

11-53 04-493

Trinitron® Color TV

Operating Instructions

*File
Small Folder*

KV-27S10
KV-27V10
KV-29RS10
KV-29V10C
KV-29V10M
KV-32S10

WARNING

To prevent fire or shock hazard, do not expose the unit to rain or moisture.

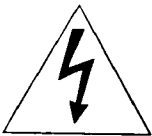
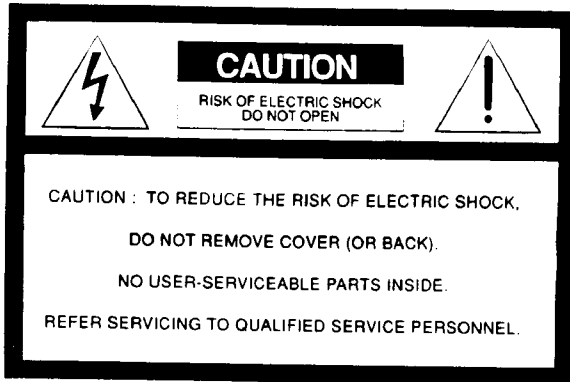

This symbol is intended to alert the user to the presence of uninsulated "dangerous voltage" within the product's enclosure that may be of sufficient magnitude to constitute a risk of electric shock to persons.



This symbol is intended to alert the user to the presence of important operating and maintenance (servicing) instructions in the literature accompanying the appliance.

CAUTION

To prevent electric shock, do not use this polarized AC plug with an extension cord, receptacle or other outlet unless the blades can be fully inserted to prevent blade exposure.

Precautions

Safety

- Operate the TV only on 120 V AC (KV-27S10/27V10/29RS10/29V10M/32S10 only).
- Operate the TV on 110-127 V or 220-240 VAC (KV-29V10C only).
- One blade of the plug is wider than the other for safety purposes and will fit into the power outlet only one way. If you are unable to insert the plug fully into the outlet, contact your dealer.

2

- Should any liquid or solid object fall into the cabinet, unplug the TV and have it checked by qualified personnel before operating it any further.
- Unplug the TV from the wall outlet if you are not going to use it for several days or more. To disconnect the cord, pull it out by the plug. Never pull the cord itself.

For details concerning safety precautions, see the supplied leaflet "IMPORTANT SAFEGUARDS."

Installing

- To prevent internal heat build-up, do not block the ventilation openings.
- Do not install the TV in a hot or humid place, or in a place subject to excessive dust or mechanical vibration.

CAUTION

When using TV games, computers, and similar products with your TV, keep the brightness and contrast functions at low settings. If a fixed (non-moving) pattern is left on the screen for long periods of time at a high brightness or contrast setting, the image can be permanently imprinted onto the screen. These types of imprints are not covered by your warranty because they are the result of misuse.

Note on Caption Vision (KV-27S10/27V10/32S10 only)

This television receiver provides display of television closed captioning in accordance § with 15.119 of the FCC rules.

Note to CATV system installer

This reminder is provided to call the CATV system installer's attention to Article 820-40 of the NEC that provides guidelines for proper grounding and, in particular, specifies that the cable ground shall be connected to the grounding system of the building, as close to the point of cable entry as practical.

Use of this television receiver for other than private viewing of programs broadcast on UHF or VHF or transmitted by cable companies for the use of the general public may require authorization from the broadcaster/cable company and/or program owner.

Owner's Record

The model and serial numbers are located at the rear of the TV. Record these numbers in the spaces provided below. Refer to them whenever you call upon your Sony dealer regarding this product.

Model No. _____

Serial No. _____

Table of contents

- 4 Welcome!
- 4 Checking your model number

Getting Started

- 5 Step 1: Hookup
- 9 Step 2: Setting up the remote commander
- 9 Step 3: Setting up the TV automatically
(AUTO SET UP)
- 12 Changing the menu language

Operations

- 13 Watching the TV
- 14 Adjusting the picture (VIDEO)
- 15 Adjusting screen brightness automatically
(LUMISPONDER)
- 15 Adjusting the sound (AUDIO)
- 16 Listening to surround sound (SURROUND)
- 17 Selecting stereo or bilingual programs (MTS)
- 17 Setting the speaker switch (SPEAKER)
- 18 Setting audio out (AUDIO OUT)
- 19 Customizing the channel number buttons (CH
CAPTION /GUIDE)
- 20 Setting video labels (VIDEO LABEL)
- 21 Displaying Caption Vision (CAPTION VISION)
- 21 Operating video equipment
- 23 Operating a cable box

Additional Information

- 24 Troubleshooting
- 26 Specifications

- 27 **Index**

The captions in parentheses indicate menu names.

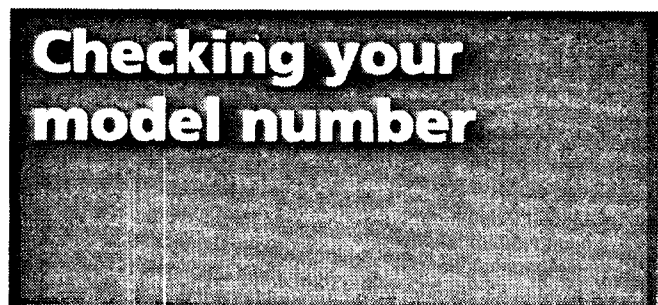

Thank you for purchasing the Sony Trinitron® Color TV. Here are some of the features you will enjoy with your TV:

- On-screen menus that let you set the picture quality, sound, and other settings
- Video input jack(s) that allows you to connect your VCR to the TV and to enjoy video picture and sound
- Surround system that simulates the sound quality of a concert hall or movie theater (*KV-27V10/29V10C/29V10M only*)
- Lumisponder that automatically adjusts the brightness of the screen (*KV-27V10/29V10C/29V10M only*)

The instructions in this manual are for six models listed below. Before you start reading, check your model number by looking at the rear of your TV.

The KV-27S10 is the model used for illustration purposes. Any differences in operation are clearly indicated in the text, for example, "*KV-27S10 only*."

Instructions in this manual are based on the remote commander. You can also use the controls on the TV if they have the same name as those on the remote commander.

Feature packages

Model number	Feature	Caption Vision	Lumisponder	Surround system	Video label	Speaker switch	Audio out	Pre-Programmed remote commander
KV-27S10	•							
KV-27V10	•	•	•	•	•	•	•	•
KV-29RS10								
KV-29V10C		•	•	•	•	•	•	•
KV-29V10M		•	•	•	•	•	•	•
KV-32S10	•							

Step 1: Hookup

Although you can use either an indoor antenna or outdoor antenna with your TV, we recommend you to connect an outdoor antenna or a cable TV system to get better picture quality.

How to connect different types of cables

The illustrations below show the examples of connecting cable to the TV directly.

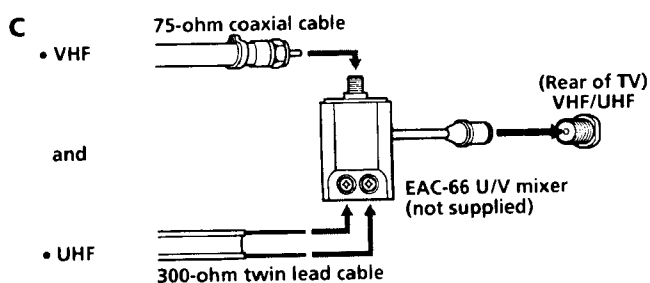
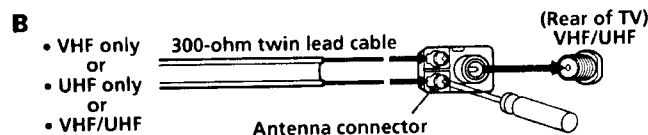
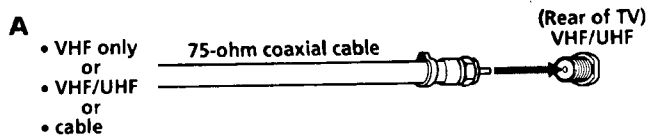

Notes

- Most VHF/UHF combination antennas have a signal splitter. Remove the splitter before attaching the appropriate connector.
- If you use the U/V mixer, snow and noise may appear in the picture when viewing cable TV channels over 37 (W +1).

Connecting an antenna/cable TV system without a VCR

If your cable company requires you to connect a cable box, make the connection as follows:

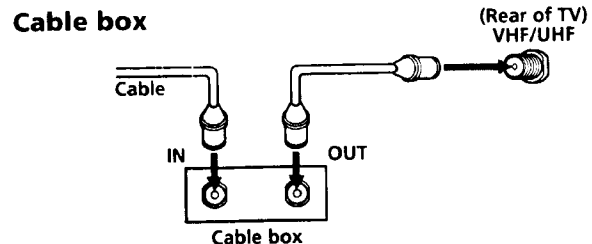
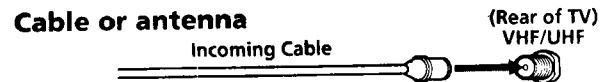

Pay cable TV systems use scrambled or encoded signals requiring the cable box* in addition to the normal cable connection.

* The cable box will be supplied by the cable company.

Note

- You cannot watch the signal through AUX connector as a window picture.

Connecting an antenna/cable TV system with a VCR

To connect your VCR to the TV, first check the model number of your TV and select the corresponding connection. For details on connection, see the instruction manual of your VCR. Before making connection, disconnect the AC power cords of the equipment to be connected.

After making these connections, you will be able to do the following:

- View the playback of video tapes
- Record one TV program while viewing another program

Without a cable box

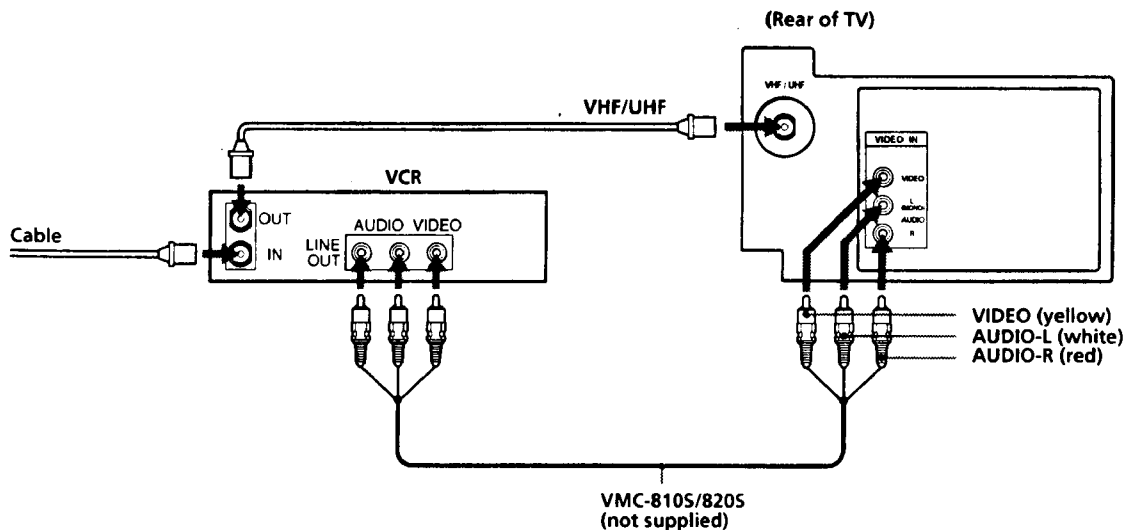

Note

- To connect a monaural VCR, connect the audio output of the VCR to AUDIO-L (mono) of VIDEO 1 IN on the TV.

To an S video equipped VCR without a cable box

■ KV-27V10/29V10C/29V10M/32S10 only

If your VCR has an S video output jack, hook up as follows and then set S VIDEO to ON on your TV (page 12). (It is set to ON at the factory.)

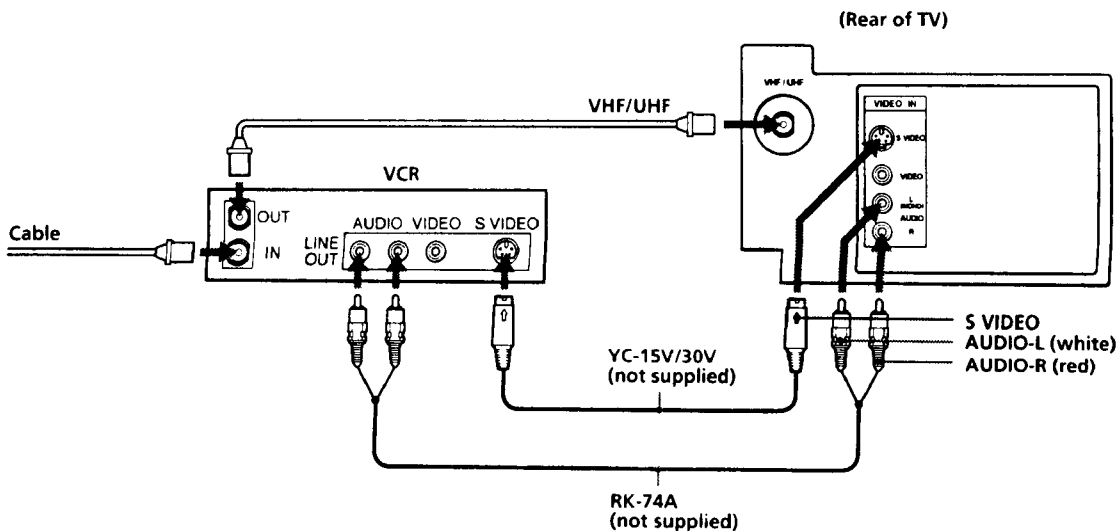

With a cable box

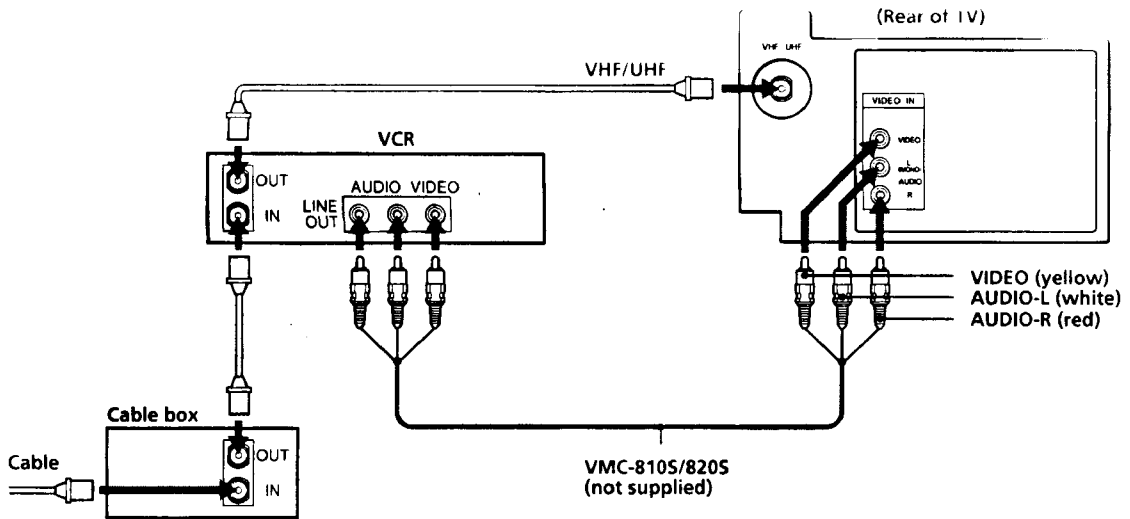

Note

- To connect a monaural VCR, connect the audio output of the VCR to AUDIO-L (mono) of VIDEO 1 IN on the TV.

To an S video equipped VCR with a cable box

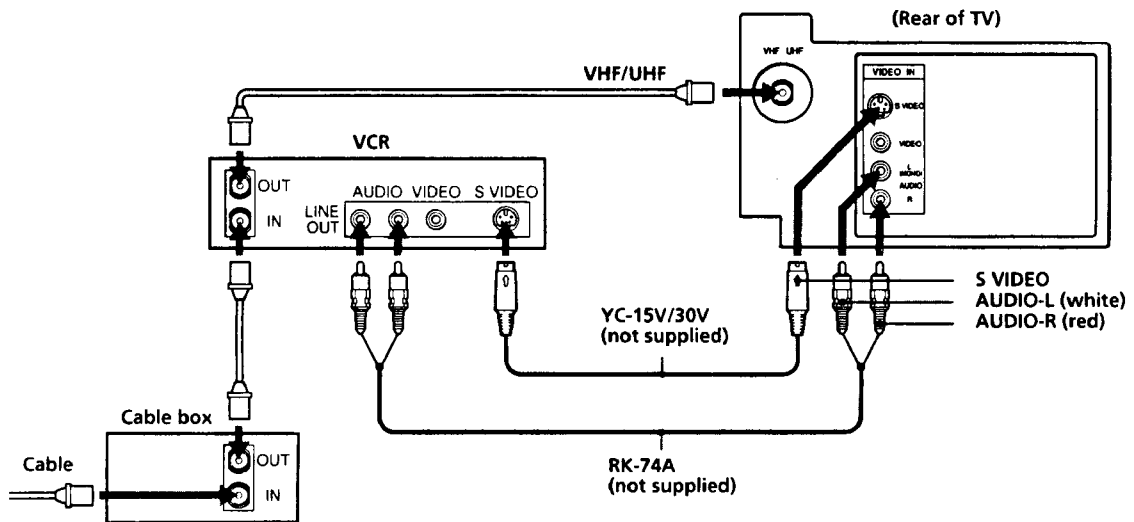

Note

- Video signals are composed of Y (luminance) and C (chroma) signals. The S connection sends the two signals separately preventing degradation, and gives better picture quality compared to conventional connection.

Connecting a camcorder

■ *KV-27V10/29V10C/29V10M only*

This connection is convenient for viewing a camcorder.

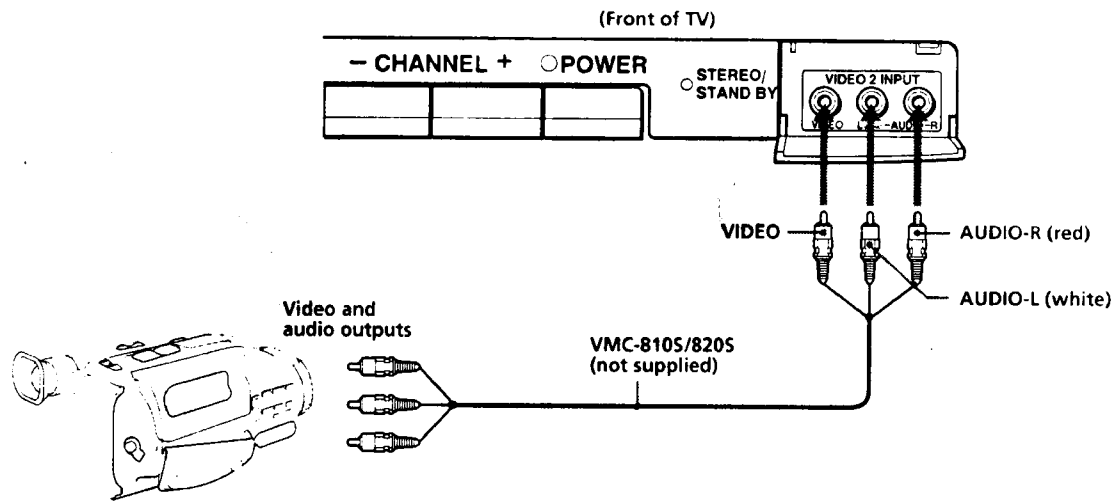

Note

- To connect a monaural camcorder, connect the audio output of the VCR to AUDIO-L (mono) of VIDEO 2 INPUT on the TV.

Connecting an audio system

■ *KV-27V10/29V10C/29V10M only*

When connecting audio equipment, see page 17 and 18 for more information.

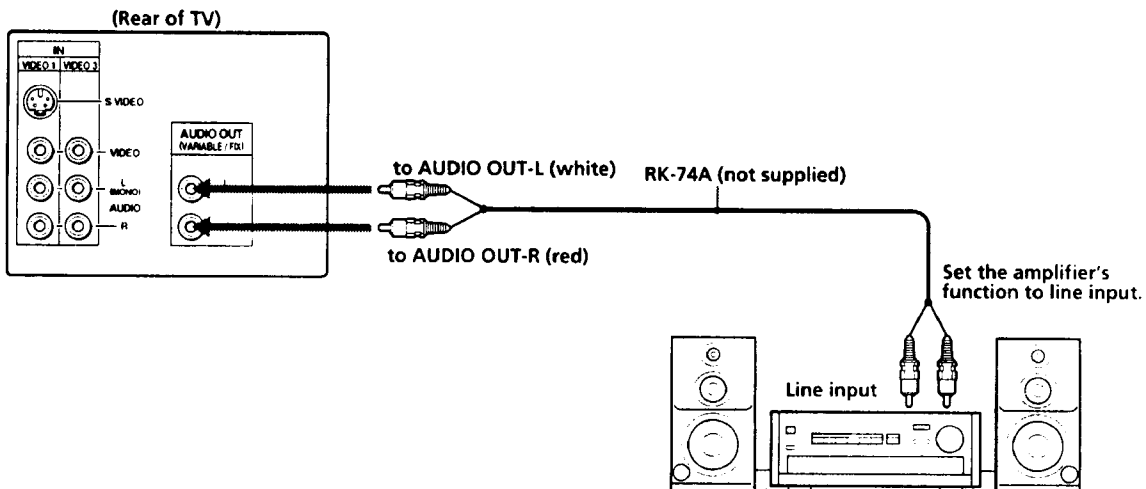

Step 2: Setting up the remote commander

■ KV-27S10/29RS10/32S10 RM-Y116 remote commander

Insert two size AA (R6) batteries in correct polarity.

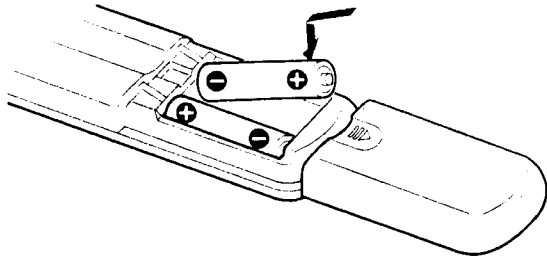

■ KV-27V10/29V10C/29V10M RM-Y117 remote commander

Insert a size AA (R6) battery in correct polarity.

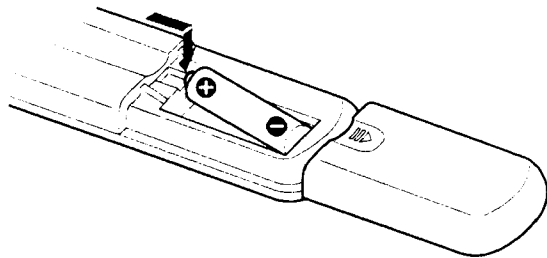

Notes

- With normal use, the battery should last for approximately six months.
- If you do not use the remote commander for an extended period of time, remove the battery to avoid possible damage from battery leakage.
- Do not handle the remote commander roughly. Do not drop it step on it or let it get wet.
- Do not place the remote commander in locations where it is in direct sunlight, near a heater, or where the humidity is high.

Step 3: Setting up the TV automatically (AUTO SET UP)

You can set up your TV easily by using AUTO SET UP feature. It presets all the receivable channels. To set up the TV manually, see "Setting cable TV on or off" and "Presetting channels" (page 11).

If the TV is set to a video input, you cannot execute AUTO SET UP. Press TV/VIDEO so that a channel number appears.

(Front of KV-27S10/29RS10/32S10)

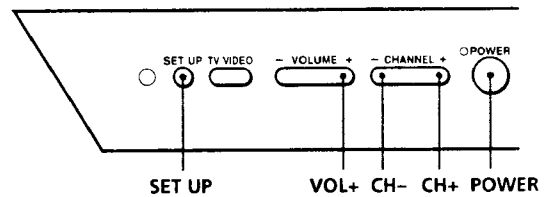

(Front of KV-27V10/29V10C/29V10M)

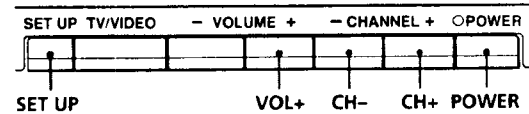

1 Press POWER to turn the TV on.



2 Press SET UP on the front of the TV.

The menu appears.



DEMO	:	VOL+
AUTO SET UP	:	CH+
FACTORY PRESET	:	CH-

3 Press CH +.

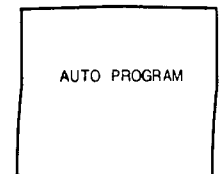
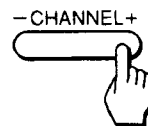

"AUTO PROGRAM" appears on the screen and the TV starts scanning and presetting channels automatically. When all the receivable channels are stored, "AUTO PROGRAM" disappears and the lowest numbered channel is displayed. If the TV receives cable TV channels, CATV is set to ON automatically.

Note

- If more than 90 seconds elapse after you press a button, the menu will disappear automatically.

DEMO: To browse the main functions.

Press VOL+ in step3. The functions and menus are displayed one by one.

FACTORY PRESET: To restore the factory settings when you are confused about the TV settings.

Press CH- in step3. The settings of picture and sound are restored to the factory setting.

Erasing or adding channels

After AUTO SET UP you can erase unnecessary channels or add the channels you want. Preset channels during the day rather than late at night, when some channels may not be broadcasting.

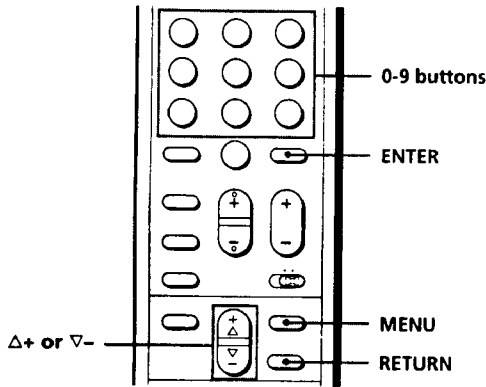

1 Press MENU.

The main menu appears.

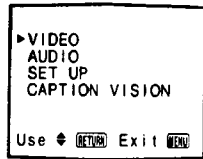

2 Press Δ+ or ∇- to select SET UP and press RETURN.

The SET UP menu appears.

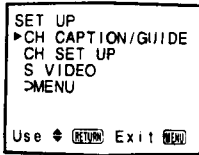
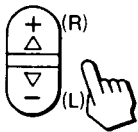

3 Press Δ+ or ∇- to select CH SET UP and press RETURN.

The CH SET UP menu appears.

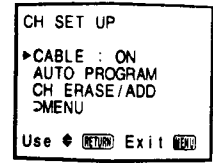
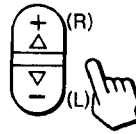

4 Press Δ+ or ∇- to select CH ERASE/ADD and press RETURN.

The CH ERASE/ADD menu appears.

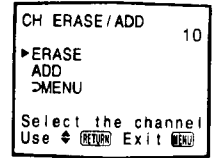
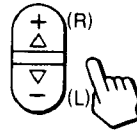

5 Erase and/or add the channel you want:

To erase an unwanted channel

- (1) Make sure the cursor (▶) is beside ERASE.
- (2) Press CH +/- to select the channel you want to erase and,

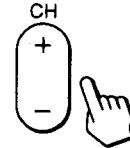

Selected channel number

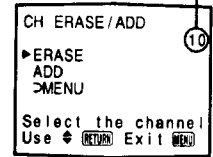

- (3) press RETURN.

The indication "-" appears beside the channel number, showing that the channel is erased from the preset memory.



To add a channel that you want

- (1) Press Δ+ or ∇- to select ADD.
- (2) Press the 0 - 9 buttons to select the channel you want to add and press ENTER and,

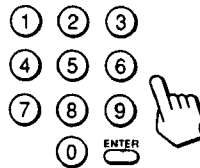

Selected channel number

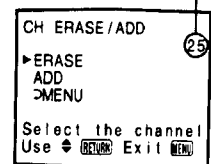

- (3) press RETURN.

The indication "+" appears beside the channel number, showing that the channel is added to the preset memory.



6 To erase and/or add other channels, repeat step 5.

7 When you finish, press MENU.



Note

- If you erase or add a VHF or UHF channel, the cable TV channel with the same number is also erased or added, and vice versa.

Setting cable TV on or off

If you have connected the TV to a cable TV system, set CABLE to ON, the factory setting. If not, set CABLE to OFF.

You do not have to do this procedure if you execute AUTO SET UP (page 9). Do this procedure only when you want to set it manually.

- 1 Press MENU.**
- 2 Press $\Delta+$ or $\nabla-$ to move the cursor (\blacktriangleright) to SET UP and press RETURN.**
- 3 Press $\Delta+$ or $\nabla-$ to move the cursor (\blacktriangleright) to CH SET UP and press RETURN.**

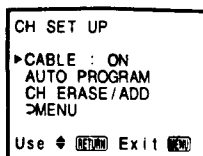

4 Set CABLE to ON or OFF:

- (1) Make sure the cursor (\blacktriangleright) is beside CABLE and press RETURN.
If the cursor is not beside CABLE, press $\Delta+$ or $\nabla-$ to move the cursor and press RETURN.
- (2) Press $\Delta+$ or $\nabla-$ to select ON or OFF and,
- (3) press RETURN.

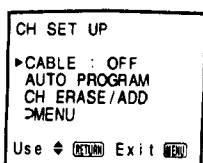

5 Press MENU to return to the original screen.

Note

- If CH SET UP menu appears in black, the TV is set to a video input and you cannot select CABLE. Press TV/VIDEO so that a channel number appears.

Presetting channels

You can preset TV channels easily by using the AUTO PROGRAM feature.

You do not have to do this procedure if you execute AUTO SET UP (page 9). Do this procedure only when you want to set it manually.

- 1 Press MENU.**
- 2 Press $\Delta+$ or $\nabla-$ to move the cursor (\blacktriangleright) to SET UP and press RETURN.**
- 3 Press $\Delta+$ or $\nabla-$ to move the cursor (\blacktriangleright) to CH SET UP and press RETURN.**
- 4 Press $\Delta+$ or $\nabla-$ to move the cursor (\blacktriangleright) to AUTO PROGRAM and press RETURN.**

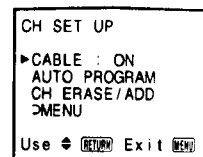

"AUTO PROGRAM" appears on the screen and the TV starts scanning and presetting channels automatically. When all the receivable channels are stored, "AUTO PROGRAM" disappears and the lowest numbered channel is displayed.

5 Press MENU to return to the original screen.

Note

- If the CH SET UP menu appears in black, the TV is set to a video input and you cannot select AUTO PROGRAM. Press TV/VIDEO or TV so that a channel number appears.

Setting S video on or off

■ KV-27V10/29V10C/29V10M/32S10 only

You can change the S VIDEO menu to ON or OFF.

- 1 Press TV/VIDEO select VIDEO 1.
- 2 Press MENU.
- 3 Press $\Delta+$ or $\nabla-$ to move the cursor (\blacktriangleright) to SET UP and press RETURN.
- 4 Press $\Delta+$ or $\nabla-$ to move the cursor (\blacktriangleright) to S VIDEO and press RETURN.

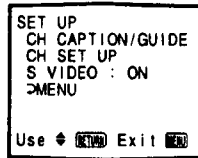

- 5 Press $\Delta+$ or $\nabla-$ to select ON or OFF and press RETURN.

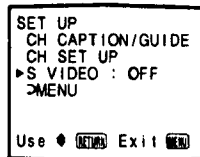

- 6 Press MENU to return to the original screen.

Notes

- If S VIDEO appears in black, set a video input to VIDEO 1.
- If you set S VIDEO to ON, the TV automatically receive S video signals whenever a VCR with S video is connected.

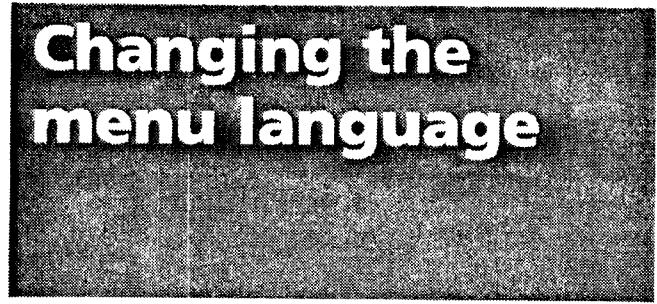

■ KV-29RS10/29V10C/29V10M only

If you prefer Spanish to English, you can change the menu language.

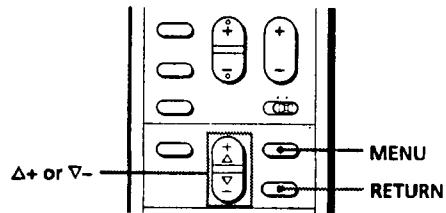

- 1 Press MENU.

The main menu appears.

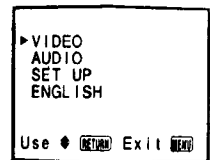

- 2 Press $\Delta+$ or $\nabla-$ to move the cursor (\blacktriangleright) to ENGLISH and press RETURN.

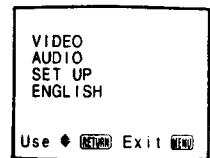
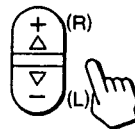

- 3 Press $\Delta+$ or $\nabla-$ to select ESPAÑOL and press RETURN.

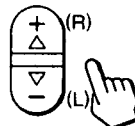

- 4 Press MENU to return to the original screen.

Note

- Certain parts of the ESPAÑOL menus remain in English.

Watching the TV

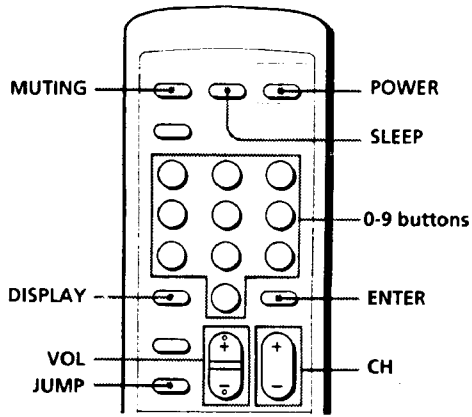

1 Press POWER to turn the TV on.



If "VIDEO" appears on the screen, press the TV/VIDEO button so that a channel number appears.

2 Select the channel you want:

To select a channel directly

Press the 0 - 9 buttons and then press ENTER.

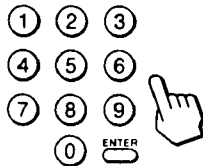

The channel can also be selected without pressing ENTER.

To scan through channels

Press CH +/- until the channel you want appears.

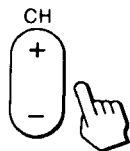

3 Press VOL +/- to adjust the volume.

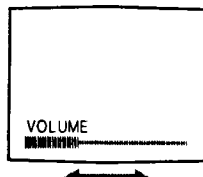
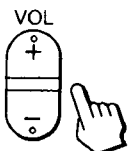

Note

- Set the CABLE BOX/TV selector to TV. (KV-27V10/29V10C/29V10M only)

Switching quickly between two channels

Press JUMP.

The channel you watched previously appears.



Pressing JUMP again switches back the channel.

Muting the sound

Press MUTING.

"MUTING" appears on the screen.



To restore the sound, press MUTING again, or press VOL +.

Displaying on-screen information

Use this feature to check the channel number, channel caption (if set), and MTS mode (if SAP is selected).

Press DISPLAY.



To cancel the display, press DISPLAY again.

Setting the Sleep Timer

The TV stays on for the length of time you specify and then shuts off automatically.

Press SLEEP repeatedly until the time (minutes) you want appears.

Each time you press SLEEP, the time changes as follows: 30 → 60 → 90 → OFF.

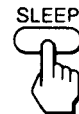

To cancel the Sleep Timer, press SLEEP repeatedly until "SLEEP OFF" appears, or turn the TV off.

Adjusting the picture (VIDEO)

When watching TV programs, you can adjust the quality of the picture to suit your taste. You can adjust the picture of video input(s) as well. These settings are stored separately from those for the TV picture.

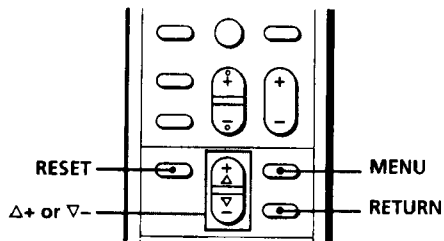

1 Press MENU.

2 Make sure the cursor (▶) is beside VIDEO and press RETURN.



3 Select the item you want to adjust.
For example:

(1) To adjust brightness, press $\Delta+$ or $\nabla-$ to select BRIGHT and,

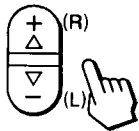

(2) press RETURN.



4 Adjust the selected item:

(1) Press $\Delta+$ or $\nabla-$ to adjust the item and,

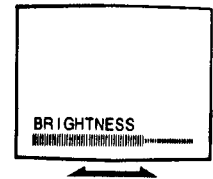
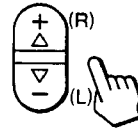

(2) press RETURN.

The new setting appears in the VIDEO menu.

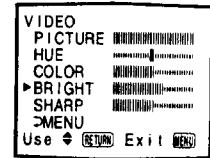

For details on each item, see "Description of adjustable items" below.

5 To adjust other items, repeat steps 3 and 4.

Description of adjustable items

Item	Press $\Delta+$ to	Press $\nabla-$ to
PICTURE	Increase picture contrast and give vivid color	Decrease picture contrast and give soft color
HUE	Make skin tones become greenish	Make skin tones become purplish
COLOR	Increase color intensity	Decrease color intensity
BRIGHT	Brighten the picture	Darken the picture
SHARP	Sharpen the picture	Soften the picture

To restore the factory settings

Press RESET while the VIDEO menu is displayed.

All the settings except for PICTURE are restored to the factory settings.

Adjusting screen brightness automatically

(LUMISPONDER)

■ KV-27V10I/29V10C/29V10M only

The LUMISPONDER feature adjusts the brightness of the screen automatically according to the ambient brightness. The LUMISPONDER function automatically adjusts the level set by the user in the VIDEO menu to the standard.

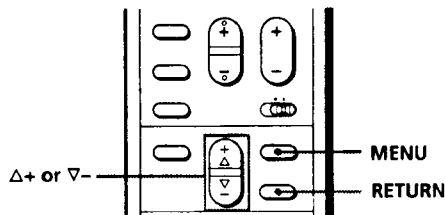

- 1 Press **MENU**.
- 2 Press **Δ+ or ∇-** to select **VIDEO** and press **RETURN**.
- 3 Press **Δ+ or ∇-** to select **LUMISPONDER** and press **RETURN**.

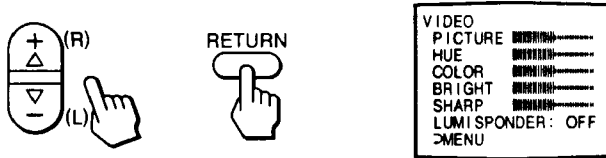

- 4 Press **Δ+ or ∇-** to select **ON or OFF** and press **RETURN**.

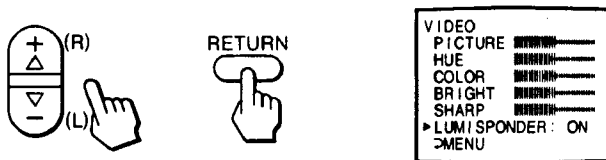

Adjusting the sound

(AUDIO)

You can adjust the quality of the sound to suit your taste.

You can adjust the sound of video input(s) as well. These settings are stored separately from those for the TV sound.

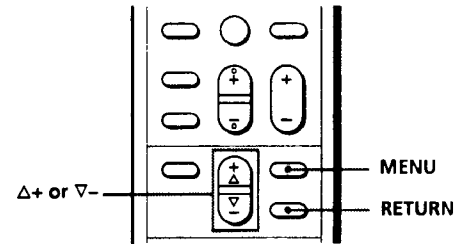

- 1 Press **MENU**.
- 2 Press **Δ+ or ∇-** to select **AUDIO** and press **RETURN**.

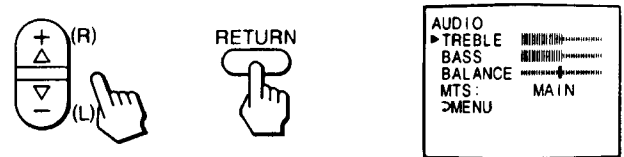

- 3 Select the item you want to adjust.
For example:

(1) To adjust bass, press **Δ+ or ∇-** to select **BASS** and,

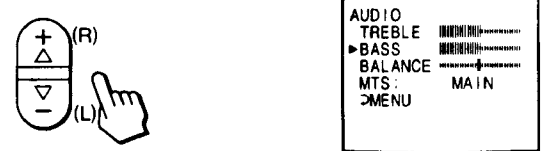

(2) press **RETURN**.

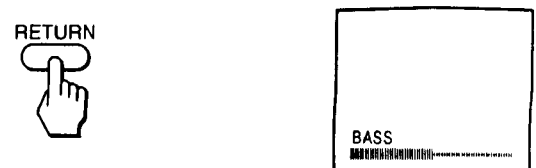

4 Adjust the selected item:

(1) Press $\Delta+$ or $\nabla-$ to adjust the item and,

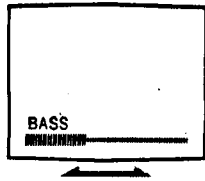
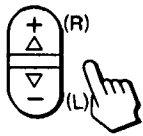

(2) press RETURN.

The new setting appears in the AUDIO menu.

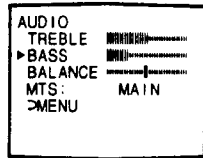

For details on each item, see "Description of adjustable items" below.

5 To adjust other items, repeat steps 3 and 4 above.

Description of adjustable items

Item	Press $\Delta+$ to	Press $\nabla-$ to
TREBLE	Increase the treble response	Decrease the treble response
BASS	Increase the bass response	Decrease the bass response
BALANCE	Emphasize the right speaker's volume	Emphasize the left speaker's volume

To restore the factory settings

Press RESET while the AUDIO menu is displayed.

Note

- When SPEAKER (page 17) is OFF and AUDIO OUT (page 18) is FIXED condition, sound menu appears mid-level setting and it cannot be adjusted.

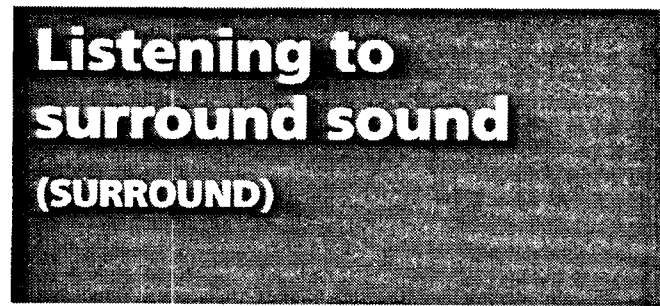

■ KV-27V10/29V10C/29V10M only

SURROUND feature simulate sound reproduction with the atmosphere of a movie theater or a concert hall. Surround sound is only effective for stereo programs.

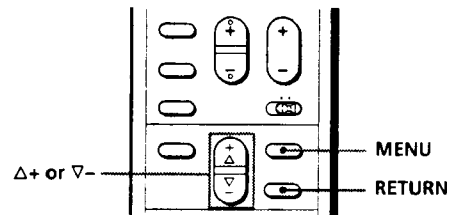

1 Press MENU.

2 Press $\Delta+$ or $\nabla-$ to select AUDIO and press RETURN.

3 Press $\Delta+$ or $\nabla-$ to select SURROUND and press RETURN.

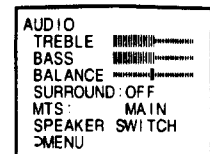
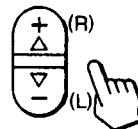

4 Press $\Delta+$ or $\nabla-$ to select ON and press RETURN.

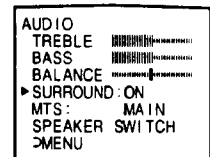
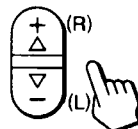

Selecting stereo or bilingual programs (MTS)

The Multichannel TV Sound (MTS) feature allows you to enjoy stereo sound or Second Audio Programs (SAP) at your choice. The initial setting is stereo sound (MAIN).

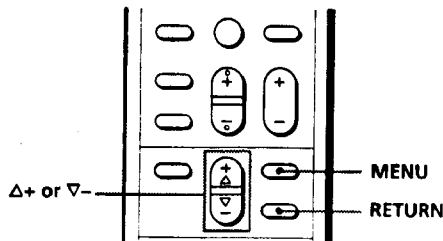

- 1 Press MENU.
- 2 Press $\Delta+$ or $\nabla-$ to select AUDIO and press RETURN.
- 3 Press $\Delta+$ or $\nabla-$ to select MTS and press RETURN.

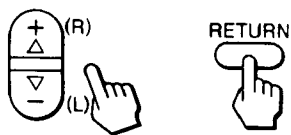

- 4 Press $\Delta+$ or $\nabla-$ to select MAIN, SAP, or MONO and press RETURN.

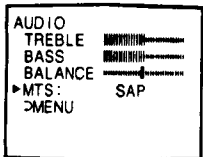
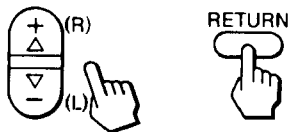

Choose	To
MAIN	Listen to stereo sound. The STEREO indicator on the TV lights up while a stereo broadcast is received.
SAP	Listen to bilingual programs. The sound of non-SAP programs will be muted when SAP is selected.
MONO	Reduce noise during stereo broadcasts.

Note

- Stereo and SAP sounds are subject to program sources.

Setting the speaker switch (SPEAKER)

■ KV-27V10I/29V10CI/29V10M only

You may switch off the TV speakers when, for example, you want to listen to the sound through a stereo system.

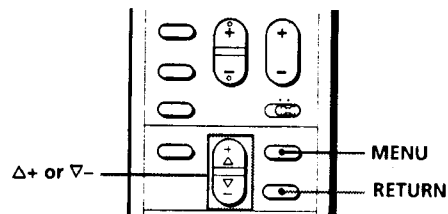

- 1 Press MENU.
- 2 Press $\Delta+$ or $\nabla-$ to select AUDIO and press RETURN.
- 3 Press $\Delta+$ or $\nabla-$ to select SPEAKER SWITCH and press RETURN.

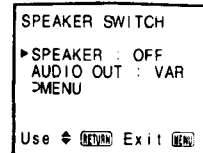
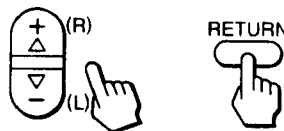

- 4 Make sure the cursor (\blacktriangleright) is beside SPEAKER and press RETURN.

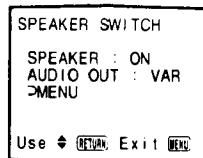

- 5 Press $\Delta+$ or $\nabla-$ to select ON or OFF and press RETURN.

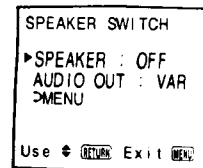
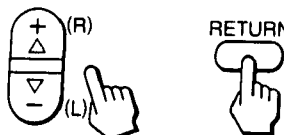

Setting audio out (AUDIO OUT)

■ KV-27V10/29V10C/29V10M only

Audio out is variable or fixed when SPEAKER is set to ON.

You can select audio out to variable or fixed when SPEAKER is set to OFF.

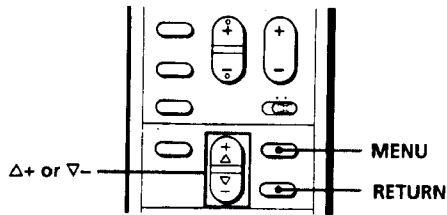

- 1 Press MENU.
- 2 Press $\Delta+$ or $\nabla-$ to select AUDIO and press RETURN.
- 3 Press $\Delta+$ or $\nabla-$ to select SPEAKER SWITCH and press RETURN.



- 4 Press $\Delta+$ or $\nabla-$ to select AUDIO OUT and press RETURN.

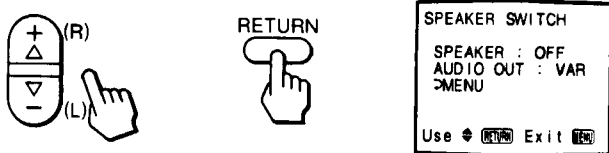

- 5 Press $\Delta+$ or $\nabla-$ to select VAR or FIXED and press RETURN.

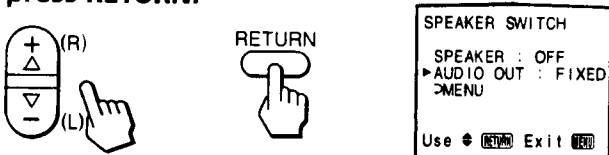

VAR: Sound output varied according to the TV settings. You can adjust the volume, bass, treble and balance.

FIXED: Sound output is always fixed to a certain level.

The volume, bass, treble and balance are also fixed to the factory settings.

Customizing the channel number buttons (CH CAPTION/ GUIDE)

You can choose up to 12 channels, caption each channel, and assign a specific channel number button to each channel. This feature allows you to select your favorite channels easily by name. For example, you can name channel 20 "ESPN," and assign the channel number 4 button to it.

Setting captions to favorite channels

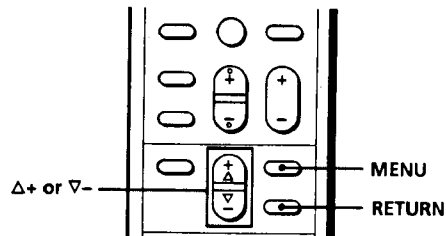

- 1 Press TV/VIDEO to select TV mode.
- 2 Press MENU.
- 3 Press $\Delta+$ or $\nabla-$ to select SET UP and press RETURN.
- 4 Press $\Delta+$ or $\nabla-$ to select CH CAPTION/GUIDE and press RETURN.



- 5 Press RETURN again.



6 Press $\Delta+$ or $\nabla-$ to select a channel guide number button and press RETURN.

Numbers 0-9 and DISPLAY and ENTER are available for use as a customized channel number. Each time you press $\Delta+$ or $\nabla-$, the channel numbers change to red in turns. The channel number button you select will be the one you press to call up your favorite channel.

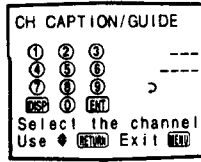
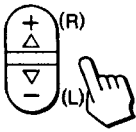

7 Press $\Delta+$ or $\nabla-$ to select the channel that you want to caption and press RETURN.

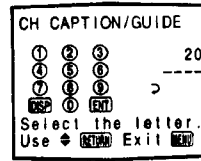
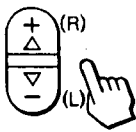

8 Enter the letters (up to four) to caption the channel:

(1) Press $\Delta+$ or $\nabla-$ to select the first letter. Each time you press $\Delta+$ or $\nabla-$, the letter changes as shown below and,

0 \leftrightarrow 1 \leftrightarrow ... \leftrightarrow 9 \leftrightarrow A \leftrightarrow B \leftrightarrow ... \leftrightarrow Z \leftrightarrow & \leftrightarrow / \leftrightarrow _ (blank space)

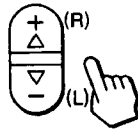

(2) press RETURN.

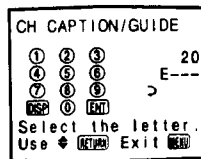

(3) Repeat steps (1) and (2) to select the remaining letters and press RETURN.

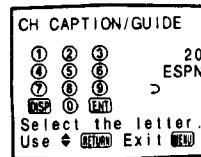

9 Repeat step 5 to 7 to caption other channels.

To erase a caption

Press RESET after step 5.

Notes

- The position number you already selected appears in yellow.
- If the CH CAPTION/GUIDE menu appears in black, the TV is set to a video input and you cannot select CH CAPTION/GUIDE. Press TV/VIDEO to select TV mode.
- If more than 90 seconds elapse after you press a button, the menu disappears automatically.

Selecting a captioned channel

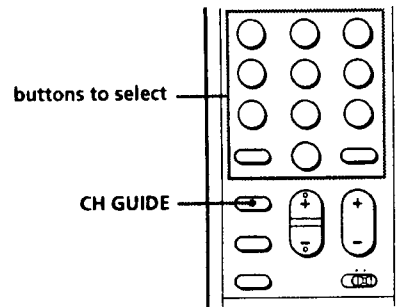

1 Press CH GUIDE.

The CHANNEL GUIDE menu appears showing channel captions and the corresponding channel number buttons.

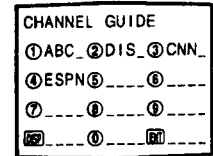

2 Press a channel number button, the DISPLAY or ENTER button to select the channel you want.

To cancel the CHANNEL GUIDE menu
Press CH GUIDE again.

Setting video labels

(VIDEO LABEL)

■ KV-27V10I/29V10CI/29V10M only

This feature allows you to label each input mode so that you can easily identify the connected equipment. For example, you can label VIDEO 1 IN as VHS.

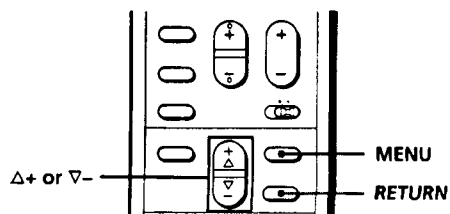

1 Press MENU.

2 Press Δ+ or ∇- to select SET UP and press RETURN.

3 Press Δ+ or ∇- to select VIDEO LABEL and press RETURN.

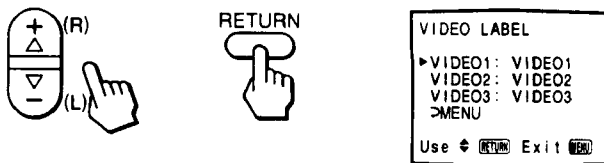

4 Press Δ+ or ∇- to select the input mode you want to label and press RETURN.

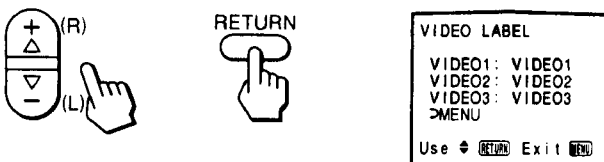

5 Press Δ+ or ∇- to select the label and press RETURN.

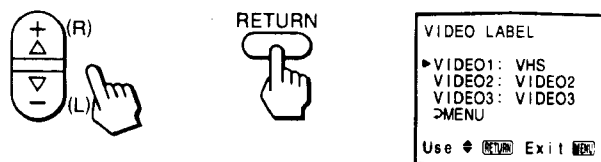

Each time you press Δ+ or ∇-, the label changes as shown below.

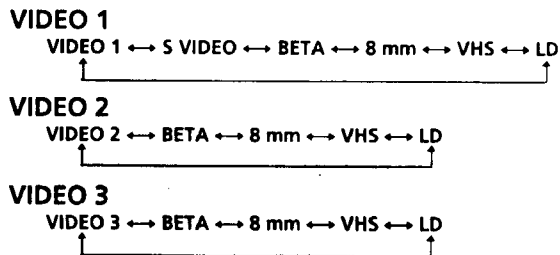

6 Repeat steps 4 and 5 to label other input modes.

Note

- If more than 90 seconds elapse after you press a button, the menu disappears automatically.

Displaying Caption Vision (CAPTION VISION)

■ KV-27S10/27V10/32S10 only

Some source programs are provided with Caption Vision (Closed Caption). To display Caption Vision, select either CC1, CC2, TEXT1, or TEXT2 from the menu.

CC1 or CC2 shows you a caption, that is a printed version of the dialog or sound effects of a program. (The mode should be set to CC1 for most programs.) TEXT1 or TEXT2 shows you text, that is information presented using half to full of the screen. It is not usually related to the program.

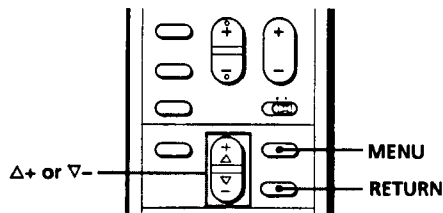

- 1 Press **MENU**.
- 2 Press **Δ+ or ∇-** to select **CAPTION VISION** and press **RETURN**.

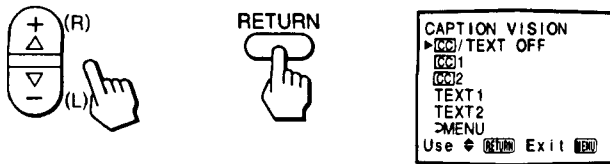

- 3 Press **Δ+ or ∇-** to select the caption type and press **RETURN**.

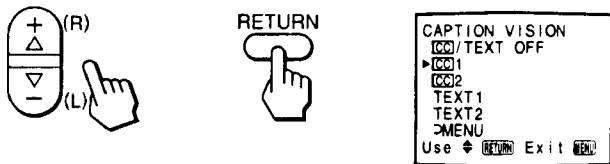

Note

- Captions may appear with a white box or another error instead of a certain word. Poor reception of TV programs can also cause errors in Caption Vision.

Operating video equipment

■ KV-27V10/29V10C/29V10M only

You can operate Sony or non-Sony video equipment that has an infrared remote sensor with the supplied remote commander. For this operation, set the manufacturer's code number.

Setting the manufacturer's code

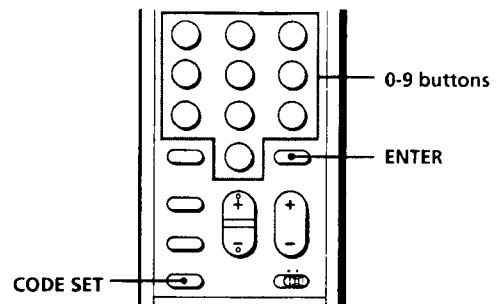

While pressing **CODE SET**, press **0 - 9** to enter the manufacturer's code number (see the chart on the next page). For example, to operate a Sony 8 mm VCR, press **0, 2** and **ENTER**.



Video equipment manufacturer code numbers

Manufacturer	Code
SONY	01, 02, 03, 04
CANON	05
EMERSON	22, 30, 33
FISHER	10, 11, 12, 15
FUNAI	29
GENERAL ELECTRIC	05, 08
GOLDSTAR	25
HITACHI	07, 08, 36
JVC	16, 35
MAGNAVOX	05, 06, 09
MITSUBISHI	18, 19, 26, 27
MULTITECH	29
NEC	16, 23, 31
PANASONIC	05, 06
PHILCO	05, 06
PHILIPS	05, 06, 09
QUASAR	05, 06
RCA	07, 08
SAMSUNG	24, 32
SANYO	11, 15
SCOTT	21
SHARP	13, 14
SHINTOM	34
SYLVANIA	05, 06, 09
SYMPHONIC	29
TEKNIKA	28, 29
TOSHIBA	20, 21
TOTE VISION	25
ZENITH	17

Notes

- If more than one code number is listed, try entering them one by one, until you come to the correct code for your equipment.
- In some rare cases, you may not be able to operate your non-Sony video equipment with this remote commander. This is because your equipment may use a code that is not provided with this remote commander. In this case, please use the equipment's own remote control unit.
- The code numbers for Sony equipment are assigned at the factory as follows:

Beta, ED Beta VCRs	01
8 mm VCR	02
VHS VCR	03 (preset code for this remote commander)
MDP	04

Caution

When you remove a battery from the remote commander, the code may revert to 03. Reset the code each time you replace the battery if necessary.

Operating video equipment

■ KV-27V10/29V10C/29V10M only

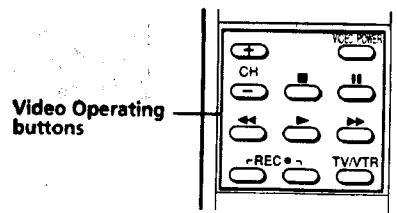

Use the video operating buttons on the remote commander to operate the video equipment.

Operating a VCR

Buttons on the remote commander

To turn on or off	Press VIDEO POWER
To change channels	Press CH +/-
To record	Press ● and REC simultaneously
To play	Press ▶
To stop	Press ■
To fast forward	Press ►►
To rewind the tape	Press ◀◀
To pause	Press II
To search the picture forward and backward	Press ►► or ◀◀ during playback

Operating the Laser-disc player

Buttons on the remote commander

To play	Press ▶
To stop	Press ■
To pause	Press II To resume normal playback, press again.
To search the picture forward and backward	Keep pressing ►► or ◀◀ during playback To resume normal playback, release the button.
To search the chapter forward and backward	Press CH +/-

Note

- If the video equipment does not have a certain function, the corresponding button on this remote commander will not operate.

Operating a cable box

■ KV-27V10/29V10C/29V10M only

Follow these instructions to set the manufacturer's code which will enable you to operate a connected cable box with the pre-programmed remote commander. For example, you can set the remote commander to operate a connected Zenith cable box.

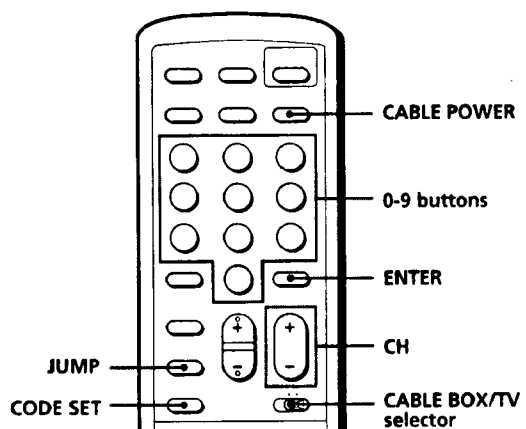

1 Set the **CABLE BOX/TV selector** to **CABLE BOX**.

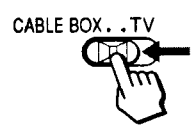

2 While pressing **CODE SET**, press **6** and **8** (Zenith's code number -see chart on the right column) and **ENTER**.



3 Use **CABLE POWER** and the **TV control buttons (0 - 9, ENTER, JUMP and CH +/-)** to operate the cable box.

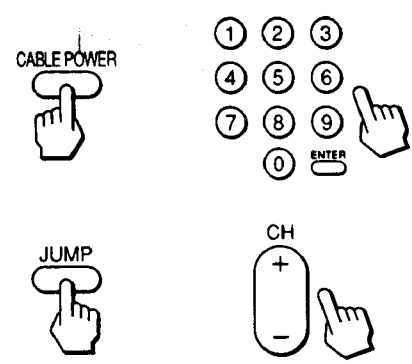

To operate the TV
Set the **CABLE BOX/TV selector** to **TV**. Then use the **TV control buttons** to control the TV.

For more details on operating the cable box
Refer to the operating instructions that come with the cable box.

Manufactures and code numbers (cable box)

Manufacturer	Code number
JERROLD	60, 61, 62, 63, 64, 65
PIONEER	69, 70
SCIENTIFIC ATLANTA	66, 67
TOCOM	71, 72
ZENITH	68

- Notes**
- If more than one code number is listed, try entering them one by one until you come to the correct code for your equipment.
 - If you enter a new code number, the code number you previously entered at that setting is erased.
 - In some cases, your cable box may use a code that is not provided with this remote commander and you may not be able to operate your cable box with the supplied remote commander. In this case, use the equipment's own remote control unit.
 - When you remove a battery from the remote commander, the code may be erased. Reset the code each time you replace the battery, if necessary.

Troubleshooting

After trying the methods below, if the problem persists, contact your nearest Sony dealer.

No picture (screen not lit), no sound

- ➔ Use FACTORY PRESET. (page 10)
- ➔ Make sure the power cord is connected securely.
- ➔ Operate with the buttons on the TV.
- ➔ Insert the battery in the remote commander with the correct polarity.
- ➔ Replace the battery with a new one if it is weak.
- ➔ Check to see if the TV/VIDEO setting is correct: when watching TV, set to TV, and when watching video tapes, set to VIDEO.
- ➔ Try another channel. It could be station trouble.

Poor or no picture (screen lit), good sound

- ➔ Use FACTORY PRESET. (page 10)
- ➔ Adjust PICTURE in the VIDEO menu. (page 14)
- ➔ Adjust BRIGHT in the VIDEO menu. (page 14)
- ➔ Check the antenna/cable connections.
- ➔ Make sure S VIDEO is set to ON in the SET UP menu, when watching video tapes with an S video type VCR.

Good picture, no sound

- ➔ Use FACTORY PRESET. (page 10)
- ➔ Press MUTING so that "MUTING" disappears from the screen. (page 13)
- ➔ Check the MTS setting in the AUDIO menu. (page 17)
- ➔ Make sure SPEAKER is set to ON in the SPEAKER SWITCH menu. (page 17)

No color

- ➔ Use FACTORY PRESET. (page 10)
- ➔ Adjust COLOR in the VIDEO menu. (page 14)
- ➔ Black and white programs cannot be seen in color.

Only snow and noise appear on the screen

- ➔ Check the CABLE setting in the SET UP menu. (page 11)
- ➔ Check the antenna/cable connections.
- ➔ Make sure the channel is broadcasting programs.

Dotted lines or stripes

- ➔ Adjust the antenna.
- ➔ Move the TV away from noise sources such as cars, neon signs, and hair-dryers.

Double images or ghosts

- ➔ Use a highly directional outdoor antenna or a cable (when the problem is caused by reflections from nearby mountains or tall buildings).

Cannot operate menu

- ➔ If the item you want to choose appears in black, you cannot select it. Press TV/VIDEO correctly.

Cannot receive upper channels (UHF) when using an antenna

- ➔ Check if CABLE is OFF in the SET UP menu. (page 11)
- ➔ Use AUTO SET UP or AUTO PROGRAM to add receivable channels that are not presently in TV memory. (page 9)

Cannot receive any channels when using cable TV

- ➔ Check if CABLE is ON in the SET UP menu. (page 11)
- ➔ Use AUTO SET UP or AUTO PROGRAM to add receivable channels that are not presently in TV memory. (page 9)

Remote commander does not operate

- ➔ Battery could be weak. Replace a battery.
- ➔ Make sure the TV's power cord is connected securely to wall outlet.
- ➔ Set the CABLE BOX/TV selector to TV when operating your TV. (KV-27V10/29V10C/29V10M only)
- ➔ Are fluorescent lights too close to TV? Move at least 3-4 feet away from TV.

Commander's power, channel up/down, channel buttons do not function

- ➔ Set the CABLE BOX/TV selector to the correct position.

Cannot gain enough volume when using a cable box

- ➔ Increase the volume at the cable box. Then set the CABLE BOX/TV selector to TV and adjust the TV's volume. (KV-27V10/29V10C/29V10M only)

The TV needs to be cleaned

- ➔ Clean the TV with a soft dry cloth. Never use strong solvents such as thinner or benzine, which might damage the finish of the cabinet.

Specifications

	Model number						Notes
	KV-27S10	KV-27V10	KV-29RS10	KV-29V10C	KV-29V10M	KV-32S10	
Television system	American TV standard						
Channel coverage	VHF: 2-13 / UHF: 14-69 / CATV: 1-125						
Antenna	75-ohm external antenna terminal for VHF/UHF						
Picture tube	HiBlack Trinitron [®] tube					Trinitron [®] tube	
Screen size (in.)	27	27	27	27	27	32	Measured diagonally
Number of inputs/outputs							
Video	1	3	1	3	3	1	1 V _{p-p} , 75 ohms unbalanced, sync negative
S video	0	1	0	1	1	1	Y: 1 V _{p-p} , 75 ohms unbalanced, sync negative C: 0.286 V _{p-p} (Burst signal), 75 ohms
Audio	1	3	1	3	3	1	500 mV _{rms} (100% modulation), Impedance: 47 kilohms
Audio out	0	1	0	1	1	0	More than 408 mV _{rms} at the maximum volume setting (variable) More than 408 mV _{rms} (fix) Impedance: 5 kilohms
Speaker output (W)	5 W × 2	5 W × 2	5 W × 2	5 W × 2	5 W × 2	5 W × 2	
Power requirements	120 V, 60 Hz	120 V, 60 Hz	120 V, 60 Hz	110-127 V, 220-240 V, 50 Hz/60 Hz	120 V, 60 Hz	120 V, 60 Hz	
Power consumption (W)							
When in use	165	165	165	160	165	190	
In standby	6	6	6	9	6	6	
Dimensions (W/H/D) (mm)	661 × 603 × 524 (26 ¹ / ₄ × 23 ³ / ₄ × 20 ³ / ₄ in.)	664 × 572 × 513 (26 ¹ / ₈ × 22 ⁵ / ₈ × 20 ¹ / ₄ in.)	661 × 603 × 524 (26 ¹ / ₄ × 23 ³ / ₄ × 20 ³ / ₄ in.)	664 × 572 × 513 (26 ¹ / ₈ × 22 ⁵ / ₈ × 20 ¹ / ₄ in.)	664 × 572 × 513 (26 ¹ / ₈ × 22 ⁵ / ₈ × 20 ¹ / ₄ in.)	781 × 714 × 613 (30 ⁷ / ₈ × 28 ¹ / ₈ × 24 ¹ / ₄ in.)	
Mass (kg)	42.2 (93 lbs)	42.9 (94 lbs)	42.2 (93 lbs)	42.9 (94 lbs)	42.9 (94 lbs)	69 (152 lbs)	

Supplied accessories

KV-27S10/29RS10/32S10

Remote commander RM-Y116 (1)
with 2 size AA (R6) batteries

KV-27V10/29V10C/29V10M

Remote commander RM-Y117 (1)

with 1 size AA (R6) battery

Power cord plug adaptor (1) (KV-29V10C only)

Optional accessories

U/V mixer EAC-66

Connecting cables VMC-810S/820S, VMC-720M, YC-15V/30V, RK-74A

Design and specifications subject to change without notice.

Index

Adjusting the picture **14**
Adjusting the sound **15**
Antenna **5**
Audio out **18**
AUTO SET UP **9**
AUTO PROGRAM **11**
Battery **9**
Cable box **5**
Cable TV **11**
Caption Vision **21**
Changing the menu language **12**
Channel caption **19**
DEMO **10**
Erase/Add **10**
FACTORY PRESET **10**
Hookup
 Without a VCR **5**
 with a VCR **6**
Jump **13**
Lumisponder **15**
MTS (Multichannel TV Sound) **17**
Muting **13**
Presetting channels **11**
Remote commander **9**
S video **6**
SAP (Second Audio Program) **17**
Sleep timer **13**
Surround **15**
Speaker switch **17**
Video label **20**
Watching
 TV **13**
 video tapes **6**

Names of controls

Δ +/ ∇ - buttons **10**
CABLE BOX/TV selector **23**
CH (channel) GUIDE button **19**
CH (channel) +/- button **9, 13**
DISPLAY button **13**
ENTER button **10, 13**
JUMP button **13**
MENU button **10**
MUTING button **13**
Number buttons (0 - 9) **10, 13**
POWER button **9**
RESET button **14**
RETURN button **10**
S VIDEO input jack **6**
SLEEP button **13**
STEREO/STAND BY indicator **17**
TV/VIDEO button **8**
VHF/UHF antenna terminal **5**
VIDEO 1 IN jacks **6**
VIDEO 2 INPUT jacks **8**
VIDEO 3 IN jacks **8**
VOL (volume) +/- buttons **9, 13**

