

# ***Trinitron<sup>®</sup> Color TV***

---

## Operating Instructions

*KV-27S25*  
*KV-27S35*  
*KV-27V25*  
*KV-27V35*  
*KV-29RS25*  
*KV-29RS25C*  
*KV-29V35C*  
*KV-29V65M*  
*KV-29V75M*  
*KV-32S25*  
*KV-32S35*  
*KV-32TW25*  
*KV-32V25*  
*KV-32V35*  
*KV-34V35C*  
*KV-35V35*  
*KV-35V45*  
*KV-35V75*



# WARNING

To prevent fire or shock hazard, do not expose the television to rain or moisture.

**CAUTION**  
RISK OF ELECTRIC SHOCK  
DO NOT OPEN

**ATTENTION**  
RISQUE DE CHOC ELECTRIQUE,  
NE PAS OUVRIR

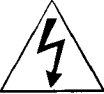
**PRECAUCION**  
RIESGO DE CHOQUE ELECTRICO  
NO ABRIR

CAUTION : TO REDUCE THE RISK OF ELECTRIC SHOCK,  
DO NOT REMOVE COVER (OR BACK).  
NO USER-SERVICEABLE PARTS INSIDE.  
REFER SERVICING TO QUALIFIED SERVICE PERSONNEL.



This symbol is intended to alert the user to the presence of uninsulated "dangerous voltage" within the product's enclosure that may be of sufficient magnitude to constitute a risk of electric shock to persons.



This symbol is intended to alert the user to the presence of important operating and maintenance (servicing) instructions in the literature accompanying the appliance.

## CAUTION

To prevent electric shock, do not use this polarized AC plug with an extension cord, receptacle or other outlet unless the blades can be fully inserted to prevent blade exposure.

## Precautions

### Safety

- Operate the TV only on 120 V AC (except KV-29RS25C/29V35C/34V35C).
- Operate the TV only on 220 V AC (KV-29RS25C/29V35C/34V35C only).
- One blade of the plug is wider than the other for safety purposes and will fit into the power outlet only one way. If you are unable to insert the plug fully into the outlet, contact your dealer (except KV-29RS25C/29V35C/34V35C).
- Should any liquid or solid object fall into the cabinet, unplug the TV and have it checked by qualified personnel before operating it any further.

- Unplug the TV from the wall outlet if you are not going to use it for several days or more. To disconnect the cord, pull it out by the plug. Never pull the cord itself.

For details concerning safety precautions, see the supplied leaflet "IMPORTANT SAFEGUARDS."

## Installing

- To prevent internal heat build-up, do not block the ventilation openings.
- Do not install the TV in a hot or humid place, or in a place subject to excessive dust or mechanical vibration.

## CAUTION

When using TV games, computers, and similar products with your TV, keep the brightness and contrast functions at low settings. If a fixed (non-moving) pattern is left on the screen for long periods of time at a high brightness or contrast setting, the image can be permanently imprinted onto the screen. These types of imprints are not covered by your warranty because they are the result of misuse.

## NOTIFICATION

This equipment has been tested and found to comply with the limits for a Class B digital device pursuant to Part 15 of the FCC Rules. These limits are designed to provide reasonable protection against harmful interference in a residential installation. This equipment generates, uses, and can radiate radio frequency energy and, if not installed and used in accordance with the instructions, may cause harmful interference with radio communications. However, there is no guarantee that interference will not occur in a particular installation. If this equipment does cause harmful interference to radio or television reception, which can be determined by turning the equipment off and on, the user is encouraged to try to correct the interference by one or more of the following measures:

- Reorient or relocate the receiving antennas.
- Increase the separation between the equipment and receiver.
- Connect the equipment into an outlet on a circuit different from that to which the receiver is connected.
- Consult the dealer or an experienced radio/TV technician for help.

You are cautioned that any changes or modifications not expressly approved in this manual could void your authority to operate this equipment.

This document is for the remote commander RM-Y136/Y137.  
MODEL: KV-27S25/27S35/27V25/27V35/29RS25/29RS25C/  
29V35C/29V65M/29V75M/32S25/32S35/32TW25/  
32V25/32V35/34V35C/35V35/35V45/35V75

Please keep this notice with the instruction manual.

## Note on Caption Vision

This television receiver provides display of television closed captioning in accordance with § 15.119 of the FCC rules.

## Note to CATV system installer

This reminder is provided to call the CATV system installer's attention to Article 820-40 of the NEC that provides guidelines for proper grounding and, in particular, specifies that the cable ground shall be connected to the grounding system of the building, as close to the point of cable entry as practical.

Use of this television receiver for other than private viewing of programs broadcast on UHF or VHF or transmitted by cable companies for the use of the general public may require authorization from the broadcaster, cable company and/or program owner.

## Owner's Record

The model and serial numbers are located at the rear of the TV. Record these numbers in the spaces provided below. Refer to them whenever you call upon your Sony dealer regarding this product.

Model No. \_\_\_\_\_  
Serial No. \_\_\_\_\_

# Table of contents

- 4 Welcome!
- 4 Checking your model number

---

## **Getting Started**

- 5 Step 1: Hookup
- 12 Step 2: Installing the glass door and adjusting the shelf
- 14 Step 3: Setting up the remote commander
- 15 Step 4: Setting up the TV automatically (AUTO SET UP)
- 18 Changing the menu language
- 18 Adjusting the tilt of the picture (TILT CORRECTION)

---

## **Operations**

- 19 Watching the TV
- 21 Watching two programs at a time—P11'
- 22 Adjusting the picture (VIDEO)
- 23 Selecting the video mode (VIDEO)
- 24 Adjusting picture brightness automatically (LIGHTSENSOR)
- 24 Adjusting the sound (AUDIO)
- 25 Using audio effect (EFFECT)
- 26 Selecting stereo or bilingual programs (MTS)
- 27 Setting the speaker switch (SPEAKER)
- 27 Setting audio out (AUDIO OUT)
- 28 Setting daylight saving time (DAYLIGHT SAVING)
- 28 Setting the clock (CURRENT TIME SET)
- 29 Setting the timer to turn the TV on and off (ON/OFF TIMER)
- 30 Customizing the channel names (CHANNEL CAPTION)
- 31 Blocking out a channel (CHANNEL BLOCK)
- 31 Setting your favorite channels (FAVORITE CHANNEL)
- 32 Setting video labels (VIDEO LABEL)
- 33 Setting Caption Vision (CAPTION VISION)
- 34 Operating video equipment
- 36 Operating a cable box or DBS receiver

---

## **Additional Information**

- 37 Troubleshooting
- 38 Specifications

**Back cover      Index**

The captions in parentheses indicate menu names.

## Welcome!

Thank you for purchasing the Sony Trinitron™ Color TV. Here are some of the features you will enjoy with your TV:

- On-screen menus that let you set the picture quality, sound, and other settings.
- Picture-in-Picture (PIP) that allows you to watch another TV channel, video or cable image as a window picture.
- Surround system that simulates the sound quality of a concert hall or movie theater (KV-27S25/27S35/29RS25/29RS25C/32S25/32S35/32TW25 only).
- SRS (SOUND RETRIEVAL SYSTEM) that allows you to receive realistic sound that recaptures audio "clues" originally present but masked in the recording process so that the action seems to happen all around you (KV-27V25/27V35/29V35C/29V65M/29V75M/32V25/32V35/34V35C/35V35/35V45/35V75 only).
- LightSensor™ that automatically adjusts the brightness of the picture (KV-27V25/27V35/29V35C/29V65M/29V75M/32V25/32V35/34V35C/35V35/35V45/35V75 only).
- S-Link™ that allows you to automatically change the TV's input mode, turn on the VCR, and play a tape by just pressing the VCR's play button (KV-27V25/27V35/29V35C/29V65M/29V75M/32V25/32V35/34V35C/35V35/35V45/35V75 only). This feature is originally designed by Sony.

## Checking your model number

The instructions in this manual are for the eighteen models listed below. Before you start reading, check your model number by looking at the rear of your TV. The KV-27S25 is the model used for illustration purposes. Any differences in operation are clearly indicated in the text, for example, "KV-27S25 only."

Instructions in this manual are based on the remote commander. You can also use the controls on the TV if they have the same name as those on the remote commander.

### Feature packages

Model number	Feature	One-tuner PIP	Two-tuner PIP	S-Link/LightSensor/SRS/Clock/Timer	Tilt correction
KV-27S25		•			
KV-27S35			•		
KV-27V25		•		•	
KV-27V35			•	•	
KV-29RS25		•			
KV-29RS25C		•			
KV-29V35C			•	•	
KV-29V65M		•		•	
KV-29V75M			•	•	
KV-32S25		•			
KV-32S35			•		
KV-32TW25		•			
KV-32V25		•		•	
KV-32V35			•	•	
KV-34V35C			•	•	
KV-35V35			•	•	•
KV-35V45			•	•	•
KV-35V75			•	•	•

# Step 1: Hookup

Although you can use either an indoor or outdoor antenna with your TV, we recommend that you connect an outdoor antenna or a cable TV system to get better picture quality.

## How to connect different types of cables

The illustrations below show examples of connecting cables to the TV directly.

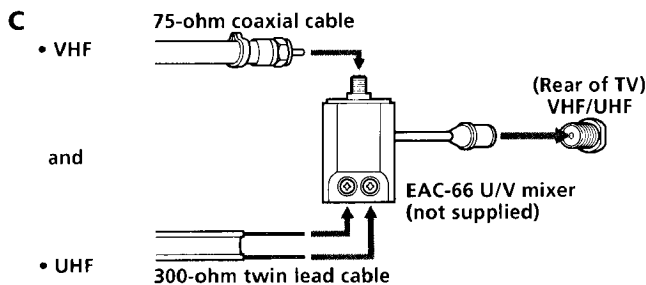
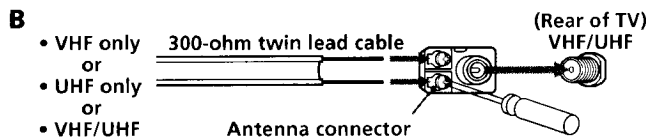
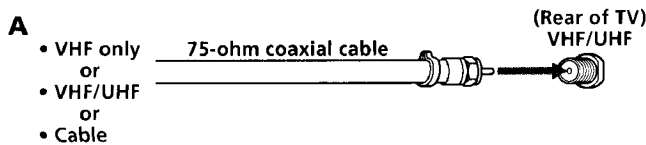

### Notes

- Most VHF/UHF combination antennas have a signal splitter. Remove the splitter before attaching the appropriate connector.
- If you use the U/V mixer, snow and noise may appear in the picture when viewing cable TV channels over 37.

## Connecting an antenna/cable TV system without a VCR

If your cable company requires you to connect a cable box, make the connection as follows:

### Cable or antenna

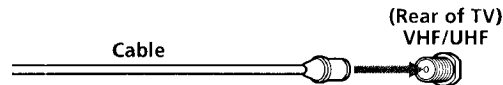

### Cable box

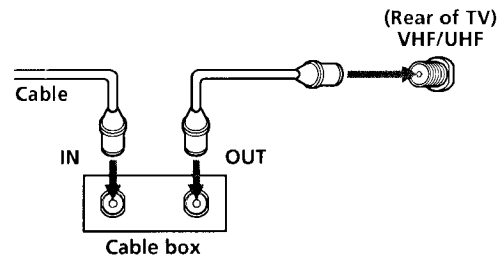

### Cable box and cable

■ KV-27S35/27V35/29V35C/29V75M/32S35/32V35/34V35C/35V35/35V45/35V75 only

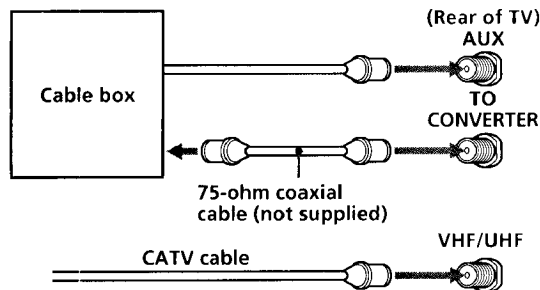

Pay cable TV systems use scrambled or encoded signals requiring a cable box\* in addition to the normal cable connection.

\* The cable box will be supplied by the cable company.

### Note

- You cannot watch the signal through AUX connector as a window picture.

### Cable and antenna

■ KV-27S35/27V35/29V35C/29V75M/32S35/32V35/34V35C/35V35/35V45/35V75 only

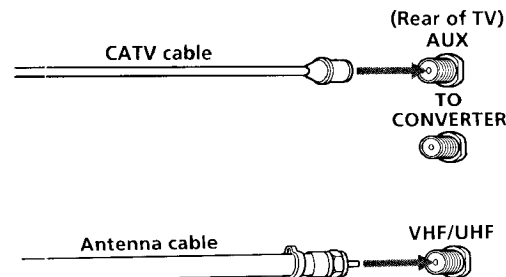

### Note

- Do not connect anything to the TO CONVERTER connector in this case.

## Connecting an antenna/cable TV system with a VCR

To connect your VCR to the TV, first check the model number of your TV and select the corresponding connection. For details on connection, see the instruction manual of your VCR.

**In order to operate PIP, a VCR must be connected to your TV and turned on (KV-27S25/27V25/29RS25/29RS25C/29V65M/32S25/32TW25/32V25 only).**

Before making the connection, disconnect the AC power cords of the equipment to be connected.

After making these connections, you will be able to do the following:

- View the playback of video tapes
- Record one TV program while viewing another program
- Watch two TV programs at once using PIP

### Without a cable box

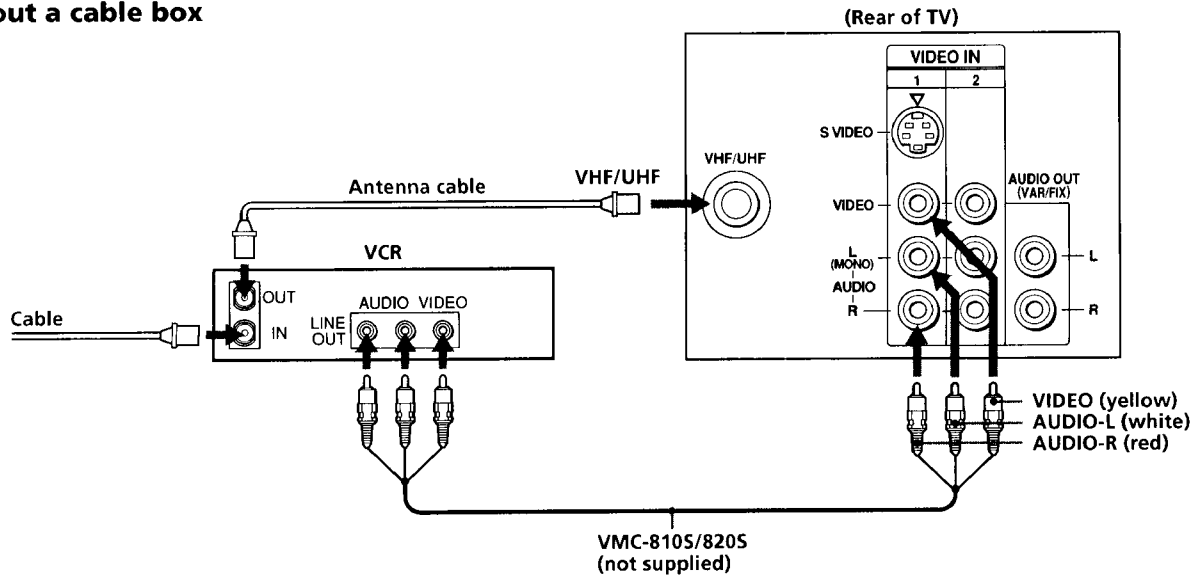

### Note

- To connect a monaural VCR, connect the audio output of the VCR to AUDIO-L (mono) of VIDEO 1 IN on the TV.

### To an S video equipped VCR without a cable box

If your VCR has an S video output jack, make the following connections.

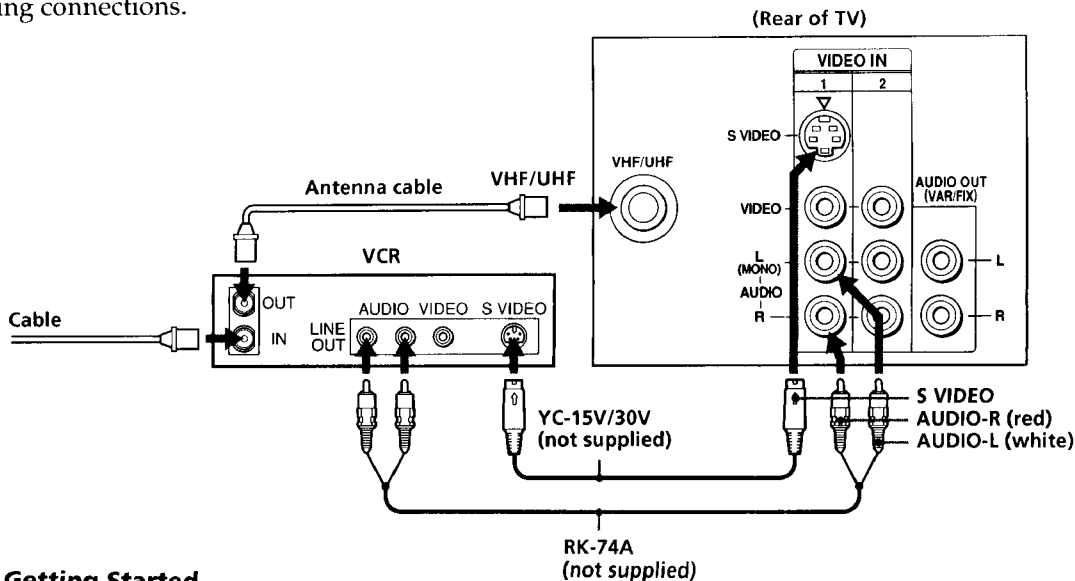

## With a cable box

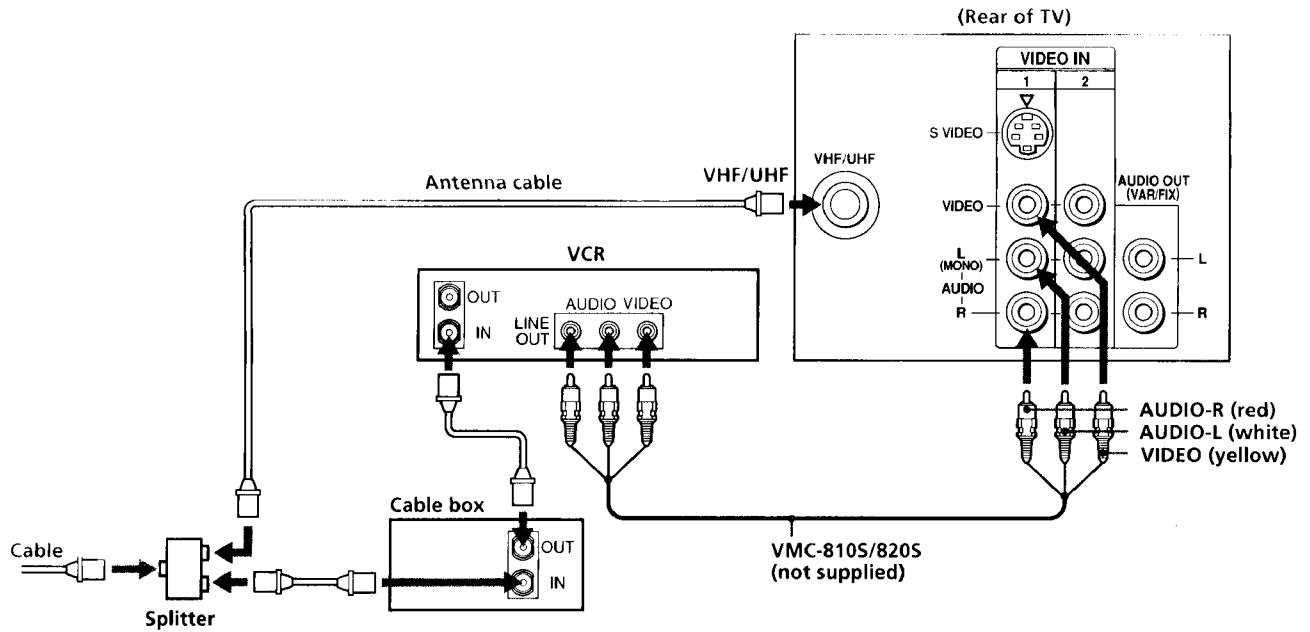

### Note

- To connect a monaural VCR, connect the audio output of the VCR to AUDIO-L (mono) of VIDEO 1 IN on the TV.

## To an S video equipped VCR with a cable box

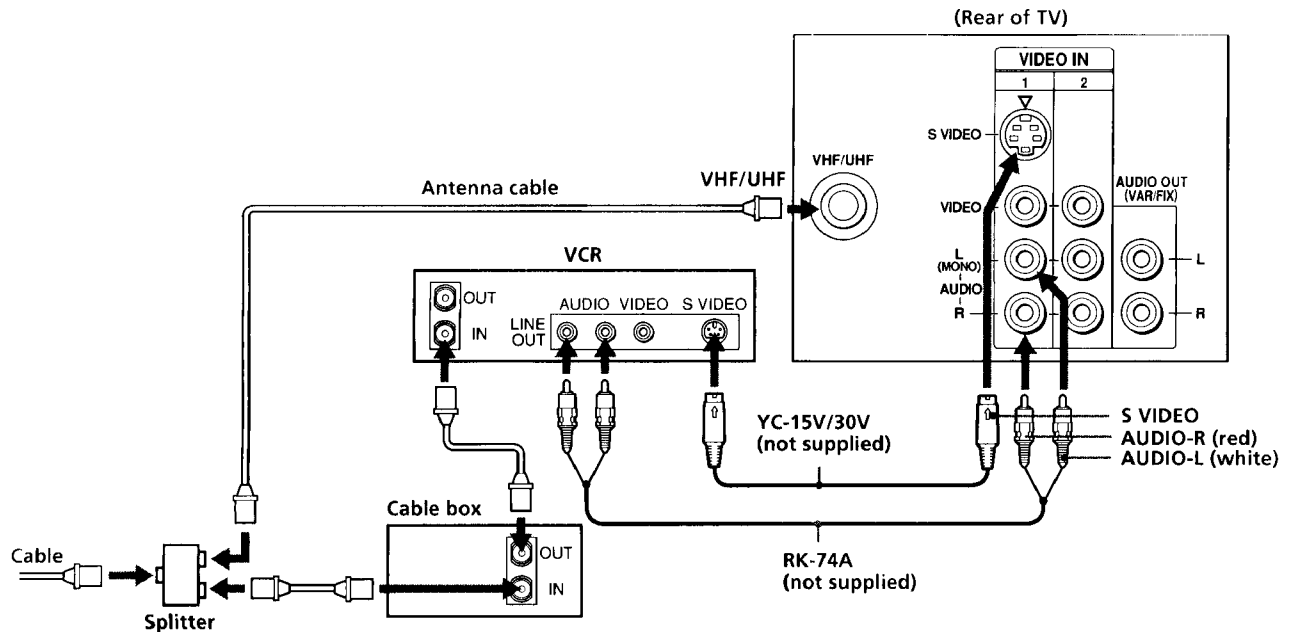

### Note

- Video signals are composed of Y (luminance) and C (chroma) signals. The S connection sends the two signals separately preventing degradation, and gives better picture quality compared to conventional connections.

## Connecting a DBS receiver

For connection details, see the instruction manual of the DBS (Digital Broadcasting Satellites) receiver.

### To a TV

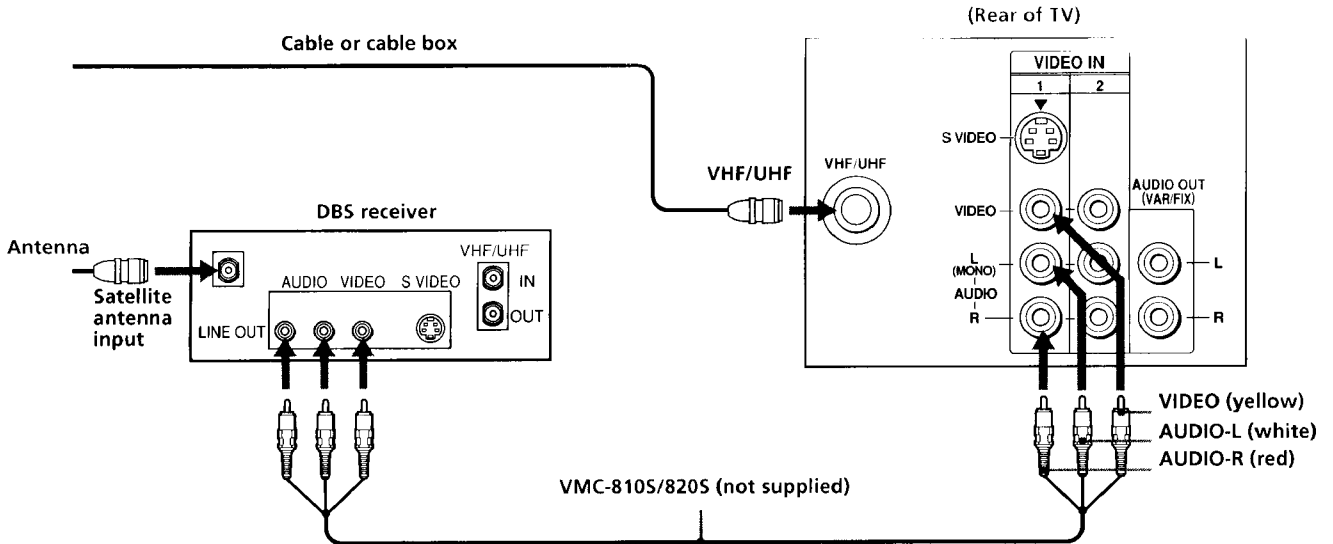

#### Note

- You can use the S VIDEO jack or the composite video jack for the video connection.

### To a TV and VCR

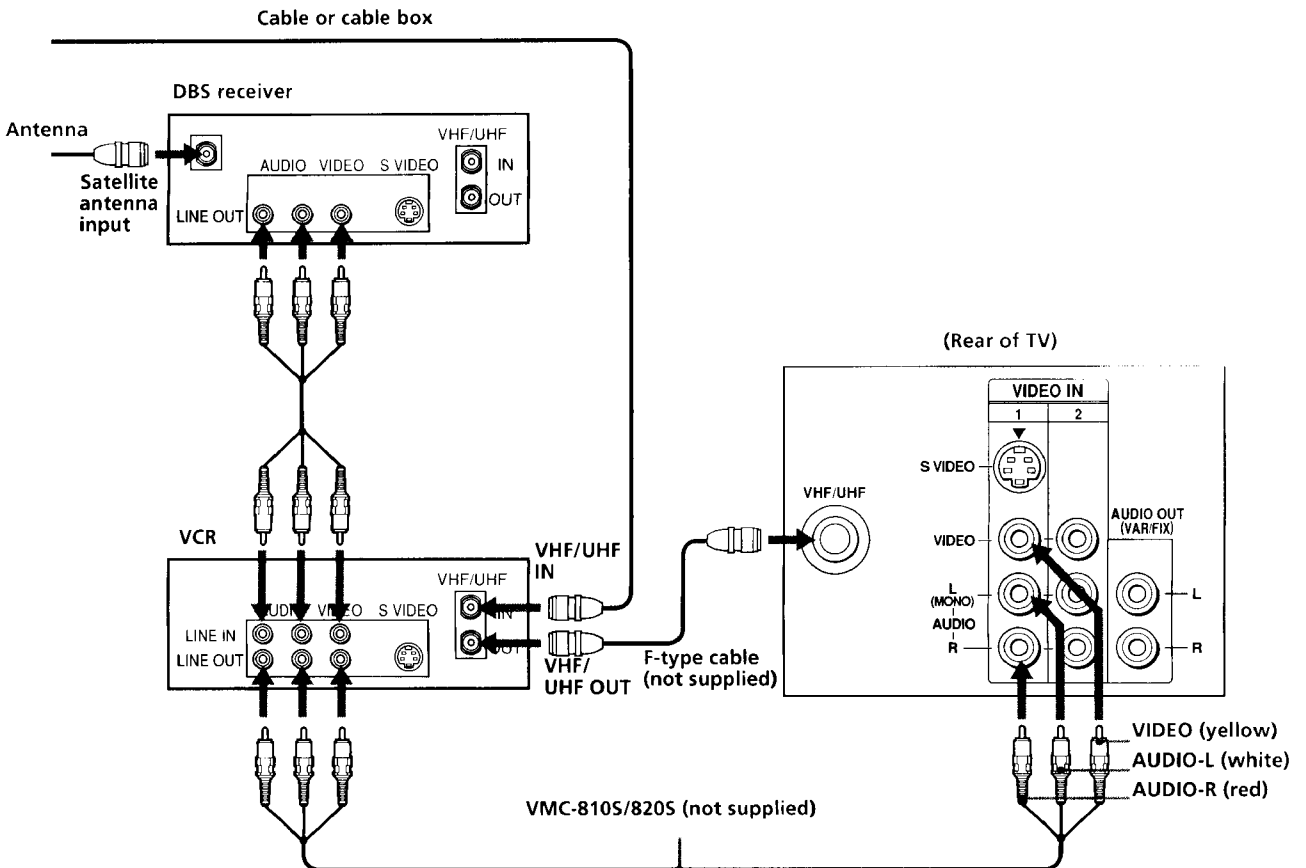



## Connecting a camcorder

■ **KV-27V25/27V35/29V35C/29V65M/29V75M/32V25/32V35/34V35C/35V35/35V45/35V75 only**

This connection is convenient for viewing a camcorder picture.

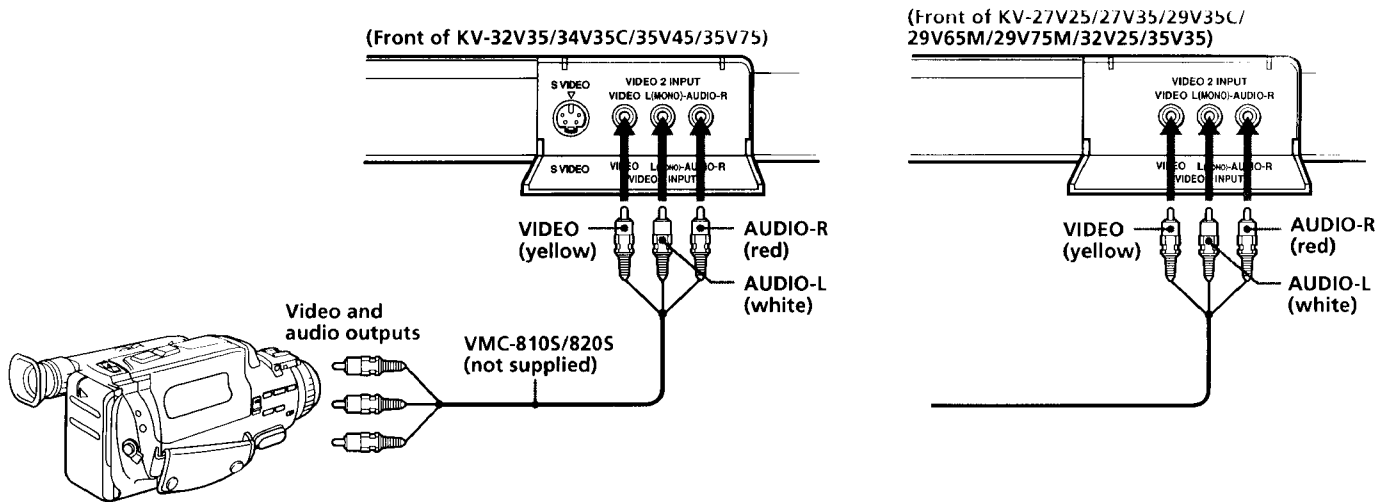

### Note

- To connect a monaural camcorder, connect the audio output of the camcorder to AUDIO-L (mono) of VIDEO 2 INPUT on the TV.

## Connecting an audio system

When connecting audio equipment, see page 27 for more information.

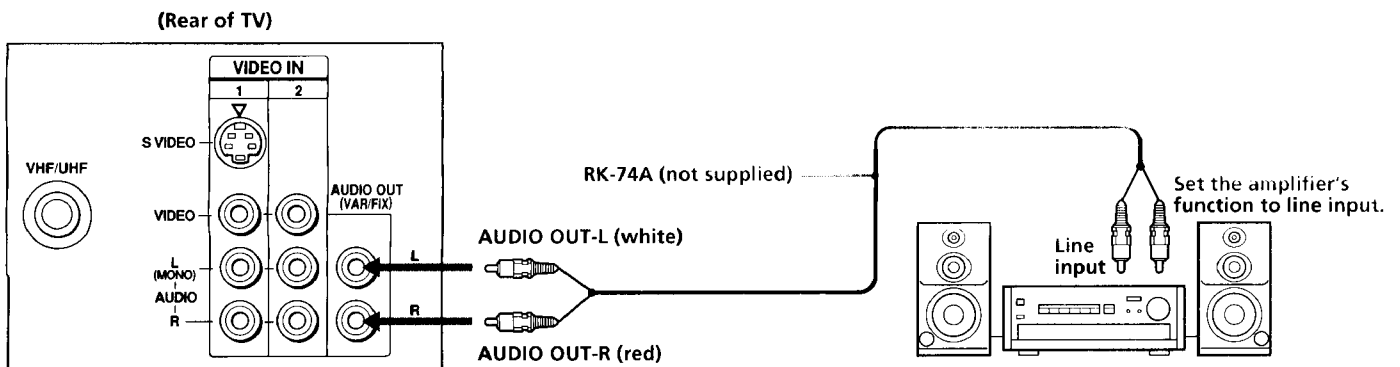

## Connecting two VCRs for tape editing using MONITOR OUT

■ KV-27V25/27V35/29V35C/29V65M/29V75M/32V25/32V35/34V35C/35V35/35V45/35V75 only

MONITOR OUT allows you to record a program that is on the screen.

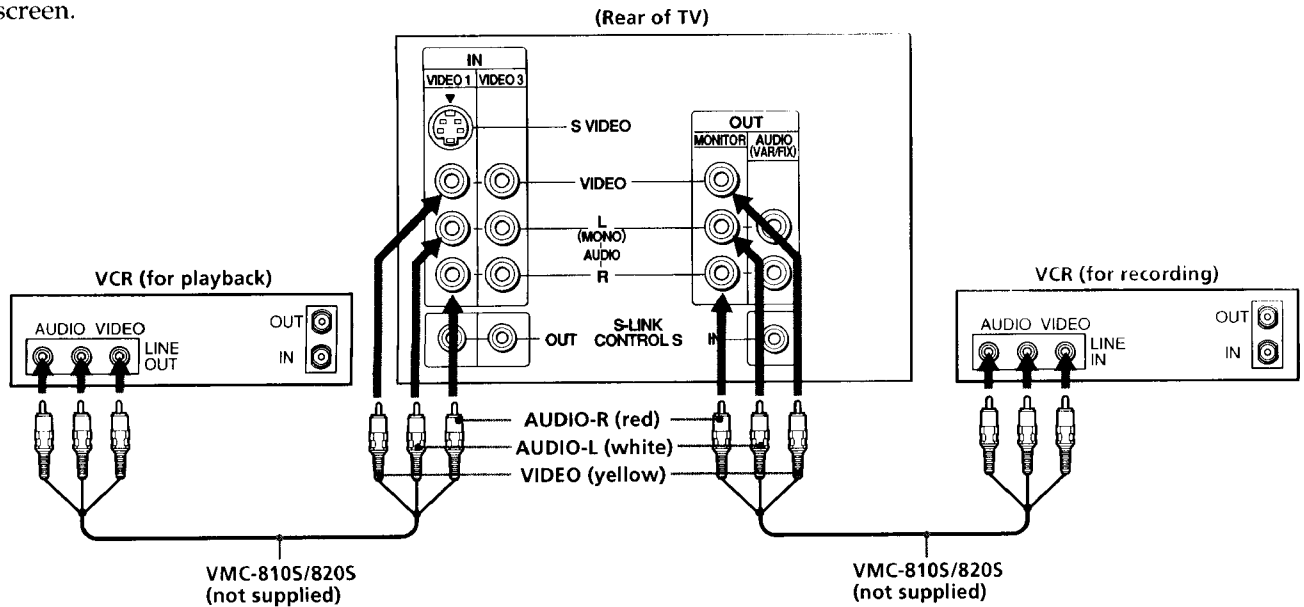

The above type of connection should only be used when you connect from the line input of one VCR, and from the line output of a second VCR.

- When connecting a single VCR to the TV, do not connect the MONITOR OUT jacks at the rear of the TV to the VCR's line input, while at the same time connecting from the TV's VIDEO IN jacks to the VCR's line output, as shown below.

### Notes

- Do not change the input signal while editing through MONITOR OUT, or the output signal will also change.
- You can use the S video jack to connect a VCR for playback and the composite video jack to connect a VCR for recording.

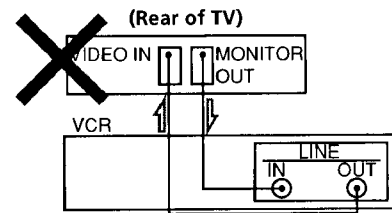

## Using the S-Link function

■ KV-27V25/27V35/29V35C/29V65M/29V75M/32V25/32V35/34V35C/35V35/35V45/35V75 only

The S-Link feature allows you to operate the TV and VCR with the S-Link function in the following ways:

- When you press the VCR's stop button, the TV's input mode is automatically changed to video, and the VCR starts playing a tape.

- When you press the VCR's stop button, the TV automatically returns to the previous input mode.
- You can turn off the TV and VCR together using the SYSTEM OFF button (see page 35 for details).

### Note

- The TV may malfunction if you connect the S-Link cable to the TV without connecting the other end of the cable to the VCR.

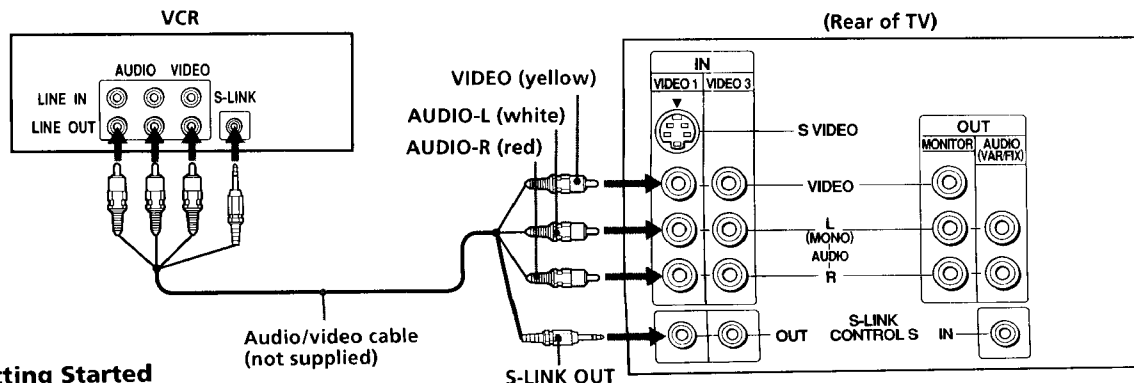

## Connecting an AV receiver

Connect an optional AV receiver to the VIDEO 1 IN jacks at the rear of the TV.

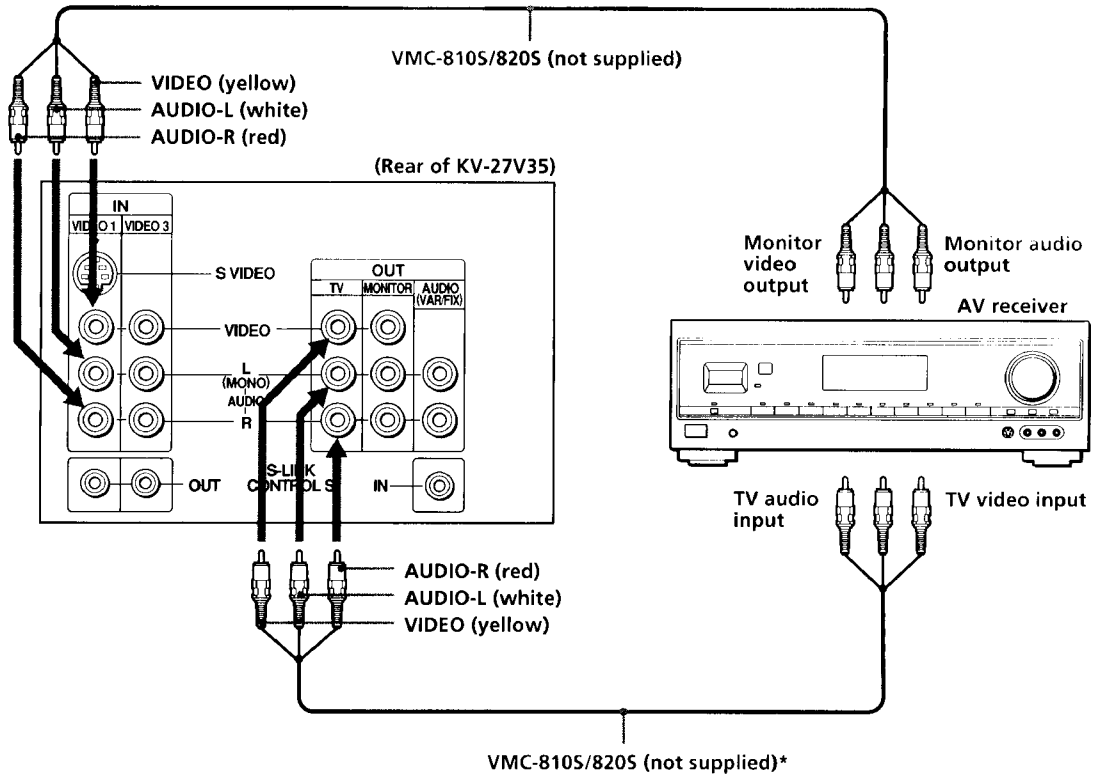

\* (KV-27V35/29V35C/29V75M/32V35/34V35C/35V45/35V75 only)

Make this connection if your TV has the TV OUT jacks. When you connect an AV receiver to the TV using the AV receiver's TV input jacks, it is recommended to set VIDEO 1 IN's video label to "RECEIVER" (see page 32 for details).

# Step 2: Installing the glass door and adjusting the shelf



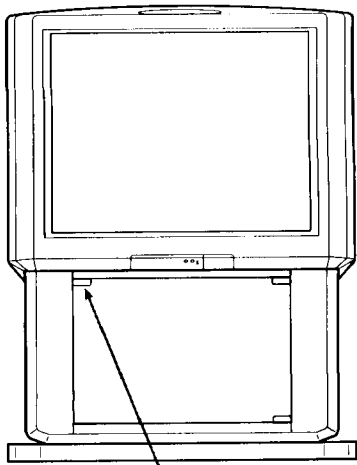

■ KV-32TW25I35V75 only

Follow these instructions to install the glass door and adjust the shelf.



Push here to close.  
To open, push again.

## Parts List

❶	Bottom hinge		1
❷	Top hinge		1
❸	Screw 4 × 4		4
❹	Plate pad		1
❺	Plate		1

## Installing the glass door

- 1 Check that the projection of the screw through the hinge allows for proper installation of the hinge to the glass door, and then insert the bottom hinge ❶ into the hole located at the bottom, right side of cabinet.

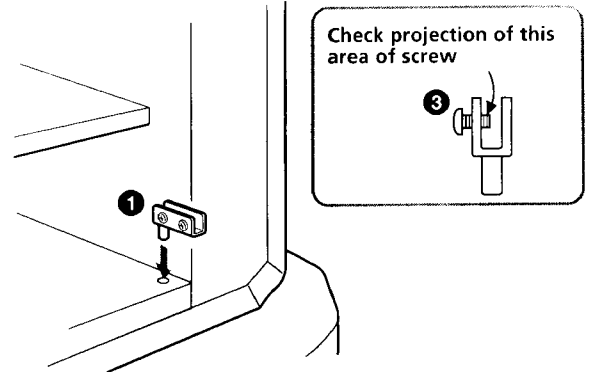

- 2 Attach the top hinge ❷ to the right side of the glass door, tighten the screws snugly, but do not overtighten. Attach the plate pad ❹ to the left side and push the plate ❺ over the plate pad.

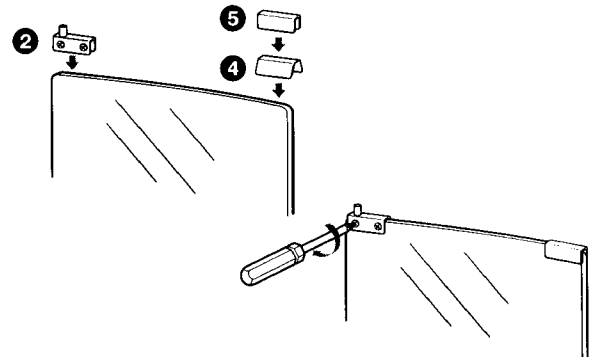

- 3 Push the top, glass door hinge into the top, right bushing and gently slide the glass door into the bottom hinge. Adjust the glass door until level, and tighten the hinge screws.

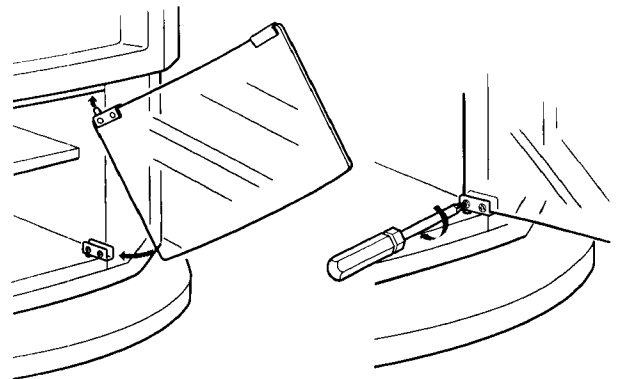

### Note

- The glass door is made of tempered glass. Although it is more shock-resistant than ordinary glass, tempered glass may shatter if it is dropped or receives a sudden shock.

---

## Adjusting the shelf

- 1** Unlock the four shelf supports with a medium Philips head screwdriver. Turn the screwdriver 90° to unlock the shelf supports.

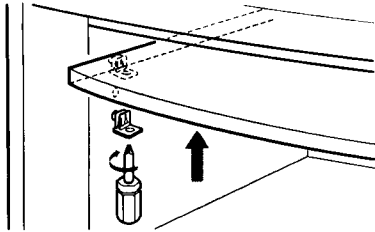

- 2** Gently slide the shelf up and out.

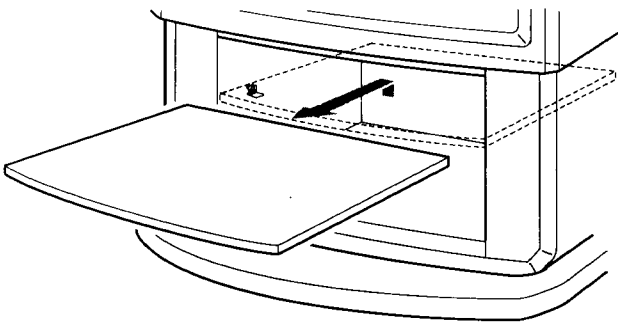

- 3** Insert shelf supports in the appropriate holes. Slide shelf in, align the shelf grooves with the shelf supports, and slide the shelf down.

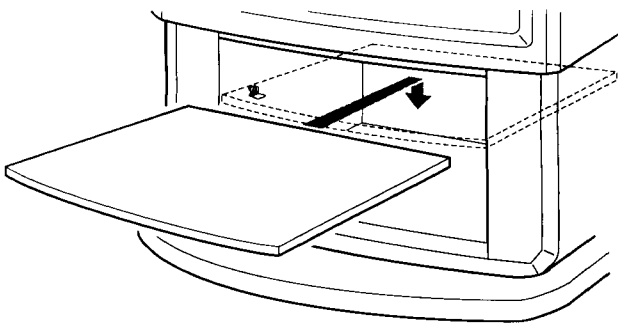

# Step 3: Setting up the remote commander

## Inserting batteries

Insert two size AA (R6) batteries (supplied) by matching the + and - on the battery to the diagram inside the battery compartment.

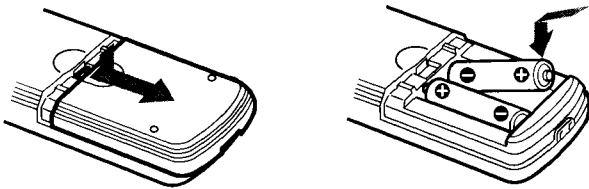

### Notes

- Under normal conditions, batteries will last up to six months. If the remote commander does not operate properly or the indicators of the buttons on the remote commander do not light up, the batteries may be worn out. When replacing batteries, replace both of them with new ones.
- Do not mix old batteries with new ones or mix different types of batteries together.
- If the electrolyte inside the battery should leak, wipe the contaminated area of the battery compartment with a cloth and replace the old batteries with new ones. To prevent the electrolyte from leaking, remove the batteries when you don't plan to use the remote commander for a long period of time.
- Do not handle the remote commander roughly. Do not drop it, step on it or let it get wet.
- Do not place the remote commander in direct sunlight, near a heater, or where the humidity is high.

## Getting to know buttons on the remote commander

Names of buttons on the remote commander are indicated in different colors to represent the available functions.

### Button color

- Transparent ..... TV/VCR/DBS/Cable box function (light up) buttons. Press the appropriate function button first to change the remote commander's function.
- Green ..... Buttons relevant to power operations.

### Label color

- White ..... TV/VCR/DBS/Cable box operation buttons.
- Yellow ..... PIP operation buttons.
- Blue ..... DBS operation buttons.

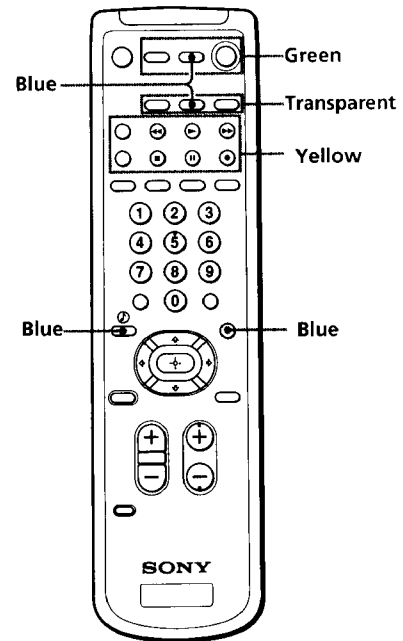

# Step 4: Setting up the TV automatically

## (AUTO SET UP)

You can set up your TV easily by using the AUTO SET UP feature. It presets all the receivable channels. To set up the TV manually, see "Setting cable TV on or off" (page 17) and "Presetting channels" (page 17).

(Front of TV)

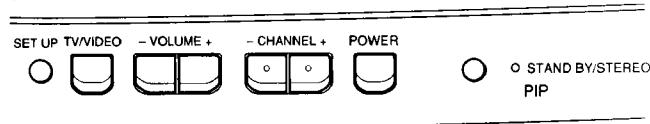

For KV-27V35/29V35C/29V75M/32V35/34V35C/35V45/35V75, the control buttons are located on the top of the TV.

**Before you start using AUTO SET UP, be sure to connect the antenna or cable to the TV (see page 5).**

### 1 Press POWER to turn on the TV.

The AUTO SET UP screen appears.

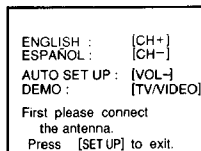

#### Note

- The AUTO SET UP screen appears whenever you press the POWER button if you do not execute AUTO PROGRAM.

### 2 (Except Canadian models)

**Press CHANNEL + to select English screens or CHANNEL - to select Spanish screens.**

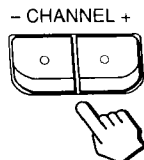

### 3 Press VOLUME -.

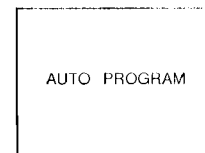
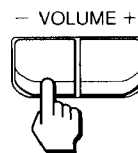

"AUTO PROGRAM" appears on the screen and the TV starts scanning and presetting channels automatically. When all the receivable channels are stored, "AUTO PROGRAM" disappears and the lowest numbered channel is displayed. If the TV receives cable TV channels, CABLE is set to ON automatically.

#### To perform AUTO SET UP again

- Press SET UP on the TV.
- (Except Canadian models) Press CHANNEL + or CHANNEL - to select the language.
- Press VOLUME -.  
The picture and sound settings will be set to the factory preset conditions.
- Press CHANNEL +.  
"AUTO PROGRAM" appears on the screen and the TV starts scanning and presetting channels.
- Press CHANNEL - to exit the AUTO SET UP menu.

#### To exit AUTO PROGRAM

Press any button.

#### Notes

- If the TV is set to a video input, you cannot execute AUTO SET UP. Press TV (black button) so that a channel number appears.
- Using the AUX connector, press TV (black button) first and make sure that "AUX" is displayed beside the channel number on the screen. Then follow the procedure above to perform AUTO SET UP. (KV-27S35/27V35/29V35C/29V75M/32S35/32V35/34V35C/35V35/35V45/35V75 only)

#### To browse the main functions (DEMO)

Press TV/VIDEO on the TV in step 3. The functions and menus are displayed one by one.

#### To exit DEMO

Press any button.

## Erasing or adding channels

After AUTO SET UP, you can erase unnecessary channels or add the channels you want. Preset channels during the day rather than late at night, when some channels may not be broadcasting.

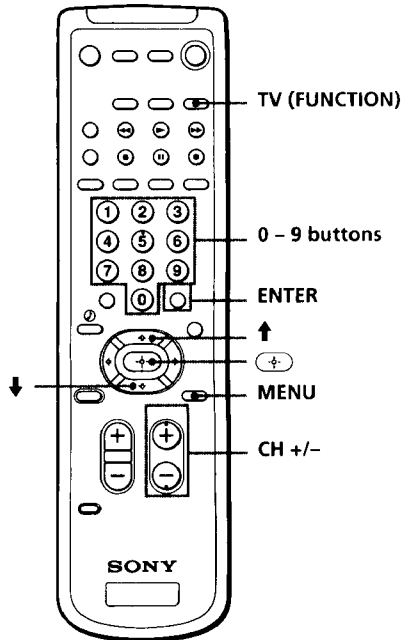

### 1 Press TV (FUNCTION).

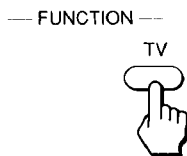

### 2 Press MENU.

The main menu appears.

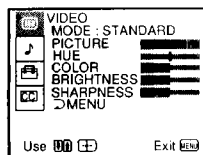

### 3 Press ↑ or ↓ to select , and press .

The SET UP menu appears.

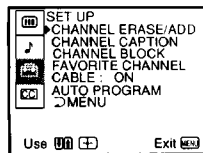
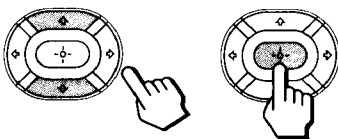

### 4 Press ↑ or ↓ to select CHANNEL ERASE/ADD, and press .

The CHANNEL ERASE/ADD menu appears.

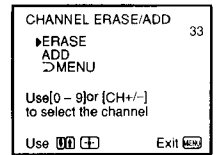
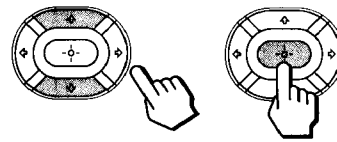

### 5 Erase and/or add channels:

#### To erase an unwanted channel

- (1) Make sure the cursor (▶) is beside ERASE.
- (2) Press CH +/- or the 0 - 9 buttons to select the channel you want to erase, and press ENTER.

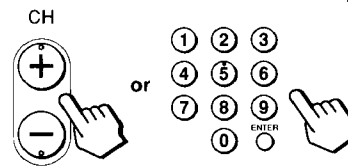

Selected channel number

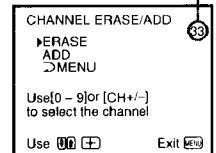

- (3) Press .

The "-" indication appears beside the channel number, showing that the channel is erased from the preset memory.

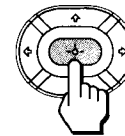

#### To add a channel that you want

- (1) Press ↑ or ↓ to move the cursor (▶) to ADD.
- (2) Press the 0 - 9 buttons to select the channel you want to add, and press ENTER.

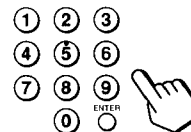

Selected channel number

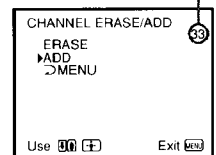

- (3) Press .

The "+" indication appears beside the channel number, showing that the channel is added to the preset memory.

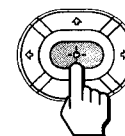

### 6 To erase and/or add other channels, repeat step 5.



## 7 Press MENU to return to the original screen.



### Notes

- If you erase or add a VHF or UHF channel, the cable TV channel with the same number is also erased or added, and vice versa.
- Erasing and adding channels is also available for the AUX input. (KV-27S35/27V35/29V35C/29V75M/32S35/32V35/34V35C/35V35/35V45/35V75 only)



## Setting cable TV on or off

If you have connected the TV to a cable TV system, set CABLE to ON (the factory setting). If not, set CABLE to OFF. You do not have to do this procedure if you execute AUTO SET UP (page 15). Do this procedure only when you want to set it manually.

### 1 Press MENU.

### 2 Press $\uparrow$ or $\downarrow$ to select , and press .

### 3 Set CABLE to ON or OFF:

- (1) Press  $\uparrow$  or  $\downarrow$  to move the cursor ( $\blacktriangleright$ ) to CABLE, and press .
- (2) Press  $\uparrow$  or  $\downarrow$  to select ON or OFF, and press .

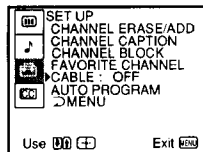
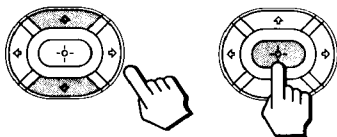

### 4 Press MENU to return to the original screen.

### Note

- If CABLE appears in gray, the TV is set to a video input and you cannot select CABLE. Press TV (black button) so that a channel number appears.

## Presetting channels

You can preset TV channels easily by using the AUTO PROGRAM feature. You do not have to do this procedure if you execute AUTO SET UP (page 15). Do this procedure only when you want to set it manually.

### 1 Press MENU.

### 2 Press $\uparrow$ or $\downarrow$ to select , and press .

### 3 Press $\uparrow$ or $\downarrow$ to select AUTO PROGRAM, and press .

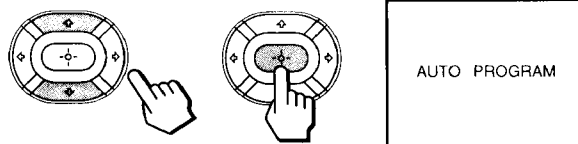

"AUTO PROGRAM" appears on the screen and the TV starts scanning and presetting channels automatically. When all the receivable channels are stored, "AUTO PROGRAM" disappears and the lowest numbered channel is displayed.

### 4 Press MENU to return to the original screen.

### To exit AUTO PROGRAM

Press any button.

### Notes

- If the AUTO PROGRAM menu appears in gray, the TV is set to a video input and you cannot select AUTO PROGRAM. Press TV (black) so that a channel number appears.
- Presetting channels is also available for the AUX input. (KV-27S35/27V35/29V35C/29V75M/32S35/32V35/34V35C/35V35/35V45/35V75 only)

# Changing the menu language

## ■ Except Canadian models

If you prefer Spanish to English, you can change the menu language. You do not have to do this procedure if you select the language during AUTO SET UP (page 15).

**1 Press MENU.**

**2 Press ↑ or ↓ to select , and press .**

**3 Press ↑ or ↓ to select LANGUAGE, and press .**

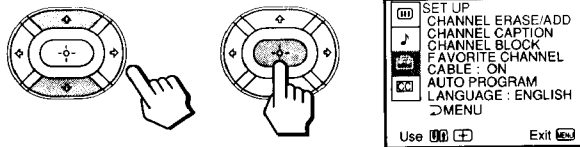

**4 Press ↑ or ↓ to select your favorite language, "ENGLISH" or "ESPAÑOL," and press .**

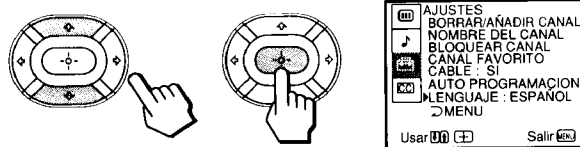

**5 Press MENU to return to the original screen.**

### Note

- Certain parts of the Spanish menus remain in English.

# Adjusting the tilt of the picture (TILT CORRECTION)

## ■ KV-35V35/35V45/35V75 only

You can adjust the tilt of the picture if it is not aligned with the TV screen. Misalignment may be caused by the direction of the earth's magnetic fields in relation to the position of the TV.

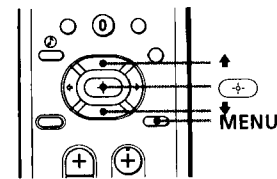

**1 Press MENU.**

**2 Press ↑ or ↓ to select , and press .**

**3 Press ↑ or ↓ to select TILT CORRECTION, and press .**

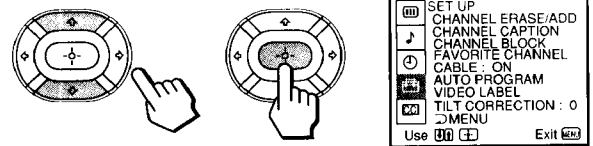

**4 Press ↑ or ↓ to adjust the tilt between +5 and -5.**

**5 Press MENU to return to the original screen.**

### Notes

- If your house is located near a high-voltage cable or is of reinforced concrete, you may not be able to correct the tilt of the picture properly. Consult your nearest Sony dealer.
- If there are large speakers near the TV, the tilt of the picture cannot be corrected properly. Place the TV away from the speakers.

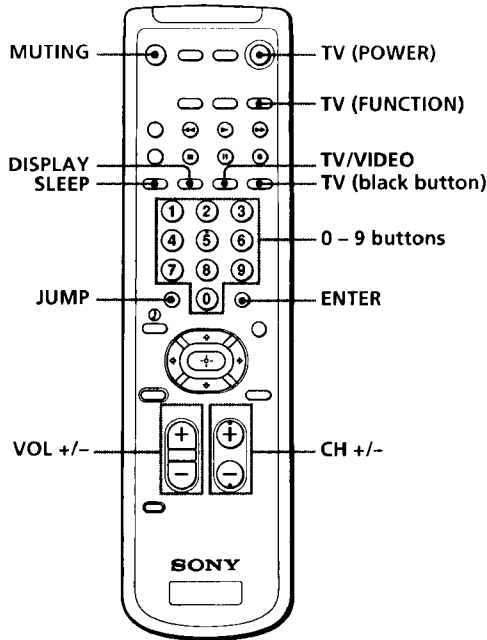

**1 Press TV (POWER) to turn on the TV.**



If "VIDEO" appears on the screen, press TV (black button) so that a channel number appears.

**2 Press TV (FUNCTION).**

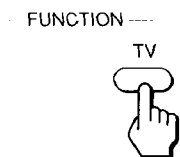

Once you press TV (FUNCTION), the TV function is set unless another function button is pressed.

**3 Select the channel you want:**

**To select a channel directly**

Press the 0 - 9 buttons, and press ENTER.

**To scan through channels**

Press CH +/- until the channel you want appears.

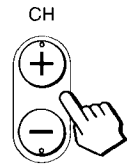
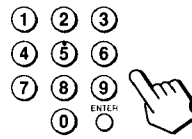

The channel can also be selected without pressing ENTER.

**4 Press VOL +/- to adjust the volume.**

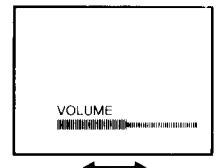
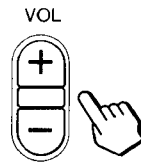

**Switching quickly between two channels**

You can use the JUMP button to switch or "jump" back and forth between two channels.

**Press JUMP.**



Pressing JUMP again switches back the channel.

**Note**

- You cannot jump to channels you scanned through using the CH +/- buttons.

**Muting the sound**

**Press MUTING.**

"MUTING" appears on the screen.



To restore the sound, press MUTING again, or press VOL +.



# Watching two programs at a time — PIP

The Picture-in-Picture (PIP) feature allows you to watch both the main picture and a window picture simultaneously.

For KV-27S25/27V25/29RS25/29RS25C/29V65M/32S25/32TW25/32V25, your TV must be connected to a VCR to enjoy this feature. See "Connecting an antenna/cable TV system with a VCR" (page 6) for connections. In order to operate PIP, your VCR must be turned on.

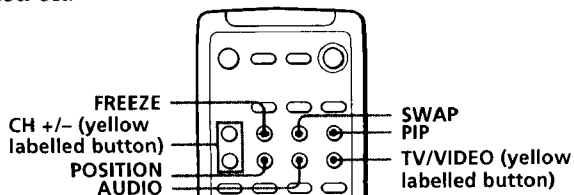

Use the yellow labelled buttons for PIP operations.

## Displaying a window picture

**Press PIP.**

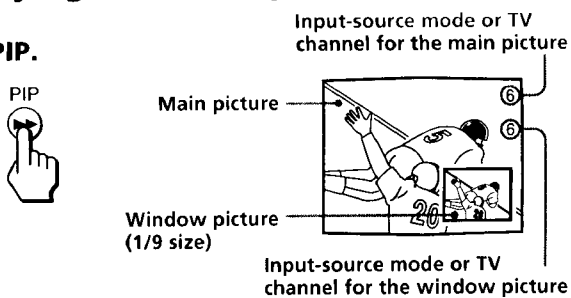

**Press PIP again to display a smaller window picture.**

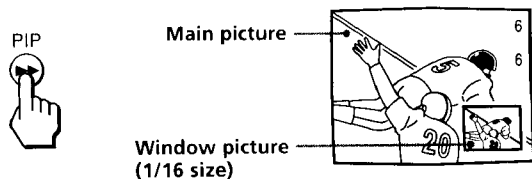

To remove the window picture, press PIP again.

**Note**

- The window picture may be affected by the condition of the main picture.

## Changing the window picture input mode

**Press TV/VIDEO (yellow labelled button) to select the input mode.**

Each time you press TV/VIDEO (yellow labelled button), "TV," "VIDEO 1," "VIDEO 2," and "VIDEO 3 (KV-27V25/27V35/29V35C/29V65M/29V75M/32V25/32V35/34V35C/35V35/35V45/35V75 only)" appear in sequence.

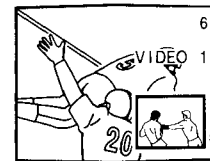

A window picture will appear in the same input mode as the last time you used PIP.

**Note**

- If you use one of the connections from page 6, your PIP input source is a VCR. If you use one of the connections from page 7, your PIP input source is a VCR or cable box.

## Listening to the sound of the window picture

**Press AUDIO.**

The display appears next to the PIP channel number for a few seconds, indicating that the window picture sound is being received.

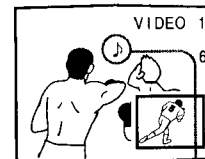

The sound of the window picture is received.

To restore the main picture sound, press AUDIO again. The display moves to the main picture channel number.

## Changing TV channels in the window picture

**Press CH +/- (yellow labelled button).**

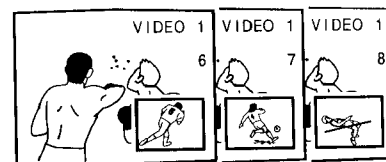
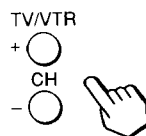

## Changing the position of the window picture

### Press POSITION.

Each time you press POSITION, the window picture will move counterclockwise on the screen.

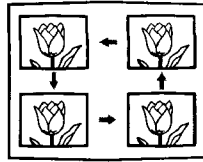

## Freezing the window picture

This feature is useful when you want to write down a recipe from a cooking program, a displayed address, or a phone number for example.

### Press FREEZE.

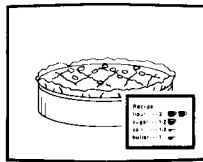

To restore the normal screen, press FREEZE again.

## Swapping the main and window pictures

### Press SWAP.

Each time you press SWAP, the images from the main and window pictures switch places along with the sound.

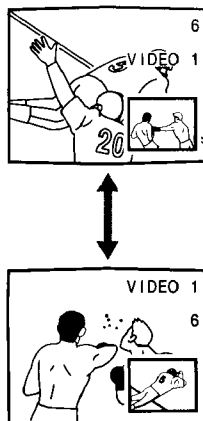

### Note

- The channels being received through the AUX jack cannot be displayed as a window picture. (KV-27S35/27V35/29V35C/29V75M/32S35/32V35/34V35C/35V35/35V45/35V75 only)

# Adjusting the picture (VIDEO)

When watching TV programs, you can adjust the picture to suit your taste.

You can adjust the picture of video input(s) as well. These settings are stored separately from those for the TV picture.

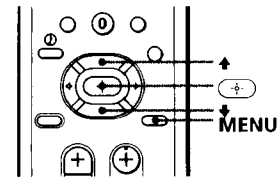

### 1 Press MENU.

### 2 Press ↑ or ↓ to select , and press .

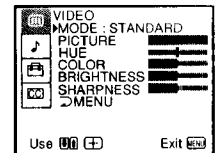
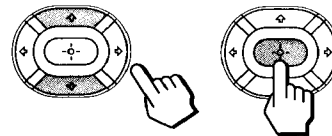

### 3 Select the item you want to adjust. For example:

- (1) To adjust the brightness, press ↑ or ↓ to move the cursor (▶) to BRIGHTNESS.

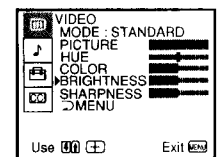
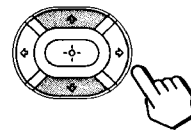

- (2) Press .

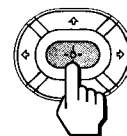

#### 4 Adjust the selected item:

(1) Press  $\uparrow$  or  $\downarrow$  to adjust the item.

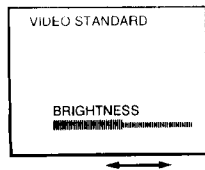
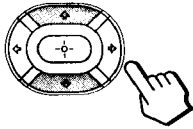

(2) Press  $\ominus$ .

The new setting appears in the VIDEO menu.

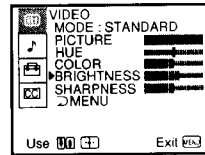
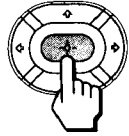

For details on each item, see “Description of adjustable items” below.

**5 To adjust other items, repeat steps 3 and 4.**

**6 Press MENU to return to the original screen.**

#### Description of adjustable items

Item	Press $\downarrow$ to	Press $\uparrow$ to
PICTURE	Decrease picture contrast and give soft color.	Increase picture contrast and give vivid color.
HUE	Make picture tones become purplish.	Make picture tones become greenish.
COLOR	Decrease color intensity.	Increase color intensity.
BRIGHTNESS	Darken the picture.	Brighten the picture.
SHARPNESS	Soften the picture.	Sharpen the picture.

#### To restore the factory settings

Press RESET while the VIDEO menu is displayed. All the settings are restored to the factory settings.

## Selecting the video mode (VIDEO)

The video mode feature allows you to choose three different modes of picture settings. Choose the one that best suits the type of program that you want to watch.

**1 Press MENU.**

**2 Press  $\uparrow$  or  $\downarrow$  to select  $\square$ , and press  $\ominus$ .**

**3 Press  $\uparrow$  or  $\downarrow$  to select MODE, and press  $\ominus$ .**

**4 Press  $\uparrow$  or  $\downarrow$  to select STANDARD, MOVIE, or SPORTS mode, and press  $\omin�$ .**

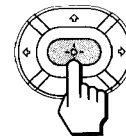
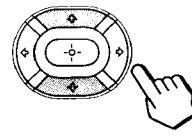

Choose	To
STANDARD	Receive a standard picture.
MOVIE	Receive a finely detailed picture.
SPORTS	Receive a vivid, bright picture.

**5 Press MENU to return to the original screen.**

#### Note

- The settings for these modes can be adjusted in the VIDEO menu.

# Adjusting picture brightness automatically (LIGHTSENSOR)

■ KV-27V25/27V35/29V35CI/29V65MI/29V75MI/32V25/32V35/34V35CI/35V35/35V45/35V75 only

The LightSensor feature adjusts the brightness of the picture automatically according to the ambient brightness.

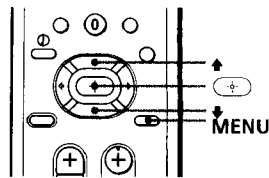

**1** Press MENU.

**2** Press ↑ or ↓ to select , and press .

**3** Press ↑ or ↓ to select LIGHTSENSOR, and press .

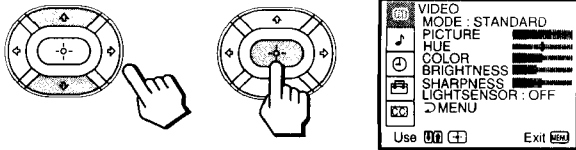

**4** Press ↑ or ↓ to select ON or OFF, and press .

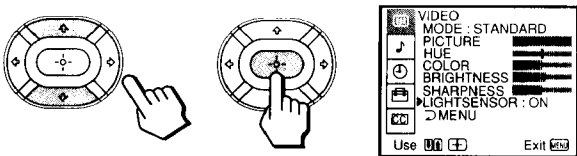

**5** Press MENU to return to the original screen.

### Note

- The LightSensor function may malfunction if you stand or place objects in front of the TV.

# Adjusting the sound (AUDIO)

You can adjust the TV sound to suit your taste. You can adjust the sound of the video input(s) as well. These settings are stored separately from those for the TV sound.

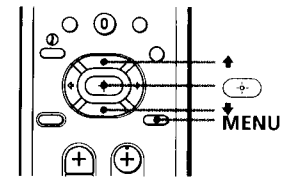

**1** Press MENU.

**2** Press ↑ or ↓ to select , and press .

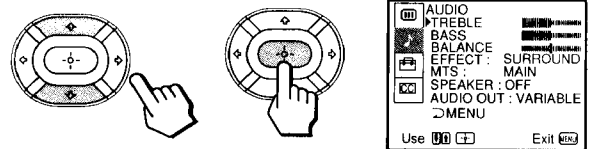

**3** Select the item you want to adjust.  
For example:

(1) To adjust bass, press ↑ or ↓ to move the cursor (▶) to BASS.



(2) Press .

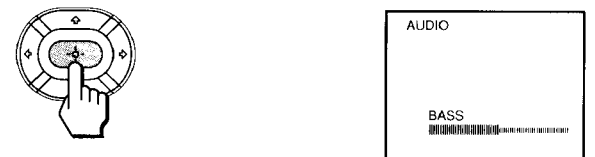



#### 4 Adjust the selected item:

(1) Press  $\uparrow$  or  $\downarrow$  to adjust the item.

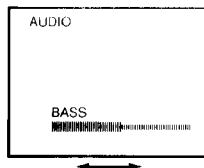
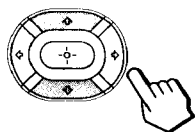

(2) Press  $\oplus$ .

The new setting appears in the AUDIO menu.

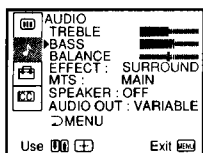
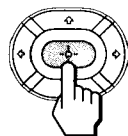

For details on each item, see "Description of adjustable items" below.

#### 5 To adjust other items, repeat steps 3 and 4.

#### 6 Press MENU to return to the original screen.

#### Description of adjustable items

Item	Press $\downarrow$ to	Press $\uparrow$ to
TREBLE	Decrease the treble response.	Increase the treble response.
BASS	Decrease the bass response.	Increase the bass response.
BALANCE	Emphasize the left speaker's volume.	Emphasize the right speaker's volume.

#### To restore the factory settings

Press RESET while the AUDIO menu is displayed.

#### Note

- When SPEAKER (page 27) is OFF and AUDIO OUT (page 27) is in the FIXED condition, the volume, TREBLE, BASS, and BALANCE cannot be adjusted.

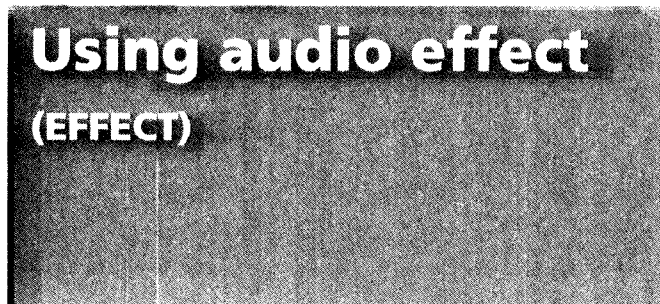

#### Using the $\text{MUSIC}$ (audio effect) button

■ For KV-27S25/27S35/29RS25/29RS25C/32S25/32S35/32TW25 only

Press  $\text{MUSIC}$ .

Each time you press the  $\text{MUSIC}$  button, the display changes as follows:

SURROUND  $\rightarrow$  SURROUND OFF

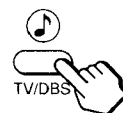

■ For KV-27V25/27V35/29V35C/29V65M/29V75M/32V25/32V35/34V35C/35V35/35V45/35V75 only

Press  $\text{MUSIC}$ .

Each time you press the  $\text{MUSIC}$  button, the display changes as follows:

SRS  $\rightarrow$  SIMULATED  $\rightarrow$  EFFECT OFF

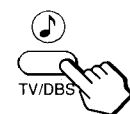

Choose	To
SURROUND	Simulate sound reproduction with the atmosphere of a movie theater or a concert hall. Surround sound is only effective for stereo programs.
SRS	When the program's audio signal is stereo or encoded, SRS expands the material and embraces you with dynamic three-dimensional sound.
SIMULATED	Receive monaural sound with a surround-like effect.

#### Note

- To use the  $\text{MUSIC}$  button function, press TV (FUNCTION).

## Using the menu to set audio effect

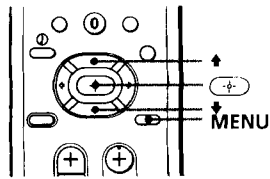

- 1 Press **MENU**.
- 2 Press **↑** or **↓** to select **♪**, and press **↵**.
- 3 Press **↑** or **↓** to select **EFFECT**, and press **↵**.

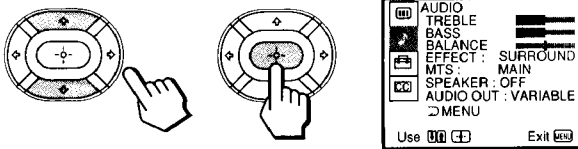

- 4 Press **↑** or **↓** to select the audio effect mode, and press **↵**.

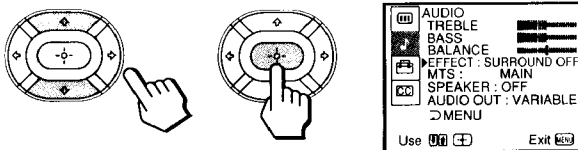

- 5 Press **MENU** to return to the original screen.

## Selecting stereo or bilingual programs (MTS)

The Multichannel TV Sound (MTS) feature allows you to enjoy stereo sound or Second Audio Programs (SAP) of your choice. The initial setting is stereo sound (MAIN).

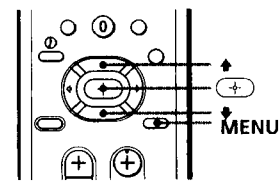

- 1 Press **MENU**.
- 2 Press **↑** or **↓** to select **♪**, and press **↵**.
- 3 Press **↑** or **↓** to select **MTS**, and press **↵**.

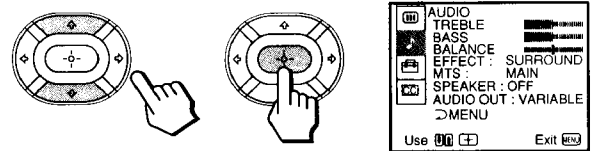

- 4 Press **↑** or **↓** to select **MAIN**, **SAP**, or **MONO**, and press **↵**.

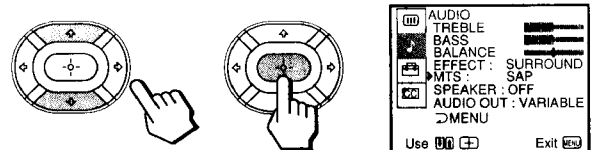

Choose	To
MAIN	Listen to stereo sound. The STEREO indicator on the TV lights up when a stereo broadcast is received.
SAP	Listen to bilingual programs. There is no sound when the SAP signal is not broadcasting.
MONO	Listen to monaural sound. Reduce noise during stereo broadcasts.

- 5 Press **MENU** to return to the original screen.

### Note

- Stereo and SAP sounds are subject to program sources.

## Setting the speaker switch (SPEAKER)

You may switch off the TV speakers when, for example, you want to listen to the sound through a stereo system.

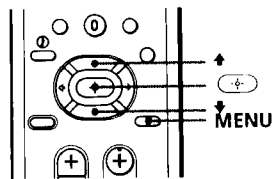

- 1 Press MENU.
- 2 Press ↑ or ↓ to select , and press .
- 3 Press ↑ or ↓ to select SPEAKER, and press .

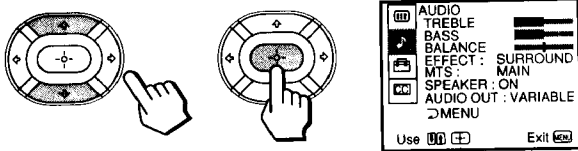

- 4 Press ↑ or ↓ to select ON or OFF, and press .

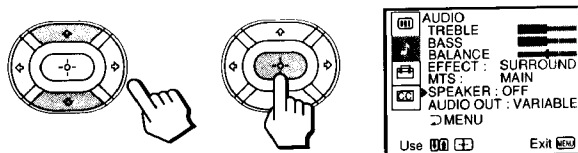

- 5 Press MENU to return to the original screen.

## Setting audio out (AUDIO OUT)

You can change AUDIO OUT to VARIABLE or FIXED when SPEAKER is set to OFF.  
AUDIO OUT is variable when SPEAKER is set to ON.

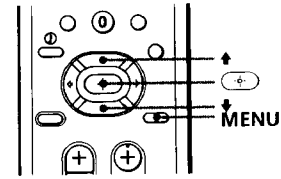

- 1 Press MENU.
- 2 Press ↑ or ↓ to select , and press .
- 3 Press ↑ or ↓ to select AUDIO OUT, and press .

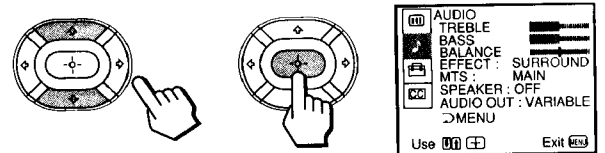

- 4 Press ↑ or ↓ to select VARIABLE or FIXED, and press .

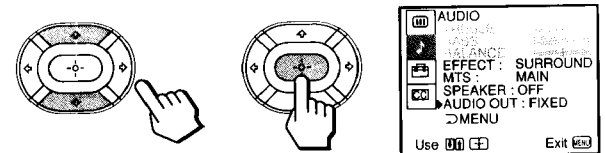

**VARIABLE:** Sound output varied according to the TV settings. You can adjust the volume, bass, treble, and balance.

**FIXED:** Sound output is always fixed to a certain level. The volume, bass, treble, and balance are also fixed to the factory settings.

- 5 Press MENU to return to the original screen.

### Note

- If AUDIO OUT appears in gray, set SPEAKER to OFF.

# Setting daylight saving time (DAYLIGHT SAVING)

■ KV-27V25I/27V35I/29V35CI/29V65MI/29V75MI/32V25I/32V35I/34V35CI/35V35I/35V45I/35V75 only

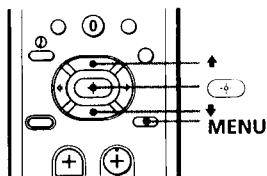

- 1 Press MENU.
- 2 Press ↑ or ↓ to select ☉, and press ⏏.
- 3 Press ↑ or ↓ to select DAYLIGHT SAVING, and press ⏏.

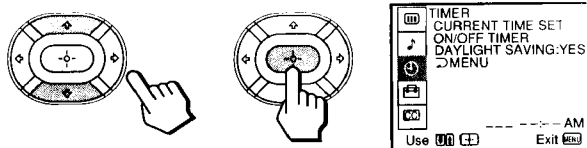

- 4 Press ↑ or ↓ to select YES or NO, and press ⏏.

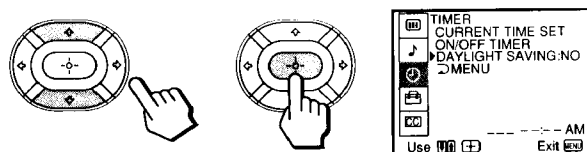

Choose	To
YES	Set for daylight saving start. The current time automatically moves one hour ahead.
NO	Set for daylight saving end.

- 5 Press MENU to return to the original screen.

# Setting the clock (CURRENT TIME SET)

■ KV-27V25I/27V35I/29V35CI/29V65MI/29V75MI/32V25I/32V35I/34V35CI/35V35I/35V45I/35V75 only

Setting the clock enables you to turn the TV on and off with the timer. Make sure to set daylight saving time first.

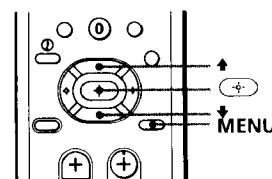

- 1 Press MENU.
- 2 Press ↑ or ↓ to select ☉, and press ⏏.
- 3 Press ↑ or ↓ to select CURRENT TIME SET, and press ⏏.



- 4 Make sure the cursor (▶) is to the left of "--:-- AM," and press ⏏.



- 5 Set the current time.

(1) Press ↑ or ↓ to set the day, and press ⏏.

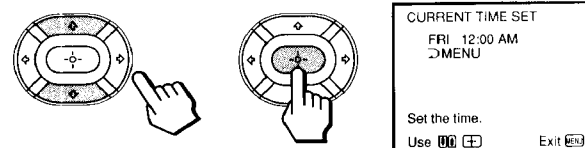

(2) Set the hour and minutes in the same way as in step (1). When you press ⏏ after setting the minutes, the clock starts.

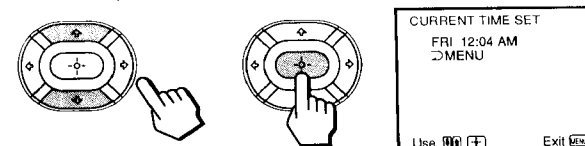

- 6 Press MENU to return to the original screen.

# Setting the timer to turn the TV on and off (ON/OFF TIMER)

■ KV-27V25/27V35/29V35C/29V65M/29V75M/32V25/32V35/34V35C/35V35/35V45/35V75 only

You can set the TV to turn on and off at the times you specify. Make sure the clock is set correctly. If it is not, set the clock first (page 28).

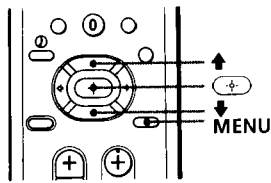

**1 Press MENU.**

**2 Press ↑ or ↓ to select ☉, and press ⏻.**

**3 Press ↑ or ↓ to select ON/OFF TIMER, and press ⏻.**

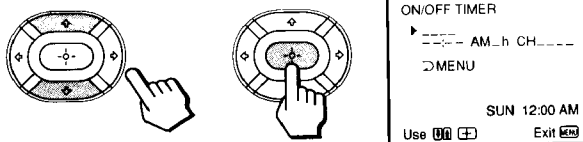

**4 Press ⏻ and enter the ON/OFF TIMER setting.**

(1) Press ↑ or ↓ to set the day(s), and press ⏻.

Each time you press ↑ or ↓, the days cycle as follows:

EVERY SUN-SAT → EVERY MON-FRI → SUNDAY → ... → SATURDAY → EVERY SUNDAY → ... → EVERY SATURDAY

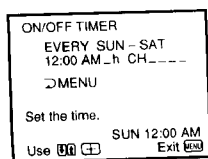
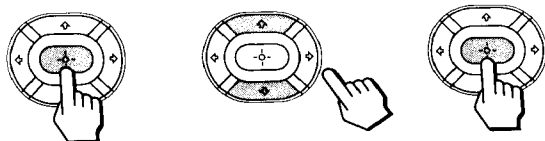

(2) Press ↑ or ↓ to set the time (hour then minutes) that you want to turn on the TV, and press ⏻.

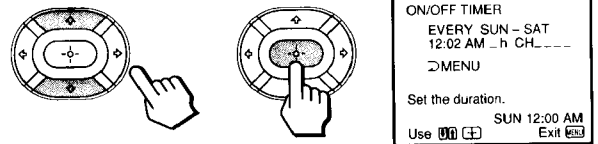

(3) Press ↑ or ↓ to set the time duration, and press ⏻.

Each time you press ↑, the time duration increases by one hour up to a maximum of six hours.

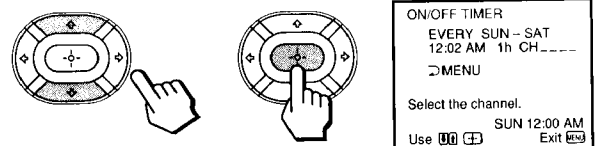

(4) Press ↑ or ↓ to select the channel, and press ⏻.

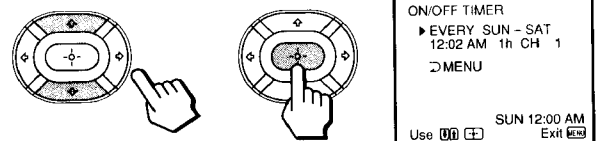

The TIMER indicator on the TV lights up.

**5 Press MENU to return to the original screen.**

One minute before the TV turns off, the message "TV will be off soon." is displayed on the screen.

## To cancel the timer

In step 3 or 4, press RESET.

## Note

- If you unplug the TV or a power interruption occurs, the ON/OFF TIMER setting will be erased. Reset the current time, then set the timer.

# Customizing the channel names (CHANNEL CAPTION)

You can add a caption for up to 12 channels. This feature allows you to easily identify which channel you are watching. You can make your own caption.

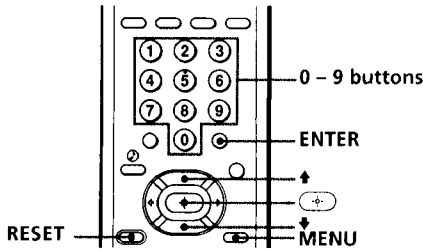

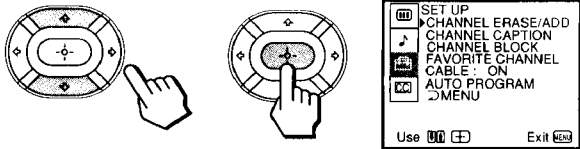

**1 Press MENU.**

**2 Press ↑ or ↓ to select , and press .**

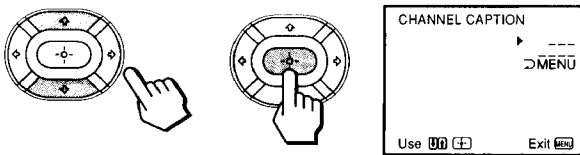

**3 Press ↑ or ↓ to select CHANNEL CAPTION, and press .**



**4 Press  and press ↑ or ↓ to select the channel that you want to caption, and press .**

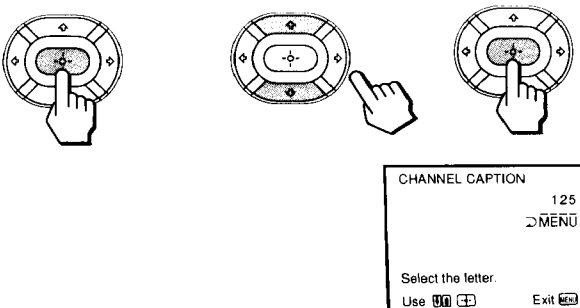



**5 Enter the letters (up to four) to caption the channel:**

(1) Press ↑ or ↓ to select the first letter.

Each time you press ↑ or ↓, the letter changes as follows:

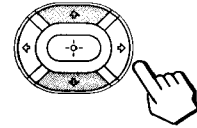
0 → 1 → ... → 9 → A → B → ... → Z → & → / → \_ (blank space)



(2) Press .

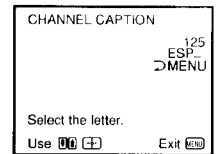
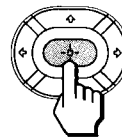

(3) Repeat steps (1) and (2) to select the remaining letters, and press .

**6 To caption other channels, repeat steps 4 and 5.**

**7 Press MENU to return to the original screen.**

After you customize the channel, the channel caption appears green.

### To erase a caption

In step 5, press RESET.



### Notes

- If the CHANNEL CAPTION menu appears in gray, the TV is set to a video input, and you cannot select CHANNEL CAPTION. Press TV (black button) so that a channel number appears.
- If more than 90 seconds elapse after you press a button, the menu disappears automatically.
- The channel caption feature is not available for the AUX input.

## Blocking out a channel (CHANNEL BLOCK)

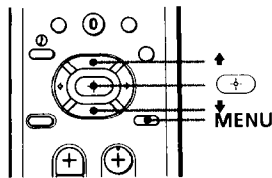
The channel block feature allows you to prevent children from watching unsuitable programs. You can block out two channels.



- 1 Press **MENU**.
- 2 Press **↑** or **↓** to select , and press .
- 3 Press **↑** or **↓** to select **CHANNEL BLOCK**, and press .

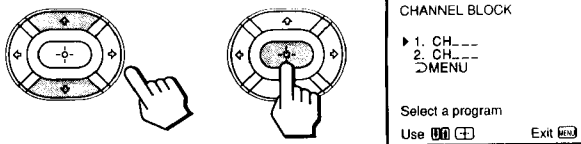

- 4 Press **↑** or **↓** to select **1** or **2**, and press .

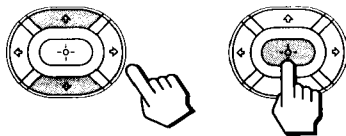

- 5 Press **↑** or **↓** to select the channel which you want to block out, and press .

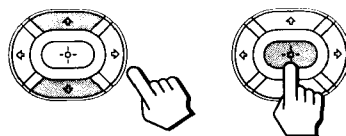

- 6 Press **MENU** to return to the original screen.

When you select the blocked channel "BLOCKED" appears on the screen.

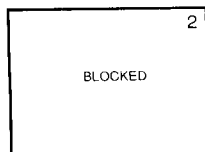

### To cancel a CHANNEL BLOCK setting

In step 4 or 5, press **RESET**.

#### Note



- Once you use CHANNEL BLOCK, Caption Vision and XDS of the blocked channel and the selected channel output from TV OUT/MONITOR OUT are also blocked out.

## Setting your favorite channels (FAVORITE CHANNEL)

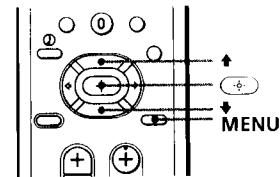

The favorite channel feature allows your TV to memorize your favorite channels easily. If you set to **AUTO**, the last five channels you selected with the 0 – 9 buttons are automatically set as your favorite channels. If you want to input your own selection of channels, set to **MANUAL**.

### Setting your favorite channels

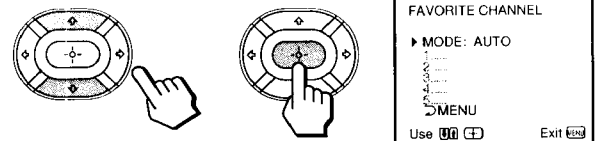

- 1 Press **MENU**.
- 2 Press **↑** or **↓** to select , and press .
- 3 Press **↑** or **↓** to select **FAVORITE CHANNEL**, and press .



- 4 Press  and press **↑** or **↓** to select **AUTO** or **MANUAL**, and press .

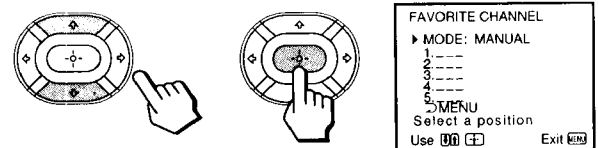

If you select **AUTO**, skip steps 5 and 6.

The last five channels you selected with the 0 – 9 buttons are automatically set as your favorite channels.

If you select **MANUAL**, the favorite channel numbers become white, indicating that favorite channels can be entered.

(continued)

**5** Press **↑** or **↓** to select a favorite channel number, and press **↵**.

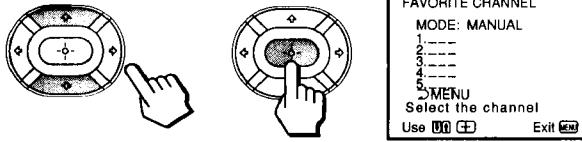

**6** Press **↑** or **↓** to select the channel that you want to set as your favorite channel, and press **↵**.

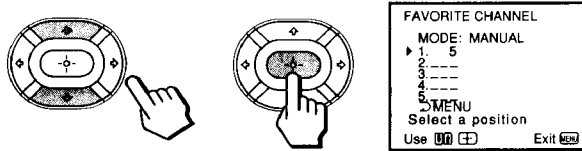

**7** Press **MENU** to return to the original screen.

**Notes**

- If the FAVORITE CHANNEL menu appears in gray, the TV is set to a video input and you cannot select FAVORITE CHANNEL.
- If more than 90 seconds elapse after you press another button, the menu disappears automatically.
- The favorite channel feature is not available for the AUX input.

**Selecting your favorite channel**

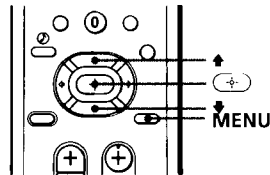

**1** Press **↵**.  
The FAVORITE CHANNEL menu appears.



**2** Press **↑** or **↓** to select the favorite channel you want to watch, and press **↵**.  
The selected channel appears on the screen.

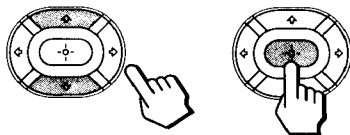

**To cancel the FAVORITE CHANNEL menu**  
Press **↑** or **↓** to select "Exit," and press **↵**.

# Setting video labels (VIDEO LABEL)

■ **KV-27V25/27V35/29V35C/29V65M/29V75M/32V25/32V35/34V35C/35V35/35V45/35V75 only**

The video label feature allows you to label each input mode so that you can easily identify the connected equipment. For example, you can label VIDEO 1 IN as VHS.

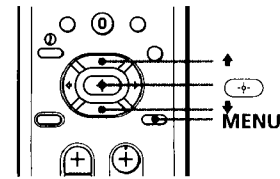

- 1** Press **MENU**.
- 2** Press **↑** or **↓** to select **Ⓜ**, and press **↵**.
- 3** Press **↑** or **↓** to select **VIDEO LABEL**, and press **↵**.

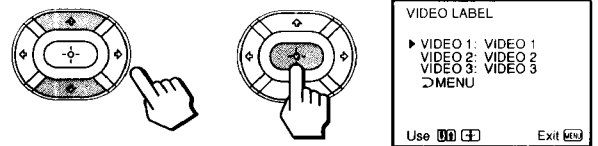

**4** Press **↑** or **↓** to select the input mode you want to label, and press **↵**.

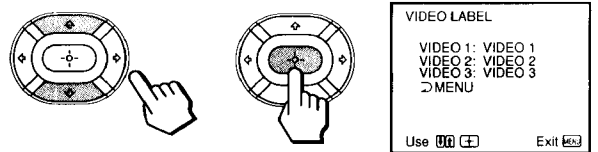



## 5 Press $\uparrow$ or $\downarrow$ to select the label, and press $\odot$ .

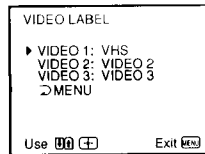
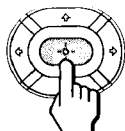
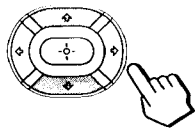

Each time you press  $\uparrow$  or  $\downarrow$ , the label changes as follows:

### VIDEO 1

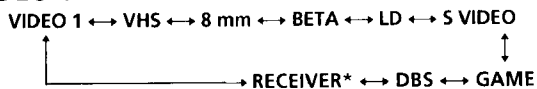

### VIDEO 2



### VIDEO 3

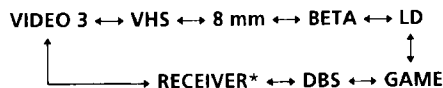

\* KV-27V35/29V35C/29V75M/32V35/34V35C/35V45/35V75 only

\*\* KV-32V35/34V35C/35V45/35V75 only

When you connect an AV receiver to the TV using the AV receiver's TV input jacks, it is recommended to set the label to RECEIVER. When RECEIVER is selected, TV channels can be selected while the video input mode is fixed. (See page 11 for the connection.)

## 6 Repeat steps 4 and 5 to label other input modes.

### Note

- If more than 90 seconds elapse before you press another button, the menu disappears automatically.

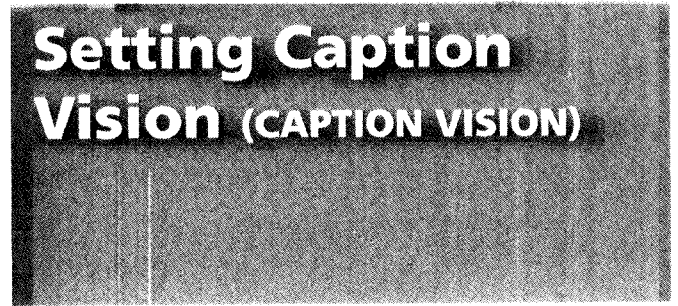

Some programs are broadcast with Caption Vision. To display Caption Vision, select either CC1, CC2, CC3, CC4, TEXT1, TEXT2, TEXT3, or TEXT4 from the menu. CC1, CC2, CC3, or CC4 shows you a caption, that is a printed version of the dialogue or sound effects of a program. (The mode should be set to CC1 for most programs.) TEXT1, TEXT2, TEXT3, or TEXT4 shows you text, that is information presented using either half or the whole screen. It is not usually related to the program.

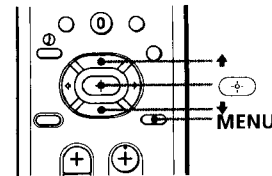

### 1 Press MENU.

### 2 Press $\uparrow$ or $\downarrow$ to select $\text{CC}$ , and press $\odot$ .

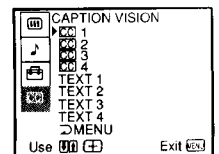
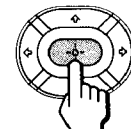
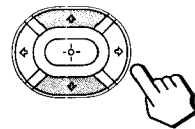

### 3 Press $\uparrow$ or $\downarrow$ to select the caption type, and press $\odot$ .

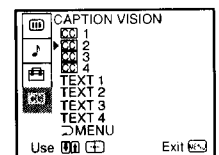
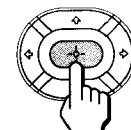
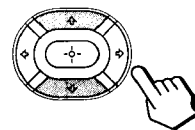

### 4 Press MENU to return to the original screen.

### To display Caption Vision

Press DISPLAY. (See page 20 for details.)

### Notes

- Poor reception of TV programs can cause errors in Caption Vision and XDS. Captions may appear with a white box or other errors instead of a certain word.
- XDS, Caption Vision, and the status display cannot be used at the same time.
- For details on XDS, see page 20.

# Operating video equipment

You can use the supplied remote commander to operate Sony or non-Sony video equipment that has an infrared remote sensor. For this operation, set the manufacturer's code number.

## Setting the manufacturer's code

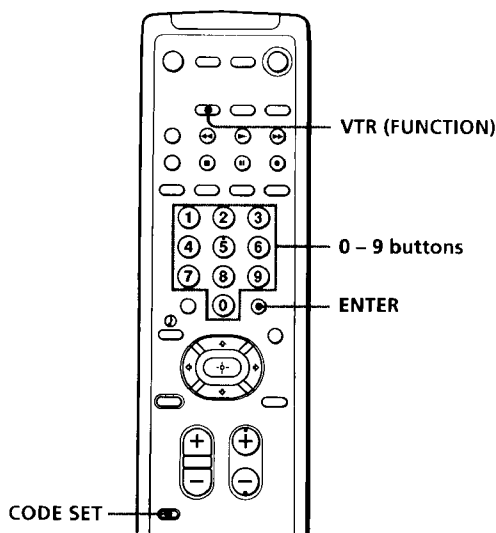

**Press the CODE SET, VTR (FUNCTION), and 0 - 9 buttons to enter the manufacturer's code number (see the chart), then press ENTER. For example, to operate a Sony 8 mm VCR, press CODE SET, VTR (FUNCTION), 3, 0, 2, and ENTER.**

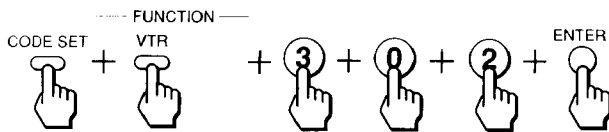

## VCR manufacturer code numbers

Manufacturer	Code number
Sony	301, 302, 303
Aiwa	338
Audio Dynamic	314, 337
Bell & Howell (M. Wards)	330, 343
Brocsonic	319
Canon	309, 308
Citizen	332
Craig	315, 302, 332
Curtis Mathis	304, 338, 309
Daewoo	341, 312, 309
DBX	314, 336, 337
Dimensia	304
Emerson	319, 320, 316, 317, 318
Fisher	330, 334, 335, 333
Funai	338
General Electric	329, 304, 309
Goldstar	332
Hitachi	306, 304, 305
Instant Replay	309, 308
JC Penny	309, 305, 304, 330, 314, 336, 337
JVC	314, 336, 337
Kenwood	314, 336, 332, 337
LXI (Sears)	332, 305, 333, 334, 330, 335
Magnavox	308, 309
Marantz	314, 336, 337
Marta	332
Memorex	309, 335
Minolta	305, 304
Mitsubishi/MGA	323, 324, 325, 326
Multitech	325, 338, 321
NEC	314, 336, 337
Olympic	309, 308
Panasonic	308, 309, 306, 307
Pentax	305, 304
Philco	308, 309
Philips	308, 309
Pioneer	308
Quasar	308, 309
RCA/PROSCAN	304, 305, 308, 309, 311, 312, 313
Realistic	309, 330, 328, 335, 324, 338
Sansui	314
Singer	315
Samsung	322, 313, 321
Sanyo	330, 335
Scott	312, 313, 321, 335, 323, 324, 325, 326
Sharp	327, 328
Shintom	315
Signature 2000 (M. Wards)	338, 327
Sylvania	308, 309, 338
Symphonic	338
Tashiro	332
Tatung	314, 336, 337
Teac	314, 336, 338, 337
Technics	309, 308
Toshiba	312, 311
Wards	327, 328, 335, 331, 332
Yamaha	330, 314, 336, 337
Zenith	331

## Notes

- If more than one code number is listed, try entering them one by one, until you come to the correct code for your equipment.
- In some rare cases, you may not be able to operate your non-Sony video equipment with the supplied remote commander. This is because your equipment may use a code that is not included with this remote commander. In this case, please use the equipment's own remote control unit.
- The code numbers for Sony equipment are assigned at the factory as follows:
 

VHS VCR	301 (preset code for the supplied remote commander)
8 mm VCR	302
Beta, ED Beta VCRs	303
- Whenever you remove the batteries — to replace them, for example — if too much time is taken, the code number may revert to the factory setting and must be reset.

## Operating video equipment

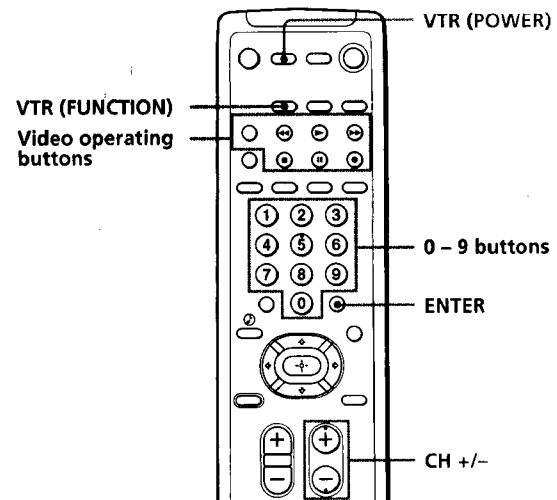

**Use the video operating buttons on the remote commander to operate the video equipment. Press VTR (FUNCTION) before operating the video equipment.**

Operating a VCR	Buttons on the remote commander
To turn on or off	Press VTR (POWER).
To select a channel directly	Press the 0 - 9 buttons.
To change channels	Press CH +/-.
To record	Press ► while pressing ●. First release ►, then release ●.
To play	Press ►.
To stop	Press ■.
To fast forward	Press ►►.
To rewind the tape	Press ◄◄.
To pause	Press   . To resume normal playback, press again.
To search the picture forward or backward	Press ►► or ◄◄ during playback. To resume normal playback, release the button.
To change input mode	Press TV/VTR.

### Note

- If the video equipment does not have a certain function, the corresponding button on this remote commander will not operate.

## Turning off the system

■ **KV-27V25/27V35/29V35C/29V65M/29V75M/32V25/32V35/34V35C/35V35/35V45/35V75 only**

You can turn off the TV and Sony equipment with the S-Link function, such as a VCR, together when you make the S-Link connection (see page 10 for the connection).

**Press SYSTEM OFF.**

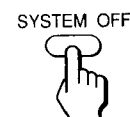

# Operating a cable box or DBS receiver

You can program the supplied remote commander to operate a cable box or DBS receiver. Follow the procedures below to set the manufacturer's code number in the remote commander.

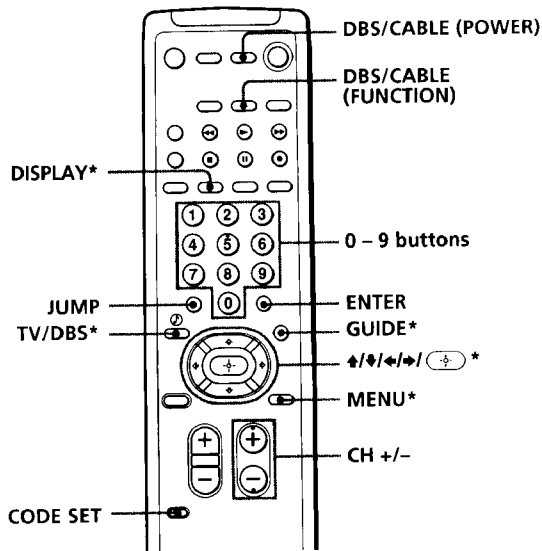

\* The TV/DBS, GUIDE, DISPLAY,  $\leftarrow/\rightarrow/\leftarrow/\rightarrow/\leftarrow/\rightarrow/\leftarrow/\rightarrow$ , and MENU buttons can be used only with a DBS receiver.

## 1 Turn off the equipment you want to set up, and press DBS/CABLE (FUNCTION).

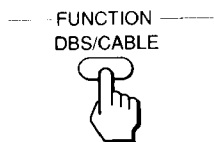

## 2 Press the CODE SET, DBS/CABLE (FUNCTION), and 0 - 9 buttons to enter the manufacturer's code number (see the chart), then press ENTER. For example, to program your remote commander to operate a Sony DBS receiver, press CODE SET, DBS/CABLE (FUNCTION), 8, 0, 1, and ENTER.

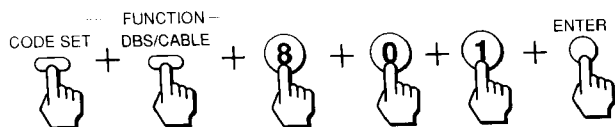

## 3 Press DBS/CABLE (POWER) to turn on the cable box or DBS receiver.

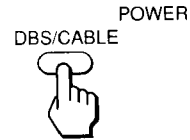

## 4 Use the cable box/DBS control buttons to check if the code number works.

For example, to operate a cable box or DBS receiver, you can use the DBS/CABLE (POWER), JUMP, CH +/-, 0 - 9 and ENTER buttons.

### Note

- If the cable box or DBS receiver does not have a certain function, the corresponding button on this remote commander will not operate.

### To operate the TV

Press TV (FUNCTION). Then use the TV control buttons to control the TV.

### For more details on operating the cable box or DBS receiver

Refer to the operating instructions that come with the equipment.

### If the remote commander doesn't work

- First, try repeating the setup procedures using the other codes listed for your equipment.

### Manufacturer code numbers (cable box)

Manufacturer	Code number
Hamlin/Regal	222, 223, 224, 225, 226
Jerrold/G. I.	201, 202, 203, 204, 205, 206, 207, 208, 218
Oak	227, 228, 229
Panasonic	219, 220, 221
Pioneer	214, 215
Scientific Atlanta	210, 211
Tocom	216, 217
Zenith	212, 213

### Manufacturer code numbers (DBS receiver)

Manufacturer	Code number
Sony	801 (preset code for the supplied remote commander)

### Notes

- If more than one code number is listed, try entering them one by one until you come to the correct code for your equipment.
- If you enter a new code number, the code number you previously entered at that setting is erased.
- In some rare cases, your equipment may use a code that is not provided with this remote commander and you may not be able to operate your equipment with the supplied remote commander. In this case, use the equipment's own remote control unit.
- Whenever you remove the batteries — to replace them, for example — if too much time is taken, the code numbers may revert to the factory setting and must be reset.

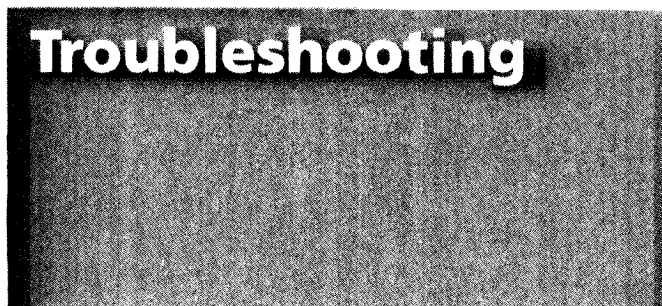

If the problem persists after trying the methods below, contact your nearest Sony dealer.

**No picture (screen not lit), no sound**

- ➔ Make sure the power cord is connected securely.
- ➔ Operate with the buttons on the TV.
- ➔ Insert the batteries in the remote commander with the correct polarity.
- ➔ Replace the batteries with new ones if they are weak.
- ➔ Check to see if the TV/VIDEO setting is correct: when watching TV, set to TV, and when watching video tapes, set to VIDEO1, 2 or 3.
- ➔ Try another channel. It could be station trouble.
- ➔ Perform AUTO SET UP again using the SET UP button to return to the factory preset condition. (page 15)

**Poor or no picture (screen lit), good sound**

- ➔ Adjust PICTURE in the VIDEO menu. (page 22)
- ➔ Adjust BRIGHTNESS in the VIDEO menu. (page 22)
- ➔ Check antenna/cable connections.
- ➔ Perform AUTO SET UP again using the SET UP button to return to the factory preset condition. (page 15)
- ➔ Remove objects from the front of TV.
- ➔ Check the LIGHTSENSOR setting in the VIDEO menu. (page 24)

**Good picture, no sound**

- ➔ Press MUTING so that "MUTING" disappears from the screen. (page 19)
- ➔ Check the MTS setting in the AUDIO menu. (page 26)
- ➔ Make sure SPEAKER is set to ON in the AUDIO menu. (page 27)
- ➔ Perform AUTO SET UP again using the SET UP button to return to the factory preset condition. (page 15)

**No color**

- ➔ Adjust the COLOR in the VIDEO menu. (page 22)
- ➔ Black and white programs cannot be seen in color.
- ➔ Perform AUTO SET UP again using the SET UP button to return to the factory preset condition. (page 15)

**Only snow and noise appear on the screen**

- ➔ Check the CABLE setting in the SET UP menu. (page 17)
- ➔ Check the antenna/cable connections.
- ➔ Make sure the channel is broadcasting programs.
- ➔ Press TV (black button) to change the input mode. (page 20)

**Dotted lines or stripes**

- ➔ Adjust the antenna.
- ➔ Move the TV away from noise sources such as cars, neon signs, and hair-dryers.

**Double images or ghosts**

- ➔ Use a highly directional outdoor antenna or a cable (when the problem is caused by reflections from nearby mountains or tall buildings).

**Cannot operate menu**

- ➔ If the item you want to choose appears in gray, you cannot select it. Press TV/VIDEO correctly.

**Cannot receive upper channels (UHF) when using an antenna**

- ➔ Make sure CABLE is OFF in the SET UP menu. (page 17)
- ➔ Use AUTO PROGRAM to add receivable channels that are not presently in TV memory. (pages 15, 17)

**Cannot receive any channels when using cable TV**

- ➔ Make sure CABLE is ON in the SET UP menu. (page 17)
- ➔ Use AUTO PROGRAM to add receivable channels that are not presently in TV memory. (pages 15, 17)

**Remote commander does not operate**

- ➔ Batteries could be weak. Replace the batteries.
- ➔ Make sure the TV's power cord is connected securely to the wall outlet.
- ➔ Press TV (FUNCTION) when operating your TV.
- ➔ Are fluorescent lights too close to the TV? Move them at least 3-4 feet away from the TV.

**Cannot gain enough volume when using a cable box**

- ➔ Increase the volume at the cable box. Then press TV (FUNCTION) and adjust the TV's volume.

**TV malfunctions when using the S-Link function**

*(KV-27V25/27V35/29V35C/29V65M/29V75M/32V25/32V35/34V35C/35V35/35V45/35V75 only)*

- ➔ Make sure the TV's power cord is connected securely to the wall outlet.
- ➔ Check the S-Link connection. (page 10)

**The TV needs to be cleaned**

- ➔ Clean the TV with a soft dry cloth. Never use strong solvents such as thinner or benzene, which might damage the finish of the cabinet.

# Specifications

Model number	KV-27S25	KV-27S35	KV-27V25	KV-27V35	KV-29RS25	KV-29RS25C	KV-29V35C	KV-29V65M	KV-29V75M
<b>Television system</b>	American TV standard								
<b>Channel coverage</b>	VHF: 2-13 / UHF: 14-69 / CATV: 1-125								
<b>Antenna</b>	75-ohm external antenna terminal for VHF/UHF								
<b>Picture tube</b>	Hi Black Trinitron® tube								
<b>Screen size (in.)</b>	27-inch picture measured diagonally								
<b>Power requirements</b>	120 V, 60 Hz	120 V, 60 Hz	120 V, 60 Hz	120 V, 60 Hz	120 V, 60 Hz	220 V, 50/60Hz	220 V, 50/60Hz	120 V, 60 Hz	120 V, 60 Hz
<b>Number of inputs/ outputs</b>									
<b>Video<sup>1)</sup></b>	2	2	3	3	2	2	3	3	3
<b>S video<sup>2)</sup></b>	1	1	1	1	1	1	1	1	1
<b>Audio<sup>3)</sup></b>	2	2	3	3	2	2	3	3	3
<b>Audio out<sup>4)</sup></b>	1	1	1	1	1	1	1	1	1
<b>Monitor out<sup>1)</sup></b>	–	–	1	1	–	–	1	1	1
<b>TV out<sup>1)</sup></b>	–	–	–	1	–	–	1	–	1
<b>S-Link</b>	–	–	•	•	–	–	•	•	•
<b>Speaker output (W)</b>	5W × 2	5W × 2	5W × 2	10W × 2	5W × 2	5W × 2	10W × 2	5W × 2	10W × 2
<b>Power consumption (W)</b> <b>When in use (Max.)</b> <b>In standby</b>	165W 9W	180W 9W	180W 9W	195W 13W	165W 9W	165W 9W	195W 13W	180W 9W	195W 13W
<b>Dimensions (W/H/D)</b> <b>(mm)</b> <b>(in.)</b>	660.4 × 602.5 × 521.2 mm 26 × 23 <sup>3</sup> / <sub>4</sub> × 20 <sup>5</sup> / <sub>8</sub> in.	660.4 × 602.5 × 521.2 mm 26 × 23 <sup>3</sup> / <sub>4</sub> × 20 <sup>5</sup> / <sub>8</sub> in.	690 × 575.4 × 503.4 mm 27 <sup>1</sup> / <sub>4</sub> × 22 <sup>3</sup> / <sub>4</sub> × 19 <sup>7</sup> / <sub>8</sub> in.	690 × 575.4 × 503.4 mm 27 <sup>1</sup> / <sub>4</sub> × 22 <sup>3</sup> / <sub>4</sub> × 19 <sup>7</sup> / <sub>8</sub> in.	660.4 × 602.5 × 521.2 mm 26 × 23 <sup>3</sup> / <sub>4</sub> × 20 <sup>5</sup> / <sub>8</sub> in.	660.4 × 602.5 × 521.2 mm 26 × 23 <sup>3</sup> / <sub>4</sub> × 20 <sup>5</sup> / <sub>8</sub> in.	690 × 575.4 × 503.4 mm 27 <sup>1</sup> / <sub>4</sub> × 22 <sup>3</sup> / <sub>4</sub> × 19 <sup>7</sup> / <sub>8</sub> in.	690 × 575.4 × 503.4 mm 27 <sup>1</sup> / <sub>4</sub> × 22 <sup>3</sup> / <sub>4</sub> × 19 <sup>7</sup> / <sub>8</sub> in.	690 × 575.4 × 503.4 mm 27 <sup>1</sup> / <sub>4</sub> × 22 <sup>3</sup> / <sub>4</sub> × 19 <sup>7</sup> / <sub>8</sub> in.
<b>Mass (kg)</b> <b>(lbs)</b>	40.6 kg 89 lbs 8 oz	42 kg 92 lbs 10 oz	43 kg 94 lbs 13 oz	43 kg 94 lbs 13 oz	40.6 kg 89 lbs 8 oz	40.6 kg 89 lbs 8 oz	43 kg 94 lbs 13 oz	43 kg 94 lbs 13 oz	43 kg 94 lbs 13 oz

<sup>1)</sup> 1 Vp-p, 75 ohms unbalanced, sync negative

<sup>2)</sup> Y: 1 Vp-p, 75 ohms unbalanced, sync negative  
C: 0.286 Vp-p (Burst signal), 75 ohms

<sup>3)</sup> 500 mVrms (100% modulation), Impedance: 47 kilohms

<sup>4)</sup> More than 408 mVrms at the maximum volume setting (variable)  
More than 408 mVrms (fix)  
Impedance: 5 kilohms

	Model number	KV-32S25	KV-32S35	KV-32TW25	KV-32V25	KV-32V35	KV-34V35C	KV-35V35	KV-35V45	KV-35V75
<b>Television system</b>	American TV standard									
<b>Channel coverage</b>	VHF: 2-13 / UHF: 14-69 / CATV: 1-125									
<b>Antenna</b>	75-ohm external antenna terminal for VHF/UHF									
<b>Picture tube</b>	Hi Black Trinitron® tube									
<b>Screen size (in.)</b>	32-inch picture measured diagonally						35-inch picture measured diagonally			
<b>Power requirements</b>	120 V, 60 Hz	120 V, 60 Hz	120 V, 60 Hz	120 V, 60 Hz	120 V, 60 Hz	220 V, 50/60 Hz	120 V, 60 Hz	120 V, 60 Hz	120 V, 60 Hz	
<b>Number of inputs/ outputs</b>										
<b>Video<sup>1)</sup></b>	2	2	2	3	3	3	3	3	3	3
<b>S video<sup>2)</sup></b>	1	1	1	1	2	2	1	2	2	2
<b>Audio<sup>3)</sup></b>	2	2	2	3	3	3	3	3	3	3
<b>Audio out<sup>4)</sup></b>	1	1	1	1	1	1	1	1	1	1
<b>Monitor out<sup>1)</sup></b>	-	-	-	1	1	1	1	1	1	1
<b>TV out<sup>1)</sup></b>	-	-	-	-	1	1	-	1	1	1
<b>S-Link</b>	-	-	-	•	•	•	•	•	•	•
<b>Speaker output (W)</b>	5W × 2	5W × 2	5W × 2	5W × 2	10W × 2	10W × 2	5W × 2	10W × 2	10W × 2	10W × 2
<b>Power consumption (W)</b>										
<b>When in use (Max.)</b>	185W	190W	185W	190W	210W, 2.75 A	210W	215W, 2.80 A	225W, 2.90 A	225W	225W
<b>In standby</b>	9W	9W	9W	9W	13W	13W	13W	13W	13W	13W
<b>Dimensions (W/H/D)</b>										
<b>(mm)</b>	781 × 712.1 × 582.5 mm	781 × 712.1 × 582.5 mm	942 × 1133.1 × 661.5 mm	821 × 675.3 × 587 mm	821 × 675.3 × 587 mm	821 × 675.3 × 587 mm	920 × 730.8 × 641.8 mm	920 × 730.8 × 641.8 mm	920 × 1207 × 713 mm	920 × 1207 × 713 mm
<b>(in.)</b>	30 <sup>3</sup> / <sub>4</sub> × 28 <sup>1</sup> / <sub>8</sub> × 23 in.	30 <sup>3</sup> / <sub>4</sub> × 28 <sup>1</sup> / <sub>8</sub> × 23 in.	37 <sup>7</sup> / <sub>8</sub> × 44 <sup>5</sup> / <sub>8</sub> × 26 <sup>1</sup> / <sub>8</sub> in.	33 <sup>1</sup> / <sub>2</sub> × 27 <sup>5</sup> / <sub>8</sub> × 24 in.	33 <sup>1</sup> / <sub>2</sub> × 27 <sup>5</sup> / <sub>8</sub> × 24 in.	33 <sup>1</sup> / <sub>2</sub> × 27 <sup>5</sup> / <sub>8</sub> × 24 in.	37 <sup>5</sup> / <sub>8</sub> × 29 <sup>7</sup> / <sub>8</sub> × 26 <sup>1</sup> / <sub>4</sub> in.	37 <sup>5</sup> / <sub>8</sub> × 29 <sup>7</sup> / <sub>8</sub> × 26 <sup>1</sup> / <sub>4</sub> in.	37 <sup>5</sup> / <sub>8</sub> × 49 <sup>3</sup> / <sub>8</sub> × 28 <sup>1</sup> / <sub>8</sub> in.	37 <sup>5</sup> / <sub>8</sub> × 49 <sup>3</sup> / <sub>8</sub> × 28 <sup>1</sup> / <sub>8</sub> in.
<b>Mass (kg)</b>	64.3 kg	66 kg	108.9 kg	70 kg	70 kg	70 kg	90 kg	90 kg	130 kg	130 kg
<b>(lbs)</b>	141 lbs 12 oz	145 lbs 9 oz	240 lbs	154 lbs 6 oz	154 lbs 6 oz	154 lbs 6 oz	198 lbs 7 oz	198 lbs 7 oz	279 lbs 6 oz	279 lbs 6 oz

<sup>1)</sup> 1 Vp-p, 75 ohms unbalanced, sync negative

<sup>2)</sup> Y: 1 Vp-p, 75 ohms unbalanced, sync negative  
C: 0.286 Vp-p (Burst signal), 75 ohms

<sup>3)</sup> 500 mVrms (100% modulation), Impedance: 47 kilohms

<sup>4)</sup> More than 408 mVrms at the maximum volume setting (variable)  
More than 408 mVrms (fix)  
Impedance: 5 kilohms

### Supplied accessories

Remote commander RM-Y136 (1) (KV-27S25/27S35/29RS25/  
29RS25C/32S25/32S35/32TW25  
only)

RM-Y137 (1) (KV-27V25/27V35/29V35C/  
29V65M/29V75M/32V25/32V35/  
34V35C/35V35/35V45/35V75  
only)

Size AA (R6) battery (2)

### Optional accessories

Connecting cables VMC-810S/820S, VMC-720M, YC-15V/30V,  
RK-74A

TV Stand SU-27A (KV-27S25/27S35/27V25/27V35/29RS25/  
29RS25C/29V35C/29V65M/29V75M only)

TV Stand SU-32A (KV-32S25/32S35/32V25/32V35/34V35C only)

TV Stand SU-35A (KV-35V35/35V45 only)

U/V mixer EAC-66

Design and specifications are subject to change without notice.

### ●<sup>®</sup> SRS (SOUND RETRIEVAL SYSTEM)

The ● SRS (SOUND RETRIEVAL SYSTEM) is manufactured by Sony Corporation under license from SRS Labs, Inc. It is covered by U.S. Patent No. 4,748,669. Other U.S. and foreign patents pending.

The word 'SRS' and the SRS symbol (●) are registered trademarks of SRS Labs, Inc.

# Index

Adjusting the picture **22**  
Adjusting the sound **24**  
Antenna **5**  
Audio effect **25**  
Audio out **27**  
Auto program **17**  
Auto set up **15**  
AV receiver **11**  
Battery **14**  
Cable box **5**  
Cable TV **17**  
Caption Vision **33**  
Changing the menu language **18**  
Channel block **31**  
Channel caption **30**  
Current time set **28**  
Daylight saving time **28**  
DBS **8, 36**  
DEMO **15**  
Erase/Add **16**  
Favorite channel **31**  
Hookup  
    with a VCR **6**  
    without a VCR **5**  
Language **18**  
LightSensor **24**  
MTS (Multichannel TV Sound) **26**  
On/off timer **29**  
PIP (Picture-in-Picture) **21**  
Presetting channels **15, 17**  
Remote commander **14**  
SAP (Second Audio Program) **26**  
Sleep timer **20**  
S-Link **10, 35**  
Speaker **27**  
SRS **25**  
Surround **25**  
TEXT **33**  
Tilt correction **18**  
Video label **33**  
Video mode **23**

Watching  
    TV **19**  
    video tapes **20**  
XDS **20**

## Names of controls

▲/▼ buttons **16**  
⊕ button **16**  
0 - 9 buttons **16**  
AUDIO OUT jacks **9**  
AUX antenna terminal **5**  
CH (channel) +/- buttons **16, 19**  
CONVERTER antenna terminal **5**  
CODE SET button **34**  
DISPLAY button **20**  
ENTER button **16, 19**  
FUNCTION (DBS/CABLE, TV, VTR) buttons **16**  
GUIDE button **14**  
JUMP button **19**  
MENU button **16**  
MONITOR OUT jacks **10**  
MUTING button **19**  
PIP operating buttons **21**  
POWER (DBS/CABLE, TV, VTR) buttons **15**  
RESET button **23**  
S-LINK jacks **10**  
S VIDEO input jack **6**  
SLEEP button **20**  
STAND BY/STEREO indicator **26**  
SYSTEM OFF button **35**  
TIMER indicator **29**  
TV (black) button **20**  
TV/ DBS ⊕ button **25, 36**  
TV OUT jacks **11**  
TV/ VIDEO button **20**  
VHF/UHF antenna terminal **5**  
VIDEO 1 IN jacks **6**  
VIDEO 2 INPUT jacks **9**  
VIDEO 3 IN jacks **10**  
VOL (volume) +/- buttons **19**