

VR562

# USER'S GUIDE

S-57-06-640

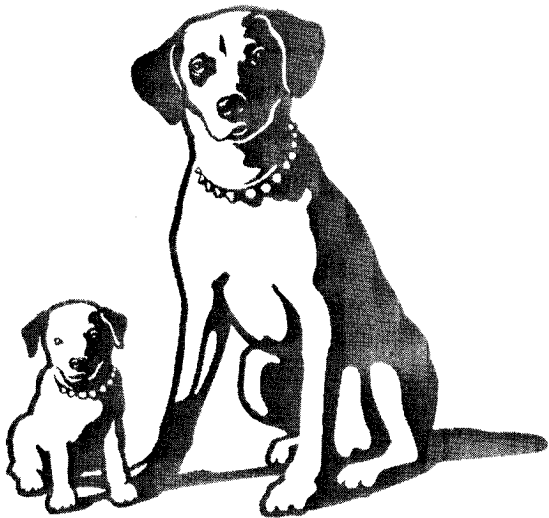

VIDEO CASSETTE

RECORDER

RECORD

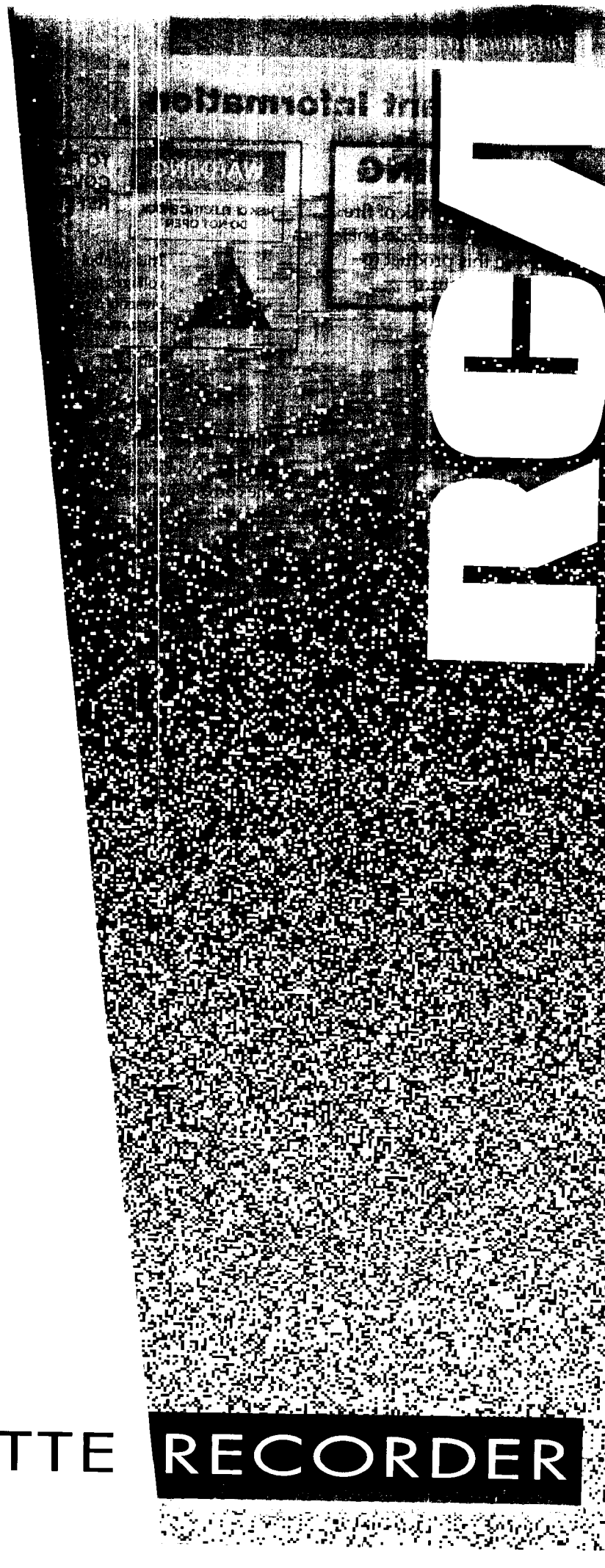

# Important Information

## WARNING

To reduce the risk of fire or shock hazard, do not expose this product to rain or moisture.

## WARNING

RISK OF ELECTRIC SHOCK  
DO NOT OPEN

TO REDUCE THE RISK OF ELECTRIC SHOCK, DO NOT REMOVE COVER (OR BACK). NO USER SERVICEABLE PARTS INSIDE. REFER SERVICING TO QUALIFIED SERVICE PERSONNEL.



This symbol indicates "dangerous voltage" inside the product that presents a risk of electric shock or personal injury.



This symbol indicates important instructions accompanying the product.

## Cautions

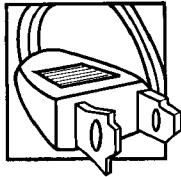

**Caution:** To prevent electric shock, match wide blade of plug to wide slot, fully insert.

**Attention:** Pour éviter les chocs électriques, introduire la lame la plus large de la fiche dans la borne correspondante de la prise et pousser jusqu'au fond.

Refer to the identification/rating label on the back of the product for the proper operating voltage.

FCC Regulations state that unauthorized changes or modifications to this equipment may void the user's authority to operate it.

## Note To Cable TV Installer

This reminder is provided to call your attention to Article 820-40 of the National Electrical Code (Section 54 of the Canadian Electrical Code, Part 1) which provides guidelines for proper grounding and, in particular, specifies that the cable ground shall be connected to the grounding system of the building as close to the point of cable entry as practical.

## Product Registration

Please fill out the product registration card and return it immediately. Returning this card allows us to contact you if needed.

Keep your sales receipt to obtain warranty parts and service and for proof of purchase. Attach it here and record the serial and model numbers in case you need them. The numbers are located on the back of the product.

Model No. **VR562** \_\_\_\_\_

Serial No. \_\_\_\_\_

Purchase Date: \_\_\_\_\_

Dealer/Address/Phone: \_\_\_\_\_

\_\_\_\_\_  
\_\_\_\_\_

# Table of Contents

## Important Information

Warnings	i
Cautions	i
Note to Cable TV Installer	i
Product Registration	i

## Hooking Up the VCR

Choosing a Hookup	2
Antenna or Cable System Without a Cable Box	3
Cable System With Cable Box to Unscramble All Channels	4
Cable System With Cable Box to Unscramble Pay Channels Only	5
Connecting Two VCRs for Copying Tapes	6

## Setting Up the VCR

Startup	
Check Accessories With VCR	7
Insert Batteries in Remote	7
Turn on TV	7
Turn on VCR	8
Set Up Your VCR	8-10
Auto Clock Set	8-9
Set the Automatic	
Daylight-Saving Time	9
Set the Time and Date	9
Auto Channel Search	10
Add or Remove Channels from VCR's Memory	10
Select the Language	10
Use TV•VCR Button	11
Set the Display Panel Brightness	11
Set the ALERT SOUND	11

## Using the Remote Control

Remote Control	12-13
Controlling a TV	14
Controlling a Cable Box or a Satellite Receiver	15

## Playing a Tape

Playback	16
Using the Playback Features	
Auto Play Feature	16
Picture Search	17
Slow Motion	17
Pause for Stop Action	17

DISP (Display) Button	18
Time Counter	18
Index Search	19
Zero Search	19
Blank Search	20
Frame Advance	20
Automatic Tracking	20
Manual Tracking	20

## Recording and Playback Feature

COMMERCIAL▶▶ ADVANCE™ 21-22

## Recording a Program

Recordings	23
Recording Speeds	23
Normal Recording	23
Watch a TV Channel While VCR is Recording a Different Channel	23
Express Recording	24
Recording While You're Away	
VCR Plus+ Setup	25-26
Setting a VCR Plus+ Recording	27
Stopping a VCR Plus+ Recording	27
Setting a Timer Recording	28
Stopping a Timer Recording	28
Checking or Clearing VCR Plus+ or Timer Recordings	29
Timer Recording From the VCR's Line Input	29
Using the Recording Features	
Recording Pause	29
Pro-Tect Plus™ Feature	29
Using Two VCRs for Copying and Editing Tapes	30

## References

Location of Controls	
Front Panel	31
Display Panel	32
Back Panel	33
Trouble Checks	34-35
Questions and Answers About	
Commercial Advance	36
Specifications	37
Cleaning the VCR	37
Limited Warranty	38
Index	39-40

# Choosing a Hookup

The hookups on pages 3 through 5 are divided into two hookup types: Basic (A) and Advanced (B).

The basic hookup shows the backs of TVs that have only an antenna/cable connection. It is the easier of the two and additional accessories may not be needed.

The advanced hookup shows the VCR hooked up to a TV with audio and video jacks. This connection may improve the picture quality as well as convenience of operation.

## Answer the questions to choose the hookup for your VCR.

### 1. How does your TV receive signals?

Choose one answer from below.

- A. Outside antenna – Turn to page 3.
- B. Rabbit ears (set-top) and/or bow tie antenna – Turn to page 3.
- C. Cable System – Go to question 2.

### 2. What type of Cable-TV system\* do you have?

Choose one answer from below.

- A. Cable without a box – Turn to page 3.
- B. Cable box to unscramble all the channels – Turn to page 4.
- C. Cable box to unscramble only pay channels, such as HBO, Showtime, Cinemax, etc. – Turn to page 5.

## Optional Hookups

### How to hook up two VCRs for copying tapes.

- A. Select a hookup by answering questions 1 and 2 above.
- B. Then, modify the connections as shown on page 6.

\*You may need to contact your local cable company for assistance.

# Antenna or Cable System Without a Cable Box

## A. Basic hookup.

Use this hookup for a basic connection which requires fewer accessories.

1. Set the **3CH.4** switch on back of VCR to either channel 3 or 4.  
Tune the TV to this channel and use the **TV•VCR** button to watch the VCR.
2. Connect as shown.  
This connection may require additional accessories not provided.
3. Plug in power cords of VCR and TV.
4. **Go to "Startup" section.**

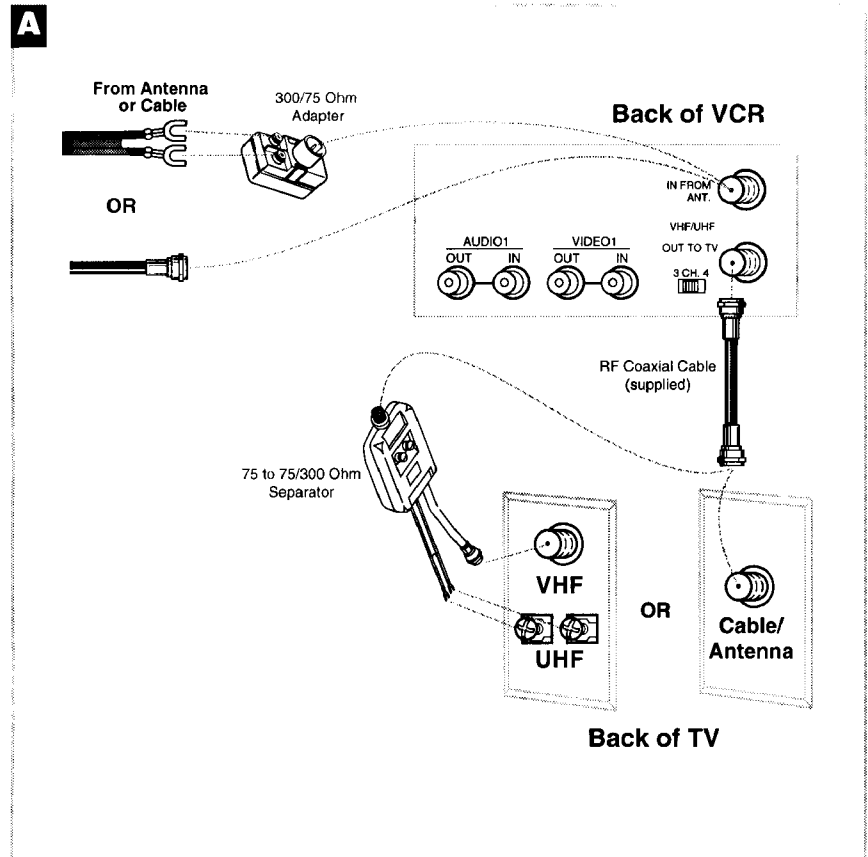

## B. Advanced hookup.

Use this hookup for slightly improved picture quality and more convenient operation — use of the **TV•VCR** button is not required.

1. Connect as shown.  
This connection requires additional accessories not provided. A Y-adapter may be required to hear sound from both channels if your TV is stereo.
2. Plug in power cords of VCR and TV.
3. **Go to "Startup" section.**  
Tune the TV to its video input to watch the VCR.

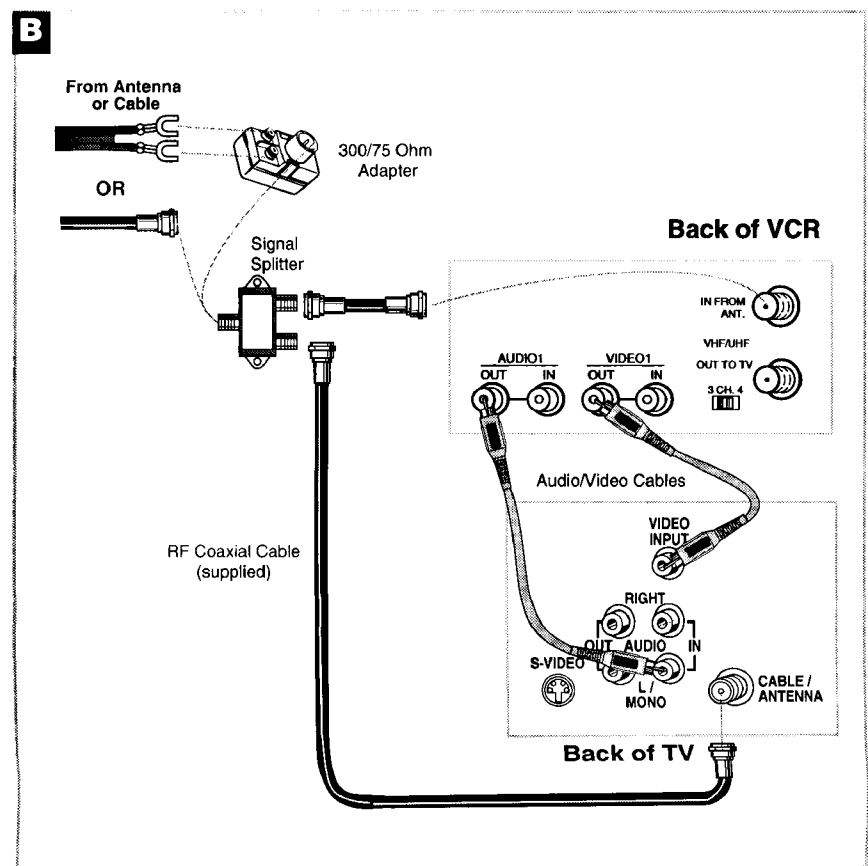

# Cable System With Cable Box to Unscramble All Channels

## A. Basic hookup.

Use this hookup for a basic connection which requires fewer accessories.

1. Set the 3CH.4 switch on back of VCR to either channel 3 or 4.  
Tune the TV to this channel and use the TV•VCR button to watch the VCR.
2. Connect as shown.  
This connection may require additional accessories not provided.
3. Plug in power cords of VCR, TV, and cable box.
4. **Go to "Startup" section.**

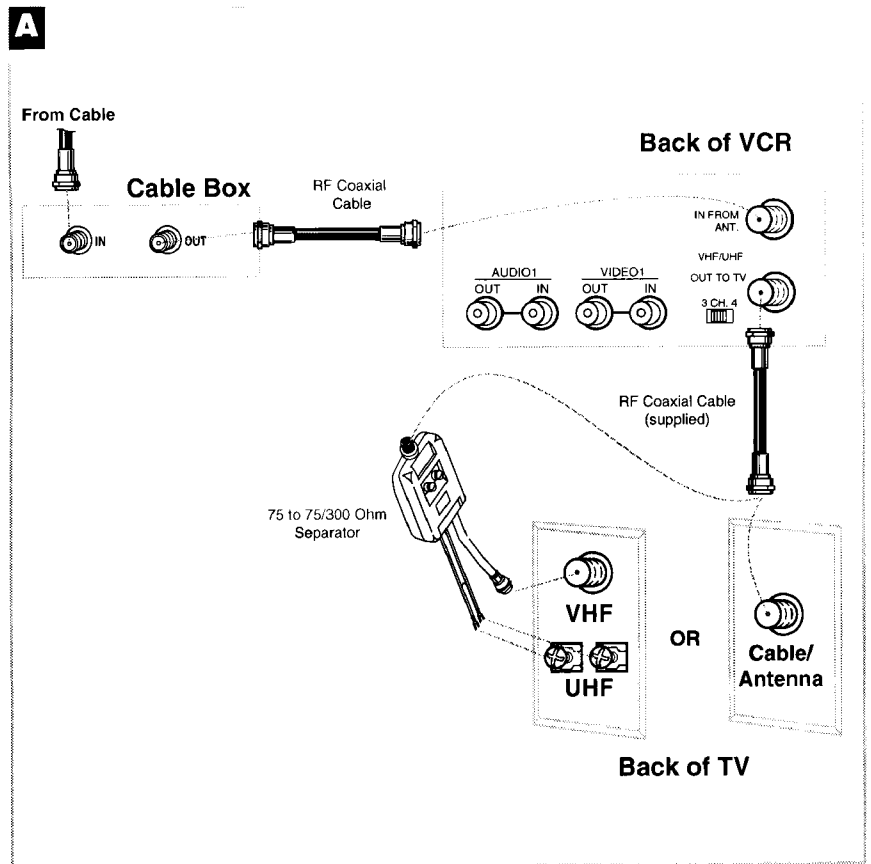

## B. Advanced hookup.

Use this hookup for slightly improved picture quality and more convenient operation — use of the TV•VCR button is not required.

1. Connect as shown.  
This connection requires additional accessories not provided. A Y-adaptor may be required to hear sound from both channels if your TV is stereo.
2. Plug in power cords of VCR, TV, and cable box.
3. **Go to "Startup" section.**  
Tune the TV to its video input to watch the VCR.

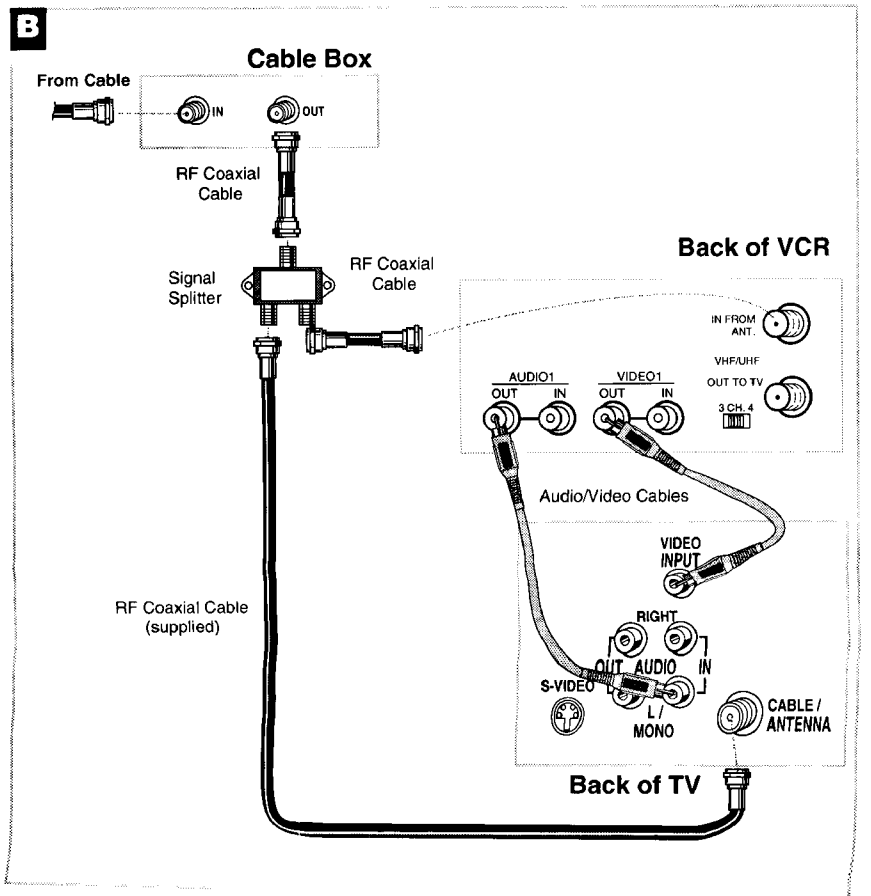

# Cable System With Cable Box to Unscramble Pay Channels Only

(such as HBO, Showtime, Pay-Per-View, etc.)

## A. Basic hookup.

Use this hookup for a basic connection which requires fewer accessories.

1. Set the **3CH.4** switch on back of VCR to either channel 3 or 4.  
Tune the TV to this channel and use the TV•VCR button to watch the VCR.
2. **Connect as shown.**  
This connection may require additional accessories not provided.
3. **Plug in power cords of VCR, TV, and cable box.**
4. **Go to "Startup" section.**

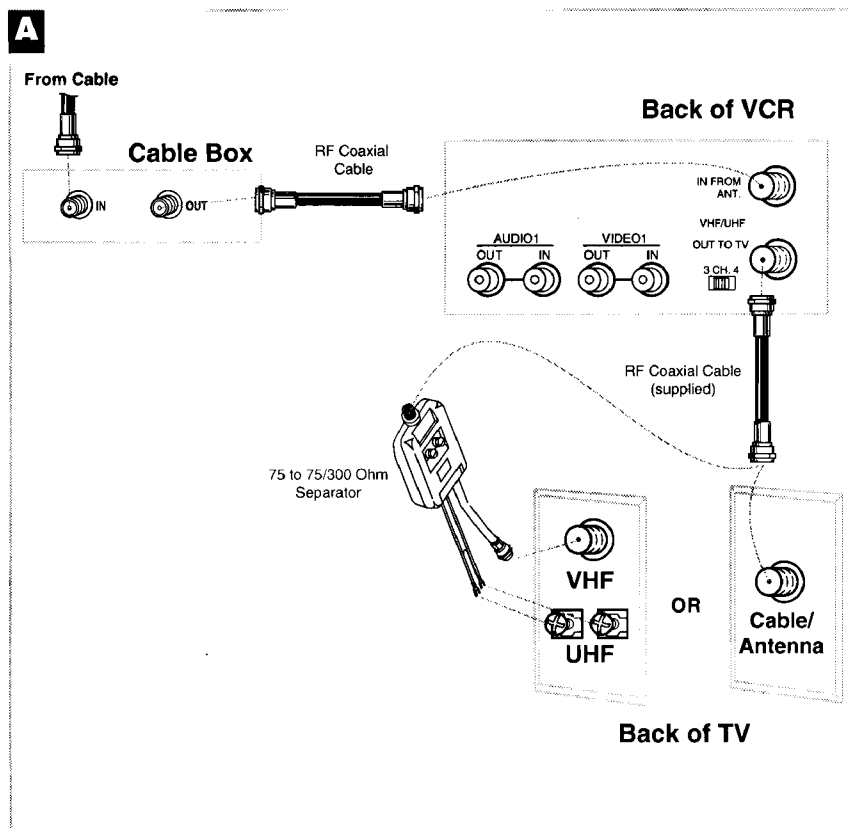

## B. Advanced hookup.

Use this hookup for slightly improved picture quality and more convenient operation — use of the TV•VCR button is not required.

1. **Connect as shown.**  
This connection requires additional accessories not provided. A Y-adapter may be required to hear sound from both channels if your TV is stereo.
2. **Plug in power cords of VCR, TV, and cable box.**
3. **Go to "Startup" section.**  
Tune the TV to its video input to watch the VCR. View all pay channels through the VCR.

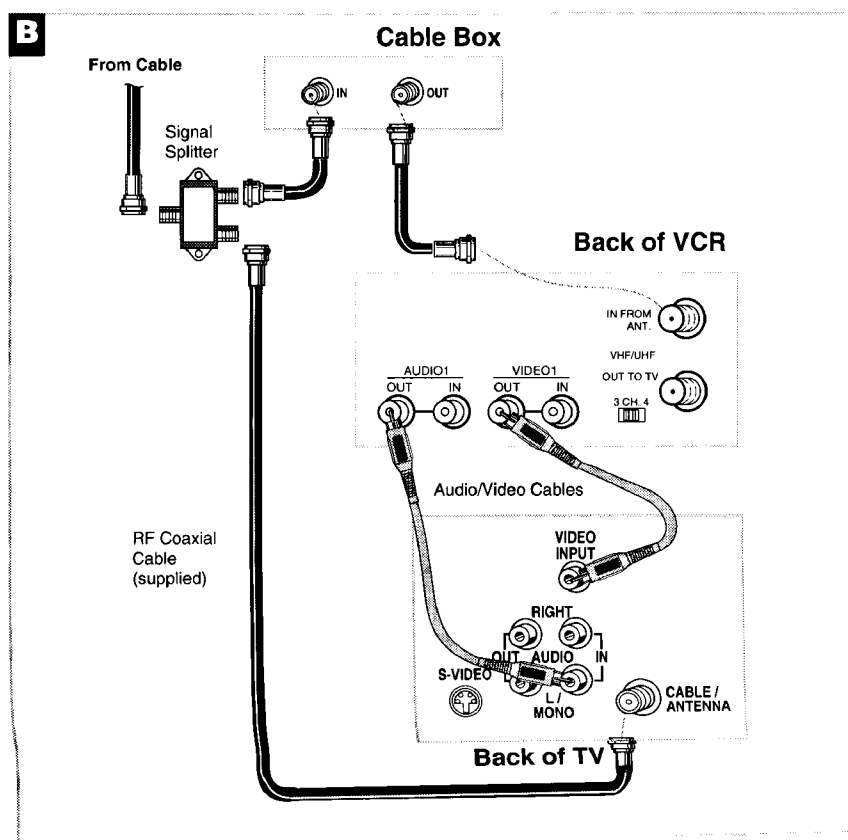

## Connecting Two VCRs for Copying Tapes

### Option A hookup.

Use this hookup for a basic connection which requires fewer accessories.

1. Select a hookup from pages 2 through 5 and then modify with this connection.
2. Set the 3CH.4 switch on the playback VCR to either channel 3 or 4.  
Tune the recording VCR to this channel to receive the signal from the playback VCR.
3. Connect as shown.  
This connection may require additional accessories not provided.
4. Plug in power cords of VCRs and TV.
5. **Go to "Startup" section.**

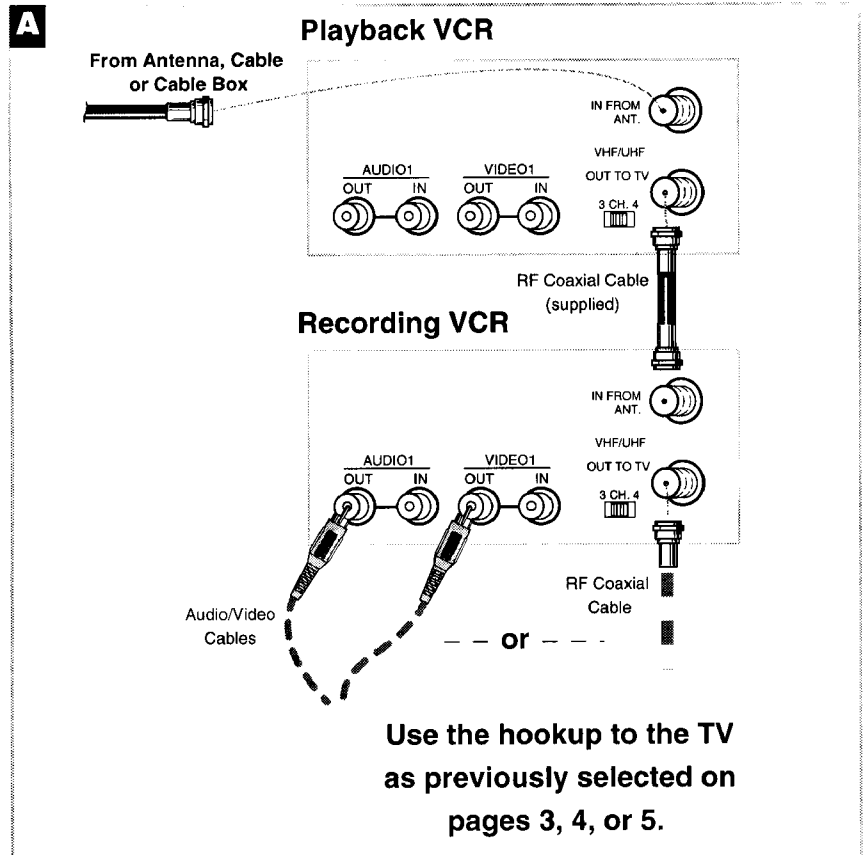

### Option B hookup.

Use this hookup for slightly improved copy quality and more convenient operation — use of the TV•VCR button is not required.

1. Select a hookup from pages 2 through 5 and then modify with this connection.
2. Connect as shown.  
This connection requires additional accessories not provided. A Y-adaptor may be required to hear sound from both channels if your other VCR is stereo.
3. Plug in power cords of VCRs and TV.
4. **Go to "Startup" section.**

Select the line (audio/video) input on the recording VCR to receive the signal from the playback VCR.

Caution: The unauthorized recording of television programs and other materials may infringe the rights of others.

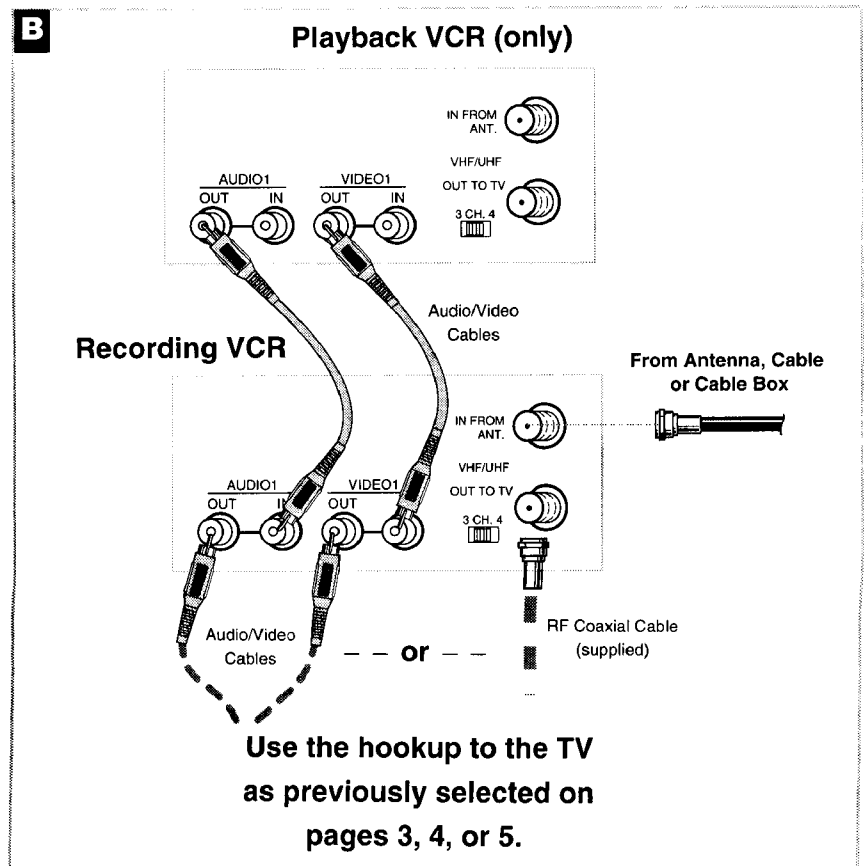



# Startup

## 1. Check accessories with VCR.

Contact your dealer if any items are missing.

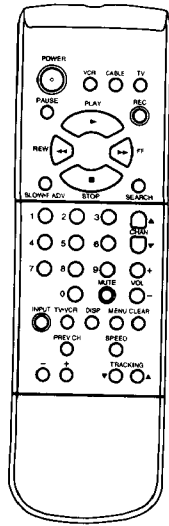

**Remote**  
(Stock No. 221373)

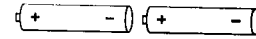

**2 "AA" Batteries**

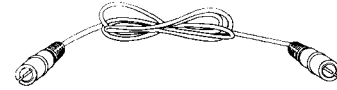

**RF Coaxial Cable**  
(Stock No. 221346)

## 2. Insert batteries in remote.

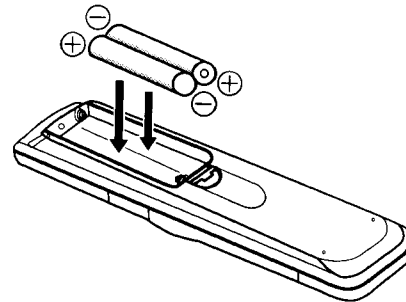
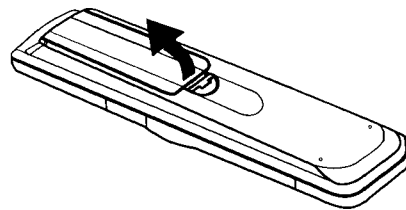

## 3. Turn on the TV.

- A. Turn on the TV.
- B. If you used one of the basic hookups, tune the TV to the channel selected with the 3CH.4 switch on back of VCR.

If you used one of the advanced hookups, tune the TV to the TV's video input.  
(See TV owner's manual for details.)

# Startup

## 4. Turn on the VCR.

A. Press VCR on the remote.

The SET TIME ZONE screen appears the *first time* the VCR is turned on after connecting it. It is a step-by-step procedure to set up the VCR for *Auto Clock Set* using Coordinated Universal Time information transmitted by some broadcast stations and *Auto Channel Search*. If you choose to set up these VCR options individually, go to "Set up your VCR" section.

If the SET TIME ZONE screen does not appear:

- Make sure TV is tuned to same channel as channel 3/4 switch, or TV's video line input.
- Make sure VCR indicator is on in the VCR display panel if you use a basic hookup.
- Check the connections.

B. Follow the step-by-step procedures until setup is complete. If setup is successful, skip the next step.

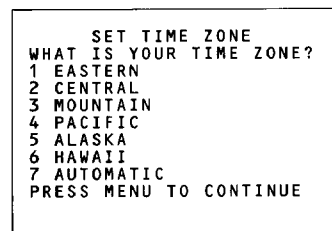

## 5. Set up your VCR.

The initial setup is a one-time procedure only; and should you wish to change or reset an individual feature, follow the instructions in this step.

### Auto Clock Set

The AUTO CLOCK SET feature is set to ON at the factory. With this feature on, the VCR automatically updates the clock using the Coordinated Universal Time information transmitted by some broadcast stations. The TIME ZONE and DAYLIGHT SAVINGS TIME menu items must be set for your area. With this feature off, the clock will not be set or adjusted automatically.

- A. Press MENU on the remote to display the VCR MAIN MENU.
- B. Press 3 to display the TIME menu.
- C. Press 2 to switch AUTO CLOCK SET between ON and OFF.

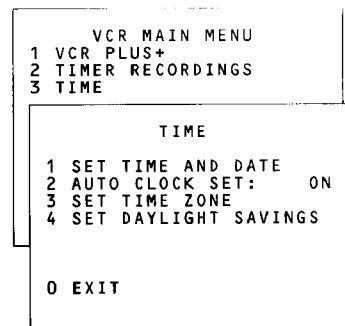

### Set the Time Zone

1. Press MENU on the remote to display the VCR MAIN MENU.
2. Press 3 to display the TIME menu.
3. Press 3 to display the SET THE TIME ZONE menu.
4. Select your time zone.
  - If you select AUTOMATIC for your time zone, the VCR sets the clock using the first Coordinated Universal Time information it finds. If the time is not correct, select another time zone or use the SET TIME AND DATE option.

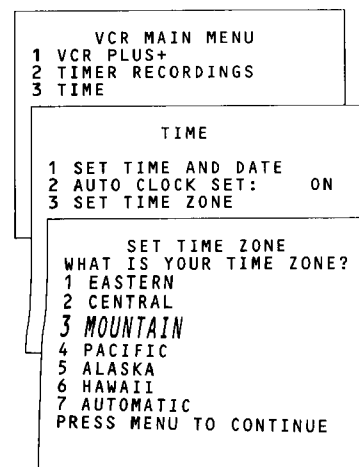

# Startup

## Set Daylight Savings Time

1. Press MENU on the remote to display the VCR MAIN MENU.
2. Press 3 to display the TIME menu.
3. Press 4 to display the SET DAYLIGHT SAVINGS menu.
4. Select one of the options.

- If you select YES, DST IS OBSERVED:

**In the Spring**, daylight-saving time begins on the first Sunday in April. Because the clock automatically changes from 2:00 AM to 3:00 AM (forward one hour), remember that any part of a scheduled Timer Recording that falls between these two times will not be recorded.

**In the autumn**, daylight-saving time ends on the last Sunday in October. The VCR clock automatically changes from 2:00 AM to 1:00 AM (back one hour). Therefore, it can affect your recording length.

- If you select AUTOMATIC, the VCR sets the clock using the first Coordinated Universal Time information it finds.

**Notes:** With a cable box, the VCR will not reset the clock after a power outage unless the cable box is set to the channel carrying the broadcast signal.

If AUTO CLOCK SET is unsuccessful, try tuning the VCR (or cable box) to a channel carrying the XDS information (usually PBS), then turn the VCR off. If the time does not set within 10 minutes, set the time and date manually through the menu items.

Check local cable system or TV stations for availability of channels with Extended Data Service (XDS).

## Set the Clock

If the AUTO CLOCK SET was unsuccessful, set the clock through the menu option. Also, if you choose to set the clock manually, the AUTO CLOCK SET feature is automatically turned off.

- A. Press MENU on the remote to display the VCR MAIN MENU.
- B. Press 3 to display the TIME menu.
- C. Press 1 to display the SET TIME AND DATE.
- D. Use the number buttons on the remote to enter the time including AM or PM, month, day, and year. The day of the week will automatically appear after you enter the year.
  - Press 0 before single-digit numbers. Press 1 for AM or 2 for PM. Example: press 0, then 5, then 0, then 7, then 2 for a time of 5:07 PM.
  - Press CLEAR on the remote at any time to change incorrect entries.
- E. Press MENU to set the clock.
- F. Press 0 to exit the menus.

The time appears in the VCR's display panel. To display the time and date on the screen, press DISP on the remote.

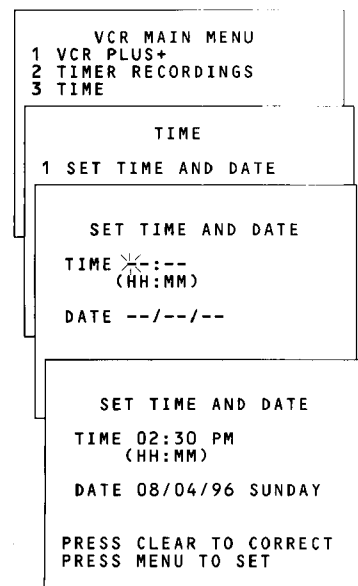
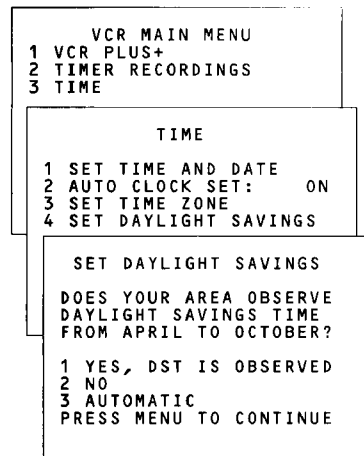

## Startup

### Auto Channel Search

The AUTO CHANNEL SEARCH feature memorizes the channel list available through your signal type—cable or antenna. The signal type is automatically selected when you auto channel search. Also, should you change your signal system, you must perform Auto Channel Search.

Wait until the channel numbers stop changing. This takes about one to two minutes. The TV tunes to the lowest channel found. Pressing CHANNEL up or down selects only the active channels.

- A. Press MENU on the remote to display the VCR MAIN MENU.
- B. Press 4 to display the CHANNELS menu.
- C. Press 1 to begin AUTO CHANNEL SEARCH.

The VCR automatically selects the CABLE (cable TV) or ANTENNA signal. For cable connection, 125 channels are searched; for an antenna connection, 69 channels are searched.

#### To change the SIGNAL TYPE:

- A. Follow steps A-B above.
- B. Press 3 to switch the SIGNAL TYPE between CABLE and ANTENNA.

### 6. Add or remove channels from the VCR's memory.

You may want to add or remove channels if some of the channels are not active, have weak signals, or you do not want to watch them.

We recommend channels be placed in memory using the AUTO CHANNEL SEARCH feature before adding or removing channels.

- A. Press MENU on the remote to display the VCR MAIN MENU.
- B. Press 4 to display CHANNELS menu.
- C. Press 2 to display ADD/REMOVE CHANNEL screen.
- D. Use CHANNEL up and down or the number buttons to go to channels you want to add or delete.
- E. Follow the on-screen directions.

### 7. Select the language.

The VCR displays the on-screen menus in the English, Spanish, or French language. The word "Language" cycles through the different languages when the VCR MAIN MENU is displayed on the TV screen.

- A. Press MENU on remote to display the VCR MAIN MENU.
- B. Press 6 to display the LANGUAGE, IDIOMA or LANGUE menu. *The arrow indicates which language is selected.*
  - Press 1 to have the menus displayed in English (Ingles).
  - Press 2 to have the menus displayed in Spanish (Español).
  - Press 3 to have the menus displayed in French (Français).

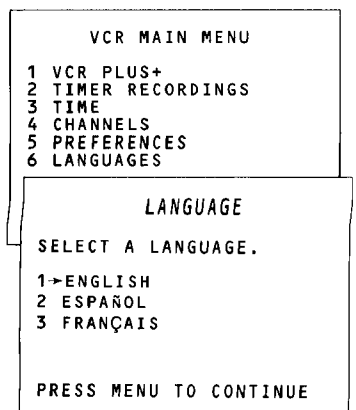
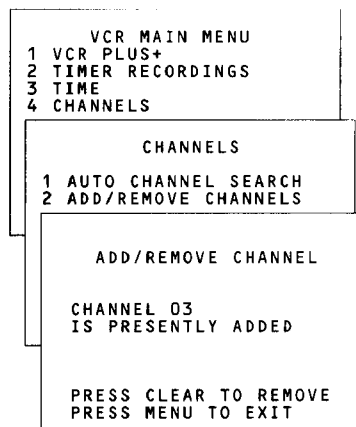
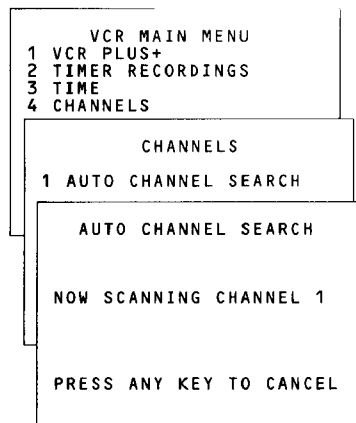

## Startup

### 8. Use TV•VCR button.

Skip this step if you used one of the advanced hookups.

When using one of the basic hookups, the TV•VCR button lets you switch between the picture coming from the VCR or television channels. This button lets you record a program on the VCR while watching another channel on the TV. *Details are in the "Recording" section.*

- A. Press VCR to set the remote to control the VCR.
- B. Press TV•VCR to see the picture from the VCR. The VCR indicator lights in the display panel.
- C. Press CHANNEL up or down to change channels on the VCR.  
The channel number followed by the station name (if broadcast) appears for a few seconds on the TV screen.
- D. Press TV•VCR to see the TV channels.  
The VCR indicator does not light in the display panel. Change channels using the TV's remote.
- E. Return the TV to the VCR viewing channel — CH3 or CH4.
- F. Press VCR, then TV•VCR to switch back to the picture from the VCR.

### 9. Set the display panel brightness.

This VCR lets you change the brightness level of the fluorescent display panel.

- A. Press MENU on remote to see the VCR MAIN MENU.
- B. Press 5 to display the PREFERENCES menu.
- C. Press 3 to select a FRONT PANEL mode.
  - Select AUTO to keep the display panel bright when VCR is on and dim when it is off.
  - Select BRIGHT to keep the display panel bright.
  - Select DIM to keep the display panel dim.

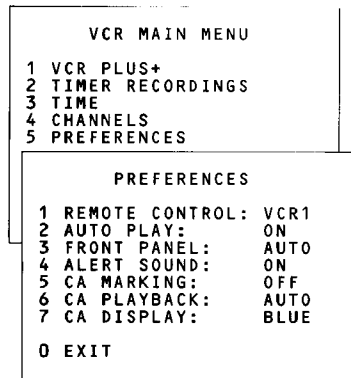

### 10. Set the ALERT SOUND.

Select this feature if you want a warning to sound each time an invalid entry or invalid operation is attempted. This feature is set to OFF at the factory. Please note the warning sound is heard only when the VCR and TV are on.

- A. Press MENU on the remote to display VCR MAIN MENU.
- B. Press 5 to display the PREFERENCES menu.
- C. Press 4 to select ALERT SOUND: ON or OFF.
  - Select ON if you want to sound a short warning.
  - Select OFF if you *do not* want to sound a short warning.

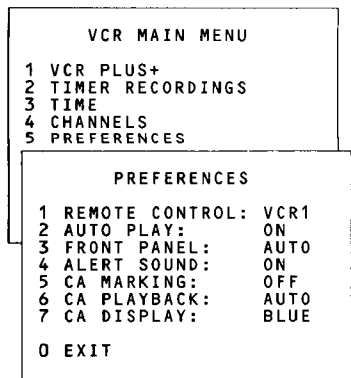

# Remote Control

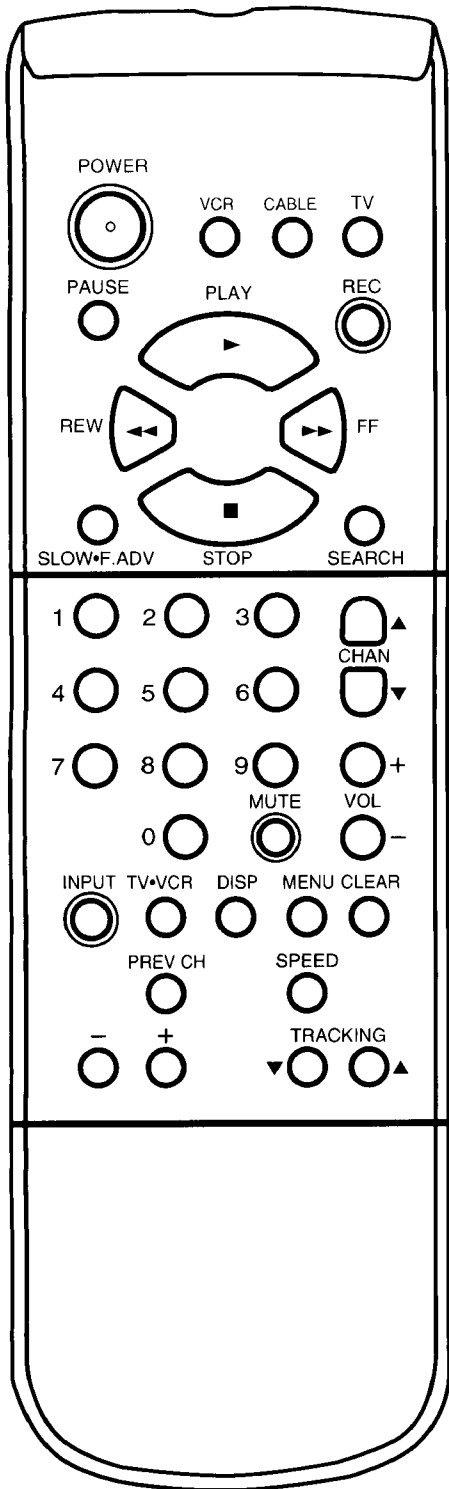

## Component Buttons

Press one of the buttons to set the remote to operate that component.

### CABLE

Used with POWER button to turn on a compatible cable box or satellite receiver as described on page 15.

Used with POWER button to turn on another brand of TV as described on page 14.

### VCR

Sets the remote to control the VCR.

### TV

Turns on a compatible RCA, ProScan, or GE TV and sets the remote to control the TV.

## VCR Function Buttons

Press VCR to set remote to control the VCR to use the function buttons.

### - and + (SLOW)

Used for slow-motion playback. Press + to increase the speed. Press - to decrease the speed.

### MENU

Displays the VCR MAIN MENU on the TV screen.

Removes a menu from the screen.

### CHAN (Channel) Up or Down

Selects the next higher or lower channel in the VCR's channel memory.

### Numbers (0 through 9)

Select a channel up to 99—press two numbers.

Select a cable channel over 99—press and hold 1 until 1-- appears on the screen. Then, press the other two numbers.

### CLEAR

Resets the time counter to 0:00:00.

Lets you change entries when setting the clock or a timer recording.

### PAUSE

Pauses action for viewing during playback.

Pauses recording to prevent recording of unwanted scenes.

### DISP (Display)

Shows VCR operating displays on the TV screen.

Displays the time counter.

### FF (Fast Forward)

Fast forwards the tape when the VCR is stopped.

Quickly searches a tape in forward motion during playback.

### PLAY

Plays a tape.

### POWER

Turns off the VCR when the remote is set to control the VCR.

Turns off other components if remote is programmed.

### INPUT

Turns the line input (L) on or off.

Line input refers to the signal coming from the component connected to the audio/video jacks on the back of the VCR.

### PREV CH (Previous Channel)

Switches between two channels.

Select one channel and then select another. Press PREV CH to switch between the two channels.

## Remote Control

### VCR Function Buttons

(continued)

#### REC (Record)

Starts the VCR recording.

Used for express recording.

#### REW (Rewind)

Rewinds the tape when the VCR is stopped.

Quickly searches a tape in reverse motion during playback.

#### SEARCH

Displays the INDEX and ZERO search menus on the TV screen.

Advances a tape 60 seconds during playback.

#### SLOW•F.ADV (Frame Advance)

Used for slow-motion playback.

Advances a tape one frame with each press of the button when tape is paused during playback.

#### SPEED (Tape Speed)

Selects a recording speed (SP or SLP).

#### STOP

Stops the VCR's normal functions such as record, playback, rewind, fast forward, and pause.

#### TRACKING Up or Down

Reduces the streaks that may appear on the picture during play, slow, or pause.

Reduces picture "jitter" during stop-action playback.

#### TV•VCR

Switches the picture signal so that it either comes from the VCR or the TV channel. See "Startup" section.

### TV Function Buttons

Press the TV button to set remote to control a compatible TV. Some buttons may not work with the TV.

#### CHAN (Channel) Up or Down

Selects next higher or lower channel in the TV's channel memory when remote is set to control a TV.

Used with the TV button to turn on a compatible TV that the remote has been programmed to control. See "Controlling a TV" section.

#### CLEAR

Removes menus or status displays from the screen.

#### MUTE

Turns the TV sound on or off.

#### PREV CH (Previous Channel)

Switches between two channels.

Select one channel and then select another. Press PREV CH to switch between the two channels.

Used as an ENTER button on some TVs.

#### DISP (DISPLAY)

Shows the status displays on the screen.

Removes menus or displays from the screen.

#### Numbers (0 through 9)

Selects a channel up to 99—press two numbers.

Selects a cable channel over 99—press and hold 1 until 1-- appears on the screen. Then, press the other two numbers.

#### VOL (Volume) + or -

Raises and lowers sound.

#### POWER

Turns off a compatible TV when remote is set to control that TV.

### Cable Box or Satellite Receiver Function Buttons

Press the CABLE button to set remote to control a compatible cable box or satellite receiver. Some buttons may not work with the cable box or satellite receiver.

#### CHAN (Channel) Up or Down

Selects next higher or lower channel.

#### POWER

Turns off a compatible cable box or satellite receiver when remote is set to control it.

#### PREV CH (Previous Channel)

Used as an ENTER button for some cable boxes and/or satellite receivers.

#### Numbers (0 through 9)

Selects a channel using the numbers.

## Controlling a TV

The VCR's remote is preprogrammed to control the basic functions of a compatible RCA, ProScan, or GE TV. Also, you can set up the remote to control other manufacturer's brands. To program the remote, enter the remote code numbers that correspond to your brand.

### Program the Remote for a TV

1. Turn on the TV.
2. Point the VCR remote at the TV.
3. Hold the TV button and press two number buttons to enter the code for your brand.
4. Release the buttons.
5. Press CHANNEL up or down. If the TV turns off or changes channels, setup is complete.
6. Repeat steps 2 – 5 with a different code if the first one does not work.

TV Codes					
Brand *	Remote Button	Brand *	Remote Button	Brand *	Remote Button
Akai	03	Kawasho	03,06	RCA	01,06,12
AOC	06,12	Kenwood	06	Realistic	05
Candle	06	Loewe	04	Sampo	06
Citizen	06	Luxman	06	Samsung	06,09,12
Colortyme	06	LXI	04,05,07	Sanyo	05,08
Concerto	06	Magnavox	04,06	Sears	01,05,06,07, 08,10
Curtis Mathes	01,06	Marantz	04,06,12	Sharp	06,13
Daewoo	06,12	MGA	06	Sony	03
Daytron	06	Mitsubishi	06,12	Soundesign	06
Electrohome	06	MTC	06,12	Sylvania	04,06
Emerson	06	NAD	07,08	Technics	11
Envision	05,06	NEC	06,12	Techwood	06
Fisher	05,08	Panasonic	04,11	Teknika	06
GE	00,01,06,11	Philco	04,06,12	TMK	06
Goldstar	06,12	Philips	03,04,06	Toshiba	05,07,08,09
Hallmark	06	Pioneer	06	Universal	00
Hitachi	06,14	Portland	06,12	Victor	10
Infinity	04	ProScan	01	Wards	00,01,04,06,12,13
J C Penny	00,01,06,09,12	Proton	06	Yamaha	12
JBL	04	Quasar	11	Zenith	02
Jensen	06	Radio Shack	01,05,13		
JVC	10,11				

\*The remote may not be able to control every model TV of the brands listed.

### Operate the TV

After you set up your remote to control your TV, test the TV buttons to see which ones operate your TV.

1. Point the remote at the TV and press TV.
2. If the TV does not turn on in step 1, press TV, then POWER.
3. Use the "TV Function Buttons" described in "Remote Control" section.

**Helpful Hint:** Notice the difference between the TV and VCR on-screen displays. This is one way to tell if the remote is set to control the VCR or the TV.



## Controlling a Cable Box or a Satellite Receiver

The CABLE button on the VCR's remote is preprogrammed to control a compatible RCA cable box or RCA, ProScan, or GE satellite receiver. If your cable box is another manufacturer's brand and has its own remote, you will probably be able to program the VCR's remote to control it. To program the VCR's remote, enter the code that corresponds to your brand.

### Program the Remote for a Cable Box or Satellite Receiver

1. Turn on the cable box or satellite receiver.
2. Point the VCR remote at the cable box or satellite receiver.
3. Hold the CABLE button and press two number buttons to enter the code for your brand.
4. Release the buttons.
5. Press POWER on the remote. If the cable box or satellite receiver turns off, setup is complete.
6. Repeat steps 2 – 5 with a different code if the first one does not work.

Cable Box Codes					
Brand*	Code	Brand*	Code	Brand*	Code
ABC	.53,54	Magnavox	.07,08,19,26,	Samsung	.44
Anvision	.07,08		.28,29,32,33,40,41	Sci. Atlanta	.03,22,35,63,64
Cablestar	.07,08	NSC	.09	Stargate 2000	.58
Diamond	.56	Oak	.01,16,38	Sylvania	.11,59
Eagle	.07,08	Oak Sigma	.16	Teknika	.06
Eastern Int.	.02	Panasonic	.03,27,39	Texscan	.10,11,59
General Instruments	.04,05,15,23,	Philips	.07,08,19,,26,28,	Tocom	.17,21,49,50,55
	.24,25,30,36		.29,32,33,40,41	Unika	.31,32,41
Hamlin	.12,13,34,48	Pioneer	.18,20,44	Universal	.51,52,
Hitachi	.37,43	RCA	.27,60	Viewstar	.07,08,19,26,28
Jerrold	.04,05,15,23,24,	Randtek	.07,08		.29,32,33,40,41
	.25,30,36, 45,46,47	Regal	.12,13	Warner Amex	.44
Macom	.37,43	Regency	.02,33	Zenith	.14,42,57,61

Satellite Receiver Codes					
Brand*	Code	Brand*	Code	Brand*	Code
GE	.00	ProScan	.00	RCA	.00

\*The remote may not be able to control every cable box or satellite receiver of the brands listed.

### Operate the Cable Box or Satellite Receiver

After you set up your remote to control the cable box or satellite receiver, test the buttons to see which ones operate it.

1. Point the remote at the component and press CABLE.
2. If the component does not turn on in step 1, press CABLE, then POWER.
3. Use the "Cable Box or Satellite Receiver Function Buttons" described in the "Remote Control" section.

# Playback

## To play a tape

1. Turn on the TV and tune it to channel 3, 4, or the TV's video input to see the picture from the VCR.
2. Insert a tape in the VCR.  
The VCR automatically turns on and the VCR indicator lights. The VCR automatically begins playback if the safety tab on the tape has been removed and the AUTO PLAY feature is turned on.

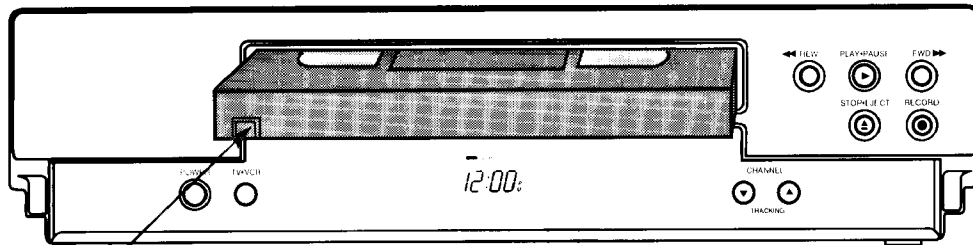

**Safety Tab**

3. Press PLAY•PAUSE on the VCR or PLAY on the remote or VCR, if necessary.
4. Press TRACKING up or down on the remote or the VCR to remove any streaks from the picture if necessary. See "Manual Tracking" section.
5. Press STOP•EJECT on the VCR or STOP on the remote to stop the tape.
6. Press REW on the VCR or the remote to rewind the tape.

### End of Tape

The VCR automatically rewinds the tape if it reaches the end of the tape during playback.

### Power Off

If you press POWER while a tape is rewinding, the VCR turns off automatically when it is completely rewound.

7. Press STOP•EJECT on the VCR to eject the tape once it is completely rewound.

## AUTO PLAY Feature

This feature allows the VCR to automatically start playing when you insert a tape with the safety tab removed.

1. Press MENU on the remote to display the VCR MAIN MENU.
2. Press 5 to display the PREFERENCES menu.
3. Press 2 to select AUTO PLAY: ON or OFF.
  - Select ON if you want to have a tape with its safety tab removed to start playing automatically.
  - Select OFF if you *do not* want a tape with its safety tab removed to start playing automatically.

VCR MAIN MENU	
1	VCR PLUS+
2	TIMER RECORDINGS
3	TIME
4	CHANNELS
5	PREFERENCES
PREFERENCES	
1	REMOTE CONTROL: VCR1
2	AUTO PLAY: ON
3	FRONT PANEL: AUTO
4	ALERT SOUND: OFF
5	CA MARKING: OFF
6	CA PLAYBACK: AUTO
7	CA DISPLAY: BLUE
0	EXIT

# Using the Playback Features

## Picture Search

You can search for a specific tape location during playback by fast forwarding or rewinding the tape. Sound is turned off during picture search. Picture search works best for tapes recorded in the SP or SLP speed.

### Fast Forward Search

1. Press FF on the remote or FWD on the VCR to search forward at a faster-than-normal speed.
2. Press FF or PLAY on the remote or FWD or PLAY•PAUSE on the VCR to return to playback.

### Rewind Search

1. Press REW on VCR or remote to search backward at a faster-than-normal speed.
2. Press REW or PLAY•PAUSE on the VCR or REW or PLAY on the remote to return to playback.

## Slow Motion

You can view a tape in slow motion during play or play pause. The + and - buttons let you vary the speed. Sound is turned off during slow-motion playback. Slow motion works best for tapes recorded in the SP or SLP speed.

1. Press SLOW•F.ADV during playback to begin slow motion.
2. Press + to increase the speed or - to decrease the speed.
2. Use TRACKING up or down to remove any streaks from the picture.
3. Press PLAY on the remote or PLAY•PAUSE on the VCR to return to playback.  
The VCR automatically switches from slow-motion playback to stop after a few minutes.

## Pause for Stop Action

This feature stops the tape in action and lets you examine the details of the scene. Stop action works best for tapes recorded in the SP or SLP speed.

1. Press PAUSE on the remote or PLAY•PAUSE on the VCR during playback to stop the action.
2. Press TRACKING up or down to move the lines out of the picture or reduce any jittering of the picture.
3. Press PAUSE or PLAY on the remote or PLAY•PAUSE on the VCR to return to playback.  
The VCR automatically switches from stop-action playback to stop after a few minutes.

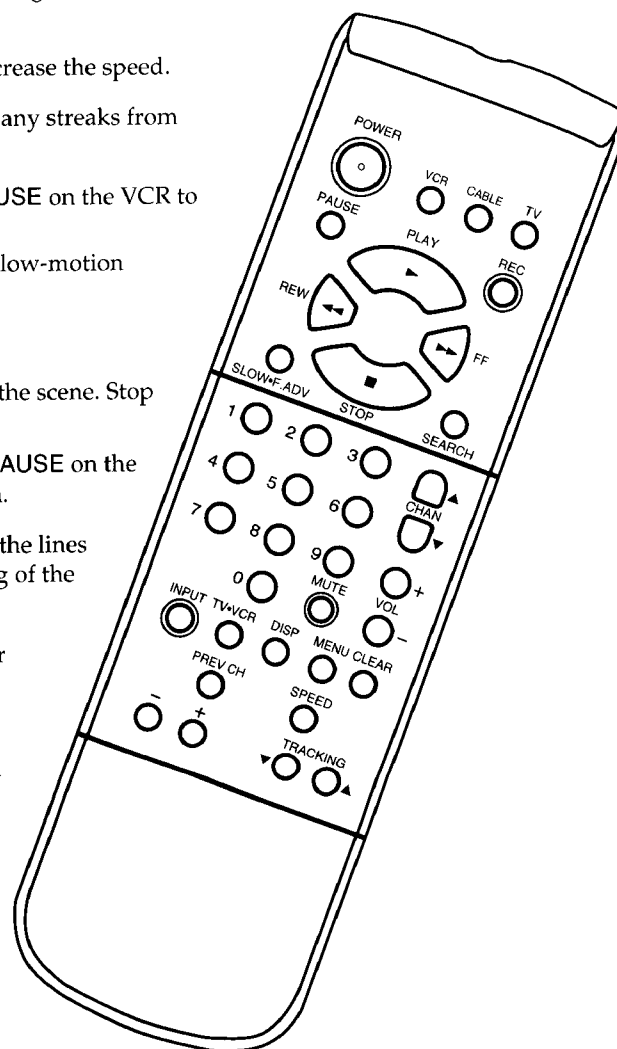

## Using the Playback Features

### DISP (DISPLAY) Button

The DISP button shows the status of the VCR channel number, station ID (if broadcast), time counter, date, time and tape speed on the TV screen. The time and date must be set before they can be displayed.

1. Press DISP.  
If you do not press DISP again, this display times out.
2. Press DISP again to display only the time counter on the TV screen.
3. Press DISP again to return to TV viewing.  
Turning off the VCR automatically returns the displays to normal.

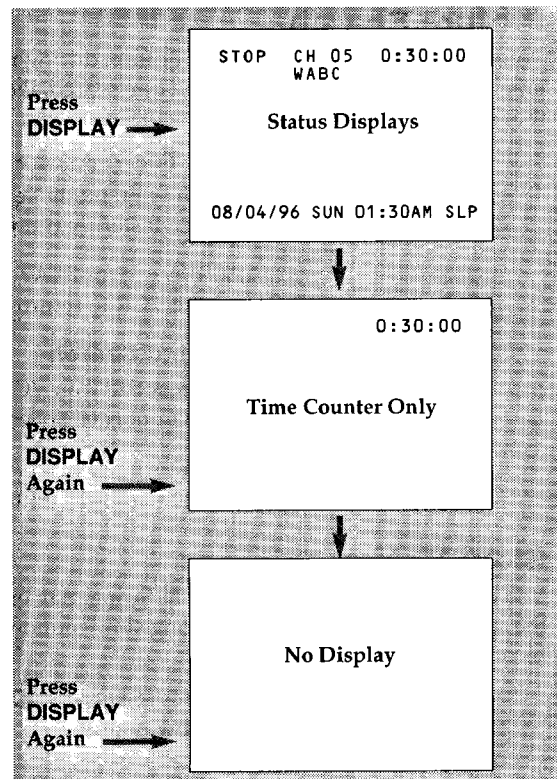

### Time Counter

The time counter shows the actual time it takes to record a program or play back a segment of a prerecorded tape. It helps locate the beginning or ending of programs you taped. The time counter resets to 0:00:00 when the tape is ejected from the VCR.

For example, if you record a 30-minute program at the beginning of the tape and you want to go to the end of that program to begin another recording, you would:

1. Insert the prerecorded tape and make sure it is rewound to the beginning.
2. Press DISP twice to display only the time counter on the TV screen.
3. Press CLEAR to reset the time counter to 0:00:00.
4. Press FF to fast forward the tape until 0:30:00 appears in the time counter and press STOP. The time counter does not advance when it detects no signal (blank tape).
5. Press DISP to remove the time counter from the screen.

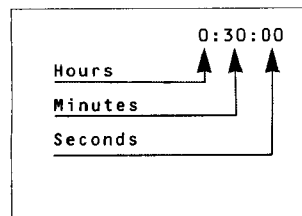

## Using the Playback Features

### Index Search

The VCR has a "VHS Index Search System" that automatically records an index mark on the tape every time you begin recording a program. Your VCR has two index playback features. To locate the program you want to play, select a specific index number or search by scanning.

Some index marks may be missed by the VCR.

- A mark too close to the current location on the tape.
- The mark at the beginning of a recorded segment of five minutes or less.
- The first index mark on the tape when you start searching from the beginning of the tape.

#### To Index Search

1. Insert the prerecorded tape and press STOP.
2. Press SEARCH on the remote to display the INDEX SEARCH menu on the TV screen.
3. Press REW or FF on the remote to scan or enter the number of index marks you want the VCR to search. Press CLEAR on the remote to correct an entry. Once the index mark or marks are found, the tape begins playback.
4. Follow the directions on the screen.

```
INDEX SEARCH
PRESS REW OR FF
TO BEGIN SCANNING
OR
ENTER A SPECIFIC
INDEX NUMBER
      ↕
PRESS SEARCH TO EXIT
```

```
INDEX SEARCH
SEARCHING FOR
INDEX MARKS...

PRESS STOP TO CANCEL
```

### Zero Search

The zero search feature allows the VCR to quickly return to a counter reading of 0:00:00 anywhere on the tape. This is especially convenient when you want to watch a segment of the tape several times.

1. Insert the prerecorded tape.
2. Press DISP *twice* to display only the time counter on the TV screen.
3. Use PLAY, FF, or REW to advance to the place on the tape where you want to return quickly.
4. Press CLEAR to reset the time counter to 0:00:00.
5. Continue playing the tape.
6. Press STOP.
7. Press SEARCH twice to display the ZERO SEARCH menu on the TV screen.
8. Follow the directions on the screen.

```
ZERO SEARCH

CURRENT TAPE COUNTER IS
2:17:25
PRESS REW TO GO TO
0:00:00
PRESS SEARCH TO EXIT
```

OR

```
ZERO SEARCH

CURRENT TAPE COUNTER IS
-2:17:25
PRESS FF TO GO TO
0:00:00
PRESS SEARCH TO EXIT
```

## Using the Playback Features

### Blank Search

The VCR searches for blank portions of the tape that are more than six seconds long.

1. Insert the prerecorded tape and press STOP.
2. Press SEARCH *three times* to display the BLANK SEARCH menu.
3. Press FWD on the VCR or FF on the remote to begin searching for six seconds of blank tape. A message appears on the screen if a blank area is not found.
4. Press STOP to stop BLANK searching.

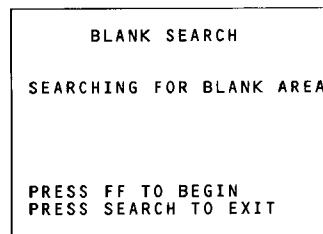

### Frame Advance (SLOW•F. ADV Button)

Frame advance lets you view one stop-action frame after another. Frame advance works best for tapes recorded in the SP or SLP speed.

1. Press PAUSE on the remote or PLAY•PAUSE on the VCR during playback to stop the action.
2. Press SLOW•F. ADV each time you want to view a frame of the scene.
3. Press PAUSE or PLAY on the remote or PLAY•PAUSE on the VCR to resume normal playback.

### Automatic Tracking

The VCR has automatic tracking which adjusts the picture when you are playing back a tape recorded on another VCR. Automatic tracking is turned on when a tape is inserted or the VCR's power is turned on.

### Manual Tracking

Occasionally, you may need to manually adjust tracking on a tape recorded on a different VCR or camcorder. Tracking is used when playing a tape, and it has no effect during recording.

- When streaks or snow appear in the picture, press TRACKING up or down on the remote or the VCR for the best possible picture.
- During pause, press TRACKING up or down on the remote to reduce any jittering of the picture.
- To turn Automatic Tracking back on, press both TRACKING buttons on the front of the VCR at the same time, or eject the tape and re-insert it.

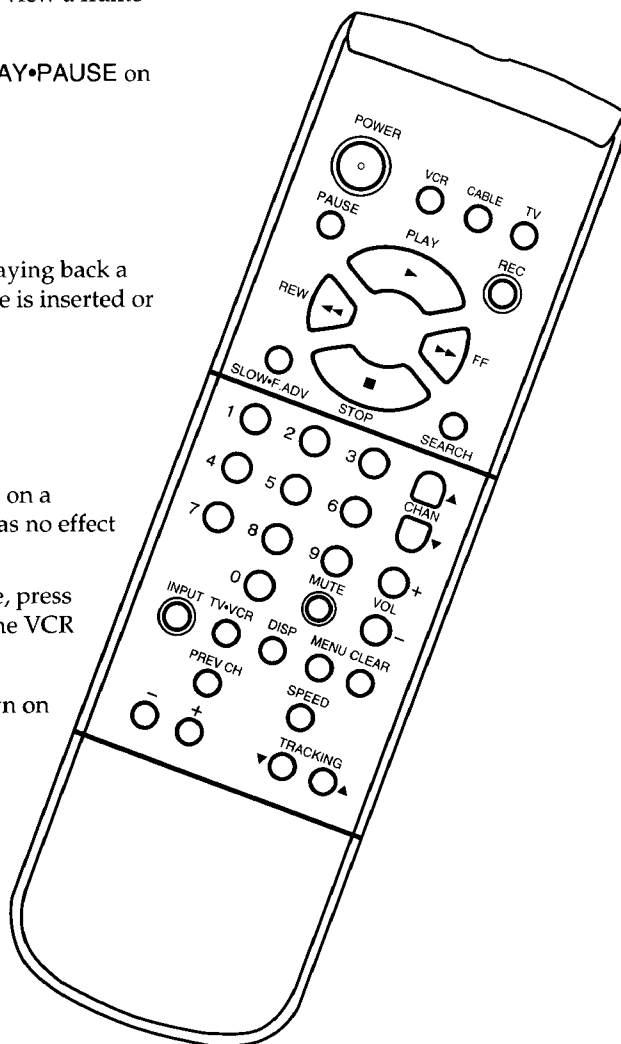

# COMMERCIAL▶▶ADVANCE™

COMMERCIAL▶▶ADVANCE™ is a patented technology that detects and marks most commercials on your tape for any recording that is more than 15 minutes long. During playback, the VCR automatically skips the detected commercial segments or you can choose to manually skip them. This feature reduces three minutes of commercials into approximately 8-12 seconds of fast forwarding in the SLP speed. You can select a background of blue or see the video as the commercials are skipped.

After recording, the VCR rewinds the tape to the beginning of the recording and determines where the commercials are located. It then marks the beginning and end of the detected commercial segments and returns the tape to the end of the recording. *It does not erase the commercials from the tape.*

Because television signals do not indicate where commercials are located, this feature finds and marks them through a set of formulas based on how television is broadcast today. Since television stations broadcast differently and insert their own commercials, you may experience some variations in this feature's effectiveness. Station promotions, identifications, and announcements are not considered commercials — but might be skipped.

See "Trouble Checks" section for answers to common questions about COMMERCIAL▶▶ADVANCE™.

## COMMERCIAL▶▶ADVANCE™ Marking

1. Press MENU to display the VCR MAIN MENU.
2. Press 5 to display the PREFERENCES menu.
3. Make sure CA MARKING is set to ON. If not, press 5.

The VCR will mark most commercials for the following types of recording:

- **VCR Plus+, Timer, or One Touch Recording:** The VCR will automatically mark the commercials after the power is turned off.
- **Manual Recording:** When you press STOP to stop recording, the VCR will ask you if you want to mark the commercials. Just follow the on-screen display.

MARK and COMM alternate in the display panel while the VCR is marking commercials.

### To Stop COMMERCIAL▶▶ADVANCE™ Marking

Press STOP to cancel commercial marking.

### To Turn Off Marking

For special VCR use (such as editing or copying) or if you decide not to use this feature, turn COMMERCIAL▶▶ADVANCE™ marking (CA MARKING) off.

1. Press MENU to display the VCR MAIN MENU.
2. Press 5 to display the PREFERENCES menu.
3. Press 5 to select CA MARKING: OFF.

The VCR will not mark the commercials.

COMMERCIAL▶▶ADVANCE™ is a trademark of Arthur D. Little Enterprises, Inc.  
A Jerry Iggulden invention licensed by Arthur D. Little Enterprises, Inc.

VCR MAIN MENU

1 VCR PLUS+  
2 TIMER RECORDINGS  
3 TIME  
4 CHANNELS  
5 PREFERENCES

PREFERENCES

1 REMOTE CONTROL: VCR1  
2 AUTO PLAY: ON  
3 FRONT PANEL: AUTO  
4 ALERT SOUND: OFF  
5 CA MARKING: ON

THE VCR IS WAITING TO MARK COMMERCIALS IN THE PROGRAM YOU RECORDED.

1 MARK THEM NOW  
2 MARK THEM LATER  
3 DON'T MARK COMMERCIALS

THE VCR WILL BEGIN MARKING IN 30 SECONDS...

MARKING COMMERCIALS...  
PRESS STOP TO CANCEL

VCR MAIN MENU

1 VCR PLUS+  
2 TIMER RECORDINGS  
3 TIME  
4 CHANNELS  
5 PREFERENCES

PREFERENCES

1 REMOTE CONTROL: VCR1  
2 AUTO PLAY: ON  
3 FRONT PANEL: AUTO  
4 ALERT SOUND: ON  
5 CA MARKING: OFF  
6 CA PLAYBACK: AUTO  
7 CA DISPLAY: BLUE  
0 EXIT

## COMMERCIAL▶▶ADVANCE™

### To Select a Background for Playback

1. Press MENU to display the VCR MAIN MENU.
2. Press 5 to display the PREFERENCES menu.
3. Press 7 to select CA DISPLAY: BLUE or VIDEO.
  - Select BLUE to have the VCR display a blue screen while it advances through the block of marked commercials.
  - Select VIDEO to have the VCR display the video as it advances through the block of marked commercials.

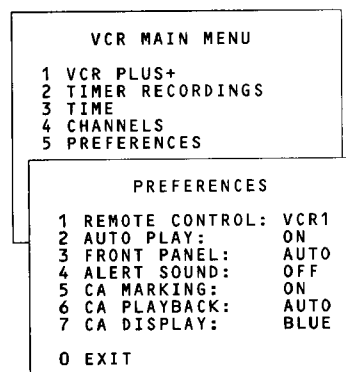

### To Play Back a Recording Made Using COMMERCIAL▶▶ADVANCE™

1. Press MENU to display the VCR MAIN MENU.
2. Press 5 to display the PREFERENCES menu.
3. Press 6 to select CA PLAYBACK: AUTO or MANUAL.
  - Select AUTO to have the VCR automatically advance through the blocks of marked commercials.

It works with most 30, 45, and 60-second commercials.

A commercial group starting within the first two minutes or last two minutes of a recording will not be automatically skipped.

A commercial will not be skipped if the recording starts in the middle of a commercial segment, one isolated commercial is shown without others, or a commercial is longer than one minute. Press FF to scan through the commercial.

It is possible that part of a recorded program might be skipped if the program segment is between commercials and less than one minute or there are frequent dark and quiet scenes. If part of the program is skipped, rewind the tape to the beginning of the skipped program segment and press PLAY.

- Select MANUAL and the VCR will not advance through the blocks of marked commercials until you press SEARCH.

The VCR will resume playback when it reaches the end of the marked commercials.

If you press SEARCH during playback of material other than commercials, the VCR will still advance to the end of the next "marked" commercial block and resume playback.

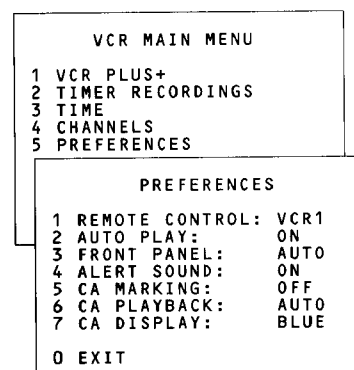



# Recordings

Your VCR provides different recording options. These options are explained in this section of the manual.

## Recording Speeds

Press **SPEED** on the remote to select a recording speed (SP or SLP). The speed you select appears on the TV screen. Tapes recorded in LP can be played in this VCR.

**SP (Standard Play)** gives the best quality recording. That is why most prerecorded, rental tapes are recorded in SP. Fewer programs can be recorded on the tape. Special effects such as pause, frame advance, slow motion, and picture search work well in this speed.

**SLP (Super Long Play)** gives three times the recording time of tapes recorded in SP. Special effects such as pause, frame advance, slow motion, and picture search work well in this speed.

Cassette	Recording Time	
	SP	SLP
T-120	2Hrs	6Hrs
T-160	2Hrs 40Min	8Hrs

# Normal Recording

## To Make a Recording

Turn on the TV and tune it to the VCR viewing channel, either 3, 4, or the TV's video input channel.

1. Insert a tape with its safety tab in place.
2. Press **VCR** to set the remote to control the VCR.
3. If you are using one of the basic hookups, make sure the VCR indicator lights in the VCR's display panel. If not, press **TV•VCR** to turn it on.
4. Use **SPEED** on the remote to select a recording speed.  
The tape speed indicator appears on the TV screen.
5. Select the channel to be recorded.  
The channel number appears on the TV screen.
6. Press **RECORD** on the VCR or **REC** on the remote to begin recording.  
The **REC** indicator lights in the VCR's display panel.

## Watch a TV Channel While VCR is Recording a Different Channel

For some cable box hookups, this recording feature may not apply. Contact your local cable company for assistance.

1. Follow steps 1 through 6 above.
2. If you are using one of the basic hookups, press **TV•VCR** to switch to the TV channel.  
The VCR indicator turns off in the display panel.
3. Press **TV** to set the remote to control TV functions for a compatible TV.
4. Select the channel you want to watch with the TV's channel buttons.
5. Press **STOP•EJECT** on the VCR or **STOP** on the remote when the recording is finished.

## Express Recording

Express recording lets you record up to four hours without using the timer program feature. The VCR turns off automatically at the end of the recording.

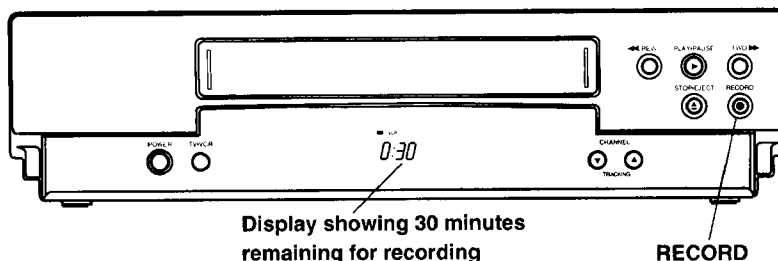

1. Turn on the VCR.
2. Insert a tape with its safety tab in place.
3. Select the channel you want to record.
4. Use **SPEED** on the remote to select a recording speed.
5. Press **REC** on the remote or **RECORD** on the VCR twice to start the recording.
6. Press **RECORD** or **REC** repeatedly until the amount of recording time for the program is displayed on the TV screen.

	Press <b>RECORD</b>	Recording Time
<div style="border: 1px solid black; padding: 5px; width: fit-content;"> <p>REC CH 06 RECORD LENGTH 0:00</p>    <p>PRESS REC TO SET LENGTH</p> </div> <p>Display on TV Screen</p>	0:30	(30 Min)
	1:00	(1 Hr)
	1:30	(1 Hr, 30 Min)
	2:00	(2 Hrs)
	3:00	(3 Hrs)
	4:00	(4 Hrs)
	<b>Normal Record</b>	
	0:00	Turns Off

Each press of **RECORD** or **REC** increases the time — 30 minutes up to 4 hours.

The amount of time the VCR records, power indicator flashes, and **TIMER** indicators lights in the VCR display panel.

During recording, press **RECORD** on the VCR or **REC** on the remote to display the time remaining on the TV screen. Press **RECORD** or **REC** again to increase the recording time.

## Stopping a Express Recording in Progress

You can stop a recording by:

- Pressing and holding the **STOP** button on the remote or **STOP•EJECT** on the VCR for approximately three seconds.
- Pressing the **RECORD** button until 0:00 is displayed for the recording.

# Recording While You're Away (VCR Plus+\* Recording)

## VCR Plus+ Setup

A VCR Plus+ channel number is assigned for each broadcast or cable channel. These numbers are listed in most publications that list PlusCode\* numbers.

1. Prepare the worksheet for the VCR Plus+ channels that are different from the channels you receive them on. Refer to the chart below for standardized VCR Plus+ channel numbers.
2. Press MENU on the remote to display the VCR MAIN MENU on the TV screen.

Broadcast or Cable-TV Station Name	VCR Plus+ Channel Number	Channel Number You Receive This Station On
HBO	33	See Note 1
ESPN	34	See Note 1
ABC	See Note 2	See Note 1
FOX	See Note 2	See Note 1

**Note 1:** Check your local or cable listing for the channel number you receive this station on.  
**Note 2:** Check your local listing for the broadcast or VCR Plus+ channel number assigned to this station.

3. Press 4 to display CHANNELS menu.
4. Press 4 to display VCR PLUS+ CHANNEL LIST menu.
5. Using the worksheet on the next page, press two numbers to enter each channel number you receive on a **different** channel than the assigned VCR Plus+ channel number.

If a channel in your area has been assigned more than one VCR Plus+ channel number, enter that same channel number next to each VCR Plus+ channel number.

Press CHAN up or down to move the VCR PLUS+ numbers up or down on the menu.

Press CLEAR on the remote to erase a number.

6. Press MENU when you are finished.

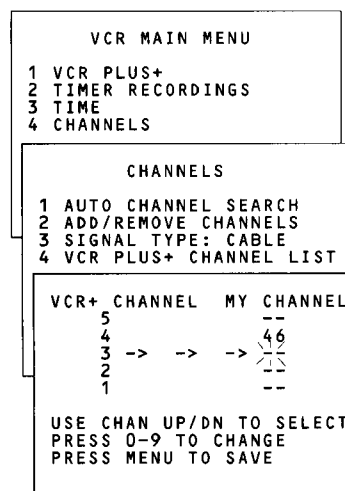

### Standardized VCR Plus+ Channel Numbers for Cable-TV

U.S.A. List		Canadian List	
35 American Movie Classics	58 The Movie Channel	67 Allarcom Pay Television/Superchannel	99 First Choice Four
39 Arts & Entertainment	48 Music Television	44 Arts & Entertainment	90 House of Commons
57 Black Entertainment	49 The Nashville Network	72 Cable News Network-Headline News	91 La Chaîne Française
54 Bravo	38 Nickelodeon	61 Cable News Network	51 The Learning Channel
42 Cable News Network	64 Nostalgia Television	70 Canadian Home Shopping Network	65 MeteoMedia/The Weather Network
45 Cinemax	99 Quality Value Cable	56 Canal Famille	48 MuchMusic Network
98 Cinemax 2	41 Showtime	69 Cathay International Television Inc	55 MusiquePlus
37 The Discovery Channel	97 Showtime 2	68 Chinavision Canada Corp	52 Nashville Network
53 The Disney Channel	59 Sports Channel	60 Country Music Television	73 Newsworld/CBC
63 Entertainment Television	52 Turner Network Television	63 Family Channel	53 Le Réseau des Sports
34 ESPN Sports Network	44 USA Network	62 First Choice	43 The Sports Network
47 The Family Channel	62 Video Hits 1	96 First Choice Two	64 Super Ecran
33 Home Box Office	93 Viewer's Choice 1	97 First Choice Three	37 Super Ecran B
95 Home Box Office 2	94 Viewer's Choice 2		98 Super Ecran C
96 Home Box Office 3	55 WGN Chicago		66 Telatino Network
51 The Learning Channel	43 WTBS Atlanta		46 TV5 Montreal
46 Lifetime	60 WWOR New York		92 Viewer's Choice 1

\*VCR Plus+ and PlusCode are trademarks of Gemstar Development Corporation.



## Recording While You're Away (VCR Plus+ Recording)

The VCR Plus+ and timer program features let you program the VCR to record up to eight different programs within a one year period. Before using VCR Plus+ to record a program, make sure that:

- The clock is set correctly.
- A tape with safety tab has been inserted with enough tape to record the program(s).
- The remote is set to control the VCR — using VCR.
- The VCR is set up for VCR Plus+ programming.

### Setting a VCR Plus+ Recording

1. Press MENU on the remote to display the VCR MAIN MENU.
2. Press 1 to display the VCR PLUS+ menu.
3. Press numbers on the remote to enter PlusCode number for the program you want to record. VCR PlusCode numbers are found in most local TV listings.  
Press CLEAR on the remote to correct an entry.
4. Press MENU to enter the program.  
If the VCR does not recognize the PlusCode number, UNRECOGNIZED NUMBER... PLEASE RE-ENTER appears on the TV screen. Check the number and enter it again.
5. Press 1, 2, 3, or 4 to select type of program.
  - 1 ONE TIME – single program recorded once.
  - 2 DAILY – program recorded at same time every day.
  - 3 WEEKDAYS – program recorded at same time Monday through Friday.
  - 4 WEEKLY – program recorded at same time once a week.
6. Select a recording speed using the SPEED button.
7. Press CLEAR if you want to change the program end time.  
This feature lets you extend the recording time on VCR Plus+ programs. Also, this option may be useful when you are recording programs such as sporting events that could exceed scheduled broadcast times.
8. Press MENU to enter your program.  
A reminder appears which times or you can press MENU until VCR MAIN MENU appears.  
If you have entered two programs whose times overlap, PROGRAMS OVERLAP appears on the screen.
9. Repeat steps 2 – 8 for additional programs or press 0 to remove the menu from the TV screen.
10. Turn off the VCR before recording time.  
The TIMER indicator appears in the VCR display panel.

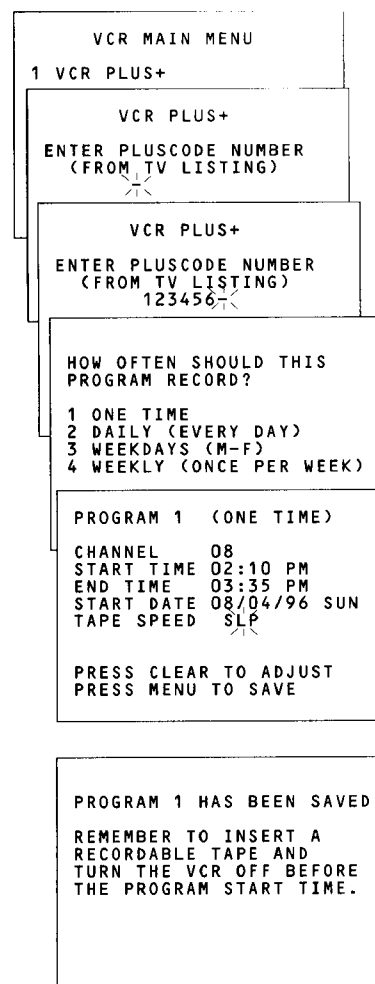

### Stopping a VCR Plus+ Recording in Progress

You can stop a recording by pressing and holding the STOP button on the remote or STOP•EJECT on the VCR for approximately three seconds.

## Recording While You're Away (Timer Recording)

The timer program and VCR Plus+ features let you program the VCR to record up to eight different programs within a one year period. Before setting the timer, make sure that:

- The clock is set correctly.
- A tape with its safety tab in place has been inserted with enough tape to record the programs.
- The remote is set to control the VCR — using VCR.

### Setting a Timer Recording

1. Press MENU on the remote to display the VCR MAIN MENU.
2. Press 2 to display the TIMER RECORDINGS menu.
3. Press 1 to display the CREATE A NEW PROGRAM menu.
4. Press 1, 2, 3, or 4 to select type of program.
  - 1 ONE TIME — single program recorded once.
  - 2 DAILY — program recorded at same time every day.
  - 3 WEEKDAYS — program recorded at same time Monday through Friday.
  - 4 WEEKLY — program recorded at same time once a week.
5. Press number buttons on the remote to enter the channel number (or INPUT on the remote to select line input), start time including AM or PM, end time, and start date of the recording. Follow the on-screen prompts. Press CLEAR on the remote to correct an entry.
6. Press SPEED, or 1(SP), 2 (SLP) on the remote to select the recording speed.
7. Press MENU to enter your program. A reminder appears which times or you can press MENU until TIMER RECORDINGS menu appears. If you have entered two programs whose times overlap, PROGRAMS OVERLAP appears on the screen.
8. Repeat steps 3–7 for additional programs or press MENU twice to remove the menu from the TV screen.
9. Turn off the VCR before the recording time. If using a cable box, leave it turned on and tuned to the channel you want to record. The TIMER indicator appears in the VCR display panel.

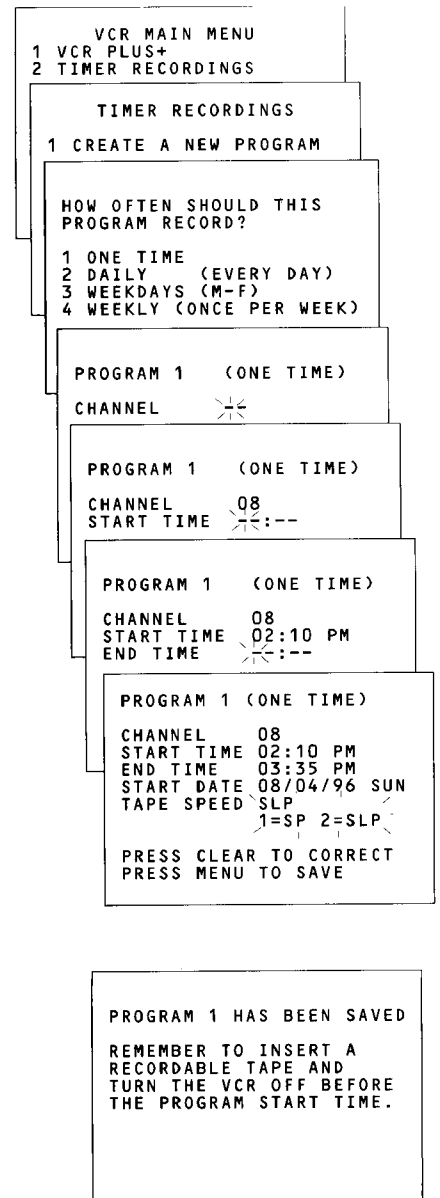

### Stopping a Timer Recording in Progress

You can stop a recording by pressing and holding the STOP button on the remote or STOP•EJECT on the VCR for approximately three seconds.

# Recording While You're Away (Timer Recording)

## Checking or Clearing VCR Plus+ or Timer Recordings

1. Press MENU on the remote to display the VCR MAIN MENU.
2. Press 2 to display the TIMER RECORDINGS menu.
3. Press 2 to display the REVIEW EXISTING PROGS menu. Each entered program is displayed for a few seconds in sequence.
4. Press MENU for next program or CLEAR to erase the program.

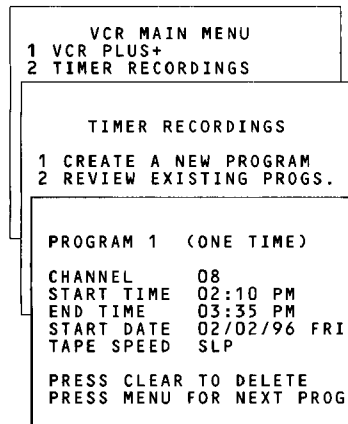

## Timer Recording From the VCR's Line Input

The line input refers to the signal coming from the VCR's AUDIO and VIDEO IN jacks. Recording from the line input is convenient if you have a satellite receiver or similar component attached to these jacks.

To timer record from the component connected to the VCR's line input, press INPUT on the remote to enter VIDEO instead of the channel number on the TV screen during timer programming.

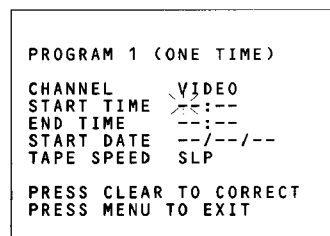

# Using the Recording Features

## Recording Pause

To prevent recording short passages of unwanted material, use PAUSE or PLAY•PAUSE during recording to stop and start recording. The VCR automatically switches from pause to stop after a few minutes.

## Pro-Tect Plus™ (Child Lock) Feature

This feature is useful to tamper proof your timer recordings from unwanted changes and/or protect the VCR from misoperation by other users in the household.

### To Lock the VCR

Press and hold POWER or VCR button on the remote for approximately six seconds to turn on the Pro-Tect Plus™ feature.

SAFE appears in the VCR front panel to let you know the feature is activated.

### To Unlock the VCR

Press and hold VCR button on the remote for approximately six seconds to unlock the VCR.

# Using Two VCRs for Copying and Editing Tapes

## Operating Instructions (Refer to hookup on page 6.)

Use one VCR as the playback VCR and the other as the recording VCR.

**Caution:** The unauthorized recording of television programs and other materials may infringe the rights of others.

1. Turn on the TV and VCRs.
2. Tune the TV to the VCR viewing channel, either 3, 4, or the TV's video input.
3. If you connected your VCR using Option A (page 6), tune the recording VCR to channel 3 or 4 – the one selected on the back of the playback VCR.  
  
If you connected your VCR using Option B (page 6), press INPUT on the recording VCR's remote to select the line input.
4. Insert the tape you want to copy into the playback VCR. Insert a blank tape with its safety tab in place into the recording VCR.
5. Press PLAY, then PAUSE on playback VCR when you reach the point on the tape or program where you want to begin copying. If the tape was not recorded on the playback VCR, streaks may appear, and you may need to adjust tracking.
6. Press RECORD on the VCR or REC on the remote, then PAUSE on the recording VCR.
7. Press the PAUSE buttons on both VCRs at the same time to begin copying the tape.\*
8. Edit out segments that you do not want to copy by pressing PAUSE on the recording VCR to stop copying the tape. Then, locate the next segment you want to copy on the playback VCR by using FWD, REW and PLAY. Press PAUSE on the playback VCR. Press PAUSE at the same time on both VCRs to resume copying.
9. Press STOP•EJECT on both VCRs when you are finished.

\*You may turn off the TV after the recording has started as it does not have to be on to copy a tape.

## Copying and Editing Tapes Using Compatible Remote

If you have a compatible RCA, ProScan or GE remote with VCR1 and VCR2 buttons, you can program this VCR to respond to either VCR1 or VCR2. This lets you control both VCRs with one remote for easier copying and editing.

Set the REMOTE CONTROL feature of this VCR to VCR1 or VCR2 position. Then, the compatible remote controls the VCR with either the VCR1 or VCR2 button — depending on the position you select in the menu.

1. Press MENU to display the VCR MAIN MENU.
2. Press 5 to display PREFERENCES.
3. Press 1 to activate the REMOTE CONTROL: VCR1 or VCR2 feature.
4. Press VCR1 or VCR2 on your compatible VCR's remote to change the setting and program this VCR to respond to VCR1 or VCR2 — depending on the position you selected in step 3.

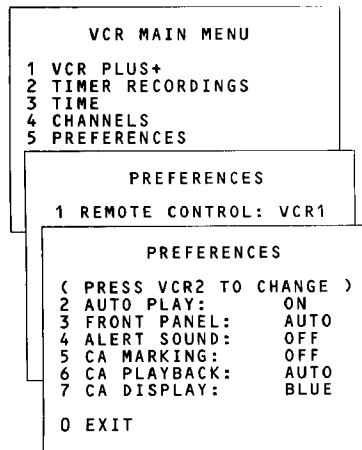



# Location of Controls

## Front Panel

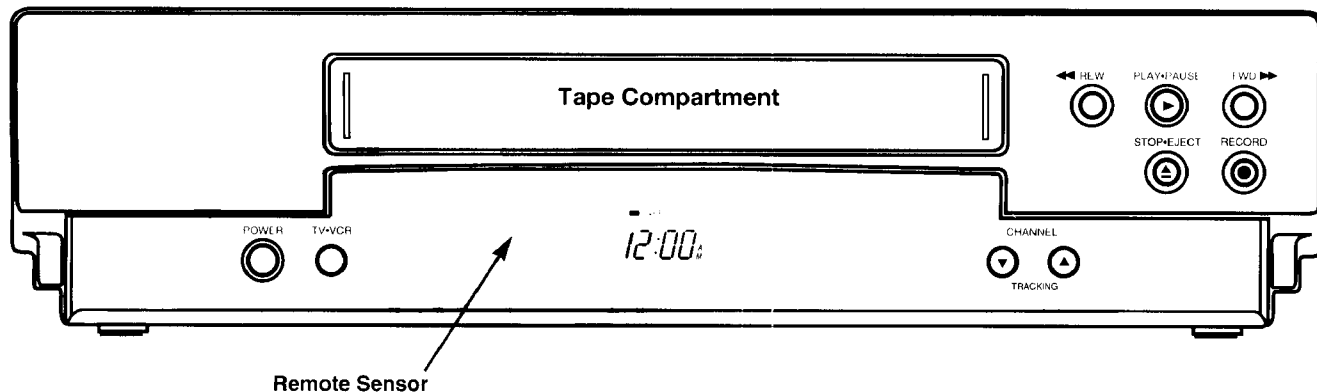

### **CHANNEL or TRACKING up or down**

Selects next higher or lower channel in the VCR's channel memory.

Adjusts tracking during playback.

### **FWD (Fast-Forward)**

Fast-forwards the tape when the VCR is stopped. Searches the picture forward during playback.

### **PLAY•PAUSE**

Plays a tape.

Pauses the tape for stop-action viewing during playback.

Pauses the tape during recording to prevent recording unwanted material.

### **POWER**

Turns the VCR on or off.

### **RECORD**

Starts the VCR recording.

Used for express recording.

### **Remote Sensor**

Receives signals from the remote control.

Aim the remote at this sensor with no objects between them.

### **REW (Rewind)**

Rewinds the tape when the VCR is stopped.

Searches the picture in reverse during playback.

### **STOP•EJECT**

Stops the VCR's normal functions such as record, playback, rewind, fast-forward, or pause.

Ejects the cassette when the VCR is stopped.

### **TV•VCR**

Switches the picture signal so that it either comes from the VCR or the TV channel.

# Location of Controls

## Display Panel

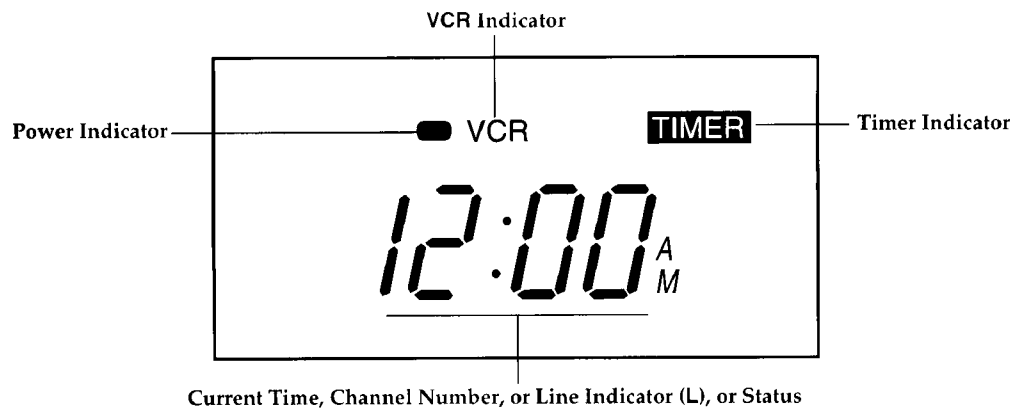

### Power Indicator

Lights when the VCR is turned on.  
Flashes during a recording.

### Time, Channel Number, or Line Input (L)

The current time is displayed. Only the AM indicator appears; when the time is PM, no indicator appears.

The channel number or line input is displayed. Press INPUT on the remote to display the line input indicator (L) to record from the VIDEO1 IN and AUDIO1 IN jacks.

### Status Indicators

Shows what the VCR is doing.

- PLAY A tape is playing.
- REC A tape is recording.
- REW A tape is rewinding.
- FF A tape is fast forwarding.
- STOP A tape is stopped.

### TIMER Indicator

Shows VCR is set for timer recording when VCR is turned off.

Flashes when the timer recording is set and there is no cassette in the VCR.

### VCR Indicator

Lights when using the TV•VCR button.

When using one of the basic hookups:

- The picture comes from the VCR when VCR indicator is on.
- The picture comes from the television channels when VCR indicator is off.

**Back Panel**

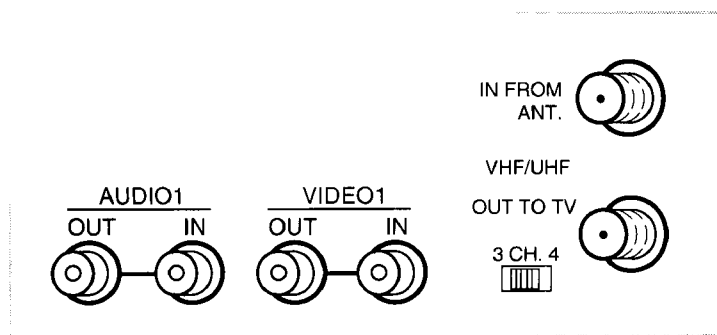

**3CH.4 Switch**

Selects the channel to which you tune the TV to see the VCR picture if you connect the VCR using one of the basic hookups.

**IN FROM ANT. (Antenna) Connector**

Receives a signal from an antenna or cable system when attached.

**OUT TO TV Connector**

Passes signal to TV using the cable supplied.

**VIDEO1 IN and AUDIO1 IN Jacks**

Receives signals from another component like a VCR or camcorder when it is connected to these jacks. Use INPUT (channel 00) on the remote to select.

**VIDEO1 OUT and AUDIO1 OUT Jacks**

Sends signals from VCR to another component like a TV, VCR, or camcorder when it is connected to these jacks.

## Trouble Checks

Sometimes problems can be easily solved by checking a few basic things. Check below before you call for help or take your VCR to an Authorized RCA VCR Servicenter.

<b>Trouble</b>	<b>Here's what to try:</b>
No power	<ul style="list-style-type: none"> <li>• Plug VCR into an operating outlet.</li> <li>• Check connections.</li> </ul>
VCR does not respond to remote	<ul style="list-style-type: none"> <li>• Remove batteries and hold down one or more buttons for several seconds to drain the microprocessor inside the remote and reset it. Re-install the batteries and try remote again.</li> <li>• Press VCR to set remote to control the VCR.</li> <li>• Aim remote at VCR with no objects between them.</li> <li>• Change batteries.</li> <li>• Check the ProTect Plus™ feature.</li> </ul>
Remote no longer controls an RCA TV	<ul style="list-style-type: none"> <li>• Press TV to set remote to control a compatible TV. <i>See page 14.</i></li> <li>• Reprogram remote for RCA TV. <i>See page 14.</i></li> </ul>
Remote no longer controls a compatible TV, cable box, or satellite receiver	<ul style="list-style-type: none"> <li>• Press TV or CABLE button to set remote to control the corresponding component. <i>See pages 14-15.</i></li> <li>• Reprogram remote to control the component. <i>See pages 14-15.</i></li> <li>• Aim remote at TV with no objects between them.</li> <li>• Reprogram remote after batteries have been changed.</li> <li>• Change batteries.</li> </ul>
Poor or no picture for normal TV viewing	<ul style="list-style-type: none"> <li>• Press TV•VCR to turn VCR indicator off.</li> <li>• Switch TV to an active channel.</li> <li>• Check antenna connections.</li> </ul>
Snowy or no picture during playback	<ul style="list-style-type: none"> <li>• Press TV•VCR to turn VCR indicator on.</li> <li>• Check TV channel selected (3 or 4) to make sure it matches the channel selected with 3CH.4 switch on back of VCR.</li> <li>• Check TV's fine tuning.</li> <li>• Check video cable connections between VCR and TV monitor.</li> <li>• Set TV monitor to video input channel.</li> <li>• Try another tape.</li> <li>• Some snow/streaks are normal during search, stop action, frame advance, and slow-motion playback.</li> </ul>
Streaks in picture during normal playback	<ul style="list-style-type: none"> <li>• Press TRACKING to move streaks for the best picture.</li> <li>• Check tape — it may be worn out or of poor quality.</li> </ul>
Time counter not working	<ul style="list-style-type: none"> <li>• The time counter does not advance during unrecorded portions of tape. When an unrecorded segment of tape is encountered, the time counter will hold its count until recorded material is detected again.</li> <li>• A minus (-) appears in front of the time if you rewind the tape farther back than a counter reading of 0:00:00.</li> </ul>
Will not record or play	<ul style="list-style-type: none"> <li>• No cassette in VCR.</li> <li>• Eject and reinsert cassette.</li> <li>• Broken tape — try another cassette.</li> <li>• VCR is in pause mode. Press PAUSE or PLAY•PAUSE on the remote or the VCR during recording or playback.</li> <li>• Check the ProTect Plus™ feature.</li> </ul>
Will not record	<ul style="list-style-type: none"> <li>• Safety tab removed from cassette.</li> <li>• Make sure the line indicator (L) is turned off in VCR's display panel for normal recording from the VCR's tuner. Press INPUT on the remote to turn the line input off.</li> <li>• Check the ProTect Plus™ feature.</li> </ul>
Rewind does not operate	<ul style="list-style-type: none"> <li>• Tape already rewind.</li> </ul>

# Trouble Checks

Trouble	Here's what to try:
VCR Plus+ or timer recording not made or wrong program recorded	<ul style="list-style-type: none"> <li>• Wrong VCR plus+ code entered.</li> <li>• Cable box was not turned on at time recording was to begin.</li> <li>• Program entered incorrectly (wrong channel or times).</li> <li>• Power interruption. Reset clock. <i>See pages 8-9.</i></li> <li>• Check to see if time and date are correct — including AM/PM.</li> <li>• Program exceeded tape's length or tape was not rewound beforehand.</li> <li>• VCR was not turned off at the time recording was to start.</li> <li>• No tape in VCR or cassette's safety tab broken off.</li> </ul>
Clock shows incorrect time or date	<ul style="list-style-type: none"> <li>• Power interruption. Clock on the front panel will show -- --.</li> <li>• Clock was not set accurately (check AM/PM and date). <i>See pages 8-9.</i></li> <li>• Time zone or daylight saving time information incorrect. <i>See pages 8-9.</i></li> <li>• Check with the broadcast station or cable company if Auto Clock Set feature is turned on and time is still inaccurate by a few minutes.</li> </ul>
Time did not adjust for daylight savings.	<ul style="list-style-type: none"> <li>• Make sure Daylight Savings Time feature is turned on.</li> </ul>
VCR makes noise when stopped	<ul style="list-style-type: none"> <li>• VCR is removing tape from heads. This is normal. The head cylinder inside the VCR continues to rotate for a few minutes after you put the VCR in the stop mode.</li> </ul>
Will not AUTO-SEARCH active channels correctly	<ul style="list-style-type: none"> <li>• Check antenna connections.</li> <li>• Check SIGNAL TYPE: CABLE/ANTENNA feature. <i>See page 10.</i></li> </ul>
Cannot select channels over 69	<ul style="list-style-type: none"> <li>• Cable channels over 69 can only be selected if SIGNAL TYPE: CABLE/ANTENNA feature is set to CABLE. <i>Details are on page 10.</i></li> </ul>
Cassette with safety tab removed does not start to play automatically	<ul style="list-style-type: none"> <li>• Set AUTO PLAY ON/OFF feature to ON. <i>Details are on page 16.</i></li> </ul>
Tape plays back in slow motion	<ul style="list-style-type: none"> <li>• Press SLOW +/- or PLAY to return to normal playback.</li> </ul>
TIMER indicator flashes	<ul style="list-style-type: none"> <li>• Timer recording programmed and no cassette in VCR.</li> </ul>
Time counter disappears while searching	<ul style="list-style-type: none"> <li>• This is normal.</li> </ul>
On-screen menus in English, French, or Spanish	<ul style="list-style-type: none"> <li>• Check language feature in "Startup" section.</li> </ul>
VCR forwards through commercials or momentarily displays a blue screen during playback	<ul style="list-style-type: none"> <li>• COMMERCIAL▶▶ADVANCE™ CA PLAYBACK feature set to AUTO. <i>See pages 21-22.</i></li> </ul>
VCR forwards through a rental or pre-recorded tape displaying a blue screen	<ul style="list-style-type: none"> <li>• Some tapes use special control track marking. Set the COMMERCIAL▶▶ADVANCE™ CA PLAYBACK feature, in the PREFERENCES menu to MANUAL.</li> </ul>
COMMERCIAL▶▶ADVANCE™ feature does not mark commercials	<p>The commercial advance feature does not mark commercials under the following situations:</p> <ul style="list-style-type: none"> <li>• CA Marking: ON/OFF feature set to OFF. <i>See page 21.</i></li> <li>• Recording is less than 15 minutes.</li> <li>• A single isolated commercial cannot be marked.</li> <li>• Recording started in the middle of a commercial segment.</li> <li>• The commercial is longer than one minute.</li> <li>• A commercial group within the first or last two minutes of a recording.</li> <li>• It does not mark commercials between 30-and-45 seconds and 45-and-60 seconds.</li> <li>• Accuracy and effectiveness can vary depending upon program content and the characteristics of the commercials.</li> <li>• Effectiveness may vary when local television stations insert their own commercials.</li> </ul>
Commercials recorded even though COMMERCIAL▶▶ADVANCE™ feature was turned on.	<ul style="list-style-type: none"> <li>• COMMERCIAL▶▶ADVANCE™ is designed to record the commercials, mark them, and then skip over the marked commercials during playback.</li> </ul>

## Questions and Answers About COMMERCIAL▶▶ADVANCE™

Question	Answer
Will commercials be scanned through only on playback of recordings?	Yes. The VCR does not rewind and mark commercial segments until after recording is finished.
How fast does the COMMERCIAL▶▶ADVANCE™ VCR scan through the commercial breaks?	In SLP tape speed, a 3-minute commercial break is scanned through in approximately 8-12 seconds. In SP, it takes about 25-35 seconds.
Are commercials still recorded if I want to watch them?	Yes. The recorded program, including commercials, can be viewed by setting the CA PLAYBACK feature to MANUAL.
What if the VCR scans forward through part of my program?	Simply rewind the tape to just before the skipped segment, and press PLAY to view the program.
Once a recording has been marked, does COMMERCIAL▶▶ADVANCE™ work each time the tape is played?	Yes. If the CA PLAYBACK feature is set to AUTO, the marked commercials should be skipped each time the tape is played in a COMMERCIAL▶▶ADVANCE™ VCR.
After marking commercials, is the tape left at the beginning or end of the recording?	The tape is left at the end of the recording so it is in position to begin additional programmed recordings.
Does the marking process interfere with other programmed recordings?	No. If two or more recordings are programmed together without sufficient time to mark the first recording, marking will take place after all recordings have completed.
What happens if the marking process is interrupted?	Marking can be interrupted to allow use of the VCR. Marking will resume again when the VCR's power is turned off as long as the tape has not been ejected from the VCR.
Does COMMERCIAL▶▶ADVANCE™ work in all recording speeds?	Yes, COMMERCIAL▶▶ADVANCE™ works in SP and SLP.
Will COMMERCIAL▶▶ADVANCE™ marked recordings work in non-COMMERCIAL▶▶ADVANCE™ VCRs?	A COMMERCIAL▶▶ADVANCE™ marked recording will play in a non-COMMERCIAL▶▶ADVANCE™ VCR, but commercials will not automatically be skipped.

## Specifications

<b>Format:</b>	VHS
<b>Record/Playback System:</b>	Video: 4-Head Audio: Mono record/playback system
<b>Video Signal System:</b>	EIA standard: NTSC color
<b>Antenna:</b>	75-ohm external VHF/UHF combined antenna terminal
<b>Tuner:</b>	USA: 181 channels capability* (125 cable channels) Canada: 178 channels capability* (122 cable channels)
<b>Type:</b>	AutoProgramming frequency synthesis
<b>Power Requirement:</b>	120V AC, 60 Hz
<b>Power Consumption:</b>	18 watts
<b>Dimensions:</b>	3.5 inches high (89 mm) 15 inches wide (380 mm) 11.2 inches deep (285 mm)
<b>Weight:</b>	8.2 pounds (3.7 kg)
<b>Storage Temperature Range:</b>	- 22°F to +149°F (-30°C to +65°C)
<b>Operating Temperature Range:</b>	+41°F to +104°F (+5°C to +40°C)

\*Check your cable company's compatibility requirements.

## Cleaning the VCR

Use a soft cloth or dusting attachment of your vacuum cleaner to dust your VCR. Remove dust from the ventilation holes on the top, back, sides, and bottom of the cabinet.

Plastic surfaces are easily scratched and can be marred by alcohol and various solvents. Avoid excessive use of oil-based furniture polishes since the materials used in the cabinet will accumulate more dust. We recommend using a non-abrasive, anti-static cleaner and polisher.

## Limited Warranty

### What your warranty covers:

- Any defect in material or workmanship.

### For how long after your purchase:

- Ninety days for labor charges.
- One year for parts.  
The warranty period for rental units begins with the first rental or 45 days from date of shipment to the rental firm, whichever comes first.

### What we will do:

- Pay any Authorized RCA VCR Servicenter the labor charges to repair your VCR.
- Pay any Authorized RCA VCR Servicenter for the new or, at our option, refurbished replacement parts required to repair your VCR.

### How you get service:

- Take your VCR to any Authorized RCA VCR Servicenter. To identify your nearest Authorized RCA VCR Servicenter, ask your dealer, look in the Yellow Pages, or call 1-800-336-1900.
- Show the service technician your evidence of purchase date.
- Pick up your VCR when repairs are completed.

### What your warranty does not cover:

- Customer instruction. (Your Owner's Manual clearly describes how to install, adjust, and operate your VCR. Any additional information should be obtained from your Dealer.)
- Installation and related adjustments.
- Signal reception problems not caused by your VCR.
- Damage from misuse or neglect.
- Cleaning of video/audio heads.
- Remote control batteries.
- A VCR that has been modified or incorporated into other products or is used for institutional or other commercial purposes.
- A VCR purchased or serviced outside the USA.
- Acts of God, such as but not limited to lightning damage.

### Product Registration:

- Please complete and mail the *Product Registration Card* packed with your VCR. It will make it easier to contact you should it ever be necessary. The return of the card is not required for warranty coverage.

### How state law relates to this warranty:

- This warranty gives you specific legal rights, and you also may have other rights that vary from state to state.

### If you purchased your VCR outside the United States:

- This warranty does not apply. Contact your dealer for warranty information.



## Index

- + and - Buttons .....12,13,17
- 3CH.4 Switch.....3-6,7,11,33
- Accessories, Included .....7
- Add or Remove Channels from
  - Memory .....10
- ADD/REMOVE CHANNEL Menu.....10
- ALERT SOUND Feature .....11
- Antenna Connections.....2,3
- ANTENNA Signal .....10
- AUDIO1/VIDEO1 IN Jacks .....6,29,33
- AUDIO1/VIDEO1 OUT Jacks.....3-5,33
- AUTO CHANNEL SEARCH .....10
- AUTO CLOCK SET .....8,9
- AUTO, Display Panel .....11
- AUTO PLAY Feature .....16
- Automatic Tracking.....20
- Back Panel.....33
- Batteries, Inserting in Remote .....7
- BLANK SEARCH Feature.....20
- BRIGHT, Display Panel .....11
- CABLE Button .....12,15
- CABLE Signal .....10
- Cable Box Function Buttons .....12,13,15
- Cable Box, Programming Remote .....15
- Cable System With Cable Box
  - Connections .....2,4,5
- Cable System Without Cable Box
  - Connections .....2,3
- Card, Registration.....i
- CF DISPLAY Feature.....22
- CF MARKING Feature.....21
- CF PLAYBACK Feature .....22
- CHAN Up or Down Buttons.....12-15
- CHANNEL Buttons.....31
- Checking Timer Recordings.....29
- Checks, Trouble.....34,35
- Child Lock Feature .....29
- Choosing a Hookup.....2
- Cleaning the VCR .....37
- CLEAR Button.....10,12,13,25-29
- Clearing VCR Plus+ or
  - Timer Recordings.....29
- Clock Setting, Manually.....9
- COMMERCIAL▶ADVANCE™
  - Recording and Playback .....21,22
  - Questions and Answers About.....36
- Connections.....2-6
  - Antenna .....2,3
  - Audio/Video Jacks.....2,3-6
  - Cable-TV .....2,4,5
  - Two VCRs .....6
- Contents .....1
- Controlling a
  - Cable Box .....15
  - Satellite Receiver.....15
  - TV .....14
- Copying Tape, Connections .....6
- Copying and Editing Tapes.....30
- Date and Time, Setting.....9
- Daylight Savings Time.....9
- Design Specifications.....37
- DIM, Display Panel .....11
- DISPLAY Button .....12,18
- Display Panel.....11,32
- Editing and Copying Tapes.....30
- EJECT•STOP Button .....16,31
- English Language .....10
- F.ADV (Frame Advance)•SLOW
  - Button .....12,20
- FF (Fast Forward) Button .....12,17,19,20
- FWD (Fast Forward) Button.....17,19,20,31
- Frame Advance Feature.....12,20
- Français.....10
- French Language.....10
- Front Panel.....31
- Hookups
  - Antenna .....2,3
  - Audio/Video Jacks.....2,3-6
  - Cable-TV .....2,4,5
  - Two VCRs .....6
- IN FROM ANT. Connector .....3-6,33
- INDEX SEARCH .....19
- INPUT Button .....12,29,30,33
- LANGUAGE Menu.....10
- Language, Selecting.....10
- Langue .....10
- Limited Warranty .....38
- Line Input, Recording From.....29
- Location of Controls
  - Back Panel.....33
  - Display Panel.....32
  - Front Panel.....31
  - Remote Control .....12,13
- LP Speed.....23
- Manual Tracking.....20
- MENU Button .....8-11,12
- Normal Recording.....23
- Number Buttons .....12-15,25,28
- One Touch Recording .....24
- OUT TO TV Connector .....3-6,33
- PANEL DISPLAY Feature.....11
- PAUSE Button.....12,17,29,30
- Pause for Stop Action.....17
- Pause, Recording.....29
- Picture Search.....17
- PLAY Button .....12,16,17,30
- PLAY•PAUSE Button .....16,17,30,31
- Playing a Tape.....16-20
- POWER Button .....12,31
- POWER Indicator.....32
- PREV CH Button.....12
- Programming Remote for
  - Cable Box .....15
  - Satellite Receiver.....15
  - TV .....14
  - VCR.....30
- ProTect Plus™.....29
- REC Button.....12,13,23,24,30
- RECORD Button.....23,24,30,31
- Recording
  - Express.....24
  - From Another VCR.....30
  - Normal.....23
  - One Program While Watching Another.....23
  - Pause.....29
  - Speeds.....23
  - Timer.....28
  - VCR Plus+ .....25-27

## Index

Registration Card.....	i
REMOTE CONTROL Feature.....	30
Remote Control.....	12,13
Remote Sensor.....	31
Remove or Add Channels from Memory.....	10
Review Programs Feature.....	29
REW Button.....	12,13,19,31
Safety Precautions.....	i
Satellite Receiver, Programming the Remote.....	15
SEARCH Button.....	12,13,19,20
Searching, Picture.....	17
Sensor, Remote.....	31
Setting Auto Clock.....	8,9
Daylight Savings Time.....	9
Time and Date.....	9
Time Zone.....	8
Timer Recording.....	28
Up the VCR.....	7-11
VCR Plus+ Recording.....	24
SIGNAL TYPE Feature.....	10
SLOW +/- Button.....	12,13,17
Slow Motion.....	17
SLP Speed.....	23
Solving Problems.....	34,35
SOUND ALERT Feature.....	11
SP Speed.....	23
Spanish Language.....	10
Specifications.....	37
SPEED Button.....	12,13,23,24,28
Speeds, Recording.....	23
STOP Button.....	12,13,16,30
STOP•EJECT Button.....	16,30,31
Stopping a Recording.....	24,27,28
Table of Contents.....	1
Time and Date, Setting.....	9
Time Counter.....	18
TIMER Indicator.....	27,28,32
Time Auto Clock Set.....	8,9
Counter.....	18
Daylight Savings.....	9
Setting.....	8,9
Zone.....	8
Timer Recording Checking and Clearing.....	29
Front VCR Line Input.....	29
Recording.....	28
Setting.....	28
Stopping.....	28
Tracking, Automatic and Manual.....	20
TRACKING Buttons.....	12,13,20,31
Trouble Checks.....	34,35
TV Button.....	12-14
TV Function Buttons.....	12-14
TV•VCR Button.....	3-6,11,23,31
VCR Button.....	12,30
VCR1 Button.....	30
VCR2 Button.....	30
VCR Controls.....	31,33
VCR, Cleaning.....	37
VCR Function Buttons.....	12,13
VCR Indicator.....	7,32
VCR Plus+ Recording Checking or Clearing.....	29
Setting.....	27
Setup.....	25,26
Stopping.....	27
VCR, Turn On.....	8
VCRs Memory, Placing Channels.....	10
VCRs, Connecting for Tape Copying.....	6
VIDEO1 IN Jacks.....	6,30,33
VIDEO1 OUT Jacks.....	3-5,33
Warning.....	11
Warranty, Limited.....	38
Zero Search.....	19



For your nearest Home  
Entertainment Dealer  
or Authorized Servicenter  
call toll-free in the U.S.A.

1-800-336-1900

Canadian Consumers –  
Your toll free numbers are:

English: 1-800-522-0338

French: 1-800-522-0445

If you would like a copy of this manual in French, please follow the  
instructions below:

Si un livret d'instructions en français n'est pas inclus avec votre appareil, vous  
pouvez en obtenir un (indiquer le numéro de modèle, votre nom, et votre  
adresse) en vous adressant à:

Thomson Consumer Electronics  
Attention: Canadian Operations  
P.O. Box 0944  
Indianapolis, IN 46206-0944

Please do not send any products to the Indianapolis address listed  
in this manual or on the carton. This will only add delays in service  
for your product.

 **THOMSON CONSUMER ELECTRONICS**  
**10330 North Meridian Street**  
**Indianapolis, IN 46290-1024**

©1996 Thomson Consumer Electronics, Inc.

Trademark(s)<sup>®</sup> Registered

Marca(s) Registrada(s)

Printed in Japan

**Part Number 96-VR562-1**

VQTS3229 (A)