

Use & Care Guide

Kenmore®

Gas Range

#,* = color number

Model: 982.7683#

Transform SR Brands Management LLC
Hoffman Estates, IL, U.S.A. 60179 U.S.A
www.kenmore.com



PRODUCT RECORD

In the space below, record the data of purchase, model and serial number of your product. You will find the model and serial number printed on an identification label located on the interior liner of the refrigerator compartment. Have these items of information available whenever you contact Sears concerning your product.

Model No. _____

Date of Purchase _____

Serial No. _____

Save these instructions and attach your sales receipt for future reference.

Kenmore Limited Warranty

Kenmore® products are sold and distributed by Kenmore and Kenmore authorized distributors and licensees in various countries.

For information on the limited warranty and authorized provider applicable to your product and country please visit: <https://www.kenmore.com/warranty-information/>

For a printed copy please contact us at 1-844-553-6667 or at the address below:

*ATTN: Kenmore Warranty Request
5407 Trillium Suite B120
Hoffman Estates, IL 60192*

RANGE SAFETY

WARNING



Fire Hazard

If the information in this manual is not followed exactly, a fire or explosion may result causing property damage, personal injury or death.

- Do not store or use gasoline or other flammable vapors and liquids in the vicinity of this or any other appliance.
- **WHAT TO DO IF YOU SMELL GAS**
 - Do not try to light any appliance.
 - Do not touch any electrical switch.
 - Do not use any phone in your building.
 - Clear the room, building, or area of all occupants.
 - Immediately call your gas supplier from a neighbor's phone. Follow the gas supplier's instructions.
 - If you cannot reach your gas supplier, call the fire department.
- Installation and service must be performed by a qualified installer, service agency or the gas supplier.

WARNING

Never Operate the Top Surface Cooking Section of this Appliance Unattended.

- Failure to follow this warning statement could result in fire, explosion, or burn hazard that could cause property damage, personal injury, or death.
- If a fire should occur, keep away from the appliance and immediately call your fire department.

DO NOT ATTEMPT TO EXTINGUISH AN OIL/GREASE FIRE WITH WATER

WARNING



Tip Over Hazard

- A child or adult can tip the range and be killed.
- Install anti-tip bracket to floor or wall per installation instructions.
- Slide range back so rear range foot is engaged in the slow of the anti-top bracket.
- Re-engage the anti-tip bracket if range is moved.
- Do not operate the range without anti-tip bracket installed and engaged.
- Failure to follow these instructions can result in death or serious burns to children and adults.

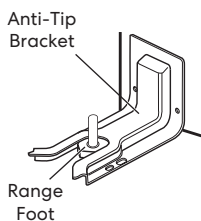

Making sure the anti-tip bracket is installed:

- Slide range forward.
- Look for the anti-tip bracket securely attached to floor and wall.
- Slide range back so rear range foot is under anti-tip bracket.

 WARNING Gas leaks cannot always be detected by smell.

Gas suppliers recommend that you use a gas detector approved by UL or CSA.

For more information, contact your gas supplier.

 WARNING Do not install a ventilation system that blows air downward toward this cooking appliance. This type of ventilation system may cause ignition and combustion problems with this cooking appliance resulting in personal injury or unintended operation.

Your safety and the safety of others are very important.

We have provided many important safety messages in this manual and on your appliance. Always read and obey all safety messages.



This is the safety alert symbol.

This symbol alerts you to potential hazards that can kill or hurt you and others.

All safety messages will follow the safety alert symbol and either the word "DANGER," "WARNING" or "CAUTION." These words mean:

 **DANGER**

You can be killed or seriously injured if you don't immediately follow instructions.

 **WARNING**

You can be killed or seriously injured if you don't follow instructions.

 **CAUTION**

A potentially hazardous situation which, if not avoided, could result in minor or moderate injury.

All safety messages will tell you what the potential hazard is, tell you how to reduce the chance of injury, and tell you what can happen if the instructions are not followed.

In the State of Massachusetts, the following installation instructions apply:

- Installations and repairs must be performed by a qualified or licensed contractor, plumber, or gasfitter qualified or licensed by the State of Massachusetts.
- If using a ball valve, it shall be a T-handle type.
- A flexible gas connector, when used, must not exceed 3 feet.

State of California Proposition 65 Warnings:

 **WARNING** This product can expose you to chemicals including lead and bisphenol A(BPA), which are known to the state of California to cause birth defects or other reproductive harm. For more information go to www.P65Warnings.ca.gov

IMPORTANT SAFETY INSTRUCTIONS

⚠ WARNING To reduce the risk of fire, electrical shock, injury to persons, or damage when using the range, follow basic precautions, including the following:

- **⚠ WARNING** TO REDUCE THE RISK OF TIPPING OF THE RANGE, THE RANGE MUST BE SECURED BY PROPERLY INSTALLED ANTI-TIP DEVICES. TO CHECK IF THE DEVICES ARE INSTALLED PROPERLY, SLIDE RANGE COMPLETELY FORWARD, LOOK FOR ANTI-TIP BRACKET SECURELY ATTACHED TO THE FLOOR OR WALL, AND SLIDE RANGE BACK SO THE REAR RANGE FOOT IS UNDER ANTI-TIP BRACKET.
- **⚠ WARNING** NEVER use this appliance as a space heater to heat or warm the room. Doing so may result in carbon monoxide poisoning and overheating of the oven.
- **⚠ WARNING** NEVER cover any slots, holes or passages in the oven bottom or cover an entire rack with materials such as aluminum foil. Doing so blocks airflow through the oven and may cause carbon monoxide poisoning. Aluminum foil linings may also trap heat, causing a fire hazard.
- **⚠ CAUTION** Do not store items of interest to children in cabinets above a range or on the back guard of a range – children climbing on the range to reach items could be seriously injured.
- Do Not Leave Children Alone – Children should not be left alone or unattended in area where range is in use. They should never be allowed to sit or stand on any part of the range.
- Wear Proper Apparel – Loose-fitting or hanging garments should never be worn while using the range.
- User Servicing – Do not repair or replace any part of the range unless specifically recommended in the manual. All other servicing should be referred to a qualified technician.
- Storage in or on Range – Flammable materials should not be stored in an oven or near surface units.
- This appliance is not intended for storage.

READ AND SAVE THESE INSTRUCTIONS

IMPORTANT SAFETY INSTRUCTIONS

- Do Not Use Water on Grease Fires – Smother fire or flame or use dry chemical or foam-type extinguisher.
- Use Only Dry Potholders – Moist or damp potholders on hot surfaces may result in burns from steam. Do not let potholder touch hot heating elements. Do not use a towel or other bulky cloth.
- Never Leave Surface Units Unattended at High Heat Settings – Boilover causes smoking and greasy spillovers that may ignite.
- Glazed Cooking Utensils – Only certain types of glass, glass/ceramic, ceramic, earthenware, or other glazed utensils are suitable for range-top service without breaking due to the sudden change in temperature.
- Utensil Handles Should Be Turned Inward and Not Extend Over Adjacent Surface Units – To reduce the risk of burns, ignition of flammable materials, and spillage due to unintentional contact with the utensil, the handle of a utensil should be positioned so that it is turned inward, and does not extend over adjacent surface units.
- Disconnect power before servicing.
- Proper Installation – The appliance, when installed, must be electrically grounded in accordance with local codes, or in the absence of local codes, with the National Electrical Code, ANSI/NFPA 70 or the Canadian Electrical Code, CSA C22.1-02. In Canada, the appliance must be electrically grounded in accordance with Canadian Electrical Code. Be sure your appliance is properly installed and grounded by a qualified technician.
- Injuries may result from misuse of appliance doors or drawers such as stepping, leaning, or sitting on the doors or drawers.
- Maintenance – Keep range area clear and free from combustible materials, gasoline, and other flammable vapors and liquids.
- Do not let cooking grease or other flammable materials accumulate in or near the range. Grease in the oven or on the cooktop may ignite.
- Top burner flame size should be adjusted so it does not extend beyond the edge of the cooking utensil. This instruction is based on safety considerations.

READ AND SAVE THESE INSTRUCTIONS

IMPORTANT SAFETY INSTRUCTIONS

- | | |
|--|--|
| <ul style="list-style-type: none">• Do not use replacement parts that have not been recommended by the manufacturer (e.g. parts made at home using a 3D printer).• Clean Cooktop With Caution – If a wet sponge or cloth is used to wipe spills on a hot cooking area, be careful to avoid steam burn. Some cleaners can produce noxious fumes if applied to a hot surface.• Use Care When Opening Door – Let hot air or steam escape before removing or replacing food.• Do Not Heat Unopened Food Containers – Build-up of pressure may cause container to burst and result in injury.• Keep Oven Vent Ducts Unobstructed.• Never broil with door open. Open-door broiling is not permitted due to overheating of control knobs.• Placement of Oven Racks – Always place oven racks in desired location while oven is cool. If rack must be moved while oven is hot, do not let potholder contact hot heating element in oven. | <ul style="list-style-type: none">• Care must be taken to prevent aluminum foil and meat probes from contacting heating elements.• DO NOT TOUCH HEATING ELEMENTS OR INTERIOR SURFACES OF OVEN – Heating elements may be hot even though they are dark in color. Interior surfaces of an oven become hot enough to cause burns. During and after use, do not touch, or let clothing or other flammable materials contact heating elements or interior surfaces of oven until they have had sufficient time to cool. Other surfaces of the appliance may become hot enough to cause burns – among these surfaces are cooktop, burners, grates, oven vent openings and surfaces near these openings, oven doors, windows of oven doors, and crevices around the oven doors.• Top burner flame size should be adjusted so it does not extend beyond the edge of the cooking utensil.• Have the installer show you the location of the range gas shut-off valve and how to turn it off if necessary. |
|--|--|

READ AND SAVE THESE INSTRUCTIONS

IMPORTANT SAFETY INSTRUCTIONS

- Proper Disposal of Your Appliance – Dispose of or recycle your appliance in accordance with Federal and Local Regulations. Contact your local authorities for the environmentally safe disposal or recycling of your appliance.

For units with ventilating hood –

- Clean Ventilating Hoods Frequently – Grease should not be allowed to accumulate on hood or filter.
- When flambé cooking under the vent hood, turn the fan on.

For self-cleaning ranges –

- Do Not Clean Door Gasket – The door gasket is essential for a good seal. Care should be taken not to rub, damage, or move the gasket.
- Do Not Use Oven Cleaners – No commercial oven cleaner or oven liner protective coating of any kind should be used in or around any part of the oven.
- Clean Only Parts Listed in Manual.
- Before Self-Cleaning the Oven – Remove broiler pan and other utensils. Wipe off all excessive spillage before initiating the cleaning cycle.

READ AND SAVE THESE INSTRUCTIONS

OVERVIEW

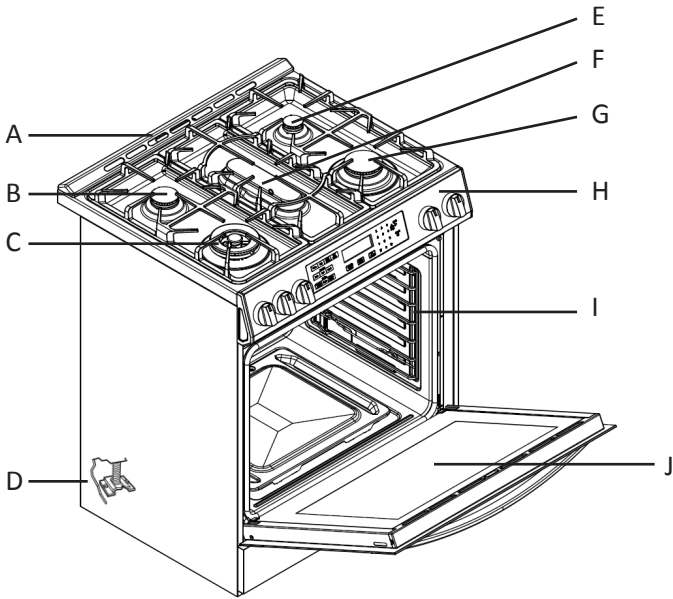

- A Backsplash
- B Semi-Rapid Burner
- C Triple Burner
- D Anti-tip Bracket
- E Auxiliary Burner
- F Oval Burner
- G Rapid Burner
- H Control Panel
- I Oven Rack Positions
- J Oven Door Window

BURNER LAYOUT

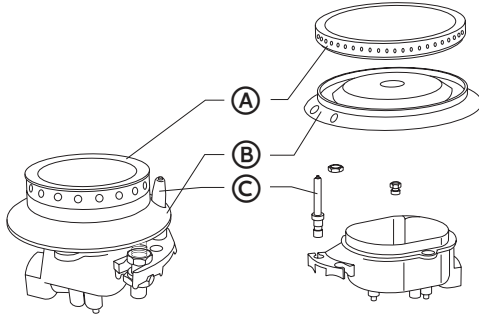

Ⓐ Burner Cap

Ⓑ Burner Head

Ⓒ Electrode

CONTROL PANEL

Surface Burner Controls



Oven/Clock/Timer Controls

CLOCK & Timer

SETTING THE CLOCK

IMPORTANT: Clock must be set in order for the timed oven functions to work.

NOTE: In the event of a power failure, all settings including the clock time set will be lost. When the power is returned, clock must be set again.

TO SET THE TIME OF DAY

When the power is connected or after a power outage, the screen will display 12.00

Clock

1. Press “Settings” repeatedly until the display show “--:-- Timed”.
2. Press numbers to enter the time.
3. Press “Start” to save.

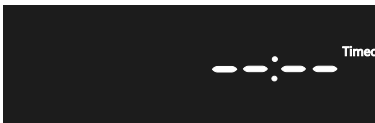

TO SET THE TIMER

The digital countdown timer can be set up to 11 hours and 59 minutes maximum.

1. Press the "Timer", and press numbers to enter the length of time.
2. Press "Start" to save.

Once confirmed, the current time will be shown and the countdown will begin. When the countdown is finished, press "timer" button to stop the beeping.

To view and modify the countdown time remaining, press the "timer", and press number to modify; To cancel the timer, follow the steps above to set the length of time to 0.00

TIMED COOKINGS FOR OVEN

WARNING

Food Poisoning Hazard

Do not let food sit in oven more than one hour before or after cooking. Doing so can result in food poisoning or sickness.

Foods that can easily spoil such as milk, eggs, fish, meat or poultry, should be chilled in the refrigerator first. Even when chilled, they should not stand in the oven for more than 1 hour before cooking begins, and should be removed promptly when finished cooking.

- **Cook Time**

Cook for the set length of time from now, then shut off the oven automatically.

TO SET THE COOK TIME

Press "Cook Time".

Press numbers to enter the length of time.

Press "Start" to save.

- **Delay Start**

Start cooking from the time you want.

TO SET THE DELAY START

Set the cooking function and cook time firstly.

Press "Delay Start".

Press numbers to enter the time you want to start cooking.

Press "Start" to save.

Note: The oven will start cooking from the time you set, and finish cooking when the cooking time is over.

IMPORTANT: Clock must be set in order for the timed oven functions to work.

COOKTOP USE

Read the instructions before installing or using this appliance.

1. This appliance shall be installed in accordance with the regulations in force and only used in a well-ventilated space.
2. The use of a gas-cooking appliance results in the production of heat and moisture in the room in which it is installed. Ensure that the kitchen is well ventilated: keep natural ventilation holes open or install a mechanical ventilation device (mechanical extractor hood).
3. Prolonged intensive use of the appliance may call for additional ventilation, for example opening of a window, or more effective ventilation, for example increasing the level of mechanical ventilation where present.

IGNITION AND OPERATION OF THE BURNERS

To ignite a burner, push down on the burner knob and rotate it counterclockwise until the knob indicator is aligned with the ⚡ ignite icon. Release the knob and adjust the flame intensity by further rotating the knob counterclockwise from MAX (maximum) to MIN (minimum).

NOTE: For models with a flame failure safety device - Once the flame is lit, hold the knob depressed for about 3-4 seconds until the device keeps the burner automatically lit. If the burner fails to ignite, wait one minute for the gas to dissipate before attempting to reignite.

To turn off the burner, rotate the knob clockwise until the indicator on the knob is aligned with OFF.

POWER FAILURE

In case of prolonged power failure, the surface burners can be lit manually. Hold a lit match near a burner and turn knob counterclockwise until the indicator is aligned with MAX. After the burner is lit, turn knob to desired setting.

In the case of unintentional flame extinguishing, the safety valve intervenes by shutting off the gas to the burners.

The electric igniter must not be actuated for longer than 15 seconds. Should the burner not light, or should the burner be unintentionally turned off, immediately close the burner, and wait at least 1 minute before repeating. Once ignited, adjust the flame as desired.

For lower gas consumption and a better result, use saucepans with a diameter matching the diameter of the burner, to avoid the flame coming up around the sides of the saucepan. See the Container Table. Use only flat-bottomed pans.

As soon as liquid starts to boil, turn the flame down to a level sufficient to maintain boiling.

COOKWARE

MATCH PAN DIAMETER TO FLAME SIZE

The flame should be the same size as the bottom of the pan or smaller. Do not use small pans with high flame settings as the flames can lick up the sides of the pan. Oversize pans that span two burners are placed front to rear, not side to side.

USE BALANCED PANS

Pans must sit level on the cooktop grate without rocking. Center the pan over the burner.

USE A LID THAT FITS PROPERLY

A well-fitting lid helps shorten the cooking time. Flat, heavy bottom pans provide

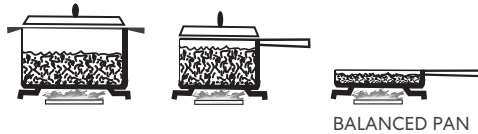

CONCAVE (HOLLOW)



CONVEX (ROUNDED)



FLAME TOO LARGE FOR PAN SIZE



USE LIDS THAT FIT PROPERLY



UNBALANCED PAN

CONTAINER TABLE

Burner	Min Saucepan	Max Saucepan
Auxiliary	3.5" (9.0 cm)	6.3" (16 cm)
Semi-rapid	5.1" (13 cm)	7.1" (18 cm)
Rapid	5.9" (15 cm)	10.2" (26 cm)
Triple ring	8.3" (21 cm)	10.2" (26 cm)

OVEN USE

WARNING

NEVER cover any slots, holes or passages in the oven bottom or cover an entire rack with materials such as aluminum foil. Doing so blocks airflow through the oven and may cause carbon monoxide poisoning. Aluminum foil linings may also trap heat, causing a fire hazard.

Reset all controls to the OFF position after using a programmable timing operation. No attempt should be made to operate the appliance during power failure.

An air curtain or other overhead range hood, which operates by blowing a downward airflow onto a range shall not be used in conjunction with a gas range.

Functions operation

Operating Mode	Default temperature (°F)	Adjustable range	Preheat phase
Bake	350	170-500	√
Broil	Hi	Lo(450) Hi(550)	×
Proof (Press for 3 seconds in warm mode temp)	100	80-120	×
Warm	140	140-210	×

Bake

Bake is used to prepare foods such as pastries, breads and casseroles. The oven can be programmed to bake at any temperature from 170 °F (80 °C) to 500 °F (260 °C). The default temperature is 350 °F (175 °C).

Broil

The Broil function uses intense heat from the upper burner to cook food. Broiling works best for tender cuts of meat, fish, and thinly cut vegetables.

WARM/PROOF

The Warm mode keeps hot, cooked foods at serving temperature. The Proof

Note: The preheating stage indicates whether real-time display of temperature is required.

There is a preheating stage: When the actual oven core temperature is less than 170°F, the interface displays Lo.

When the actual core temperature of the oven is greater than or equal to 170°F, the interface displays the temperature in real time.

When the actual oven core temperature reaches the set value, the interface always displays the settemperature value.

Non-preheating stage: the set temperature value is always displayed on the heating interface of the oven from the beginning.

Cooking Settings

1) Select the required baking function, touch the button on the display screen, the interface will light up the function options, and the default temperature and default time will appear on the display panel.

2) Click Start to Start the operation. When the actual temperature of the furnace core is lower than 170°F, the temperature digital tube only displays Lo. When the actual temperature of the furnace core is higher than 170°F, the interface needs to display the current temperature in real time. When the core temperature has reached the set value, the interface will always show that the set value no longer changes in real time.

3) To set the temperature, you can modify the temperature by touching the corresponding digital button. The number changes from right to left in turn. If it exceeds the allowed setting range, an invalid sound "didi" will be emitted when touching the Start button.

4) Set the working time, touch cook time, the time digital tube display --:-- , and blink, touch the number key, the displayed numbers change from right to left, run the setting range (0:00-11:59), if you do not set this parameter, the oven default 2 hours; If the value exceeds the allowed setting range, the next operation is not allowed, and the system makes two invalid beeps. After the Cook time is set, the system prompts you to enter Delay Start or touch start to start the operation.

5) To set the appointment function, touch Delay start to set the appointment. The default time is the current clock time. Delay start indicates when the oven starts to work. After setting, touch the Start button, and the screen will start the countdown of reservation. If the countdown time exceeds 1 hour, the screen will display in the form of hour/minute. If the countdown time is less than 1 hour, the display is displayed in the form of minutes per second.

Control panel lock function

1). When the oven is on standby, touch the "Start" button and hold for 3 seconds. The control panel is locked.

At this time, only the Start key is effective in the control panel, and other keys are invalid. When other keys are touched, the control panel lock icon on the screen blinks and an invalid tone is heard concurrently.

2). When the oven enters the working state, touch the "Start" button and hold it for 3 seconds, the control panel will be locked, except the "Start" button, other keys are invalid, the child lock icon will flash when touching other keys, if there is no unlock after 3 seconds, return to the current operating state, touch the "Start" button and hold it for 3 seconds, the control panel lock will be released, At the same time, the control panel lock symbol on the screen disappears

3). The control panel lock function is only effective in the interface of standby and mode operation, and not in other Settings interface.

Setting Function

Clock

1. Press "Settings" repeatedly until the display shows "--:-- Timed".
2. Press numbers to enter the time.
3. Press "Start" to save.



Selecting Fahrenheit or Celsius

1. Press "Settings" repeatedly until "Unit" appears in the display.
2. Press "1" to select F(Fahrenheit) or (Celsius).
3. Press "Start" to save.



Sound

1. Press "Settings" repeatedly until "Snd" appears in the display.
2. Press "1" to select On or Off.
3. Press "Start" to save.

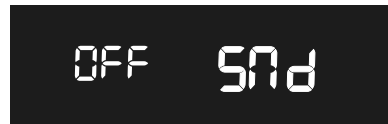
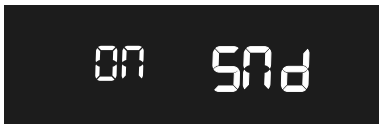

Adjusting the Oven Temperature

1. Press "Settings" repeatedly until "t_AJ" appears in the display.
2. Press "1" to select the mode you want to adjust temperature.
3. Press "3" or "6" to select the temperature.
4. Press "Start" to save.

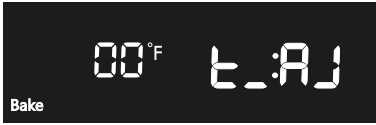

Demo mode

1. Press "Settings" repeatedly until "dEno" appears in the display.
2. Press "1" to select On or Off.
3. Press "Start" to save.



Setting the Hour Mode

1. Press "Settings" repeatedly until "12h" or "24h" appears in the display.
2. Press "1" to select "12h" or "24h".
3. Press "Start" to save.



Setting the SABBATH mode

1. Press "Settings" repeatedly until "SAbb" appears in the display.
2. Press "1" to select On or Off.
3. Press "Start" to save.

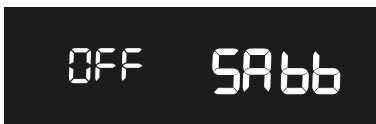

Error alarm message

Abnormal Temperature sensor: Err1

In any state, if the temperature sensor is open or short, the oven will give an alarm and display Err1. In this case, cancel can be performed.

RANGE CARE

CLEANING

IMPORTANT: Before cleaning, make sure all controls are off and the oven and cooktop are cool. Always follow label instructions on cleaning products. Soap, water and a soft cloth or sponge are suggested first unless otherwise noted. Do not use abrasive cleaning products.

EXTERIOR PORCELAIN ENAMEL SURFACES

Food spills containing acids, such as vinegar and tomato, should be cleaned as soon as the entire appliance is cool. These spills may affect the finish.

Cleaning Method:

Glass cleaner, mild liquid cleaner or nonabrasive scrubbing pad: Gently clean around the model and serial number plate because scrubbing may remove numbers.

EXTERIOR STAINLESS STEEL

NOTE: Do not use soap-filled scouring pads, abrasive cleaners, Cooktop Polishing Cream, steel-wool pads, gritty washcloths or some paper towels. Damage may occur, even with one-time or limited use.

Rub in direction of grain to avoid damaging.

Cleaning Methods:

Liquid detergent or all-purpose cleaner: Rinse well with clean water and dry with soft, lint-free cloth.

Stainless Steel Cleaner and Polish. Vinegar for hard water spots.

OVEN DOOR EXTERIOR

Cleaning Method:

Glass cleaner and paper towels or nonabrasive plastic scrubbing pad: Apply glass cleaner to soft cloth or sponge, not directly on panel.

PORCELAIN-COATED GRATES AND CAPS

- Clean as soon as cooktop, grates and caps are cool.
- Food spills containing acids, such as vinegar and tomato, should be cleaned as soon as the cooktop grates and caps are cool. These spills may affect the finish.
- To avoid chipping, do not bang grates and caps against each other or hard surfaces such as cast iron cookware.
- Do not reassemble caps on burners while wet.

Cleaning Method:

Nonabrasive plastic scrubbing pad and mildly abrasive cleanser.

BURNER SPREADER

Wash the burner spreader frequently with boiling water and detergent to remove any deposits which could block the flame outlet.

Before reinstalling, dry the burner spreader thoroughly so the burner will ignite properly.

COOKTOP CONTROL KNOBS

- Pull knobs straight away from control panel to remove.
- When replacing knobs, make sure knobs are in the Off position.

Cleaning Method:

Soap and water or dishwasher:

NOTE: Do not use steel wool, abrasive cleansers or oven cleaner. Do not soak knobs.

CONTROL PANEL

Cleaning Method:

Glass cleaner and soft cloth or sponge: Apply glass cleaner to soft cloth or sponge, not directly on panel.

NOTE: Do not use abrasive cleaners, steel-wool pads, gritty washcloths or some paper towels. Damage may occur.

OVEN CAVITY

Food spills should be cleaned when oven cools. At high temperatures, foods react with porcelain, so staining, etching, pitting or faint white spots can result.

Cleaning Method:

Mild detergent and warm water.

NOTE: Do not use oven cleaners.

OVEN RACKS AND ROASTING RACKS

Cleaning Method:

Steel-wool pad

OVEN DOOR REMOVAL

For normal oven use, there is no need to remove the oven door. However, should it become necessary to remove the door, follow the instructions in this section.

IMPORTANT:

- Make sure oven is cool and power to the oven has been turned off before removing the door.
- The oven door is heavy and fragile, and the door front is glass. To avoid oven door glass breakage, use both hands, and grasp only the sides of the oven door to remove.
- Be sure that both levers are securely in place before removing the door.
- Do not force door open or closed.

To remove the oven door:

1. Open the oven door completely.

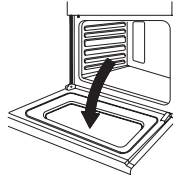

2. Lift up the hinge latch on each side.

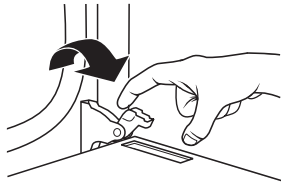

3. Close the oven door as far as it will shut.
4. While grasping both outside edges of the oven door, lift up on the door.
5. Continue to push the top of the door closed, while pulling the bottom of the door out of the hinge receivers in the door frame.

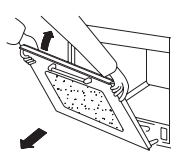

To replace the oven door:

1. Insert both hanger arms into the hinge receivers in the door frame.
2. Slowly open the oven door, and you will feel the door set into place.
3. Move the hinge latches back into the locked position.
4. Check that the door opens and closes freely. If it does not, repeat the door removal and replacement procedures.

REPLACING AN OVEN LIGHT

WARNING



Electrical Shock Hazard

Make sure the oven and lights are cool and power to the oven has been turned off before replacing the light bulb(s).

The lenses must be in place when using the oven. The lenses serve to protect the light bulb from breaking.

The lenses are made of glass. Handle carefully to avoid breakage.

Failure to do so could result in death, electric shock, cuts or burns.

The oven light is a standard 25 watt (G9) appliance bulb.

IMPORTANT: Before replacing the bulb, make sure the oven is cool and the controls are turned off.

WARNING:

1. Make sure the oven and lights are cool and power to the oven has been turned off before replacing the light bulb(s).
2. The lenses must be in place when using the oven. The lenses serve to protect the light bulb from breaking.
3. The lenses are made of glass. Handle carefully to avoid breakage.
4. Failure to do so could result in death, electric shock, cuts or burns.

REPLACING AN OVEN LIGHT

The oven light is a standard 25-watt (G9) appliance bulb.

IMPORTANT: Before replacing the bulb, make sure the oven is cool and the controls are turned off.

1. Disconnect the power.
2. Remove the bulb cover by turning it anti-clockwise.

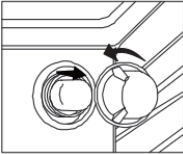

3. Remove the burned-out bulb from the socket.

NOTE: To avoid damage or decreasing the life of the new bulb, do not touch the bulb with bare fingers. Wear gloves or use a tissue when replacing the light bulb.

4. Replace the bulb, and then replace the bulb cover.
5. Reconnect the power.

TROUBLESHOOTING

First try the solutions suggested here to possibly avoid the cost of a service call.

BAKING PROBLEMS

With any oven setting poor results can occur for many reasons other than a malfunction of the oven. Check the chart below for causes of the most common problems. Since the size, shape and material of baking utensils directly affect the baking results, the best solution may be to replace old baking utensils that have darkened and warped with age and use.

PROBLEM	CAUSE
Food browns unevenly	<ul style="list-style-type: none">• Oven not preheated• Aluminum foil on oven rack or oven bottom• Baking utensil too large for recipe• Pans touching each other or oven walls
Food too brown on bottom	<ul style="list-style-type: none">• Oven not preheated• Using glass, dull or darkened metal pans• Incorrect rack position• Pans touching each other or oven walls
Food is dry or has shrunk excessively	<ul style="list-style-type: none">• Oven temperature too high• Baking time too long• Oven door opened frequently• Pan size too large
Food is baking or roasting too slowly	<ul style="list-style-type: none">• Oven temperature too low• Oven not preheated• Oven door opened frequently• Tightly sealed with aluminum foil• Pan size too small

PROBLEM	CAUSE
Piecrusts do not brown on bottom or crust is soggy	<ul style="list-style-type: none"> • Baking time not long enough • Using shiny steel pans • Incorrect rack position • Oven temperature is too low
Cakes pale, flat and may not be done inside	<ul style="list-style-type: none"> • Oven temperature too low • Incorrect baking time • Cake tested too soon • Oven door opened too often • Pan size may be too large
Cakes high in middle with crack on top	<ul style="list-style-type: none"> • Oven temperature too high • Baking time too long • Pans touching each other or oven walls • Incorrect rack position • Pan size too small
Piecrust edges too brown	<ul style="list-style-type: none"> • Oven temperature too high • Edges of crust too thin

COOKTOP PROBLEMS

PROBLEM	POSSIBLE CAUSE	SOLUTION
Burner will not ignite	There is no power to the range.	Check that range is properly connected to 3- or 4-wire, 240V power supply.
Burner will not operate	First time use. Air still in the gas line.	Turn on any one of the surface burner knobs to release air from the gas lines.
	Control knob is not set correctly.	Push in knob before turning to a setting.
	The burner port is clogged.	Clean burner port opening using a stiff, nylon toothbrush or a straightened paper clip.

PROBLEM	POSSIBLE CAUSE	SOLUTION
Burner Flames are uneven, yellow and/or noisy	Burner port(s) are clogged.	Clean burner port opening using a stiff, nylon toothbrush or a straightened paper clip.
	Burner caps are not positioned properly.	Place burner caps so that the alignment pins are properly aligned with the slots.
	Propane gas is being used.	The range should be converted to LP gas by a qualified technician.
Burner flame is too high or too low	Cooktop gas supply is not correct.	Ensure the range is set for the correct gas type. It is factory set for natural gas. If connecting to LP gas, the burners should be converted to LP gas with the orifice kit supplied and the pressure regulator converted to the LP gas setting by a qualified technician.
	The gas pressure is not correct.	Make sure the pressure regulator is installed correctly and the gas line pressure is correct. See Installation Instructions.
Burner makes popping noises	The burner is wet.	Allow the burner to dry before using.
	The burner cap or gas spreader is not positioned correctly.	Place burner caps so that the alignment pins are properly aligned with the slots.
Excessive heat around cookware on cooktop	The cookware is not the proper size for the burner.	Use cookware with a bottom surface approximately the same size as the cooking area and burner. Cookware should not extend more than 1" (2.5 cm) outside the cooking area. Adjust the flame so that it does not come up around the cookware.
Cooking results are not what expected	Using incorrect Cookware.	See the "Cookware" section.
	The control knob is not set to the proper heat level.	See the "Controls" section.

OVEN PROBLEMS

PROBLEM	POSSIBLE CAUSE	SOLUTION
Oven is not heating	No power to the range.	Check the circuit breaker or fuse box to your house. Make sure there is proper electrical power to the oven.
	Oven control not turned on.	Make sure the oven temperature has been selected.
Oven is not cooking evenly	Not using the correct bake ware or oven rack position.	Refer to cook charts for recommended rack position. Always reduce recipe temperature by 25 °F (15 °C) when baking with Convention Bake mode.
Oven display stays Off	Power interruption.	Turn off power at the main power supply (fuse or breaker box). Turn breaker back on. If condition persists, call for service.
Cooling fan continues to run after oven is turned off	The electronic components have not yet cooled sufficiently.	The fan will turn off automatically when the electronic components have cooled sufficiently.
Oven light is not working properly	Light bulb loose or burned-out.	Reinsert or replace the light bulb. Touching the bulb with fingers may cause the bulb to burn out.
Oven light stays on	Door is not closing completely	Check for obstruction in oven door. Check to see if hinge is bent or door switch broken.
Cannot remove lens cover	Soil build-up around the lens cover.	Wipe lens cover area with a clean, dry towel prior to attempting to remove the lens cover.
Clock and timer are not working properly	No power to the range.	Check the circuit breaker or fuse box to your house. Make sure there is proper electrical power to the oven.

PROBLEM	POSSIBLE CAUSE	SOLUTION
Excessive Moisture		When using bake mode, preheat the oven first. Convection Bake and Convection Roast will eliminate any moisture in the oven.
Porcelain Chips	Porcelain interior is chipped by oven racks	When removing and replacing oven racks, always tilt racks upward and do not force them to avoid chipping the porcelain.

Kenmore®

For Customer Care go to:

www.kenmore.com/contact-us/

to select your local area or retailer where this appliance was purchased for contact information on scheduling in-home repair service or ordering replacement parts.

Translate above in French and Spanish, fit centered to one-page

