



# User Guide

Electric Range

THANK YOU for purchasing this high-quality product. Register your range at [www.jennair.com](http://www.jennair.com). In Canada, register your range at [www.jennair.ca](http://www.jennair.ca).

For future reference, please make a note of your product model and serial numbers. These can be found on the label located on the oven frame behind the top right side of the oven door.

Model Number \_\_\_\_\_ Serial Number \_\_\_\_\_

Para una versión de estas instrucciones en español, visite [www.jennair.com](http://www.jennair.com).

Deberá tener a mano el número de modelo y de serie, que están ubicados en el marco del horno, detrás del lado derecho superior de la puerta del horno.

## Table of Contents

<b>RANGE SAFETY</b> .....	<b>2</b>
The Anti-Tip Bracket .....	2
<b>KEY USAGE TIPS</b> .....	<b>4</b>
AquaLift® Self-Cleaning Technology .....	4
Surface Temperatures .....	4
Preheating .....	4
Ceramic Glass Cooktop Cleaning .....	4
<b>FEATURE GUIDE</b> .....	<b>5</b>
Electronic Oven Controls .....	7
<b>COOKTOP</b> .....	<b>9</b>
Cookware .....	11
Home Canning .....	11
<b>OVEN</b> .....	<b>12</b>
Aluminum Foil.....	12
Positioning Racks and Bakeware .....	12
Roll-Out Rack.....	13
Oven Vent .....	14
Sabbath Mode.....	14
Baking and Roasting.....	14
Broiling.....	14
Convection Cooking .....	15
Proofing Bread .....	15
Favorite.....	15
Cook Time .....	16
Baking Drawer.....	16
Oven Light .....	16
<b>RANGE CARE</b> .....	<b>17</b>
Clean Cycle .....	17
General Cleaning.....	18
Remove/Replace Drawer .....	19
<b>TROUBLESHOOTING</b> .....	<b>20</b>
<b>ACCESSORIES</b> .....	<b>22</b>
<b>WARRANTY</b> .....	<b>23</b>

# Range Safety

## Your safety and the safety of others are very important.

We have provided many important safety messages in this manual and on your appliance. Always read and obey all safety messages.



This is the safety alert symbol.

This symbol alerts you to potential hazards that can kill or hurt you and others.

All safety messages will follow the safety alert symbol and either the word "DANGER" or "WARNING."

These words mean:

**⚠ DANGER**

**You can be killed or seriously injured if you don't immediately follow instructions.**

**⚠ WARNING**

**You can be killed or seriously injured if you don't follow instructions.**

All safety messages will tell you what the potential hazard is, tell you how to reduce the chance of injury, and tell you what can happen if the instructions are not followed.

## The Anti-Tip Bracket

The range will not tip during normal use. However, the range can tip if you apply too much force or weight to the open door without having the anti-tip bracket fastened down properly.



**⚠ WARNING**

### Tip Over Hazard

**A child or adult can tip the range and be killed.**

**Verify the anti-tip bracket has been properly installed and engaged per installation instructions.**

**Re-engage anti-tip bracket if range is moved.**

**Do not operate range without anti-tip bracket installed and engaged.**

**Failure to follow these instructions can result in death or serious burns to children and adults.**

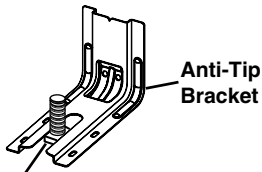

Anti-Tip Bracket

Range Foot

**To verify the anti-tip bracket is installed and engaged:**

- Slide range forward.
- Look for the anti-tip bracket securely attached to floor or wall.
- Slide range back so rear range foot is under anti-tip bracket.
- See installation instructions for details.

# IMPORTANT SAFETY INSTRUCTIONS

**WARNING:** To reduce the risk of fire, electrical shock, injury to persons, or damage when using the range, follow basic precautions, including the following:

- **WARNING:** TO REDUCE THE RISK OF TIPPING OF THE RANGE, THE RANGE MUST BE SECURED BY PROPERLY INSTALLED ANTI-TIP DEVICES. TO CHECK IF THE DEVICES ARE INSTALLED PROPERLY, SLIDE RANGE FORWARD, LOOK FOR ANTI-TIP BRACKET SECURELY ATTACHED TO FLOOR OR WALL, AND SLIDE RANGE BACK SO REAR RANGE FOOT IS UNDER ANTI-TIP BRACKET.
- **CAUTION:** Do not store items of interest to children in cabinets above a range or on the backguard of a range – children climbing on the range to reach items could be seriously injured.
- Proper Installation – Be sure the range is properly installed and grounded by a qualified technician.
- Never Use the Range for Warming or Heating the Room.
- Do Not Leave Children Alone – Children should not be left alone or unattended in area where the range is in use. They should never be allowed to sit or stand on any part of the range.
- Wear Proper Apparel – Loose-fitting or hanging garments should never be worn while using the range.
- User Servicing – Do not repair or replace any part of the range unless specifically recommended in the manual. All other servicing should be referred to a qualified technician.
- Storage in or on the Range – Flammable materials should not be stored in an oven or near surface units.
- Do Not Use Water on Grease Fires – Smother fire or flame or use dry chemical or foam-type extinguisher.
- Use Only Dry Potholders – Moist or damp potholders on hot surfaces may result in burns from steam. Do not let potholder touch hot heating elements. Do not use a towel or other bulky cloth.
- DO NOT TOUCH SURFACE UNITS OR AREAS NEAR UNITS – Surface units may be hot even though they are dark in color. Areas near surface units may become hot enough to cause burns. During and after use, do not touch, or let clothing or other flammable materials contact surface units or areas near units until they have had sufficient time to cool. Among those areas are the cooktop and surfaces facing the cooktop.
- Use Proper Pan Size – The range is equipped with one or more surface units of different size. Select utensils having flat bottoms large enough to cover the surface unit heating element. The use of undersized utensils will expose a portion of the heating element to direct contact and may result in ignition of clothing. Proper relationship of utensil to burner will also improve efficiency.
- Never Leave Surface Units Unattended at High Heat Settings – Boilover causes smoking and greasy spillovers that may ignite.
- Make Sure Reflector Pans or Drip Bowls Are in Place – Absence of these pans or bowls during cooking may subject wiring or components underneath to damage.

- Protective Liners – Do not use aluminum foil to line surface unit drip bowls or oven bottoms, except as suggested in the manual. Improper installation of these liners may result in a risk of electric shock, or fire.
- Glazed Cooking Utensils – Only certain types of glass, glass/ceramic, ceramic, earthenware, or other glazed utensils are suitable for range-top service without breaking due to the sudden change in temperature.
- Utensil Handles Should Be Turned Inward and Not Extend Over Adjacent Surface Units – To reduce the risk of burns, ignition of flammable materials, and spillage due to unintentional contact with the utensil, the handle of a utensil should be positioned so that it is turned inward, and does not extend over adjacent surface units.
- Do Not Soak Removable Heating Elements – Heating elements should never be immersed in water.
- Do Not Cook on Broken Cooktop – If cooktop should break, cleaning solutions and spillovers may penetrate the broken cooktop and create a risk of electric shock. Contact a qualified technician immediately.
- Clean Cooktop With Caution – If a wet sponge or cloth is used to wipe spills on a hot cooking area, be careful to avoid steam burn. Some cleaners can produce noxious fumes if applied to a hot surface.
- Use Care When Opening Door – Let hot air or steam escape before removing or replacing food.
- Do Not Heat Unopened Food Containers – Build-up of pressure may cause container to burst and result in injury.
- Keep Oven Vent Ducts Unobstructed.
- Placement of Oven Racks – Always place oven racks in desired location while oven is cool. If rack must be moved while oven is hot, do not let potholder contact hot heating element in oven.
- DO NOT TOUCH HEATING ELEMENTS OR INTERIOR SURFACES OF OVEN – Heating elements may be hot even though they are dark in color. Interior surfaces of an oven become hot enough to cause burns. During and after use, do not touch, or let clothing or other flammable materials contact heating elements or interior surfaces of oven until they have had sufficient time to cool. Other surfaces of the appliance may become hot enough to cause burns – among these surfaces are oven vent openings and surfaces near these openings, oven doors, and windows of oven doors.

## For self-cleaning ranges –

- Do Not Clean Door Gasket – The door gasket is essential for a good seal. Care should be taken not to rub, damage, or move the gasket.
- Do Not Use Oven Cleaners – No commercial oven cleaner or oven liner protective coating of any kind should be used in or around any part of the oven.
- Clean Only Parts Listed in Manual.
- Before Self-Cleaning the Oven – Remove broiler pan and other utensils.

## For units with ventilating hood –

- Clean Ventilating Hoods Frequently – Grease should not be allowed to accumulate on hood or filter.
- When flambeing foods under the hood, turn the fan on.

## SAVE THESE INSTRUCTIONS

## Key Usage Tips

### AquaLift® Self-Cleaning Technology



AquaLift® Self-Cleaning Technology is a first-of-its-kind cleaning solution designed to minimize the time, temperature and odors that ordinarily come with traditional self-cleaning methods. With AquaLift® Self-Cleaning Technology, an exclusive coating on the interior of the oven is activated with heat and water to release baked-on soil. To use AquaLift® Self-Cleaning Technology, simply wipe out loose debris, pour water into the oven bottom, and run the AquaLift® Self-Cleaning cycle. When the cycle finishes in under 1 hour at a lower temperature than in traditional self-cleaning methods, just wipe out the remaining water and loose debris. See the “Clean Cycle” section for more detailed instructions. For additional information, frequently asked questions, and videos on using AquaLift® Self-Cleaning Technology, visit our website at <http://whirlpoolcorp.com/aqualift>.

### Surface Temperatures

When the range is in use, all range surfaces may become hot, such as the knobs and oven door.

#### Baking Drawer

When the oven is in use, the drawer may become hot. Do not store plastics, cloth, or other items that could melt or burn in the drawer.

#### Oven Vent

The oven vent releases hot air and moisture from the oven, and should not be blocked or covered. Do not set plastics, paper or other items that could melt or burn near the oven vent.

### Preheating

When beginning a Bake, Convection Bake, or Convection Roast cycle, the oven will begin preheating after Start is pressed. The oven will take approximately 12 to 15 minutes to reach 350°F (177°C) with all of the oven racks provided with your oven inside the oven cavity. Higher temperatures will take longer to preheat. The preheat cycle rapidly increases the oven temperature. The actual oven temperature will go above your set temperature to offset the heat lost when your oven door is opened to insert food. This ensures that when you place your food in the oven, the oven will begin at the proper temperature. Insert your food when the preheat tone sounds. Do not open the door during preheat before the tone sounds.

### Ceramic Glass Cooktop Cleaning

To avoid damaging the cooktop, do not use steel wool, abrasive powder cleansers, chlorine bleach, rust remover, or ammonia.

1. Remove food/residue with the Cooktop Scraper.

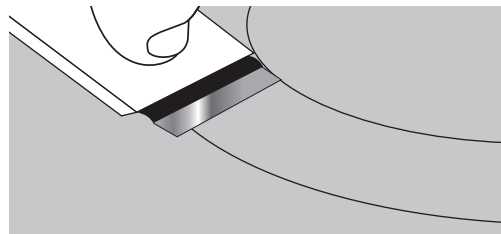

- For best results, use the Cooktop Scraper while the cooktop is still warm but not hot to the touch. It is recommended to wear an oven mitt while scraping the warm cooktop.
- Hold the Cooktop Scraper at approximately a 45° angle against the glass surface and scrape the residue. It will be necessary to apply pressure in order to remove the residue.

Allow the cooktop to cool down completely before proceeding to Step 2.

2. Apply a few dime-sized drops of affresh® Cooktop Cleaner to the affected areas.

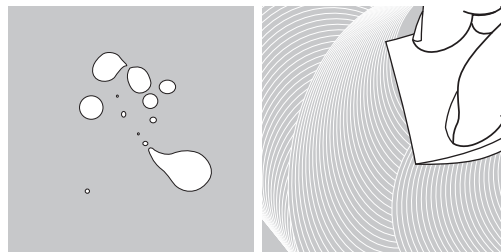

- Rub affresh® Cooktop Cleaner onto the cooktop surface with the blue Cooktop Cleaning Pad. Some pressure is needed to remove stubborn stains.
  - Allow the cleaner to dry to a white haze before proceeding to Step 3.
3. Polish with a clean, dry cloth or a clean, dry paper towel.



- Repeat steps 1 through 3 as necessary for stubborn or burned-on stains.

The Complete Cooktop Cleaner Kit is available for order including the following:

- Cooktop Scraper
- Affresh® Cooktop Cleaner
- Blue Cooktop Cleaning Pads

See the “Accessories” section for part numbers and information on ordering.

# Feature Guide

This manual covers several models. Your model may have some or all of the items listed. Refer to this manual or the Frequently Asked Questions (FAQs) section of our website at [www.jennair.com](http://www.jennair.com) for more detailed instructions. In Canada, refer to the Customer Service Section at [www.jennair.ca](http://www.jennair.ca).

## ⚠ WARNING

**Food Poisoning Hazard**

**Do not let food sit for more than one hour before or after cooking.**

**Doing so can result in food poisoning or sickness.**



KEYPAD	FEATURE	INSTRUCTIONS
OPTIONS/CLOCK	<b>Clock</b>	The Clock can use a 12- or 24-hour cycle. See the “Electronic Oven Controls” section. <ol style="list-style-type: none"> <li>1. Press OPTIONS/CLOCK until “CLOCK” is displayed.</li> <li>2. Use the number keypads to set the time of day.</li> <li>3. Press START to change the time.</li> <li>4. Press “3” for AM or “6” for PM.</li> </ol>
OPTIONS/CLOCK	<b>Settings</b>	Enables you to personalize the audible tones and oven operation to suit your needs. See the “Electronic Oven Controls” section.
LIGHT	<b>Oven cavity light</b>	The oven light is controlled by a keypad on the oven control panel. While the oven door is closed, press LIGHT to turn the light on and off. When the oven door is opened, the oven light will automatically come on.
TIMER SET/OFF	<b>Oven timer</b>	The Timer can be set in hours or minutes up to 9 hours and 59 minutes. <ol style="list-style-type: none"> <li>1. Press TIMER SET/OFF.</li> <li>2. Press the number keypads to set the length of time in hr-min-min. Leading zeros do not have to be entered. For example, for 2 minutes, enter “2.”</li> <li>3. Press TIMER SET/OFF to begin the countdown. If enabled, end-of-cycle tones will sound at end of countdown.</li> <li>4. Press TIMER SET/OFF again to cancel the Timer and return to the time of day. Do not press the CANCEL because the oven will turn off.</li> <li>5. If the Timer is running, but not in the display, press TIMER SET/OFF to display the countdown for 5 seconds.</li> </ol>
START	<b>Cooking start</b>	The Start keypad begins any oven function. If Start is not pressed within 2 minutes after pressing a keypad, the function is canceled and the time of day is displayed.
CANCEL UPPER CANCEL LOWER	<b>Range function</b>	The Cancel keypads stop any function for the appropriate oven, except the Clock and Timer.
BAKE (upper and lower oven)	<b>Baking and roasting</b>	<ol style="list-style-type: none"> <li>1. Press BAKE for the desired oven.</li> <li>2. Press the number keypads to set the desired temperature. If the temperature entered is not in the range of the temperatures allowed, the minimum or maximum allowed temperature will be displayed. Enter a temperature in the allowable range.</li> <li>3. Press START.</li> <li>4. To change the temperature, repeat steps 2 and 3.</li> <li>5. Press CANCEL for the desired oven when finished.</li> </ol>

KEYPAD	FEATURE	INSTRUCTIONS
<b>BROIL</b>	<b>Broiling</b>	<ol style="list-style-type: none"> <li>1. Press BROIL.</li> <li>2. Press the number keypads to set the desired temperature. If the temperature entered is not in the range of the temperatures allowed, the minimum or maximum allowed temperature will be displayed. Enter a temperature in the allowable range.</li> <li>3. Press START and allow the oven to preheat for 2 minutes.</li> <li>4. To change the temperature, repeat steps 2 and 3.</li> <li>5. Position the cookware in the oven, and then close the door.</li> <li>6. Press CANCEL UPPER when finished.</li> </ol>
<b>MANUAL CONVECT MODES</b>	<b>Convection cooking</b>	<ol style="list-style-type: none"> <li>1. Press MANUAL CONVECT MODES until the desired convection mode appears in the display.</li> <li>2. Press START.</li> <li>3. Press the number keypads to set the desired temperature. If the temperature entered is not in the range of the temperatures allowed, the minimum or maximum allowed temperature will be displayed. Enter a temperature in the allowable range.</li> <li>4. Press START.</li> <li>5. Insert food when prompted.</li> <li>6. To change the temperature, repeat steps 3 and 4.</li> <li>7. Press CANCEL UPPER when finished.</li> </ol>
<b>AUTO CONVECT MODES</b>	<b>Convection cooking</b>	<ol style="list-style-type: none"> <li>1. Press AUTO CONVECT MODES until the desired convection mode appears in the display.</li> <li>2. Press START.</li> <li>3. Press the number keypads to set the desired temperature. If the temperature entered is not in the range of the temperatures allowed, the minimum or maximum allowed temperature will be displayed. Enter a temperature in the allowable range.</li> <li>4. Press START.</li> <li>5. Press the number keypads to set the desired cook time.</li> <li>6. Press START.</li> <li>7. Insert food when prompted.</li> <li>8. To change the temperature, repeat steps 3 through 6.</li> <li>9. Press CANCEL UPPER when finished.</li> </ol>
<b>KEEP WARM (upper and lower oven)</b>	<b>Hold warm</b>	<p>Food must be at serving temperature before placing it in the warmed oven.</p> <ol style="list-style-type: none"> <li>1. Press KEEP WARM for the desired oven.</li> <li>2. Press the number keypads to set the desired temperature. If the temperature entered is not in the range of the temperatures allowed, the minimum or maximum allowed temperature will be displayed. Enter a temperature in the allowable range.</li> <li>3. Press START.</li> <li>4. Press CANCEL for the desired oven when finished.</li> </ol>
<b>WARM ZONE ON/OFF</b>	<b>Warming zone</b>	<p>Press COOKTOP WARM ZONE ON/OFF to select the warming element on the cooktop, and then press CONFIRM.</p> <p>Press COOKTOP WARM ZONE ON/OFF to turn off the warming element.</p>
<b>PROOF</b>	<b>Proofing bread</b>	<ol style="list-style-type: none"> <li>1. Place prepared dough in oven. Press PROOF.</li> <li>2. Press START.</li> <li>3. Let the dough rise until nearly doubled in size. Proofing time may vary depending on dough type and quantity.</li> <li>4. Press CANCEL UPPER when finished proofing.</li> </ol> <p>Refer to the "Proofing Bread" section for more information.</p>
<b>FAVORITE</b>	<b>Saved favorite</b>	<p>The Favorite keypad stores the oven mode, cook time, and temperature for your favorite recipe. To save or use favorite, see the "Favorite" section.</p>
<b>DELAY START</b>	<b>Delayed start</b>	<p>The Delay Start keypad is used to enter the starting time for an oven function with a delayed start. Delay Start should not be used for foods such as breads and cakes because they may not bake properly.</p> <p>To set a Timed Cook or a Delayed Timed Cook, see the "Cook Time" section.</p>
<b>COOK TIME</b>	<b>Timed cooking</b>	<p>Timed cooking allows the oven to be set to turn on at a certain time of day, cook for a set length of time, and/or shut off automatically.</p> <p>To set a Timed Cook or a Delayed Timed Cook, see the "Cook Time" section.</p>
<b>AQUALIFT SELF CLEAN</b>	<b>Clean cycle</b>	<p>See the "Clean Cycle" section.</p>

KEYPAD	FEATURE	INSTRUCTIONS
<b>START (hold for 3 sec to lock)</b>	<b>Oven control lockout</b>	<ol style="list-style-type: none"> <li>1. Check that the oven is OFF.</li> <li>2. Press and hold START (hold 3 sec to lock) for 3 seconds.</li> <li>3. A tone will sound, "Control Locked" will scroll, and then "Locked" will be displayed.</li> <li>4. Repeat to unlock. No keypads will function with the controls locked. The cooktop functions are not affected by the oven control lockout.</li> </ol>
<b>OPTIONS/CLOCK</b>	<b>Energy save</b>	<ol style="list-style-type: none"> <li>1. Press OPTIONS/CLOCK until "ENERGY SAVER" is displayed.</li> <li>2. The current setting will be displayed.</li> <li>3. Press the "1" keypad to adjust the setting.</li> <li>4. Press CANCEL to exit and display the time of day.</li> </ol> <p>If Energy Save is ON, the range will go into Sleep mode after 5 minutes of inactivity. Any keypad press will activate the display. If Energy Save is OFF, the display will be ON at all times.</p>

## Electronic Oven Controls

### Control Display

The display will flash when powered up or after a power loss. Press CANCEL UPPER to clear. When the oven is not in use, the time of day is displayed. If the range is in Energy Save mode, the display will be blank when not in use.

### Tones

Tones are audible signals, indicating the following:

#### One Tone

- Valid keypad press
- Oven is preheated (long tone).
- Function has been entered.
- Reminder, repeating each minute after the end-of-cycle tones

#### Three Tones

- Invalid keypad press

#### Four Tones

- End-of-cycle

Use the Options/Clock keypad to change the tone settings.

### Energy Save

The Energy Save mode puts the range into Sleep mode and reduces energy consumption.

#### To Activate the Energy Save Mode:

1. Press OPTIONS/CLOCK until "ENERGY SAVER" is displayed.
2. The current setting will be displayed.
3. Press the "1" keypad to adjust the setting.
4. Press CANCEL to exit and display the time of day.
5. The setting will be activated after 5 minutes.

#### To Deactivate the Energy Save Mode:

1. Press OPTIONS/CLOCK until "ENERGY SAVER" is displayed.
2. The current setting will be displayed.
3. Press the "1" keypad to adjust the setting.
4. Press CANCEL to exit and display the time of day.
5. The clock will reappear in the display and the range can be operated as usual.

### Settings

Many features of the oven control can be adjusted to meet your personal needs. These changes are made using the Options/Clock keypad.

Use the Options/Clock keypad to scroll through the features that can be changed. Each press of the Options/Clock keypad will advance the display to the next setting. After selecting the feature to be changed, the control will prompt you for the required input. Then press START or CANCEL UPPER to exit and display the time of day. Details of all of the feature changes are explained in the following sections.

Press CANCEL UPPER to exit Settings.

### Clock

The Clock can use a 12- or 24-hour cycle.

1. Press OPTIONS/CLOCK until "CLOCK" is displayed.
2. Use the number keypads to set the time of day.
3. Press START to change the time.
4. Press "3" for AM or "6" for PM.

### Fahrenheit and Celsius

The temperature is preset to Fahrenheit but can be changed to Celsius.

1. Press OPTIONS/CLOCK until "TEMP UNIT" is displayed.
2. The current setting will be displayed.
3. Press the "1" keypad to adjust the setting.
4. Press START or CANCEL UPPER to exit and display the time of day.

### Audible Tones Disable

Turns off all tones, including the end-of-cycle tone and keypress tones. Reminder tones are still active when all tones are disabled.

1. Press OPTIONS/CLOCK until "SOUND" is displayed.
2. The current setting will be displayed.
3. Press the "1" keypad to adjust the setting.
4. Press START or CANCEL UPPER to exit and display the time of day.

### Sound Volume

Sets the volume of the tone to either high or low.

1. Press OPTIONS/CLOCK until "SOUND VOLUME" is displayed.
2. The current setting will be displayed.
3. Press the "1" keypad to adjust the setting.
4. Press START or CANCEL UPPER to exit and display the time of day.

### End-of-Cycle Tone

Activates or turns off the tones that sound at the end of a cycle.

1. Press OPTIONS/CLOCK until "END TONE" is displayed.
2. The current setting will be displayed.
3. Press the "1" keypad to adjust the setting.
4. Press START or CANCEL UPPER to exit and display the time of day.

### KeyPress Tones

Activates or turns off the tones when a keypad is pressed.

1. Press OPTIONS/CLOCK until "KEYPRESS TONE" is displayed.
2. The current setting will be displayed.
3. Press the "1" keypad to adjust the setting.
4. Press START or CANCEL UPPER to exit and display the time of day.

### Reminder Tones Disable

Turns off the short repeating tone that sounds every 1 minute after the end-of-cycle tones.

1. Press OPTIONS/CLOCK until "REMINDER TONE" is displayed.
2. The current setting will be displayed.
3. Press the "1" keypad to adjust the setting.
4. Press START or CANCEL UPPER to exit and display the time of day.

### 12/24 Hour Clock

1. Press OPTIONS/CLOCK until "12/24 HOUR" is displayed.
2. The current setting will be displayed.
3. Press the "1" keypad to adjust the setting.
4. Press START or CANCEL UPPER to exit and display the time of day.

### Demo Mode

**IMPORTANT:** This feature is intended for use on the sales floor with 120 V power connection and permits the control features to be demonstrated without the oven turning on. If this feature is activated, the oven will not work.

1. Press OPTIONS/CLOCK until "DEMO MODE" is displayed.
2. The current setting will be displayed.
3. Press the "1" keypad to adjust the setting.
4. Press START or CANCEL UPPER to exit and display the time of day.

### Sabbath Mode

The Sabbath mode sets the oven to remain on in a bake setting until turned off.

When the Sabbath mode is set, only the Bake cycle will operate. All other cooking and cleaning cycles are disabled. No tones will sound, and the displays will not indicate temperature changes.

When the oven door is opened or closed, the oven light will not turn on or off, and the heating elements will not turn on or off immediately.

#### To Enable Sabbath Mode Capability (One Time Only):

1. Press OPTIONS/CLOCK until "SABBATH" is displayed.
2. The current setting will be displayed.
3. Press the "1" keypad to adjust the setting.
4. Press START or CANCEL UPPER to exit and display the time of day.

### 12-Hour Shutoff

The oven control is set to automatically shut off the oven 12 hours after the oven initiates a cook or clean function. This will not interfere with any timed or delay cook functions.

1. Press OPTIONS/CLOCK until "12Hr AUTO\_OFF" is displayed.
2. The current setting will be displayed.
3. Press the "1" keypad to adjust the setting.
4. Press START or CANCEL UPPER to exit and display the time of day.

### Languages - Scrolling Display Text

Language options are English, Spanish, and French.

1. Press OPTIONS/CLOCK until "LANGUAGE" is displayed.
2. The current setting will be displayed.
3. Press the "1" or "2" keypad to select the desired language.
4. Press START or CANCEL UPPER to exit and display the time of day.

### Oven Temperature Offset Control

**IMPORTANT:** Do not use a thermometer to measure oven temperature. Elements will cycle on and off as needed to provide consistent temperature but may run slightly hot or cool at any point in time due to this cycling. Most thermometers are slow to react to temperature change and will not provide an accurate reading due to this cycling.

The oven provides accurate temperatures; however, it may cook faster or slower than your previous oven, so the temperature can be adjusted to personalize it for your cooking needs. It can be changed to Fahrenheit or Celsius.

#### To Adjust Oven Temperature:

1. Press OPTIONS/CLOCK until "TEMP CALIB" is displayed.  
On some models, press "1" to adjust the drawer temperature calibration. Press START, wait 10 seconds for the display to change, and then continue with Step 3.

#### OR

- Press START to adjust the oven temperature calibration. Wait 10 seconds for the display to change, and then continue with Step 3.
2. Press the "3" keypad to increase the temperature in 5°F (3°C) increments or press the "6" keypad to decrease the temperature in 5°F (3°C) increments. The offset range is from -30°F to +30°F (-18°C to +18°C).
3. Press START or CANCEL UPPER to exit and display the time of day.



## ⚠️ WARNING



### Fire Hazard

Turn off all controls when done cooking.

Failure to do so can result in death or fire.

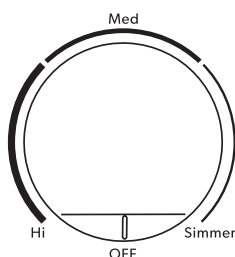

The control knobs can be set to anywhere between Hi and Lo. Push in and turn to setting.

**REMEMBER:** When range is in use, the entire cooktop area may become hot.

### Ceramic Glass

The surface cooking area will glow red when an element is ON. Some parts of the surface cooking area may not glow red when an element is ON. This is normal operation. It will also randomly cycle off and back on again, even while on Hi, to keep the cooktop from extreme temperatures.

It is normal for the surface of light colored ceramic glass to appear to change color when surface cooking areas are hot. As the glass cools, it will return to its original color.

Clean the cooktop after each use to help avoid scratches, pitting, abrasions and to condition the glass surface. Ceramic glass cooktop cleaner and a cooktop scraper are also recommended for stubborn soils. Do not use abrasive cleaners, cleaning pads or harsh chemicals for cleaning. The Cooktop Care Kit contains all of the items needed to clean and condition your ceramic glass cooktop. Refer to the "Range Care" section for additional information.

**IMPORTANT:** To avoid permanent damage to the cooktop surface and to make soils easier to remove, clean the cooktop after each use to remove all soils.

- Avoid storing jars or cans above the cooktop. Dropping a heavy or hard object onto the cooktop could crack the cooktop.
- To avoid damage to the cooktop, do not leave a hot lid on the cooktop. As the cooktop cools, air can become trapped between the lid and the cooktop and the ceramic glass could break when the lid is removed.
- For foods containing sugar in any form, clean up all spills and soils as soon as possible. Allow the cooktop to cool down slightly. Then, while wearing oven mitts, remove the spills using a scraper while the surface is still warm. If sugary spills are allowed to cool down, they can adhere to the cooktop and can cause pitting and permanent marks.
- To avoid scratches, do not slide cookware or bakeware across the cooktop. Aluminum or copper bottoms and rough finishes on cookware or bakeware could leave scratches or marks on the cooktop.
- Do not cook popcorn in prepackaged aluminum containers on the cooktop. They could leave aluminum marks that cannot be removed completely.
- To avoid damage to the cooktop, do not allow objects that could melt, such as plastic or aluminum foil, to touch any part of the entire cooktop.
- To avoid damage to the cooktop, do not use the cooktop as a cutting board.

- Use cookware about the same size as the surface cooking area. Cookware should not extend more than 1/2" (1.3 cm) outside the area.

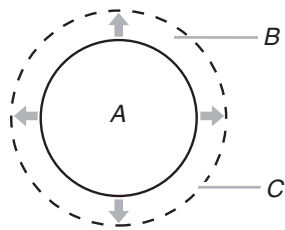

A. Surface cooking area  
B. Cookware/canner  
C. 1/2" (1.3 cm) maximum overhang

- Use flat-bottomed cookware for best heat conduction and energy efficiency. Cookware with rounded, warped, ribbed, or dented bottoms could cause uneven heating and poor cooking results.
- Determine flatness by placing the straight edge of a ruler across the bottom of the cookware. While you rotate the ruler, no space or light should be visible between it and the cookware.
- Cookware designed with slightly indented bottoms or small expansion channels can be used.
- Make sure the bottoms of pots and pans are clean and dry before using them. Residue and water can leave deposits when heated.
- To avoid damage to the cooktop, do not cook foods directly on the cooktop.

### Cooktop On Indicator Light

The Cooktop On indicator light is located on the console panel. When any control knob on the console panel is turned on, the Cooktop On indicator light will glow.

### Hot Surface Indicator Light

On ceramic glass models, the Hot Surface indicator light is located on the console panel.

The Hot Surface indicator light will glow as long as any surface cooking area is too hot to touch, even after the surface cooking area is turned off.

### Triple Zone Cooking Element

The Triple Zone cooking element offers flexibility depending on the size of the cookware. Single size can be used in the same way as a regular element. The dual and triple sizes combine the single, dual, and outer element and is recommended for larger cookware, larger quantities of food and home canning.

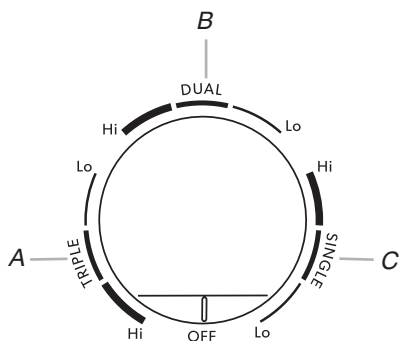

A. Triple  
B. Dual  
C. Single

### Rapid Boil Element (Right Front Element)

The Rapid Boil cooking element offers additional cooking flexibility. The Rapid Boil cooking element can be used to boil liquids faster. The lowest melt setting can be used to prepare sauces, brown or saute foods, and keep foods at a low temperature. Use cookware appropriate in size for the Rapid Boil cooking element.

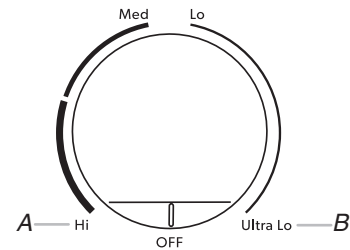

A. Rapid boil option  
B. Lower heat option

### Melt Element (Left Rear Element)

The Melt cooking element offers flexibility due to a wide range of settings between Hi and Melt. The Hi heat option can be used to boil small amounts of liquid quickly. To reduce the power setting, turn the knob clockwise. The Melt setting is designed for delicate foods that require low heat, such as when melting chocolate or holding sauces. Use cookware appropriate in size for the Melt cooking element.

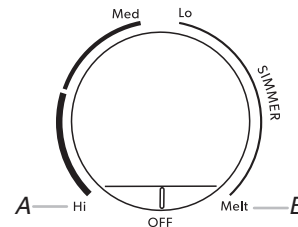

A. High heat option  
B. Melt option

### Warm Zone Element

## ⚠ WARNING

### Food Poisoning Hazard

**Do not let food sit in oven more than one hour before or after cooking.**

**Doing so can result in food poisoning or sickness.**

Use the Cooktop Warm Zone element to keep cooked foods warm. One hour is the recommended maximum time to maintain food quality.

Do not use it to heat cold foods.

The Warm Zone element can be used alone or when any of the other surface cooking areas are being used.

The Warm Zone element area will not glow red when cycling on. However, the Cooktop On indicator light will glow while the Cooktop Warm Zone element is in use.

- Use only cookware recommended for oven and cooktop use.
- Cover all foods with a lid or aluminum foil. When warming baked goods, allow a small opening in the cover for moisture to escape.
- To avoid damage to the cooktop, do not use plastic wrap to cover food because the plastic wrap may melt.
- Use pot holders or oven mitts to remove food.

## Cooktop Warm Zone



### To Use:

1. To turn on, press COOKTOP WARM ZONE ON/OFF and then CONFIRM.
2. To turn off, press COOKTOP WARM ZONE ON/OFF.

### Cookware

**IMPORTANT:** Do not leave empty cookware on a hot surface cooking area, element, or surface burner.

Ideal cookware should have a flat bottom, straight sides, and a well-fitting lid, and the material should be of medium-to-heavy thickness.

Rough finishes may scratch the cooktop. Aluminum and copper may be used as a core or base in cookware. However, when used as a base, they can leave permanent marks on the surfaces.

Cookware material is a factor in how quickly and evenly heat is transferred which affects cooking results. A nonstick finish has the same characteristics as its base material. For example, aluminum cookware with a nonstick finish will take on the properties of aluminum.

Cookware with nonstick surfaces should not be used under the broiler.

Check for flatness by placing the straight edge of a ruler across the bottom of the cookware. While you rotate the ruler, no space or light should be visible between it and the cookware.

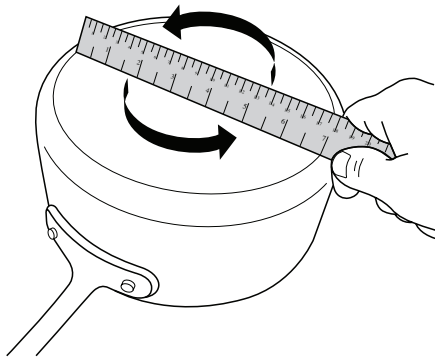

Use the following chart as a guide for cookware material characteristics.

Cookware	Characteristics
<b>Aluminum</b>	<ul style="list-style-type: none"> <li>■ Heats quickly and evenly.</li> <li>■ Suitable for all types of cooking</li> <li>■ Medium or heavy thickness is best for most cooking tasks.</li> <li>■ May leave aluminum residues which may be diminished if cleaned immediately after cooking.</li> </ul>
<b>Cast iron</b>	<ul style="list-style-type: none"> <li>■ Heats slowly and evenly.</li> <li>■ Good for browning and frying</li> <li>■ Maintains heat for slow cooking.</li> <li>■ Rough edges or burrs may scratch the cooktop.</li> </ul>
<b>Ceramic or ceramic glass</b>	<ul style="list-style-type: none"> <li>■ Follow manufacturer's instructions.</li> <li>■ Heats slowly, but unevenly.</li> <li>■ Ideal results on low to medium heat settings</li> <li>■ May scratch the cooktop.</li> </ul>

Cookware	Characteristics
<b>Copper</b>	<ul style="list-style-type: none"> <li>■ Heats very quickly and evenly.</li> <li>■ May leave copper residues, which may be diminished if cleaned immediately after cooking.</li> <li>■ Can leave a permanent stain or bond to the cooktop if overheated.</li> </ul>
<b>Earthenware</b>	<ul style="list-style-type: none"> <li>■ Follow manufacturer's instructions.</li> <li>■ Use on low heat settings.</li> <li>■ May scratch the cooktop.</li> </ul>
<b>Porcelain enamel-on-steel or cast iron</b>	<ul style="list-style-type: none"> <li>■ See stainless steel or cast iron.</li> <li>■ Porcelain enamel bakeware without the metal base may bond to the cooktop if overheated.</li> </ul>
<b>Stainless steel</b>	<ul style="list-style-type: none"> <li>■ Heats quickly, but unevenly.</li> <li>■ A core or base of aluminum or copper on stainless steel provides even heating.</li> </ul>

Use flat-bottomed cookware for best cooking results and energy efficiency. The cookware should be about the same size as the cooking area outlined on the cooktop. Cookware should not extend more than 1/2" (1.3 cm) outside the area.

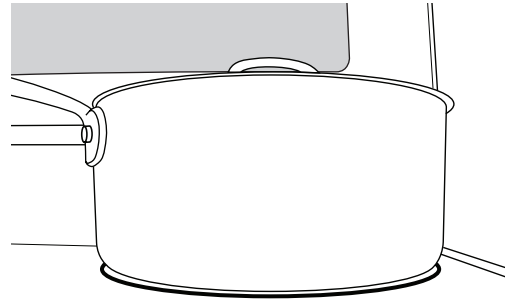

## Home Canning

Canning can be performed on a glass smoothtop cooking surface or traditional coil element cooktop. When canning for long periods, alternate the use of surface cooking areas or elements between batches. This allows time for the most-recently used areas to cool.

- Center the canner on the largest surface cooking area or element. On electric cooktops, canners should not extend more than 1/2" (1.3 cm) beyond the surface cooking area or element.
- Do not place canner on 2 surface cooking areas or elements at the same time.
- On ceramic glass models, use only flat-bottomed canners to avoid damage to the cooktop and elements.
- For more information, contact your local agricultural extension office or refer to published home canning guides. Companies that manufacture home canning products can also offer assistance.

# Oven

Odors and smoke are normal when the oven is used the first few times or when it is heavily soiled.

**IMPORTANT:** The health of some birds is extremely sensitive to the fumes given off by the oven. Exposure to the fumes may result in death to certain birds. Always move birds to another closed and well-ventilated room.

## Aluminum Foil

**IMPORTANT:** To avoid permanent damage to the oven bottom finish, do not line the oven bottom with any type of foil or liner.

For best cooking results, do not cover entire oven rack with foil because air must be able to move freely.

## Positioning Racks and Bakeware

**IMPORTANT:** To avoid permanent damage to the porcelain finish, do not place food or bakeware directly on the oven door or bottom.

### Bakeware

To cook food evenly, hot air must be able to circulate. Allow 2" (5 cm) of space around bakeware and oven walls. Make sure that no bakeware piece is directly over another.

### Racks

- Position racks before turning on the oven.
- Do not position racks with bakeware on them.
- Make sure racks are level.

To position a rack, pull it out to the stop position, raise the front edge, and then lift out. Use the following illustration and charts as guide.

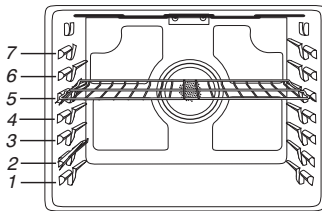

The oven has 7 positions for a flat rack as shown in the previous illustration and the following table.

Flat Rack Position*	Type of Food
7	Broiling/searing meats, hamburgers, steaks
6	Broiled meats, poultry, fish
3 or 4	Most baked goods, casseroles, frozen foods
2	Roasted meats
1	Large roasts or poultry

For hamburger patties to have a well-seared exterior and a rare interior, use a flat rack in rack position 7. Side 1 should cook for approximately 2½ to 3½ minutes. Side 2 should cook for approximately 4 to 5 minutes. Expect a moderate degree of smoke when broiling.

\*If your model has a Max Capacity Oven Rack, the recessed ends must be placed in the rack position above the desired position of the food. See the following illustration.

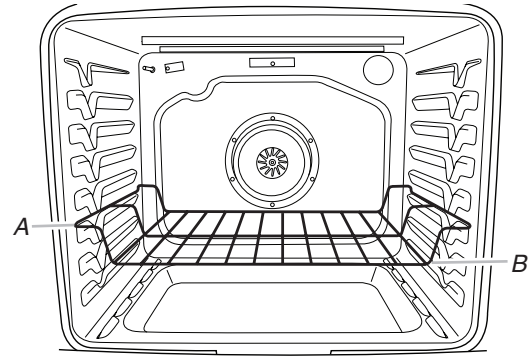

A. Ends of rack in position 3  
B. Food in position 2

**IMPORTANT:** These rack positions are for flat racks. If a Max Capacity Oven Rack is used, the rack position must be adjusted as shown in the previous figure.

### Multiple Rack Cooking

2-rack (non-convection): Use rack positions 2 and 5 or 3 and 6.

2-rack (convection): Use rack positions 2 and 5 or 3 and 6.

3-rack (convection): Use rack positions 2 and 7 and a Max Capacity Oven Rack in rack position 5.

### Baking Cookies and Layer Cakes on 2 Racks

#### Baking Layer Cakes

For best results when baking cakes on 2 racks, use the Bake function, a flat rack in rack position 3, and a roll-out rack in rack position 5. Place the cakes on the racks as shown. Keep at least 3" (7.6 cm) of space between the front of the racks and the front cakes.

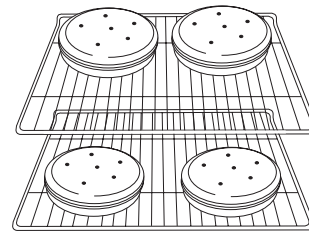

#### Baking Cookies

For best results when baking cookies on 2 racks, use the Convection Bake function, a flat rack in rack position 3, and a roll-out rack in rack position 5.

## Roll-Out Rack

The roll-out rack allows easy access to position and remove food in the oven. It is not recommended to use the roll-out rack in the top rack, position 7, or the bottom rack, position 1.

### Open Position

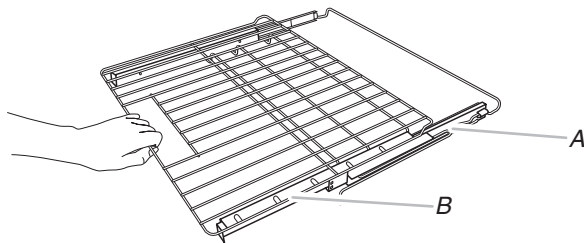

A. Rack frame  
B. Sliding rack

### Closed and Engaged Position

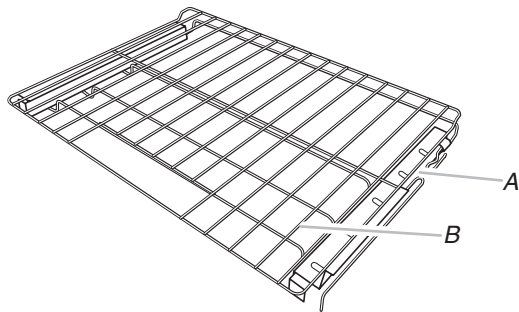

A. Rack frame  
B. Sliding rack

### To Insert Roll-Out Rack

1. Angle the front of the rack assembly up, and then insert the rack frame into the "V" cutout in the rack guides of the oven cavity.

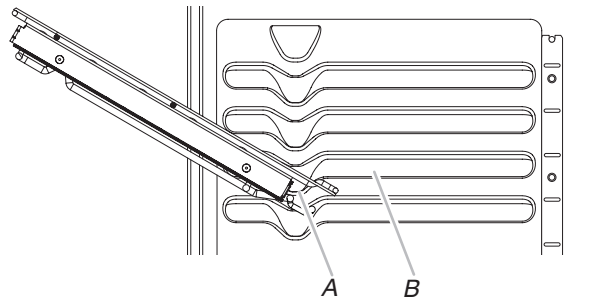

A. "V" cutout  
B. Rack guides

2. Keep rack assembly lifted up at an angle, and then push in to bypass the lower "V" cutout.

3. Lower the front of the rack assembly, and then gently slide rack assembly into oven, bypassing the "V" cutouts. Push the rack assembly into the oven until it stops at the ladder in the back of the oven.

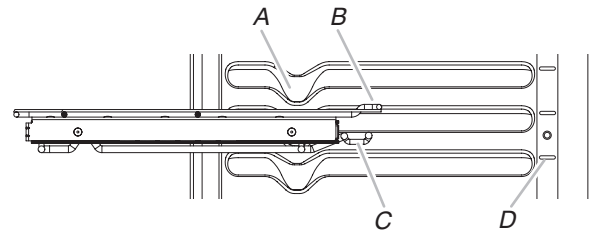

A. "V" cutout  
B. Rack guides  
C. Ladder hook  
D. Ladder

4. Reach through the rack to hold the sliding rack and the front crossbar. Lift the front of the rack assembly, and then push the rack assembly to the back of the oven. Lower the front of the rack assembly so the ladder hook engages with the ladder on both sides of the oven.

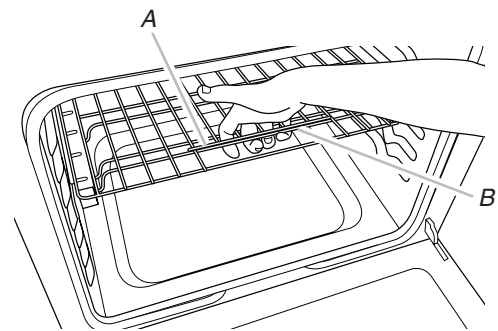

A. Sliding rack  
B. Front crossbar

### To Remove Roll-Out Rack1.

1. Push the sliding rack in completely so that it is in the closed and engaged position.
2. Reach through the rack to hold the sliding rack and the front crossbar. Lift the front of the rack assembly to disengage the ladder hook from the ladders at the rear of the oven, and then pull the rack assembly forward.
3. Using 2 hands, gently pull the sliding rack and the rack frame at the same time to the "V" cutout. Angle the rack so that the front is higher than the back, and then gently pull rack past "V" cutout and then out of the oven.

To avoid damage to the sliding rack, do not place more than 25 lbs (11.4 kg) on the rack.

Do not clean the roll-out rack in a dishwasher. It may remove the rack's lubricant and affect its ability to slide.

See the "General Cleaning" section for more information.

## Oven Vent

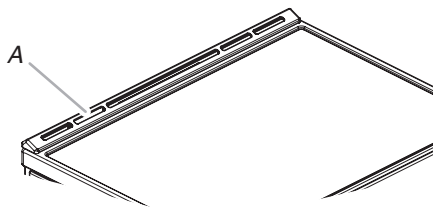

A. Oven vent

The oven vent releases hot air and moisture from the oven and should not be blocked or covered. Blocking or covering the vent will cause poor air circulation, affecting cooking and cleaning results. Do not set plastics, paper, or other items that could melt or burn near the oven vent.

## Sabbath Mode

The Sabbath mode sets the oven to remain on in a Bake setting until turned off.

When the Sabbath mode is set, only the Bake cycle will operate. All other cooking and cleaning cycles are disabled. No tones will sound and the displays will not indicate temperature changes.

When the oven door is opened or closed, the oven light will not turn on or off and the heating elements will not turn on or off immediately.

### To Enable Sabbath Mode Capability (One Time Only):

1. Press OPTIONS/CLOCK until “SABBATH” is displayed. “OFF. Press (1) for On” will scroll in the display.
2. Press the “1” keypad. “ON. Press (1) for Off” will scroll in the display. Sabbath mode can be activated for baking.
3. Press START or CANCEL UPPER to exit and display the time of day.

**NOTE:** To disable the Sabbath mode, repeat steps 1 through 3 to change the status from “SABBATH ON” to “SABBATH OFF.”

### To Activate Sabbath Mode:

1. Press BAKE for the desired oven.
2. Press the number keypad to set a temperature other than 350°F (177°C).
3. Press START.
4. For timed cooking in Sabbath mode, press COOK TIME, and then the number keypads to set the desired cook time.
5. Press OPTIONS/CLOCK. Three tones will sound. Then press “7.” “SAb” will appear in the display.

### To Adjust Temperature (When Sabbath Mode Is Running):

1. Press the number keypad as instructed by the scrolling text to select the new temperature.

**NOTE:** The temperature adjustment will not appear on the display. The scrolling text will be shown on the display as it was before the keypad was pressed.

2. Press START.

### To Deactivate Sabbath Mode:

Press OPTIONS/CLOCK, and then press “7” to return to regular baking, or press CANCEL for the desired oven to turn off the range.

**NOTE:** No tones will sound while deactivating Sabbath mode.

## Baking and Roasting

### Preheating

When beginning a Bake, Convect Bake, or Convect Roast cycle, the oven will begin preheating after Start is pressed. The oven will take approximately 12 to 15 minutes to reach 350°F (177°C) with all of the oven racks provided with your oven inside the oven cavity. Higher temperatures will take longer to preheat. The preheat cycle rapidly increases the oven temperature. The actual oven temperature will go above your set temperature to offset the heat lost when your oven door is opened to insert food. This ensures that when you place your food in the oven, the oven will begin at the proper temperature. Insert your food when the Preheat tone sounds. Do not open the door during preheat before the tone sounds.

### Oven Temperature

While in use, the oven elements will cycle on and off as needed to maintain a consistent temperature, but they may run slightly hot or cool at any point in time due to this cycling. Opening the oven door while in use will release the hot air and cool the oven which could impact the cooking time and performance. It is recommended to use the oven light to monitor cooking progress.

**NOTE:** On models with convection, the convection fan may run in the non-convection Bake mode to improve oven performance.

### Temperature Management System

The Temperature Management System electronically regulates the oven heat levels during preheat and Bake to maintain a precise temperature range for optimal cooking results. The bake and broil elements or burners cycle on and off in intervals. On convection range models, the fan will run while preheating and may be cycled on and off for short intervals during Bake to provide the best results. This feature is automatically activated when the oven is in use.

Before baking and roasting, position racks according to the “Positioning Racks and Bakeware” section. When roasting, it is not necessary to wait for the oven preheat cycle to end before putting food in unless it is recommended in the recipe.

## Broiling

When broiling, preheat the oven for 2 minutes before putting food in unless recommended otherwise in the recipe. Position food on grid in a broiler pan, and then place it in the center of the oven rack.

**IMPORTANT:** Close the door to ensure proper broiling temperature.

Changing the temperature when broiling allows more precise control when cooking. The lower the broil setting is, the slower the cooking. Thicker cuts and unevenly shaped pieces of meat, fish, and poultry may cook better at lower broil settings. Use rack 6 or 7 for broiling. Refer to the “Positioning Racks and Bakeware” section for more information.

On lower settings, the broil element will cycle on and off to maintain the proper temperature.

- For best results, use a broiler pan and grid. It is designed to drain juices and help avoid spatter and smoke. If you would like to purchase a broiler pan, one may be ordered. See the “Accessories” section.

## Convection Cooking

In a convection oven, the fan-circulated hot air continually distributes heat more evenly than the natural movement of air in a standard thermal oven. This movement of hot air helps maintain a consistent temperature throughout the oven, cooking foods more evenly, crisping surfaces while sealing in moisture, and yielding crustier breads.

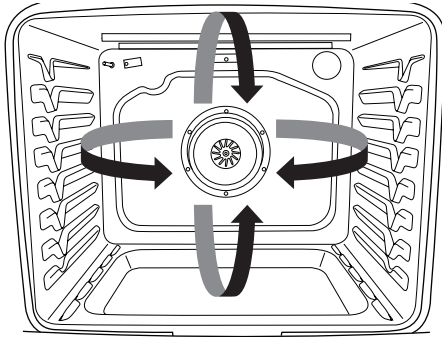

During convection baking or roasting, the bake, broil, and convection elements cycle on and off in intervals while the fan circulates the hot air. During convection broiling, the broil and convection elements cycle on and off.

If the oven door is opened during convection cooking, the fan will turn off immediately. It will come back on when the oven door is closed.

With convection cooking, most foods can be cooked at a lower temperature and/or a shorter cooking time than in a standard thermal oven. When using Manual Convection modes, reduce the time and temperature when setting the oven. Use the following chart as a guide.

Convection Mode	Time/Temp. Guidelines
Convection Bake	25°F (15°C) lower temperature, possible shortened cooking time
Convection Roast	Cooking time shortened by up to 30%
Convection Broil	Shortened cooking time

When using Auto Convection modes, the oven will automatically adjust the time and temperature for the selected mode.

### Convection Modes

#### Manual Convection Modes:

Convection Bake - Multiple-rack baking or cookies, biscuits, breads, casseroles, tarts, tortes, cakes

Convection Roast - Whole chicken or turkey, vegetables, pork roasts, beef roasts

Convection Broil - Thicker cuts or unevenly shaped pieces of meat, fish, or poultry

#### Auto Convection Modes:

Meats - Chicken: whole and pieces; meat loaf; roasts: pork, beef, ham

Baked Goods - Biscuits, quick breads, yeast breads, cakes, cookies, casseroles

Others - Frozen convenience foods: French fries, nuggets, fish sticks, lasagna, pizza

## Proofing Bread

Proofing bread prepares the dough for baking by activating the yeast. Follow the recipe directions as a guide. Proof should be used for fresh dough, thawed dough, and for the first and second rise.

### To Proof:

Before first proofing, place the dough in a lightly greased bowl and cover loosely with wax paper, coated with shortening. Place on rack guide 2 and close the oven door.

**NOTE:** If the temperature of the oven is greater than 120°F (49°C), "Oven Cooling" will be displayed until the temperature is less than 120°F (49°C).

1. Press PROOF.
2. Press START.

Let the dough rise until nearly doubled in size. Proofing time may vary depending on dough type and quantity.

3. Press CANCEL UPPER when finished proofing.

Before second proofing, shape the dough, place it in baking pan(s), and cover loosely. Follow the same placement and control steps above. Before baking, remove the cover.

**NOTE:** If the oven temperature is greater than 120°F (49°C), the display will indicate "Oven Cooling" until the temperature is below 120°F (49°C).

## Favorite

Favorite stores the oven mode and temperature for your favorite recipe. Favorite can only be stored for the upper oven.

To Save a Recipe:

1. While the oven is being used for Bake, Broil, Convection Bake, Convection Roast, or Convection Broil, press and hold FAVORITE for 3 seconds.
2. The current oven mode, cook time, and temperature will be displayed. "SAVED" will be displayed. The recipe has been saved.

**NOTE:** Only one recipe can be saved at a time. Saving a new recipe will overwrite a previously saved recipe.

To Select the Favorite Recipe:

1. Press FAVORITE. The saved oven mode and temperature will be displayed.
 

**NOTE:** Favorite does not store cook times.
2. Press START.
3. Once the recipe is selected, oven will begin preheating to the set program.
4. To change the temperature, press the number keypads to set the desired temperature.
5. Press START.
6. To change the cook time, press COOK TIME.
7. Press the number keypads to set the desired cook time.
8. Press START.
9. Press CANCEL when finished cooking.

## Cook Time

### **⚠ WARNING**

#### **Food Poisoning Hazard**

**Do not let food sit in oven more than one hour before or after cooking.**

**Doing so can result in food poisoning or sickness.**

#### **To Set a Timed Cook:**

1. Press BAKE or BROIL, or press AUTO CONVECT MODES or MANUAL CONVECT MODES until the desired convection mode appears on the display.
2. Press the number keypads to enter a temperature other than the one displayed.
3. Press COOK TIME. The cook time oven indicator light will light up.
4. Press the number keypads to enter the length of time to cook.
5. Press START. The display will count down the time. When the time ends, the oven will shut off automatically.
6. Press CANCEL for the desired oven to clear the display.

#### **To Set a Delayed Timed Cook:**

1. Press BAKE or BROIL, or press AUTO CONVECT MODES or MANUAL CONVECT MODES until the desired convection mode appears on the display.
2. Press the number keypads to enter a temperature other than the one displayed.
3. Press COOK TIME. The Cook Time oven indicator light will light up.
4. Press number keypads to enter the length of time to cook.
5. Press DELAY START.
6. Press number keypads to enter the number of hours and/or minutes you want to delay the start time.
7. Press START.

When the start time is reached, the oven will automatically turn on. The temperature and/or time settings can be changed anytime after the oven turns on by repeating steps 2 through 4. When the set cook time ends, the oven will shut off automatically.

8. Press CANCEL for the desired oven to clear the display.

## Baking Drawer

### **⚠ WARNING**

#### **Food Poisoning Hazard**

**Do not let food sit in oven more than one hour before or after cooking.**

**Doing so can result in food poisoning or sickness.**

The Baking Drawer is highly recommended for baking frozen foods. Use the temperature and medium cook time given on the frozen food packaging. For example, if the packaging suggests a cook time of 15 to 20 minutes, set the cook time for 17 minutes. Check food for doneness before removing from the Baking Drawer.

The Baking Drawer may also be used for conventional baking and keeping hot cooked foods warm. It is not recommended to prepare foods taller than the height of the baking drawer rack handles or foods that may rise above 2½" (6.4 cm) in the Baking Drawer.

**IMPORTANT:** Always use the baking drawer rack when using the Baking Drawer.

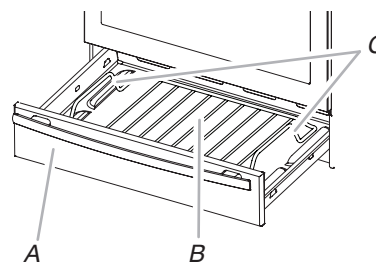

- A. Baking drawer
- B. Baking drawer rack
- C. Baking drawer rack handles

See the "General Cleaning" section for more information.

#### **To Bake with the Baking Drawer:**

1. Press LOWER OVEN BAKE.
2. Press the number keypads to set the desired temperature. If the temperature entered is not in the range of the temperatures allowed, the minimum or maximum allowed temperature will be displayed. Enter a temperature in the allowable range.
3. Press START.
4. To change the temperature, repeat steps 2 and 3.
5. Press CANCEL LOWER when finished.
6. Remove food from the drawer.

#### **To Keep Warm with the Baking Drawer:**

Food must be at serving temperature before placing it in the warmed drawer.

1. Place food in the baking drawer.
2. Press LOWER OVEN KEEP WARM.
3. Press the number keypads to set the desired temperature. If the temperature entered is not in the range of the temperatures allowed, the minimum or maximum allowed temperature will be displayed. Enter a temperature in the allowable range.
4. Press START.
5. Press CANCEL LOWER when finished.
6. Remove food from the baking drawer.

## Oven Light

The oven light is a standard 40 W appliance bulb. Before replacing, make sure the oven and cooktop are cool and the control knobs are in the Off position.

#### **To Replace:**

1. Unplug range or disconnect power.
2. Turn the glass bulb cover in the back of the oven counterclockwise to remove.
3. Turn bulb counterclockwise to remove from socket.
4. Replace bulb by turning clockwise.
5. Replace bulb cover by turning clockwise.
6. Plug in range or reconnect power.



# AquaLift®

## Self-Cleaning Technology

AquaLift® Technology is an innovative cleaning solution that utilizes heat and water to release baked-on spills from the oven in less than 1 hour. This new cleaning technology is a low-heat, odor-free alternative to traditional self-cleaning options.

Allow the oven to cool to room temperature before using the Clean cycle. If your oven cavity is above 200°F (93°C), “Oven Cooling” will appear in the display and the Clean cycle will not be activated until the oven cavity cools down.

### To Clean:

1. Remove all racks and accessories from the oven cavity and wipe excess soil. Use a plastic scraper to remove easily removed soils.

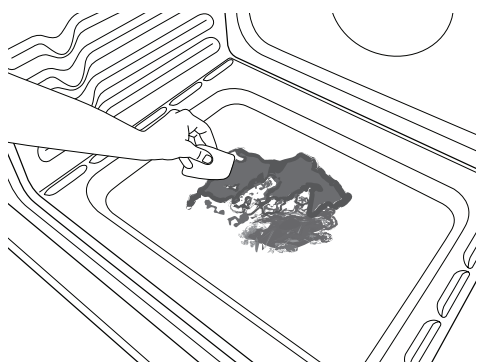

2. Pour 2 cups (16 oz [500 mL]) of distilled or filtered water onto the bottom of the empty oven and close the oven door.

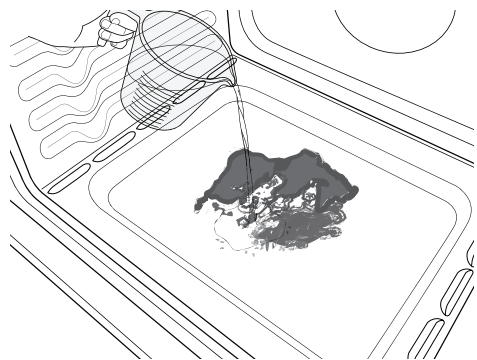

**IMPORTANT:** Do not use chemicals or other additives with the water. Do not open the oven door during the Clean cycle. The water on the oven bottom is hot.

3. Press AQUALIFT SELF CLEAN and then START on the oven control panel.
4. Allow 40 minutes for cleaning and cooldown. A beep will sound when the Clean cycle is complete.
5. Press CANCEL UPPER at the end of the cycle. Cancel Upper may be pressed at any time to stop the Clean cycle.

6. Remove the residual water and loosened soils with a sponge or cloth immediately after the Clean cycle is complete. Much of the initial 2 cups (16 oz [500 mL]) of water will remain in the oven after the cycle has completed. If additional soils remain, leave a small amount of water in the oven bottom to assist with the cleaning.

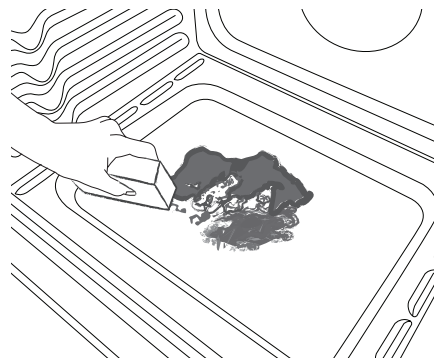

7. If any soils remain, remove them with a non-scratch scrubbing sponge or plastic scraper. Additional Clean cycles may be run to help remove the stubborn soils.

**IMPORTANT:** Do not use oven cleaners. The use of chemicals, including commercial oven cleaners or metal scouring pads, may cause permanent damage to the porcelain surface of the oven interior.

### NOTES:

- The range should be level to ensure that the entire surface of the bottom of the oven cavity is covered by water at the beginning of the Clean cycle.
- For best results, use distilled or filtered water. Tap water may leave mineral deposits on the oven bottom.
- Before removing the residual water and loosened soils at the end of the Clean cycle, insert a cloth or paper towel between the lower edge of the oven door and the front frame to keep water from spilling onto the front of the range and the floor.
- Soil baked on through several cooking cycles will be more difficult to remove with the Clean cycle.
- Nonabrasive scrub sponges or eraser-style cleaning pads (without cleaners) can be effective for cleaning the oven cavity walls, oven door, and oven bottom for difficult soils. For best results, moisten the pads and sponges before use.
- Run an additional Clean cycle for stubborn soils.
- Affresh® Kitchen Appliance Cleaner and affresh® Cooktop Cleaner may be used to clean the oven bottom, walls, and door when the oven has finished the cycle and returned to room temperature. If affresh® Cooktop Cleaner is used, it is recommended to wipe out the cavity with distilled water as well. Refer to the “Accessories” section for information on ordering.
- Additional AquaLift® Technology Cleaning Kits may be obtained by ordering Part Number W10423113RP. See the “Accessories” section for more information.
- For assistance with AquaLift® Technology, call 1-877-258-0808 in the U.S.A. or 1-800-807-6777 in Canada, or visit our website at <http://whirlpoolcorp.com/aqualift>.

## General Cleaning

**IMPORTANT:** Before cleaning, make sure all controls are OFF and the oven and cooktop are cool. Always follow label instructions on cleaning products. For additional information, you can visit our website at [www.jennair.com](http://www.jennair.com). In Canada, visit our website at [www.jennair.ca](http://www.jennair.ca).

Soap, water and a soft cloth or sponge are suggested first unless otherwise noted.

### EXTERIOR PORCELAIN ENAMEL SURFACES (on some models)

Food spills containing acids, such as vinegar and tomato, should be cleaned as soon as the entire range is cool. These spills may affect the finish.

#### Cleaning Method:

- Glass cleaner, mild liquid cleaner, or nonabrasive scrubbing pad:  
Gently clean around the model/serial/rating plate because scrubbing may remove numbers.
- Affresh® Kitchen and Appliance Cleaner Part Number W10355010 (not included):  
See the "Accessories" section for more information.

### STAINLESS STEEL (on some models)

**NOTE:** To avoid damage to stainless steel surfaces, do not use soap-filled scouring pads, abrasive cleaners, Cooktop Cleaner, steel-wool pads, gritty washcloths, or abrasive paper towels. Damage may occur to stainless steel surfaces, even with one-time or limited use.

#### Cleaning Method:

Rub in direction of grain to avoid damaging.

- Affresh® Stainless Steel Cleaner Part Number W10355016:  
See the "Accessories" section for more information.

### METALLIC PAINT (on some models)

Do not use abrasive cleaners, cleaners with bleach, rust removers, ammonia or sodium hydroxide (lye) because paint surface may stain.

### CERAMIC GLASS

To avoid damaging the cooktop, do not use steel wool, abrasive powder cleansers, chlorine bleach, rust remover, or ammonia.

1. Remove food/residue with the Cooktop Scraper.

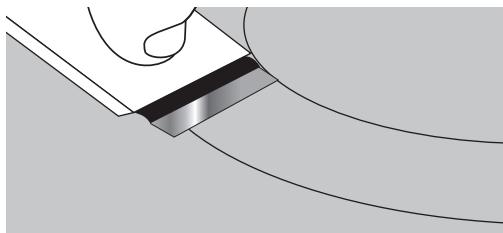

- For best results, use the Cooktop Scraper while the cooktop is still warm but not hot to the touch. It is recommended to wear an oven mitt while scraping the warm cooktop.
- Hold the Cooktop Scraper at approximately a 45° angle against the glass surface and scrape the residue. It will be necessary to apply pressure in order to remove the residue.

Allow the cooktop to cool down completely before proceeding to Step 2.

2. Apply a few dime-sized drops of affresh® Cooktop Cleaner to the affected areas.

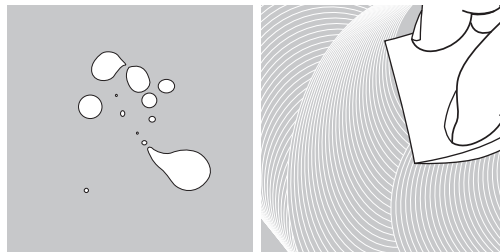

- Rub affresh® Cooktop Cleaner onto the cooktop surface with the blue Cooktop Cleaning Pad. Some pressure is needed to remove stubborn stains.
  - Allow the cleaner to dry to a white haze before proceeding to Step 3.
3. Polish with a clean, dry cloth or a clean, dry paper towel.

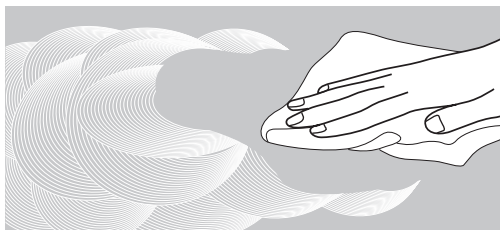

- Repeat steps 1 through 3 as necessary for stubborn or burned-on stains.

The Complete Cooktop Cleaner Kit is available for order including the following:

- Cooktop Scraper
- Affresh® Cooktop Cleaner
- Blue Cooktop Cleaning Pads

See the "Accessories" section for part numbers and information on ordering.

### COOKTOP CONTROLS

To avoid damage to the cooktop controls, do not use steel wool, abrasive cleansers, or oven cleaner.

To avoid damage, do not soak knobs.

When replacing knobs, make sure knobs are in the Off position.

On some models, do not remove seals under knobs.

#### Cleaning Method:

- Soap and water:  
Pull knobs straight away from control panel to remove.

### CONTROL PANEL AND OVEN DOOR EXTERIOR

To avoid damage to the control panel, do not use abrasive cleaners, steel-wool pads, gritty washcloths, or abrasive paper towels.

#### Cleaning Method:

- Glass cleaner and soft cloth or sponge:  
Apply glass cleaner to soft cloth or sponge, not directly on panel.
- Affresh® Kitchen and Appliance Cleaner Part Number W10355010 (not included):  
See the "Accessories" section for more information.

## OVEN RACKS

### Cleaning Method:

- Steel-wool pad
- For racks that have discolored and are harder to slide, a light coating of vegetable oil applied to the rack guides will help them slide.

## BAKING DRAWER

Check that baking drawer is cool and empty before cleaning.

Baking drawer can be removed for easier cleaning. See the "Removing the Baking Drawer" section for instructions.

Food spills should be cleaned when oven cools. At high temperatures, foods react with porcelain and staining, etching, pitting or faint white spots can result.

### Cleaning Method:

- Mild detergent

## OVEN CAVITY

Use AquaLift® Technology regularly to clean oven spills.

Do not use oven cleaners.

Food spills should be cleaned when oven cools. At high temperatures, foods react with porcelain. Staining, etching, pitting, or faint white spots can result.

### Cleaning Method:

- Clean cycle:  
See the "Clean Cycle" section first.

## Remove/Replace Drawer

Remove all items from inside the baking drawer, and then allow the range to cool completely before attempting to remove the drawer.

### To Remove:

1. Open the drawer to its fully open position.
2. Using a flat-blade screwdriver, gently loosen the drawer from the glide alignment notch, and then lift up the drawer alignment tab from the glide.

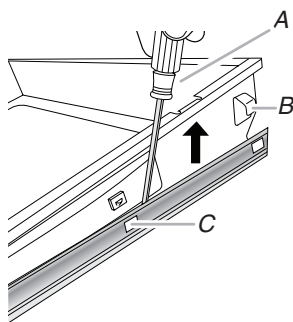

A. Flat-blade screwdriver  
B. Drawer alignment tab  
C. Drawer glide notch

3. Repeat Step 2 on the other side. The drawer is no longer attached to the drawer glides. Using both hands, pick up the drawer to complete the removal.

### To Replace:

1. Align the forward drawer notches with the notches in the drawer glides on both sides. Place the rear alignment tabs into the drawer glides on both sides.

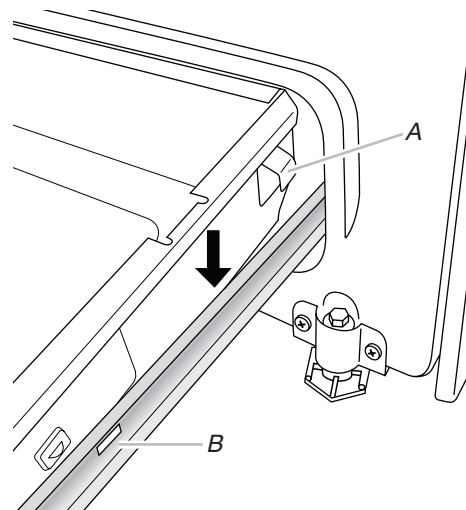

A. Drawer alignment tab  
B. Drawer glide notch

2. Push the drawer in all the way.
3. Gently open and close the drawer to ensure it is seated properly on the glides on both sides.

# Troubleshooting

First try the solutions suggested here. If you need further assistance or more recommendations that may help you avoid a service call, refer to the warranty page in this manual, or visit <https://jennair.custhelp.com>. In Canada, visit <http://www.jennair.ca>.

Contact us by mail with any questions or concerns at the address below:

In the U.S.A.:

JennAir Brand Home Appliances  
Customer eXperience Center  
553 Benson Road  
Benton Harbor, MI 49022-2692

In Canada:

JennAir Brand Home Appliances  
Customer eXperience Centre  
200 - 6750 Century Ave.  
Mississauga, Ontario L5N 0B7

Please include a daytime phone number in your correspondence.

Problem	Possible Causes and/or Solutions
<b>Nothing will operate</b>	<p><b>Power supply cord is unplugged:</b> Plug into a grounded outlet.</p> <p><b>ENERGY SAVE is active and the display is blank:</b> Press any keypad on the control to display the time of day. See the “Electronic Oven Controls” section for more information.</p> <p><b>Household fuse is blown or a circuit breaker is tripped:</b> Replace the fuse or reset the circuit breaker. If the problem continues, call an electrician.</p> <p><b>The control displays an F9 or F9 E0 error code:</b> The electrical outlet in the home may be miswired. Contact a qualified electrician to verify the electrical supply.</p>
<b>Cooktop will not operate</b>	<p><b>The control knob is not set correctly:</b> Push in knob before turning to a setting.</p> <p><b>On ceramic glass models, the oven control lockout is set:</b> See the “Control Lock” keypad feature in the “Feature Guide.”</p>
<b>Excessive heat around cookware on cooktop</b>	<p><b>Cookware is not the proper size:</b> Use cookware about the same size as the surface cooking area, element, or surface burner. Cookware should not extend more than 1/2" (1.3 cm) outside the cooking area.</p>
<b>Cooktop cooking results not what expected</b>	<p><b>Control knob set to incorrect heat level:</b> See the “Cooktop” section.</p> <p><b>Range is not level:</b> Level the range. See the Installation Instructions.</p>
<b>Cooktop element cycles on and off on Hi setting</b>	<p><b>Element cycling due to a temperature limiter:</b> This is normal operation. The element may cycle on and off to keep the cooktop from overheating.</p>
<b>Oven will not operate</b>	<p><b>Delay Start is set -</b> See “Cook Time” section.</p> <p><b>Control Lock is on -</b> Press and hold START for 3 seconds to unlock.</p> <p><b>The range is in Demo mode:</b> Demo mode will deactivate all oven elements. See “Demo Mode” in the “Electronic Oven Controls” section.</p> <p><b>Electronic oven control set incorrectly -</b> See “Electronic Oven Controls” section.</p>
<b>Oven temperature too high or too low</b>	<p><b>Oven temperature calibration needs adjustment:</b> See “Oven Temperature Control” in the “Electronic Oven Controls” section.</p>
<b>Oven indicator lights flash</b>	<p><b>Power to range is turned on or restored:</b> See “Control Display” in the “Electronic Oven Controls” section. If the indicator light(s) keep flashing, call for service. See the “Warranty” section for contact information.</p>
<b>Display shows messages</b>	<p><b>Power failure (Display shows flashing time.):</b> Press CANCEL to clear the display. On some models, reset the clock, if needed. See “Clock” keypad feature in the “Feature Guide” section.</p> <p><b>Error code (Display shows letter followed by number.):</b> Depending on your model, press CANCEL to clear the display. See “Control Display” in the “Electronic Oven Controls” section. If it reappears, call for service. See the “Warranty” section for contact information.</p>
<b>Clean cycle did not work on all spills</b>	<p><b>Several cooking cycles between Clean cycles or spills on oven walls and doors:</b> Run additional Clean cycles. Use the Aqualift® Technology Cleaning Kit. Affresh® Kitchen and Appliance Cleaner or affresh® Cooktop Cleaner can be used for stubborn soils. See the “Accessories” section for more information.</p>
<b>Mineral deposits are left on the oven bottom after the Clean cycle</b>	<p><b>Tap water was used in the Clean cycle:</b> Use distilled or filtered water in the Clean cycle.</p> <p>To remove deposits, use a cloth soaked with vinegar. Then use a cloth dampened with water to thoroughly remove any vinegar residue.</p> <p><b>Range is not level:</b> Mineral deposits will collect on dry areas of the oven bottom during the Clean cycle. Level the range. See the Installation Instructions.</p> <p>To remove deposits, use a cloth soaked with vinegar. Then use a cloth dampened with water to thoroughly remove any vinegar residue.</p>

Problem	Possible Causes and/or Solutions
<p><b>Oven cooking results not what expected</b></p>	<p><b>Range is not level:</b> Level the range. See the Installation Instructions.</p> <p><b>The set temperature was incorrect:</b> Double-check the recipe in a reliable cookbook.</p> <p><b>Oven temperature is calibrated incorrectly:</b> See “Oven Temperature Offset Control” in the “Electronic Oven Controls” section.</p> <p><b>Oven was not preheated:</b> See the “Baking and Roasting” section.</p> <p><b>Racks were positioned improperly:</b> See the “Positioning Racks and Bakeware” section.</p> <p><b>Not enough air circulation around bakeware:</b> See the “Positioning Racks and Bakeware” section.</p> <p><b>Batter distributed unevenly in pan:</b> Check that batter is level in the pan.</p> <p><b>Darker browning of food caused by dull or dark bakeware:</b> Lower oven temperature 25°F (15°C) or move rack to a higher position in the oven.</p> <p><b>Lighter browning of food caused by shiny or light-colored bakeware:</b> Move rack to a lower position in the oven.</p> <p><b>Incorrect length of cooking time was used:</b> Adjust cooking time.</p> <p><b>Oven door was not closed:</b> Be sure that the bakeware does not keep the door from closing.</p> <p><b>Oven door was opened during cooking:</b> Oven peeking releases oven heat and can result in longer cooking times.</p> <p><b>Rack is too close to bake burner, making baked items too brown on bottom:</b> Move rack to higher position in the oven.</p> <p><b>Pie crusts browning too quickly:</b> Use aluminum foil to cover the edge of the crust and/or reduce baking temperature.</p>

## Accessories

For accessories in the U.S.A., you can visit our website at [www.jennair.com](http://www.jennair.com) or call us at 1-800-JENNAIR (1-800-536-6247).

In Canada, visit our website at [www.jennair.ca](http://www.jennair.ca) or call us at 1-800-JENNAIR (1-800-536-6247).

### **Complete Cooktop Cleaner Kit**

(ceramic glass models)  
(includes cleaner, protectant, protectant applicator, scraper, and cleaner pads)  
Order Part Number 31605

### **Cooktop Protectant**

(ceramic glass models)  
Order Part Number 31463A

### **Affresh® Stainless Steel Cleaning Wipes**

(stainless steel models)  
Order Part Number W10355049

### **Affresh® Cooktop Cleaner**

(ceramic glass models)  
Order Part Number W10355051

### **Cooktop Cleaning Pads**

(ceramic glass models)  
Order Part Number W10391473

### **Affresh® Stainless Steel Cleaner**

(stainless steel models)  
Order Part Number W10355016

### **Affresh® Kitchen and Appliance Cleaner**

Order Part Number W10355010

### **AquaLift® Oven Cleaning Kit**

Order Part Number W10423113RP

### **Cooktop Scraper**

(ceramic glass models)  
Order Part Number WA906B

### **Granite Cleaner and Polish**

Order Part Number W10275756

### **Gas Grate and Drip Pan Cleaner**

Order Part Number 31617A

### **Gourmet Griddle**

Order Part Number W10432539

### **Heavy Duty Flat Oven Rack**

Order Part Number W10554005

### **Split Oven Rack**

Order Part Number 4396927

### **HD Max Capacity Oven Rack**

Order Part Number W10554006

### **Sliding Flat Oven Rack**

Order Part Number W10554008

### **Porcelain Broiler Pan and Grid**

Order Part Number 4396923

### **Premium Broiler Pan and Roasting Rack**

Order Part Number W10123240

### **Trim Assembly**

5/8" (1.7 cm) White - Order Part Number W10675027

5/8" (1.7 cm) Black - Order Part Number W10675026

5/8" (1.7 cm) Stainless Steel - Order Part Number W10675028

1 1/8" (2.9 cm) White - Order Part Number W10731885

1 1/8" (2.9 cm) Black - Order Part Number W10731886

1 1/8" (2.9 cm) Stainless Steel - Order Part Number W10731887

### **Backsplash Assembly**

White - Order Part Number W10655448

Black - Order Part Number W10655449

Stainless Steel - Order Part Number W10655450

### **Grill Kit**

Order Part Number W10432545

# JENNAIR® MAJOR APPLIANCE LIMITED WARRANTY

ATTACH YOUR RECEIPT HERE. PROOF OF PURCHASE IS REQUIRED TO OBTAIN WARRANTY SERVICE.

Please have the following information available when you call the Customer eXperience Center:

- Name, address, and telephone number
- Model number and serial number
- A clear, detailed description of the problem
- Proof of purchase, including dealer or retailer name and address

## IF YOU NEED SERVICE:

1. Before contacting us to arrange service, please determine whether your product requires repair. Some questions can be addressed without service. Please take a few minutes to review the Troubleshooting section of the Use and Care Guide or visit [producthelp.jennair.com](http://producthelp.jennair.com).
2. All warranty service is provided exclusively by our authorized JennAir Service Providers. In the U.S. and Canada, direct all requests for warranty service to:

**JennAir Customer eXperience Center  
1-800-JENNAIR (1-800-536-6247).**

If outside the 50 United States or Canada, contact your authorized JennAir dealer to determine whether another warranty applies.

## TWO YEAR LIMITED WARRANTY

### WHAT IS COVERED

### WHAT IS NOT COVERED

For two years from the date of purchase, when this major appliance is installed, operated, and maintained according to instructions attached to or furnished with the product, JennAir brand of Whirlpool Corporation or Whirlpool Canada LP (hereafter "JennAir") will pay for factory specified replacement parts and repair labor to correct defects in materials or workmanship that existed when this major appliance was purchased or, at its sole discretion, replace the product. In the event of product replacement, your appliance will be warranted for the remaining term of the original unit's warranty period.

**YOUR SOLE AND EXCLUSIVE REMEDY UNDER THIS LIMITED WARRANTY SHALL BE PRODUCT REPAIR AS PROVIDED HEREIN.** Service must be provided by a JennAir designated service company. This limited warranty is valid only in the United States or Canada and applies only when the major appliance is used in the country in which it was purchased. This limited warranty is effective from the date of original consumer purchase. Proof of original purchase date is required to obtain service under this limited warranty.

1. Commercial, non-residential, multiple-family use, or use inconsistent with published user, operator, or installation instructions.
2. In-home instruction on how to use your product.
3. Service to correct improper product maintenance or installation, installation not in accordance with electrical or plumbing codes, or correction of household electrical or plumbing (e.g., house wiring, fuses, or water inlet hoses).
4. Consumable parts (e.g., light bulbs, batteries, air or water filters, preservation solutions).
5. Defects or damage caused by the use of non-genuine JenAir parts or accessories.
6. Conversion of products from natural gas or propane gas.
7. Damage from accident, misuse, abuse, fire, floods, acts of God, or use with products not approved by JennAir.
8. Repairs to parts or systems to correct product damage or defects caused by unauthorized service, alteration, or modification of the appliance.
9. Cosmetic damage including scratches, dents, chips, and other damage to the appliance finishes, unless such damage results from defects in materials and workmanship and is reported to JennAir within 30 days.
10. Discoloration, rust, or oxidation of surfaces resulting from caustic or corrosive environments including, but not limited to, high salt concentrations, high moisture or humidity, or exposure to chemicals.
11. Food or medicine loss due to product failure.
12. Pickup or delivery. This product is intended for in-home repair.
13. Travel or transportation expenses for service in remote locations where an authorized JennAir servicer is not available.
14. Removal or reinstallation of inaccessible appliances or built-in fixtures (e.g., trim, decorative panels, flooring, cabinetry, islands, countertops, drywall) that interfere with servicing, removal, or replacement of the product.
15. Service or parts for appliances with original model/serial numbers removed, altered, or not easily determined.

**The cost of repair or replacement under these excluded circumstances shall be borne by the customer.**

### DISCLAIMER OF IMPLIED WARRANTIES

IMPLIED WARRANTIES, INCLUDING ANY IMPLIED WARRANTY OF MERCHANTABILITY OR IMPLIED WARRANTY OF FITNESS FOR A PARTICULAR PURPOSE, ARE LIMITED TO TWO YEARS OR THE SHORTEST PERIOD ALLOWED BY LAW. Some states and provinces do not allow limitations on the duration of implied warranties of merchantability or fitness, so this limitation may not apply to you. This warranty gives you specific legal rights, and you also may have other rights that vary from state to state or province to province.

### DISCLAIMER OF REPRESENTATIONS OUTSIDE OF WARRANTY

JennAir makes no representations about the quality, durability, or need for service or repair of this major appliance other than the representations contained in this warranty. If you want a longer or more comprehensive warranty than the limited warranty that comes with this major appliance, you should ask JennAir or your retailer about buying an extended warranty.

### LIMITATION OF REMEDIES: EXCLUSION OF INCIDENTAL AND CONSEQUENTIAL DAMAGES

YOUR SOLE AND EXCLUSIVE REMEDY UNDER THIS LIMITED WARRANTY SHALL BE PRODUCT REPAIR AS PROVIDED HEREIN. JENNAIR SHALL NOT BE LIABLE FOR INCIDENTAL OR CONSEQUENTIAL DAMAGES. Some states and provinces do not allow the exclusion or limitation of incidental or consequential damages, so these limitations and exclusions may not apply to you. This warranty gives you specific legal rights, and you also may have other rights that vary from state to state or province to province.

03/17





---

## NOTES

---

## NOTES

