



ENGLISH

FRANÇAIS

ESPAÑOL

# OWNER'S MANUAL FRENCH DOOR REFRIGERATOR

Please read this owner's manual thoroughly before operating and keep it handy for reference at all times.

LFXS32726\*  
LFXS32736\*



MFL62184485\_Rev.12

[www.lg.com](http://www.lg.com)

Copyright © 2014 - 2017 LG Electronics Inc. All Rights Reserved.

# TABLE OF CONTENTS

## 3 PRODUCT FEATURES

---

## 4 IMPORTANT SAFETY INSTRUCTIONS

---

## 7 COMPONENTS

---

- 7 Refrigerator Exterior
- 8 Refrigerator Interior

## 9 INSTALLATION

---

- 9 Installation Overview
- 10 Specifications
- 11 Unpacking Your Refrigerator
- 11 Choosing the Proper Location
  - 11 - Flooring
  - 12 - Ambient Temperature
  - 12 - Measuring the Clearances
- 12 Removing/Assembling the Refrigerator Door Handles
- 13 Removing/Assembling the Freezer Drawer Handle
- 13 Removing/Assembling the Doors and Drawers
  - 14 - Removing the Left Refrigerator Door
  - 15 - Removing the Right Refrigerator Door
  - 16 - Assembling the Right Refrigerator Door
  - 17 - Assembling the Left Refrigerator Door
  - 18 - Removing the Freezer Drawers
  - 20 - Assembling the Freezer Drawers
- 21 Connecting the Water Line
  - 21 - Before You Begin
  - 21 - Water Pressure
  - 21 - What You Will Need
  - 22 - Water Line Installation Instructions
- 24 Turning On the Power
- 25 Leveling and Door Alignment
  - 25 - Leveling
  - 25 - Door Alignment

## 26 HOW TO USE

---

- 26 Before Use
- 27 Control Panel
  - 27 - Control Panel Features
- 29 In-Door Ice Bin
  - 29 - Detaching the In-Door Ice Bin
  - 29 - Assembling the In-Door Ice Bin
- 30 Automatic Icemaker
  - 30 - Turning the Automatic Icemaker On or Off
  - 31 - When You Should Turn the Icemaker Off
  - 31 - Normal Sounds You May Hear
  - 31 - Preparing for Vacation
- 32 Ice and Water Dispenser
  - 32 - Dispenser
  - 32 - Using the Dispenser
  - 32 - Locking the Dispenser
  - 32 - Cleaning the Dispenser Stand
- 33 Storing Food
  - 33 - Food Preservation Location
  - 34 - Food Storage Tips
  - 34 - Storing Frozen Food
- 35 Glide'N'Access™
- 36 Detaching and Assembling the Storage Bins
- 37 Adjusting the Refrigerator Shelves

## 38 MAINTENANCE

---

- 38 Cleaning
- 39 Replacing the Fresh Air Filter
- 39 Replacing the Water Filter

## 44 SMART DIAGNOSIS™

---

- 44 Using Smart Diagnosis™

## 45 TROUBLESHOOTING

---

## 55 LIMITED WARRANTY

---

## PRODUCT FEATURES

\* Depending on the model, some of the following functions may not be available.



### FILTERED WATER AND ICE DISPENSER

The water dispenser dispenses fresh, chilled water. The ice dispenser dispenses cubed and crushed ice.



### DOOR ALARM

The Door Alarm function is designed to prevent refrigerator malfunctioning that could occur if a refrigerator door or freezer drawer remains open. If a refrigerator door or freezer drawer is left open for more than 60 seconds, a warning alarm sounds at 30 second intervals.

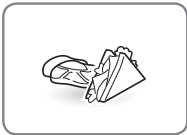

### GLIDE'N'SERVE

Glide'N'Serve provides storage space with a variable temperature control that keeps the compartment colder than the refrigerator. It is a convenient place to store sandwiches or meat to be cooked.



### AUTO CLOSING HINGE

The refrigerator doors and freezer drawers close automatically with a slight push. (The door only closes automatically when it is open at an angle less than 30°.)

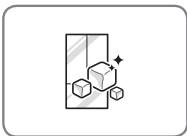

### ICE PLUS

Ice production can be increased by approximately 20 percent when the freezer section is maintained at the coldest temperature for a 24-hour period.

# IMPORTANT SAFETY INSTRUCTIONS

## *READ ALL INSTRUCTIONS BEFORE USING THE APPLIANCE.*

This guide contains many important safety messages. Always **read and obey** all safety messages.



This is the safety alert symbol. It alerts you to safety messages that inform you of hazards that can kill or hurt you or others, or cause damage to the product.

All safety messages will be preceded by the safety alert symbol and the hazard signal word WARNING or CAUTION. These words mean:



**WARNING** You can be killed or seriously injured if you do not follow instructions.



**CAUTION** Indicates an imminently hazardous situation which, if not avoided, may result in minor or moderate injury, or product damage.



**WARNING**

**To reduce the risk of fire, electric shock, or personal injury when using your product, basic safety precautions should be followed, including the following:**

### Power

- NEVER unplug your refrigerator by pulling on the power cord. Always grip the plug firmly and pull it straight out from the outlet.
- If the supply cord is damaged, it must be replaced by the manufacturer or its service agent or a similarly qualified person in order to avoid a hazard. Do not use a cord that shows cracks or abrasion damage along its length or at either the plug or connector end.
- Do not use an uncertified power outlet.
- Unplug the power plug immediately in the event of a blackout or thunderstorm.
- Plug in the power plug with the power cord facing downward.

### Installation

- Contact an authorized service center before you install or relocate the refrigerator.
- When moving your refrigerator away from the wall, be careful not to roll over or damage the power cord.
- Prior to use, ensure that you are connecting this product to a dedicated, grounded electrical outlet rated for use with this product (115V, 60Hz, AC only). It is the user's responsibility to replace a standard 2-prong wall outlet with a standard 3-prong wall outlet.
- Do not install the refrigerator where there may be a danger of the unit falling.

### Use

- DO NOT allow children to climb, stand, or hang on the refrigerator doors or on the shelves in the refrigerator. They could damage the refrigerator and seriously injure themselves.
- Do not hang on to or place heavy objects on the refrigerator's dispenser.
- Do not place heavy or dangerous objects (bottles with liquid) on the refrigerator.
- Do not put live animals inside the refrigerator.
- Do not allow children to climb into the product when it is in use.
- In the event of a gas leak (propane/LPG), ensure adequate ventilation and contact an authorized service center before resuming use. Do not touch or disassemble the electric outlet of the refrigerator.
- In the event of a refrigerant leak, move flammable objects away from the refrigerator. Ensure adequate ventilation and contact an authorized service center.
- Do not use or place flammable substances (chemicals, medicine, cosmetics, etc) near the refrigerator or store them inside the refrigerator. Do not place the refrigerator in the vicinity of flammable gas.
- Do not overfill or pack items too tightly into door bins. Doing so may cause damage to the bin or personal injury if items are removed with excessive force.

**READ ALL INSTRUCTIONS BEFORE USING THE APPLIANCE.**

To reduce the risk of fire, electric shock, or personal injury when using your product, basic safety precautions should be followed, including the following:

- This product is not to be used for special purposes such as the storage of medicine or test materials or for use on ships, etc.
- Unplug the power plug before cleaning or repairing the refrigerator.
- When you replace the light bulb in the refrigerator, unplug the refrigerator or turn off the power.
- Do not modify or extend the power cord.
- Do not use a dryer to dry the interior. Do not light a candle to remove interior odors.
- For your safety, this appliance must be properly grounded. Have the wall outlet and the circuit checked by a qualified electrician to make sure the outlet is properly grounded.
- Do not use an outlet that can be turned off with a switch. Do not use an extension cord. It is the user's responsibility to replace a standard 2-prong wall outlet with a standard 3-prong wall outlet.
- Do not, under any circumstances, cut or remove the third (ground) prong from the power cord.
- Do not use an adapter plug and plug the power plug into a multi-outlet extension cord.
- Disconnect the power cord immediately if you hear a noise, smell a strange odor or detect smoke coming from the appliance.
- Turn the power off if water or dust penetrates into the refrigerator. Call a service agent.
- Do not disassemble or modify the refrigerator.
- Do not put hands, feet, or metal objects below or behind the refrigerator.
- Do not operate the refrigerator or touch the power cord with wet hands.
- In refrigerators with automatic icemakers, avoid contact with the moving parts of the ejector mechanism or with the heating element that releases the cubes. Do not place fingers or hands on the automatic ice-making mechanism while the refrigerator is plugged in.
- When dispensing ice from the dispenser, do not use crystal ceramics.
- Do not touch the cold surfaces in the freezer compartment with wet or damp hands, when your refrigerator is in operation.
- Do not put glass containers, glass bottles or soda in the freezer.
- This appliance is not intended for use by persons (including children) with reduced physical, sensory or mental capabilities, or lack of experience and knowledge, unless they have been given supervision or instruction concerning the use of the appliance by a person responsible for their safety.
- Do not refreeze frozen food that has thawed completely. Doing so may result in a serious health issue.
- If you are throwing away your old refrigerator, make sure the CFC coolant is removed for proper disposal by a qualified servicer. If you release CFC coolant, you may be fined or imprisoned in accordance with the relevant environmental law.
- Junked or abandoned refrigerators are dangerous, even if they are sitting for only a few days. When disposing of the refrigerator, remove the packing materials from the door or take off the doors but leave the shelves in place so that children may not easily climb inside.
- If connected to a circuit protected by fuses, use time delay fuse.

 **WARNING**

This product contains chemicals known to the State of California to cause cancer and birth defects or other reproductive harm. **Wash hands after handling.**

**READ ALL INSTRUCTIONS BEFORE USING THE APPLIANCE.**

To reduce the risk of fire, electric shock, or personal injury when using your product, basic safety precautions should be followed, including the following:

 **CAUTION****Installation**

- The refrigerator must be properly installed in accordance with the Installer Instructions that were taped to the front of the refrigerator.
- Be careful when you unpack and install the refrigerator. Immediately dispose of plastic and other packing materials out of reach of children.
- The appliance must be positioned for easy access to a power source.

**Use**

- Close the door carefully when children are around.
- Keep fingers out of pinch point areas; clearances between the doors and cabinets are necessarily small. Be careful closing doors when children are nearby.
- If you store food improperly, be aware that it may fall and cause injury.
- Do not use aerosols near the refrigerator.
- Do not store articles on the top of the appliance.

**Maintenance**

- Do not use strong detergents like wax or thinners for cleaning. Clean with a soft cloth.
- Wipe foreign objects (such as dust and water) off the prongs of the power plug and contact areas regularly.
- Do not store, disassemble or repair the refrigerator by yourself.
- Remove any dust or foreign matter from the power plug pins.
- Do not use a wet or damp cloth when cleaning the plug.
- If the refrigerator is disconnected from the power supply, you should wait for at least five minutes before plugging it back in.
- If you notice a chemical or burning plastic smell or see smoke, unplug the refrigerator immediately and contact your LG Electronics Service Center.

**SAVE THESE INSTRUCTIONS**

# COMPONENTS

Use this page to become more familiar with the parts and features of your refrigerator.

\*The appearance and specifications of the actual product may differ depending on the model.

## Refrigerator Exterior

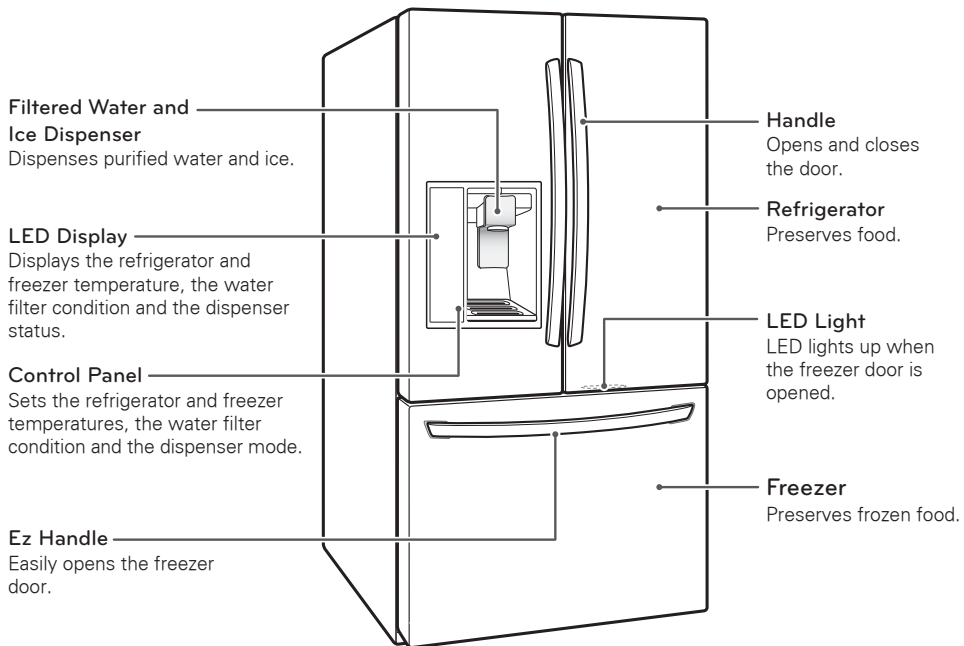

## Refrigerator Interior

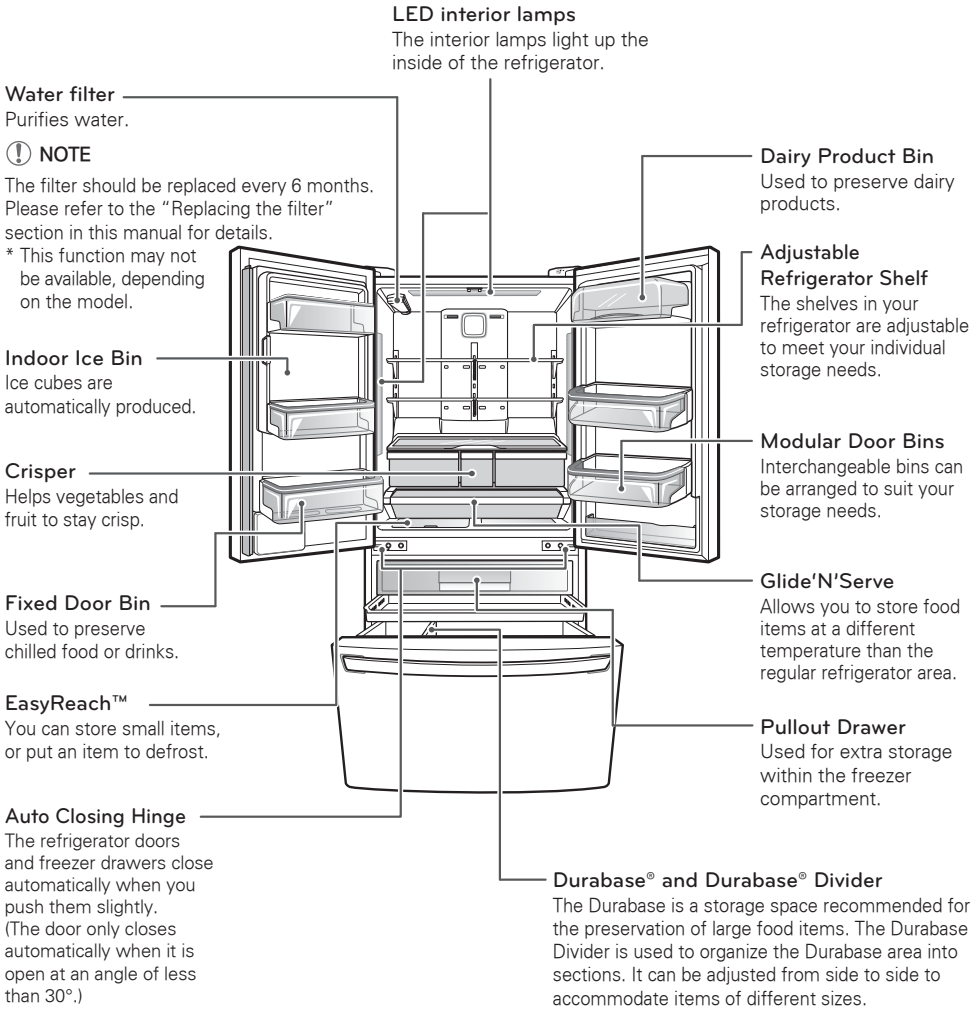



# INSTALLATION

## Installation Overview

Please read the following installation instructions first after purchasing this product or transporting it to another location.

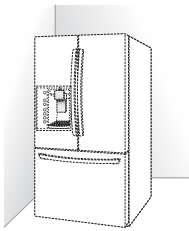

1 Unpacking your refrigerator

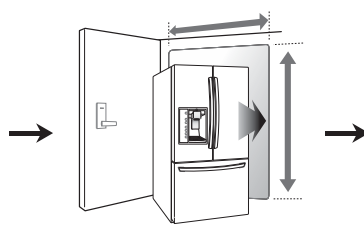

2 Choosing the proper location

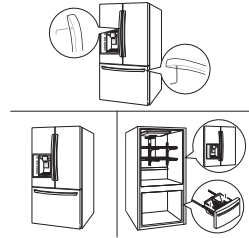

3 Disassembling/Assembling

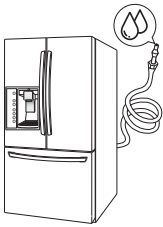

4 Connecting the water supply and water line

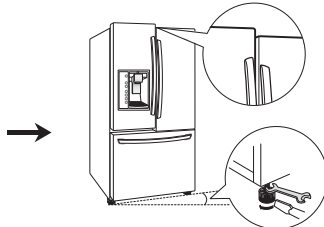

5 Leveling and Door Alignment



**NOTE**

Connect to potable water supply only.

## Specifications

The appearance and specifications listed in this manual may vary due to constant product improvements.

<b>Bottom-freezer refrigerator model LFXS32726* / LFXS32736*</b>	
<b>Description</b>	French door refrigerator
<b>Electrical requirements</b>	115 VAC @ 60 Hz
<b>Min. / Max. Water pressure</b>	20 - 120 psi (138 - 827 kPa)
<b>Dimensions</b>	35 3/4" (W) X 37 1/8" (D) X 70 1/4" (H), 49" (D w/ door open) 908 mm (W) X 943 mm (D) X 1785 mm (H), 1245 mm (D w/ door open)
<b>Net weight</b>	339 lb. (154 kg)

## Unpacking Your Refrigerator



### WARNING

- Use two or more people to move and install the refrigerator. Failure to do so can result in back or other injury.
- Your refrigerator is heavy. When moving the refrigerator for cleaning or service, be sure to protect the floor. Always pull the refrigerator straight out when moving it. Do not wiggle or walk the refrigerator when trying to move it, as floor damage could occur.
- Keep flammable materials and vapors, such as gasoline, away from the refrigerator. Failure to do so can result in fire, explosion, or death.

Remove tape and any temporary labels from your refrigerator before using. Do not remove any warning-type labels, the model and serial number label, or the Tech Sheet that is located under the front of the refrigerator.

To remove any remaining tape or glue, rub the area briskly with your thumb. Tape or glue residue can also be easily removed by rubbing a small amount of liquid dish soap over the adhesive with your fingers. Wipe with warm water and dry.

Do not use sharp instruments, rubbing alcohol, flammable fluids, or abrasive cleaners to remove tape or glue. These products can damage the surface of your refrigerator.

Refrigerator shelves are installed in the shipping position. Please reinstall shelves according to your individual storage needs.

## Choosing the Proper Location

- Select a place where a water supply can be easily connected for the automatic icemaker.



### NOTE

The water pressure must be 20 – 120 psi or 138 – 827 kPa or 1.4 – 8.4 kgf/cm<sup>2</sup>. If the refrigerator is installed in an area with low water pressure (below 20 psi), you can install a booster pump to compensate for the low pressure.

- The refrigerator should always be plugged into its own individual properly grounded electrical outlet rated for 115 Volts, 60 Hz, AC only, and fused at 15 or 20 amperes. This provides the best performance and also prevents overloading house wiring circuits which could cause a fire hazard from overheated wires. It is recommended that a separate circuit serving only this appliance be provided.



### WARNING

To reduce the risk of electric shock, do not install the refrigerator in a wet or damp area.

## Flooring

To avoid noise and vibration, the unit must be leveled and installed on a solidly constructed floor. If required, adjust the leveling legs to compensate for the unevenness of the floor. The front should be slightly higher than the rear to aid in door closing. Leveling legs can be turned easily by tipping the cabinet slightly. Turn the leveling legs to the left to raise the unit or to the right to lower it. (See Leveling and Door Alignment.)



### NOTE

Installing on carpeting, soft tile surfaces, a platform or weakly supported structure is not recommended.

### Ambient Temperature

Install this appliance in an area where the temperature is between 55°F (13°C) and 110°F (43°C). If the temperature around the appliance is too low or high, cooling ability may be adversely affected.

### Measuring the Clearances

Too small of a distance from adjacent items may result in lowered freezing capability and increased electricity consumption charges. Allow at least 24 inches (61 cm) in front of the refrigerator to open the doors, and at least 2 inches (5.08 cm) between the back of the refrigerator and the wall.

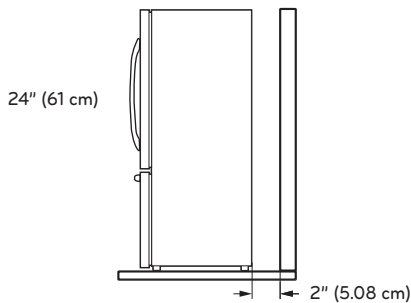

### Removing/Assembling the Refrigerator Door Handles

#### ! NOTE

When it is necessary to move the refrigerator through a narrow opening, removing the doors is the recommended procedure. If it is necessary to remove the handles, follow the directions below.

#### Removing the Handles

- 1 Loosen the set screws **1** with a  $\frac{3}{32}$  in. Allen wrench and remove the handle.
- 2 Loosen the mounting fasteners **2** that connect to the refrigerator door and handle using a  $\frac{1}{4}$  in. Allen wrench, and remove the mounting fasteners.

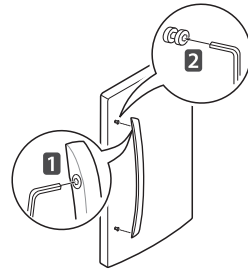

#### Assembling the Handles

- 1 Assemble the mounting fasteners **1** at both ends of the handle using a  $\frac{1}{4}$  in. Allen wrench.
- 2 Place the handle on the door by fitting the handle footprints over the mounting fasteners and tightening the set screws **2** with a  $\frac{3}{32}$  in. Allen wrench.

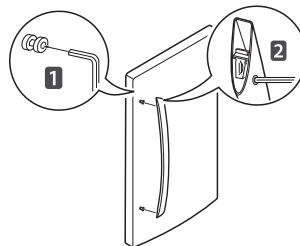

## Removing/Assembling the Freezer Drawer Handle

### Removing the Handles

- 1 Loosen the set screws **1** located on the lower side of the handle with a  $\frac{1}{8}$  in. Allen wrench and remove the handle.
- 2 Loosen the mounting fasteners **2** that connect to the freezer drawer and handle using a  $\frac{1}{4}$  in. Allen wrench, and remove the mounting fasteners.

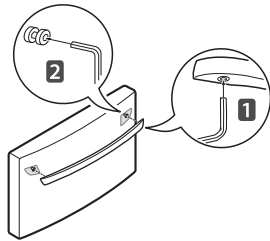

### Assembling the Handles

- 1 Assemble the mounting fasteners **1** at both ends of the handle using a  $\frac{1}{4}$  in. Allen wrench.
- 2 Place the handle on the door by fitting the handle footprints over the mounting fasteners and tightening the set screws **2** with a  $\frac{1}{8}$  in. Allen wrench.

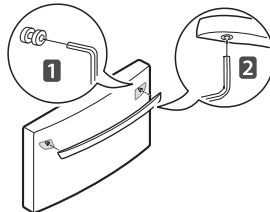

### WARNING

When assembling or disassembling the handle:

- Grasp the handle tightly to avoid dropping it.
- Do not swing the handle into nearby people or animals.
- Make sure that the bracket hole of the handle fits properly into the stopper bolt of the door. Assemble the set screws to fix the handle into place.
- Make sure that there is not a gap between the door and handle after assembling the handle.

## Removing/Assembling the Doors and Drawers

When it is necessary to move the refrigerator through a narrow opening, removing the doors is the recommended procedure.



### WARNING

- If your entrance door is too narrow for the refrigerator to pass through, remove the refrigerator doors and move the refrigerator sideways through the doorway.
- Use two or more people to remove and install the refrigerator doors. Failure to do so can result in back or other injury.
- Disconnect the electrical supply to the refrigerator before installing. Failure to do so could result in serious injury or death.
- Do not put hands, feet or other objects into the air vents or bottom of the refrigerator. You may be injured or receive an electrical shock.
- Be careful when handling the hinge and stopper, to avoid injury.
- Remove food and bins before detaching the doors and drawers.

### Removing the Left Refrigerator Door

- 1 The water supply is connected to the upper right part of the rear surface of the refrigerator. Remove the ring in the joint area. Hold the water supply connection and gently push the Collet to detach the water supply line as shown in **1** and **2**.

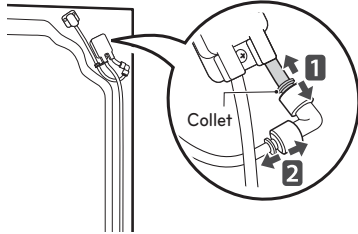

**NOTE**  
Detachment of the water supply line is applicable only when detaching the left refrigerator door.

- 2 Remove the **1** screw from the hinge cover at the top of the refrigerator. Lift the hook (not visible), located at the bottom of the front side of the cover **2** with a flat-head screwdriver.

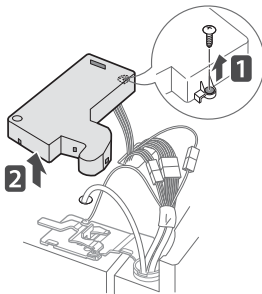

- 3 Remove the cover and pull out the tube **1**. Disconnect all wire harnesses **2**.

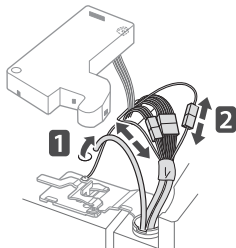

- 4 Rotate the hinge lever counterclockwise **1**. Lift the top hinge **2** free of the hinge lever latch.

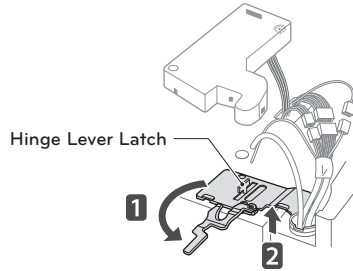

**CAUTION**  
When lifting the hinge free of the latch, be careful that the door does not fall forward.

- 5 Lift the door from the middle hinge pin and remove the door.

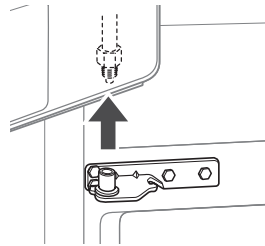

**CAUTION**  
Place the door, inside facing up, on a non-scratching surface.

### Removing the Right Refrigerator Door

- 1 Remove the top hinge cover screw **1**.  
Lift the hook (not visible), located at the bottom of the front side of the cover **2**, with a flat-head screwdriver.

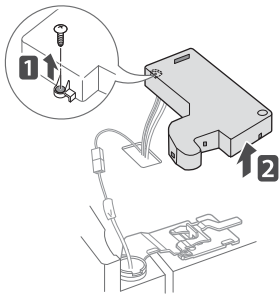

- 2 Detach the wire harness **1**.

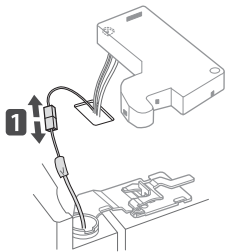

- 3 Rotate the hinge lever **1** clockwise.  
Lift the top hinge **2** free of the hinge lever latch.

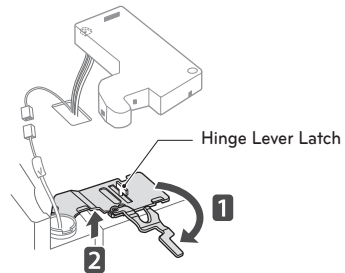

#### CAUTION

When lifting the hinge free of the hinge lever latch, be careful that the door does not fall forward.

- 4 Lift the door from the middle hinge pin and remove the door.

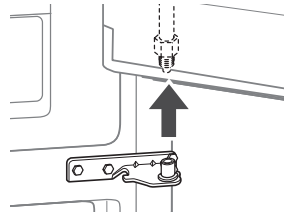

#### CAUTION

Place the door on the floor, inside facing up, on a non-scratching surface.

### Assembling the Right Refrigerator Door

Install the right-side door first.

- 1 Make sure that the plastic sleeve is inserted in the bottom of the door. Lower the door onto the middle hinge pin as shown in the figure.

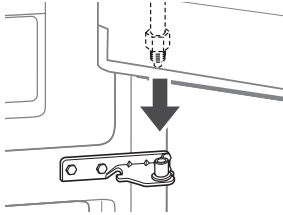

- 2 Fit the hinge **1** over the hinge lever latch and slot it into place. Rotate the lever **2** counterclockwise to secure the hinge.

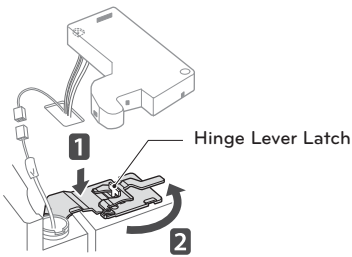

- 3 Connect the wire harness **1**.

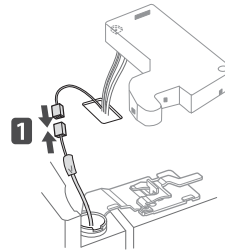

- 4 Make sure that the door-switch located inside the cover is tightly connected. Position the cover in its place. Insert and tighten the cover screw **2**.

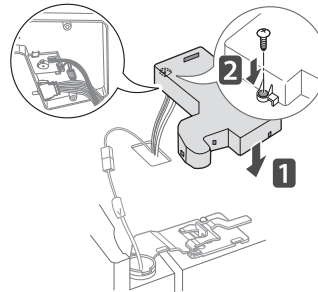



### Assembling the Left Refrigerator Door

Install the left refrigerator door after the right door is installed.

- 1 Make sure that the plastic sleeve is inserted in the bottom of the door. Install the refrigerator door onto the middle hinge.

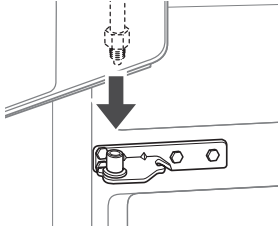

- 2 Fit the hinge **1** over the hinge lever latch and slot it into place. Rotate the lever clockwise **2** and fasten the hinge.

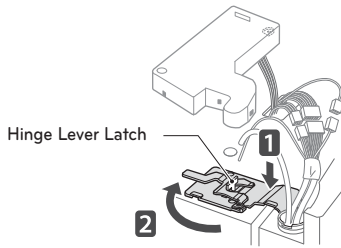

- 3 Connect all the wire harnesses.

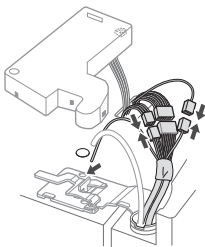

- 4 Push the water supply tube into the hole on the top case and pull it through the backplate.

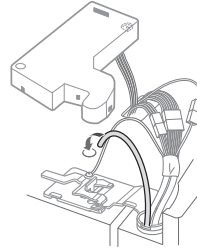

- 5 Hold the water supply connection and gently push in the collet to connect the water supply line as shown in **1** and **2**. Insert the tube at least  $\frac{5}{8}$  inch (15 mm) into the connector. Assemble the clip to the joint part for fastening.

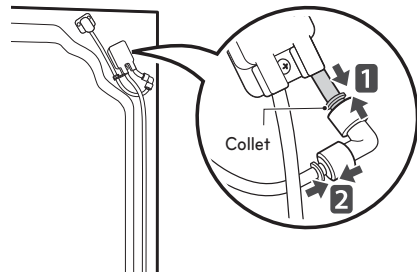

- 6 Make sure that the door-switch located inside the cover is tightly connected. Place the cover **1** in its position and tighten the cover screw **2**.

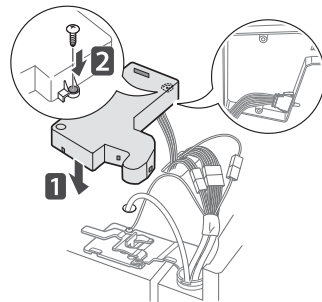

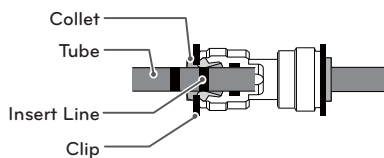
**NOTE**

- 1) Gently press the Collet and insert the tube until only one line shows on the tube.

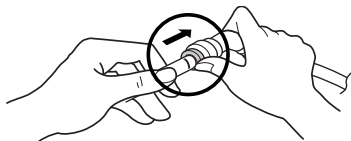

(Correct)

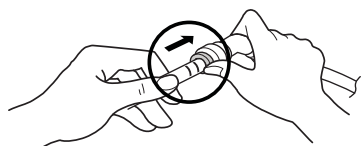

(Incorrect)

- 2) Pull the tube to make sure that the tube is tightly fastened and then insert the clip.

**Removing the Freezer Drawers**

In the following figures, the Pullout Drawer located above the freezer drawer is not shown for clarity.

**CAUTION**

- Use two or more people to remove and install the freezer drawer. Failure to do so can result in back or other injury.
- Do not hold the handle when removing or replacing the drawer. The handle may come off and it could cause personal injury.
- Be careful of sharp hinges on both sides of the drawer.
- When you lay the drawer down, be careful not to damage the floor.
- Do not sit or stand on the freezer drawer.
- To prevent accidents, keep children and pets away from the drawer. Do not leave the drawer open. If the Durabase® storage bin is removed from the freezer drawer, there is sufficient space for a small child or pet to crawl inside.

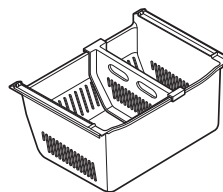

(Durabase®)

- 1 Pull the drawer open to full extension.
- 2 Gently lift and pull out the ice bin.

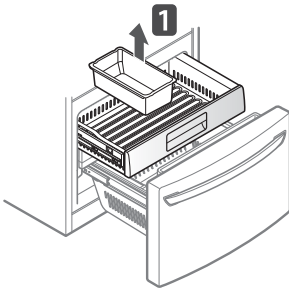

On the left rail, use a flat blade screwdriver to push in on the tab to release the drawer from the rail, as shown below. Once the left side is loose, push the tab on the right side with your finger to release the drawer. Lift the front of the drawer up, then pull it straight out.

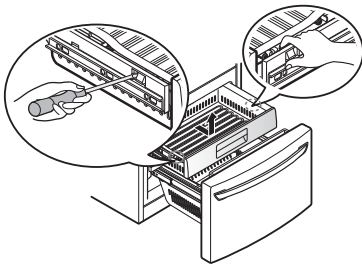

- 3 Remove the screws from the rails at both ends.

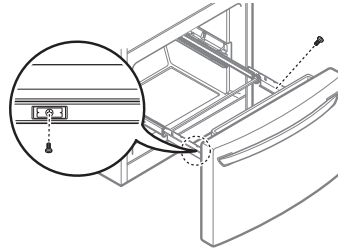

- 4 Grip both sides of the drawer and pull it up to remove it from the rails.

**CAUTION**  
Do not hold the handle when removing or replacing the drawer. The handle may come off, causing personal injury.

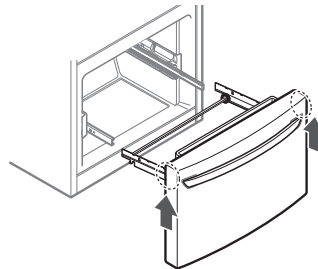

- 5 Hold both rails and push them in simultaneously.

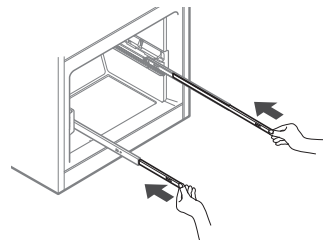

### Assembling the Freezer Drawers

- 1 Pull out both rails simultaneously, until both rails are fully extended.

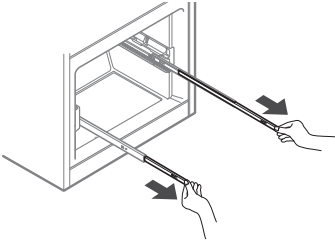

- 2 Grasp the drawer on each side and hook the drawer supports into the rail tabs located on both sides.

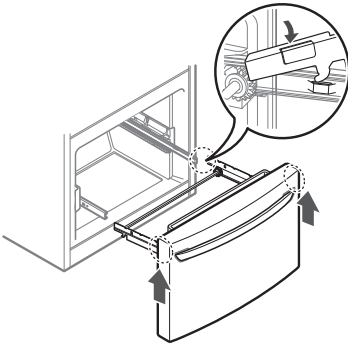

#### CAUTION

Do not hold the handle when removing or replacing the drawer. The handle may come off, causing personal injury.

- 3 Lower the door into its final position and tighten the screws located on both sides.

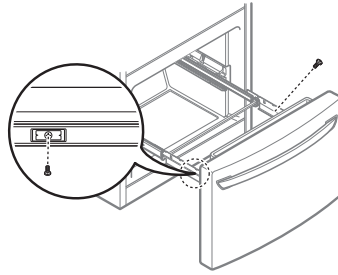

- 4 Insert the drawer into the frame, and push the drawer back into place until you hear a click.

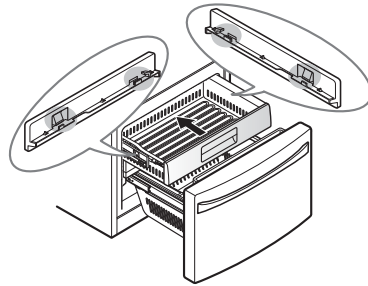

- 5 Insert the lower basket in the rail assembly.

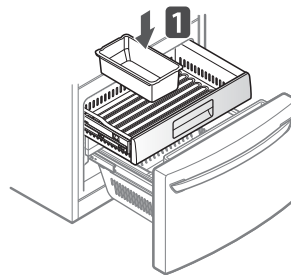

## Connecting the Water Line

### Before You Begin

This water line installation is not covered by the refrigerator warranty. Follow these instructions carefully to minimize the risk of expensive water damage.

Water hammer (water banging in the pipes) in house plumbing can cause damage to refrigerator parts and can lead to water leakage or flooding. Call a qualified plumber to correct water hammer before installing the water supply line to the refrigerator.

 **CAUTION**

To prevent burns and product damage, only connect the refrigerator water line to a cold water supply.

If you use your refrigerator before connecting the water line, make sure the icemaker power button is turned off.

 **CAUTION**

Do not install the icemaker tubing in areas where temperatures fall below freezing.

### Water Pressure

The water pressure must be between 20 and 120 psi. If the refrigerator is installed in an area with low water pressure (below 20 psi), you can install a booster pump to compensate for the low pressure.

If a reverse osmosis water filtration system is connected to your cold water supply, this water line installation is not covered by the refrigerator warranty. Follow the instructions carefully to minimize the risk of expensive water damage.

If a reverse osmosis water filtration system is connected to your cold water supply, the water pressure to the reverse osmosis system needs to be a minimum of 40 to 60 psi (276-414 kPa or 2.8-4.2 kgf/cm<sup>2</sup>, less than 2.0-3.0 sec. to fill a cup of 7 oz or 198 cc capacity).

 **CAUTION**

Wear eye protection during installation to prevent injury.

If the water pressure from the reverse osmosis system is less than 20 psi or 138 kPa or 1.4 kgf/cm<sup>2</sup> (takes more than 4.0 sec to fill a cup of 7 oz or 198 cc capacity):

- Check to see if the sediment filter in the reverse osmosis system is blocked. Replace the filter if necessary.
- Allow the storage tank on the reverse osmosis system to refill after heavy usage.
- If the issue concerning water pressure from reverse osmosis remains, call a licensed, qualified plumber.
- All installations must be in accordance with local plumbing code requirements.

### What You Will Need

- **Copper Tubing**, ¼ in. outer diameter, to connect the refrigerator to the water supply. Be sure both ends of the tubing are cut square.
- To determine how much tubing you need: measure the distance from the water valve on the back of the refrigerator to the water supply pipe. Then, add 8 feet (2.4 m). Be sure there is sufficient extra tubing (about 8 feet [2.4 m] coiled into 3 turns of about 10 in. [25 cm] diameter) to allow the refrigerator to move out from the wall after installation.

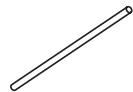

- **Power drill.**
- **½ in. or adjustable wrench.**
- **Flat blade and Phillips head screwdrivers.**
- **Two ¼ in. outer diameter compression nuts and 2 ferrules (sleeves)** to connect the copper tubing to the shutoff valve and the refrigerator water valve.

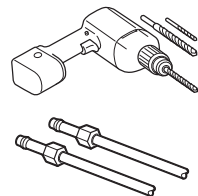

- If your existing copper water line has a flared fitting at the end, you will need an **adapter** (available at plumbing supply stores) to connect the water line to the refrigerator OR you can cut off the flared fitting with a tube cutter and then use a compression fitting.

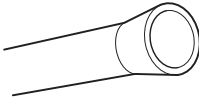

- **Shutoff valve to connect to the cold water line.** The shutoff valve should have a water inlet with a minimum inside diameter of 5/32 in. at the point of connection to the COLD WATER LINE. Saddle-type shutoff valves are included in many water supply kits. Before purchasing, make sure a saddle-type valve complies with your local plumbing codes.

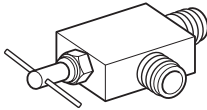

**NOTE**

A self piercing saddle type water valve should not be used.

**Water Line Installation Instructions**

**WARNING**

When using any electrical device (such as a power drill) during installation, be sure the device is battery powered, double insulated or grounded in a manner that will prevent the hazard of electric shock.

Install the shutoff valve on the nearest frequently used drinking water line.

- 1 SHUT OFF THE MAIN WATER SUPPLY  
Turn on the nearest faucet to relieve the pressure on the line.

- 2 CHOOSE THE VALVE LOCATION

Choose a location for the valve that is easily accessible. It is best to connect into the side of a vertical water pipe. When it is necessary to connect into a horizontal water pipe, make the connection to the top or side, rather than at the bottom, to avoid drawing off any sediment from the water pipe.

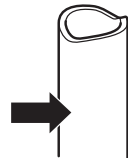

- 3 DRILL THE HOLE FOR THE VALVE

Drill a 1/4 in. hole in the water pipe using a sharp bit. Remove any burrs resulting from drilling the hole in the pipe. Be careful not to allow water to drain into the drill. Failure to drill a 1/4 in. hole may result in reduced ice production or smaller cubes.

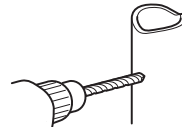

**NOTE**

The hookup line cannot be white, plastic tubing. Licensed plumbers must use only copper tubing (NDA tubing #49595 or #49599) or Cross Link Polyethylene (PEX) tubing.

4 FASTEN THE SHUTOFF VALVE

Fasten the shutoff valve to the cold water pipe with the pipe clamp.

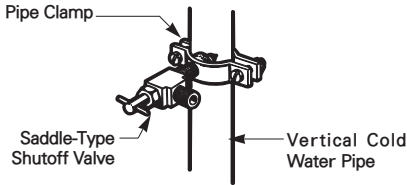

**NOTE**

Commonwealth of Massachusetts Plumbing Codes 248CMR shall be adhered to. Saddle valves are illegal and their use is not permitted in Massachusetts. Consult with your licensed plumber.

5 TIGHTEN THE PIPE CLAMP

Tighten the clamp screws until the sealing washer begins to swell.

**NOTE: Do not overtighten the clamp or you may crush the tubing.**

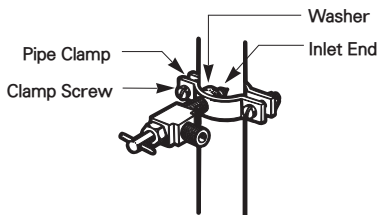

6 ROUTE THE TUBING

Route the tubing between the cold water line and the refrigerator.

Route the tubing through a hole drilled in the wall or floor (behind the refrigerator or adjacent base cabinet) as close to the wall as possible.

**NOTE**

Be sure there is sufficient extra tubing (about 8 feet coiled into 3 turns of about 10 in. diameter) to allow the refrigerator to move out from the wall after installation.

7 CONNECT THE TUBING TO THE VALVE

Place the compression nut and ferrule (sleeve) for copper tubing onto the end of the tubing and connect it to the shutoff valve. Make sure the tubing is fully inserted into the valve. Tighten the compression nut securely.

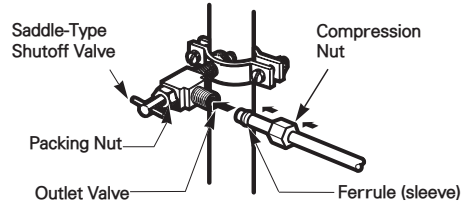

8 FLUSH OUT THE TUBING

Turn the main water supply on and flush out the tubing until the water is clear.

Shut the water off at the water valve after about one quart of water has been flushed through the tubing.



9 CONNECT THE TUBING TO THE REFRIGERATOR

**WARNING**

Before making the connection to the refrigerator, be sure that the refrigerator power cord is not plugged into the wall outlet.

- Remove the plastic flexible cap from the water valve.
- Place the compression nut and ferrule (sleeve) onto the end of the tubing as shown.
- Insert the end of the copper tubing into the connection as far as possible. While holding the tubing, tighten the fitting.

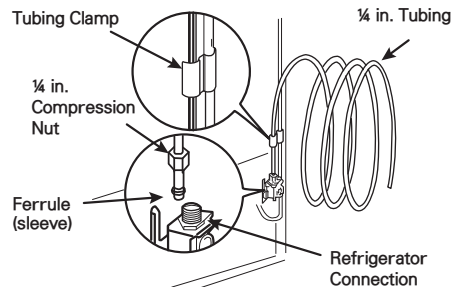

## 10 TURN THE WATER ON AT THE SHUTOFF VALVE

Tighten any connections that leak.

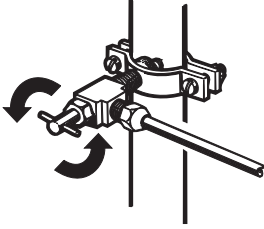

### CAUTION

Check to see if leaks occur at the water line connections.

## 11 PLUG IN THE REFRIGERATOR

Arrange the coil of tubing so that it does not vibrate against the back of the refrigerator or against the wall. Push the refrigerator back to the wall.

## 12 START THE ICEMAKER

Turn the icemaker on at the control panel.

The icemaker will not begin to operate until it reaches its operating temperature of 15°F (-9°C) or below. It will then begin operation automatically if the icemaker has been turned on.

## Turning On the Power

- 1 Plug in the refrigerator.

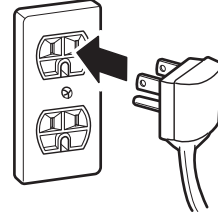

### CAUTION

- Connect to a rated power outlet.
- Have a certified electrician check the wall outlet and wiring for proper grounding.
- Do not damage or cut off the ground terminal of the power plug.



## Leveling and Door Alignment

### Leveling

After installing, plug the refrigerator's power cord into a 3-prong grounded outlet and push the refrigerator into the final position.

Your refrigerator has two front leveling legs—one on the right and one on the left. Adjust the legs to alter the tilt from front-to-back or side-to-side. If your refrigerator seems unsteady, or you want the doors to close more easily, adjust the refrigerator's tilt using the instructions below:

- 1 Turn the leveling leg to the left to raise that side of the refrigerator or to the right to lower it. It may take several turns of the leveling leg to adjust the tilt of the refrigerator.

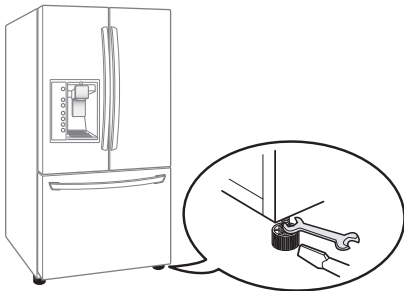

**NOTE**

A flare nut wrench works best, but an open-end wrench will suffice. Do not over-tighten.

- 2 Open both doors again and check to make sure that they close easily. If the doors do not close easily, tilt the refrigerator slightly more to the rear by turning both leveling legs to the left. It may take several more turns, and you should turn both leveling legs the same amount.

### Door Alignment

Both the left and right refrigerator doors have an adjustable nut, located on the bottom hinge, to raise and lower them to align properly. If the space between your doors is uneven, follow the instructions below to align the doors evenly:

Use the wrench (included with the Owner's Manual) to turn the nut in the door hinge to adjust the height. Turn it to the right to raise or to the left to lower the height.

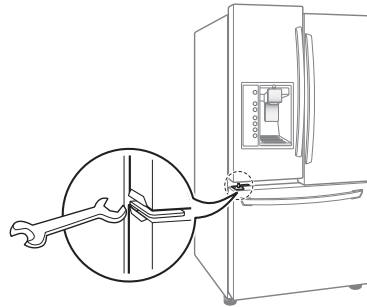

## HOW TO USE

### Before use



#### Clean the refrigerator.

Clean your refrigerator thoroughly and wipe off all dust that accumulated during shipping.



#### CAUTION

- Do not scratch the refrigerator with a sharp object or use a detergent that contains alcohol, a flammable liquid or an abrasive when removing any tape or adhesive from the refrigerator.
- Do not peel off the model or serial number label or the technical information on the rear surface of the refrigerator.



#### NOTE

Remove adhesive residue by wiping it off with your thumb or dish detergent.

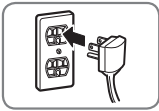

#### Connect the power supply.

Check if the power supply is connected before use.  
Read the "Turning On the Power" section.

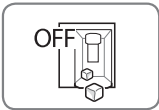

#### Turn off the icemaker if the refrigerator is not yet connected to the water supply.

Turn off the automatic icemaker and then plug the power plug of the refrigerator into the grounded electric outlet.

\* This is applicable only to certain models.



#### CAUTION

Running the automatic icemaker before connecting it to the water supply may cause the refrigerator to malfunction.



#### Wait for the refrigerator to cool.

Allow your refrigerator to run for at least two to three hours before putting food in it. Check the flow of cold air in the freezer compartment to ensure proper cooling.



#### CAUTION

Putting food in the refrigerator before it has cooled could cause the food to spoil, or a bad odor could linger inside the refrigerator.

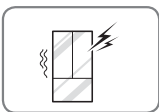

#### The refrigerator makes a loud noise after initial operation.

This is normal. The volume will decrease as the temperature lowers.

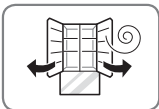

#### Open refrigerator doors and freezer drawers to ventilate the interior.

The inside of the refrigerator may smell like plastic at first. Remove any adhesive tape from inside the refrigerator and open the refrigerator doors and the freezer drawers for ventilation.

## Control Panel

\* Depending on the model, some of the following functions may not be available. The actual control panel may differ from model to model.

### Control Panel Features

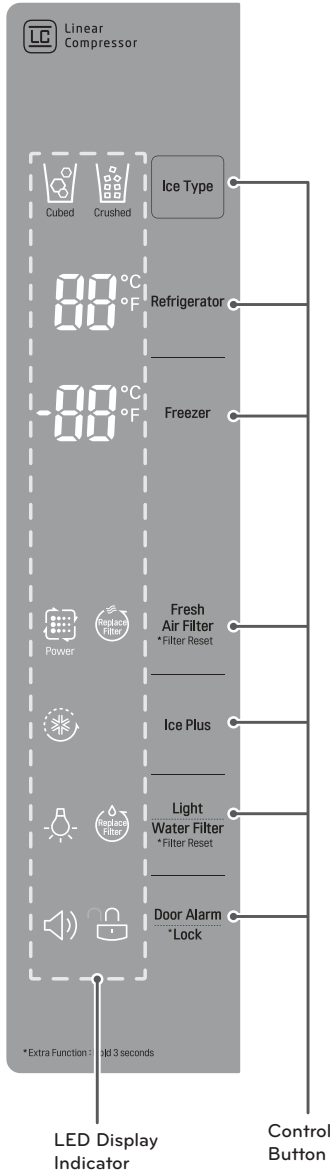

### Ice Type

Cubed Crushed

Press the Ice Type button to choose either cubed or crushed ice. The cubed or crushed ice icon will illuminate.

### Refrigerator Temperature

Indicates the set temperature of the refrigerator compartment in Celsius (°C) or Fahrenheit (°F).

### Freezer Temperature

Indicates the set temperature of the freezer compartment in Celsius (°C) or Fahrenheit (°F).

To change the temperature mode from °F to °C (or vice versa) press and hold the Refrigerator and Freezer temperature buttons simultaneously for approximately five seconds. The temperature indication on the display window switches between Celsius and Fahrenheit.

### NOTE

The displayed temperature is the target temperature, and not the actual temperature of the refrigerator. The actual refrigerator temperature depends on the food inside the refrigerator.

### Fresh Air Filter

Power

The Fresh Air Filter helps remove odors from the refrigerator. The Fresh Air Filter has two settings, Auto and Power. In Auto mode, the Fresh Air Filter will cycle on and off in increments of ten minutes on and one hundred ten minutes off. If set to the Power mode, the Fresh Air Filter will stay on continuously for four hours, cycling on and off in increments of ten minutes on and five minutes off. After four hours, the Fresh Air Filter will switch back to Auto mode.

- Press the Air Filter button once for Power mode.
- Press the Air Filter button again to switch back to Auto mode.

## Control Panel Features (continued)

### Change Filter



When the Change Filter icon turns on, the air filter needs to be replaced. After replacing the air filter, press and hold the Fresh Air Filter button for three seconds to turn the icon light off. Changing the air filter approximately every six months is recommended.

### Ice Plus



This function increases both ice making and freezing capabilities.

- When you touch the Ice Plus button, the graphic will illuminate in the display and will continue for 24 hours. The function will automatically shut off after 24 hours.
- You can stop this function manually by touching the button one more time.

### Ice On/Off



Press the Ice On/Off button for three seconds to turn the icemaker on/off.

### Light



When you press the Light button, the dispenser light will turn on and the indicator will appear on the LED display.

### Change Water Filter



When the water filter indicator turns on, you need to change the water filter. After changing the water filter, press and hold the Change Filter button for three seconds to turn the indicator light off. You need to change the water filter approximately every six months.

### Door Alarm



- When power is connected to the refrigerator, the door alarm is initially set to ON. When you press the Door Alarm button, the display will change to OFF and the Door Alarm function will deactivate.
- When either the refrigerator or the freezer door is left open for more than 60 seconds, the alarm tone will sound to let you know that the door is open.
- When you close the door, the door alarm will stop.

### Lock



**The Lock function disables every other button on the display.**

- When power is initially connected to the refrigerator, the Lock function is off.
- If you want to activate the Lock function to lock other buttons, press and hold the Lock button for three seconds or more. The Lock icon will display and the Lock function is now enabled.
- To disable the Lock function, press and hold the **Lock** button for approximately three seconds.



### CAUTION

#### Display Mode (For Store Use Only)

The Display Mode disables all cooling in the refrigerator and freezer sections to conserve energy while on display in a retail store. When activated OFF will display on the control panel and the display will remain on for 20 seconds.

#### To deactivate / activate:

With either refrigerator door opened, press and hold the Refrigerator and Ice Plus buttons at the same time for five seconds. The control panel will beep and the temperature settings will display to confirm that Display Mode is deactivated. Use the same procedure to activate the Display Mode.

## In-Door Ice Bin

\* Depending on the model, some of the following functions may not be available.

### CAUTION

- Keep hands and tools out of the ice compartment door and dispenser chute. Failure to do so may result in damage or personal injury.
- The icemaker will stop producing ice when the in-door ice bin is full. If you need more ice, empty the ice bin into the extra ice bin in the freezer compartment. During use, the ice can become uneven causing the icemaker to misread the amount of ice cubes and stop producing ice. Shaking the ice bin to level the ice within it can reduce this problem.
- Storing cans or other items in the ice bin will damage the icemaker.
- Keep the ice compartment door closed tightly. If the ice compartment door is not closed tightly, the cold air in the ice bin will freeze food in the refrigerator compartment. This could also cause the icemaker to stop producing ice.
- If the Ice On/Off button on the display is set to OFF for an extended period of time, the ice compartment will gradually warm up to the temperature of the refrigerator compartment. To prevent ice cubes from melting and leaking from the dispenser, ALWAYS empty the ice bin when the icemaker is set to OFF for more than a few hours.

## Detaching the In-Door Ice Bin

- 1 Gently pull the handle to open the ice compartment.

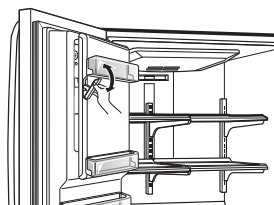

- 2 To remove the in-door ice bin, grip the front handle, slightly lift the lower part, and slowly pull out the bin as shown.

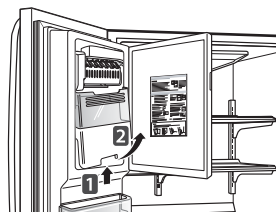

## Assembling the In-Door Ice Bin

- 1 Carefully insert the in-door ice bin while slightly slanting it to avoid contact with the icemaker.

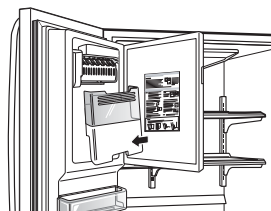

- 2 Avoid touching the auto shutoff (feeler arm) when replacing the ice bin. See the label on the ice compartment door for details.

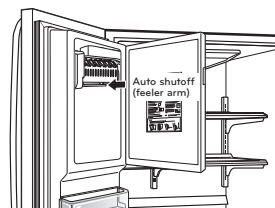

### CAUTION

When handling the ice bin, keep hands away from the icemaker tray area to avoid personal injury.

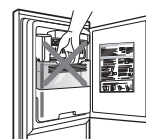

## Automatic Icemaker

\* Depending on the model, some of the following functions may not be available.

Ice is made in the automatic icemaker and sent to the dispenser. The icemaker will produce 70-182 cubes in a 24-hour period, depending on freezer compartment temperature, room temperature, number of door openings and other operating conditions.

- It takes about 12 to 24 hours for a newly installed refrigerator to begin making ice. Wait 72 hours for full ice production to occur.
- Ice making stops when the in-door ice bin is full. When full, the in-door ice bin holds approximately 6 to 8 (12-16 oz) glasses of ice.
- Foreign substances or frost on the auto shutoff (feeler arm) can interrupt ice production. Make sure the feeler arm is clean at all times for proper operation.
- To increase ice production, use the Ice Plus function. The function increases both ice making and freezing capabilities.



### WARNING

#### Personal Injury Hazard

DO NOT place fingers or hands on the automatic ice making mechanism while the refrigerator is plugged in.

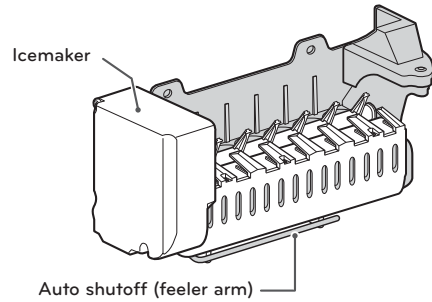

### Turning the Automatic Icemaker On or Off

To turn the automatic icemaker On/Off, press and hold the Ice On/Off button on the control panel for three seconds.

## Automatic Icemaker (continued)



### CAUTION

- The first ice and water dispensed may include particles or odor from the water supply line or the water tank.
- Throw away the first few batches of ice. This is also necessary if the refrigerator has not been used for a long time.
- Never store beverage cans or other items in the ice bin for the purpose of rapid cooling. Doing so may damage the icemaker or the containers may burst.
- If discolored ice is dispensed, check the water filter and water supply. If the problem continues, contact a qualified service center. Do not use the ice or water until the problem is corrected.
- Keep children away from the dispenser. Children may play with or damage the controls.
- The ice passage may become blocked with frost if only crushed ice is used. Remove the frost that accumulates by removing the ice bin and clearing the passage with a rubber spatula. Dispensing cubed ice can also help prevent frost buildup.
- Never use thin crystal glass or crockery to collect ice. Such containers may chip or break resulting in glass fragments in the ice.
- Dispense ice into a glass before filling it with water or other beverages. Splashing may occur if ice is dispensed into a glass that already contains liquid.
- Never use a glass that is exceptionally narrow or deep. Ice may jam in the ice passage and refrigerator performance may be affected.
- Keep the glass at a proper distance from the ice outlet. A glass held too close to the outlet may prevent ice from dispensing.
- To avoid personal injury, keep hands out of the ice door and passage.
- Never remove the dispenser cover.
- If ice or water dispenses unexpectedly, turn off the water supply and contact a qualified service center.

## When You Should Turn the Icemaker Off

- When the water supply will be shut off for several hours.
- When the ice bin is removed for more than one or two minutes.
- When the refrigerator will not be used for several days.



### NOTE

The ice bin should be emptied when the Ice On/Off button is turned to the OFF mode.

## Normal Sounds You May Hear

- The icemaker water valve will buzz as the icemaker fills with water. If the power button has been turned on, the ice maker will buzz even if it has not yet been hooked up to water. To stop the buzzing, press the power button to turn it off.



### NOTE

Keeping the power turned on to the icemaker before the water line is connected can damage the icemaker.

- You will hear the sound of cubes dropping into the bin and water running in the pipes as the icemaker refills.

## Preparing For Vacation

Set the icemaker power button to OFF and shut off the water supply to the refrigerator.



### NOTE

The ice bin should be emptied any time the Ice On/Off button is turned off.

If the ambient temperature will drop below freezing, have a qualified technician drain the water supply system to prevent serious property damage due to flooding caused by ruptured water lines or connections.

## Ice and Water Dispenser

\* Depending on the model, some of the following functions may not be available.

**CAUTION**  
Keep children away from the dispenser. Children may play with or damage the controls.

### Dispenser

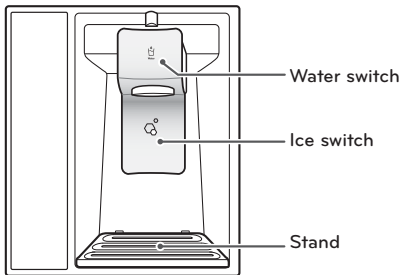

### Using the Dispenser

- To dispense **cold water**, push on the water switch with a glass.
- To dispense **ice**, push on the ice switch with a glass.

**NOTE**

- If discolored ice is dispensed, check the water filter and water supply. If the problem continues, contact a qualified service center. Do not use the ice or water until the problem is corrected.
- The dispenser will not operate when either of the refrigerator doors are open.
- If dispensing water or ice into a container with a small opening, place it as close to the dispenser as possible.
- Some dripping may occur after dispensing. Hold your cup beneath the dispenser for a few seconds after dispensing to catch all of the drops.

	Incorrect Way	Correct Way
Water		
Ice		

**CAUTION**  
Throw away the first few batches of ice (about 24 cubes). This is also necessary if the refrigerator has not been used for a long time.

### Locking the Dispenser

Press and hold the Alarm and Lock buttons simultaneously for three seconds to lock the dispenser and all the control panel functions. Follow the same instructions to unlock.

### Cleaning the Dispenser Stand

- 1 Grip the stand with both hands and pull it out.

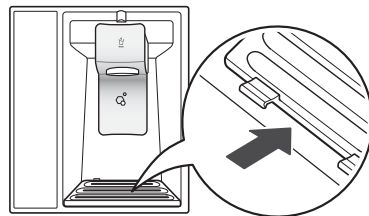

- 2 Wipe out dirty areas with a clean cloth.



## Storing Food

### Food Preservation Location

Each compartment inside the refrigerator is designed to store different types of food. Store your food in the optimal space to enjoy the freshest taste.

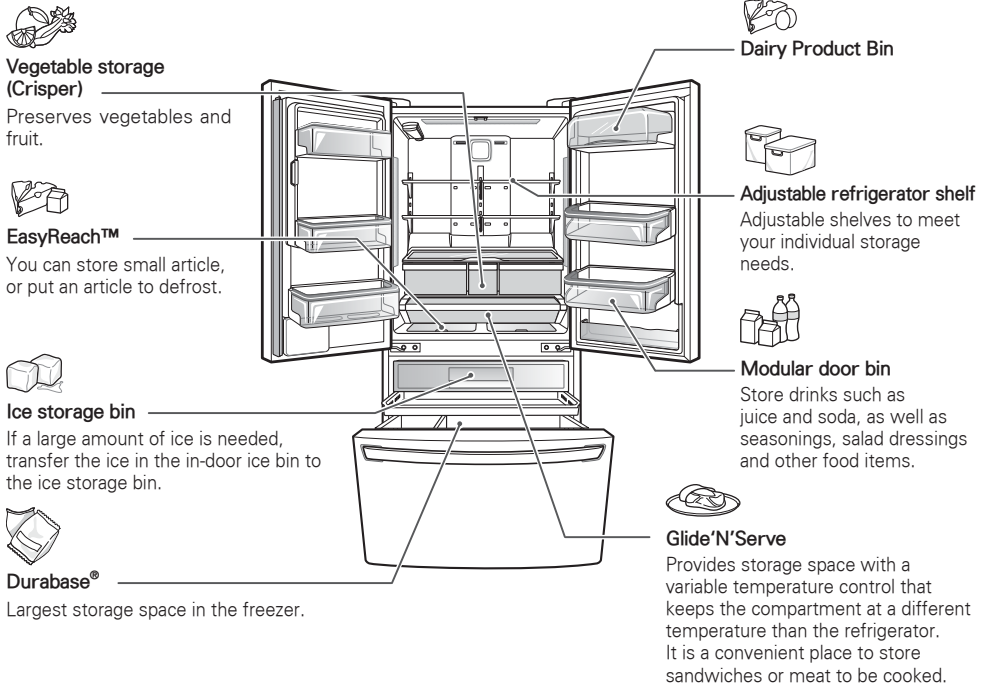

### CAUTION

- Do not store food with high moisture content towards the top of the refrigerator. The moisture could come in direct contact with the cold air and freeze.
- Wash food before storing it in the refrigerator. Vegetables and fruit should be washed, and food packaging should be wiped down to prevent adjacent foods from being contaminated.
- If the refrigerator is kept in a hot and humid place, frequent opening of the door or storing a lot of vegetables in the refrigerator may cause condensation to form. Wipe off the condensation with a clean cloth or a paper towel.
- If the refrigerator door or freezer drawer is opened or closed too often, warm air may penetrate the refrigerator and raise its temperature. It can also increase the running costs of the unit.
- The temperature inside the EasyReach™ is slightly lower than in the shelf or door bin area.
- Do not overfill or pack items too tightly into door bins. Doing so may cause damage to the bin or personal injury if items are removed with excessive force.
- Do not store liquids in glass bottles in the pantry. If they freeze, they can break and cause injury.



### NOTE

- If you are leaving home for a short period of time, like a short vacation, the refrigerator should be left on. Refrigerated foods that are able to be frozen will stay preserved longer if stored in the freezer.
- If you are leaving the refrigerator turned off for an extended period of time, remove all food and unplug the power cord. Clean the interior, and leave the door open to prevent fungi from growing in the refrigerator.

## Food Storage Tips

\* The following tips may not be applicable depending on the model.

Wrap or store food in the refrigerator in airtight and moisture-proof material unless otherwise noted. This prevents food odor and taste transfer throughout the refrigerator. For dated products, check date code to ensure freshness.

Food	How to
<b>Butter or Margarine</b>	Keep opened butter in a covered dish or closed compartment. When storing an extra supply, wrap in freezer packaging and freeze.
<b>Cheese</b>	Store in the original wrapping until you are ready to use it. Once opened, rewrap tightly in plastic wrap or aluminum foil.
<b>Milk</b>	Wipe milk cartons. For coldest milk, place containers on interior shelf.
<b>Eggs</b>	Store in original carton on interior shelf, not on door shelf.
<b>Fruit</b>	Do not wash or hull the fruit until it is ready to be used. Sort and keep fruit in its original container, in a crisper, or store in a completely closed paper bag on a refrigerator shelf.
<b>Leafy Vegetables</b>	Remove store wrapping and trim or tear off bruised and discolored areas. Wash in cold water and drain. Place in plastic bag or plastic container and store in crisper.
<b>Vegetables with skins (carrots, peppers)</b>	Place in plastic bags or plastic container and store in crisper.
<b>Fish</b>	Store fresh fish and shellfish in the freezer section if they are not being consumed the same day of purchase. It is recommended to consume fresh fish and shellfish the same day purchased.
<b>Leftovers</b>	Cover leftovers with plastic wrap or aluminum foil, or store in plastic containers with tight lids.

## Storing Frozen Food

### NOTE

Check a freezer guide or a reliable cookbook for further information about preparing food for freezing or food storage times.

## Freezing

Your freezer will not quick-freeze a large quantity of food. Do not put more unfrozen food into the freezer than will freeze within 24 hours (no more than 2 to 3 lbs. of food per cubic foot of freezer space). Leave enough space in the freezer for air to circulate around packages. Be careful to leave enough room at the front so the door can close tightly.

Storage times will vary according to the quality and type of food, the type of packaging or wrap used (how airtight and moisture-proof) and the storage temperature. Ice crystals inside a sealed package are normal. This simply means that moisture in the food and air inside the package have condensed, creating ice crystals.

### NOTE

Allow hot foods to cool at room temperature for 30 minutes, then package and freeze. Cooling hot foods before freezing saves energy.

## Storing Frozen Food (continued)

### Packaging

Successful freezing depends on correct packaging. When you close and seal the package, it must not allow air or moisture in or out. If it does, you could have food odor and taste transfer throughout the refrigerator and could also dry out frozen food.

### Packaging recommendations:

- Rigid plastic containers with tight-fitting lids
- Straight-sided canning/freezing jars
- Heavy-duty aluminum foil
- Plastic-coated paper
- Non-permeable plastic wraps
- Specified freezer-grade self-sealing plastic bags

Follow package or container instructions for proper freezing methods.

### Do not use

- Bread wrappers
- Non-polyethylene plastic containers
- Containers without tight lids
- Wax paper or wax-coated freezer wrap
- Thin, semi-permeable wrap

## Glide'N'Access™

The Glide'N'Access™ slides out for easy loading of large items, like sheet cakes or deli trays, and to give you easy access to items stored at the back of the shelf.

To slide out, grasp the handle at the front of the shelf and gently pull forward. Push back to slide in.



### CAUTION

Take care when sliding the Glide'N'Access™ in and out, as taller items may fall, causing damage or injury.

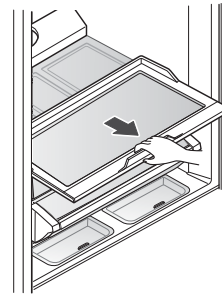

## Glide'N'Serve

The Glide'N'Serve provides storage space with a variable temperature control that can keep the compartment at a slightly different temperature than the refrigerator section. This drawer can be used for large party trays, deli items and beverages. (This drawer should not be used for vegetables that require high humidity.)

Press the **Select** button to choose between Produce (Cold), Deli (Colder) and Meat (Coldest).

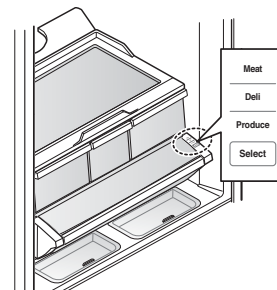

## Detaching and Assembling the Storage Bins

### Glide'N'Serve and Crisper

To remove the Crisper **1** and Glide'N'Serve **2**, pull out the Crisper **1** and Glide'N'Serve **2** to full extension, lift the front up, and pull straight out.

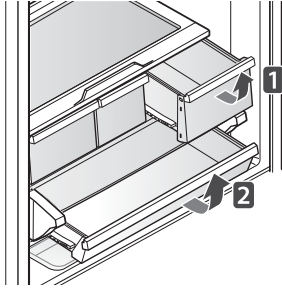

To install, slightly tilt up the front, insert the drawer into the frame and push it back into place.

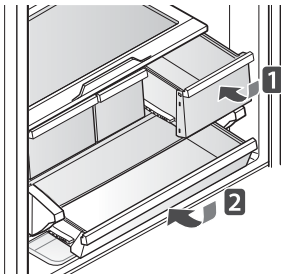

### EasyReach™

Open and close by pulling the handle.

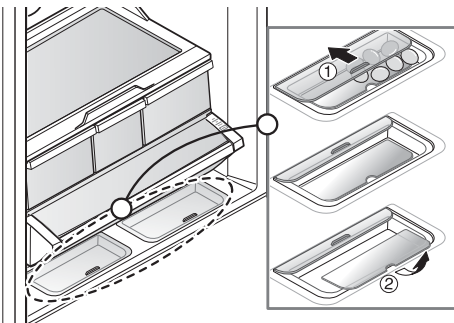

### To Remove Glide'N'Access™

To remove the Glide'N'Access™, pull out the shelf to full extension, lift the front up and pull straight out.

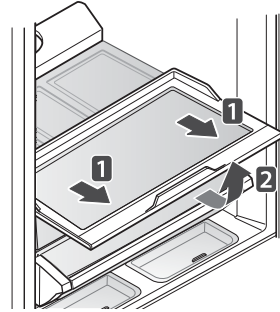

### Door Bins

The door bins are removable for easy cleaning and adjustment.

- 1 To remove the bin, simply lift the bin up and pull straight out.
- 2 To replace the bin, slide it in above the desired support and push down until it snaps into place.

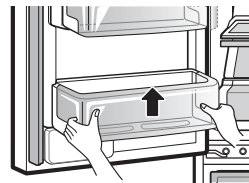

#### NOTE

Some bins may vary in appearance and will only fit in one location.

#### CAUTION

- Do not apply excessive force while detaching or assembling the storage bins.
- Do not use the dishwasher to clean the storage bins and shelves.
- Regularly detach and wash the storage bins and shelves; they can become easily contaminated by the food.

## Adjusting the Refrigerator Shelves

The shelves in your refrigerator are adjustable to meet your individual storage needs. Your model may have glass or wire shelves.

Adjusting the shelves to fit items of different heights will make finding the exact item you want easier. Doing so will also reduce the amount of time the refrigerator door is open which will save energy.

### Detaching the Shelf

Tilt up the front of the shelf and lift it straight up. Pull the shelf out.

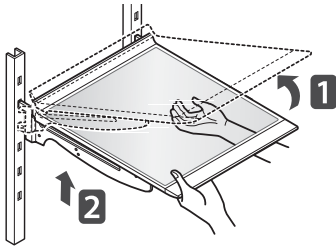

### Using the Folding Shelf

You can store taller items, such as a gallon container or bottles, by simply pushing the front half of the shelf underneath the back half of the shelf. Pull the front of the shelf toward you to return to a full shelf.

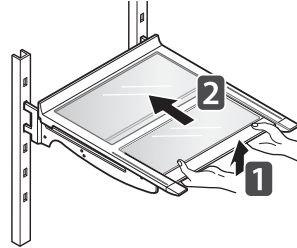

### CAUTION

- Do not clean glass shelves with warm water while they are cold. Shelves may break if exposed to sudden temperature changes or impact.
- Glass shelves are heavy. Use special care when removing them.

### Assembling the Shelf

Tilt the front of the shelf up and guide the shelf hooks into the slots at a desired height. Then, lower the front of the shelf so that the hooks drop into the slots.

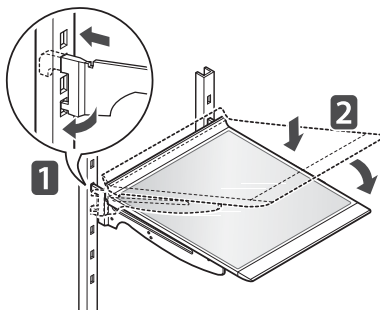

### CAUTION

Make sure that shelves are level from one side to the other. Failure to do so may result in the shelf falling or spilling food.

# MAINTENANCE

## Cleaning

- Both the refrigerator and freezer sections defrost automatically; however, clean both sections about once a month to prevent odors.
- Wipe up spills immediately.
- Always unplug the refrigerator before cleaning.

### General Cleaning Tips

- Unplug refrigerator or disconnect power.
- Remove all removable parts, such as shelves, crispers, etc.
- Use a clean sponge or soft cloth and a mild detergent in warm water. Do not use abrasive or harsh cleaners.
- Hand wash, rinse and dry all surfaces thoroughly.

### Exterior

Waxing external painted metal surfaces helps provide rust protection. Do not wax plastic parts. Wax painted metal surfaces at least twice a year using appliance wax (or auto paste wax). Apply wax with a clean, soft cloth.

For products with a stainless steel exterior, use a clean sponge or soft cloth and a mild detergent in warm water. Do not use abrasive or harsh cleaners. Dry thoroughly with a soft cloth.



#### CAUTION

- Do not use a rough cloth or sponge when cleaning the interior and exterior of the refrigerator.
- Do not place your hand on the bottom surface of the refrigerator when opening and closing.



#### WARNING

Use non-flammable cleaner. Failure to do so can result in fire, explosion, or death.

### Inside Walls (allow freezer to warm up so the cloth will not stick)

To help remove odors, you can wash the inside of the refrigerator with a mixture of baking soda and warm water. Mix 2 tablespoons of baking soda to 1 quart of water (26 g soda to 1 liter water). Be sure the baking soda is completely dissolved so it does not scratch the surfaces of the refrigerator.

### Door Liners and Gaskets

Use a clean sponge or soft cloth and a mild detergent in warm water. Do not use cleaning waxes, concentrated detergents, bleaches, or cleaners containing petroleum on plastic refrigerator parts.

### Plastic Parts (covers and panels)

Use a clean sponge or soft cloth and a mild detergent in warm water. Do not use glass cleaners, abrasive cleansers, or flammable fluids. These can scratch or damage the material.

### Condenser Coils

Use a vacuum cleaner with an attachment to clean the condenser cover and vents. Do not remove the panel covering the condenser coil area.

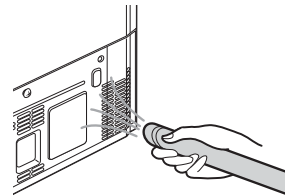

## Replacing the Fresh Air Filter

It is recommended that you replace the air filter:

- Approximately every six months.
- When the CHANGE FILTER light turns on.

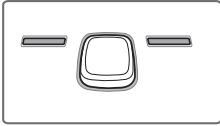

### 1 Remove the Old Filter

Turn the filter cover to the left to detach it from the refrigerator wall. The filter is located on the inside of the filter cover. Remove the filter from the cover and replace it with a new filter.

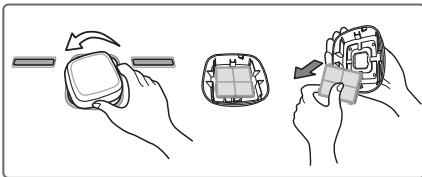

### 2 Install a New Air Filter.

Place the new filter inside of the cover with the side that says "Front" facing outward. Turn the filter cover to the right to attach it to the refrigerator wall.

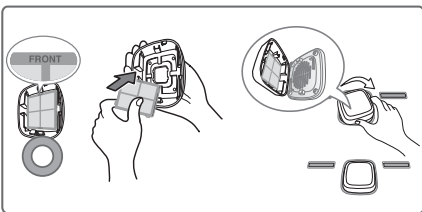

After changing the filter, push and hold the Air Filter button for three seconds to reset the filter sensor.

## Replacing the Water Filter

It is recommended that you replace the water filter:

- Approximately every six months.
- When the water filter indicator turns on.
- When the water dispenser output decreases.
- When the ice cubes are smaller than normal.

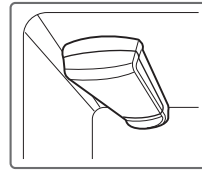

### Before Replacing the Water Filter:

If the top shelf, located below the water filter, is in the highest position, it will need to be removed prior to replacing the water filter.

To remove any shelf—Tilt up the front of the shelf **1** and lift it **2**. Pull the shelf out.

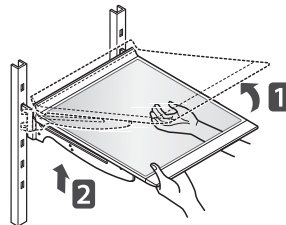

1 Remove the old water filter.

Lower or remove the top left shelf to allow the water filter to rotate all the way down.

Press the push button to open the water filter cover.

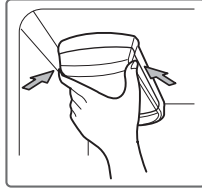

**NOTE:** Replacing the water filter causes a small amount of water (around 1 oz. or 25 cc) to drain. Place a cup under the front end of the water filter cover to collect any leaking water. Hold the water filter upright, once it is removed, to prevent any remaining water from spilling out of the water filter.

Pull the water filter downward and pull out. Make sure to rotate the filter down completely before pulling it out of the manifold hole.

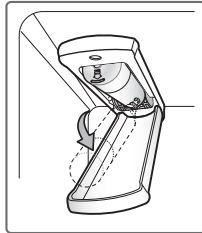

2 Replace with a new water filter.

Take the new water filter out of its packing and remove the protective cover from the o-rings. With the water filter tabs in the horizontal position, push the new water filter into the manifold hole until it stops.

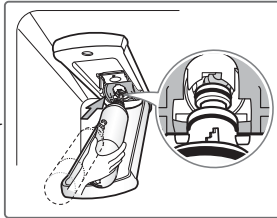

Rotate the water filter up into position and close the cover. The cover will click when closed correctly.

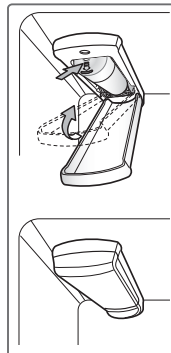

3 After the water filter is replaced, dispense 2.5 gallons of water (flush for approximately 5 minutes) to remove trapped air and contaminants from the system. Do not dispense the entire 2.5 gallon amount continuously. Depress and release the dispenser pad for cycles of 30 seconds ON and 60 seconds OFF.

4 Water Filter Bypass Plug

Keep the water filter bypass plug. You **MUST** use the water filter bypass plug when a replacement water filter cartridge is not available.

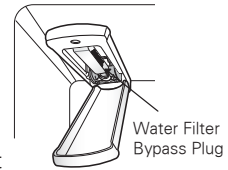

**CAUTION**  
DO NOT operate refrigerator without water filter or water filter plug installed.

**NOTE**

- To purchase a replacement water filter: Visit your local dealer or distributor  
Web: Find Parts & Accessories from Support section of lg.com  
Call : 1-800-243-0000 (USA)  
1-888-542-2623 (Canada)
- Part number of the replacement water filter: ADQ36006101



### Performance Data Sheet

**Model: LG ADQ36006101-S**      Use Replacement Cartridge: ADQ36006101

The concentration of the indicated substances in water entering the system was reduced to a concentration less than or equal to the permissible limit for water leaving the system as specified in NSF/ANSI Standard 42 and Standard 53.



System tested and certified by NSF International against NSF/ANSI Standard 42 and Standard 53 for the reduction of substances listed below.

Contaminant Reduction	Average Influent	NSF specified Challenge Concentration	Avg % Reduction	Average Product Water Concentration	Max Permissible Product Water Concentration	NSF Reduction requirements	NSF Test Report
Chlorine Taste and Odor	2.1 mg/L	2.0 mg/L ± 10%	97.2%	0.06 mg/L	N/A	≥ 50%	J-00049247
Nominal Particulate Class I, , ≥ 0.5 to < 1.0 µm	5,600,000 pts/mL	At least 10,000 particles/mL	98.7%	73,000 pts/ml	N/A	≥ 85%	J-00049282
Asbestos	190 MFL	10 <sup>7</sup> to 10 <sup>8</sup> MFL; fibers greater than 10 µm in length	>99%	< 1MLF	N/A	≥ 99%	J-0004928
Atrazine	0.0094 mg/L	0.009 mg/L ± 10%	94.7%	0.00005 mg/L	0.003 mg/L	N/A	J-00049293
Benzene	0.016 mg/L	0.015 mg/L ± 10%	96.7%	0.005 mg/L	0.005 mg/L	N/A	J-00049300
Carbofuran	0.08 mg/L	0.08 mg/L ± 10%	98.1%	0.002 mg/L	0.04 mg/L	N/A	J-00049294
Lindane	0.002 mg/L	0.002 mg/L ± 10%	98.2%	0.00004 mg/L	0.0002 mg/L	N/A	J-00051975
P-Dichlorobenzene	0.22 mg/L	0.225 mg/L ± 10%	99.8%	0.0005 mg/L	0.075 mg/L	N/A	J-00049298
Toxaphene	0.014 mg/L	0.015 mg/L ± 10%	93%	0.001 mg/L	0.003 mg/L	N/A	J-00049302
2,4-D	0.213 mg/L	0.210 mg/L ± 10%	95.2%	0.009 mg/L	0.07 mg/L	N/A	J-00049284
Lead pH @6.5	0.150 mg/L	0.15 mg/L ± 10%	>99.3%	0.001 mg/L	0.010 mg/L	N/A	J-00051974
Lead pH @8.5	0.150 mg/L	0.15 mg/L ± 10%	>99.3%	0.001 mg/L	0.010 mg/L	N/A	J-00049277
Mercury @ pH 6.5	0.0059 mg/L	0.006 mg/L ± 10%	96.1	0.0002 mg/L	0.002 mg/L	N/A	J-00053886
Mercury @ pH 8.5	0.0058 mg/L	0.006 mg/L ± 10%	90.1	0.0006 mg/L	0.002 mg/L	N/A	J-00051972
Cyst*	120,000 cysts/L	Minimum 50,000 cysts/L	99.99%	<1 cyst/L	N/A	≥ 99.95%	J-00049281

\* Based on the use of Cryptosporidium parvum oocysts.

Application Guidelines/Water Supply Parameters	
Service Flow	0.5 gpm (1.9 lpm)
Water Supply	Potable Water
Water Pressure	20 -120 psi (138 - 827 kPa)
Water Temperature	33°F - 100°F (0.6°C - 38°C)

It is essential that the manufacturer's recommended installation, maintenance and filter replacement requirements be carried out for the product to perform as advertised.

### NOTE

- While the testing was performed under standard laboratory conditions, actual performance may vary.

Replacement Cartridge: ADQ36006101

For estimated costs of replacement elements please call USA 1-800-243-0000  
CANADA 1-888-LGCANADA (24 hours per day/7 days per week) or visit our website at [www.lg.com](http://www.lg.com)

3M is a trademark of 3M Company.  
NSF is a trademark of NSF International.  
© 2009 3M Company. All rights reserved.

### WARNING

To reduce the risk associated with choking:

- Do not allow children under 3 years of age to have access to small parts during the installation of this product.

To reduce the risk associated with the ingestion of contaminants:

- Do not use with water that is microbiologically unsafe or of unknown quality without adequate disinfection before or after the system. Systems certified for cyst reduction may be used on disinfected water that may contain filterable cysts. EPA Establishment # 070595-MEX-001

### CAUTION

To reduce the risk associated with property damage due to water leakage:

- Read and follow Use Instructions before installation and use of this system.
- Installation and use MUST comply with all state and local plumbing codes.
- Do not install if water pressure exceeds 120 psi (827 kPa). If your water pressure exceeds 80 psi, you must install a pressure limiting valve. Contact a plumbing professional if you are uncertain how to check your water pressure.
- Do not install where water hammer conditions may occur. If water hammer conditions exist you must install a water hammer arrester. Contact a plumbing professional if you are uncertain how to check for this condition.
- Do not install on hot water supply lines. The maximum operating water temperature of this filter system is 100°F (37.8°C).
- Protect filter from freezing. Drain filter when temperatures drop below 40°F (4.4°C).
- The disposable filter cartridge MUST be replaced every 6 months, at the rated capacity or if a noticeable reduction in flow rate occurs.
- Protect from freezing, remove filter cartridge when temperatures are expected to drop below 33° F.
- Do not install systems in areas where ambient temperatures may go above 110° F (43.3° C).
- Where a backflow prevention device is installed on a water system, a device for controlling pressure due to thermal expansion must be installed.
- Ensure all tubing and fittings are secure and free of leaks.

Manufactured for LG®Electronics by CUNO Incorporated 400 Research Parkway Meriden, CT 06450 U.S.A Worldwide: 203-237-5541  
[www.cuno.com](http://www.cuno.com)

State of California  
 Department of Public Health  
**Water Treatment Device**  
**Certificate Number**  
**09 - 2018**

Date Issued: December 15, 2009

<b><u>Trademark/Model Designation</u></b> ADQ36006101-S	<b><u>Replacement Elements</u></b> ADQ36006101
<b>Manufacturer:</b> Cuno Inc.	

The water treatment device(s) listed on this certificate have met the testing requirements pursuant to Section 116830 of the Health and Safety Code for the following health related contaminants:

<b><u>Microbiological Contaminants and Turbidity</u></b>	<b><u>Inorganic/Radiological Contaminants</u></b>
Cysts	Asbestos
	Lead
	Mercury
<b><u>Organic Contaminants</u></b>	
2,4-D Reduction	
Atrazine	
Benzene	
Carbofuran	
Lindane	
p-Dichlorobenzene	
Toxaphene	
<b>Rated Service Capacity:</b> 200 gal	<b>Rated Service Flow:</b> 0.5 gpm

**Conditions of Certification:**

## SMART DIAGNOSIS™

Should you experience any problems with your refrigerator, it has the capability of transmitting data via your telephone to the LG service center. This gives you the capability of speaking directly to our trained specialists. The specialist records the data transmitted from your machine and uses it to analyze the issue, providing a fast and effective diagnosis.

If you experience problems with your refrigerator, call 1-800-243-0000. Only use the Smart Diagnosis™ feature when instructed to do so by the LG call center agent. The transmission sounds that you will hear are normal and sound similar to a fax machine.

Smart Diagnosis™ cannot be activated unless your refrigerator is connected to power. If your refrigerator is unable to turn on, then troubleshooting must be done without using Smart Diagnosis™.

### Using Smart Diagnosis™

First, call 1-800-243-0000. Only use the Smart Diagnosis™ feature when instructed to do so by the LG call center agent.

- 1 Lock the display. To lock the display, press and hold the Lock button for three seconds. (If the display has been locked for over five minutes, you must deactivate the lock and then reactivate it.)



- 2 Open the right refrigerator door.

- 3 Hold the mouthpiece of your phone in front of the speaker that is located on the right hinge of the refrigerator door, when instructed to do so by the call center.

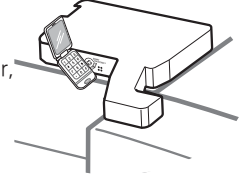

- 4 Press and hold the Freezer Temperature button for three seconds while continuing to hold your phone to the speaker.

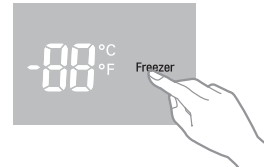

- 5 After you hear three beeps, release the Freezer Temperature button.
- 6 Keep the phone in place until the tone transmission has finished. The display will count down the time. Once the countdown is over and the tones have stopped, resume your conversation with the specialist, who will then be able to assist you in using the information transmitted for analysis.

#### NOTE

- For best results, do not move the phone while the tones are being transmitted.
- If the call center agent is not able to get an accurate recording of the data, you may be asked to try again.

#### NOTE

- Call quality differences by region may affect the function.
- Use the home telephone for better communication performance, resulting in better service.
- Bad call quality may result in poor data transmission from your phone to the machine, which could cause Smart Diagnosis™ to malfunction.

## TROUBLESHOOTING

Review the Troubleshooting section before calling for service; doing so will save you both time and money.

Problem	Possible Causes	Solutions
Refrigerator and Freezer section are not cooling.	The refrigerator control is set to OFF (some models).	Turn the control ON. Refer to the Setting the Controls section for proper temperature settings.
	Refrigerator is in the defrost cycle.	During the defrost cycle, the temperature of each compartment may rise slightly. Wait 30 minutes and confirm the proper temperature has been restored once the defrost cycle has completed.
	Refrigerator was recently installed.	It may take up to 24 hours for each compartment to reach the desired temperature.
	Refrigerator was recently relocated.	If the refrigerator was stored for a long period of time or moved on its side, it is necessary for the refrigerator to stand upright for 24 hours before connecting it to power.
Cooling System runs too much.	Refrigerator is replacing an older model.	Modern refrigerators require more operating time but use less energy due to more efficient technology.
	Refrigerator was recently plugged in or power restored.	The refrigerator will take up to 24 hours to cool completely.
	Door opened often or a large amount of food / hot food was added.	Adding food and opening the door warms the refrigerator, requiring the compressor to run longer in order to cool the refrigerator back down. In order to conserve energy, try to get everything you need out of the refrigerator at once, keep food organized so it is easy to find, and close the door as soon as the food is removed. (Refer to the Food Storage Guide.)
	Doors are not closed completely.	Firmly push the doors shut. If they will not shut all the way, see the Doors will not close completely or pop open section in Troubleshooting.
	Refrigerator is installed in a hot location.	The compressor will run longer under warm conditions. At normal room temperatures (70°F) expect your compressor to run about 40% to 80% of the time. Under warmer conditions, expect it to run even more often. The refrigerator should not be operated above 110°F.
	Condenser / back cover is clogged.	Use a vacuum cleaner with an attachment to clean the condenser cover and vents. Do not remove the panel covering the condenser coil area.

Problem	Possible Causes	Solutions
Refrigerator or Freezer section is too warm.	Refrigerator was recently installed.	It may take up to 24 hours for each compartment to reach the desired temperature.
	Air vents are blocked.	Rearrange items to allow air to flow throughout the compartment. Refer to the Airflow diagram in the Using Your Refrigerator section.
	Doors are opened often or for long periods of time.	When the doors are opened often or for long periods of time, warm, humid air enters the compartment. This raises the temperature and moisture level within the compartment. To lessen the effect, reduce the frequency and duration of door openings.
	Unit is installed in a hot location.	The refrigerator should not be operated in temperatures above 110F.
	A large amount of food or hot food was added to either compartment.	Adding food warms the compartment requiring the cooling system to run. Allowing hot food to cool to room temperature before putting it in the refrigerator will reduce this effect.
	Doors not closed correctly.	See the Doors will not close correctly or pop open section in Troubleshooting.
	Temperature control is not set correctly.	If the temperature is too warm, adjust the control one increment at a time and wait for the temperature to stabilize. Refer to the Setting the Controls section for more information.
	Defrost cycle has recently completed.	During the defrost cycle, the temperature of each compartment may rise slightly and condensation may form on the back wall. Wait 30 minutes and confirm the proper temperature has been restored once the defrost cycle has completed.

Problem	Possible Causes	Solutions
Interior moisture buildup.	Doors are opened often or for long periods of time.	When the doors are opened often or for long periods of time, warm, humid air enters the compartment. This raises the temperature and moisture level within the compartment. To lessen the effect, reduce the frequency and duration of door openings.
	Doors not closed correctly.	See the Doors will not close correctly section in the Troubleshooting section.
	Weather is humid.	Humid weather allows additional moisture to enter the compartments when the doors are opened leading to condensation or frost. Maintaining a reasonable level of humidity in the home will help to control the amount of moisture that can enter the compartments.
	Defrost cycle recently completed.	During the defrost cycle, the temperature of each compartment may rise slightly and condensation may form on the back wall. Wait 30 minutes and confirm that the proper temperature has been restored once the defrost cycle has completed.
	Food is not packaged correctly.	Food stored uncovered or unwrapped, and damp containers can lead to moisture accumulation within each compartment. Wipe all containers dry and store food in sealed packaging to prevent condensation and frost.
Food is freezing in the refrigerator compartment.	Food with high water content was placed near an air vent.	Rearrange items with high water content away from air vents.
	Refrigerator temperature control is set incorrectly.	If the temperature is too cold, adjust the control one increment at a time and wait for the temperature to stabilize. Refer to the Setting the Controls section for more information.
	Refrigerator is installed in a cold location.	When the refrigerator is operated in temperature below 41°F (5°C), food can freeze in the refrigerator compartment. The refrigerator should not be operated in temperature below 55°F (13°C).
Frost or ice crystals form on frozen food (outside of package).	Door is opened frequently or for long periods of time.	When the doors are opened often or for long periods of time, warm, humid air enters the compartment. This raises the temperature and moisture level within the compartment. Increased moisture will lead to frost and condensation. To lessen the effect, reduce the frequency and duration of door openings.
	Door is not closing properly.	Refer to the Doors will not close correctly or pop open section in the Troubleshooting section.
Refrigerator or Freezer section is too cold.	Incorrect temperature control settings.	If the temperature is too cold, adjust the control one increment at a time and wait for the temperature to stabilize. Refer to the Setting the Controls section for more information.

Problem	Possible Causes	Solutions
Frost or ice crystals on frozen food (inside of sealed package).	Condensation from food with a high water content has frozen inside of the food package.	This is normal for food items with a high water content.
	Food has been left in the freezer for a long period of time.	Do not store food items with high water content in the freezer for a long period of time.
Icemaker is not making enough ice.	Demand exceeds ice storage capacity.	The icemaker will produce approximately 70-182 cubes in a 24 hour period.
	House water supply is not connected, valve is not turned on fully, or valve is clogged.	Connect the refrigerator to a cold water supply with adequate pressure and turn the water shutoff valve fully open. If the problem persists, it may be necessary to contact a plumber.
	Water filter has been exhausted.	It is recommended that you replace the water filter: <ul style="list-style-type: none"> <li>• Approximately every six months.</li> <li>• When the water filter indicator turns on.</li> <li>• When the water dispenser output decreases.</li> <li>• When the ice cubes are smaller than normal.</li> </ul>
	Low house water supply pressure.	The water pressure must be between 20 and 120 psi on models without a water filter and between 40 and 120 psi on models with a water filter. If the problem persists, it may be necessary to contact a plumber or install a booster pump to compensate for the low pressure.
	Reverse Osmosis filtration system is used.	Reverse osmosis filtration systems can reduce the water pressure below the minimum amount and result in icemaker issues. (Refer to Water Pressure section.)
	Tubing connecting refrigerator to house supply valve is kinked.	The tubing can kink when the refrigerator is moved during installation or cleaning resulting in reduced water flow. Straighten or repair the water supply line and arrange it to prevent future kinks.



Problem	Possible Causes	Solutions
Icemaker is not making enough ice (continued).	Doors are opened often or for long periods of time.	If the doors of the unit are opened often, ambient air will warm the refrigerator which will prevent the unit from maintaining the set temperature. Lowering the refrigerator temperature can help, as well as not opening the doors as frequently.
	Doors are not closed completely.	If the doors are not properly closed, ice production will be affected. See the Doors will not close completely or pop open section in Troubleshooting for more information.
	The temperature setting for the freezer is too warm.	The recommended temperature for the freezer compartment for normal ice production is 0°F. If the freezer temperature is warmer, ice production will be affected.
Dispensing water slowly.	Water filter has been exhausted.	It is recommended that you replace the water filter: <ul style="list-style-type: none"> <li>• Approximately every six months.</li> <li>• When the water filter indicator turns on.</li> <li>• When the water dispenser output decreases.</li> <li>• When the ice cubes are smaller than normal.</li> </ul>
	Reverse osmosis filtration system is used.	Reverse osmosis filtration systems can reduce the water pressure below the minimum amount and result in icemaker issues.  If the problem persists, it may be necessary to contact a plumber or install a booster pump to compensate for the low pressure.
	Low house water supply pressure.	The water pressure must be between 20 and 120 psi on models without a water filter and between 40 and 120 psi on models with a water filter.  If the problem persists, it may be necessary to contact a plumber or install a booster pump to compensate for the low pressure.

Problem	Possible Causes	Solutions
Not dispensing ice.	Doors are not closed completely.	Ice will not dispense if any of the refrigerator doors are left open.
	Infrequent use of the dispenser.	Infrequent use of the ice dispenser will cause the cubes to stick together over time, which will prevent them from properly dispensing. Check the ice bin for ice cubes clumping/sticking together. If they are, break up the ice cubes to allow for proper operation.
	The delivery chute is clogged with frost or ice fragments.	Eliminate the frost or ice fragments by removing the ice bin and clearing the chute with a plastic utensil. Dispensing cubed ice can also help prevent frost or ice fragment buildup.
	The dispenser display is locked.	Press and hold the Lock button for three seconds to unlock the control panel and dispenser.
	Ice bin is empty.	It may take up to 24 hours for each compartment to reach the desired temperature and for the icemaker to begin making ice. Make sure that the shutoff (arm/sensor) is not obstructed.  Once the ice supply in the bin has been completely exhausted, it may take up to 90 minutes before additional ice is available, and approximately 24 hours to completely refill the bin.
Icemaker is not making ice.	Refrigerator was recently installed or icemaker recently connected.	It may take up to 24 hours for each compartment to reach the desired temperature and for the icemaker to begin making ice.
	Icemaker not turned on.	Locate the Ice On/Off button and confirm that it is turned on.
	The refrigerator is not connected to a water supply or the supply shutoff valve is not turned on.	Connect refrigerator to the water supply and turn the water shutoff valve fully open.
	Icemaker shutoff (feeler arm) obstructed.	If your icemaker is equipped with an ice shutoff arm, make sure that the arm moves freely. If your icemaker is equipped with the electronic ice shutoff sensor, make sure that there is a clear path between the two sensors.
	Reverse osmosis water filtration system is connected to your cold water supply.	Reverse osmosis filtration systems can reduce the water pressure below the minimum amount and result in icemaker issues. (Refer to the Water Pressure section.)

Problem	Possible Causes	Solutions
Not dispensing water.	New installation or water line recently connected.	Dispense 2.5 gallons of water (flush for approximately 5 minutes) to remove trapped air and contaminants from the system. Do not dispense the entire 2.5 gallon amount continuously. Depress and release the dispenser pad for cycles of 30 seconds ON and 60 seconds OFF.
	The dispenser panel is locked.	Press and hold the Lock button for three seconds to unlock the control panel and dispenser.
	The dispenser is not set for water dispensing.	The dispenser can be set for ice or water. Make certain that the control panel is set for the proper operation. Press the Water button on the control panel to dispense water.
	Refrigerator or freezer doors are not closed properly.	Water will not dispense if any of the refrigerator doors are left open.
	Water filter has been recently removed or replaced.	After the water filter is replaced, dispense 2.5 gallons of water (flush for approximately 5 minutes) to remove trapped air and contaminants from the system. Do not dispense the entire 2.5 gallon amount continuously. Depress and release the dispenser pad for cycles of 30 seconds ON and 60 seconds OFF.
	Tubing connecting refrigerator to house supply valve is kinked.	The tubing can kink when the refrigerator is moved during installation or cleaning resulting in reduced water flow. Straighten or repair the water supply line and arrange it to prevent future kinks.
	The house water supply is not connected, the valve is not turned on fully, or the valve is clogged.	Connect refrigerator to the water supply and turn the water shutoff valve fully open.  If the problem persists, it may be necessary to contact a plumber.

Problem	Possible Causes	Solutions
Ice has bad taste or odor.	Water supply contains minerals such as sulfur.	A water filter may need to be installed to eliminate taste and odor problems.  NOTE: In some cases, a filter may not help. It may not be possible to remove all minerals / odor / taste in all water supplies.
	Icemaker was recently installed.	Discard the first few batches of ice to avoid discolored or bad tasting ice.
	Ice has been stored for too long.	Ice that has been stored for too long will shrink, become cloudy, and may develop a stale taste. Throw away old ice and make a new supply.
	The food has not been stored properly in either compartment.	Rewrap the food. Odors may migrate to the ice if food is not wrapped properly.
	The interior of the refrigerator needs to be cleaned.	See the Care and Cleaning section for more information.
	The ice storage bin needs to be cleaned.	Empty and wash the bin (discard old cubes). Make sure that the bin is completely dry before reinstalling it.
Dispensing warm water.	Refrigerator was recently installed.	Allow 24 hours after installation for the water storage tank to cool completely.
	The water dispenser has been used recently and the storage tank was exhausted.	Depending on your specific model, the water storage capacity will range from approximately 20 to 30 oz.
	Dispenser has not been used for several hours.	If the dispenser has not been used for several hours, the first glass dispensed may be warm. Discard the first 10 oz.
	Refrigerator is connected to the hot water supply.	Make sure that the refrigerator is connected to a cold water pipe.   <b>WARNING:</b> Connecting the refrigerator to a hot water line may damage the icemaker.
Water has bad taste or odor.	Water supply contains minerals such as sulfur.	A water filter may need to be installed to eliminate taste and odor problems.
	Water filter has been exhausted.	It is recommended that you replace the water filter: <ul style="list-style-type: none"> <li>• Approximately every 6 months.</li> <li>• When the water filter indicator turns on.</li> <li>• When the water dispenser output decreases.</li> <li>• When the ice cubes are smaller than normal.</li> </ul>
	Refrigerator was recently installed.	Dispense 2.5 gallons of water (flush for approximately 5 minutes) to remove trapped air and contaminants from the system. Do not dispense the entire 2.5 gallon amount continuously. Depress and release the dispenser pad for cycles of 30 seconds ON and 60 seconds OFF.

Problem	Possible Causes	Solutions
Icemaker is making too much ice.	Icemaker shutoff (feeler arm) obstructed.	Empty the ice bin. If your icemaker is equipped with an ice shutoff arm, make sure that the arm moves freely. Reinstall the ice bin and wait 24 hours to confirm proper operation.
Clicking	The defrost control will click when the automatic defrost cycle begins and ends. The thermostat control (or refrigerator control on some models) will also click when cycling on and off.	Normal Operation
Rattling	Rattling noises may come from the flow of refrigerant, the water line on the back of the unit, or items stored on top of or around the refrigerator.	Normal Operation
	Refrigerator is not resting solidly on the floor.	Floor is weak or uneven or leveling legs need to be adjusted. See the Door Alignment section.
	Refrigerator with linear compressor was jarred while running.	Normal Operation
Whooshing	Evaporator fan motor is circulating air through the refrigerator and freezer compartments.	Normal Operation
	Air is being forced over the condenser by the condenser fan.	Normal Operation
Gurgling	Refrigerant flowing through the cooling system.	Normal Operation
Popping	Contraction and expansion of the inside walls due to changes in temperature.	Normal Operation
Sizzling	Water dripping on the defrost heater during a defrost cycle.	Normal Operation
Vibrating	If the side or back of the refrigerator is touching a cabinet or wall, some of the normal vibrations may make an audible sound.	To eliminate the noise, make sure that the sides and back cannot vibrate against any wall or cabinet.
Dripping	Water running into the drain pan during the defrost cycle.	Normal Operation

Problem	Possible Causes	Solutions
Pulsating or High-Pitched Sound	Your refrigerator is designed to run more efficiently to keep your food items at the desired temperature. The high efficiency compressor may cause your new refrigerator to run longer than your old one, but it is still more energy efficient than previous models. While the refrigerator is running, it is normal to hear a pulsating or high-pitched sound.	Normal Operation
Doors will not close correctly or pop open.	Food packages are blocking the door open.	Rearrange food containers to clear the door and door shelves.
	Ice bin, crisper cover, pans, shelves, door bins, or baskets are out of position.	Push bins all the way in and put crisper cover, pans, shelves and baskets into their correct positions. See the Using Your Refrigerator section for more information.
	The doors were removed during product installation and not properly replaced.	Remove and replace the doors according to the Removing and Replacing Refrigerator Handles and Doors section.
	Refrigerator is not leveled properly.	See Door Alignment in the Refrigeration Installation section to level refrigerator.
Doors are difficult to open.	The gaskets are dirty or sticky.	Clean the gaskets and the surfaces that they touch. Rub a thin coat of appliance polish or kitchen wax on the gaskets after cleaning.
	Door was recently closed.	When you open the door, warmer air enters the refrigerator. As the warm air cools, it can create a vacuum. If the door is hard to open, wait one minute to allow the air pressure to equalize, then see if it opens more easily.
Refrigerator wobbles or seems unstable.	Leveling legs are not adjusted properly.	Refer to the Leveling and Door Alignment section.
	Floor is not level.	It may be necessary to add shims under the leveling legs or rollers to complete installation.
Lights do not work.	LED interior lighting failure.	The refrigerator compartment lamp is LED interior lighting, and service should be performed by a qualified technician.
Refrigerator has an unusual odor.	The Air Filter may need to be set to the MAX setting or replaced.	Set the Air Filter to the MAX setting. If the odor does not go away within 24 hours, the filter may need to be replaced. See the Replacing the Air Filter section for replacement instructions.
The interior of the refrigerator is covered with dust or soot.	The refrigerator is located near a fire source, such as a fireplace, chimney or candle.	Make sure that the refrigerator is not located near a fire source, such as a fireplace, chimney or candle.

## LIMITED WARRANTY FOR USA

ARBITRATION NOTICE: THIS LIMITED WARRANTY CONTAINS AN ARBITRATION PROVISION THAT REQUIRES YOU AND LG TO RESOLVE DISPUTES BY BINDING ARBITRATION INSTEAD OF IN COURT, UNLESS YOU CHOOSE TO OPT OUT. IN ARBITRATION, CLASS ACTIONS AND JURY TRIALS ARE NOT PERMITTED. PLEASE SEE THE SECTION TITLED "PROCEDURE FOR RESOLVING DISPUTES" BELOW.

Should your LG Refrigerator ("Product") fail due to a defect in materials or workmanship under normal and proper use, during the warranty period set forth below, LG Electronics ("LG") will, at its option, repair or replace the Product. This limited warranty is valid only to the original retail purchaser of the Product and applies only when purchased and used within the United States including U.S. Territories.

WARRANTY PERIOD			
Refrigerator/ Freezer	Sealed System (Condenser, Dryer, Connecting Tube and Evaporator)	Compressor	
One (1) year from the date of original retail purchase	Five (5) years from the date of original retail purchase	Five (5) years from the date of original retail purchase	Linear / Inverter Compressor Only : Parts Only for years 6-10 from the date of original retail purchase (Consumer will be charged for labor)
Parts and Labor (internal/ functional parts only)	Parts and Labor	Parts and Labor	

- Replacement products and parts are warranted for the remaining portion of the original warranty period or ninety (90) days, whichever is greater.
- Replacement products and parts may be new, reconditioned, refurbished, or otherwise factory remanufactured.
- Proof of original retail purchase specifying the Product model and date of purchase is required to obtain warranty service under this limited warranty.

**EXCEPT TO THE EXTENT PROHIBITED BY APPLICABLE LAW, ANY IMPLIED WARRANTY OF MERCHANTABILITY OR FITNESS FOR A PARTICULAR PURPOSE ON THE PRODUCT IS LIMITED IN DURATION TO THE DURATION OF THE ABOVE LIMITED WARRANTY. UNDER NO CIRCUMSTANCES SHALL LG OR ITS U.S. DISTRIBUTORS/DEALERS BE LIABLE FOR ANY INDIRECT, INCIDENTAL, CONSEQUENTIAL, SPECIAL, OR PUNITIVE DAMAGES, INCLUDING, WITHOUT LIMITATION, LOST GOODWILL, LOST REVENUES OR PROFITS, WORK STOPPAGE, IMPAIRMENT OF OTHER GOODS, COST OF REMOVAL AND REINSTALLATION OF THE PRODUCT, LOSS OF USE, OR ANY OTHER DAMAGES WHETHER BASED IN CONTRACT, TORT, OR OTHERWISE. LG'S TOTAL LIABILITY, IF ANY, SHALL NOT EXCEED THE PURCHASE PRICE PAID BY YOU FOR THE PRODUCT.**

Some states do not allow the exclusion or limitation of incidental or consequential damages or limitations on how long an implied warranty lasts, so the above exclusion or limitation may not apply to you. This warranty gives you specific legal rights and you may also have other rights that vary from state to state.

### THIS LIMITED WARRANTY DOES NOT COVER:

- Service trips to deliver, pick up, or install, educate how to operate, correct wiring, or correct unauthorized repairs.
- Damage or failure of the Product to perform during power failures and interrupted or inadequate electrical service.
- Damage or failure caused by leaky or broken water pipes, frozen water pipes, restricted drain lines, inadequate or interrupted water supply or inadequate supply of air.
- Damage resulting from operating the product in a corrosive atmosphere or contrary to the product owner's manual.
- Damage or failure to the Product caused by accidents, pests and vermin, lightning, wind, fire, floods, acts of God, or any other causes beyond the control of LG.

- Damage or failure caused by unauthorized modification or alteration, or if used for other than the intended purpose.
- Damage or failure resulting from misuse, abuse, improper installation, repair, or maintenance. Improper repair includes use of parts not authorized by LG. Improper installation or maintenance includes installation or maintenance contrary to the Product owner's manual.
- Damage or failure caused by incorrect electrical current, voltage, or plumbing codes.
- Damage or failure caused by transportation and handling, including scratches, dents, chips, and/or other damage to the finish of the Product, unless such damage is reported within one (1) week of delivery.
- Damage or missing items to any display, open box, or discounted Product.
- Refurbished Product or any Product sold "As Is", "Where Is", "With all Faults", or similar disclaimer.
- Products with original serial numbers that have been removed, altered, or cannot be readily determined.
- Increases in utility costs and additional utility expenses.
- Any noises associated with normal operation.
- Use of accessories (e.g., water filters, etc.), components, or consumable cleaning products that are not authorized by LG.
- Replacement of light bulbs, filters, or any consumable parts.
- When Product is used for other than normal and proper household use (e.g. commercial or industrial use, offices, and recreational facilities or vehicles) or contrary to the instructions outlined in the Product's owner's manual.
- Costs associated with removal and reinstallation of your Product for repairs.
- Shelves, door bins, drawers, handle and accessories, except for internal/functional parts covered under this limited warranty.

**The cost of repair or replacement under these excluded circumstances shall be borne by the consumer.**

TO OBTAIN WARRANTY SERVICE AND ADDITIONAL INFORMATION

Call 1-800-243-0000 and select the appropriate option from the menu.

Or visit our website at <http://www.lg.com>.

Or by mail: LG Electronics Customer Service P.O. Box 240007 Huntsville, AL 35813 ATTN: CIC

#### PROCEDURE FOR RESOLVING DISPUTES:

ALL DISPUTES BETWEEN YOU AND LG ARISING OUT OF OR RELATING IN ANY WAY TO THIS LIMITED WARRANTY OR THE PRODUCT SHALL BE RESOLVED EXCLUSIVELY THROUGH BINDING ARBITRATION, AND NOT IN A COURT OF GENERAL JURISDICTION. BINDING ARBITRATION MEANS THAT YOU AND LG ARE EACH WAIVING THE RIGHT TO A JURY TRIAL AND TO BRING OR PARTICIPATE IN A CLASS ACTION.

**Definitions.** For the purposes of this section, references to "LG" mean LG Electronics U.S.A., Inc., its parents, subsidiaries and affiliates, and each of their officers, directors, employees, agents, beneficiaries, predecessors in interest, successors, assigns and suppliers; references to "dispute" or "claim" shall include any dispute, claim or controversy of any kind whatsoever (whether based in contract, tort, statute, regulation, ordinance, fraud, misrepresentation or any other legal or equitable theory) arising out of or relating in any way to the sale, condition or performance of the product or this Limited Warranty.

**Notice of Dispute.** In the event you intend to commence an arbitration proceeding, you must first notify LG in writing at least 30 days in advance of initiating the arbitration by sending a letter to LG at LG Electronics, USA, Inc. Attn: Legal Department- Arbitration 1000 Sylvan Ave, Englewood Cliffs 07632. You and LG agree to engage in good faith discussions in an attempt to amicably resolve your claim. The notice must provide your name, address, and telephone number; identify the product that is the subject of the claim; and describe the nature of the claim and the relief being sought. If you and LG are unable to resolve the dispute within 30 days, either party may proceed to file a claim for arbitration.



**Agreement to Binding Arbitration and Class Action Waiver.** Upon failure to resolve the dispute during the 30 day period after sending written notice to LG, you and LG agree to resolve any claims between us only by binding arbitration on an individual basis, unless you opt out as provided below. Any dispute between you and LG shall not be combined or consolidated with a dispute involving any other person's or entity's product or claim. More specifically, without limitation of the foregoing, any dispute between you and LG shall not under any circumstances proceed as part of a class or representative action. Instead of arbitration, either party may bring an individual action in small claims court, but that small claims court action may not be brought on a class or representative basis.

**Arbitration Rules and Procedures.** To begin arbitration of a claim, either you or LG must make a written demand for arbitration. The arbitration will be administered by the American Arbitration Association ("AAA") and will be conducted before a single arbitrator under the AAA's Consumer Arbitration Rules that are in effect at the time the arbitration is initiated (referred to as the "AAA Rules") and under the procedures set forth in this section. The AAA Rules are available online at [www.adr.org/consumer](http://www.adr.org/consumer). Send a copy of your written demand for arbitration, as well as a copy of this provision, to the AAA in the manner described in the AAA Rules. You must also send a copy of your written demand to LG at LG Electronics, USA, Inc. Attn: Legal Department- Arbitration 1000 Sylvan Avenue Englewood Cliffs, NJ 07632. If there is a conflict between the AAA Rules and the rules set forth in this section, the rules set forth in this section will govern. This arbitration provision is governed by the Federal Arbitration Act. Judgment may be entered on the arbitrator's award in any court of competent jurisdiction. All issues are for the arbitrator to decide, except that issues relating to the scope and enforceability of the arbitration provision and to the arbitrability of the dispute are for the court to decide. The arbitrator is bound by the terms of this provision.

**Governing Law.** The law of the state of your residence shall govern this Limited Warranty and any disputes between us except to the extent that such law is preempted by or inconsistent with applicable federal law.

**Fees/Costs.** You do not need to pay any fee to begin an arbitration. Upon receipt of your written demand for arbitration, LG will promptly pay all arbitration filing fees to the AAA unless you seek more than \$25,000 in damages, in which case the payment of these fees will be governed by the AAA Rules. Except as otherwise provided for herein, LG will pay all AAA filing, administration and arbitrator fees for any arbitration initiated in accordance with the AAA Rules and this arbitration provision. If you prevail in the arbitration, LG will pay your attorneys' fees and expenses as long as they are reasonable, by considering factors including, but not limited to, the purchase amount and claim amount. Notwithstanding the foregoing, if applicable law allows for an award of reasonable attorneys' fees and expenses, an arbitrator can award them to the same extent that a court would. If the arbitrator finds either the substance of your claim or the relief sought in the demand is frivolous or brought for an improper purpose (as measured by the standards set forth in Federal Rule of Civil Procedure 11(b)), then the payment of all arbitration fees will be governed by the AAA Rules. In such a situation, you agree to reimburse LG for all monies previously disbursed by it that are otherwise your obligation to pay under the AAA Rules. Except as otherwise provided for, LG waives any rights it may have to seek attorneys' fees and expenses from you if LG prevails in the arbitration.

**Hearings and Location.** If your claim is for \$25,000 or less, you may choose to have the arbitration conducted solely on the basis of (1) documents submitted to the arbitrator, (2) through a telephonic hearing, or (3) by an in-person hearing as established by the AAA Rules. If your claim exceeds \$25,000, the right to a hearing will be determined by the AAA Rules. Any in-person arbitration hearings will be held at a location within the federal judicial district in which you reside unless we both agree to another location or we agree to a telephonic arbitration.

**Opt Out.** You may opt out of this dispute resolution procedure. If you opt out, neither you nor LG can require the other to participate in an arbitration proceeding. To opt out, you must send notice to LG no later than 30 calendar days from the date of the first consumer purchaser's purchase of the product by either: (i) sending an e-mail to [optout@lge.com](mailto:optout@lge.com), with the subject line: "Arbitration Opt Out" or (ii) calling 1-800-980-2973. You must include in the opt out e-mail or provide by telephone: (a) your name and address; (b) the date on which the product was purchased; (c) the product model name or model number; and (d) the serial number (the serial number can be found (i) on the product; or (ii) online by accessing <https://www.lg.com/us/support/repair-service/schedule-repair-continued> and clicking on "Find My Model & Serial Number").

You may only opt out of the dispute resolution procedure in the manner described above (that is, by e-mail or telephone); no other form of notice will be effective to opt out of this dispute resolution procedure. Opting out of this dispute resolution procedure will not affect the coverage of the Limited Warranty in any way, and you will continue to enjoy the full benefits of the Limited Warranty. If you keep this product and do not opt out, then you accept all terms and conditions of the arbitration provision described above.

## LIMITED WARRANTY FOR CANADA

ARBITRATION NOTICE: THIS LIMITED WARRANTY CONTAINS AN ARBITRATION PROVISION THAT REQUIRES YOU AND LG TO RESOLVE DISPUTES BY BINDING ARBITRATION INSTEAD OF IN COURT, UNLESS THE LAWS OF YOUR PROVINCE OR TERRITORY DO NOT PERMIT THAT, OR, IN OTHER JURISDICTIONS, IF YOU CHOOSE TO OPT OUT. IN ARBITRATION, CLASS ACTIONS AND JURY TRIALS ARE NOT PERMITTED. PLEASE SEE THE SECTION TITLED "PROCEDURE FOR RESOLVING DISPUTES" BELOW.

Should your LG Refrigerator ("Product") fail due to a defect in materials or workmanship under normal and proper use, during the warranty period set forth below, LG Electronics Canada, Inc. ("LGECI") will, at its option, repair or replace the Product upon receipt of proof of the original retail purchase. This limited warranty is valid only to the original retail purchaser of the Product and applies only to a Product distributed, purchased and used within Canada, as determined at the sole discretion of LGECI.

<b>WARRANTY PERIOD (Note: If the original date of purchase cannot be verified, the warranty will begin sixty (60) days from the date of manufacture)</b>			
<b>Refrigerator</b>	<b>Sealed System (Condenser, Dryer, Connecting Tube and Evaporator)</b>		<b>Linear / Inverter Compressor</b>
<b>One (1) year from the date of original retail purchase</b>	<b>One (1) year from the date of original retail purchase</b>	<b>Seven (7) years from the date of original retail purchase</b>	<b>Ten (10) years from the date of original retail purchase</b>
Parts and Labor (internal/functional parts only)	Parts and Labor	Parts only (Consumer will be charged for labor)	Part only (Consumer will be charged for labor)

- Replacement products and parts are warranted for the remaining portion of the original warranty period or ninety (90) days, whichever is greater.
- Replacement products and parts may be new, reconditioned, refurbished, or otherwise factory remanufactured, all at the sole discretion of LGECI.
- Proof of original retail purchase specifying the Product model and date of purchase is required to obtain warranty service under this Limited Warranty.

LGECI'S SOLE LIABILITY IS LIMITED TO THE LIMITED WARRANTY SET OUT ABOVE. EXCEPT AS EXPRESSLY PROVIDED ABOVE, LGECI MAKES NO, AND HEREBY DISCLAIMS, ALL OTHER WARRANTIES AND CONDITIONS RESPECTING THE PRODUCT, WHETHER EXPRESS OR IMPLIED, INCLUDING BUT NOT LIMITED TO, ANY IMPLIED WARRANTY OR CONDITION OF MERCHANTABILITY OR FITNESS FOR A PARTICULAR PURPOSE, AND NO REPRESENTATIONS SHALL BE BINDING ON LGECI. LGECI DOES NOT AUTHORIZE ANY PERSON TO CREATE OR ASSUME FOR IT ANY OTHER WARRANTY OBLIGATION OR LIABILITY IN CONNECTION WITH THE PRODUCT. TO THE EXTENT THAT ANY WARRANTY OR CONDITION IS IMPLIED BY LAW, IT IS LIMITED TO THE WARRANTY PERIOD SET OUT ABOVE. UNDER NO CIRCUMSTANCES SHALL LGECI, THE MANUFACTURER OR DISTRIBUTOR OF THE PRODUCT, BE LIABLE FOR ANY INCIDENTAL, CONSEQUENTIAL, SPECIAL, DIRECT, INDIRECT, PUNITIVE OR EXEMPLARY DAMAGES, INCLUDING, WITHOUT LIMITATION, LOSS OF GOODWILL, LOST PROFITS, LOSS OF ANTICIPATED PROFITS, LOST REVENUE, LOSS OF USE, OR ANY OTHER DAMAGE, WHETHER ARISING DIRECTLY OR INDIRECTLY FROM ANY CONTRACTUAL BREACH, FUNDAMENTAL BREACH, TORT OR OTHERWISE, OR FROM ANY ACTS OR OMISSIONS. LGECI'S TOTAL LIABILITY, IF ANY, SHALL NOT EXCEED THE PURCHASE PRICE PAID BY YOU FOR THE PRODUCT.

This Limited Warranty gives you specific legal rights. You may also have other rights that vary from province to province depending on applicable provincial laws. Any term of this Limited Warranty that negates or varies any implied condition or warranty under provincial law is severable where it conflicts with such provincial law without affecting the remainder of this warranty's terms.

**THIS LIMITED WARRANTY DOES NOT COVER:**

- Service trips to i) deliver, pick up, or install or; educate on how to operate the Product; ii) correct wiring or plumbing; or iii) correct unauthorized repairs or installations of the Product;
- Damage or failure of the Product to perform during power failures and interrupted or inadequate electrical service;
- Damage or failure caused by leaky or broken water pipes, frozen water pipes, restricted drain lines, inadequate or interrupted water supply or inadequate supply of air;
- Damage or failure resulting from operating the Product in a corrosive atmosphere or contrary to the instructions outlined in the Product's owner's manual;
- Damage or failure to the Product caused by accidents, pests and vermin, lightning, wind, fire, floods, acts of God, or any other causes beyond the control of LGECI or the manufacturer;
- Damage or failure resulting from misuse, abuse, improper installation, repair, or maintenance of the Product. Improper repair includes use of parts not authorized or specified by LGECI. Improper installation or maintenance includes installation or maintenance contrary to the Product's owner's manual;
- Damage or failure caused by unauthorized modification or alteration of the Product, or if used for other than the intended household purpose/use of the Product, or damage or failure resulting from any water leakage due to improper installation of the Product;
- Damage or failure caused by incorrect electrical current, voltage or plumbing codes;
- Damage or failure caused by use that is other than normal household use, including, without limitation, commercial or industrial use, including use in commercial offices or recreational facilities, or as otherwise outlined in the Product's owner's manual;
- Damage or failure caused by the use of any accessories, components or cleaning products, including, without limitation, water filters, that are not approved/authorized by LGECI;
- Replacement of the water filter cartridge due to water pressure that is outside the specified operating range or due to excessive sediment in the water supply;
- Damage or failure caused by transportation and handling, including scratches, dents, chips and/or other damage to the finish of the Product, unless such damage results from defects in materials or workmanship and is reported to LGECI within one (1) week of delivery of the Products;
- Damage or missing items to any display, open box, refurbished or discounted Product;
- Refurbished Product or any Product sold "As Is", "Where Is", "With all Faults", or any similar disclaimer;
- Products with original serial numbers that have been removed, altered or cannot be readily determined at the discretion of LGECI;
- Increases in utility costs and additional utility expenses in any way associated with the Product;
- Any noises associated with normal operation of the Product;
- Replacement of light bulbs, filters, fuses or any other consumable parts;
- Replacement of any part that was not originally included with the Product;
- Costs associated with removal and/or reinstallation of the Product for repairs; and
- Shelves, door bins, drawers, handle and accessories to the Product, except for internal/functional parts covered under this Limited Warranty.
- Coverage for "in Home" repairs, for products in-warranty, will be provided if the Product is within a 150 km radius from the nearest authorized service center (ASC), as determined by LG Canada. If your Product is located outside a 150 km radius from a ASC, as determined by LG Canada, it will be your responsibility to bring the Product, at your sole expense, to the ASC for in-warranty repair.

**All costs and expenses associated with the above excluded circumstances, listed under the heading, This Limited Warranty Does Not Cover, shall be borne by the consumer.**

TO OBTAIN WARRANTY SERVICE AND ADDITIONAL INFORMATION, PLEASE CALL OR VISIT OUR WEBSITE:

Call 1-888-542-2623 (7 A.M. to 12 A.M., 365 days a year) and select the appropriate option from the menu, or. Visit our website at <http://www.lg.com>

**PROCEDURE FOR RESOLVING DISPUTES:**

EXCEPT WHERE PROHIBITED AT LAW, ALL DISPUTES BETWEEN YOU AND LG ARISING OUT OF OR RELATING IN ANY WAY TO THIS LIMITED WARRANTY OR THE PRODUCT SHALL BE RESOLVED EXCLUSIVELY THROUGH BINDING ARBITRATION, AND NOT IN A COURT OF GENERAL JURISDICTION. EXCEPT WHERE PROHIBITED AT LAW, YOU AND LG BOTH IRREVOCABLY AGREE TO WAIVE THE RIGHT TO A JURY TRIAL AND TO BRING OR PARTICIPATE IN A CLASS ACTION.

**Definitions.** For the purposes of this section, references to “LG” mean LG Electronics Canada, Inc., its parents, subsidiaries and affiliates, and each of their officers, directors, employees, agents, beneficiaries, predecessors in interest, successors, assigns and suppliers; references to “dispute” or “claim” shall include any dispute, claim or controversy of any kind whatsoever (whether based in contract, tort, statute, regulation, ordinance, fraud, misrepresentation or any other legal or equitable theory) arising out of or relating in any way to the sale, condition or performance of the product or this Limited Warranty.

**Notice of Dispute.** In the event you intend to commence an arbitration proceeding, you must first notify LG in writing at least 30 days in advance of initiating the arbitration by sending a letter to LG Electronics, Canada, Inc., Attn: Legal Department- Arbitration, 20 Norelco Drive, North York, Ontario M9L 2X6. You and LG agree to engage in good faith discussions in an attempt to amicably resolve your claim. The notice must provide your name, address, and telephone number; identify the product that is the subject of the claim; and describe the nature of the claim and the relief being sought. If you and LG are unable to resolve the dispute within 30 days, either party may proceed to file a claim for arbitration.

**Agreement to Binding Arbitration and Class Action Waiver.** Upon failure to resolve the dispute during the 30 day period after sending written notice to LG, you and LG agree to resolve any claims between you and LG only by binding arbitration on an individual basis, unless you opt out as provided below, or you reside in a jurisdiction that prevents full application of this clause in the circumstances of the claims at issue (in which case if you are a consumer, this clause will only apply if you expressly agree to the arbitration). To the extent permitted by applicable law, any dispute between you and LG shall not be combined or consolidated with a dispute involving any other person’s or entity’s product or claim. More specifically, without limitation of the foregoing, except to the extent such a prohibition is not permitted at law, any dispute between you and LG shall not under any circumstances proceed as part of a class or representative action. Instead of arbitration, either party may bring an individual action in small claims court, but that small claims court action may not be brought on a class or representative basis except to the extent this prohibition is not permitted at law in your province or territory of jurisdiction as it relates to the claims at issue between you and LG.

**Arbitration Rules and Procedures.** To begin arbitration of a claim, either you or LG must make a written demand for arbitration. The arbitration will be private and confidential, and conducted on a simplified and expedited basis before a single arbitrator chosen by the parties under the provincial or territorial commercial arbitration law and rules of the province or territory of your residence. You must also send a copy of your written demand to LG at LG Electronics, Canada, Inc., Attn: Legal Department- Arbitration, 20 Norelco Drive, North York, Ontario M9L 2X6. This arbitration provision is governed by your applicable provincial or territorial commercial arbitration legislation. Judgment may be entered on the arbitrator’s award in any court of competent jurisdiction. All issues are for the arbitrator to decide, except that, issues relating to the scope and enforceability of the arbitration provision and to the arbitrability of the dispute are for the court to decide. The arbitrator is bound by the terms of this provision.

**Governing Law.** The law of the province or territory of your residence shall govern this Limited Warranty and any disputes between you and LG except to the extent that such law is preempted by or inconsistent with applicable federal or provincial/territorial law. Should arbitration not be permitted for any claim, action, dispute or controversy between you and LG, you and LG attend to the exclusive jurisdiction of the courts of the province or territory of your residence for the resolution of the claim, action, dispute or controversy between you and LG.

**Fees/Costs.** You do not need to pay any fee to begin an arbitration. Upon receipt of your written demand for arbitration, LG will promptly pay all arbitration filing fees unless you seek more than \$25,000 in damages, in which case the payment of these fees will be governed by the applicable arbitration rules. Except as otherwise provided for herein, LG will pay all filing, administration and arbitrator fees for any arbitration initiated in accordance with the applicable arbitration rules and this arbitration provision. If you prevail in the arbitration, LG will pay your attorneys' fees and expenses as long as they are reasonable, by considering factors including, but not limited to, the purchase amount and claim amount. Notwithstanding the foregoing, if applicable law allows for an award of reasonable attorneys' fees and expenses, an arbitrator can award them to the same extent that a court would. If the arbitrator finds either the substance of your claim or the relief sought in the demand is frivolous or brought for an improper purpose (as measured by the applicable laws), then the payment of all arbitration fees will be governed by the applicable arbitration rules. In such a situation, you agree to reimburse LG for all monies previously disbursed by it that are otherwise your obligation to pay under the applicable arbitration rules. Except as otherwise provided for, LG waives any rights it may have to seek attorneys' fees and expenses from you if LG prevails in the arbitration.

**Hearings and Location.** If your claim is for \$25,000 or less, you may choose to have the arbitration conducted solely (1) on the basis of documents submitted to the arbitrator, (2) through a telephonic hearing, or (3) by an in-person hearing as established by the applicable arbitration rules. If your claim exceeds \$25,000, the right to a hearing will be determined by the applicable arbitration rules. Any in-person arbitration hearings will be held at the nearest, most mutually-convenient arbitration location available within the province or territory in which you reside unless you and LG both agree to another location or agree to a telephonic arbitration.

**Severability and Waiver.** If any portion of this Limited Warranty (including these arbitration procedures) is unenforceable, the remaining provisions will continue in full force and effect to the maximum extent permitted by applicable law. Should LG fail to enforce strict performance of any provision of this Limited Warranty (including these arbitration procedures), it does not mean that LG intends to waive or has waived any provision or part of this Limited Warranty.

**Opt Out.** You may opt out of this dispute resolution procedure. If you opt out, neither you nor LG can require the other to participate in an arbitration proceeding. To opt out, you must send notice to LG no later than 30 calendar days from the date of the first consumer purchaser's purchase of the product by either (i) sending an e-mail to [optout@lge.com](mailto:optout@lge.com), with the subject line: "Arbitration Opt Out;" or (ii) calling 1-800-980-2973. You must include in the opt out e-mail or provide by telephone: (a) your name and address; (b) the date on which the product was purchased; (c) the product model name or model number; and

(d) the serial number (the serial number can be found (i) on the product; or (ii) online by accessing [https://www.lg.com/ca\\_en/support/repair-service/schedule-repair](https://www.lg.com/ca_en/support/repair-service/schedule-repair) and clicking on "Find My Model & Serial Number").

In the event that you "Opt Out", the law of the province or territory of your residence shall govern this Limited Warranty and any disputes between you and LG except to the extent that such law is preempted by or inconsistent with applicable federal or provincial/territorial law. Should arbitration not be permitted for any claim, action, dispute or controversy between you and LG, you and LG agree to attorn to the exclusive jurisdiction of the courts of the province or territory of your residence for the resolution of the claim, action, dispute or controversy between you and LG.

You may only opt out of the dispute resolution procedure in the manner described above (that is, by e-mail or telephone); no other form of notice will be effective to opt out of this dispute resolution procedure. Opting out of this dispute resolution procedure will not affect the coverage of the Limited Warranty in any way, and you will continue to enjoy the full benefits of the Limited Warranty. If you keep this product and do not opt out, then you accept all terms and conditions of the arbitration provision described above.

**Conflict of Terms.** In the event of a conflict or inconsistency between the terms of this Limited Warranty and the End User License Agreement ("EULA") in regards to dispute resolution, the terms of this Limited Warranty shall control and govern the rights and obligations of the parties and shall take precedence over the EULA.





