

SINGLE WALL OVEN

use & care

| | |
|--|----|
| Introduction. | 2 |
| Important Safety Instructions. | 3 |
| Cooking Recommendations. | 9 |
| Before Setting Oven Controls. | 12 |

| | |
|---------------------------------|----|
| Setting Oven Controls | 18 |
| Care and Cleaning | 31 |
| Before You Call | 36 |
| Warranty | 39 |

2

INTRODUCTION

Welcome to our *family*

Thank you for bringing Frigidaire into your home! We see your purchase as the beginning of a long relationship together.

This manual is your resource for the use and care of your product. Please read it before using your appliance. Keep it handy for quick reference. If something doesn't seem right, the troubleshooting section will help you with common issues.

FAQs, helpful tips and videos, cleaning products, and kitchen and home accessories are available at www.frigidaire.com.

We are here for you! Visit our website, chat with an agent, or call us if you need help. We may be able to help you avoid a service visit. If you do need service, we can get that started for you.

Let's make it official! Be sure to register your product.

Keep your product info here so it's easy to find.

Model Number: _____

Serial Number: _____

Purchase Date: _____

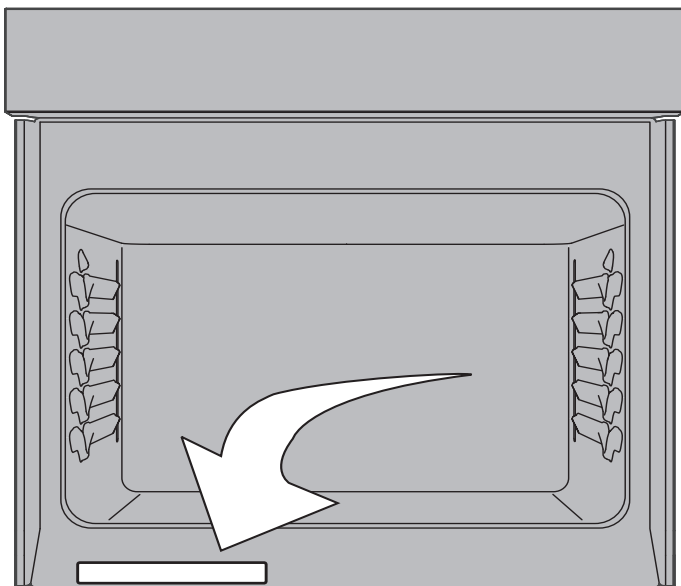

Serial Number Location



Installation Checklist

- Read all the safety instructions in the front of your Use & Care Manual.
- Remove all packaging materials from your appliance before cooking.
- Confirm that the electrical power to the appliance is turned on.
- Wipe out the inside of the oven cavity with a damp cloth.
- Apply a thin layer of cooking oil to the sides of the oven racks to keep them gliding smoothly.
- Set the clock. See (page 13) for instructions.
- Before cooking, set the oven to bake at 350°F (177°C) for 30 minutes (page ref). Some noise and odors are normal on the first cooking cycle.
- Remember to complete your product registration!

Read all instructions before using this appliance.

This manual contains important safety symbols and instructions. Please pay attention to these symbols and follow all instructions given.

Do not attempt to install or operate your appliance until you have read the safety precautions in this manual. Safety items throughout this manual are labeled with a WARNING or CAUTION statement based on the risk type.

Warnings and important instructions appearing in this guide are not meant to cover all possible conditions and situations that may occur. Common sense, caution, and care must be exercised with installing, maintaining, or operating your appliance.

DEFINITIONS

 This is the safety alert symbol. It is used to alert of potential personal injury hazards. Obey all safety messages that follow this symbol to avoid possible injury or death.

WARNING

Indicates a potentially hazardous situation which, if not avoided, may result in death or serious injury.

CAUTION

Indicates a potentially hazardous situation which, if not avoided, may result in minor or moderate injury.

IMPORTANT

Indicates installation, operation or maintenance information which is important but not hazard-related.

NOTE

Indicates a short, informal reference – something written down to assist the memory or for future reference.

WARNING

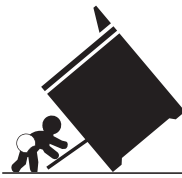

Tip Over Hazard

- **A child or adult can tip the oven and be killed.**
- **Install the anti-tip device to oven and/or structure per installation instructions.**
- **Ensure the anti-tip device is re-engaged when the oven is moved.**
- **Do not operate the oven without the anti-tip device in place and engaged.**
- **Failure to follow these instructions can result in death or serious burns to children and adults.**

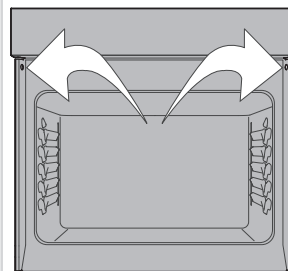

Refer to the installation instructions supplied with your appliance for proper installation.

Anti-tip mounting holes

Check for proper installation with a visual check that the anti-tip screws are present. Test the installation with light downward pressure on the open oven door. The oven should not tip forward.

4

IMPORTANT SAFETY INSTRUCTIONS

IMPORTANT INSTRUCTIONS FOR UNPACKING AND INSTALLATION

IMPORTANT

Read and follow the below instructions and precautions for unpacking, installing, and servicing your appliance.

Remove all tape and packaging before using the appliance. Destroy the carton and plastic bags after unpacking the appliance. Never allow children to play with packaging material. Do not remove the wiring label and other literature attached to the appliance. Do not remove model/serial number plate.

Cold temperatures can damage the electronic control. When using this appliance for the first time, or when the appliance has not been used for an extended period of time, be sure the appliance has been in temperatures above 32°F (0°C) for at least 3 hours before turning on the power to the appliance.

All materials used in construction of cabinets, enclosures, and supports surrounding the product must have a temperature rating above 194°F (90°C).

Never modify or alter the construction of the appliance by removing the leveling legs, panels, wire covers, anti-tip brackets/screws, or any other part of the appliance.

Be sure to have an appropriate foam-type fire extinguisher available, visible, and easily accessible located near the appliance.

GROUNDING INSTRUCTIONS

WARNING

- Avoid fire hazard or electrical shock. Failure to follow this warning may cause serious injury, fire, or death.
- Avoid fire hazard or electrical shock. Do not use an adapter plug, use an extension cord, or remove grounding prong from the power cord. Failure to follow this warning may cause serious injury, fire, or death.

Proper Installation—Be sure your appliance is properly installed and grounded by a qualified technician. In the United States, install in accordance with the National Fuel Gas Code ANSI Z223.1/NPFA No. 54, latest edition and National Electrical Code NFPA No. 70 latest edition, and local electrical code requirements. In Canada, install in accordance with CAN/CGA B149.1 and CAN/CGA B149.2 and CSA Standard C22.1, Canadian Electrical code, Part 1-latest editions and local electrical code requirements. Install only per installation instructions provided in the literature package for this appliance.

For personal safety, this appliance must be properly grounded. For maximum safety, the power cord must be securely connected to an electrical outlet or junction box that is the correct voltage, is correctly polarized and properly grounded, and protected by a circuit breaker in accordance with local codes.

It is the personal responsibility of the consumer to have the appropriate outlet or junction box with the correct, properly grounded wall receptacle installed by a qualified electrician. It is the responsibility and obligation of the consumer to contact a qualified installer to assure that the electrical installation is adequate and

is in conformance with all local codes and ordinances.

See the installation instructions packaged with this appliance for complete installation and grounding instructions.

IMPORTANT INSTRUCTIONS FOR USING THE APPLIANCE

WARNING

- **Storage In or On Appliance**—Flammable materials should not be stored in an oven or microwave, near surface burners or elements, or in the storage or warmer drawer (if equipped). This includes paper, plastic, and cloth items, such as cookbooks, plastic ware, and towels, as well as flammable liquids. Do not store explosives, such as aerosol cans, on or near the appliance.
- Do not leave children alone - Children should not be left alone or unattended in the area where appliance is in use. They should never be allowed to sit or stand on any part of the appliance, including the storage drawer, lower broiler drawer, warmer drawer, or lower double oven.
- Do not store items of interest to children in the cabinets above the appliance or on the backguards of ranges. Children climbing on or near the appliance to reach items could be seriously injured.
- Do not allow children to climb or play around the appliance. The weight of a child on an open oven door may cause the appliance to tip, resulting in serious burns or other injury. An open drawer when hot may cause burns.

WARNING

- Stepping, leaning, or sitting on the door or drawers of this appliance can result in serious injuries and also cause damage to the appliance.
- Never cover any slots, holes or passages in the oven bottom or cover and entire rack with materials such as aluminum foil. Aluminum foil linings may also trap heat, causing a fire hazard.
- Do not use oven or warmer drawer (if equipped) for storage.
- Never use your appliance as a space heater to heat or warm the room. Doing so may result in carbon monoxide poisoning and overheating of the appliance.

CAUTION

- When heating fat or grease, watch it closely. Grease may catch fire if it becomes too hot.
- Do not use water or flour on grease fires. Smother fire or flame or use dry chemical or foam-type extinguisher. Cover the fire with a pan lid or use baking soda.
- Use dry potholders. Moist or damp potholders on hot surfaces may result in burns from steam. Do not let potholders touch hot cooking areas. Do not use towels or other bulky cloths.
- Do not heat unopened food containers - Build-up of pressure may cause container to burst and result in injury.

6

IMPORTANT SAFETY INSTRUCTIONS

CAUTION

- Wear proper apparel - Loose-fitting or hanging garments should never be worn while using the appliance. Do not let clothing or other flammable materials contact hot surfaces.
- Do not touch surface burners or elements, areas near these burners or elements, interior surfaces of the oven, or the warmer drawer (if equipped). Surface burners and elements may be hot even though they appear cool. Areas near surface burners and elements may become hot enough to cause burns. During and after use, do not touch, or let clothing or other flammable materials touch these areas until they are cool. These areas may include the cooktop, surfaces facing the cooktop, oven vent areas, oven door, and oven window.
- Do not attempt to operate the appliance during a power failure. If the power fails, always turn off the appliance. If the appliance is not turned off and the power resumes, electric surface elements may resume operation when power is restored. Once the power resumes, reset the clock and the oven function.

IMPORTANT INSTRUCTIONS FOR USING YOUR OVEN

Protective liners—Do not use aluminum foil, aftermarket oven liners, or any other materials or devices to line oven bottom, oven racks, or any other part of the appliance. Only use aluminum as recommended for baking, such as lining cookware or as a cover placed on food. Any other use of protective liners or aluminum foil may result in a risk of electric shock or fire or a short circuit.

Use care when opening oven door, lower oven door, or warmer drawer (some models). Stand to the side of the appliance when opening the door of a hot oven. Let hot air or steam escape before you remove or replace food in the oven.

Keep oven vent ducts unobstructed. Touching surfaces in this area when the oven is on may cause severe burns. Do not place plastic or heat-sensitive items on or near the oven vent. These items can melt or ignite.

Placement of oven racks - Always place oven racks in desired location while oven is cool. If rack must be moved while oven is hot, do not let potholder contact hot burner or element in oven. Use potholders and grasp the rack with both hands to reposition. Remove all cookware and utensils before moving the rack.

Do not use a broiler pan without its insert. Broiler pans and inserts allow dripping fat to drain away from the high heat of the broiler. Do not cover the broiler insert with aluminum foil; exposed fat and grease could ignite.

Do not cook food on the oven bottom. Always cook in proper cookware and always use the oven racks.

IMPORTANT INSTRUCTIONS FOR CLEANING YOUR APPLIANCE **CAUTION**

Before manually cleaning any part of the appliance, be sure all controls are turned off and the appliance is cool. Cleaning a hot appliance can cause burns.

Clean the appliance regularly to keep all parts free of grease that could catch fire. Do not allow grease to accumulate. Greasy deposits in the fan could catch fire.

Always follow the manufacturer's recommended directions for use of kitchen cleaners and aerosols. Be aware that excess residue from cleaners and aerosols may ignite causing damage and injury.

Clean ventilating hoods frequently - Grease should not be allowed to accumulate on hood or filter. Follow the manufacturer's instructions for cleaning vent hoods.

IMPORTANT INSTRUCTIONS FOR SELF CLEANING OVENS **CAUTION**

Before using self clean, remove the broiler pan, any food, utensils, and cookware from the oven, storage drawer or warming drawer (if equipped). Remove oven racks unless otherwise instructed.

Do not clean the oven door gasket. The door gasket is essential for a good seal. Care should be taken not to rub, damage, or move the gasket.

Do not use oven cleaners. No commercial oven cleaner or oven liner protective coating of any kind should be used in or around any part of the appliance.

Use the self clean cycle to clean only the parts listed in this manual.

Some birds are extremely sensitive to the fumes given off during the self clean cycle of any oven. Move birds to another well-ventilated room.

8

IMPORTANT SAFETY INSTRUCTIONS

IMPORTANT INSTRUCTIONS FOR SERVICE AND MAINTENANCE

Do not repair or replace any part of the appliance unless specifically recommended in the manuals. All other servicing should be done only by a qualified technician. This reduces the risk of personal injury and damage to the appliance.

Always contact your dealer, distributor, service agent, or manufacturer about problems or conditions you do not understand.

Ask your dealer to recommend a qualified technician and an authorized repair service. Know how to disconnect the power to the appliance at the circuit breaker or fuse box in case of an emergency.

Remove the oven door from any unused oven if it is to be stored or discarded.

Do not touch a hot oven light bulb with a damp cloth. Doing so could cause the bulb to break. Handle halogen lights (if equipped) with paper towels or soft gloves. Disconnect the appliance or shut off the power to the appliance before removing and replacing the bulb.





WARNING

California Residents: for cancer and reproductive harm information, visit www.P65Warnings.ca.gov

Bakeware

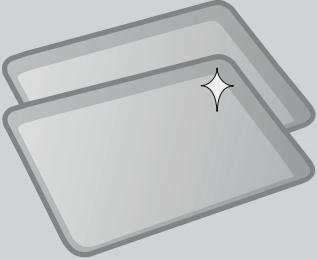
The material of bakeware affects how evenly and quickly it transfers heat from the pan to the food.

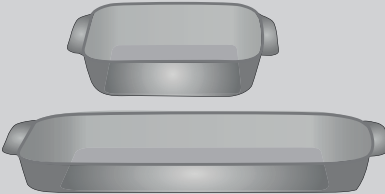
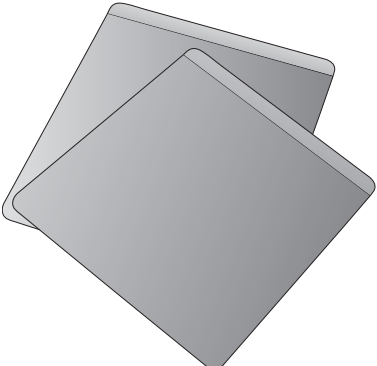
| Material | Attributes | Recommendation |
|---|--|--|
| <p>Shiny metal bakeware</p>  | <p>Shiny, aluminum, and non-coated bakeware is the best for even heating. It is suitable for all baked goods.</p> | <p>Recommended cooking temperatures and times are based on shiny metal bakeware.</p> |
| <p>Dark metal bakeware</p>  | <p>Dark bakeware cooks hotter than shiny bakeware.</p> | <p>Reduce the cooking temperature by 25°F (13-14°C) when using dark bakeware.</p> |
| <p>Glass bakeware</p>  | <p>Glass bakeware cooks hotter than shiny bakeware. Glass is convenient, as the same piece of bakeware can be used for cooking, serving, and storing food.</p> | <p>Reduce the cooking temperature by 25°F (13-14°C) when using glass bakeware.</p> |
| <p>Insulated bakeware</p>  | <p>Insulated bakeware cooks cooler than shiny bakeware. Insulated bakeware is designed for baking in gas ovens.</p> | <p>When using insulated bakeware, the recipe baking time may be longer than usual.</p> |

10 COOKING RECOMMENDATIONS

Cooking Conditions

Conditions in your kitchen can affect the performance of your appliance when cooking food.

| Condition | Attributes | Recommendation |
|----------------|---|---|
| Aging cookware | As pans age and become discolored, cooking times may need to be reduced slightly. | If food is too dark or overcooked, use the minimum cook time in the recipe or packaging. If food is too light or undercooked, use the middle to maximum cook time in the recipe or packaging. |
| High altitude | Air is drier and air pressure is lower. Water boils at a lower temperature, and liquids evaporate faster. Foods may take longer to bake. Doughs may rise faster. | Adjust cooking temperature, cooking time, or recipes as needed. Increase amount of liquid in baking recipes. Increase cook time on cooktop. Cover dishes to reduce evaporation. Increase bake time or oven temperature. Reduce amount of baking soda or baking powder in recipe. Reduce rising time or punch down dough and allow it to rise twice. |

Cooking Results

Small adjustments may help you achieve the best results.

| Result | Recommendation |
|----------------|---|
| Food too light | Use the middle to maximum cook time recommended on packaging or recipe. |
| Food too dark | Use the minimum cook time recommended on packaging or recipe. |

Cooking Tips

Use these additional tips to get the best results from your appliance.

| Situation | Recommendation |
|-------------------------|--|
| Baking | |
| Rack placement | Follow the instructions in particular oven mode starting in "Setting Oven Controls" on page 20. |
| Preheat | Fully preheat the oven before baking items like cookies, cakes, biscuits and breads. Insert food immediately after the beep. |
| Checking food | Use the window and oven light when checking food. Opening the door may reduce baking performance. |
| Bake or Convection Bake | Convection bake is the best function to use for baking on multiple racks. For best performance, see "Convection Bake" on page 24 |
| Food placement | Allow at least 2 inches (5 cm) of space between bakeware for proper air circulation. |

| Material | Recommendation |
|----------------------------|--|
| Broiling / Roasting | |
| Broiling pan | For best results when broiling, use a broil pan with an insert designed to drain the fat from the food, help avoid spatter, and reduce smoking. The broiler pan will catch grease spills, and the insert helps prevent grease splatters. |
| Convection Cooking | |
| Convection attributes | Convection cooking uses a fan to circulate hot air around the oven and food. It browns food more evenly and reduces hot spots in the oven. Convection saves time when using multiple racks or cooking several food items at once. |
| Convection bake | Reduce cooking temperature by 25° F (13-14° C) from the recipe unless the recipe is written for convection baking. Preheat the oven for best results. |

12 BEFORE SETTING OVEN CONTROLS

➔ IMPORTANT

Your Frigidaire wall oven has many features that allow you to customize the way your oven works.

Take time to read this section for important safety information and to become familiar with the many menu option settings starting on page 13.

Oven Vent Location

The oven is vented as shown below. When the oven is on, warm air is released through the vent. This venting is necessary for proper air circulation in the oven and good baking results. Do not block oven vent. Never close off the openings with aluminum foil or any other material. Steam or moisture may appear near the oven vent. This is normal.

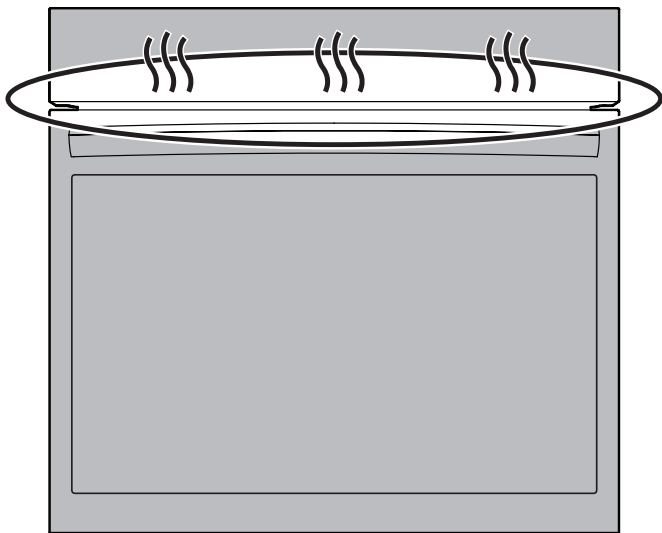

Figure 1: Oven vent

! WARNING

Protective Liners — Do not use aluminum foil or any other material or liners to line the oven bottom, walls, racks or any other part of the range. Doing so will alter the heat distribution, produce poor baking results, and possibly cause permanent damage to the oven interior. Improper installation of these liners may result in risk of electric shock or fire. During self clean, temperatures in the oven will be hot enough to melt foil.

! CAUTION

Always use pot holders or oven mitts when using the oven. When cooking, the oven interior, oven exterior, oven racks, and cooktop will become very hot which can cause burns.

Remove all oven racks before starting a self clean cycle. If oven racks are left inside the oven during a cleaning cycle, the slide ability of the oven racks may be damaged and all of the oven racks will lose their shiny finish.

To prevent possible damage to the oven, do not attempt to close the oven door until all the oven racks are fully positioned back inside the oven cavity.

Types of Oven Rack

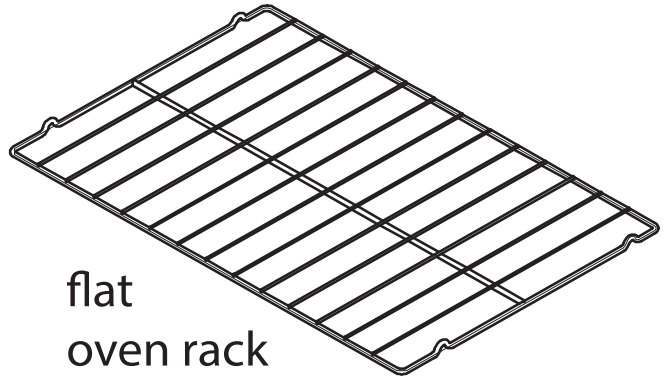

flat
oven rack

Figure 2: Oven rack types

Flat oven racks may be used for most cooking needs and may be placed in most oven rack positions.

! WARNING

Do not line the oven walls, racks, bottom or any other parts of the range with aluminum foil. Doing so will alter heat distribution, produce poor baking results and may cause permanent damage to the oven interior. During self-clean temperatures the oven will be hot enough to melt foil.

➔ IMPORTANT

Remove all oven racks and clean according to instructions provided in the Care & Cleaning section of this manual. Never pick up hot oven racks or parts.

Using Menu Options to Customize Your Cooking Experience

When you first install your appliance, the screen will prompt you to set your preferences. You can always change them later using the menu ≡ .

1. Touch the Menu Options bars and scroll to find the desired option.
2. Select option and set your preference.
3. Save and go back or **Save & Close**.

You can press the **X** to close without saving changes.

Clock

When the appliance is first plugged in or when the power supply to the appliance has been interrupted, the display will show 12:00. It is recommended to always set the clock for the correct time of day before using the appliance.

1. Touch **Menu Options** bars and scroll to **Clock**. You will see options to turn off the clock display when the oven is off, to change from 12-hour to 24-hour time, and to set the clock.
2. Touch **Set Clock** and set time using graph.
3. Set AM or PM
4. **Save & Close**

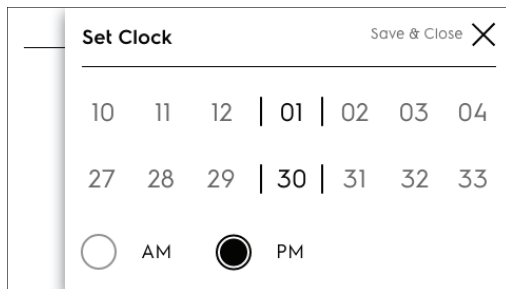

Energy Saving Mode

The oven control has a factory preset built-in 12-Hour Energy Saving feature that will turn off the oven if the oven is left on for more than 12 hours. The control may be programmed to override this feature to bake continuously.

1. Scroll to **Energy Saving Mode** and touch.
2. Follow the information to override the Energy Saving feature if necessary.
3. **Save & Close**.

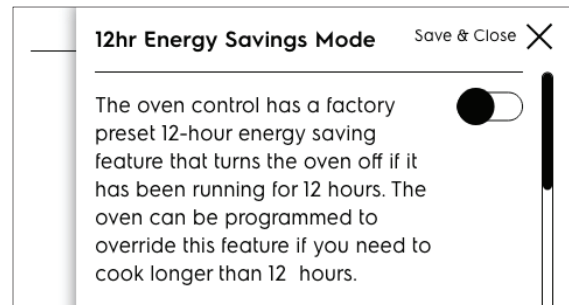

General Settings

1. Scroll to **General Settings** and touch.
2. Different options will appear.
3. Select an option to see how it is set and change if desired.

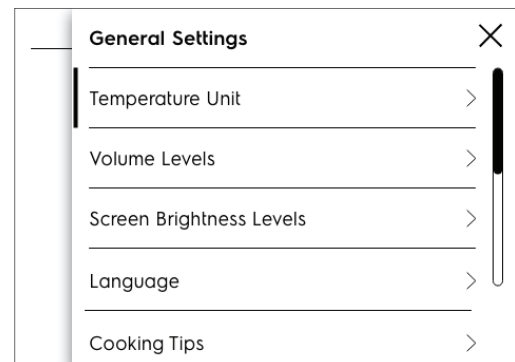

Temperature Display

The electronic oven control is set to display °F when shipped from the factory. The display may be changed to show either °F or °C oven temperatures.

Temperature Display > Fahrenheit
 Celcius

1. Select **Fahrenheit** or **Celcius**.
2. **Save & Close**

14 BEFORE SETTING OVEN CONTROLS

Volume

Volume allows the oven control to operate with strong tones, quiet tones, or no tones. Use the slider to set the volume.

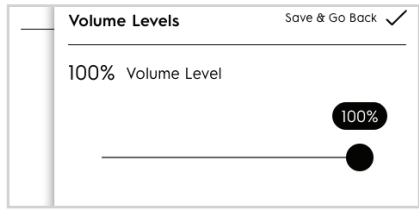

Screen Brightness

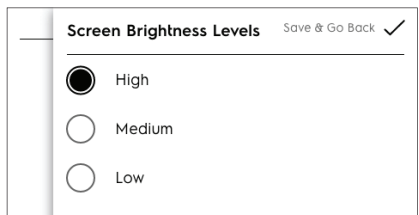

1. Choose brightness and Save & Close.

Language

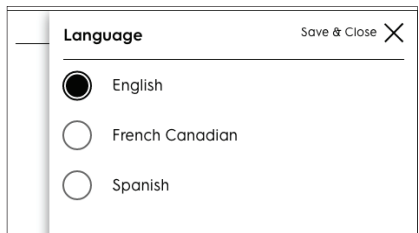

1. Select desired language.
2. **Save & Close.**

Favorites

Scroll to Favorites and touch.

- **Quick Start Options** > Oven 350°F (can change the default when Quick Start is selected)
 1. Change temperature if desired.
 2. **Save.**
- **Temperature Options** > Adjust Custom Preheat default.
 1. 325°F / 163°C
 2. 375°F / 191°C
 3. 400°F / 204°C

NOTE

These temperature options are also available in Custom Preheat menu on the main screen

Cooking Tips

You can switch whether cooking tips are displayed or not by choosing On or Off.

Oven Temperature Calibration

Your appliance has been factory calibrated and tested to ensure an accurate baking temperature. For the first few uses, follow your recipe times and temperature recommendations carefully. If you think the oven is cooking too hot or too cool for your recipe times, you can adjust the control so the oven cooks hotter or cooler than the temperature displayed.

Important: Do not use oven thermometers such as those found in grocery stores to check the temperature settings inside your oven. These oven thermometers may vary as much as 20 to 40 degrees from actual temperatures.

1. Scroll to **Oven Temperature Calibration** and touch.
2. Option to adjust is shown.
3. Use slide to increase or decrease default oven temperature.
4. Save and go back or **Save & Close.**

The oven temperature may be increased as much as +35°F (+19°C) or decreased -35°F (-19°C) from the factory calibrated settings.

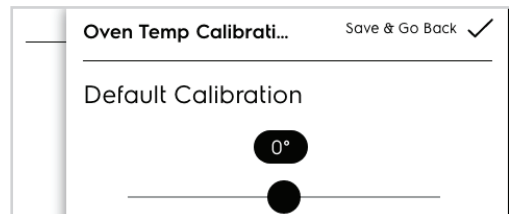

Sabbath Mode

1. Scroll to **Sabbath Mode**.
2. Read and follow all instructions to set and when finished cancel. See “Setting the Sabbath Feature for the Jewish Sabbath and Holidays (some models)” on page 46 for complete details on how Sabbath mode works with your oven controls.

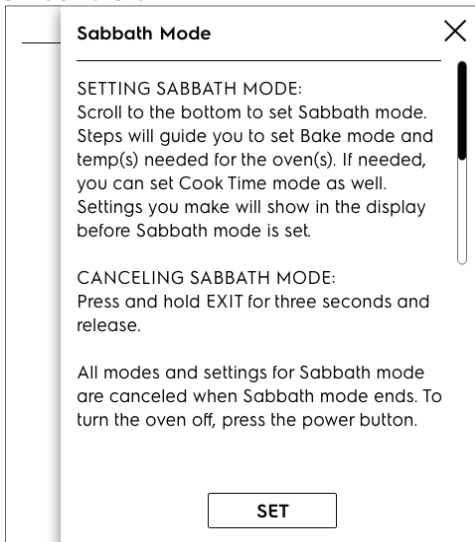

Factory Reset

1. **Scroll to Factory Reset and touch**
2. **Follow screen prompts**

Note: Your appliance was set with predetermined (default) oven control settings. Over time, users may have made changes to these settings. The following options may have been modified since the appliance was new:

- 12 or 24 hr display mode
- Screen Brightness
- Language
- Favorites
- Show Clock
- All Food Probe settings
- Continuous bake or 12 hour energy savings mode
- Silent or audible control
- Oven temperature display (Fahrenheit or Celsius)
- Oven temperature adjustments (UPO)

If Reset is touched all the settings will return to default.

3. **Are you sure?**
4. **Reset.**
5. **OKAY**

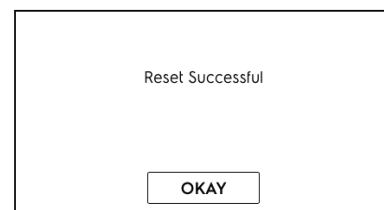
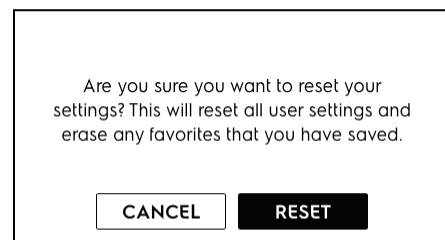

16 BEFORE SETTING OVEN CONTROLS

Lock Screen

As a safety measure the oven doors and controls can be locked. Follow screen directions to lock and unlock.

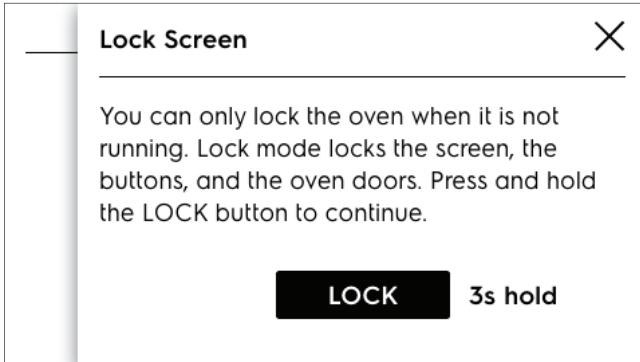

From the Settings Menu, Select **Lock Screen**, then touch and hold **LOCK** for 3 seconds.

When the doors and controls are locked the screen will show the time of day, a note that the oven is locked, and an **UNLOCK** key. Once the controls and door are locked, there is no access to any cooking functions. This ensures that the oven will remain locked and safe.

To unlock the oven door, press the **UNLOCK** key, Once the controls and door are locked, there is no access to any cooking functions.

To unlock the oven door and control, press **UNLOCK** and follow directions on the screen. You will be shown a code to use for unlocking the doors and controls.

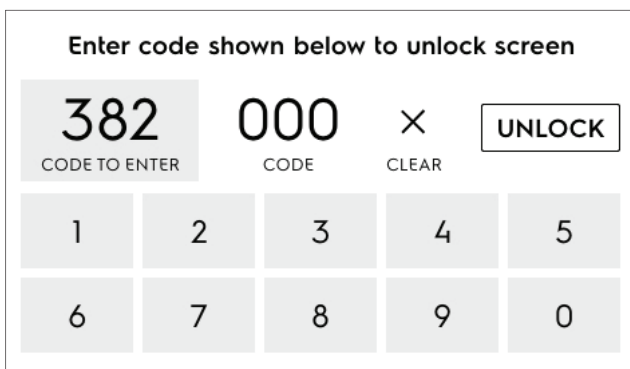

About the Appliance

1. Scroll to **About the Appliance** and touch.
2. Touch headings to see information.

Important information about the appliance such as the the software version number and contact information for support is listed here.

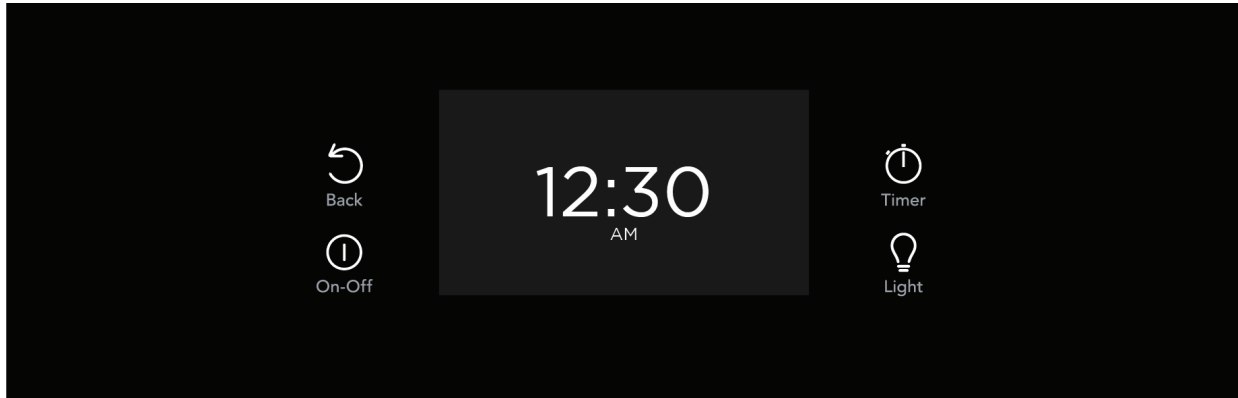

ON / OFF

When **ON/OFF** is pressed, the display opens to the Quick Start screen.

LIGHT

Press the Light key to turn the oven light on or off.

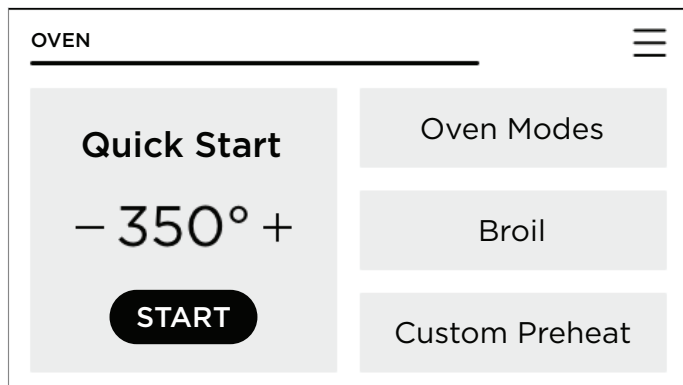

NOTE

In addition to ON/OFF, touching the screen will also activate the display.

If the oven is on when **ON/OFF** is pressed, it will turn off completely, canceling any functions that are running at the time.

BACK

Pressing the Back key will return to the previous screen without implementing any changes you may have selected.

TIMER

Pressing Timer will access the timer function. The timer will count down the amount of time you specify, and a tone will sound when the timer reaches zero. You can set a timer from 1 minute to 11 hours and 59 minutes.

Enter the desired time and press **START**. While the timer is running, you can pause or cancel the countdown. You can also add or subtract time by pressing + or -.

Table 1: Minimum and maximum control settings

| Feature | Mode | Min Temp/Time | Max Temp/Time |
|-------------|--------|---------------|----------------|
| Bake | | 170°F (77°C) | 550°F (288°C) |
| Broil | | 400°F (205°C) | 550°F (288°C) |
| Conv Bake | | 170°F (77°C) | 550°F (288°C) |
| Keep Warm | | 140°F (60°C) | 200°F (93°C) |
| Timer | | 0:01 Min | 11:59 Hr./Min. |
| Clock Time | 12 Hr. | 1:00 Hr./Min. | 11:59 Hr./Min. |
| | 24 Hr | 0:00 Min | 23:59 Hr./Min. |
| Delay Start | | 0:01 Min. | 1:00 Hr./Min. |
| Cook Time | 12 Hr. | 0:01 Min | 11:59 Hr./Min. |
| | 24 Hr | 0:01 Min | 11:59 Hr./Min. |
| Self clean | | 2 hours | 4 hours |

18 SETTING OVEN CONTROLS

Quick Start

When **ON/OFF** is pressed the display opens to the Quick Start screen.

From the Quick Start screen, you can immediately start the Bake function by pressing **START**. You can adjust the temperature by pressing **+** or **-**.

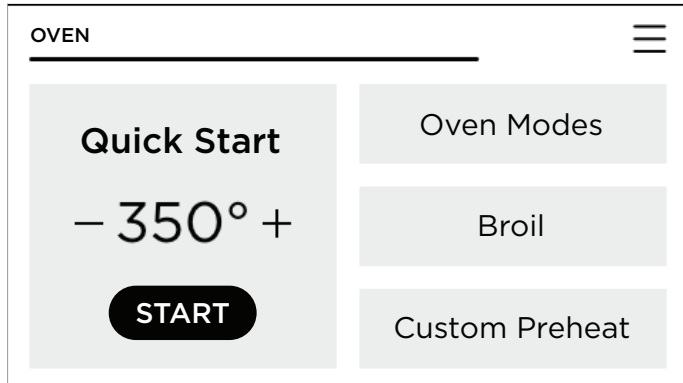

To select other cooking options, touch **Oven Modes** and scroll to the desired feature.

Use the scroll bar to find your oven mode as shown in the oven mode table on the right. When you select a cooking mode simply follow the tips for setting the particular mode.

Important: Valuable tips to help you get the best results are included in the display and also can be found in this Use & Care Manual.

Modes

- Bake (page 19)
- Convection Bake (page 21)
- Broil (page 22)
- Keep Warm (page 24)
- Self Clean (page 25)
- Delay Start (page 24)

Setting Bake

Bake uses heat that rises from the oven bottom for best baking results.

A reminder tone will sound indicating when the set bake temperature is reached and to place the food in the oven.

Bake may be set for any oven temperature between 170°F (77°C) to 550°F (288°C).

CAUTION

Always use pot holders or oven mitts when using the oven. When cooking the oven interior, oven racks, and cooktop will become very hot which can cause burns.

Baking Tips

- Fully preheat the oven before baking items like cookies, cakes, biscuits and breads.
- For all baking except layer cakes, pans should be pulled to the front of the rack. Place layer cake pans as shown.
- Use the convection bake function for best results when baking cookies or cakes on multiple racks.
- For best results when baking layer cakes using two oven racks, place racks in positions 2 (flat) and 5 (glide) and place pans centered on each rack.
- When using any single rack for baking cookies, cakes, biscuits, or muffins use rack position 3.
- Allow at least 2 inches (5 cm) of space between bakeware for proper air circulation.
- Leave oven lights off while baking.

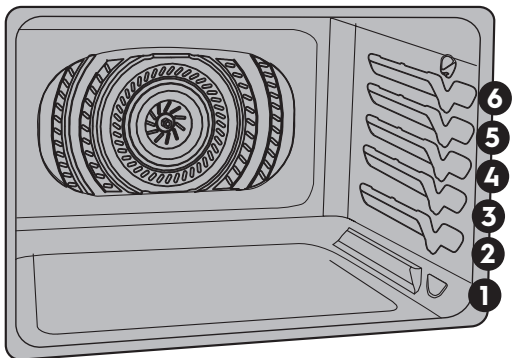

To set Bake

1. Press **ON/OFF** key.

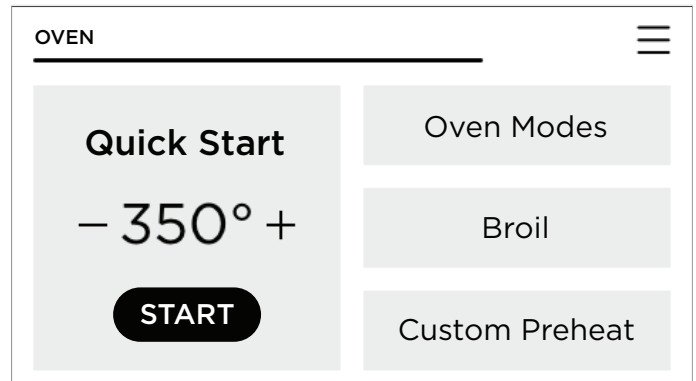

2. Touch **Oven Modes** and touch **Bake**. The default temperature 350°F will show in the display. You can also use the controls on the Quick Start screen.
3. To set the temperature to 375, use the numbered keys to program the new temperature of 375 and touch **START**.
4. The screen shows the current temperature and a **Cook Time** button.
5. Touch **Cook Time** to set a cooking time if needed.

NOTE: If a cook time is set the oven will turn off automatically when the time expires.

6. Touch **START**.
7. When cooking has ended, **Off** will be in display.
8. Press **ON/OFF** to return display to show the time of day.

To cancel cooking anytime touch **CANCEL**.

Press **ON/OFF** to turn off the oven and show time of day in the display.

To cancel cooking anytime touch **CANCEL**.

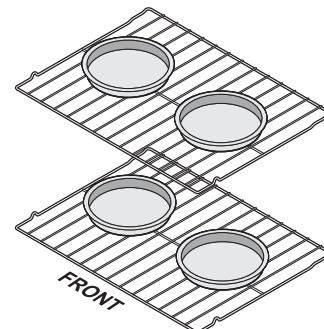

20 SETTING OVEN CONTROLS

Setting Cook Time

Use Cook Time to set the amount of time needed for most oven functions. The oven will turn on immediately (or after a specified delay) and stop automatically after the set cook time ends.

In most cases you will see a cooking tip suggesting to set Cook Time after the oven is preheated.

When the programmed cook time ends:

- **Off** will appear in the display window
- an alert tone will sound
- the oven will turn off automatically

The **Off** message and an **OKAY** button will display until **OKAY** is touched.

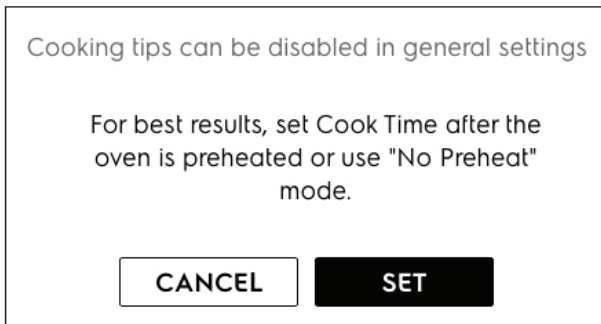

NOTE: The maximum cook time setting is 11 hours and 59 minutes unless the oven is set for continuous cooking.

To change the oven temperature or cook time after baking has started:

- Touch **+** or **-** on either side of the set temperature.
- Touch **TEMP** to access the keypad.

Convection Bake

Convection Bake uses a fan to circulate the oven's heat uniformly around the oven. This improved heat distribution allows for even cooking and browning results. Heated air flows around the food from all sides.

Convection bake may be set for any oven temperature between 170°F (77°C) and 550°F (288°C).

Benefits of convection cooking include:

- Multiple rack baking.

Convection baking tips:

- Use Convection Bake for best results when baking cookies and cakes on 2 racks.
- For best results it is recommended to preheat the oven before baking items like cookies, biscuits and breads and move pans to front of the racks.
- If your recipe is not written for convection baking, reduce the oven temperature by 25° or use Convection Convert option.
- No special pans or bakeware required.
- For cookies use the following racks:
- Single rack baking use 3 (flat rack).
- Two rack baking use 2 (flat) and 5 (glide).
- For baking cakes use the following rack positions and place bakeware as shown in Figure 4. In upper rack use position 4 (glide) or 5 (flat).
- Cookies and biscuits should be baked on pans with no sides or very low side to allow heated air to circulate around the food. Food items baked on pans with a dark finish will cook faster.
- Leave oven lights off while baking.

Convection Convert

Convection Convert automatically reduces the oven temperature from what is specified in most baking recipes to compensate for the increased cooking efficiency of convection baking.

To set convection bake with a default oven set temperature of 325°F (163°C):

1. Select **Oven Mode** and scroll to **Convection Bake**.
2. Touch **Convection Bake**: Default oven temp of 325° appears.
3. An option for **Convection Convert** is visible on the screen. Using it will lower the oven temperature 25° to account for the increased efficiency of convection. If used, Convection Convert must be selected before pressing Start.
4. Touch **START**:
5. Option to set **Cook Time**.
6. Touch **START**.
7. Oven will turn off when **Cook Time** is complete.
8. Cooking has ended and **Off** will be in display.
9. Press **ON/OFF** to return display to show the time of day.

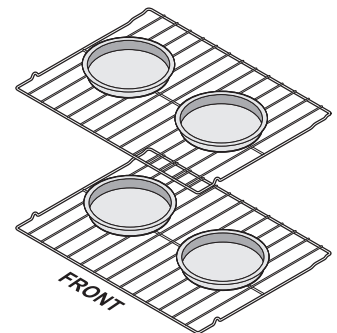
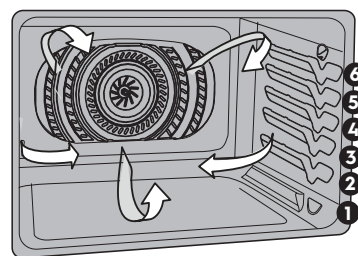
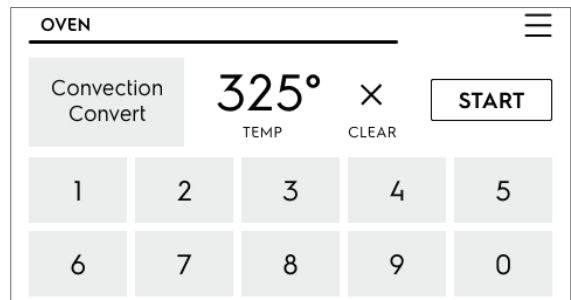

Figure 3: Pan positions for best results when baking cakes on two racks.

22 SETTING OVEN CONTROLS

Setting Broil

Use the broil function to cook foods that require direct exposure to radiant heat for optimum browning results. Broiling may produce smoke. If smoke is excessive, place food further away from the heating element.

The broil feature preset to 550°F. Broil may be set at any temperature between 400°F (205°C) and 550°F (288°C).

WARNING

Should an oven fire occur, close the oven door and turn the oven off. If the fire continues, use a fire extinguisher. Do not put water or flour on the fire. Flour may be explosive and water can cause a grease fire to spread and cause personal injury.

CAUTION

Always use pot holders or oven mitts when using the oven. When cooking, the oven interior, oven racks, and cooktop will become very hot which can cause burns.

IMPORTANT

Broiler pans and inserts allow the grease to drain away from the high heat of the broiler. Do not use the pan without the insert. Do not cover the insert with foil - the exposed grease could ignite.

If you do not have a broiler pan, you can order one from frigidaire.com.

To set broil with the default broil oven temperature of 550°F (288°C):

1. Arrange the oven racks when cool. For optimum browning results, preheat oven for 2 minutes before adding food.
2. Select **Oven Mode** and scroll to **Broil**.
3. Default **550°** appears.
4. If lower broil temperature is needed use keypad to select between 400° and 550°.

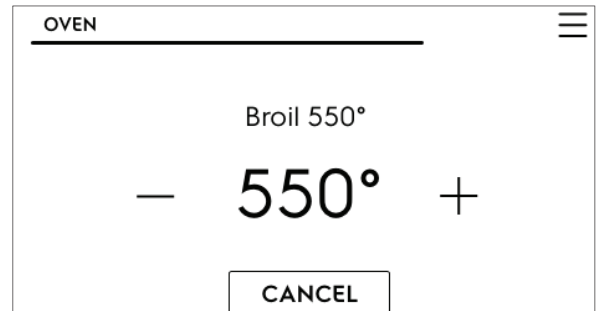

5. Press **START**. Broil with oven door closed.
6. Broil on one side until food is browned; turn and broil other side until done to your satisfaction.
7. When finished broiling, press **ON/OFF**.

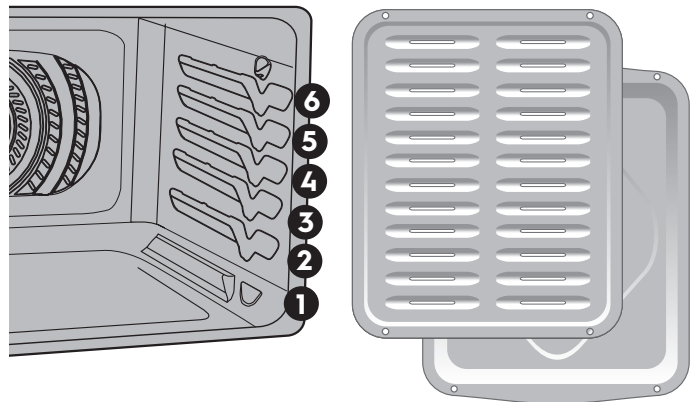

Important notes:

- Always arrange oven racks when the oven is cool.
- For best results when broiling, use a broil pan with broil pan insert designed to drain the fat from the food and help avoid spatter and reduce smoking.
- When broiling, always pull the oven rack out to the stop position before turning or removing food.

Table 2: Broil recommendations

| Food item | Rack Position | Temp | Cook time in minutes | | Internal Temperature | Doneness |
|-----------------------|---------------|---------------|----------------------|----------|----------------------|-------------|
| | | | 1st side | 2nd side | | |
| Steak 1" thick | 5 | 550°F (288°C) | 4:00 | 4:00 | 140°F (60°C) | Rare** |
| Steak 1" thick | 5 | 550°F (288°C) | 6:00 | 4:00 | 145°F (63°C) | Medium |
| Steak 1" thick | 5 | 550°F (288°C) | 7:00 | 5:00 | 160°F (71°C) | Medium-well |
| Steak 1" thick | 5 | 550°F (288°C) | 8:00 | 6:00 | 170°F (77°C) | Well |
| Pork Chops 3/4 "thick | 5 | 550°F (288°C) | 12:00 | 10:00 | 170°F (77°C) | Well |
| Chicken - Bone In | 5 | 450°F (232°C) | 20:00 | 10:00 | 170°F (77°C) | Well |
| Chicken Boneless | 5 | 450°F (232°C) | 8:00 | 6:00 | 170°F (77°C) | Well |
| Fish | 5 | 550°F (288°C) | as directed | | 170°F (77°C) | Well |
| Shrimp | 5 | 550°F (288°C) | as directed | | 170°F (77°C) | Well |
| Hamburger 1" thick | 5 | 550°F (288°C) | 9:00 | 7:00 | 145°F (63°C) | Medium |
| Hamburger 1" thick | 5 | 550°F (288°C) | 10:00 | 8:00 | 170°F (77°C) | Well |

The U.S. Department of Agriculture states, "**Rare fresh beef is popular, but you should know that cooking it to only 140°F (60°C) means some food poisoning organisms may survive." (Source: Safe Food Book, Your Kitchen Guide, USDA Rev. June 1985.) The lowest temperature recommended by the USDA is 145°F (63°C) for medium rare fresh beef. For well done 170°F (77°C). All cook times shown are after 2 minutes of preheating.

24 SETTING OVEN CONTROLS

Keep Warm

Keep Warm should only be used with foods that are already at serving temperatures. Keep warm will keep cooked foods warm and ready for serving after cooking has finished.

Keep warm will keep the oven temperature at 140° F - 200° F (60°C - 93°C).

To set Keep Warm:

1. If needed, arrange oven racks and place cooked food in oven.
2. Press **Oven Modes** and scroll to **Keep Warm**.
3. Touch **Keep Warm**.
4. Set desired temperature.
5. Press **START**.
6. **Keep Warm** will turn off when canceled.

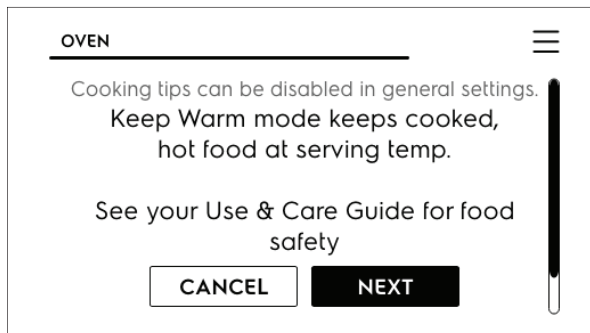

Setting Delay Start

Delay Start allows a delayed starting time only for Bake, Convection Bake, No Preheat, Convection Roast, Steam Roast, Steam Clean, and Self Clean. Prior to setting a delay start, be sure the time of day is set correctly. The maximum delay for a Delay Start is one hour (12 hours for Self Clean or Steam Clean).

1. Press **ON/OFF** key and touch **Oven Modes**.

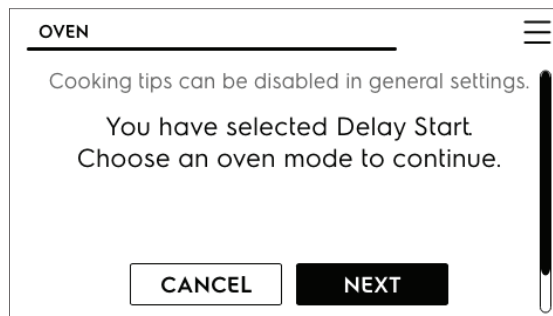

2. Scroll to **Delay Start** and touch.
3. Follow the information on the screen to set delay time, temperature, and cook time.

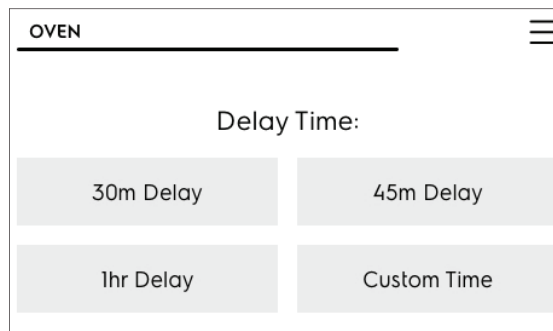

When the Delay Start time is reached, the oven will turn on and begin cooking. The screen will show the oven temperature.

When Cook Time (if used) ends, **Cooking is over** and **Off** and **OKAY** will appear in the display window, and the oven will shut off automatically.

The oven control will sound tones as a reminder until the **OKAY** is pressed.

WARNING

Food Poisoning Hazard. Do not let food sit for more than one hour before or after cooking. Doing so can result in food poisoning or sickness.

Self Clean

A self cleaning oven cleans itself with high temperatures (well above normal cooking temperatures), which vaporizes soils or reduces them to a fine powdered ash you can wipe away afterwards with a damp cloth. This function can be programmed for clean times between 2 and 4 hours.

Important: Before starting self clean read all following caution and important statements before starting a self clean cycle.

CAUTION

- Do not leave small children unattended near appliance. During self clean cycle, the outside of the oven can become very hot and cause burns if touched.
- Do not line the oven walls, racks, oven bottom, or any part of the range with aluminum foil. This will cause permanent damage to the oven interior and destroy heat distribution, and will melt to the oven interior.
- Do not force the oven door open. This will damage the automatic door locking system. Use caution when opening the oven door after the self clean cycle ends. The oven may still be very hot and cause burns. To avoid possible burns, stand to side of oven when opening door to allow steam or hot air to escape.
- The health of some birds is extremely sensitive to fumes given off during the self clean cycle of any range. Move birds to a well ventilated room.

Important notes:

- Completely remove all oven racks and any accessories from oven cavity to avoid damage to oven racks. If the oven racks are not removed they may discolor.
- Remove all items from the oven and cooktop including cookware, utensils, and any aluminum foil. Aluminum foil will not withstand high temperatures from a self clean cycle and will melt.
- Do not spray oven cleaners or oven protective coatings in or around any part of the oven interior. Clean any soil from the oven frame, the door liner outside the oven door gasket, and the small area at the front center of the oven bottom (page 25). These areas heat sufficiently to burn soil on. Clean using soap and water prior to starting Self Clean.

- Remove any excessive spills. Any spills on the oven bottom should be wiped up and removed before starting a self clean cycle. To clean use hot, soapy water and a cloth. Large spills can cause heavy smoke or fire when subjected to high temperatures.
- Do not allow food spills with high sugar or acid content (such as milk, tomatoes, sauerkraut, fruit juices, or pie fillings) to remain on the surface as they may leave a dull spot even after cleaning.
- Do not clean the oven door gasket. The woven material in the gasket is essential for a good seal. Care should be taken not to rub, damage, or remove the oven door gasket. Doing so could cause damage to the door gasket and compromise the performance of the oven.
- The kitchen area should be well ventilated using an open window, ventilation fan, or exhaust hood during the first self clean cycle. This will help eliminate the normal odors.

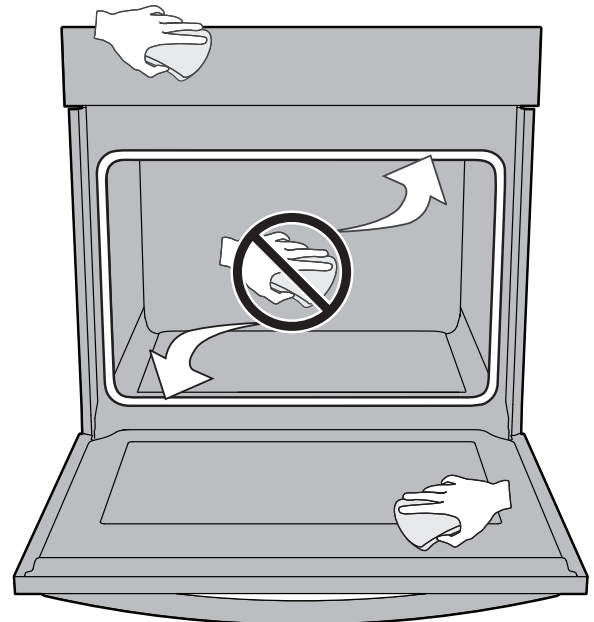

Figure 4: Clean around the oven door gasket

- Do not attempt to open the oven door when the OVEN LOCK indicator light is flashing. Allow about 15 seconds for the motorized door latch mechanism to completely lock or unlock the oven door.
- When the clean time finishes, the oven door will remain locked until the range has cooled sufficiently. In addition to the clean time that was programmed, you must allow about 1 additional hour for the oven to cool before you will be able to open the oven door.

26 SETTING OVEN CONTROLS

To set a self clean cycle:

1. Be sure the oven is empty and all oven racks are removed. Remove all items from the oven. Be sure oven door is completely closed.
2. Touch **Oven Modes** and scroll to **Self Clean**.
3. Touch **Self Clean** and select 2 hour, 3 hour, or 4 hour clean time.
4. Press **TIMER** to start the self clean cycle.

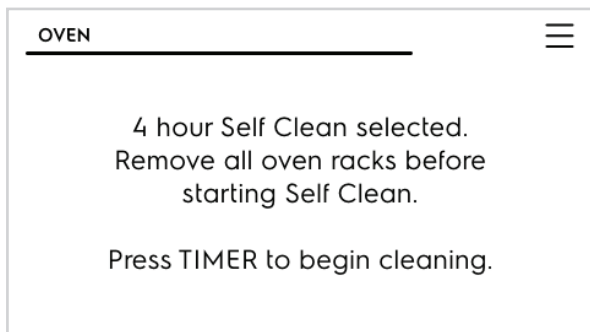
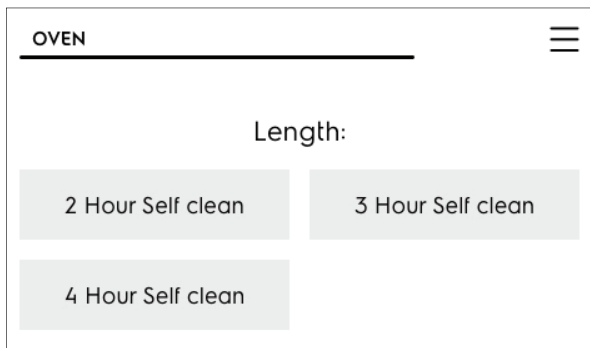

When the oven is set to run a self-clean cycle, the motor door lock will begin locking the oven door. Do not open the oven door while the lock motor is running or when any locking indicators or displays are showing. The oven door is completely locked in about 15 seconds. Once the oven door has locked, CLEAN will appear in the display indicating self clean has started.

Do not force the oven door open when self-clean is active. This can damage the automatic door-locking system. Use caution when opening the door after self-clean cycle is complete; the oven may still be very hot.

When the self clean cycle has completed:

1. **CLEAN** message will turn off, and **Hot** will appear in display window. The oven door will remain locked while the oven cools.
2. Once the oven has cooled down (about 1 hour) and **Hot** is no longer displayed, the oven door may be opened.
3. When the oven interior has completely cooled, wipe away any residue or powdered ash with a damp cloth or paper towel.

Setting Delay Start Self Clean

To start a delay self clean with default clean time of 3 hours.

1. Press **ON/OFF** key and touch **Oven Modes**.
2. Scroll and touch **Delay Start**.

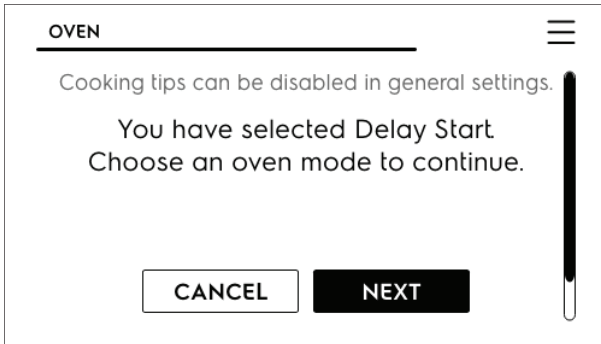

3. Touch **NEXT** and scroll Oven Modes to **Self Clean**. Follow the information on the screen to set delay time, self clean time.

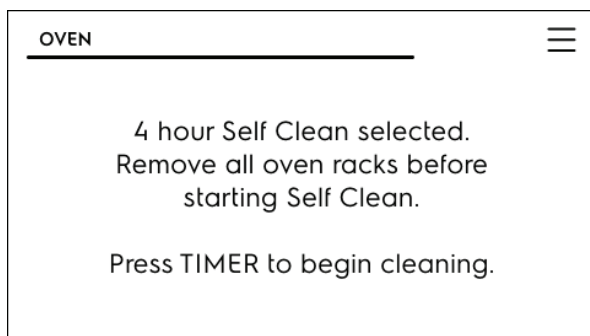
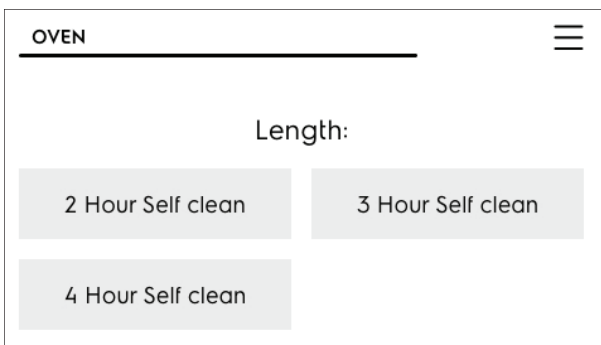

If it becomes necessary to stop self clean when active:

- Press **OFF**.
- If self clean has heated the oven to a high temperature, allow enough time for the oven to cool.
- Before restarting self clean, be sure to read important notes below.

Important notes

- If self clean was active and then interrupted by a power failure or canceled before the oven was thoroughly cleaned, it may be necessary to run another self clean cycle.
- If the oven temperature was high enough when self clean was interrupted the oven control may not allow another self clean cycle to be set for up to 4 hours.

28 SETTING OVEN CONTROLS

Setting the Sabbath Feature for the Jewish Sabbath and Holidays (some models)



For further assistance, guidelines for proper usage, and a complete list of models with the Sabbath feature, please visit the web at www.star-k.org.

This appliance provides special settings for use when observing the Jewish Sabbath/Holidays. Sabbath mode disables all audible tones or visual display changes on the oven control. Bake is the only cooking feature available while in the Sabbath mode. Most oven controls are locked during Sabbath mode.

To start Sabbath Mode, first select Sabbath from the settings menu. Next, select Delay (if desired), Bake temperature, and cook time (if desired) and set. Cooking will begin after any specified delay.

If cook time was set, once the time has elapsed, the cooking will end and the display will show Idle to indicate that the cook time has ended.

Important: The Sabbath mode will override the factory preset 12 hour energy saving mode, and the appliance will stay on until the cooking features are canceled. If cooking is canceled when the appliance is in the Sabbath mode, no audible or visual indicators will be available to verify the cancellation.

If the oven interior lights are needed, be sure to activate them prior to setting the Sabbath mode. Once the oven light is turned on and the Sabbath mode is active, the oven light will remain on until the Sabbath mode is turned off and the oven lights are turned off. The oven door will not activate the interior oven lights when the oven door is opened or closed.

It is recommended that any oven temperature modification made within an active Sabbath mode press the + or - key.

The temperature will increase or decrease with each press by 5°F or 1°C and the change will be accepted automatically.

WARNING

Food poisoning hazard. Do not let food sit for more than one hour before or after cooking. Doing so can result in food poisoning or sickness. Foods that can easily spoil such as milk, eggs, fish, meat or poultry, should be chilled in the refrigerator first. Even when chilled, they should not stand in the oven for more than 1 hour before cooking begins, and should be removed promptly when finished cooking.

Important:

- Do not attempt to activate any other oven function except Bake while the Sabbath feature is active. When the Sabbath feature is active, only the + and - keys and OFF will function. ALL OTHER KEYS should not be used once the Sabbath feature is active.
- You may change the oven temperature once baking has started. Use the + and - keys to raise or lower the oven temperature. Each press of an arrow key will raise or lower the temperature by 5°F (1°C).
- Remember that the oven control will no longer provide audible tones or display any further changes when the Sabbath feature is active.
- The oven will shut-off automatically after completing a bake time and therefore may only be used once during the Sabbath/Jewish Holidays.

SETTING SABBATH MODE:

Sabbath Mode is set using the **Menu Options**.

1. Touch the **Menu Options** bars.
2. Scroll to **Sabbath Mode**.
3. Touch **Sabbath Mode** and follow all instructions on screen.

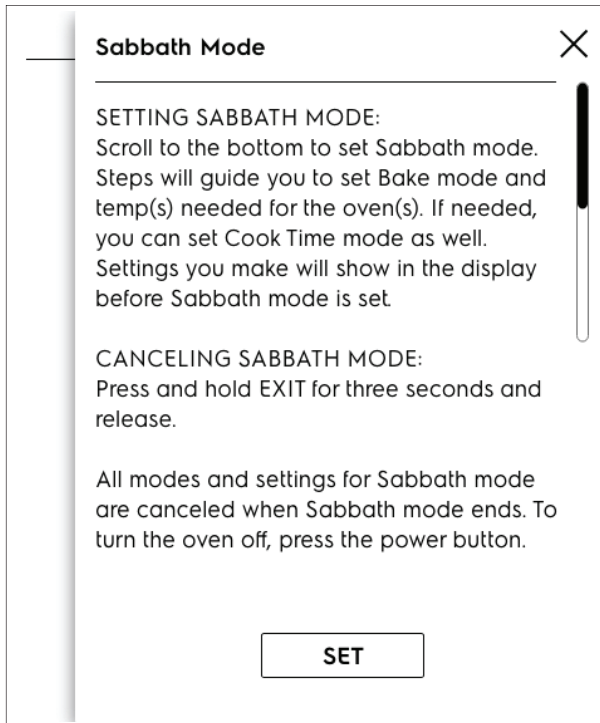

To exit Sabbath Mode, press and hold **EXIT** for three seconds.

30 CARE AND CLEANING

Remove spills and any heavy soiling as soon as possible. Regular cleaning will reduce the difficulty of major cleaning later.

CAUTION

Before cleaning any part of the appliance, be sure all controls are turned off and the appliance is cool.

If ammonia or appliance cleaners are used, they must be removed and the appliance must be thoroughly rinsed before operating. Follow manufacturer's instructions and provide adequate ventilation.

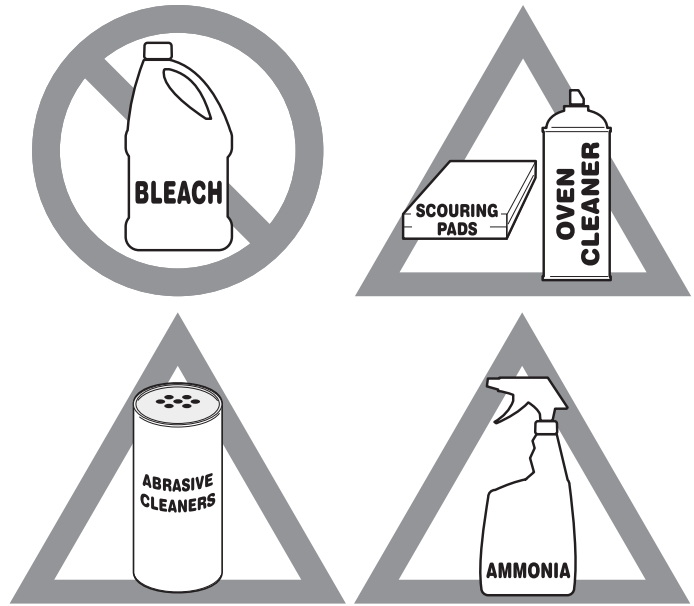

Figure 5: Use cleaners with caution

| Surface or Area | Cleaning Recommendation |
|--|--|
| Aluminum and vinyl | Using a soft cloth, clean with mild dish detergent and water. Rinse with clean water, dry and polish with a soft, clean cloth. |
| Painted body parts Painted decorative trims | Using a soft cloth, clean with mild dish detergent and water or a 50/50 solution of vinegar and water. Rinse with clean water, dry and polish with a soft, clean cloth. Glass cleaners may be used, but do not apply directly to surface; spray onto cloth and wipe. |
| Touch display | Using a soft cloth, clean with mild dish detergent and water or a 50/50 solution of vinegar and water. Do not spray liquids directly on the display area. Do not use large amounts of water on the display - excess water may cause damage to the appliance. Do not use other liquid cleaners, abrasive cleaners, scouring pads, or paper towels - they may damage the finish. |
| Control panel | Using a soft cloth, clean with mild dish detergent and water or a 50/50 solution of vinegar and water. Do not spray liquids directly on the oven control and display area. Do not use large amounts of water on the control panel - excess water on the control area may cause damage to the appliance. Do not use other liquid cleaners, abrasive cleaners, scouring pads, or paper towels - they will damage the finish. |
| Control knobs | Using a soft cloth, clean with mild dish detergent and water or a 50/50 solution of vinegar and water. To remove control knobs: turn to the OFF position, grasp firmly, and pull off the shaft. To replace knobs after cleaning, line up the OFF markings and push the knobs into place. |
| Stainless Steel | Using a soft cloth, clean with mild dish detergent and water or a 50/50 solution of vinegar and water. Rinse with clean water, dry with a soft clean cloth. Do not use cleaners containing abrasives, chlorides, chlorine, or ammonia. |
| Coated Stainless Steel | Using a soft cloth, clean with mild dish detergent and water or a 50/50 solution of vinegar and water. Rinse with clean water, dry with a soft clean cloth. Do not use appliance cleaner, stainless steel cleaner, or cleaner containing abrasives, chlorides, chlorine, or ammonia. These cleaners may damage the finish. |

| Surface or Area | Cleaning Recommendation |
|---|--|
| Porcelain-enameled broiler pan and insert Porcelain door liner Porcelain body parts | Rinse with clean water and a damp cloth. Scrub gently with a soapy, non-abrasive scouring pad to remove most spots. Rinse with a 50/50 solution of clean water and ammonia. If necessary, cover difficult spots with an ammonia-soaked paper towel for 30 to 40 minutes. Rinse and wipe dry with a clean cloth. Remove all cleaners or future heating could damage the porcelain. Do not allow food spills with a high sugar or acid content (milk, tomatoes, sauerkraut, fruit juices or pie filling) to remain on porcelain surfaces. These spills may cause a dull spot even after cleaning. |
| Self-cleaning oven interior | Before setting a self-clean cycle, clean soils from the oven frame, areas outside the oven door gasket, and the small area at the front center of the oven bottom. See "Self Clean" on page 39. |
| Oven door | Use mild dish detergent and water or a 50/50 solution of vinegar and water to clean the top, sides, and front of the oven door. Rinse well. Glass cleaner may be used on the outside glass of the door. Ceramic smoothtop cleaner or polish may be used on the interior door glass. Do not immerse the door in water. Do not spray or allow water or cleaners to enter the door vents. Do not use oven cleaners, cleaning powders, or any harsh abrasive cleaning materials on the outside of the oven door. Do not clean the oven door gasket. The oven door gasket is made of a woven material which is essential for a good seal. Do not rub, damage, or remove this gasket. |

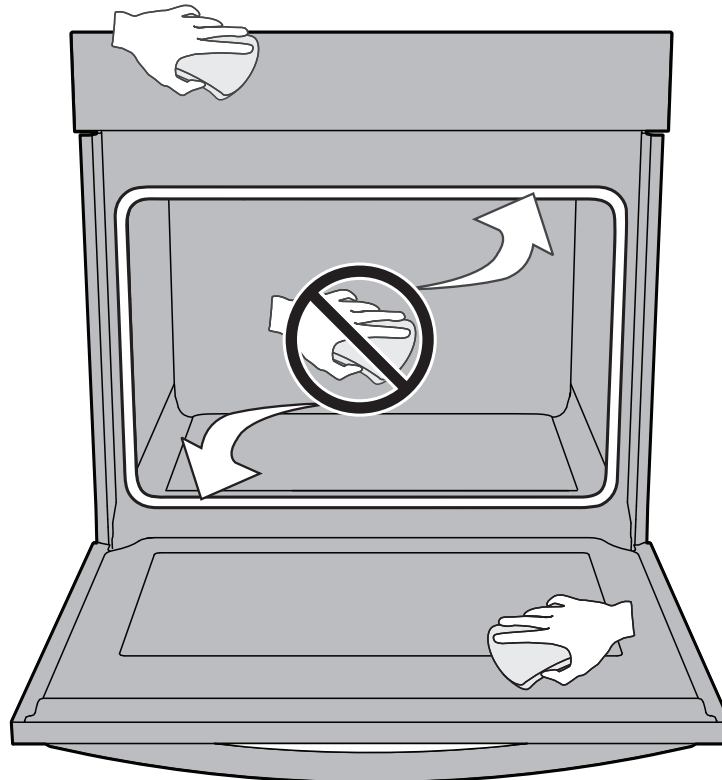

Figure 6: Do not clean oven door gasket

32 CARE AND CLEANING

General Cleaning

Refer to the table at the beginning of this chapter for more information about cleaning specific parts of the oven.

Follow these cleaning precautions:

- Allow the oven to cool before cleaning.
- Wear rubber gloves when cleaning the appliance manually.

Remove soils using hot, soapy water. Do not allow food spills with a high sugar or acid content (such as milk, tomatoes, sauerkraut, fruit juices or pie filling) to remain on the surface as they may cause a dull spot even after cleaning. Remove spillovers and heavy soiling as soon as possible. Regular cleaning will reduce the effort required for major cleaning later.



CAUTION

Before manually cleaning any part of the oven, be sure all controls are turned off and the oven is cool. The oven may be hot and can cause burns.

Remove all racks and accessories from the oven before cleaning.

Ammonia must be rinsed before operating the oven. Provide adequate ventilation.

Cleaning Porcelain Enamel Oven

The oven interior is porcelain on steel, it is safe to clean using oven cleaners.

To remove heavy soil:

1. Allow a dish of ammonia to sit in the oven overnight or for several hours with the oven door closed. Clean softened dirt spots using hot, soapy water. Rinse well with water and a clean cloth.
2. If soil remains, use a nonabrasive scouring pad or a nonabrasive cleaner. If necessary, use an oven cleaner following manufacturer's instructions. Do not mix ammonia with other cleaners.
3. Clean any soil from the oven frame, the door liner outside the oven door gasket and the small area at the front center of the oven bottom. Clean with hot, soapy water. Rinse well using clean water and a cloth.

Broiler Pan Cleaning Tips

To prevent grease from baking on, remove the broiler pan from the oven as soon as cooking is completed. Use oven mitts because the broiler pan is extremely hot. Pour off grease. Soak the pan in hot, soapy water.

Clean the broiler pan as soon as possible after each use. If necessary, use soap-filled steel wool pads. Heavy scouring may scratch the grid.

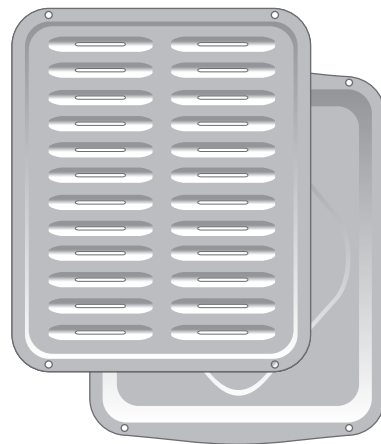

Figure 7: Broiler pan with insert

Aluminum Foil, Aluminum Utensils, and Oven Liners

WARNING

Never cover any slots, holes, or passages in the oven bottom or cover an entire oven rack with materials such as aluminum foil. Doing so blocks air flow through the oven and may cause carbon monoxide poisoning. Aluminum foil linings may trap heat, causing a fire hazard.

- Protective liners—Do not use aluminum foil to line the oven bottom. The high heat of the oven can melt these materials to the oven cavity and ruin the oven. These types of materials can also reduce the effectiveness of the air circulation in the oven and produce poor baking results. Only use aluminum foil as recommended in this manual. Improper installation of these liners may result in risk of electric shock or fire.
- Aluminum utensils - The melting point of aluminum is much lower than that of other metals. Care must be taken when aluminum pots or pans are used.
- Oven racks - Do not use aluminum foil to cover the oven racks. Using a liner in the oven restricts the heat and air flow needed to obtain the best possible cooking results for any oven.

Replacing the Oven Light

CAUTION

Be sure the oven is unplugged and all parts are cool before replacing the oven light.

The interior oven light is located at the rear of the oven cavity and is covered by a glass shield. The glass shield must be in place whenever the oven is in use.

To replace the oven interior light bulb:

1. Turn electrical power off at the main source or unplug the appliance.
2. Remove interior oven light shield by turning a quarter turn counter-clockwise.
3. Replace bulb with a new T-4 type Halogen 25 watt appliance bulb.

NOTE

Wear a cotton glove or use a paper towel when installing a new bulb. Do not touch the new bulb with your fingers when replacing. This will shorten the life of the bulb.

4. Replace glass oven light shield by rotating clockwise.
5. Turn power back on again at the main source (or plug the appliance back in).
6. Be sure to reset the time of day on the clock.

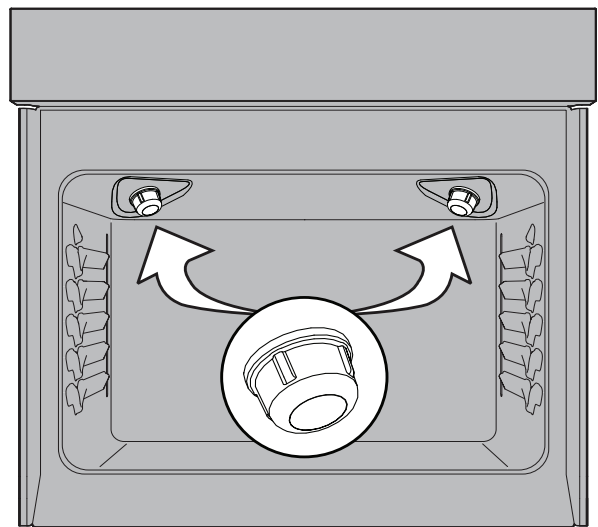

Figure 8: Wall oven Halogen light

34 CARE AND CLEANING

Removing and Replacing the Oven Door

CAUTION

The door is heavy. For safe, temporary storage, lay the door flat with the inside of the door facing down.

IMPORTANT

Special door care instructions - For safe, temporary storage, lay the door flat with the inside of the door facing down.

Most oven doors contain glass that can break. Do not hit the glass with pots, pans, or any other object. Scratching, hitting, jarring, or stressing the glass may weaken its structure, causing an increased risk of breakage at a later time. Do not close the oven door until all of the oven racks are fully in place.

To remove the oven door:

1. Open oven door completely, horizontal with floor (Figure 9).
2. Pull up the lock located on each hinge support toward front of the oven until the lock stops. You may have to apply a little upward pressure on the lock to pull it up (Figure 10).
3. Grasp the door by the sides, and close the door until the door frame makes contact with the unlocked hinges (Figure 11).
4. Pull the bottom of the door toward you while rotating the top of the door toward the appliance to completely disengage the hinge levers (Figure 12).

To replace the oven door:

1. Firmly grasp both sides of oven door along the door sides. Do not use the oven door handle (Figure 12).
2. Hold the oven door at the same angle as the removal position (Figure 11). Carefully insert the hinge levers into the oven frame until you feel the hinge levers are seated into the hinge notches. The hinge arms must be fully seated into the hinge notches before the oven door can be fully opened.
3. Fully open the oven door, horizontal with floor (Figure 9).
4. Push the door hinge locks up toward and into the oven frame on both left and right oven door hinges to the locked position (Figure 10).
5. Close the oven door.

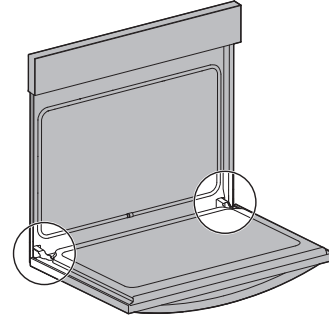

Figure 9: Door hinge location

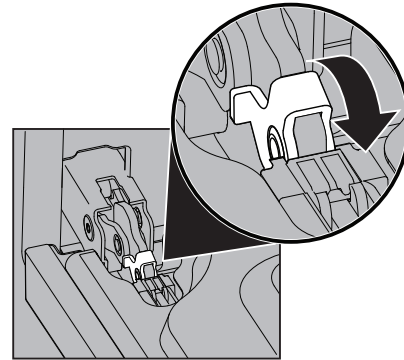

Figure 10: Door hinge lock

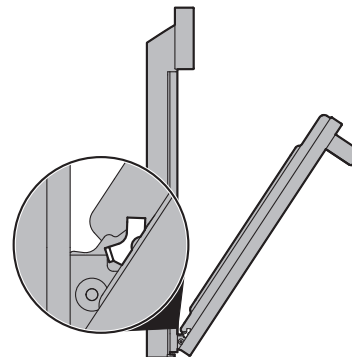

Figure 11: Removal position

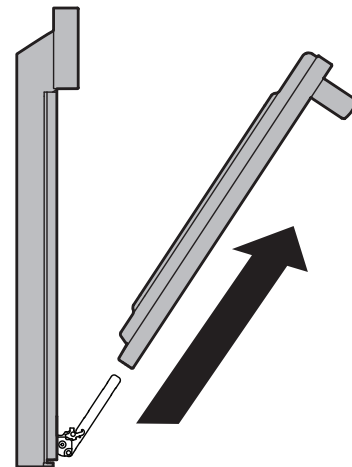







Figure 12: Remove door

BEFORE YOU CALL

Oven Baking

For best cooking results, preheat the oven before baking cookies, breads, cakes, pies, pastries, etc. There is no need to preheat the oven for roasting meat or baking casseroles. The cooking times and temperatures needed to bake a product may vary slightly from your previously owned appliance.

| Baking Problems and Solutions Baking Problems | | |
|--|---|--|
| Baking Problems | Causes | Corrections |
| Cookies and biscuits burn on the bottom.  | Cookies and biscuits put into oven before oven is preheated. | Allow oven to preheat to desired temperature before placing food in oven. Choose pan sizes that will permit at least 2" of air space. |
| Cakes too dark on top or bottom  | Cakes put in oven before oven is preheated. Rack position too high or too low. Oven too hot. | Allow oven to preheat to the selected temperature before placing food in the oven. Use proper rack position for baking needs. Set oven temperature 25°F (13°C) lower than recommended. |
| Cakes not done in center  | Oven too hot. Incorrect pan size. Pan not centered in oven. Glass cookware slow heat conductor. | Set oven temperature 25°F (13°C) lower than recommended. Use pan size suggested in recipe. Use proper rack position and place pan so there are at least 2" (5.1 cm) of space on all sides of pan. Reduce temperature and increase cook time or use shiny bakeware. |
| Cakes not level.  | Oven not level. Pan too close to oven wall or rack overcrowded. Pan warped. Oven light left on while baking. | Place a marked glass measuring cup filled with water on the center of the oven rack. If the water level is uneven, refer to the installation instructions for leveling the oven. Use proper rack position and place pan so there are at least 2" (5.1 cm) of space on all sides of pan. Do not use pans that are dented or warped. Do not leave the oven light on while baking. |
| Foods not done when cooking time is over.  | Oven too cool. Oven overcrowded. Oven door opened too frequently. | Set oven temperature 25°F (13°C) higher than suggested and bake for the recommended time. Be sure to remove all pans from the oven except the ones to be used for baking. Open oven door only after the shortest recommended baking time. |

Let us help you troubleshoot your concern! This section will help you with common issues. If you need us, visit our website, chat with an agent, or call us. We may be able to help you avoid a service visit. If you do need service, we can get that started for you!

1-800-374-4432 (United States)
Frigidaire.com

1-800-265-8352 (Canada)
Frigidaire.ca

| Problem | Cause / Solution |
|-----------------------------------|---|
| Entire appliance does not operate | Appliance not connected. Make sure power cord is plugged properly into outlet. Check your fuse box or breaker box to make sure the circuit is active. Electrical power outage. Check house lights to be sure. Call your local electric company for service outage information. |

| Oven Problems | |
|---|---|
| Problem | Cause / Solution |
| Poor baking results. | Many factors affect baking results. Use proper oven rack position. Center food in the oven and space pans to allow air to circulate. Preheat the oven to the set temperature before placing food in the oven. Try adjusting the recipe's recommended temperature or baking time. See "Oven Temperature Calibration" on page 14 if you feel the oven is too hot or too cool. |
| Flames inside oven or smoking from oven vent. | Excessive spills in oven. Grease or food spilled onto the oven bottom or oven cavity. Wipe up excessive spills before starting the oven. If flames or excessive smoke are present when using broil, see "Setting Broil" on page 34. |
| Oven smokes excessively when broiling. | Incorrect setting. Follow the "Setting Broil" on page 34. Meat too close to the broil element or burner. Reposition the broil pan to provide proper clearance between the meat and broil element or burner. Remove excess fat from meat. Cut remaining fatty edges to prevent curling, but do not cut into lean. Grease build up on oven surfaces. Regular cleaning is necessary when broiling frequently. Grease or food splatters will cause excessive smoking. |
| Convection fan does not rotate. | Oven door is open. The convection fan will turn off if the oven door is opened when convection is active. Close the oven door. |

BEFORE YOU CALL

| Self-Clean Problems | |
|---|--|
| Problem | Cause / Solution |
| Self clean does not work. | Oven control not set properly. See "Self Clean" on page 40. |
| Oven racks discolored or do not slide easily. | Oven racks left in oven cavity during self clean. Remove oven racks from oven cavity before starting a self-clean cycle. Clean by using a mild abrasive cleaner following manufacturer's instructions. Rinse with clean water, dry, and replace in oven. |
| Soil not completely removed after self clean. | <p>Self clean was interrupted. Review instructions on "Self Clean" on page 40.</p> <p>Excessive spills on oven bottom. Remove excessive spills before starting self clean.</p> <p>Failure to clean soil from the oven frame, the door liner outside the oven door gasket, and the small area at the front center of the oven bottom. These areas are not in the self-cleaning area, but get hot enough to burn on residue. Clean these areas before starting the self-cleaning cycle. Burned-on residue can be cleaned with a stiff nylon brush and water or a nylon scrubber. Be careful not to damage the oven gasket.</p> |

| Other Problems | |
|---|---|
| Problem | Cause / Solution |
| Appliance is not level. | <p>Poor installation. Place the oven rack in the center of the oven. Place a level on the oven rack. Adjust the leveling legs at the base of the appliance until the rack is level.</p> <p>Kitchen cabinet alignment may make range appear not level. Be sure cabinets are square and have sufficient room for appliance clearance.</p> |
| Cannot move appliance easily. Appliance must be accessible for service. | Cabinets not square or are built in too tightly. Contact the builder or installer to make the appliance accessible. |
| Oven light does not work. | Be sure the oven light is secure in the socket. See "Replacing the Oven Light" on page 62. |

38 WARRANTY

Your appliance is covered by a one year limited warranty. For one year from your original date of purchase, Electrolux will pay all costs for repairing or replacing any parts of this appliance that prove to be defective in materials or workmanship when such appliance is installed, used and maintained in accordance with the provided instructions.

Exclusions

This warranty does not cover the following:

Products with original serial numbers that have been removed, altered or cannot be readily determined.

Product that has been transferred from its original owner to another party or removed outside the USA or Canada.

Rust on the interior or exterior of the unit.

Products purchased "as-is" are not covered by this warranty.

Food loss due to any refrigerator or freezer failures.

Products used in a commercial setting.

Service calls which do not involve malfunction or defects in materials or workmanship, or for appliances not in ordinary household use or used other than in accordance with the provided instructions.

Service calls to correct the installation of your appliance or to instruct you how to use your appliance.

Expenses for making the appliance accessible for servicing, such as removal of trim, cupboards, shelves, etc., which are not a part of the appliance when it is shipped from the factory.

Service calls to repair or replace appliance light bulbs, air filters, water filters, other consumables, or knobs, handles, or other cosmetic parts.

Surcharges including, but not limited to, any after hour, weekend, or holiday service calls, tolls, ferry trip charges, or mileage expense for service calls to remote areas, including the state of Alaska.

Damages to the finish of appliance or home incurred during installation, including but not limited to floors, cabinets, walls, etc.

Damages caused by: services performed by unauthorized service companies; use of parts other than genuine Electrolux parts or parts obtained from persons other than authorized service companies; or external causes such as abuse, misuse, inadequate power supply, accidents, fires, or acts of God.

DISCLAIMER OF IMPLIED WARRANTIES; LIMITATION OF REMEDIES

CUSTOMER'S SOLE AND EXCLUSIVE REMEDY UNDER THIS LIMITED WARRANTY SHALL BE PRODUCT REPAIR OR REPLACEMENT AS PROVIDED HEREIN. CLAIMS BASED ON IMPLIED WARRANTIES, INCLUDING WARRANTIES OF MERCHANTABILITY OR FITNESS FOR A PARTICULAR PURPOSE, ARE LIMITED TO ONE YEAR OR THE SHORTEST PERIOD ALLOWED BY LAW, BUT NOT LESS THAN ONE YEAR. ELECTROLUX SHALL NOT BE LIABLE FOR CONSEQUENTIAL OR INCIDENTAL DAMAGES SUCH AS PROPERTY DAMAGE AND INCIDENTAL EXPENSES RESULTING FROM ANY BREACH OF THIS WRITTEN LIMITED WARRANTY OR ANY IMPLIED WARRANTY. SOME STATES AND PROVINCES DO NOT ALLOW THE EXCLUSION OR LIMITATION OF INCIDENTAL OR CONSEQUENTIAL DAMAGES, OR LIMITATIONS ON THE DURATION OF IMPLIED WARRANTIES, SO THESE LIMITATIONS OR EXCLUSIONS MAY NOT APPLY TO YOU. THIS WRITTEN WARRANTY GIVES YOU SPECIFIC LEGAL RIGHTS. YOU MAY ALSO HAVE OTHER RIGHTS THAT VARY FROM STATE TO STATE.

If You Need Service

Keep your receipt, delivery slip, or some other appropriate payment record to establish the warranty period should service be required. If service is performed, it is in your best interest to obtain and keep all receipts. Service under this warranty must be obtained by contacting Electrolux at the addresses or phone numbers below.

This warranty only applies in the USA and Canada. In the USA, your appliance is warranted by Electrolux Major Appliances North America, a division of Electrolux Home Products, Inc. In Canada, your appliance is warranted by Electrolux Canada Corp. Electrolux authorizes no person to change or add to any obligations under this warranty. Obligations for service and parts under this warranty must be performed by Electrolux or an authorized service company. Product features or specifications as described or illustrated are subject to change without notice.

USA
1-877-435-3827

Electrolux Major Appliances NA
10200 David Taylor Drive
Charlotte, NC 28262
ElectroluxAppliances.com



Electrolux

Canada
1.800.265.8352

Electrolux Canada Corp.
5855 Terry Fox Way
Mississauga, Ontario, Canada
L5V 3E4
ElectroluxAppliances.ca

FRIGIDAIRE®

welcome *home*

A22383503 A (EN) Aug 2021

Our home is your home. Visit us if you need help with any of these things:



owner support



accessories



service



registration

(See your registration card for more information.)

Frigidaire.com
1-800-374-4432

Frigidaire.ca
1-800-265-8352