



# Side by Side REFRIGERATORS

## **SAFETY INFORMATION ..... 3**

### **USING THE REFRIGERATOR**

Controls .....	6
TurboCool™ .....	8
Water Filter - XWFE .....	9
Shelves and Bins .....	10
Refrigerator Doors .....	12
Crispers and Pans .....	13
Automatic Icemaker .....	14
Ice and Water Dispenser .....	16

### **CARE AND CLEANING .....17**

The Outside .....	17
The Inside .....	17
Behind the Refrigerator .....	18
Preparing for Vacation .....	18
Preparing to Move .....	18
Replacing the LED Lighting .....	19

### **INSTALLATION INSTRUCTIONS**

Preparing to Install the Refrigerator .....	20
Moving the Refrigerator .....	21
Installing the Refrigerator .....	25
Installing the Water Line .....	29

### **TROUBLESHOOTING TIPS**

Normal Operating Conditions .....	32
Troubleshooting .....	33

### **LIMITED WARRANTY ..... 36**

### **CONSUMER SUPPORT**

Water Filter Limited Warranty .....	37
Performance Data Sheets .....	38
Appliance Communication .....	39
Consumer Support .....	40

## **OWNER'S MANUAL & INSTALLATION INSTRUCTIONS**

Models 22, 23, 25, 28

## **ENGLISH/FRANÇAIS/ESPAÑOL**

Write the model and serial numbers here:

Model # \_\_\_\_\_

Serial # \_\_\_\_\_

Find these numbers on a label inside the refrigerator compartment at the top on the right side behind the controls..

## **THANK YOU FOR MAKING GE APPLIANCES A PART OF YOUR HOME.**

---

Whether you grew up with GE Appliances, or this is your first, we're happy to have you in the family.

We take pride in the craftsmanship, innovation and design that goes into every GE Appliances product, and we think you will too. Among other things, registration of your appliance ensures that we can deliver important product information and warranty details when you need them.

Register your GE appliance now online. Helpful websites and phone numbers are available in the Consumer Support section of this Owner's Manual. You may also mail in the pre-printed registration card included in the packing material.



**GE APPLIANCES**

# IMPORTANT SAFETY INFORMATION

## READ ALL INSTRUCTIONS BEFORE USING THE APPLIANCE

**▲ WARNING** To reduce the risk of fire, explosion, electric shock, or injury when using your refrigerator, follow these basic safety precautions:

- This refrigerator must be properly installed and located in accordance with the Installation Instructions before it is used.
- Unplug the refrigerator before making repairs or cleaning.
 

**NOTE:** Power to the refrigerator cannot be disconnected by any setting on the control panel.

**NOTE:** Repairs must be performed by a qualified Service Professional.
- Replace all parts and panels before operating.
- Do not use an extension cord.
- Do not store or use gasoline or other flammable vapors and liquids in the vicinity of this or any other appliance.
- Do not store explosive substances such as aerosol cans with a flammable propellant in this appliance.
- To prevent suffocation and entrapment hazards to children, remove the fresh food and freezer doors from any refrigerator before disposing of it or discontinuing its use.
- To avoid serious injury or death, children should not stand on, or play in or with the appliance.
- Children and persons with reduced physical, sensory or mental capabilities or lack of experience and knowledge can use this appliance only if they are supervised or have been given instructions on safe use and understand the hazards involved.
- This appliance is intended to be used in household and similar applications such as: staff kitchen areas in shops, offices and other working environments; farm houses; by clients in hotels, motels, bed & breakfast and other residential environments; catering and similar non-retail applications.
- Connect to potable water supply only. A cold water supply is required for automatic icemaker operation. The water pressure must be between 40 and 120 psi (275-827 kilopascals).
- Do not apply harsh cleaners to the refrigerator. Certain cleaners will damage plastic which may cause parts such as the door or door handles to detach unexpectedly. See the Care and Cleaning section for detailed instructions.

**▲ CAUTION** To reduce the risk of injury when using your refrigerator, follow these basic safety precautions.

- Do not clean glass shelves or covers with warm water when they are cold. Glass shelves and covers may break if exposed to sudden temperature changes or impact, such as bumping or dropping. Tempered glass is designed to shatter into many small pieces if it breaks.
- Keep fingers out of the “pinch point” areas; clearances between the doors and between the doors and cabinet are necessarily small. Be careful closing doors when children are in the area.
- Do not touch the cold surfaces in the freezer compartment when hands are damp or wet, skin may stick to these extremely cold surfaces.
- Do not refreeze frozen foods which have thawed completely.
- In refrigerators with automatic icemakers, avoid contact with the moving parts of the ejector mechanism, or with the heating element that releases the cubes. Do not place fingers or hands on the automatic ice making mechanism while the refrigerator is plugged in.
- Use a sturdy glass when dispensing ice (on models with ice dispenser)

## INSTALLATION

**▲ WARNING** FIRE AND EXPLOSION HAZARD

Keep flammable materials and vapors away from refrigerator. Failure to do so can result in fire, explosion, or death.

# READ AND SAVE THESE INSTRUCTIONS

# IMPORTANT SAFETY INFORMATION

## READ ALL INSTRUCTIONS BEFORE USING THE APPLIANCE

### CONNECTING ELECTRICITY

#### **⚠ WARNING** **ELECTRICAL SHOCK HAZARD**

Plug into a grounded 3-prong outlet  
 Do not remove the ground prong  
 Do not use an adapter  
 Do not use an extension cord.  
 Failure to follow these instructions can result in death, fire, or electrical shock.

**Do not, under any circumstances, cut or remove the third (ground) prong from the power cord. For personal safety, this appliance must be properly grounded.**

The power cord of this appliance is equipped with a 3-prong (grounding) plug which mates with a standard 3-prong (grounding) wall outlet to minimize the possibility of electric shock hazard from this appliance.

Have the wall outlet and circuit checked by a qualified electrician to make sure the outlet is properly grounded.

Where a standard 2-prong wall outlet is encountered, it is your personal responsibility and obligation to have it replaced with a properly grounded 3-prong wall outlet. Do not use an adapter.

The refrigerator should always be plugged into its own individual electrical outlet which has a voltage rating that matches the rating plate.

A 115 Volt AC, 60 Hz, 15- or 20-amp fused, grounded electrical supply is required. This provides the best performance and also prevents overloading house wiring circuits which could cause a fire hazard from overheated wires.

Never unplug your refrigerator by pulling on the power cord. Always grip plug firmly and pull straight out from the outlet.

Immediately discontinue use of a damaged supply cord. If the supply cord is damaged, it must be replaced by a qualified service professional with an authorized service part from the manufacturer.

When moving the refrigerator away from the wall, be careful not to roll over or damage the power cord.

### PROPER DISPOSAL OF YOUR OLD REFRIGERATOR

#### **⚠ WARNING** **SUFFOCATION AND ENTRAPMENT HAZARD**

Failure to follow these disposal instructions can result in death or serious injury

**IMPORTANT:** Child entrapment and suffocation are not problems of the past. Junked or abandoned refrigerators are still dangerous even if they will sit for "just a few days." If you are getting rid of your old refrigerator, please follow the instructions below to help prevent accidents.

#### **Before You Throw Away Your Old Appliance**

- Take off the refrigerator and freezer doors.
- Leave the shelves in place so that children may not easily climb inside.

#### **⚠ WARNING** **REFRIGERANT AND FOAM DISPOSAL:**

Dispose of or recycle appliance in accordance with Federal and Local Regulations. Flammable refrigerant and insulation material used requires special disposal procedures. Contact your local authorities for the environmentally safe disposal or recycling of your appliance.

## READ AND SAVE THESE INSTRUCTIONS

# IMPORTANT SAFETY INFORMATION

## READ ALL INSTRUCTIONS BEFORE USING THE APPLIANCE

Check the rating label for refrigerant type. If R600a, follow the warning instructions below.

### **⚠ WARNING**



### **FIRE OR EXPLOSION HAZARD Flammable Refrigerant**

This appliance contains isobutane refrigerant, also known as R600a, a natural gas with high environmental compatibility. However, it is also combustible. Adhere to the warnings below to reduce the risk of injury or property damage.

1. When handling, installing and operating the appliance, care should be taken to avoid damage to the refrigerant tubing.
2. Service shall only be performed by authorized service personnel. Use only manufacturer-authorized service parts.
3. Dispose of refrigerator in accordance with the Federal and Local Regulations. The flammable refrigerant and insulation material used in this product require special disposal procedures. Contact

your local authorities for the environmentally safe disposal of your refrigerator.

4. Keep ventilation openings in the appliance enclosures or in the built-in structure clear of obstruction.
5. To remove frost, scrape with a plastic or wood spatula or scraper. Do not use an ice pick or a metal or sharp-edged instrument as it may puncture the freezer liner and then the flammable refrigerant tubing behind it.
6. Do not use electrical appliances inside the food storage compartment of the appliance.
7. Do not use any electrical device to defrost your freezer.

## READ AND SAVE THESE INSTRUCTIONS

## Controls (on some models)

Not all features are on all models. Your controls may be similar to the following:

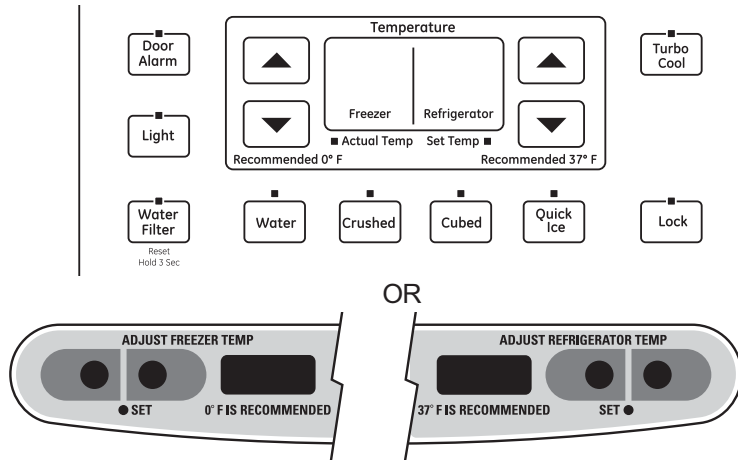

The temperature controls are preset in the factory at 37°F (2.8°C) for the refrigerator compartment and 0°F (-17.8°C) for the freezer compartment. Allow 24 hours for the temperature to stabilize to the preset recommended settings.

The temperature controls can display both the SET temperature as well as the actual temperature in the refrigerator and freezer. The actual temperature may vary slightly from the SET temperature based on usage and operating environment.

- On some models, setting both controls to the warmest setting until the display flashes (off) will stop cooling in both the freezer and refrigerator compartments.
- On other models, setting either control to the warmest setting until the display flashes (off) will stop the cooling to the freezer and refrigerator.
- **NOTE:** Turning the refrigerator off via the controls on the touch panel does not shut off electrical power to the refrigerator.

**NOTE:** The refrigerator is shipped with protective film-covering the temperature controls. If this film was not removed during installation, remove it now.

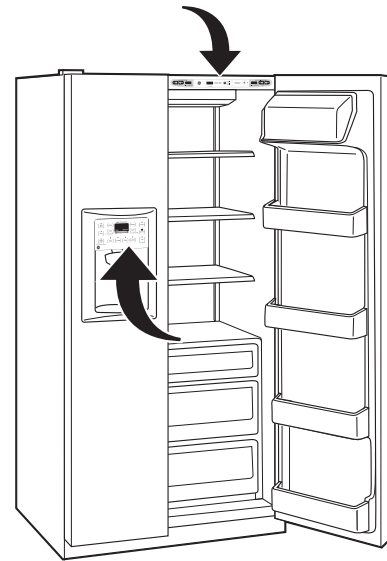

## Performance Air Flow System

The Performance Air-Flow System is designed to maximize temperature control in the refrigerator and freezer compartments. This unique special feature consists of the Air Tower along the back wall of the refrigerator and the Air Tunnel on the bottom portion of the freezer rear wall.

Placing food in front of the louvers on these components will not affect performance. Although the Air Tower and the Air Tunnel can be removed, doing so will affect temperature performance. (For removal instructions, on-line, 24 hours a day, contact us at **GEAppliances.com** or call 800.GE.CARES. In Canada, contact us at **geappliances.ca** or call 1.800.561.3344.)

# Controls (on some models)

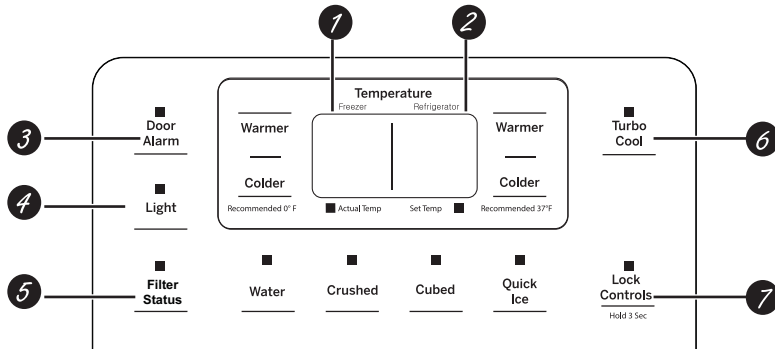

The temperature controls are preset in the factory at **37°F (2.8°C)** for the refrigerator compartment and **0°F (-17.8°C)** for the freezer compartment. Allow 24 hours for the temperature to stabilize to the preset recommended settings.

The temperature controls can display both the SET temperature as well as the actual temperature in the refrigerator and freezer. The actual temperature may vary slightly from the SET temperature based on usage and operating environment.

- 1 Freezer Compartment Temperature Control**  
Adjust freezer compartment temperature. The freezer temperature is preset in the factory at **0°F (-17.8°C)**. Allow 24 hours for temperature to stabilize to the preset recommended setting.
- 2 Refrigerator Compartment Temperature Control**  
Adjust Refrigerator compartment temperature. The refrigerator temperature is preset in the factory at **37°F (2.8°C)**. Allow 24 hours for temperature to stabilize to the preset recommended setting.
- 3 Door Alarm (on some models)**  
To set the alarm, press this pad until the indicator light comes on. This alarm will sound if either door is open for more than 3 minutes. The light goes out and the beeping stops when you close the door.
- 4 LED dispenser Light**  
Press the **Light** pad to turn your dispenser light on and off.
- 5 Filter Status**  
Press the **Filter Status** pad to display the water filter's life percentage (%).

- 6 TurboCool™ (on some models)**  
TurboCool™ rapidly cools the refrigerator compartment in order to more quickly cool foods. Use TurboCool™ when adding a large amount of food to the refrigerator compartment, putting away foods after they have been sitting out at room temperature or when putting away warm leftovers. It can also be used if the refrigerator has been without power for an extended period.  
**NOTES:** The refrigerator temperature cannot be changed during TurboCool™.  
The freezer temperature is not affected during TurboCool™.  
When opening the refrigerator door during TurboCool™, the fans will continue to run if they have cycled on.
- 7 Lock Controls**  
Press and hold the **Lock Controls** pad for 3 seconds to lock out ice and water dispenser and all other controls. Press and hold to unlock the controls.

## COMPRESSOR

To turn off compressor:

1. Raise the freezer temperature above the highest setting by pressing the **Freezer warmer** pad until the display starts blinking.
2. Raise the **Fresh Food** temperature above the highest setting until you see OFF.

To turn on the compressor:

1. Press **Fresh Food** or **Freezer colder** pad.

**NOTE:** Compartment lights and the user interface display will stay on.

## TurboCool™ (on some models.)

### How it Works

**TurboCool™** rapidly cools the refrigerator compartment in order to more quickly cool foods. Use **TurboCool™** when adding a large amount of food to the refrigerator compartment, putting away foods after they have been sitting out at room temperature or when putting away warm leftovers. It can also be used if the refrigerator has been without power for an extended period.

Once activated, the compressor will turn on immediately and the fans will cycle on and off at high speed as needed for eight hours. The compressor will continue to run until the refrigerator compartment cools to approximately 34°F (1°C), then it will cycle on and off to maintain this setting. After 8 hours, or if **TurboCool™** is pressed again, the refrigerator compartment will return to the original setting.

### How to Use

Press **TurboCool™**. The **TurboCool™** temperature display will show **Tc** and the LED will be activated.

After **TurboCool™** is complete, the **TurboCool™** indicator light will go out.

**NOTES:** The refrigerator temperature cannot be changed during **TurboCool™**.

The freezer temperature is not affected during **TurboCool™**.

When opening the refrigerator door during **TurboCool™**, the fans will continue to run if they have cycled on.

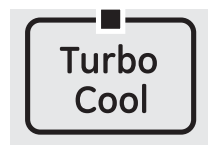



# Water Filter Cartridge - XWFE (On some models)

## Water Filter Cartridge

The water filter cartridge holder is located in the back upper-right corner of the fresh food refrigerator compartment.

Select models use radio frequency identification (RFID) to detect leaks and monitor filter status. The RFID technology is certified by the FCC.

### Contains

FCC ID: ZKJ-294D2018 IC: 10229A-294D2018

“This device complies with part 15 of the FCC Rules. Operation is subject to the following two conditions:

(1) This device may not cause harmful interference, and (2) this device must accept any interference received, including interference that may cause undesired operation.”

“This device complies with Industry Canada licence-exempt RSS standard(s). Operation is subject to the following two conditions: (1) this device may not cause interference, and (2) this device must accept any interference, including interference that may cause undesired operation of the device.”

## When to Replace the Filter

If there is a replacement indicator light for the water filter cartridge on the dispenser, a red light will start blinking to tell you that you need to replace the filter soon. For models that don't have the indicator light, the filter cartridge should be replaced every six months, or earlier if the flow of water to the dispenser or icemaker decreases.

## Removing the Filter

If you are replacing the filter, first remove the previous one by gently grasping the filter and slowly turning it to the left, about a ¼ turn. The filter should automatically release itself when you have rotated it far enough to the left. A small amount of water may drip down.

### CAUTION

If air has been trapped in the system, the filter cartridge may be ejected as it is removed. Use caution when removing.

### WARNING

To reduce the risk associated with choking, do not allow children under 3 years of age to have access to small parts during the installation of this product. The disposable filter cartridge should be replaced every 6 months at the rated capacity, or sooner if a noticeable reduction in flow rate occurs.

For the maximum benefit of your filtration system, GE Appliances recommends the use of GE Appliances-branded filters only. Using GE Appliances-branded filters in GE Appliances and Hotpoint® refrigerators provides optimal performance and reliability. GE Appliances filters meet rigorous industry standards for safety and quality that are important for products that are filtering your water. GE Appliances has not qualified non-GE Appliances-branded filters for use in GE Appliances and Hotpoint refrigerators and there is no assurance that non-GE Appliances-branded filters meet GE Appliances standards for quality, performance and reliability.

If you have questions, or to order additional filter cartridges, visit our website at [gewaterfilters.com](http://gewaterfilters.com) or call GE Appliances Parts and Accessories, 877.959.8688. (Canada 1.800.661.1616 or [GEAppliances.ca/en/products/parts-filters-accessories](http://GEAppliances.ca/en/products/parts-filters-accessories))

## Filter Bypass Plug

To reduce the risk of property damage due to water leakage, you MUST use the filter bypass plug when a replacement filter cartridge is not available. Some models do not come equipped with the filter bypass plug. To obtain a free bypass plug, call 800-GECARES. In Canada, call 800.561.3344. The dispenser and icemaker will not operate without either the filter or bypass plug installed. The bypass plug is installed in the same way as a filter cartridge.

## Installing the Filter Cartridge in a Side by Side Refrigerator

1. Line up the arrow on the filter with the arrow on the filter cartridge holder. Gently push the top of the new filter up inside the holder.
2. Slowly turn the filter to the right until it stops. DO NOT OVERTIGHTEN. As you turn the filter, it will automatically raise itself into position. The filter will move about a ¼ turn or 90 degrees.
3. Run water from the dispenser for 2 gallons (7.6 liters) or approximately 5 minutes to clear the system. Water may spurt out and air bubbles may be visible during this process.
4. Press and hold the RESET WATER FILTER button on the dispenser for 3 seconds. On select models, filter reset will be automatic when a new filter is installed.

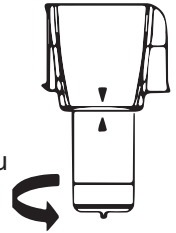

## Application Guidelines/Water Supply

Service Flow	0.5 gpm (1.89 lpm)
Water Supply	Potable Water
Water Pressure	25-120 psi (172-827 kPa)
Water Temperature	33°F-100°F (0.6°C-38°C)
Capacity	170 gallons (643.5 liters)

Sign-up for TEXT REMINDERS by texting REPLACE to 70543.

# Shelves and Bins

Not all features are on all models.

## Refrigerator Door Bins and Freezer Door Tilt-Out Bins

### Large Bins

The larger refrigerator door bins and freezer tilt-out door bins are adjustable.

**To remove:** Lift the front of the bin straight up, then lift up and out.

**To replace or relocate:** Engage the back side of the bin in the molded supports of the door. Then push down on the front of the bin. Bin will lock in place.

### Small Bins

**To remove:** Lift the front of the bin straight up then out.

**To replace:** Position the bin above the rectangular molded supports on the door. Then slide the bin down onto the support to lock it in place.

The snugger helps prevent tipping, spilling or sliding of small items stored on the door shelf. Place a finger on either side of the snugger near the rear and move it back and forth to fit your needs.

**NOTE:** Be careful when placing items in the top bin. Make sure that items do not block or fall into the ice chute.

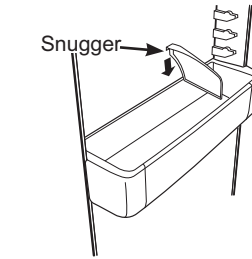

Refrigerator bin

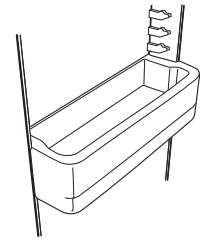

Freezer bin

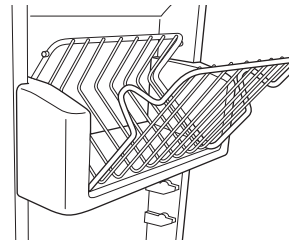

Freezer tilt-out bin

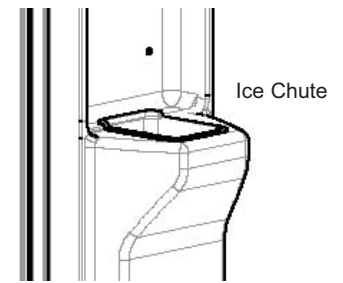

Ice Chute

## Slide-Out Shelf (on some models)

The slide-out shelf allows you to reach items stored behind others. The special edges of the spillproof shelf are designed to help prevent spills from dripping to lower shelves.

### Spillproof Shelf

**To remove:** Slide the shelf out until it reaches the stop, then press down on the tab and slide the shelf straight out.

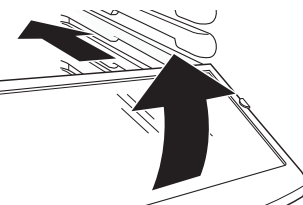
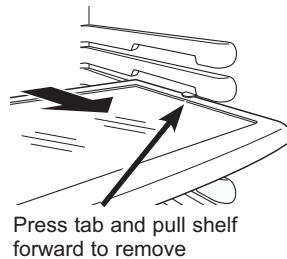

**To replace or relocate:** Line the shelf up with the supports and slide it into place. The shelf can be repositioned when the door is at 90° or more. To reposition the shelf, slide the shelf past the stops and angle downward. Slide shelf down to the desired position, line up with the supports and slide into place. Make sure you push the shelves all the way back in before you close the door.

## Edge-to-Edge Shelf

**To remove:** With door opened at an angle greater than 90°, slide the shelf out until it reaches the stop tab. Press down on the tab and slide the shelf out until it reaches the shelf's back trim. While keeping the left side of the shelf in contact with the cabinet, pull the shelf down and forward toward the left to remove.

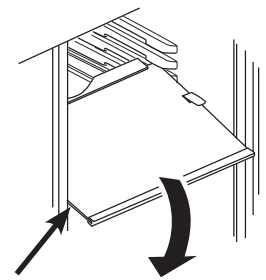
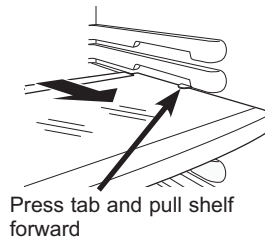

With left side stays against the cabinet as you pull down and to the left to remove

**To replace or relocate:** With door opened at an angle greater than 90°, align the shelf's back trim against the shelf support. Keeping the left side against the cabinet, slowly lift and gently push the shelf back into place. Reposition the shelf past the stop tabs. Make sure you push the shelves all the way back in before you close the door.

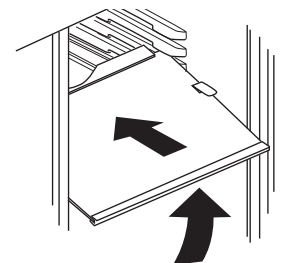

# Shelves and Bins

Not all features are on all models.

## Freezer Baskets (on some models)

**To remove,** slide out to the stop position, lift the front past the stop position, and slide out.

Make sure you push the baskets all the way back in before you close the door.

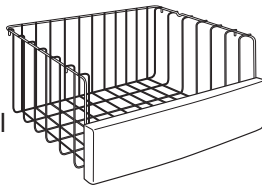

## Freezer Baskets (on some models)

**To remove,** push the basket all the way to the back of the freezer. Lift up until the back pins are disengaged. Lift the entire basket up and pull out.

Make sure you push the baskets all the way back in before you close the door.

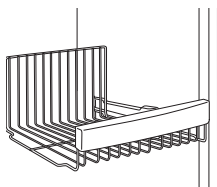

## QuickSpace™ Shelf (on some models)

This shelf splits in half and slides under itself for storage of tall items on the shelf below.

This shelf can be removed and replaced or relocated just like Slide-Out Spillproof Shelves.

On some models, this shelf can not be used in the lowest position.

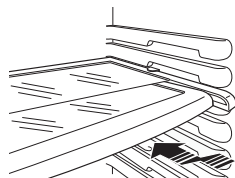

## Slide-Out Freezer Shelves

**To remove,** slide out to the stop position, lift the front past the stop position, and slide out from rib.

Make sure you push the shelves all the way back in before you close the door.

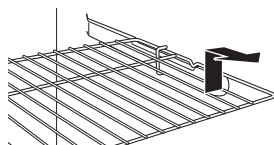

## Fixed Freezer Shelves

**To remove,** lift the shelf up at the left side and then bring the shelf out.

### NOTE FOR DISPENSER

**MODELS:** In order to take full advantage of the tilt-out ice bin (on some models), only store items on the shelf below the ice bin that are no taller than the lowest point on the bin.

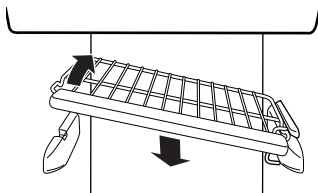

## Door Wine/Beverage Rack (on some models)

This rack holds up to 5 cans, one bottle of wine or one 2-liter bottle of soda.

The rack hangs from the sides of the dairy bin.

### To remove:

1. Empty the wine/beverage rack.
2. Holding the bottom of the dairy bin, lift the front straight up, then lift up and out.
3. To detach the rack from the dairy bin, pull the rack's side wires out of the holes on each side of the dairy bin.

### To replace:

1. Reattach the rack to the sides of the bin.
2. Engage the back side of the bin in the molded supports on the door. Then push down on the front of the bin. The bin will lock into place.

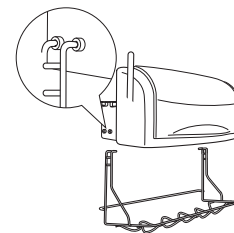
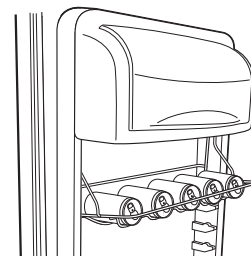

## ShelfSaver™ Rack (on some models)

Use this rack to store beverage cans for easy access.

It can also hold a 9" x 13" baking dish.

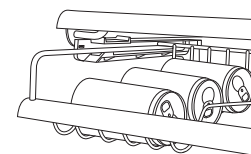

## Door Can Rack (on some models)

This door rack holds up to 9 cans.

**NOTE:** This rack can only be mounted in the top position under the dairy bin.

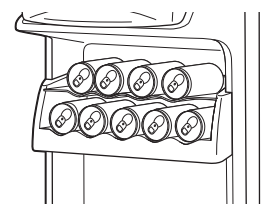

## Removable Beverage Rack (on some models)

The beverage rack is designed to hold a bottle on its side. It can be attached to any slide-out shelf.

### To install:

1. Line up the large part of the slots on the top of the rack with the tabs under the shelf.
2. Then slide the rack back to lock it in place.

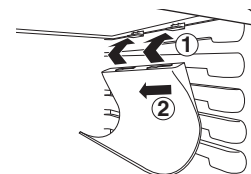
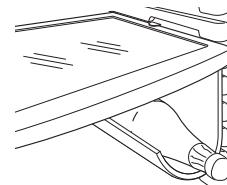

# Refrigerator Doors

## Refrigerator Doors (on some models)

The refrigerator doors may feel different than the ones you are used to. The special door opening/closing feature makes sure the doors close all the way and are securely sealed.

When opening and closing the door you will notice a stop position. If the door is opened past this stop point, the door will remain open to allow you to load and unload food more easily. When the door is only partially open, it will automatically close.

The resistance you feel at the stop position will be reduced as the door is loaded with food.

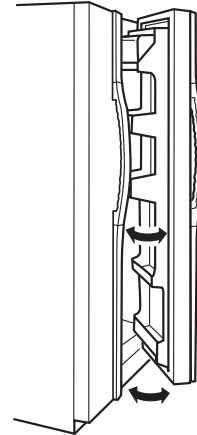

When the door is only partially open, it will automatically close. Beyond this stop the door will stay open.

## Door Alignment

If doors are uneven, adjust the refrigerator door.

To remove the base grille, open the doors, remove the screw at each end of the base grille and then pull the grille straight out.

1. Using a 7/16" socket wrench, turn the door adjusting screw to the right to raise the door; to the left, to lower it. (A nylon plug, imbedded in the threads of the pin, prevents the pin from turning unless a wrench is used.)
2. After one or two turns of the wrench, open and close the refrigerator door and check the alignment at the top of the doors.

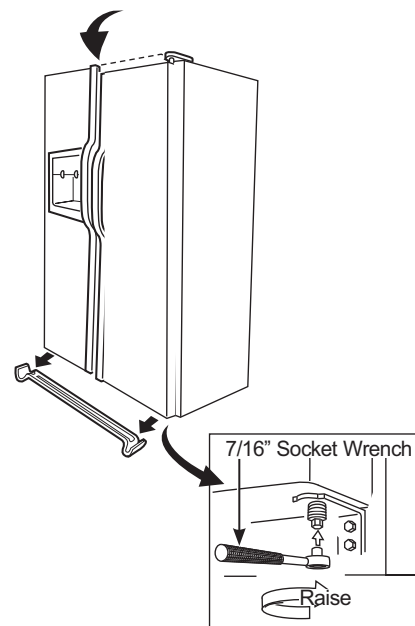

# Crispers and Pans

Not all features are on all models.

## Fruit and Vegetable Crispers

Excess water that may accumulate in the bottom of the drawers should be wiped dry.

On some models, the bottom drawer has full extension slides that allow full access to the drawer.



## Adjustable Humidity Crispers

Slide the control all the way to the HI setting to provide high humidity recommended for most vegetables.

Slide the control all the way to the LO setting to provide lower humidity levels recommended for most fruits.

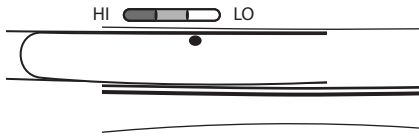

## Crisper Removal

Crispers can easily be removed by pulling the drawer straight out and lifting the drawer up and over the stop location.

If the door prevents you from taking out the drawers, first try to remove the door bins. If this does not offer enough clearance, the refrigerator will need to be rolled forward until the door opens enough to slide the drawers out. In some cases, when you roll the refrigerator out, you will need to move the refrigerator to the left or right as you roll it out.

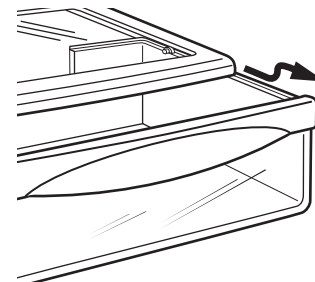

## Convertible Deli Pan (on some models)

The convertible deli pan has its own cold air duct to allow a stream of cold air from the freezer compartment or refrigerator compartment to flow to the pan.

The variable temperature control regulates the air flow from the Climate Keeper.

Set the control to the coldest setting to store fresh meats.

Set the control to cold to convert the pan to normal refrigerator temperature and provide extra vegetable storage space. The cold air duct is turned off. Variable settings between these extremes can be selected.

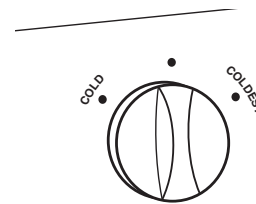

## How to Remove and Replace the Drawer

### To remove:

1. Pull the drawer out to the stop position.
2. Rotate all four swing locks to the unlock position.
3. Lift the front of the drawer up and out.

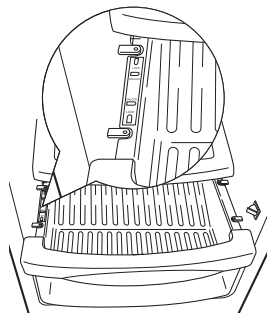

### To replace:

1. Make sure all four swing locks are in the unlock position.
2. Place the sides of the drawer into the drawer supports, making sure the swing locks fit on the drawer slots.
3. Lock all four swing locks by rotating them to the lock position.

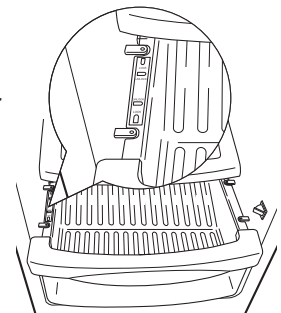



# Automatic Icemaker

Not all features are on all models.

**⚠ WARNING** Connect to potable water supply only.

A cold water supply is required for automatic icemaker operation. The water pressure must be between 40 and 120 psi (275-827 kilopascals).

## Automatic Icemaker

The icemaker will produce seven cubes per cycle—approximately 100–130 cubes in a 24-hour period, depending on freezer compartment temperature, room temperature, number of door openings and other use conditions.

If the refrigerator is operated before the water connection is made to the icemaker, set the power switch in the OFF position.

When the refrigerator has been connected to the water supply, set the power switch to the ON position.

The icemaker will fill with water when it cools to 15°F (–10°C). A newly installed refrigerator may take 12 to 24 hours to begin making ice cubes.

You will hear a buzzing sound each time the icemaker fills with water.

Throw away the first few batches of ice to allow the water line to clear.

Be sure nothing interferes with the sweep of the feeler arm.

When the bin fills to the level of the feeler arm, the icemaker will stop producing ice. It is normal for several cubes to be joined together.

If ice is not used frequently, old ice cubes will become cloudy, taste stale and shrink.

**⚠ CAUTION** Avoid contact with the moving parts of the ejector mechanism, or with the heating element (located on the bottom of the ice maker) that releases the cubes. Do not place fingers or hands on the automatic ice making mechanism while the refrigerator is plugged in.

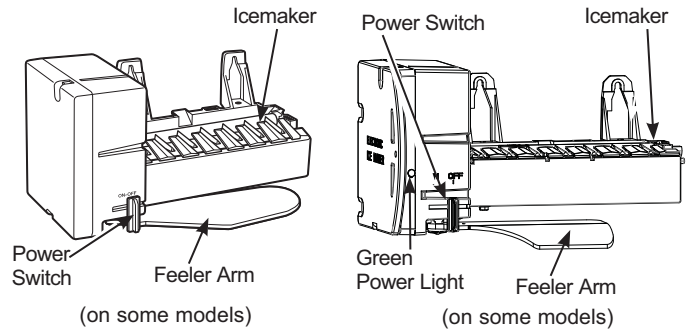

### Special note about dispenser models:

- Some models have a tilt-out ice bin. The bin can be tilted out as shown in the illustrations, and it will hold itself up while you take ice out or turn the icemaker power switch on and off. Be sure to put the bin back in place before closing the door.
- **To restore your ice level from an empty bucket stage, the following steps are recommended:**
  1. 12 hours after the first batch of ice has fallen into the bin, dispense 3 to 4 cubes.
  2. After an additional 6 hours, dispense 3 to 4 cubes again.

These steps will restore your ice level in the shortest amount of time.

### NOTE:

In homes with lower than average water pressure, you may hear the icemaker cycle multiple times when making one batch of ice.

# Automatic Icemaker

## Accessing Ice and Reaching the Power Switch on Dispenser Models

There are two types of ice storage bins on dispenser models. One has a shelf above the bin, the other does not.

### Special note for models with tilt-out ice bin:

- These models have a tilt-out ice bin. The bin can be tilted out as shown in the illustrations, and it will hold itself up while you take ice out or turn the icemaker power switch on and off. Be sure to put the bin back in place before closing the door.

**NOTE:** In order to take full advantage of the tilt-out ice bin, only store items on the shelf below the ice bin that are no taller than the lowest point on the bin.

### Models with tilt out ice bin

To access ice and reach the icemaker power switch:

1. Lift the bin, then pull it forward until the bin stops.

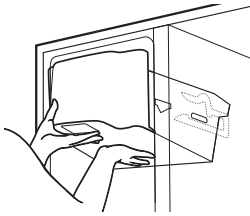

2. Lower the bin to access ice or reach the power switch.

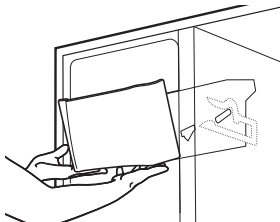

### Models with a shelf above the ice bin

To access ice, pull the bin forward.

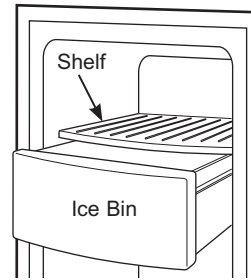

To reach the power switch, pull the shelf straight out. Always be sure to replace the shelf.

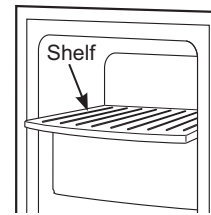

**On some models, to access ice or reach the power switch:**

1. Pull the bin forward until the bin stops.

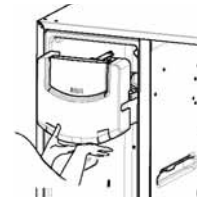

2. Lower the bin to access ice or reach the power switch.

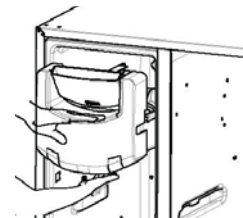

## Removing Ice Bin (dispenser models)

**CAUTION** The ice bin is heavy when full.

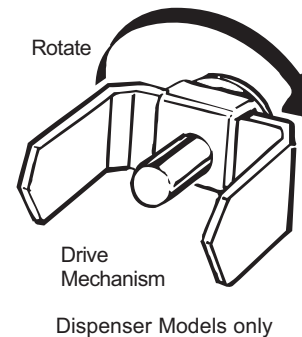

Set the power switch to the **OFF** position before removing the bin.

When replacing the bin, be sure to press it firmly into place. If it does not go all the way back, remove it and rotate the drive mechanism 1/4 turn. Then push the bin back again.



# Ice and Water Dispenser (on some models.)

## Using the Dispenser

Select CUBED ICE , CRUSHED ICE  or WATER .

Press the glass gently against the top of the dispenser cradle.

The spill shelf is not self-draining. To reduce water spotting, the shelf and its grille should be cleaned regularly.

If no water is dispensed when the refrigerator is first installed, there may be air in the water line system. Press the dispenser arm for at least two minutes to remove trapped air from the water line and to fill the water system. To flush out impurities in the water line, throw away the first six glassfuls of water.

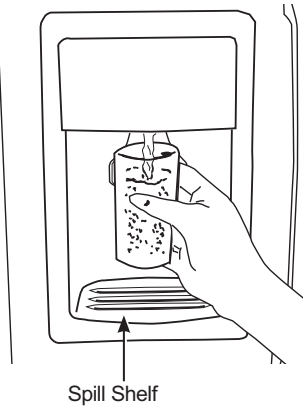

Spill Shelf

### **CAUTION** Laceration Hazard

- Never put fingers or any other object into ice crusher discharge opening. Doing so can result in contacting the ice crushing blades and lead to serious injury or amputation
- Use a sturdy glass when dispensing ice. A delicate glass may break and result in personal injury.

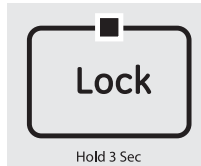

## Locking the Dispenser

Press the LOCK pad for 3 seconds to lock the dispenser and control panel. To unlock, press and hold the pad again for 3 seconds.

## Dispenser Light

This pad turns the light in the dispenser on and off. The light also comes on when the dispenser cradle is pressed. If this light burns out it will need to be replaced; For models with LED light, contact GE service center.



## Quick Ice (on some models)

When you need ice in a hurry, press this pad to speed up ice production. This will increase ice production for the following 48 hours or until you press the pad again.

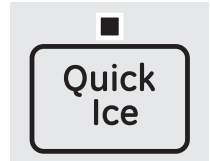

## Door Alarm (on some models)

To set the alarm, press this pad until the indicator light comes on. This alarm will sound if either door is open for more than 3 minutes. The light goes out and the beeping stops when you close the door.



## Water Filter (on some models)

The Filter Indicator Light will turn yellow when the filter is nearing expiration., and red when the filter is expired. After you replace the water filter, press and hold the Reset Filter pad for 3 seconds until the light turns off to reset the timer.



## Filter Status (on some models)

Press the Filter Status pad to display the water filter's life percentage (%).

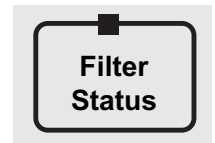

## Important Facts About Your Dispenser

- Do not add ice from trays or bags to the storage drawer. It may not crush or dispense well.
- Avoid overfilling glass with ice and use of narrow glasses. Backed-up ice can jam the chute or cause the door in the chute to freeze shut. If ice is blocking the chute, poke it through with a wooden spoon.
- Beverages and foods should not be quick-chilled in the ice storage drawer. Cans, bottles or food packages in the storage drawer may cause the icemaker or auger to jam.
- To keep dispensed ice from missing the glass, put the glass close to, but not touching, the dispenser opening.
- Some crushed ice may be dispensed even though you selected CUBED ICE. This happens occasionally when a few cubes accidentally get directed to the crusher.
- After crushed ice is dispensed, some water may drip from the chute.
- Sometimes a small mound of snow will form on the door in the ice chute. This condition is normal and usually occurs when you have dispensed crushed ice repeatedly. The snow will eventually evaporate.



# Care and Cleaning

## Cleaning the Outside

The dispenser drip area, (on some models) beneath the grille, should be wiped dry. Water left in this area may leave deposits. Remove the deposits by adding undiluted vinegar to the well. Soak until the deposits disappear or become loose enough to rinse away.

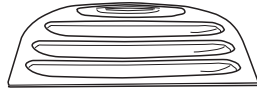

The dispenser cradle (on some models). Before cleaning, lock the dispenser by pressing and holding the **LOCK** pad for 3 seconds. Clean with warm water and baking soda solution—about a tablespoon (15 ml) of baking soda to a quart (1 l) of water. Rinse thoroughly and wipe dry.

## FINGERPRINT RESISTANT STAINLESS STEEL\*, BLACK STAINLESS, SLATE, DARK SLATE, PAINTED - Outside surfaces, door handles, and trim

**⚠ DO NOT use Stainless Steel cleaners on the door surfaces. ⚠**

**IMPORTANT:** The use of incorrect products may damage the outer finish of Fingerprint Resistant Stainless and Black Stainless models. Please follow these instructions and use only the appropriate items below to clean your appliance surfaces.

- Clean interior/exterior surfaces with warm water, mild soap or detergent, and a soft or microfiber cloth to avoid damage.
- Wipe the appliance surface dry with a soft clean cloth or microfiber towel to avoid streaking or water spotting.

DO USE	DO NOT USE								
Soft, clean cloth or sponge Microfiber cloth	Abrasive cloths, paper towels, scrubbing sponges (with or without soap), scouring or steel wool pads								
Mild detergent mixed with warm water	<table border="0"> <tr> <td>Abrasive powders, liquids, or sprays</td> <td>Oven cleaners</td> </tr> <tr> <td>Window sprays, ammonia, or bleach</td> <td>Alkaline cleaners</td> </tr> <tr> <td>Citrus or plant oil-based cleaners</td> <td>Stainless steel cleaners</td> </tr> <tr> <td>Acidic or vinegar-based cleaners</td> <td></td> </tr> </table>	Abrasive powders, liquids, or sprays	Oven cleaners	Window sprays, ammonia, or bleach	Alkaline cleaners	Citrus or plant oil-based cleaners	Stainless steel cleaners	Acidic or vinegar-based cleaners	
Abrasive powders, liquids, or sprays	Oven cleaners								
Window sprays, ammonia, or bleach	Alkaline cleaners								
Citrus or plant oil-based cleaners	Stainless steel cleaners								
Acidic or vinegar-based cleaners									

\*Easily wipe away smudges and fingerprints.

## STAINLESS STEEL - Outside surfaces, door handles, and trim

**NOTE: DO NOT** allow stainless steel cleaner to come in contact with any plastic parts such as trim pieces, handle hardware and liners. If unintentional contact of cleaners with plastic parts does occur, clean plastic part with a sponge and mild detergent mixed with warm water.

DO USE	DO NOT USE
Soft, clean cloth or sponge	Abrasive cloths, scrubbing sponges (with or without soap), scouring or steel wool pads
Mild detergent mixed with warm water Approved stainless steel cleaners; Visit the GE Appliances parts store for approved stainless steel cleaners: <b>GEApplianceparts.com</b> or call <b>877.959.8688</b> Cleaners with oxalic acid such as Bar Keepers Friend Soft Cleanser™ can be used to remove surface rust, tarnish and small blemishes on stainless steel surfaces only.	Abrasive powders or sprays Window Sprays or Ammonia Citrus or plant oil-based cleaners Acidic or vinegar-based cleaners Oven cleaners Cleaners containing acetone (propanone) Any cleaner with <b>WARNING</b> about plastic contact

## Cleaning the Inside

To help prevent odors, leave an open box of baking soda in the fresh food and freezer compartments.

**Unplug the refrigerator before cleaning.** If this is not practical, wring excess moisture out of sponge or cloth when cleaning around switches, lights or controls.

Use warm water and baking soda solution— about a tablespoon (15 ml) of baking soda to a quart (1 liter) of water. This both cleans and neutralizes odors. Rinse and wipe dry.

**Use of any cleaning solution other than that which is recommended, especially those that contain petroleum distillates, can crack or damage the interior of the refrigerator.**

**⚠ CAUTION** Do not clean glass shelves or covers with warm water when they are cold. Glass shelves and covers may break if exposed to sudden temperature changes or impact such as bumping or dropping. Tempered glass is designed to shatter into many small pieces if it breaks.

Do not wash any plastic refrigerator parts in the dishwasher.

The chill/thaw tray is dishwasher safe.

# Care and Cleaning

---

## Behind the Refrigerator

Be careful when moving the refrigerator away from the wall. All types of floor coverings can be damaged, particularly cushioned coverings and those with embossed surfaces.

Pull the refrigerator straight out and return it to position by pushing it straight in. Moving the refrigerator in a side direction may result in damage to the floor covering or refrigerator.

When pushing the refrigerator back, make sure you don't roll over the power cord or icemaker supply line (on some models).

---

## Preparing for Vacation

For long vacations or absences, remove food and unplug the refrigerator. Clean the interior with a baking soda solution of one tablespoon (15 ml) of baking soda to one quart (1 liter) of water. Leave the doors open.

Set the icemaker power switch to the OFF position and shut off the water supply to the refrigerator.

If the temperature can drop below freezing, have a qualified servicer drain the water supply system (on some models) to prevent serious property damage due to flooding.

---

## Preparing to Move

Secure all loose items such as shelves and drawers by taping them securely in place to prevent damage.

When using a hand truck to move the refrigerator, do not rest the front or back of the refrigerator against the hand truck. This could damage the refrigerator. Handle only from the sides of the refrigerator.

Be sure the refrigerator stays in an upright position during moving.

# Care and Cleaning

## Freezer Compartment

1. Unplug the refrigerator.
2. Remove the shelf just above the light shield. (The shelf will be easier to remove if it is emptied first.) Remove the screw at the top of the light shield.
3. To remove the light shield, press in on the sides, and lift up and out.
4. Replace the bulb with an appliance bulb of the same or lower wattage, and reinstall the light shield. When reinstalling the light shield, make sure the top tabs snap securely into place. Replace the screw.
5. Reinstall the shelf and plug the refrigerator back in.

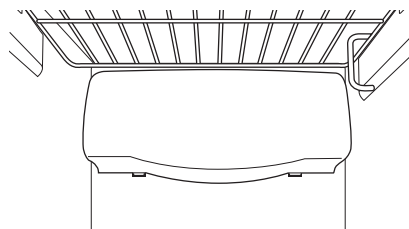

## Dispenser (on some models)

1. Unplug the refrigerator.
2. The bulb is located on the dispenser under the control panel. Remove the light bulb by turning it counterclockwise.
3. Replace the bulb with a bulb of the same size and wattage.
4. Plug the refrigerator back in.

## Replacing the lights on models with LED lighting (on some models)

Setting the controls to **OFF** does not remove power to the light circuit. Not all features are on all models.

### Refrigerator Compartment

There is an LED lighting display in the top and sides of the fresh food compartment and in the rear and side of the freezer compartment on some models.

If this assembly needs to be replaced, call GE Appliances Service at 1.800.432.2737 in the United States or 1.800.561.3344 in Canada.

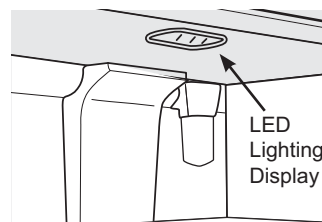

# Installation Instructions

Refrigerator Models 22, 23,  
25, 28

Questions? Call 800.GE.CARES (800.432.2737) or visit our Website at: [GEAppliances.com](http://GEAppliances.com)  
In Canada, call 1.800.561.3344 or visit our Website at: [GEAppliances.ca](http://GEAppliances.ca)

## BEFORE YOU BEGIN

Read these instructions completely and carefully.

- **IMPORTANT** — Save these instructions for local inspector's use
- **IMPORTANT** — Observe all governing codes and ordinances.
- **Note to Installer** – Be sure to leave these instructions with the Consumer.
- **Note to Consumer** – Keep these instructions for future reference.
- **Skill level** – Installation of this appliance requires basic mechanical skills.
- **Completion time** – Refrigerator Installation  
30 minutes  
Water Line Installation  
30 minutes
- Proper installation is the responsibility of the installer.
- Product failure due to improper installation is not covered under the Warranty.

If the refrigerator has already been installed, remove the base grille (see Step 2 in Moving the Refrigerator), then skip to Step 5 in Installing the Refrigerator.

## PREPARATION

### WATER SUPPLY TO THE ICEMAKER (on some models)

If the refrigerator has an icemaker, it will have to be connected to a cold water line. A GE Appliances water supply kit is available at extra cost from your dealer, by visiting our Website at [GEAppliances.com](http://GEAppliances.com) (in Canada, at [geappliances.ca](http://geappliances.ca)), or from Parts and Accessories, 877.959.8688. (in Canada 1.800.661.1616).

## TOOLS YOU WILL NEED

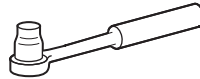

3/8" and 5/16" Socket

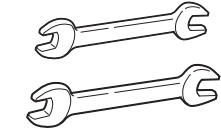
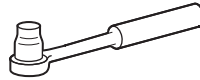

1/2" and 7/16" Wrench

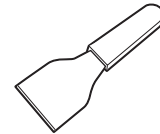

Plastic Putty Knife

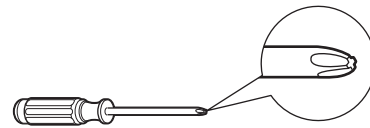

Phillips Head Screwdriver

# Installation Instructions

## MOVING THE REFRIGERATOR

### **⚠ CAUTION** Lifting Hazard.

Single person lift can cause injury. Use assistance when handling, moving or lifting the refrigerator doors. **NOTE:** When moving door, to prevent damage to door and electronics carefully place the door in a proper location.

### **⚠ WARNING**

To reduce the risk of electric shock or injury during installation, you must first unplug the refrigerator before proceeding. Failure to follow these instructions can result in electrical shock.

### **1** LOADING THE REFRIGERATOR ONTO A HAND TRUCK

Leave all tape and door pads on doors until the refrigerator is in its final location.

To move the refrigerator, use a padded hand truck. Center the refrigerator on the hand truck and secure the strap around the refrigerator.

**DO NOT OVERTIGHTEN THE STRAP.**

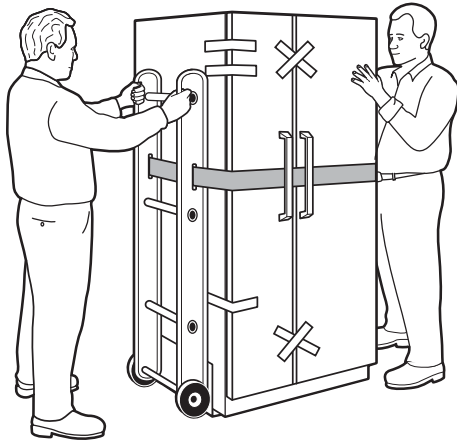

### **2** REMOVE THE BASE GRILLE

Remove the grille by removing the two Phillips head screws.

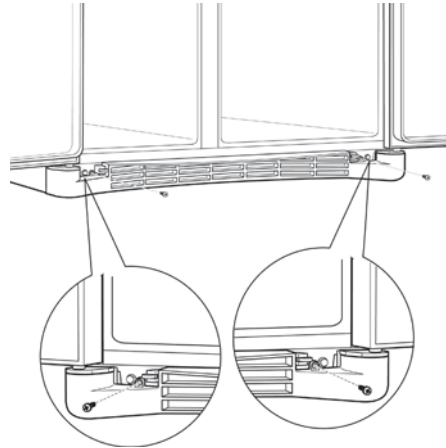

If the refrigerator must go through any entrance that is less than 38" wide, the doors must be removed. Proceed to Step 3.

**DO NOT** remove the handles.

If all entrances are more than 38" wide, skip to Installing the Refrigerator.

### **3** DISCONNECT THE WATER COUPLING (on some models)

If the refrigerator has a water dispenser, there is a water line from the cabinet into the bottom hinge on the freezer door that must be disconnected.

To disconnect, push in on the white collar of the coupling and pull out the tubing.

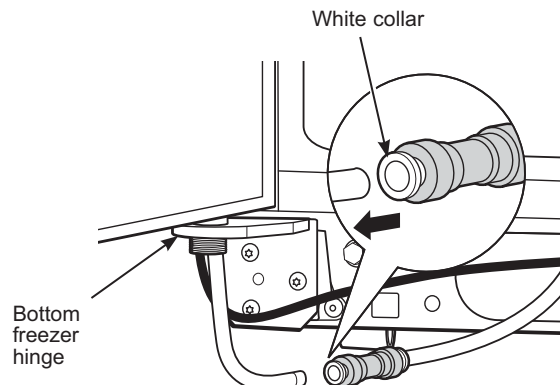

# Installation Instructions

## MOVING THE REFRIGERATOR (Cont.)

### 4 DISCONNECT THE POWER COUPLING (on some models)

If the refrigerator has a water dispenser, there is a power line (harness) from the cabinet into the bottom hinge on the freezer door that must be disconnected.

To disconnect, pull apart at the coupling.

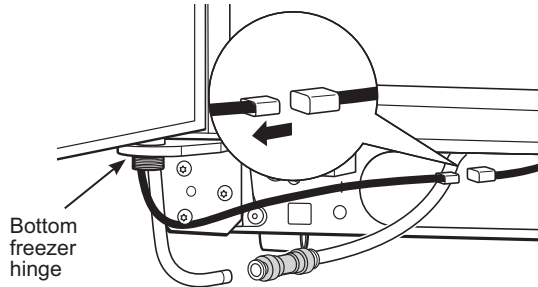

### 6 CLOSE THE FREEZER AND REFRIGERATOR DOORS

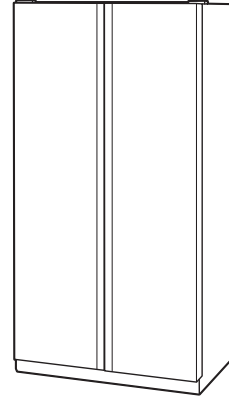

### 5 DISCONNECT THE ELECTRICAL CONNECTORS (on some models)

If the refrigerator has a refreshment center, there are electrical connectors (harnesses) from the cabinet into the bottom hinge on the refrigerator door that must be disconnected.

To disconnect, pull apart each connector.

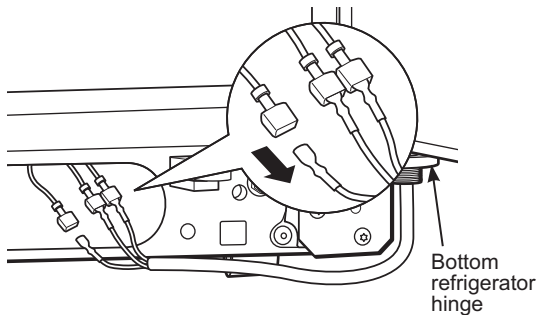

# Installation Instructions

## MOVING THE REFRIGERATOR (Cont.)

### 7 REMOVE THE FREEZER DOOR

**⚠ WARNING** Follow all steps for removing and reinstalling the door. Failure to follow these instructions, leaving off parts, or overtightening screws, can lead to the door falling off and result in injury and property damage.

- A** Remove the freezer door top hinge cover (if equipped) by either squeezing it and pulling it up or by prying it off with a plastic putty knife.

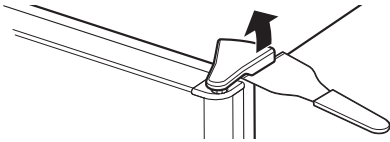

- B** Remove the two 5/16" hex head screws, then lift the hinge straight up to free the hinge pin.

5/16" Hex Head

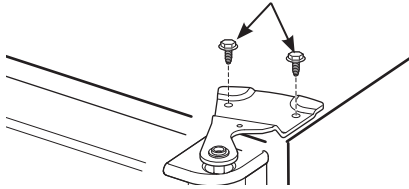

- C** Open the freezer door to 90°.

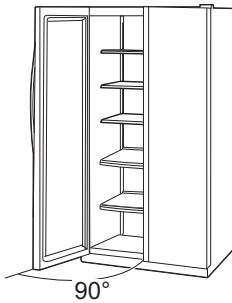

- D** As one person slowly lifts the freezer door up and off the bottom hinge, the second person should carefully guide the water line and power line (harness) through the bottom hinge.

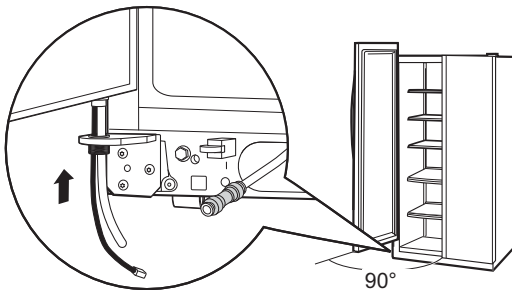

- E** Set the door on a non-scratching surface with the inside up.

### 8 REMOVE THE REFRIGERATOR DOOR

**⚠ WARNING** Follow all steps for removing and reinstalling the door. Failure to follow these instructions, leaving off parts, or overtightening screws, can lead to the door falling off and result in injury and property damage.

- A** Remove the refrigerator door top hinge cover (if equipped) by either squeezing it and pulling it up or by prying it off with a plastic putty knife.

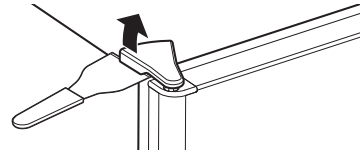

- B** Remove the two 5/16" hex head screws, then lift the hinge straight up to free the hinge pin.

5/16" Hex Head

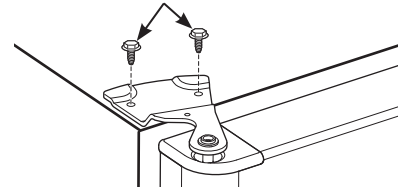

- C** Open the refrigerator door to 90°.

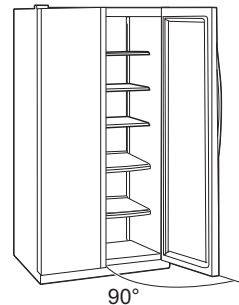

# Installation Instructions

## MOVING THE REFRIGERATOR (Cont.)

### 8 REMOVE THE REFRIGERATOR DOOR (Cont.)

- D** Lift the refrigerator door up and off the bottom hinge.
- If the refrigerator has a refreshment center, one person should slowly lift the door up and off the bottom hinge and the second person should carefully guide the electrical lines (harnesses) through the bottom hinge.

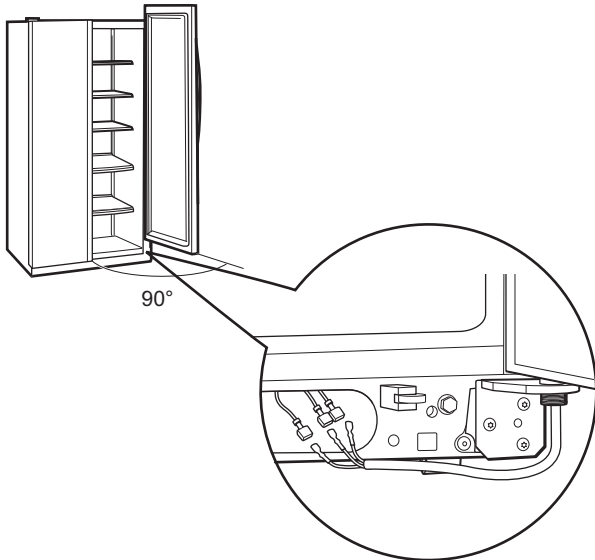

Refreshment Center Models only

- E** Set the door on a non-scratching surface with the inside up.

### 9 REPLACING THE DOORS

**▲WARNING** Follow all steps for removing and reinstalling the door. Failure to follow these instructions, leaving off parts, or overtightening screws, can lead to the door falling off and result in injury and property damage.

To replace the doors, simply reverse steps 3 through 8.

However, please note the following:

- When lowering the doors onto the bottom hinges, make sure the second person carefully guides the tube and harnesses through the holes in the hinges.
- When connecting the water line, make sure you insert the tubing all the way to the mark.

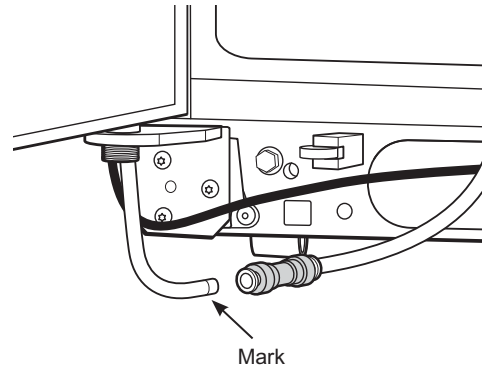

- Do not pinch the tubing and harnesses when placing the doors on the bottom hinges.
- When connecting the power line and the electrical lines (refreshment center models only), be sure that the connectors are seated together fully.



# Installation Instructions

## INSTALLING THE REFRIGERATOR

### REFRIGERATOR LOCATION

- Do not install the refrigerator where the temperature will go below 60°F (16°C) because it will not run often enough to maintain proper temperatures.
- Do not install the refrigerator where the temperature will go above 100°F (37°C) because it will not perform properly.
- Do not install the refrigerator in a location exposed to water (rain, etc.) or direct sunlight.
- Install it on a floor strong enough to support it fully loaded.

### CLEARANCES

Allow the following clearances for ease of installation, proper air circulation and plumbing and electrical connections:

	22'25" CustomStyle™	23' (33" wide), 25', 28'
Sides	1/8" (4 mm)	1/8" (4 mm)
Top	1" (25 mm)	1" (25 mm)
Back	1/2" (13 mm)	1" (25 mm)

### DIMENSIONS AND SPECIFICATIONS

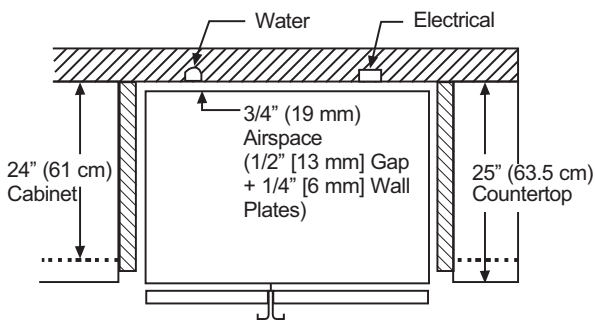

### DIMENSIONS AND SPECIFICATIONS (for 23' CustomStyle™ models)

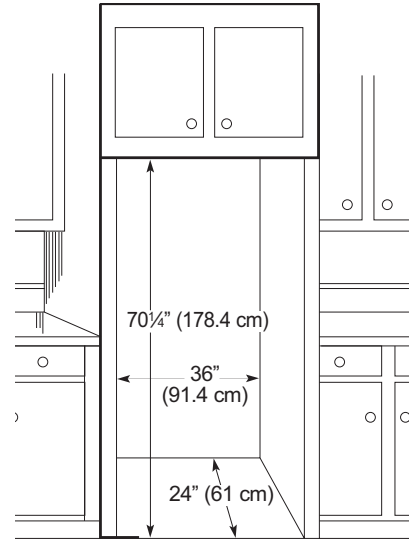

### DIMENSIONS AND SPECIFICATIONS (for 25' CustomStyle™ models)

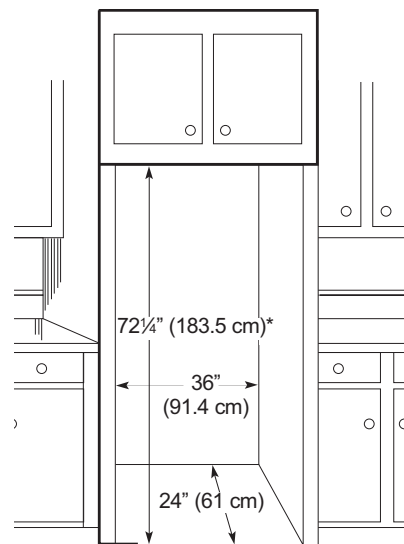

\*72-1/4" (183.5 cm) required for full adjustment of mobility wheels. If cabinets installed above refrigerator have doors that are flush to the top of the opening for the refrigerator, then an additional 1/8" may be required to provide clearance for cabinet doors to open freely.

# Installation Instructions

## INSTALLING THE REFRIGERATOR (Cont.)

### 1 CONNECTING THE REFRIGERATOR TO THE HOUSE WATER LINE

(icemaker and dispenser models)

A cold water supply is required for automatic icemaker and dispenser operation. If there is not a cold water supply, you will need to provide one. See "Installing the Water Line" section.

#### NOTES:

- Before making the connection to the refrigerator, be sure the refrigerator power cord is not plugged into the wall outlet.
- If your refrigerator does not have a water filter, we recommend installing one if your water supply has sand or particles that could clog the screen of the refrigerator's water valve. Install it in the water line near the refrigerator. If using Universal Water Line Refrigerator Tubing Kit, you will need an additional tube (WX08X10002) to connect the filter. Do not cut plastic tube to install filter.

**A** If you are using copper tubing, place a compression nut and ferrule (sleeve) onto the end of the tubing coming from the house cold water supply.

If you are using the universal water line tubing, the nuts are already assembled to the tubing.

**B** If you are using copper tubing, insert the end of the tubing into the refrigerator connection, at the back of the refrigerator, as far as possible. While holding the tubing, tighten the fitting.

If you are using universal water line tubing, insert the molded end of the tubing into the refrigerator connection, at the back of the refrigerator, and tighten the compression nut until it is hand tight. Then tighten one additional turn with a wrench. Overtightening may cause leaks.

#### **▲ WARNING**

**Connect to potable water supply only. A cold water supply is required for automatic icemaker operation. The water pressure must be between 40 and 120 psi (275-827 kilopascals).**

#### **▲ WARNING** **ELECTRIC SHOCK HAZARD**

**Attach tubing clamp using existing hole only. DO NOT drill into the refrigerator.**

**C** Fasten the tubing into the clamp provided to hold it in position. You may need to pry open the clamp.

#### Configuration 1

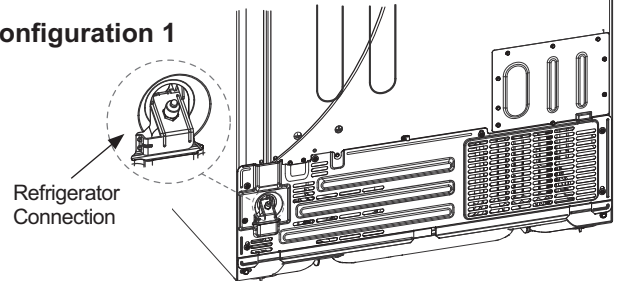

#### Configuration 2

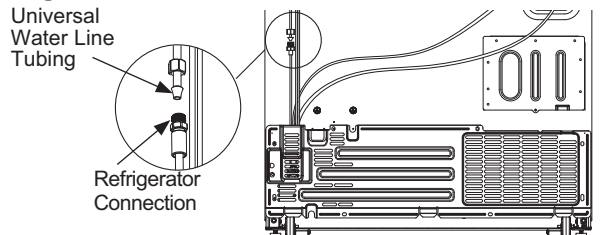

#### Configuration 3

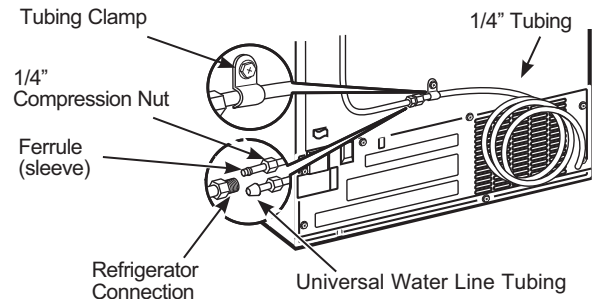

### 2 TURN ON THE WATER SUPPLY

Turn the water on at the shutoff valve (house water supply) and check for any leaks.

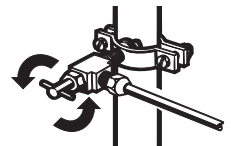

### 3 PLUG IN THE REFRIGERATOR

Before plugging in the refrigerator, make sure the icemaker power switch is set to the OFF position.

See the grounding information attached to the power cord.

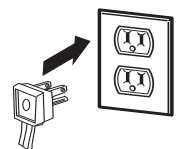

# Installation Instructions

## INSTALLING THE REFRIGERATOR (Cont.)

### 4 PUT THE REFRIGERATOR IN PLACE

Move the refrigerator to its final location.

### 5 LEVEL THE REFRIGERATOR

The refrigerator can be leveled by adjusting the rollers located near the bottom hinges.

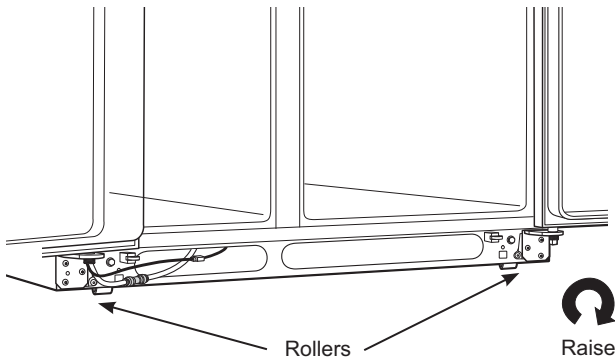

#### Rollers have three purposes:

- Rollers adjust so the door closes easily when opened about halfway. (Raise the front about 5/8" [16 mm] from the floor.)
- Rollers adjust so the refrigerator is firmly positioned on the floor and does not wobble.
- Rollers allow you to move the refrigerator away from the wall for cleaning.

#### To adjust the rollers on 23' (33" wide), 25', 28', models:

- Turn the roller adjusting screws clockwise to raise the refrigerator, counterclockwise to lower it. Use a 3/8" hex socket or wrench, or an adjustable wrench.

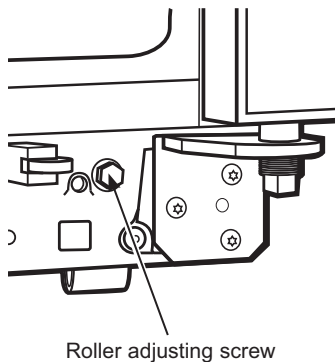

### 5 LEVEL THE REFRIGERATOR (cont.)

To adjust the rollers on 23'/25' CustomStyle™ models:

Turn the front roller adjusting screws **clockwise to raise** the refrigerator, **counterclockwise to lower** it. Use a 3/8" hex wrench with extension, or an adjustable wrench.

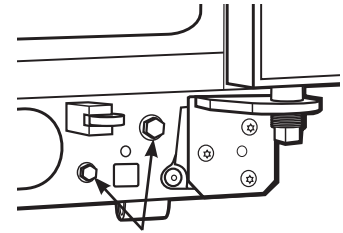

These models also have rear adjustable rollers so you can align the refrigerator with your kitchen cabinets. Use a 3/8" hex wrench with extension to turn the screws for the rear rollers—**clockwise to raise** the refrigerator, **counterclockwise to lower** it.

### 6 LEVEL THE DOORS

**A** Adjust the refrigerator door to make the doors even at the top.

**B** To align:

Using a 7/16" wrench, turn the door adjusting screw to the right to raise the door, to the left to lower it.

#### NOTE:

A nylon plug, imbedded in the threads of the pin, prevents the pin from turning unless a wrench is used.

After one or two turns of the wrench, open and close the refrigerator door and check the alignment at the top of the doors.

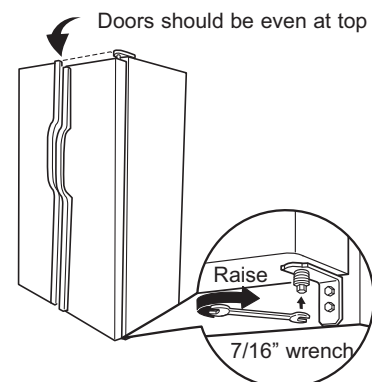

# Installation Instructions

## INSTALLING THE REFRIGERATOR (Cont.)

### 7 REPLACE THE BASE GRILLE

Replace the grille by installing the two Phillips head screws.

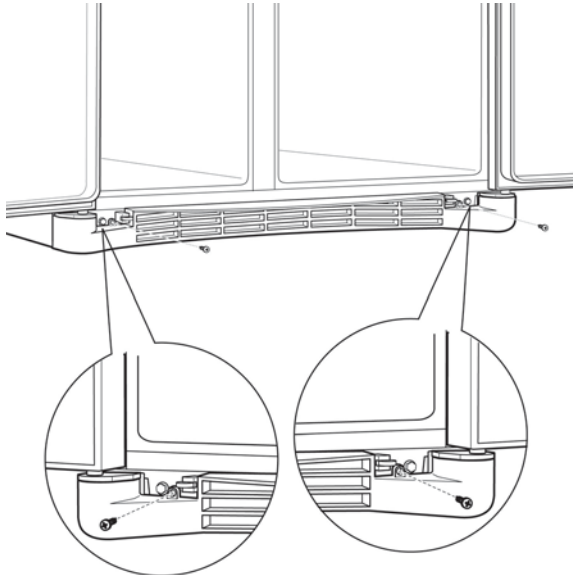

### 9 START THE ICEMAKER

Set the icemaker power switch to the **I (on)** position. The icemaker will not begin to operate until it reaches its operating temperature of 15°F (-9°C) or below. It will then begin operation automatically. It will take 2–3 days to fill the ice bin.

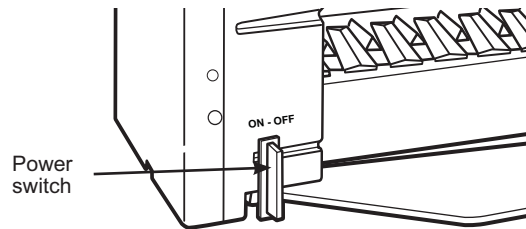

**NOTE:**

In lower water pressure conditions, the water valve may turn on up to 3 times to deliver enough water to the icemaker.

### 8 SET THE CONTROLS

Set the controls to the recommended setting.

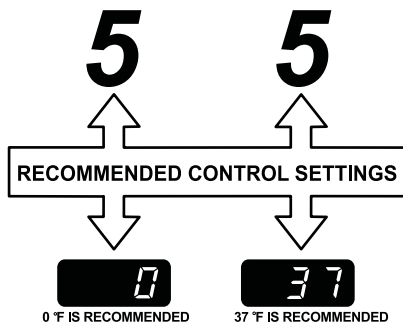

# Installation Instructions

## INSTALLING THE WATER LINE (icemaker & dispenser models)

### BEFORE YOU BEGIN

Recommended copper water supply kits are WX8X2, WX8X3 or WX8X4, depending on the amount of tubing you need. Approved plastic water supply lines are Universal Water Line Refrigerator Tubing (WX08X10006, WX08X10015 and WX08X10025).

When connecting your refrigerator to a Reverse Osmosis Water System, the only approved installation is with a GE Appliances RVKit. For other reverse osmosis water systems, follow the manufacturer's recommendations.

If the water supply to the refrigerator is from a Reverse Osmosis Water Filtration System AND the refrigerator also has a water filter, use the refrigerator's filter bypass plug. To order the bypass plug, see the Water Filter Cartridge section. Using the refrigerator's water filtration cartridge in conjunction with the RO filter can result in hollow ice cubes and slower water flow from the water dispenser.

This water line installation is not warranted by the refrigerator or icemaker manufacturer. Follow these instructions carefully to minimize the risk of expensive water damage.

Water hammer (water banging in the pipes) in house plumbing can cause damage to refrigerator parts and lead to water leakage or flooding. Call a qualified plumber to correct water hammer before installing the water supply line to the refrigerator.

To prevent burns and product damage, do not hook up the water line to the hot water line.

If you use your refrigerator before connecting the water line, make sure the icemaker power switch is in the OFF position.

Do not install the icemaker tubing in areas where temperatures fall below freezing.

When using any electrical device (such as a power drill) during installation, be sure the device is double insulated or grounded in a manner to prevent the hazard of electric shock, or is battery powered.

All installations must be in accordance with local plumbing code requirements.

### WHAT YOU WILL NEED

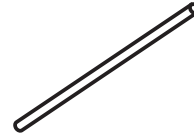

- Copper or Universal Water Line Refrigerator Tubing kit, 1/4" outer diameter to connect the refrigerator to the water supply. If using copper, be sure both ends of the tubing are cut square.

To determine how much tubing you need: measure the distance from the water valve on the back of the refrigerator to the water supply pipe. Be sure there is sufficient extra tubing to allow the refrigerator to move out from the wall after installation.

Universal Water Line Refrigerator Tubing Kits are available in the following lengths:

- 8' (2.8 m) – WX08X10006
- 15' (4.6 m) – WX08X10015
- 25' (7.6 m) – WX08X10025

#### **▲ WARNING**

Connect to potable water supply only.

A cold water supply is required for automatic icemaker operation. The water pressure must be between 40 and 120 psi (275-827 kilopascals).

# Installation Instructions

## INSTALLING THE WATER LINE (Cont.)

### WHAT YOU WILL NEED (Cont.)

**NOTE:** The only GE Appliances approved plastic tubing is that supplied in Universal Water Line Refrigerator Tubing kits. Do not use any other plastic water supply line because the line is under pressure at all times. Certain types of plastic will crack or rupture with age and cause water damage to your home.

- **A GE Appliances water supply kit** (containing tubing, shutoff valve and fittings listed below) is available at extra cost from your dealer or from Parts and Accessories, 877.959.8688 (in Canada 1.800.661.1616).

- **A cold water supply.** The water pressure must be between 20 and 120 p.s.i. (138-827 kPa).

- **Power drill.**

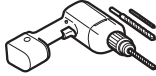

- **1/2" or adjustable wrench.**

- **Straight and Phillips blade screwdriver.**

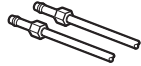

- **Two 1/4" outer diameter compression nuts and 2 ferrules (sleeves)**—to connect the copper tubing to the shutoff valve and the refrigerator water valve. OR

- If you are using a Universal Water Line Refrigerator Tubing kit, the necessary fittings are preassembled to the tubing.

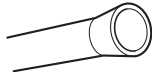

- If your existing copper water line has a flared fitting at the end, you will need an adapter (available at plumbing supply stores) to connect the water line to the refrigerator OR you can cut off the flared fitting with a tube cutter and then use a compression fitting. Do not cut formed end from Universal Water Line Refrigerator tubing.

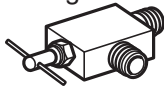

- **Shutoff valve** to connect to the cold water line. The shutoff valve should have a water inlet with a minimum inside diameter of 5/32" at the point of connection to the COLD WATER LINE. Saddle-type shutoff valves are included in many water supply kits. Before purchasing, make sure a saddle-type valve complies with your local plumbing codes.

Install the shutoff valve on the nearest frequently used drinking water line.

### 1 SHUT OFF THE MAIN WATER SUPPLY

Turn on the nearest faucet long enough to clear the line of water.

### 2 CHOOSE THE VALVE LOCATION

Choose a location for the valve that is easily accessible. It is best to connect into the side of a vertical water pipe. When it is necessary to connect into a horizontal water pipe, make the connection to the top or side, rather than at the bottom, to avoid drawing off any sediment from the water pipe.



### 3 DRILL THE HOLE FOR THE VALVE

Drill a 1/4" hole in the water pipe (even if using a self-piercing valve), using a sharp bit. Remove any burrs resulting from drilling the hole in the pipe.

Take care not to allow water to drain into the drill.

Failure to drill a 1/4" hole may result in reduced ice production or smaller cubes.

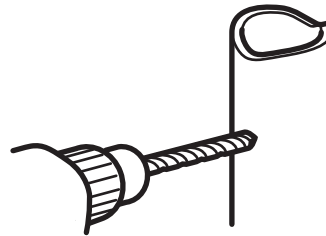



# Installation Instructions

## INSTALLING THE WATER LINE (Cont.)

### 4 FASTEN THE SHUTOFF VALVE

Fasten the shutoff valve to the cold water pipe with the pipe clamp.

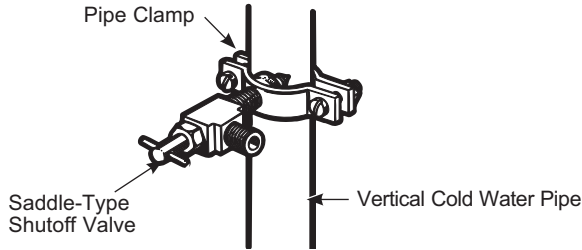

**NOTE:** Commonwealth of Massachusetts Plumbing Codes 248CMR shall be adhered to. Saddle valves are illegal and use is not permitted in Massachusetts. Consult with your licensed plumber.

### 5 TIGHTEN THE PIPE CLAMP

Tighten the clamp screws until the sealing washer begins to swell.

**NOTE:** Do not overtighten or you may crush the tubing..

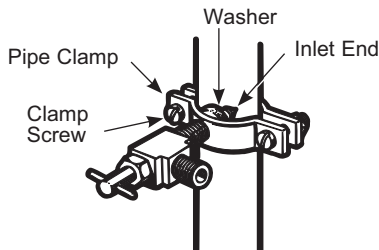

### 6 ROUTE THE TUBING

Route the tubing between the cold water line and the refrigerator.

Route the tubing through a hole drilled in the wall or floor (behind the refrigerator or adjacent base cabinet) as close to the wall as possible.

**NOTE:** Be sure there is sufficient extra tubing to allow the refrigerator to move out from the wall after installation.

### 7 CONNECT THE TUBING TO THE VALVE

Place the compression nut and ferrule (sleeve) for copper tubing onto the end of the tubing and connect it to the shutoff valve.

Make sure the tubing is fully inserted into the valve. Tighten the compression nut securely.

For plastic tubing from a Universal Water Line Refrigerator Tubing kit, insert the molded end of the tubing into the shutoff valve and tighten compression nut until it is hand tight, then tighten one additional turn with a wrench. Overtightening may cause leaks.

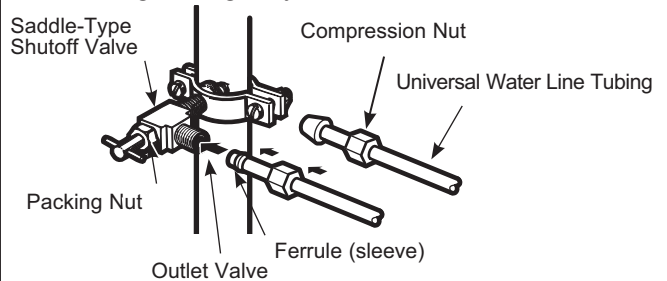

**NOTE:** Commonwealth of Massachusetts Plumbing Codes 248CMR shall be adhered to. Saddle valves are illegal and use is not permitted in Massachusetts. Consult with your licensed plumber.

### 8 FLUSH OUT THE TUBING

Turn the main water supply on and flush out the tubing until the water is clear.

Shut the water off at the water valve after about one quart (1 liter) of water has been flushed through the tubing.



To complete the installation of the refrigerator, go back to Step 1 in Installing the Refrigerator.

## Normal Operating Conditions

Newer refrigerators sound different from older refrigerators.  
Modern refrigerators have more features and use newer technology.

**Do you hear what I hear? These conditions are normal.**

***HUMMM...***

***WHOOSH...***

- The new high efficiency compressor may run faster and longer than your old refrigerator and you may hear a high-pitched hum or pulsating sound while it is operating.
- Sometimes the refrigerator runs for an extended period, especially when the doors are opened frequently. This means that the Frost Guard™ feature is working to prevent freezer burn and improve food preservation.
- You may hear a whooshing sound when the doors close. This is due to pressure equalizing within the refrigerator.

***WHIR!***



- You may hear the fans spinning at high speeds. This happens when the refrigerator is first plugged in, when the doors are opened frequently or when a large amount of food is added to the refrigerator or freezer compartments. The fans are helping to maintain the correct temperatures.
- If either door is open for over 3 minutes, you may hear the fans come on in order to cool the light bulbs.
- The fans change speeds in order to provide optimal cooling and energy savings.

### CLICKS, POPS, CRACKS and SNAPS

- You may hear cracking or popping sounds when the refrigerator is first plugged in. This happens as the refrigerator cools to the correct temperature.
- Electronic dampers click open and closed to provide optimal cooling and energy savings.
- The compressor may cause a clicking or chirping sound when attempting to restart (this could take up to 5 minutes).
- The electronic control board may cause a clicking sound when relays activate to control refrigerator components.
- Expansion and contraction of cooling coils during and after defrost can cause a cracking or popping sound.
- On models with an icemaker, after an icemaking cycle, you may hear the ice cubes dropping into the ice bucket.

### WATER SOUNDS



- The flow of refrigerant through the cooling coils may make a gurgling noise like boiling water.
- Water dropping on the defrost heater can cause a sizzling, popping or buzzing sound during the defrost cycle.
- A water dripping noise may occur during the defrost cycle as ice melts from the evaporator and flows into the drain pan.
- Closing the door may cause a gurgling sound due to pressure equalization.



For additional information on normal icemaker and dispenser operating sounds, see the About the automatic icemaker and About the ice and water dispenser sections.



# Troubleshooting Tips... Before you call for service

Save time and money! Review the charts on the following pages first and you may not need to call for service.

<b>Problem</b>	<b>Possible Causes</b>	<b>What To Do</b>
Filter Status Indicator LED turns amber	Filter reaching expired state	Press the <b>Filter Status</b> pad to show remaining filter life.
Filter Status Indicator LED turns red	Filter expired	Press the <b>Filter Status</b> pad to show remaining filter life. If the display shows 0%, the filter needs to be replaced. When the unit has detected a new filter (a filter has been replaced) the Filter Status LED will flash 3 times and then remain off to indicate the filter was successfully replaced.
LEAK or scrolling "LEAK" on the display Water is disabled Filter Status indicator LED flashing red Buzzer sound	Filter leak detected	Replace filter. Wipe off the filter/surrounding area if there is any water from filter replacement.
"Err" on the display Water is disabled Filter Status indicator LED flashing red Buzzer sound	Filter is not detected No communication with filter	Verify you have the XWFE filter and not the XWF. Verify there are no scratches or filter label damage. Replace filter if filter label shows damage.
Refrigerator beeps when pressing dispenser paddle	Filter is not properly installed Filter water leak	Replace filter or make sure the water filter is properly installed (see water filter section).
Refrigerator does not operate	Refrigerator in defrost cycle.	Wait about 30 minutes for defrost cycle to end.
	Freezer control in OFF position.	Move the freezer control to a lower temperature setting.
	Refrigerator is unplugged.	Push the plug completely into the outlet.
	The fuse is blown/circuit breaker is tripped.	Replace fuse or reset the breaker.
	Refrigerator is in showroom mode.	Unplug the refrigerator and plug it back in.
Vibration or rattling (slight vibration is normal)	Rollers need adjusting.	See Rollers.
Motor operates for long periods or cycles on and off frequently. (Modern refrigerators with more storage space and a larger freezer require more operating time. They start and stop often to maintain even temperatures.)	Normal when refrigerator is first plugged in.	Wait 24 hours for the refrigerator to completely cool down.
	Often occurs when large amounts of food are placed in refrigerator.	This is normal.
	Door left open.	Check to see if package is holding door open.
	Hot weather or frequent door openings.	This is normal.
	Temperature controls set at the coldest setting.	See Controls.
Refrigerator or freezer compartment too warm	Temperature control not set cold enough.	See Controls.
	Warm weather or frequent door openings.	Set the temperature control one step colder. See Controls.
	Door left open.	Check to see if package is holding door open.
Frost or ice crystals on frozen food (frost within package is normal)	Door left open.	Check to see if package is holding door open.
	Too frequent or too long door openings.	
Divider between refrigerator and freezer compartments feels warm	Automatic energy saver system circulates warm liquid around front edge of freezer compartment.	This helps prevent condensation on the outside.

# TROUBLESHOOTING TIPS Before you call for service

## TROUBLESHOOTING TIPS

Problem	Possible Causes	What To Do
Automatic icemaker does not work	Icemaker switch is in the OFF position.	Slide the switch to the ON position.
	Water supply turned off or not connected.	See Installing the water line.
	Freezer compartment too warm.	Wait 24 hours for the refrigerator to completely cool down.
	Piled up cubes in the storage bin cause icemaker to shut off.	Level cubes by hand.
	Ice cubes stuck in icemaker.	Turn off the icemaker, remove cubes and turn the icemaker back on.
	Filter is not properly installed. Filter water leak	Replace filter or make sure the water filter is properly installed (refer to water filter section).
Ice cubes have odor/taste	Ice storage bin needs cleaning.	Empty and wash bin. Discard old cubes.
	Food transmitting odor/taste to ice cubes.	Wrap foods well.
	Interior of refrigerator needs cleaning.	See Care and cleaning.
Small or hollow cubes	Water filter clogged.	Replace filter cartridge with new cartridge or with plug.
Slow ice cube freezing	Door left open.	Check to see if package is holding door open.
	Temperature control not set cold enough.	See Controls.
Frequent "buzzing sound"	Icemaker switch is in the ON position, but the water supply to the refrigerator has not been connected.	Set the switch to the OFF position. Keeping it in the ON position will damage the water valve.
Red / Orange glow in the freezer section, steam coming from vents, Popping / hissing sound coming from the freezer area.	This is normal operation for glass defrost heater models. The heater is clearing out frost from your refrigerator evaporator for optimum operation.	<b>Do not touch the vent area or unplug the refrigerator. It is normal operation and the heater will turn off once the frost has been cleared.</b>
Cube dispenser does not work (on some models)	Icemaker or water supply turned off.	Turn on icemaker or water supply.
	Ice cubes are frozen to icemaker feeler arm.	Remove cubes.
	An item is blocking or has fallen into the ice chute inside the top bin of the freezer.	Remove any item that might be blocking, or has fallen into the chute.
	Irregular ice clumps in storage container.	Break up with fingertip pressure and discard remaining clumps.
		Freezer may be too warm. Adjust the freezer control to a colder setting, one position at a time, until clumps do not form.
Dispenser is LOCKED.	Press and hold the Lock pad for 3 seconds.	
Water has poor taste/odor (on some models)	Water dispenser has not been used for a long time.	Dispense water until all water in system is replenished.
Water in first glass is warm (on some models)	Normal when refrigerator is first installed	Wait 24 hours for the refrigerator to completely cool down.
	Water dispenser has not been used for a long time.	Dispense water until all water in system is replenished.
	Water system has been drained.	Allow several hours for replenished supply to chill.
Water dispenser does not work (on some models)	Water supply line turned off or not connected.	See Installing the water line.
	Water filter clogged.	Replace filter cartridge or remove filter and install plug.
	Air may be trapped in the water system.	Press the dispenser arm for at least two minutes.
	Dispenser is LOCKED.	Press and hold the Lock pad for 3 seconds.

# Troubleshooting Tips... Before you call for service

Problem	Possible Causes	What To Do
Water spurting from dispenser	Newly-installed filter cartridge.	Run water from the dispenser for 3 minutes (about 1½ gallons).
Water is not dispensed (on some models) but icemaker is working	Water in reservoir is frozen.	Call for service.
	Refrigerator control setting is too cold.	Set to a warmer setting.
No water or ice cube production	Supply line or shutoff valve is clogged.	Call a plumber.
	Water filter clogged.	Replace filter cartridge or remove filter and install plug.
	Dispenser is LOCKED.	Press and hold the LOCK CONTROLS pad for 3 seconds.
	Filter is not properly installed. Filter water leak	Replace filter or make sure the water filter is properly installed (refer to water filter section).
CUBED ICE was selected but CRUSHED ICE was dispensed (on some models)	Last setting was CRUSHED ICE.	A few cubes were left in the crusher from the previous setting. This is normal.
Refrigerator has odor	Foods transmitting odor to refrigerator.	Foods with strong odors should be tightly wrapped. Keep an open box of baking soda in the refrigerator; replace every three months.
	Interior needs cleaning.	See Care and cleaning.
Moisture forms on outside of refrigerator	Not unusual during periods of high humidity.	Wipe surface dry.
Moisture collects inside (in humid weather, air carries moisture into refrigerator when doors are opened)	Too frequent or too long door openings.	This is normal for the beverage center.
	Due to the higher humidity in the refrigerator, you may on occasion experience fog or small amounts of moisture in the refrigerator compartment	This is normal for the beverage center loads and environmental conditions change with a paper towel if desired.
Interior light does not work	No power at outlet.	Replace fuse or reset the breaker.
	For LED lights	Call Service.
Water on kitchen floor or on bottom of freezer	Cubes jammed in chute.	Poke ice through with a wooden spoon.
Hot air from bottom of refrigerator	Normal air flow cooling motor. In the refrigeration process, it is normal that heat be expelled in the area under the refrigerator. Some floor coverings are sensitive and will discolor at these normal and safe temperatures.	This is normal.
Refrigerator never shuts off but the temperatures are OK	Adaptive defrost keeps compressor running during door openings.	This is normal. The refrigerator will cycle off after the door remains closed for 2 hours.
Refrigerator is beeping	Door is open.	Close door.
Door not closing properly	Door gasket on hinge side sticking or folding over.	Apply petroleum jelly on face of gasket
Actual temperature not equal to Set temperature	Unit just plugged in.	Allow 24 hours for system to stabilize
	Door open for too long	Allow 24 hours for system to stabilize
	Warm food added to refrigerator	Allow 24 hours for system to stabilize
	Defrost cycle is in process	Allow 24 hours for system to stabilize

# LIMITED WARRANTY Refrigerator Limited Warranty

## GEAppliances.com

For US Customers, all warranty service is provided by our Factory Service Centers, or an authorized Customer Care® technician. To schedule service online, visit us at **GEAppliances.com**, or call GE Appliances at 800.GE.CARES (800.432.2737). Please have your serial number and your model number available when calling for service. In Canada, call 800.561.3344.

Service your refrigerator may require the use of the onboard data port for diagnostics. This gives a GE Appliances Factory Service technician the ability to quickly diagnose any issues with your appliance and helps GE Appliances improve its products by providing GE Appliances with information on your appliance. If you do not want your appliance data to be sent to GE Appliances, please advise your technician NOT to submit the data to GE Appliances at the time of service.

<b>For the Period of:</b>	<b>GE Appliances Will Replace</b>
---------------------------	-----------------------------------

### GE and GE PROFILE MODELS:

<b>One Year</b> From the date of the original purchase	<b>Any part</b> of the refrigerator which fails due to a defect in materials or workmanship. During the <b>limited one-year warranty</b> , GE Appliances will also provide, <b>free of charge</b> , all labor and related service to replace the defective part.
<b>Thirty Days</b> (Water filter, if included) From the original purchase date of the refrigerator	<b>Any part</b> of the water filter cartridge which fails due to a defect in materials or workmanship. During this <b>limited thirty-day warranty</b> , GE Appliances will also provide, <b>free of charge</b> , a replacement water filter cartridge.

### GE PROFILE MODELS ONLY

<b>Five Years</b> From the date of the purchase	<b>Any part</b> of the sealed refrigerating system (the compressor, condenser, evaporator and all connecting tubing) which fails due to a defect in materials or workmanship. During this <b>limited five-year sealed refrigerating system warranty</b> , GE Appliances will also provide, <b>free of charge</b> , all labor and related service to replace the defective part in the sealed refrigerating system.
--	--

### What GE Appliances Will Not Cover:

- Service trips to your home to teach you how to use the product.
- Improper installation, delivery or maintenance.
- Failure of the product if it is abused, misused, or used for other than the intended purpose or used commercially.
- Loss of food due to spoilage.
- Replacement of house fuses or resetting of circuit breakers.
- Damage to finish, such as surface rust, tarnish, or small blemishes not reported within 48 hours of delivery.
- Damage caused by a non-GE Appliances Brand water filter.
- Replacement of the water filter cartridge, if included, due to water pressure that is outside the specified operating range or due to excessive sediment in the water supply.
- Replacement of the light bulbs, if included, or water filter cartridge, if included, other than as noted above.
- Damage to the product caused by accident, fire, floods or acts of God.
- Incidental or consequential damage caused by possible defects with this appliance.
- Product not accessible to provide required service.

### EXCLUSION OF IMPLIED WARRANTIES

Your sole and exclusive remedy is product repair as provided in this Limited Warranty. Any implied warranties, including the implied warranties of merchantability or fitness for a particular purpose, are limited to one year or the shortest period allowed by law.

**For US Customers:** This limited warranty is extended to the original purchaser and any succeeding owner for products purchased for home use within the USA. If the product is located in an area where service by a GE Appliances Authorized Servicer is not available, you may be responsible for a trip charge or you may be required to bring the product to an Authorized GE Appliances Service location for service. In Alaska, the limited warranty excludes the cost of shipping or service calls to your home.

Some states do not allow the exclusion or limitation of incidental or consequential damages. This limited warranty gives you specific legal rights, and you may also have other rights which vary from state to state. To know what your legal rights are, consult your local or state consumer affairs office or your state's Attorney General.

**Warrantor: GE Appliances, a Haier company**

**Louisville, KY 40225**

**For Customers in Canada:** This limited warranty is extended to the original purchaser and any succeeding owner for products purchased in Canada for home use within Canada. In-home warrant service will be provided in areas where it is available and deemed reasonable by MC Commercial Inc. to provide. If the product is located in an area where service by a GE Appliances Authorized Servicer is not available, you may be responsible for a trip charge or you may be required to bring the product to an Authorized GE Appliances Service location for service.

**Warrantor Canada: MC Commercial Inc., Burlington Ontario, L7R 5B6**

Staple your receipt here. Proof of the original purchase date is needed to obtain service under the warranty.

# Water Filter Cartridge XWFE Limited Warranty

**LIMITED WARRANTY**

Contact us at [geapplianceparts.com](http://geapplianceparts.com), or call 800.GE.CARES.

<b>For the period of</b>	<b>GE Appliances will replace</b>
<b>Thirty Days</b> From the date of the original purchase	<b>Any part of the water filter cartridge which fails due to a defect in materials or workmanship during this <b>limited thirty-day warranty</b>.*</b>

## What GE Appliances will not cover:

- Service trips to your home to teach you how to use the product.
- Improper installation.
- Failure of the product if it is abused, misused, used for other than the intended purpose or used commercially.
- Replacement of house fuses or resetting of circuit breakers.
- Damage to the product caused by accident, fire, floods, or acts of God.
- Incidental or consequential damage caused by possible defects with this appliance.

### EXCLUSION OF IMPLIED WARRANTIES

Your sole and exclusive remedy is part exchange as provided in this Limited Warranty. Any implied warranties, including the implied warranties of merchantability or fitness for a particular purpose, are limited to six months or the shortest period allowed by law.

This limited warranty is extended to the original purchaser and any succeeding owner for products purchased for home use within the USA. In Alaska, the limited warranty excludes the cost of shipping or service calls to your home.

Some states do not allow the exclusion or limitation of incidental or consequential damages. This limited warranty gives you specific legal rights, and you may also have other rights which vary from state to state. To know what your legal rights are, consult your local or state consumer affairs office or your state's Attorney General.

**For Purchases Made In Iowa:** This form must be signed and dated by the buyer and seller prior to the consummation of this sale.

This form should be retained on file by the seller for a minimum of two years.

## Buyer:

Name \_\_\_\_\_

Address \_\_\_\_\_

City \_\_\_\_\_ State \_\_\_\_\_ Zip \_\_\_\_\_

Signature \_\_\_\_\_ Date \_\_\_\_\_

## Seller:

Name \_\_\_\_\_

Address \_\_\_\_\_

City \_\_\_\_\_ State \_\_\_\_\_ Zip \_\_\_\_\_

Signature \_\_\_\_\_ Date \_\_\_\_\_

\*If your GE Appliances part fails because of a manufacturing defect within thirty days from the date of original purchase for use, we will give you a new or, at our option, a rebuilt part without charge. Return the defective part to the parts supplier from whom it was purchased together with a copy of the "proof of purchase" for the part. If the part is defective and shows no signs of abuse, it will be exchanged. The warranty does not cover the failure of parts which are damaged while in your possession, are abused, or have been installed improperly. It does not cover the cost of returning the part to the supplier from whom it was purchased nor does it cover the cost of labor to remove or install it to diagnose the fault. It does not cover parts used in products in commercial use except in the case of air conditioning equipment. In no event shall GE Appliances be liable for consequential damages.

**Warrantor: GE Appliances, a Haier company**  
Louisville, KY 40225

Staple your receipt here. Proof of the original purchase date is needed to obtain service under the warranty.





# Performance Data Sheet

## Model: GE Appliances XWFE

- System certified by IAPMO R&T against NSF/ANSI Standards 42, 53, 401 and P473 for the reduction of claims specified on the performance data sheet and at [iapmort.org](http://iapmort.org).
- Actual performance may vary with local water conditions.

Substance Tested for Reduction	Influent challenge concentration (mg/L)	Maximum permissible product water concentration (mg/L)	Avg % Reduction
Chlorine Taste and Odor	2.0 mg/L +/- 10%	N/A	> 99
Chloramine Taste and Odor	3.0 mg/L +/- 10%	0.5	> 99
Particulate, Class I	At least 10,000/mL	N/A	91.4
Cysts	50,000/L	N/A	> 99.99
Lead	0.15	0.01	98.85
Mercury	0.006	0.002	96.95
Asbestos	107 to 108 fibers/ L	N/A	> 99
Toxaphene	0.015 +/- 10%	0.003	86.95
VOC (Chloroform surrogate chemical)	0.300	0.015	> 99
Alachlor	0.050	0.001	> 98
Atrazine	0.100	0.003	> 97
Benzene	0.081	0.001	> 99
Carbofuran	0.190	0.001	> 99
carbon tetrachloride	0.078	0.0018	98
chlorobenzene	0.077	0.001	> 99
chloropicrin	0.015	0.0002	99
2,4-D	0.110	0.0017	98
dibromochloropropane (DBCP)	0.052	0.00002	> 99
o-Dichlorobenzene	0.08	0.001	> 99
p-Dichlorobenzene	0.040	0.001	> 98
1,2-dichloroethane	0.088	0.0048	95
1,1-dichloroethylene	0.083	0.001	> 99
cis-1,2-dichloroethylene	0.170	0.0005	> 99
trans-1,2-dichloroethylene	0.086	0.001	> 99
1,2-dichloropropane	0.080	0.001	> 99
cis-1,3-dichloropropylene	0.079	0.001	> 99
dinoseb	0.170	0.0002	99
Endrin	0.053	0.00059	99
Ethylbenzene	0.088	0.001	> 99
ethylene dibromide (EDB)	0.044	0.00002	> 99
bromochloroacetonitrile	0.022	0.0005	98
dibromoacetonitrile	0.024	0.0006	98
dichloroacetonitrile	0.0096	0.0002	98
trichloroacetonitrile	0.015	0.0003	98
1,1-dichloro-2-propanone	0.0072	0.0001	99
1,1,1-trichloro-2-propanone	0.0082	0.0003	96
heptachlor (H-34, Heptox)	0.025	0.00001	> 99
heptachlor epoxide	0.0107	0.0002	98
hexachlorobutadiene	0.044	0.001	> 98
hexachlorocyclopentadiene	0.060	0.000002	> 99
Lindane	0.055	0.00001	> 99
methoxychlor	0.050	0.0001	> 99
pentachlorophenol	0.096	0.001	> 99
simazine	0.120	0.004	> 97
Styrene	0.150	0.0005	> 99
1,1,2,2-tetrachloroethane	0.081	0.001	> 99
Tetrachloroethylene	0.081	0.001	> 99
Toluene	0.078	0.001	> 99
2,4,5-TP (silvex)	0.270	0.0016	99
tribromoacetic acid	0.042	0.001	> 98
1,2,4-Trichlorobenzene	0.160	0.0005	> 99
1,1,1-trichloroethane	0.084	0.0046	95
1,1,2-trichloroethane	0.150	0.0005	> 99
trichloroethylene	0.180	0.0010	> 99
bromoform	0.300	0.015	95
bromodichloromethane	0.300	0.015	95
chlorodibromomethane	0.300	0.015	95
xylenes	0.070	0.001	> 99
Meprobamate	400 +/- 20%	60	> 99
Atenolol	200 +/- 20%	30	> 99
Carbamazepine	1400 +/- 20%	200	> 99
DEET	1400 +/- 20%	200	> 99
Metolachlor	1400 +/- 20%	200	> 99
Trimethoprim	140 +/- 20%	20	> 99
Linuron	140 +/- 20%	20	> 99
TCEP	5000 +/- 20%	700	> 99
T CPP	5000 +/- 20%	700	> 99
Phenytol	200 +/- 20%	30	> 99
Ibuprofen	400 +/- 20%	60	> 99
Naproxen	140 +/- 20%	20	> 99
Estrone	140 +/- 20%	20	> 99
Bisphenol A	2000 +/- 20%	300	> 99
Nonyl phenol	1400 +/- 20%	200	> 99
PFOA/PFOS	1.5 mg/L +/- 10%	0.07	99.25

### Application Guidelines/Water Supply Parameters

Service Flow	0.5 gpm (1.89 lpm)
Water Supply	Potable Water
Water Pressure	25-120 psi (172-827 kPa)
Water Temperature	33°F-100°F (0.6°C-38°C)
Capacity	170 gallons (643.5 liters)

It is essential that the manufacturer's recommended installation, maintenance and filter replacement requirements be carried out for the product to perform as advertised. See Installation Manual for Warranty information.

**NOTE:** While the testing was performed under standard laboratory conditions, actual performance may vary. Replacement Cartridge: XWFE. For estimated costs of replacement elements please call 1.877.959.8688 or visit our website at [gewaterfilters.com](http://gewaterfilters.com).

### **⚠ WARNING** To reduce the risk associated with ingestion of contaminants:

- Do not use with water that is microbiologically unsafe or of unknown quality without adequate disinfection before and after the system. Systems certified for cyst reduction may be used on disinfected water that may contain filterable cysts.

### NOTICE

To reduce the risk of water leakage or flooding, and to ensure optimal filter performance:

- Read and follow use instructions before installation and use of this system.
- Installation and use **MUST** comply with all state and local plumbing codes.
- Do not install if water pressure exceeds 120 psi (827 kPa). If your water pressure exceeds 80 psi (552 kPa), you **must** install a pressure-limiting valve. Contact a plumbing professional if you are uncertain how to check your water pressure.
- Do not install where water hammer conditions may occur. If water hammer conditions exist you **must** install a water hammer arrester. Contact a plumbing professional if you are uncertain how to check for this condition.
- Do not install on hot water supply lines. The maximum operating water temperature of this filter system is 100° F (38° C).
- Protect filter from freezing. Drain filter when temperatures drop below 33°F (0.6°C).
- Change the disposable filter cartridge every six months or sooner if you observe a noticeable reduction in water flow rate.
- Failure to replace the disposable filter cartridge at recommended intervals may lead to reduced filter performance and cracks in the filter housing, causing water leakage or flooding.
- This System has been tested according to NSF/ANSI 42, 53, 401 and P473 for the reduction of the substances listed below. The concentration of the indicated substances in water entering the system was reduced to a concentration less than or equal to the permissible limit for water leaving the system, as specified in NSF/ANSI 42, 53, 401 and P473.



XWFE System is certified by IAPMO R&T against NSF/ANSI Standards 42, 53, 401, and P473 for the reduction of claims specified on the performance data sheet and at [iapmort.org](http://iapmort.org).

# Appliance Communication (on some models)

---

## REGULATORY INFORMATION

### FCC/IC Compliance Statement:

This device complies with Part 15 of the FCC Rules. This device contains license-exempt transmitter(s)/receiver(s) that comply with Innovation, Science and Economic Development, Canada's license-exempt RSS(s). Operation is subject to the following two conditions:

1. This device may not cause harmful interference.
2. This device must accept any interference received, including interference that may cause undesired operation.

This equipment has been tested and found to comply with the limits for a Class B digital device, pursuant to Part 15 of the FCC Rules. These limits are designed to provide reasonable protection against harmful interference in a residential installation. This equipment generates, uses and can radiate radio frequency energy and, if not installed and used in accordance with the instructions, may cause harmful interference to radio communications. However, there is no guarantee that interference will not occur in a particular installation. If this equipment does cause harmful interference to radio or television reception, which can be determined by turning the equipment off and on, the user is encouraged to try to correct the interference by one or more of the following measures:

- Reorient or relocate the receiving antenna.
- Increase the separation between the equipment and receiver.
- Connect the equipment into an outlet on a circuit different from that to which the receiver is connected.
- Consult the dealer or an experienced radio/television technician for help.

**Labelling:** Changes or modifications to this unit not expressly approved by the manufacturer could void the user's authority to operate the equipment.

**ConnectPlus** *module only (or similar communication module)*

**RF Exposure** - This device is only authorized for use in a mobile application. At least 20 cm of separation distance between the **ConnectPlus** device and the user's body must be maintained at all times.

# Consumer Support

---

## GE Appliances Website

Have a question or need assistance with your appliance? Try the GE Appliances Website 24 hours a day, any day of the year! You can also shop for more great GE Appliances products and take advantage of all our on-line support services designed for your convenience. In the US: [GEAppliances.com](http://GEAppliances.com) In Canada: [GEAppliances.ca](http://GEAppliances.ca)

---

## Register Your Appliance

Register your new appliance on-line at your convenience! Timely product registration will allow for enhanced communication and prompt service under the terms of your warranty, should the need arise. You may also mail in the pre-printed registration card included in the packing material.

In the US: [GEAppliances.com/register](http://GEAppliances.com/register)

In Canada: [Prodsupport.mabe.ca/crm/Products/ProductRegistration.aspx](http://Prodsupport.mabe.ca/crm/Products/ProductRegistration.aspx)

---

## Schedule Service

Expert GE Appliances repair service is only one step away from your door. Get on-line and schedule your service at your convenience any day of the year. In the US: [GEAppliances.com/service](http://GEAppliances.com/service) or call 800.432.2737 during normal business hours.

In Canada: [GEAppliances.ca/en/support/service-request](http://GEAppliances.ca/en/support/service-request) or call 800.561.3344

---

## Extended Warranties

Purchase a GE Appliances extended warranty and learn about special discounts that are available while your warranty is still in effect. You can purchase it on-line anytime. GE Appliances Services will still be there after your warranty expires. In the US: [GEAppliances.com/extended-warranty](http://GEAppliances.com/extended-warranty) or call 800.626.2224 during normal business hours.

In Canada: [GEAppliances.ca/en/support/purchase-extended-warranty](http://GEAppliances.ca/en/support/purchase-extended-warranty) or call 866.277.9842

---

## Parts and Accessories

Individuals qualified to service their own appliances can have parts or accessories sent directly to their homes (VISA, MasterCard and Discover cards are accepted). Order on-line today 24 hours every day.

In the US: [GEApplianceparts.com](http://GEApplianceparts.com) or by phone at 877.959.8688 during normal business hours.

**Instructions contained in this manual cover procedures to be performed by any user. Other servicing generally should be referred to qualified service personnel. Caution must be exercised, since improper servicing may cause unsafe operation.**

Customers in Canada should consult the yellow pages for the nearest authorized GE Appliances service parts distributor, visit our website at [GEAppliances.ca/en/products/parts-filters-accessories](http://GEAppliances.ca/en/products/parts-filters-accessories) or call 800.661.1616.

---

## Contact Us

If you are not satisfied with the service you receive from GE Appliances, contact us on our Website with all the details including your phone number, or write to:

In the US: General Manager, Customer Relations | GE Appliances, Appliance Park | Louisville, KY 40225

[GEAppliances.com/contact](http://GEAppliances.com/contact)

In Canada: Director, Consumer Relations, MC Commercial Inc. | Suite 310, 1 Factory Lane | Moncton, N.B. E1C 9M3

[GEAppliances.ca/en/contact-us](http://GEAppliances.ca/en/contact-us)