

Use & Care Guide

English

Table of Contents...2

Models: 106.5004*, 5175*

Kenmore[®]

Side by Side Refrigerator

* = color number

P/N W11439251A
Transform SR Brands Management LLC,
Hoffman Estates, IL 60179 U.S.A.
www.kenmore.com



TABLE OF CONTENTS

TABLE OF CONTENTS	2	FREEZER FEATURES	18
KENMORE MAJOR APPLIANCE WARRANTY	3	Freezer Shelf	18
REFRIGERATOR SAFETY	4	Freezer Bin	18
Proper Disposal of Your Old Refrigerator.....	5	DOOR FEATURES	18
INSTALLATION INSTRUCTIONS	5	Door Bins.....	18
Unpack the Refrigerator.....	5	Door Rails or Bins.....	18
Door Removal, Leveling, and Alignment	6	REFRIGERATOR CARE	19
Handle Installation and Removal	8	Cleaning.....	19
Location Requirements.....	9	Lights	19
Electrical Requirements.....	9	Power Interruptions.....	20
Water Supply Requirements	9	Vacation and Moving Care.....	20
Connect Water Supply	10	TROUBLESHOOTING	21
Prepare the Water System	12	ACCESSORIES	25
REFRIGERATOR USE	12	PERFORMANCE DATA SHEET	26
Ensuring Proper Air Circulation.....	12	SERVICE NUMBERS	BACK COVER
Using the Controls.....	12		
Water and Ice Dispensers.....	13		
Water Filtration System.....	15		
Ice Maker and Storage Bin.....	16		
REFRIGERATOR FEATURES	17		
Refrigerator Shelves	17		
Deli Drawer	17		
Convertible Vegetable/Meat Drawer, Crisper and Covers.....	17		
Crisper Humidity Control.....	17		

WARRANTY

KENMORE LIMITED WARRANTY

WITH PROOF OF SALE the following warranty coverage applies when this appliance is correctly installed, operated and maintained according to all supplied instructions.

One Year on Appliance

FOR ONE YEAR from the date of sale this appliance is warranted against defects in material or workmanship. A defective appliance will receive free repair or replacement at option of seller.

Lifetime on Storage Bins

FOR AS LONG AS IT IS USED from the date of sale, a free replacement will be supplied for a defective refrigerator or freezer compartment storage bin. If the defect appears within the first year, a new bin will be installed at no charge. If the defect appears after the first year, a new bin will be supplied but not installed at no charge. This Lifetime warranty covers only storage bins, and does not apply to any other related component or mechanism. You are responsible for the labor cost of bin installation after the first year from the date of sale. This warranty coverage applies for only 90 days from the date of sale if the appliance is ever used for other than private household purposes.

For warranty coverage details to obtain free repair or replacement, visit the web page: www.kenmore.com/warranty

All warranty coverage applies for only 90 DAYS from the sale date if this appliance is ever used for other than private household purposes.

This warranty covers ONLY defects in material and workmanship, and will NOT pay for:

1. Expendable items that can wear out from normal use, including but not limited to filters, belts, bags or screw-in base light bulbs.
2. A service technician to clean or maintain this appliance, or to instruct the user in correct appliance installation, operation and maintenance.
3. Service calls to correct appliance installation not performed by Sears authorized service agents, or to repair problems with house fuses, circuit breakers, house wiring, and plumbing or gas supply systems resulting from such installation.

4. Damage to or failure of this appliance resulting from installation not performed by Sears authorized service agents, including installation that was not in accord with electrical, gas or plumbing codes.
5. Damage to or failure of this appliance, including discoloration or surface rust, if it is not correctly operated and maintained according to all supplied instructions.
6. Damage to or failure of this appliance, including discoloration or surface rust, resulting from accident, alteration, abuse, misuse or use for other than its intended purpose.
7. Damage to or failure of this appliance, including discoloration or surface rust, caused by the use of detergents, cleaners, chemicals or utensils other than those recommended in all instructions supplied with the product.
8. Damage to or failure of parts or systems resulting from unauthorized modifications made to this appliance.
9. Service to an appliance if the model and serial plate is missing, altered, or cannot easily be determined to have the appropriate certification logo.

Disclaimer of implied warranties; limitation of remedies

Customer's sole and exclusive remedy under this limited warranty shall be product repair or replacement as provided herein. Implied warranties, including warranties of merchantability or fitness for a particular purpose, are limited to one year on the appliance and for as long as used on the storage bins, or the shortest period allowed by law. Seller shall not be liable for incidental or consequential damages. Some states and provinces do not allow the exclusion or limitation of incidental or consequential damages, or limitation on the duration of implied warranties of merchantability or fitness, so these exclusions or limitations may not apply to you.

This warranty applies only while this appliance is used in the United States.

This warranty gives you specific legal rights, and you may also have other rights which vary from state to state.

**Transform SR Brands management,
Hoffman Estates, IL 60179**

REFRIGERATOR SAFETY

Your safety and the safety of others are very important.

We have provided many important safety messages in this manual and on your appliance. Always read and obey all safety messages.



This is the safety alert symbol.

This symbol alerts you to potential hazards that can kill or hurt you and others.

All safety messages will follow the safety alert symbol and either the word "DANGER" or "WARNING." These words mean:

! DANGER

You can be killed or seriously injured if you don't immediately follow instructions.

! WARNING

You can be killed or seriously injured if you don't follow instructions.

All safety messages will tell you what the potential hazard is, tell you how to reduce the chance of injury, and tell you what can happen if the instructions are not followed.

IMPORTANT SAFETY INSTRUCTIONS

WARNING: To reduce the risk of fire, electric shock or injury to persons when using the refrigerator, follow basic precautions, including the following:

- Plug into a grounded 3-prong outlet.
- Do not remove the ground prong.
- Do not use an adapter.
- Do not use an extension cord.
- Disconnect power before servicing.
- Replace all parts and panels before operating.
- Remove doors from your old refrigerator.
- Connect only to the potable water supply.
- Use non-flammable cleaner.
- Keep flammable materials and vapors, such as gasoline, well away from the refrigerator.
- Use two or more people to move and install the refrigerator.
- Disconnect the power before installing the ice maker (on ice maker kit-ready models only).
- Use a sturdy glass when dispensing ice (on some models).
- Do not hit the refrigerator glass doors (on some models).
- This appliance is not intended for use by persons (including children) with reduced physical, sensory or mental capabilities, or lack of experience and knowledge, unless they have been given supervision or instruction concerning use of the appliance by a person responsible for their safety.
- Children should be supervised to ensure that they do not play with the appliance.
- If the supply cord is damaged, it must be replaced by the manufacturer, its service agent or similarly qualified person in order to avoid a hazard.
- Do not store explosive substances such as aerosol cans with a flammable propellant in this appliance.
- This appliance is intended to be used in household and similar applications such as:
 - Staff kitchen areas in shops, offices and other working environments;
 - Farm houses and by clients in hotels, motels and other residential type environments;
 - Bed and breakfast type environments;
 - Catering and similar non-retail applications.
- Keep ventilation openings, in the appliance enclosure or in the built-in structure, clear of obstruction.
- Do not use mechanical devices or other means to accelerate the defrosting process, other than those recommended by the manufacturer.
- Do not damage the the refrigerant circuit.
- Do not use electrical appliances inside the food storage compartments of the appliance, unless they are of the type recommended by the manufacturer.

PLEASE KEEP THESE INSTRUCTIONS

PROPER DISPOSAL OF YOUR OLD REFRIGERATOR

WARNING: Risk of child entrapment. Before You Throw Away Your Old Refrigerator or Freezer:

- Take off the doors.
- Leave the shelves in place so that children may not easily climb inside.

! WARNING

Suffocation Hazard

Remove doors from your old refrigerator.

Failure to do so can result in death or brain damage.

IMPORTANT: Child entrapment and suffocation are not problems of the past. Junked or abandoned refrigerators are still dangerous, even if they will sit for “just a few days.” If you are getting rid of your old refrigerator, please follow these instructions to help prevent accidents.

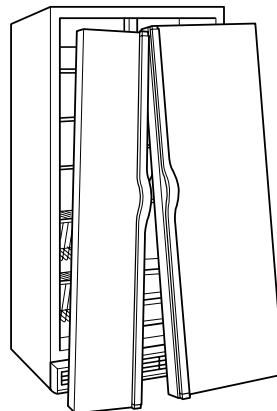

Important information to know about disposal of refrigerants:

Dispose of refrigerator in accordance with Federal and Local regulations. Refrigerants must be evacuated by a licensed, EPA certified refrigerant technician in accordance with established procedures.

INSTALLATION INSTRUCTIONS

UNPACK THE REFRIGERATOR

! WARNING

Excessive Weight Hazard

Use two or more people to move and install refrigerator.

Failure to do so can result in back or other injury.

When Moving Your Refrigerator:

Your refrigerator is heavy. When moving the refrigerator for cleaning or service, be sure to cover the floor with cardboard or hardboard to avoid floor damage. Always pull the refrigerator straight out when moving it. Do not wiggle or “walk” the refrigerator when trying to move it, as floor damage could occur.

Remove the Packaging

- Remove tape and glue residue from surfaces before turning on the refrigerator. Rub a small amount of liquid dish soap over the adhesive with your fingers. Wipe with warm water and dry.
- Do not use sharp instruments, rubbing alcohol, flammable fluids, or abrasive cleaners to remove tape or glue. These products can damage the surface of your refrigerator. For more information see the “Refrigerator Safety” section.

Clean Before Using

- After you remove all of the packaging materials, clean the inside of your refrigerator before using it. See the cleaning instructions in the “Refrigerator Care” section.

Important information to know about glass shelves and covers:

Do not clean glass shelves or covers with warm water when they are cold. Shelves and covers may break if exposed to sudden temperature changes or impact, such as bumping. Tempered glass is designed to shatter into many small, pebble-size pieces. This is normal. Glass shelves and covers are heavy. Use both hands when removing them to avoid dropping.

DOOR REMOVAL, LEVELING, AND ALIGNMENT

Gather the required tools and parts and read all instructions before starting installation. Save these instructions for future reference.

NOTE: Before moving your product into your home, measure the doorway of your home to see whether you need to remove the refrigerator and freezer doors. If door removal is necessary, see the instructions below.

IMPORTANT: Before you begin, unplug refrigerator or disconnect power. Remove food, the ice storage bin (on some models), and any adjustable door or utility bins from doors.

TOOLS NEEDED: Bubble level; flat-blade screwdriver; 5/16" and 11/16" wrench; 1/4", 3/8", and 5/16" hex-head socket wrenches, TORX T30† screwdriver, Phillips screwdriver tip #2 with 4" long as minimum.



⚠ WARNING

Electrical Shock Hazard

Disconnect power before removing doors.

Failure to do so can result in death or electrical shock.

6 Top Left Hinge

Do not remove A screws.

7 Door Removal

8 Top Right Hinge

Do not remove A screws.

9 Left and Right Bottom Hinges

Do not remove B screws.

1 Full Refrigerator

5 Wiring

A. Wiring plugs
B. Wiring clip
C. Grommets

4 Water Dispenser Tubing

A. Face of fitting. A

10 Leveling screws

Lower Raise
Raise Lower

11 Locking Nut

11/16" wrench
Tighten
Loosen

3 Base Grille

2 Water Filter Door and Base Grille

12 Alignment Screw

Raise
Lower
5/16" wrench

†TORX and T30 are trademarks of Acument Intellectual Properties, LLC.

Remove the Doors

If your new refrigerator passes through the doorway, refer to the "Cabinet Leveling & Door closing" section in this manual.

If your refrigerator does not fit through the doorway or you are getting rid of your old refrigerator, follow the steps below for door removal.

⚠ WARNING



Electrical Shock Hazard

Disconnect power before removing doors.

Failure to do so can result in death or electrical shock.

Doors & Hinges Removal

1. Unplug your refrigerator or disconnect power.
2. Fully open both doors. See graphic 1.
3. If your model has water dispensing, please open the water filter door by pulling it toward you (A). See graphic 2.
4. Use a Phillips screwdriver tip #2 to remove the screws of the base grille (B). See graphic 2.
5. To dislodge the base grille pull it up strongly toward you from one side then from other side (C). See graphic 2.
6. To remove the base grille completely, pass it underneath the refrigerator door. See graphic 3.
7. If your model has water dispensing in the door, disconnect the water dispenser tubing located below the freezer door.

- Press the blue outer ring against the face of fitting and pull the dispenser tubing free. See graphic 4.

NOTE: Keep the water tubing connector attached to the tube that runs underneath the freezer. The door cannot be removed if the connector is still attached to the tube that runs through the door hinge.

8. If your model has water dispensing in the door, disconnect the wiring located below the freezer door. See graphic 5.
 - Remove the wiring clip and the bracket wire using a 1/4" hexagonal head socket wrench.
 - Disconnect the wiring plugs from the bracket wire.
9. Close the freezer door and use a TORX T30 screwdriver to remove the top hinge completely. See graphic 6.

IMPORTANT: Do not remove either screw A. Hold the door while hinge is being removed.

10. Lift the freezer door straight up off from the bottom hinge. See graphic 7. The water dispenser tubing and wiring will remain attached to the freezer door.

NOTE: This may require two people, one to lift the door and another to feed the water tubing and wiring into the bottom hinge pin.

IMPORTANT: Rest the door on its side on a soft, clean surface, such as a towel, blanket, or piece of cardboard. This will help to avoid scratching or damaging the door, water tubing, and wiring.

11. Close the refrigerator door and use a TORX T30 screwdriver to remove completely the top hinge. See graphic 8.

IMPORTANT: Do not remove either screw A. Hold the door while the hinge is being removed.

12. Lift the refrigerator door straight up off from the bottom hinge. See graphic 7.

IMPORTANT: Rest the door on its side on a soft, clean surface, such as a towel, blanket, or piece of cardboard. This will help to avoid scratching or damaging the door.

If your refrigerator passes through the doorway now, then go directly to the "Reinstalling Doors & Hinges" section located in this manual.

If your refrigerator without doors does not pass through the doorway, follow the instruction below:

13. Remove one or both hinges using a 5/16" nut driver tool. See graphic 9.

IMPORTANT: Do not remove either screw B.

Reinstalling Door and Hinges

1. Reinstall both bottom hinges using a 5/16" nut driver to tighten screws. See graphic 9.
2. If your model has water dispensing in the door:
 - Lift the freezer door enough to feed the water dispenser tubing and wiring through the bottom hinge pin. See graphic 7.

NOTE: This may require two people, one to lift the door and the other to feed the water tubing and wiring into the bottom hinge pin.

- Insert the freezer door into the bottom hinge pin.

IMPORTANT: Hold the door while hinge is being installed.

3. Close the freezer door to align and reinstall the top hinge. Use a TORX T30 screwdriver to tighten the screws. See graphic 8.

IMPORTANT: Provide additional support for the door while top hinge is being re installed. Do not depend on the door magnets to secure the door to the cabinet.
4. If your model has water dispensing in the door, connect the water dispenser tubing. For the connection, push the tubing into the dispenser tubing until black mark touches the face of fitting. See graphic 4.
5. Reinstall the wiring clip & bracket wire to the cabinet using a 1/4" hexagonal head socket wrench. See graphic 5.
6. Connect the wiring plugs from the bracket wire. See graphic 5.
7. Lift the refrigerator door enough to insert the door into the bottom hinge pin. See graphic 7.

IMPORTANT: Hold the door while hinge is being installed.

8. Close the refrigerator door to align and reinstall the top hinge. Use a TORX T30 screwdriver to tighten the screws. See graphic 6.

IMPORTANT: Provide additional support for the door while top hinge is being reinstalled. Do not depend on the door magnets to secure the door to the cabinet.

Leveling and Door Closing

Your refrigerator has two front adjustable wheels. See graphic 1. These are used to level the refrigerator under uneven floor conditions or allow the doors to close more easily. Please follow the instructions below:

1. Use a Bubble level to check levelness of floor where the rear side of the refrigerator will rest. If the refrigerator is not leveled, adjust or add the shim on flooring to create a leveled floor for the rear side wheels. A leveled rear side prevents the refrigerator cabinet from forming a twist.
2. Place the refrigerator into its final location in the kitchen and open both doors.
3. Fully open both doors. See graphic 1.
4. If your model has water dispensing in the door, please open the water filter door by pulling it toward you (A). See graphic 2.

- Using a Phillips screwdriver tip #2, remove the screws of the base grille(B). See graphic 2.
- To dislodge the base grille pull it up strongly toward you from one side then from other side (C). See graphic 2.
- To remove the base grille completely, pass it underneath the refrigerator door. See graphic 3.
- Use a 3/8" hex-head socket to turn the leveling screws located in both sides of the refrigerator. See graphic 10.
- Raise the wheels while one person pushes on the refrigerator to lift from front side. Use the bubble level on top of the refrigerator or on its side to level the refrigerator. Check bubble level and at the same time observe the gaps and squareness to the adjacent cabinets, furniture or trim. If adjacent furnishings are not level, it may not be possible to achieve even gaps when refrigerator is level.

NOTE: Depending on uneven floor conditions, you must turn one or both screws to the right or left several times to raise or lower the refrigerator. Continue adjusting until all four corners are steady without rock.

- Close both doors and check that they close as easily as you like. If not, turn both screws to the right to raise the refrigerator by tilting it more to the back until the doors close as easily as you like.
- Check and make sure that the technician sheet is placed in the base grille cavity before assembling the base grille into the cabinet.
- Reinstall the left side of the base grille first, and then the right side. See graphic 3. You may insert the water dispenser tubing and wiring into base grille cavity below the left bottom hinge.
- Attach the base grille by pushing it into the cabinet clips. See graphic 2.
- Using Phillips screwdriver, reinstall the screw to fix the base grill.

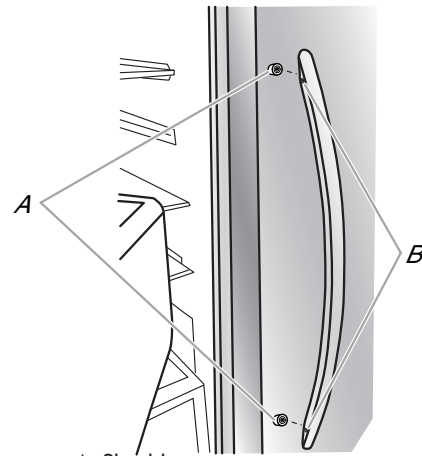

A. Shoulder screws
B. Setscrews inside the handle

- Firmly push the handle toward the door until the handle base is flush against the door.
- While holding the handle, insert the short end of the hex key into the upper hole and slightly rotate the hex key until it is engaged in the setscrew.

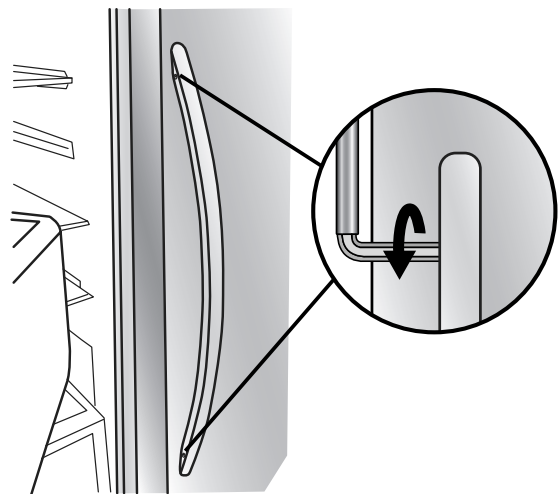

- Using a clockwise motion, tighten the setscrew until it begins to contact the shoulder screw.
- Repeat steps 4 and 5 to begin fastening the lower setscrew.
- Once both setscrews have been partially tightened as outlined in the previous steps, fully tighten both the upper and lower setscrews.

IMPORTANT: When the screws feel tight, tighten them an additional quarter-turn. The handle is not properly installed without this extra tightening.

- Open the refrigerator door and close the freezer door. Repeat steps 2 through 7 to install the other handle onto the freezer door with the setscrews facing the refrigerator.
- Save the hex key and all instructions.

To Remove the Handles:

- While holding the handle, insert the short end of the hex key into the lower setscrew hole and slightly rotate the hex key until it is engaged in the setscrew.
- Using a counterclockwise motion, loosen the setscrew a quarter turn at a time.
- Repeat steps 1 and 2 for the upper setscrew. Gently pull the handle away from the door.
- If necessary, use a Phillips screwdriver to remove the shoulder screws from the door.

Door Alignment

The refrigerator doors are designed to be slightly misaligned vertically when the refrigerator is empty. Please follow the next steps to align the refrigerator doors.

- Close both doors.
- Use an 11/16" open-ended wrench tool to loosen the locking nut located below the refrigerator door. See graphic 11. Accommodate the wrench tool so that it fits in the space.
- Use a 5/16" open-ended wrench tool to turn the alignment screw. See graphic 12. Depending on how the refrigerator door is misaligned in relation to the freezer door, you must turn the screw to the right to raise or to the left to lower the refrigerator door until both doors have been aligned vertically.

NOTE: Several turns may be required.

- Tighten the 11/16" locking nut with the wrench tool.
- Reattach the base grille if it was dislodged.

HANDLE INSTALLATION AND REMOVAL

PARTS INCLUDED: Door handles (2), 1/8" hex key, spare setscrew(s).

To Install the Handles:

NOTE: The handle mounting setscrews are preinstalled in the handle.

- Remove the handles, which are packed inside the refrigerator.

NOTE: To avoid scratching the finish, place the handles on a towel or other soft surface.

- Open the freezer door. On the refrigerator door, place the handle on the shoulder screws with the setscrews facing the freezer.

LOCATION REQUIREMENTS

⚠ WARNING



Explosion Hazard

Keep flammable materials and vapors, such as gasoline, away from refrigerator.

Failure to do so can result in death, explosion, or fire.

IMPORTANT: This refrigerator is designed for indoor household use only.

To ensure proper ventilation for your refrigerator, allow for 1/2" (1.27 cm) of space on each side and at the top. Allow for 2" (5.08 cm) of space behind the refrigerator. If your refrigerator has an ice maker, allow extra space at the back for the water line connections. When installing your refrigerator next to a fixed wall, leave a 2" (5.08 cm) minimum space on each side (depending on your model) to allow the doors to swing open.

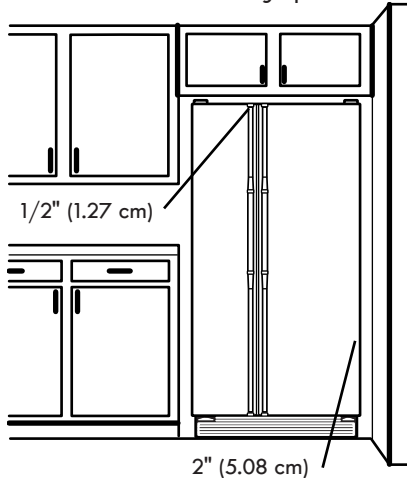

NOTES:

- This refrigerator is intended for use in a location where the temperature ranges from a minimum of 55°F (13°C) to a maximum of 110°F (43°C). The preferred room temperature range for optimum performance, which reduces electricity usage and provides superior cooling, is between 60°F (15°C) and 90°F (32°C). It is recommended that you do not install the refrigerator near a heat source, such as an oven or radiator.
- Normal minimum cabinet cut-out width required for product installation is 36" (91.44 cm). However, if the product is placed against an extended wall and the ability to remove the crisper pans is desired, an additional 18" (45.72 cm) of cabinet width is required, so a total cabinet opening width of 54" (137.16 cm) is recommended.

ELECTRICAL REQUIREMENTS

⚠ WARNING



Electrical Shock Hazard

Plug into a grounded 3 prong outlet.

Do not remove ground prong.

Do not use an adapter.

Do not use an extension cord.

Failure to follow these instructions can result in death, fire, or electrical shock.

Before you move your refrigerator into its final location, it is important to make sure you have the proper electrical connection.

Recommended Grounding Method

A 115 V, 60 Hz, AC only, 15 A or 20 A fused, grounded electrical supply is required. It is recommended that a separate circuit serving only your refrigerator be provided. Use an outlet that cannot be turned off by a switch. Do not use an extension cord.

If the supply cord is damaged it must be replaced by the manufacturer or its service agent or a similarly qualified person. Do not use a cord that shows cracks or abrasion damage along its length, or at either the plug or connector end.

NOTE: Before performing any type of installation or cleaning, or removing a light bulb, disconnect the refrigerator from the electrical source. When you are finished, reconnect the refrigerator to the electrical source and reset the control (Thermostat, Refrigerator or Freezer Control depending on the model) to the desired setting. See the "Using the Controls" section.

WATER SUPPLY REQUIREMENTS

Gather the required tools and parts before starting installation. Read and follow the instructions provided with any tools listed here.

TOOLS NEEDED:

- Flat-blade screwdriver
- 1/4" nut driver
- 7/16" and 1/2" open-end or two adjustable wrenches
- 1/4" drill bit
- Cordless drill

NOTE: Your refrigerator dealer has a kit available with a 1/4" (6.35 mm) saddle-type shutoff valve, a union, and copper tubing. Before purchasing, make sure a saddle-type valve complies with your local plumbing codes. Do not use a piercing-type or 3/16" (4.76 mm) saddle valve which reduces water flow and clogs more easily.

IMPORTANT:

- All installations must meet local plumbing code requirements.
- Use copper tubing and check for leaks. Install copper tubing only in areas where the household temperatures will remain above freezing.

Water Pressure

A cold water supply with water pressure of between 30 psi and 120 psi (207 kPa and 827 kPa) is required to operate the water dispenser and ice maker. If you have questions about your water pressure, call a licensed, qualified plumber.

- If your refrigerator has a water dispenser: After installation is complete, use the water dispenser to check the water pressure.
 - With the water filter removed, dispense 1 cup (237 mL) of water. If 1 cup of water is dispensed in 8 seconds or less, the water pressure to the refrigerator meets the minimum requirement.
 - If it takes longer than 8 seconds to dispense 1 cup of water, the water pressure to the refrigerator is lower than recommended. See the “Troubleshooting” section for suggestions.

Reverse Osmosis Water Supply

IMPORTANT: The pressure of the water supply coming out of a reverse osmosis system going to the water inlet valve of the refrigerator needs to be between 30 psi and 120 psi (207 kPa and 827 kPa).

If a reverse osmosis water filtration system is connected to your cold water supply, the water pressure to the reverse osmosis system needs to be a minimum of 40 psi to 60 psi (276 kPa to 414 kPa).

If the water pressure to the reverse osmosis system is less than 40 psi to 60 psi (276 kPa to 414 kPa):

- Check to see whether the sediment filter in the reverse osmosis system is blocked. Replace the filter if necessary.
- Allow the storage tank on the reverse osmosis system to refill after heavy usage.
- If your refrigerator has a water filter, it may further reduce the water pressure when used in conjunction with a reverse osmosis system. Remove the water filter. See the “Water Filtration System” section in the User Instructions, User Guide, or Use & Care Guide.

If you have questions about your water pressure, call a licensed, qualified plumber.

CONNECT WATER SUPPLY

Read all directions before you begin.

IMPORTANT:

- Connect to potable water supply only.

Do not use with water that is microbiologically unsafe or of unknown quality without adequate disinfection before or after the system. Systems certified for cyst reduction may be used on disinfected waters that may contain filterable cysts.

- Plumbing shall be installed in accordance with the International Plumbing Code and any local codes and ordinances.
- The gray water tubing on the back of the refrigerator (which is used to connect to the household water line) is a Plastic (cross-linked polyethylene) tube. Copper and Plastic tubing connections from the household water line to the refrigerator are acceptable, and will help avoid off-taste or odor in your ice or water. Check for leaks.
- Install tubing only in areas where temperatures will remain above freezing.

TOOLS NEEDED:

Gather the required tools and parts before starting installation.

- Flat-blade screwdriver
- 7/16" and 1/2" open-end wrenches or two adjustable wrenches
- 1/4" nut driver

Connect to Water Line

IMPORTANT: If you turn the refrigerator on before the water line is connected, turn the ice maker off.

Style 1 (Recommended)

1. Unplug refrigerator or disconnect power.
2. Turn off main water supply. Turn on nearest faucet long enough to clear line of water.
3. Use a quarter-turn shutoff valve or the equivalent, served by a 1/2" (12.7 mm) copper household supply line.

NOTE: To allow sufficient water flow to the refrigerator, a minimum 1/2" (12.7 mm) size copper household supply line is recommended.

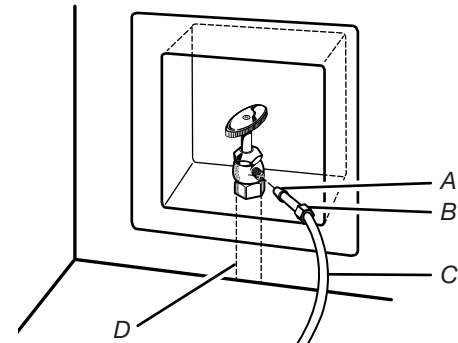

A. Compression sleeve
B. Compression Nut
C. Copper tubing
D. Household supply line (1/2" [12.7 mm] minimum)

4. Now you are ready to connect the copper tubing to the shutoff valve. Use 1/4" (6.35 mm) O.D. (outside diameter) soft copper tubing to connect the shutoff valve and the refrigerator.
 - Ensure that you have the proper length needed for the job. Be sure both ends of the copper tubing are cut square.
 - Slip compression sleeve and compression nut onto copper tubing as shown. Insert end of tubing into outlet end squarely as far as it will go. Screw compression nut onto outlet end with adjustable wrench. Do not overtighten.

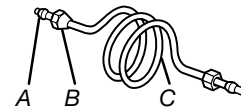

A. Compression sleeve
B. Compression nut
C. Copper tubing

5. Place the free end of the tubing into a container or sink, and turn on main water supply to flush out tubing until water is clear. Turn off shutoff valve on the water pipe.

NOTE: Always drain the water line before making the final connection to the inlet of the water valve, to avoid possible water valve malfunction.
6. Bend the copper tubing to meet the water line inlet, which is located on the back of the refrigerator cabinet as shown. Leave a coil of copper tubing to allow the refrigerator to be pulled out of the cabinet or away from the wall for service.

Style 2

1. Unplug refrigerator or disconnect power.
2. Turn off main water supply. Turn on nearest faucet long enough to clear line of water.
3. Locate a 1/2" (12.7 mm) to 1 1/4" (3.18 cm) vertical cold water pipe near the refrigerator.

IMPORTANT:

- Make sure it is a cold water pipe.
- Horizontal pipe will work, but drill on the topside of the pipe, not the bottom. This will help keep water away from the drill and normal sediment from collecting in the valve.

4. Determine the length of copper tubing you need. Measure from the connection on the lower rear corner of refrigerator to the water pipe. Add 7 ft (2.1 m) to allow for cleaning. Use 1/4" (6.35 mm) O.D. (outside diameter) copper tubing. Be sure both ends of copper tubing are cut square.
5. Using a cordless drill, drill a 1/4" (6.35 mm) hole in the cold water pipe you have selected.

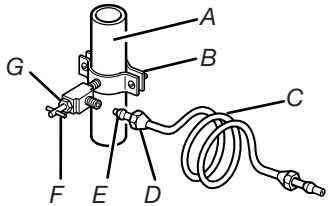

- | | |
|--------------------|-----------------------|
| A. Cold water pipe | E. Compression sleeve |
| B. Pipe clamp | F. Shutoff valve |
| C. Copper tubing | G. Packing nut |
| D. Compression nut | |

6. Fasten the shutoff valve to the cold water pipe with the pipe clamp. Be sure the outlet end is solidly in the 1/4" (6.35 mm) drilled hole in the water pipe and that the washer is under the pipe clamp. Tighten the packing nut. Tighten the pipe clamp screws slowly and evenly so the washer makes a watertight seal. Do not overtighten, or you may crush the copper tubing.
7. Slip the compression sleeve and compression nut on the copper tubing as shown. Insert the end of the tubing into the outlet end squarely as far as it will go. Screw the compression nut onto outlet end with adjustable wrench. Do not overtighten.
8. Place the free end of the tubing in a container or sink, and turn on the main water supply. Flush the tubing until water is clear. Turn off the shutoff valve on the water pipe. Coil the copper tubing.

Connect to Refrigerator

Style 1

1. Unplug refrigerator or disconnect power.
2. Remove and discard the short, black plastic part from the end of the water line inlet.
3. Thread the nut onto the end of the tubing. Tighten the nut by hand. Then tighten it with a wrench two more turns. Do not overtighten.

NOTE: To avoid rattling, be sure the copper tubing does not touch the cabinet's side wall or other parts inside the cabinet.

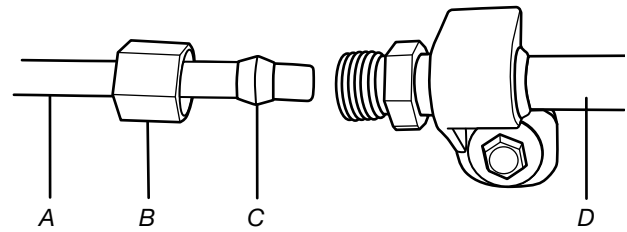

- | | |
|-------------------------|------------------------------|
| A. Household water line | C. Ferrule (purchased) |
| B. Nut (purchased) | D. Refrigerator water tubing |

4. Install the water supply tube clamp around the water supply line to reduce strain on the coupling.
5. Turn shutoff valve on.
6. Check for leaks. Tighten any connections (including connections at the valve) or nuts that leak.

Style 2

1. Unplug refrigerator or disconnect power.
2. Remove and discard the plastic part that is attached to the inlet of the water valve.
3. Attach the copper tube to the valve inlet using a compression nut and sleeve as shown. Tighten the compression nut. Do not overtighten.
4. Use the tube clamp on the back of the refrigerator to secure the tubing to the refrigerator as shown. This will help avoid damage to the tubing when the refrigerator is pushed back against the wall.
5. Turn shutoff valve on.
6. Check for leaks. Tighten any connections (including connections at the valve) or nuts that leak.

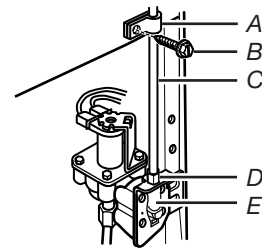

- | | |
|---------------------|--------------------|
| A. Tube clamp | D. Compression nut |
| B. Tube clamp screw | E. Valve nut |
| C. Copper tubing | |

7. On some models, the ice maker is equipped with a built-in water strainer. If your water conditions require a second water strainer, install it in the 1/4" (6.35 mm) water line at either tube connection. Obtain a water strainer from your nearest appliance dealer.

Style 3

1. Unplug refrigerator or disconnect power.
2. Remove and discard the black nylon plug from the gray water tube on the rear of the refrigerator.
3. If the gray water tube supplied with the refrigerator is not long enough, a 1/4" x 1/4" (6.35 mm x 6.35 mm) coupling is needed in order to connect the water tubing to an existing household water line. Thread the provided nut onto the coupling on the end of the copper tubing.

NOTE: Tighten the nut by hand. Then tighten it with a wrench two more turns. Do not overtighten.

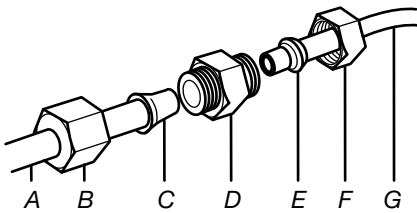

- A. Refrigerator water tubing
- B. Nut (provided)
- C. Bulb
- D. Coupling (purchased)
- E. Ferrule (purchased)
- F. Nut (purchased)
- G. Household water line

4. Turn shutoff valve on.
5. Check for leaks. Tighten any nuts or connections (including connections at the valve) that leak.

Complete the Installation

⚠ WARNING



Electrical Shock Hazard

- Plug into a grounded 3 prong outlet.
- Do not remove ground prong.
- Do not use an adapter.
- Do not use an extension cord.
- Failure to follow these instructions can result in death, fire, or electrical shock.

1. Plug into a grounded 3 prong outlet.
2. Flush the water system. See “Water and Ice Dispensers” section in User Instructions or User Guide.
NOTE: Allow 24 hours to produce the first batch of ice. Allow 72 hours to completely fill ice container.

PREPARE THE WATER SYSTEM

Please read before using the water system. Immediately after installation, follow the steps below to make sure that the water system is properly cleaned.

1. Open the freezer door and turn off the ice maker. See the “Ice Maker and Storage Bin” section.

NOTE: If your model has a water filter, make sure the filter is properly installed. See the “Water Filtration System” section.

Do not use with water that is microbiologically unsafe or of unknown quality without adequate disinfection before or after the system. Systems certified for cyst reduction may be used on disinfected waters that may contain filterable cysts.

2. Flush the water system. Use a sturdy container to depress and hold the water dispenser lever for 5 seconds, and then release it for 5 seconds. Repeat until water begins to flow. Once water begins to flow, continue depressing and releasing the dispenser lever (5 seconds on, 5 seconds off) until a total of 3 gal. (12 L) has been dispensed. This will flush air from the filter and water dispensing system and prepare the water filter for use. Additional flushing may be required in some households. As air is cleared from the system, water may spurt out of the dispenser.
3. Open the freezer door and turn on the ice maker. See the “Ice Maker and Storage Bin” section.
 - Allow 24 hours to produce the first batch of ice.
 - Discard the first three batches of ice produced.

REFRIGERATOR USE

ENSURING PROPER AIR CIRCULATION

In order to ensure proper temperatures, you need to permit air to flow between the two sections. Cold air enters the bottom of the freezer section and moves up. It then enters the refrigerator section through the top vent. Air then returns to the freezer as shown.

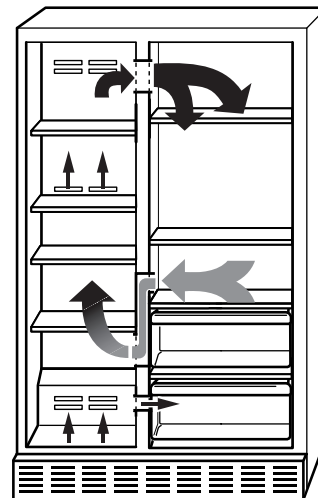

Do not block any airflow vents. If the vents are blocked, airflow will be obstructed and temperature and moisture problems may occur.

IMPORTANT: Because air circulates between both sections, any odors formed in one section will transfer to the other. You must thoroughly clean both sections to eliminate odors. To avoid odor transfer and drying out of food, wrap or cover foods tightly.

USING THE CONTROLS

For your convenience, your refrigerator controls are preset at the factory. When you first install your refrigerator, make sure that the controls are still preset. The Refrigerator Control and the Freezer Control should both be set to the "mid-settings".

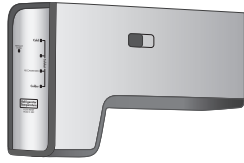

REFRIGERATOR

FREEZER

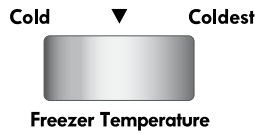

IMPORTANT:

The Refrigerator Control adjusts the refrigerator compartment temperature. Every click on Refrigerator Temperature button makes refrigerator compartment more colder, once you get the last level the system will back to the initial level.

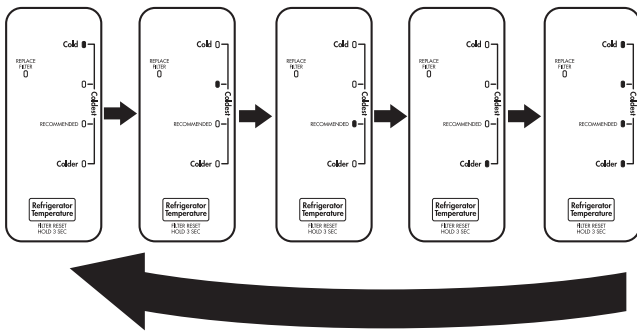

- The Freezer Control adjusts the freezer compartment temperature. Settings to the front of the mid-setting make the temperature less cold. Settings to the back of the mid-setting make the temperature colder.
- Wait 24 hours before you put food into the refrigerator. If you add food before the refrigerator has cooled completely, your food may spoil.

NOTE: Adjusting the Refrigerator and Freezer Controls to a higher (colder) than recommended setting will not cool the compartments any faster.

Adjusting the Controls

Give the refrigerator time to cool down completely before adding food. It is best to wait 24 hours before you put food into the refrigerator. The settings indicated in the previous section should be correct for normal household refrigerator usage. The controls are set correctly when milk or juice is as cold as you like and when ice cream is firm.

If you need to adjust temperatures in the refrigerator or freezer, use the settings listed in the chart below as a guide. Wait at least 24 hours between adjustments. Recheck the temperatures before other adjustments are made.

Condition/Reason:	Adjustment:
Refrigerator too warm	Refrigerator control one setting higher
Freezer too warm/ too little ice	Freezer control one setting higher
Refrigerator too cold	Refrigerator control one setting lower
Freezer too cold	Freezer control one setting lower

WATER AND ICE DISPENSERS

Depending on your model, you may have one or more of the following options: the ability to select either crushed or cubed ice, a special light that turns on when you use the dispenser, or a lock option to avoid unintentional dispensing.

NOTES:

- The dispensing system will not operate when either door (refrigerator or freezer) is open.
- Allow 24 hours for the refrigerator to cool down and chill water.
- Allow 24 hours to produce the first batch of ice. Discard the first three batches of ice produced. Wait 72 hours for full ice production. Also, take large amounts of ice from the ice bin rather than through the dispenser.

Flush the Water System

Air in the water dispensing system can cause the water dispenser to drip. After connecting the refrigerator to a water source or replacing the water filter, flush the water system. Flushing the water dispensing system forces air from the water line and filter, and prepares the water filter for use.

NOTE: As air is cleared from the system, water may spurt out of the dispenser.

1. Using a sturdy container, depress and hold the water dispenser lever for 5 seconds, and then release it for 5 seconds.
2. Repeat Step 1 until water begins to flow.
3. Once water begins to flow, continue depressing and releasing the dispenser lever (5 seconds on, 5 seconds off) until a total of 3 gal. (12 L) has been dispensed.

Additional flushing may be required in some households.

The Water Dispenser

IMPORTANT:

- Dispense at least 1 qt (1 L) of water every week to maintain a fresh supply.
- If the flow of water from the dispenser decreases, it could be caused by low water pressure.
 - With the water filter removed, dispense 1 cup (237 mL) of water. If 1 cup (237 mL) of water is dispensed in 8 seconds or less, the water pressure to the refrigerator meets the minimum requirement.
 - If it takes longer than 8 seconds to dispense 1 cup (237 mL) of water, the water pressure to the refrigerator is lower than recommended. See the "Water Supply Requirements" or "Troubleshooting" sections for suggestions.

To Dispense Water:

1. Press a sturdy glass against the water dispenser lever. Hold the glass close to the water dispenser spout to ensure that the water dispenses into the glass.
2. Remove the glass to stop dispensing.

IMPORTANT: The small tray at the bottom of the dispenser is designed to catch small spills and allow for easy cleaning. There is no drain in the tray.

The Ice Dispenser

Ice dispenses from the ice maker storage bin in the freezer when the dispenser lever is pressed. To turn off the ice maker, see the “Ice Maker and Storage Bin” section.

Your ice maker can produce both crushed and cubed ice. Before dispensing ice, select which type of ice you prefer.

- Press **CRUSHED ICE** for crushed ice, or **CUBED ICE** for cubed ice.



For crushed ice, cubes are crushed before being dispensed. This may cause a slight delay when dispensing crushed ice. Noise from the ice crusher is normal, and pieces of ice may vary in size. When changing from crushed to cubed, a few ounces of crushed ice will be dispensed along with the first cubes.

To Dispense Ice:

1. Press the button to select the desired type of ice.

⚠ WARNING



Cut Hazard

Use a sturdy glass when dispensing ice.

Failure to do so can result in cuts.

2. Press a sturdy glass against the ice dispenser lever. Hold the glass close to the ice guide to ensure that the ice dispenses into the glass.

IMPORTANT: You do not need to apply a lot of pressure to the lever in order to activate the ice dispenser. Pressing hard will not make the ice dispense faster or in greater quantities.

3. Remove the glass to stop dispensing.

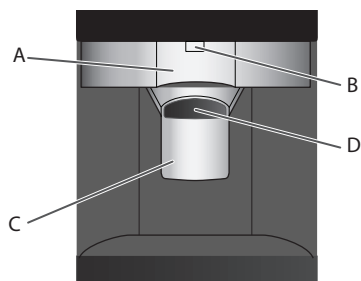

- A. Water dispenser lever C. Ice dispenser lever
B. Water dispenser spout D. Ice guide

The Dispenser Light

On some models, the dispenser light will automatically turn on when you use the dispenser.

- If you want the light to be on continuously, press **LIGHT ON**. To turn the light back off, press **LIGHT OFF**.



The dispenser lights are LEDs that cannot be changed. If it appears that your dispenser lights are not working, see the “Troubleshooting” section for more information.

The Dispenser Lock

The dispenser can be turned off for easy cleaning or to avoid unintentional dispensing by small children and pets.

NOTE: The lock feature does not shut off power to the refrigerator, to the ice maker, or to the dispenser light. It simply deactivates the dispenser lever. To turn off the ice maker, see the “Ice Maker and Storage Bin” section.



- To lock the dispenser, press **LOCK**. To unlock the dispenser, press **UNLOCK**.

WATER FILTRATION SYSTEM

Do not use with water that is microbiologically unsafe or of unknown quality without adequate disinfection before or after the system. Systems certified for cyst reduction may be used on disinfected waters that may contain filterable cysts.

Water Filter Status Light (on some models)

The filter status light will help you know when to change your water filter, this is located in the refrigerator control panel.

- The light will turn on red. This tells you that it is almost time to change the filter.
- It is recommended that you replace the filter when the status light changes to red or water flow to your water dispenser or ice maker decreases noticeably.

NOTE: The filter should be replaced at least every 6 months depending on your water quality and usage.

Resetting the Filter Status

- The reset button is located on the control panel in the refrigerator compartment. To reset the status light after changing the filter, press the button Refrigerator Temperature within 3 seconds. The status light will change from red to off when the system is reset.

Changing the Water Filter

Style 1

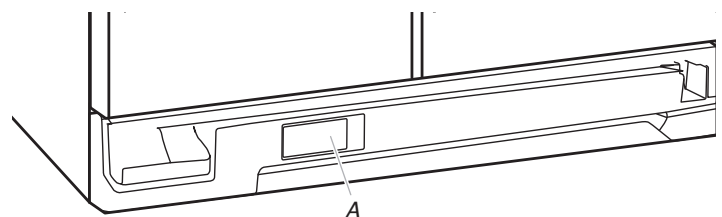

A. Water filter cover door

1. Locate the water filter cover door in the base grille, and pull open the filter door. The filter will be released and then be ejected as the door is opened.

- When the door is completely open, pull the filter straight out.

NOTE: There may be some water in the filter. Some spilling may occur. Use a towel to wipe up any spills.

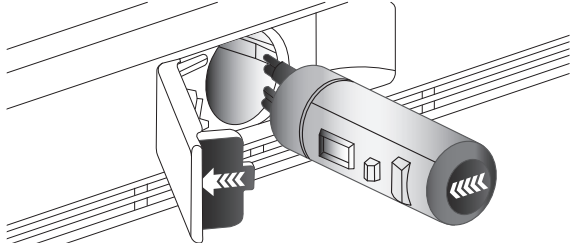

- Take the new filter out of its packaging and remove the covers from the O-rings. Be sure the O-rings are still in place after the covers are removed.
- With the arrow pointing to the left (toward the filter cover door's hinge), align the new filter with the filter housing and slide it into place. The filter cover door will automatically begin to close as the new filter is inserted.
- Close the filter cover door completely in order to snap the filter into place. You may need to press hard.
- Flush the system. See the "Water and Ice Dispensers" section in User Instructions or User Guide.

Style 2

- Locate the water filter cover door in the base grille, and pull open the filter door.

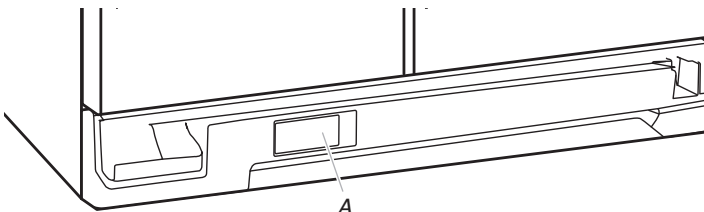

A. Water filter cover door.

- Twist the water filter and turn 90° counterclockwise to unlock.

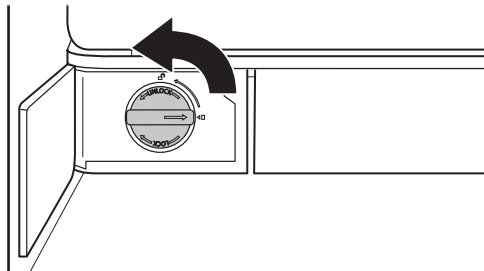

- Pull the filter out of the housing.

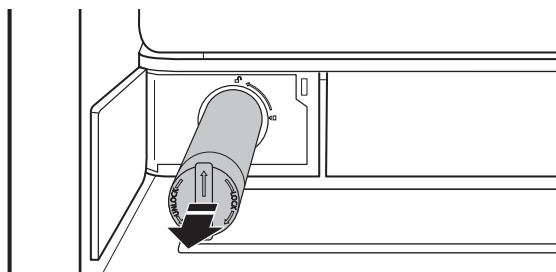

- Remove the water filter cap from the water filter.

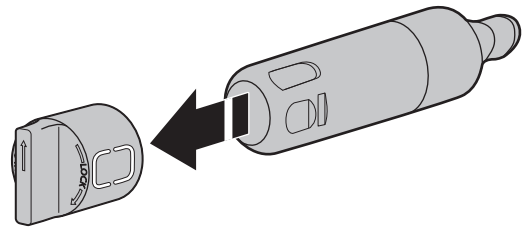

- Install the water filter cap onto the new filter. Be sure to align the arrows so the grooves in the filter align with the ribs in the filter cap.

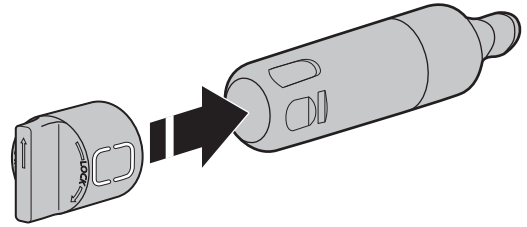

- Insert the filter into the housing.

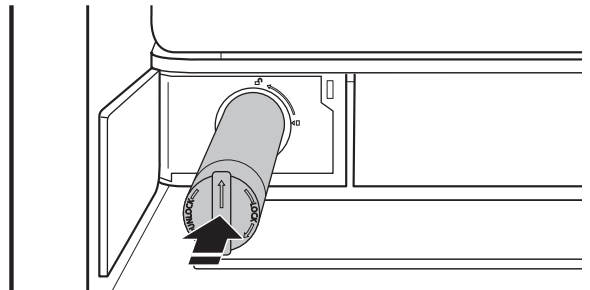

- Twist the water filter and turn 90° clockwise until it locks into place and the arrows are aligned.

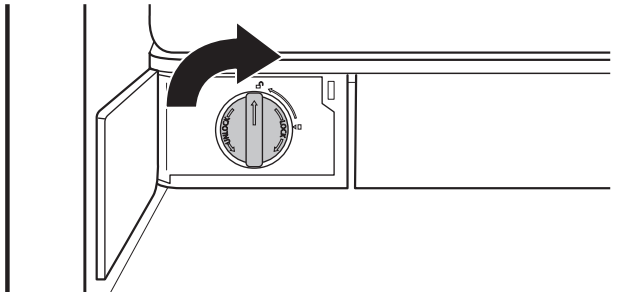

- Push the water filter door closed.

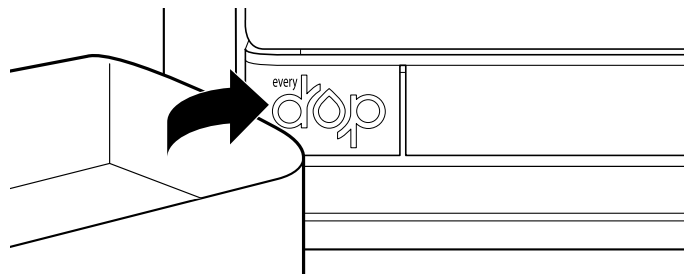

ICE MAKER AND STORAGE BIN

- Allow 24 hours to produce the first batch of ice. Discard the first three batches of ice produced.
- The quality of your ice will be only as good as the quality of the water supplied to your ice maker. Avoid connecting the ice maker to a softened water supply. Water softener chemicals (such as salt) can damage parts of the ice maker and lead to poor quality ice. If a softened water supply cannot be avoided, make sure the water softener is operating properly and is well maintained.
- Do not use anything sharp to break up the ice in the storage bin. This can cause damage to the ice container and the dispenser mechanism.
- Do not store anything on top of or in the ice maker or storage bin.

Turning the Ice Maker On/Off

Style 1

- To turn on the ice maker, lift open the ice maker door and lower the wire shutoff arm to the On (down) position.
- To manually turn off the ice maker, lift the wire shutoff arm to the Off (arm up) position and listen for the click. Ice can still be dispensed, but no more can be made.

NOTE: Your ice maker has an automatic shutoff. As ice is made, the ice cubes will fill the ice storage bin, and the ice cubes will raise the wire shutoff arm to the Off (arm up) position. Do not force the wire shutoff arm up or down.

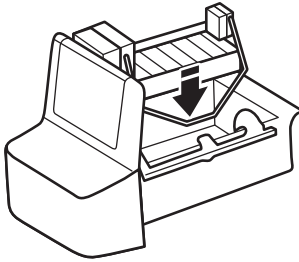

Removing and Replacing the Ice Storage Bin

1. Lift and hold open the ice maker door.
2. Lift the wire shutoff arm so it clicks into the Off (up) position. Release the ice maker door.
3. Lift up the front of the storage bin and pull it out.
4. Replace the bin by pushing it in all the way, or the dispenser will not work.
5. To restart ice production, lift open the ice maker door and push the wire shutoff arm down to the On position.

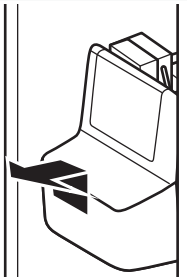

Style 2

The On/Off switch is located on the bottom of the Ice Maker and can be accessed by lifting and opening the ice maker door.

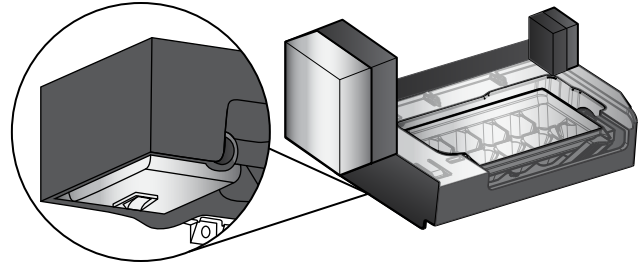

- To turn on the ice maker, lift open the ice maker door switch to the On (right) position.
- To manually turn off the ice maker, lift open the ice maker switch to the Off (left) position. Ice can still be dispensed, but no more can be made.

NOTE: Your ice maker has an automatic shutoff to keep the storage bin from overflowing during normal operation. As ice is made, the ice cubes will fill the ice storage bin, and the ice cubes will raise the shutoff arm to the Off (arm up) position. When the storage bin is at full capacity, the ice maker will automatically stop ice production, but the ice maker On/Off switch will remain in the On (down) position.

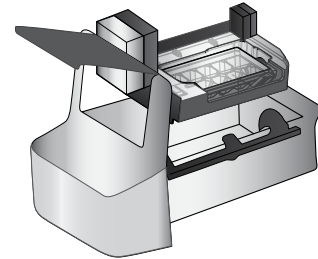

Removing and Replacing the Ice Storage Bin

1. Pull the covering panel up from the bottom.
2. Lift the plastic shutoff arm so it clicks into the Off (up) position.
3. Lift up the front of the storage bin and pull it out.
4. Replace the bin by pushing it in all the way or the dispenser will not work.
5. To restart ice production, lower the plastic shutoff arm into the On (down) position. Make sure the door is closed tightly.

REFRIGERATOR FEATURES

Your model may have some or all of these features.

Important information to know about glass shelves and covers:

Do not clean glass shelves or covers with warm water when they are cold. Shelves and covers may break if exposed to sudden temperature changes or impact, such as bumping. Tempered glass is designed to shatter into many small, pebble-size pieces. This is normal. Glass shelves and covers are heavy. Use both hands when removing them to avoid dropping.

REFRIGERATOR SHELVES

(number of shelves varies by model)

Store similar foods together and adjust the shelves to fit different heights. This reduces the time the refrigerator door is open and saves energy.

To Remove and Replace a Shelf:

1. Lift the back of the shelf to remove from the ribs. Pull the shelf forward until it is released.
2. Replace the shelf by aligning the shelf with the ribs. Slide the shelf onto the shelf supports. Be sure that the shelf is securely in position.

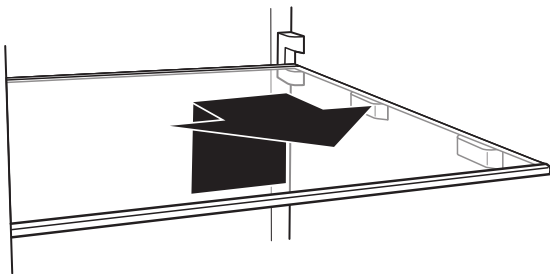

DELI DRAWER

(on some models)

The deli drawer stores raisins, nuts, spreads, and other small items at normal refrigerator temperatures.

To Remove and Replace the Deli Drawer:

1. Remove the deli drawer by sliding it straight out to the stop. Lift the front and out of the ribs. Tilt the drawer sideways to remove it from the refrigerator compartment.
2. Replace the deli drawer by sliding it back past the stop and pushing it into place.

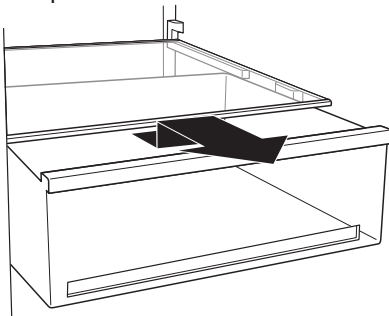

CONVERTIBLE VEGETABLE/MEAT DRAWER, CRISPER AND COVERS

(on some models)

Crisper and Convertible Vegetable/Meat Drawers

To Remove and Replace Drawers:

1. Slide crisper or meat drawer straight out to the stop. Lift the front of drawer with one hand while supporting the bottom of drawer with the other hand and slide the drawer out the rest of the way.
2. Replace the crisper or meat drawer by sliding it back in fully past the drawer stop.

Crisper and Convertible Vegetable/Meat Drawer Covers

To Remove and Replace Covers:

1. Remove the crisper and meat drawer. Tilt the front of the shelf up and pull to release the stoppers from the ribs. Pull the cover forward until it is released. Repeat steps to remove the meat drawer cover.
2. Replace the meat drawer cover into supports or slides on sidewalls of the refrigerator and slide the front of the cover frame into place. Repeat steps to replace the crisper cover.

Meat Storage Guide

Store most meat in original wrapping as long as it is airtight and moisture-proof. Rewrap if necessary. See the following chart for storage times. When storing meat longer than the times given, freeze the meat.

Fresh fish or shellfish	Use same day as purchased
Chicken, ground beef, variety meat (liver, etc.)	1-2 days
Cold cuts, steaks/roasts	3-5 days
Cured meats	7-10 days

Leftovers: Cover leftovers with plastic wrap, aluminum foil, or plastic containers with tight lids.

CRISPER HUMIDITY CONTROL

(on some models)

You can control the amount of humidity in the moisture-sealed crisper. Adjust the control to any setting between Fruit (left side) and Vegetables (right side).

Fruit | | | | | | | Vegetables
 - Humidity Control +

Fruit (left side, open) lets moist air out of the crisper for best storage of fruits and vegetables with skins.

- Fruit: Wash, let dry and store in refrigerator in plastic bag or crisper. Do not wash or hull berries until they are ready to use. Sort and keep berries in original container in crisper, or store in a loosely closed paper bag on a refrigerator shelf.
- Vegetables with skins: Place in plastic bag or plastic container and store in crisper.

Vegetables (right side, closed) keeps moist air in the crisper for best storage of fresh, leafy vegetables.

- Leafy vegetables: Wash in cold water, drain and trim or tear off bruised and discolored areas. Place in plastic bag or plastic container and store in crisper.

FREEZER FEATURES

Your model may have some or all of these features.

Frozen Food Storage Guide

Storage times will vary according to the quality and type of food, the type of packaging or wrap used (should be airtight and moisture-proof), and the storage temperature. Ice crystals inside a sealed package are normal. This simply means that moisture in the food and air inside the package have condensed, creating ice crystals.

Put no more unfrozen food into the freezer than will freeze within 24 hours (no more than 2 to 3 lbs of food per cubic foot [907 to 1,350 g per 28 L] of freezer space). Leave enough space in the freezer for air to circulate around packages. Be certain to leave enough room for the door to close tightly.

For more information on preparing food for freezing, check a freezer guide or reliable cookbook.

FREEZER SHELF

(number of shelves varies by model)

To Remove and Replace the Bottom Shelf:

1. Lift up the front and back of the shelf, and remove from the cabinet. Be sure not to remove the retaining rods.
2. Replace the shelf aligning the rods with the cabinet ribs. Apply a little pressure on the shelf to attach the rods to the ribs of the cabinet.

To Remove and Replace the Mid and Top Shelf:

1. With your hand, push the shelf from bottom to top until it is released from the holding rod. Pull the shelf until it is released from the rear rod. Remove from the cabinet.
2. To replace the shelf:
 - Replace rods into the support holes. Push the rods down so it clicks into the hole.
 - Identify the front and rear trim of the shelf.

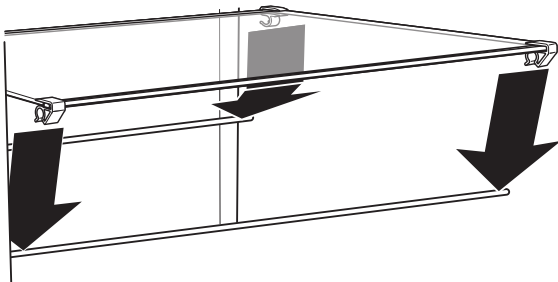

- Place the rear trim on the rear rod and push the shelf so it clicks the rod into the trim rear. (Keep the front raised while pushing).
- Lower the front of the shelf until the front trim is on the rod and push the shelf down so it clicks the rod into the trim rear.

NOTE: Be sure that both sides of the shelf are positioned evenly in the shelf support holes and the shelf is secure.

FREEZER BIN

(on some models)

The freezer bin can be used to store bags of frozen fruits and vegetables that may slide off freezer shelves.

To Remove and Replace the Freezer Bin:

1. Remove the bin by sliding it out to the stop. Lift the front to slide the bin out the rest of the way.

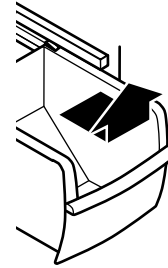

2. Replace the bin by positioning it on the rails. Lift the bin front slightly while pushing it in fully past the stops.

DOOR FEATURES

Your model may have some or all of these features.

DOOR BINS

(on some models)

To Remove and Replace the Bins:

1. Remove the bin by lifting it and pulling it straight out.
2. Replace the bin by sliding it in above the desired supports and then pushing it down until it stops.

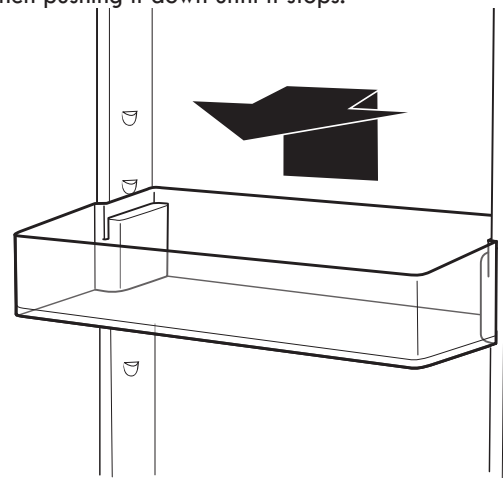

DOOR RAILS OR BINS

(on some models)

The door rails or bins may be removed for easier cleaning.

Snap-On Door Rails or Bins

To Remove and Replace the Rails or Bins:

1. Remove the rails or bins by pushing in slightly on the front of the bracket while pulling out on the inside tab. Repeat these steps for the other end of the rail or bin.
2. Replace the rails or bins by aligning the ends of the brackets with the buttons on the sides of the door liner. Firmly snap bracket onto the tabs above the shelf as shown.

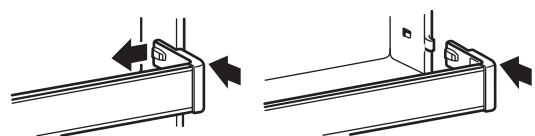

Drop-In Door Rails

To Remove and Replace the Rails:

1. Remove the rails by pulling straight up on each end of the rail.
2. Replace the rails by sliding the shelf rail into the slots on the door and pushing the rail straight down until it stops.

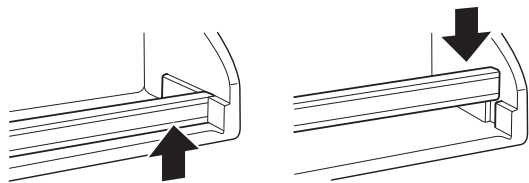

REFRIGERATOR CARE

CLEANING

WARNING



Explosion Hazard

Use nonflammable cleaner.

Failure to do so can result in death, explosion, or fire.

Both the refrigerator and freezer sections defrost automatically. However, clean both compartments about once a month to avoid buildup of odors. Wipe up spills immediately.

To Clean Your Refrigerator:

1. Unplug refrigerator or disconnect power.
2. Remove all removable parts from inside, such as shelves, crispers, etc.
3. Hand wash, rinse, and dry removable parts and interior surfaces thoroughly. Use a clean sponge or soft cloth and a mild detergent in warm water.
 - Do not use abrasive or harsh cleaners such as window sprays, scouring cleansers, flammable fluids, cleaning waxes, concentrated detergents, bleaches or cleansers containing petroleum products on plastic parts, interior and door liners or gaskets. Do not use paper towels, scouring pads, or other harsh cleaning tools. These can scratch or damage materials.
 - To help remove odors, you can wash interior walls with a mixture of warm water and baking soda (2 tbs to 1 qt [26 g to 0.95 L] of water).
4. Determine whether your refrigerator exterior is painted metal, Ultra Satin™ (stainless look) finish, brushed aluminum or stainless steel, and choose the appropriate cleaning method.

NOTE: Ultra Satin™ (stainless look) finish has a smooth, uniform color with a glossy finish that resists fingerprints. Stainless steel has a distinct grainy texture with variation in color that is natural to steel.

Painted metal: Wash exteriors with a clean sponge or soft cloth and a mild detergent in warm water. Do not use abrasive or harsh cleaners, or cleaners designed for stainless steel. Dry thoroughly with a soft cloth. Additionally, to avoid damage to painted metal exteriors, apply appliance wax (or auto paste wax) with a clean, soft cloth. Do not wax plastic parts.

Brushed aluminum: Wash with a clean sponge or soft cloth and a mild detergent in warm water. Do not use abrasive or harsh cleaners, or cleaners designed for stainless steel. Dry thoroughly with a soft cloth.

Ultra Satin™ (stainless look) finish: Wash with a clean sponge or soft cloth and a mild detergent in warm water. Do not use abrasive or harsh cleaners, or cleaners designed for stainless steel. Dry thoroughly with a soft cloth.

Stainless steel finish: Wash with a clean sponge or soft cloth and a mild detergent in warm water. Do not use abrasive or harsh cleaners. Dry thoroughly with a soft cloth.

- To keep your stainless steel refrigerator looking like new and to remove minor scuffs or marks, it is suggested that you use the manufacturer's approved Stainless Steel Cleaner and Polish. To order the cleaner, see the "Accessories" section.

IMPORTANT: This cleaner is for stainless steel parts only.

- Do not allow the Stainless Steel Cleaner and Polish to come into contact with any plastic parts such as the trim pieces, dispenser covers or door gaskets. If unintentional contact does occur, clean plastic part with a sponge and mild detergent in warm water. Dry thoroughly with a soft cloth.
5. If your model has a touch screen display on the dispenser panel, clean the screen using a soft, lint-free cloth. Mix a mild detergent with water, then use the mixture to dampen the cloth and gently wipe the screen.
 - To avoid unintentionally changing settings, make sure the refrigerator is unplugged or the power is disconnected before wiping the screen.
 - Do not over-saturate the cloth. Do not spray or wipe liquids directly onto the screen. Do not use abrasive or harsh cleaners such as window sprays, scouring cleansers, flammable fluids, cleaning waxes, concentrated detergents, nail polish remover, bleaches or cleansers containing petroleum products. Do not use paper towels, scouring pads, or other harsh cleaning tools. These can scratch or damage materials.

WARNING



Explosion Hazard

Risk of fire or explosion due to puncture of refrigerant tubing.

Follow handling instructions carefully. Flammable refrigerant used.

6. There is no need for routine condenser cleaning in normal home operating environments. If the environment is particularly greasy or dusty, or there is significant pet traffic in the home, the condenser should be cleaned every 2 to 3 months to ensure maximum efficiency.

If you need to clean the condenser:

 - Remove the base grille. See the "Base Grille" graphic or "Base Grille" section.
 - Use a vacuum cleaner with a soft brush to clean the grille, the open areas behind the grille and the front surface area of the condenser.
 - Replace the base grille when finished.
7. Plug in refrigerator or reconnect power.

LIGHTS

NOTE: Not all appliance bulbs will fit your refrigerator. Be sure to replace the bulb with one of the same size and shape.

- The dispenser lights are LEDs that cannot be changed.
- On some models, the interior lights are LEDs that cannot be changed.
- On some models, the interior lights require a 40-watt bulb.

1. Unplug refrigerator or disconnect power.
2. Remove light shield when applicable, as explained in the following sections.

NOTE: To clean the light shield, wash it with warm water and liquid detergent. Rinse and dry the shield well.

3. Remove light bulb and replace with one of the same size, shape and wattage.
4. Replace light shield when applicable as shown.
5. Plug in refrigerator or reconnect power.

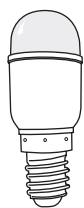

Part Number
W10574850A
(2.0 W)

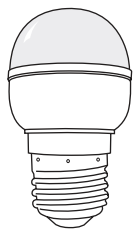

Part Number
W10565137A
(3.6 W)

POWER INTERRUPTIONS

If the power will be out for 24 hours or less, keep the door or doors closed (depending on your model) to help food stay cold and frozen.

If the power will be out for more than 24 hours, do one of the following:

- Remove all frozen food and store it in a frozen food locker.
- Place 2 lbs (907 g) of dry ice in the freezer for every cubic foot (28 L) of freezer space. This will keep the food frozen for 2 to 4 days.
- If neither a food locker nor dry ice is available, consume or can perishable food at once.

REMEMBER: A full freezer stays cold longer than a partially filled one. A freezer full of meat stays cold longer than a freezer full of baked goods. If you see that food contains ice crystals, it may be refrozen, although the quality and flavor may be affected. If the condition of the food is poor, dispose of it.

VACATION AND MOVING CARE

Vacations

If You Choose to Leave Refrigerator On While You Are Away:

1. Use up any perishables and freeze other items.
2. If your refrigerator has an automatic ice maker and is connected to the household water supply, turn off the water supply to the refrigerator. Property damage can occur if the water supply is not turned off.
3. If you have an automatic ice maker, turn off the ice maker.

NOTE: Depending on your model, raise the wire shutoff arm to the Off (up) position or press the switch to Off.

4. Empty the ice bin.

If You Choose to Turn Refrigerator Off Before You Leave:

1. Remove all food from the refrigerator.
2. If your refrigerator has an automatic ice maker:
 - Turn off the water supply to the ice maker at least one day ahead of time.
 - When the last load of ice drops, raise the wire shutoff arm to the Off (arm up) position or move the switch to the Off (left) setting.
3. Unplug refrigerator.
4. Clean, wipe, and dry thoroughly.
5. Tape rubber or wood blocks to the tops of both doors to prop them open far enough for air to get in. This stops odor and mold from building up.

Moving

When you are moving your refrigerator to a new home, follow these steps to prepare it for the move.

1. If your refrigerator has an automatic ice maker:
 - Turn off the water supply to the ice maker at least one day ahead of time.
 - Disconnect the water line from the back of the refrigerator.
 - When the last load of ice drops, raise the wire shutoff arm to the Off (arm up) position or move the switch to the Off setting.
2. Remove all food from the refrigerator and pack all frozen food in dry ice.
3. Empty the ice bin.
4. Unplug refrigerator.
5. Clean, wipe, and dry thoroughly.
6. Take out all removable parts, wrap them well, and tape them together so they don't shift and rattle during the move.
7. Depending on the model, raise the front of the refrigerator so it rolls more easily or screw in the leveling legs so they don't scrape the floor. See the "Adjust the Doors" or the "Door Removal, Leveling, and Alignment" sections.
8. Tape the doors closed and tape the power cord to the back of the refrigerator.

When you get to your new home, put everything back and refer to the Installation Instructions for preparation instructions. Also, if your refrigerator has an automatic ice maker, remember to reconnect the water supply to the refrigerator.

TROUBLESHOOTING

First try the solutions suggested here or visit our website to possibly avoid the cost of a service call.

⚠ WARNING



Electrical Shock Hazard

Plug into a grounded 3 prong outlet.
Do not remove ground prong.
Do not use an adapter.
Do not use an extension cord.
Failure to follow these instructions can result in death, fire, or electrical shock.

⚠ WARNING



Explosion Hazard

Use nonflammable cleaner.
Failure to do so can result in death, explosion, or fire.

⚠ WARNING



Explosion Hazard

Risk of fire or explosion due to puncture of refrigerant tubing.
Follow handling instructions carefully. Flammable refrigerant used.

⚠ DANGER



Explosion Hazard

Risk of fire or explosion. Flammable refrigerant used.
Do not use mechanical devices to defrost refrigerator.
Do not puncture refrigerant tubing.

GENERAL OPERATION

Possible Causes and/or Recommended Solutions

Refrigerator will not operate

- **Not connected to an electrical supply:** Plug the power cord into a grounded 3 prong outlet. Do not use an extension cord.
 - **No power to the electrical outlet:** Plug in a lamp to see if the outlet is working.
 - **Household fuse has blown or circuit breaker has tripped:** Replace the fuse or reset the circuit breaker. If the problem continues, contact a licensed electrician.
 - **New installation:** Following installation, allow 24 hours for the refrigerator and freezer to cool completely.
- NOTE:** Adjusting the temperature control(s) to the coldest setting will not cool either compartment (refrigerator or freezer) more quickly.

Motor seems to run too much

- **Your new refrigerator has an energy-efficient motor:** The refrigerator may run longer than you're used to, because the compressor and fans operate at lower speeds that are more energy-efficient. This is normal.
- NOTE:** Your refrigerator may run even longer if the room is warm, a large load of food is added, the doors are opened often, or if a door has been left open.

Refrigerator seems noisy

The compressor in your new refrigerator regulates temperature more efficiently and uses less energy than older models. During various stages of operation, you may hear normal operating sounds that are unfamiliar.

The following noises are normal:

- **Buzzing/Clicking:** Heard when the water valve opens and closes to dispense water or fill the ice maker. If the refrigerator is connected to a water line, this is normal. If the refrigerator is not connected to a water line, turn off the ice maker.
- **Cracking/Crashing:** Heard when ice is ejected from the ice maker mold.
- **Popping:** Heard when the inside walls contract/expand, especially during initial cooldown.
- **Pulsating/Whirring:** Heard when the fans/compressor adjust to optimize performance during normal operation.

GENERAL OPERATION	Possible Causes and/or Recommended Solutions
Temperature is too warm	<ul style="list-style-type: none"> ■ Rattling: Heard when water passes through the water line, or due to the flow of refrigerant. Rattling may also come from items placed on top of the refrigerator. ■ Water running or gurgling: Heard when ice melts during the defrost cycle and water runs into the drain pan. ■ Sizzling: Heard when water drips onto the heater during the defrost cycle. <hr/> <ul style="list-style-type: none"> ■ New installation: Following installation, allow 24 hours for the refrigerator and freezer to cool completely. NOTE: Adjusting the temperature control(s) to the coldest setting will not cool either compartment (refrigerator or freezer) more quickly. ■ Doors are opened often or not closed completely: This allows warm air to enter the refrigerator. Minimize door openings, keep the doors fully closed, and make sure both doors are properly sealed. ■ Air vents are blocked: Remove items that are immediately in front of the vents. ■ Large amount of warm food recently added: Allow several hours for the refrigerator to return to its normal temperature. ■ Controls are not set correctly for the surrounding conditions: Adjust the controls to a colder setting. Check the temperature again in 24 hours.
Temperature is too cold	<ul style="list-style-type: none"> ■ Controls are not set correctly for the surrounding conditions: Adjust the controls to a warmer setting. Check the temperature again in 24 hours. ■ Top refrigerator shelf is colder than lower shelves: On some models, air from the freezer enters the refrigerator compartment through vents near the top refrigerator shelf. As a result, the top shelf can be slightly colder than lower shelves. ■ Air vents are blocked: Remove items that are immediately in front of the vents.
Interior moisture buildup	<p>NOTE: Some moisture buildup is normal. Clean with a soft dry cloth.</p> <ul style="list-style-type: none"> ■ Room is humid: A humid environment contributes to moisture buildup. Use the refrigerator only in an indoor location, with as little humidity as possible. ■ Doors are opened often or not closed completely: This allows humid air to enter the refrigerator. Minimize door openings, keep the doors fully closed, and make sure both doors are properly sealed.
Interior lights do not work	<ul style="list-style-type: none"> ■ Doors have been open for an extended period of time: Close the doors to reset the lights. ■ Light bulb is loose in the socket or has burned out: On models with incandescent interior light bulbs, tighten or replace the bulb. See the "Lights" section. <p>NOTE: On models with LED lights, call for assistance or service if the interior lights do not illuminate when either door is opened. See the Warranty for contact information.</p>
Dispenser lights do not work (on some models)	<ul style="list-style-type: none"> ■ Dispenser light is turned off: On some models, if the dispenser light is set to Off, the light will turn on only when a dispenser pad/lever is pressed. If you want the dispenser light to stay on continuously, select a different setting. See the "Water and Ice Dispensers" section. ■ Dispenser light is set to AUTO or NIGHT LIGHT: On some models, if the dispenser light is set to Auto or Night Light, make sure the dispenser light sensor is not blocked. See the "Water and Ice Dispensers" section in the User Instructions or User Guide. <p>NOTE: On models with LED lights, call for assistance or service if the dispenser lights do not operate correctly. See the Warranty in the User Instructions or User Guide for contact information.</p>

⚠ WARNING



Explosion Hazard
Use nonflammable cleaner.
Failure to do so can result in death, explosion, or fire.

DOORS AND LEVELING	Possible Causes and/or Recommended Solutions
Doors are difficult to open	<ul style="list-style-type: none"> ■ Gaskets are dirty or sticky: Clean the gaskets and contact surfaces with mild soap and warm water. Rinse and dry with a soft cloth.
Doors will not close completely	<ul style="list-style-type: none"> ■ Door is blocked open: Move food packages away from the door. Make sure all bins and shelves are in their correct positions. Make sure all packaging materials have been removed.
Doors appear to be uneven	<ul style="list-style-type: none"> ■ Doors need to be aligned, or refrigerator needs to be leveled: See the leveling and door alignment instructions.
Refrigerator rocks and is not stable	<ul style="list-style-type: none"> ■ Refrigerator is not level: To stabilize the refrigerator, remove the base grille and lower the leveling feet until they touch the floor. See the leveling and door alignment instructions.

⚠ WARNING



Cut Hazard
Use a sturdy glass when dispensing ice.
Failure to do so can result in cuts.

ICE AND WATER	Possible Causes and/or Recommended Solutions
Ice maker is not producing ice, not producing enough ice, or producing small/hollow ice	<ul style="list-style-type: none"> ■ Refrigerator is not connected to a water supply, or the water supply shutoff valve is not fully turned on: Connect the refrigerator to a water supply and make sure the water shutoff valve is fully open. ■ Kink in the water source line: A kink in the water line can reduce water flow, resulting in decreased ice production, small ice cubes, and/or hollow or irregularly-shaped ice. Straighten the water line. ■ Ice maker is not turned on: Turn on the ice maker. See the “Ice Maker and Storage Bin” section in the User Instructions or User Guide. ■ New installation: After connecting the refrigerator to a water source, flush the water system. (See the “Water and Ice Dispensers” section in the User Instructions or User Guide). Wait 24 hours for ice production to begin. Wait 72 hours for full ice production. Discard the first three batches of ice produced. ■ Large amount of ice was recently removed: Allow sufficient time for the ice maker to produce more ice. ■ Ice is jammed in the ice maker ejector arm: Remove ice from the ejector arm using a plastic utensil. ■ Inadequate water pressure: Verify that the household has adequate water pressure. See the “Water Supply Requirements” section. ■ Water filter is installed incorrectly: Make sure the filter is properly installed. See the “Water Filtration System” section in the User Instructions or User Guide. ■ A reverse osmosis water filtration system is connected to your cold water supply: This can decrease water pressure. See the “Water Supply Requirements” section. <p>NOTE: If questions remain regarding water pressure, contact a licensed, qualified plumber.</p>

ICE AND WATER**Possible Causes and/or Recommended Solutions**

Ice dispenser will not operate properly

- **Doors not closed completely** - Make sure both doors are firmly closed. (On some models, only the freezer door must be closed in order to operate the dispenser.)
- **New installation** - After connecting the refrigerator to a water source, flush the water system. (See the “Water and Ice Dispensers” section in the User Instructions or User Guide.) Wait 24 hours for ice production to begin. Wait 72 hours for full ice production. Discard the first three batches of ice produced.
- **Ice maker is not turned on, or ice bin is not installed correctly** - Turn on the ice maker and make sure the ice storage bin is firmly in position. See the “Ice Maker and Storage Bin” section in the User Instructions or User Guide.
- **Ice is clogged or frozen together in the ice storage bin, or ice is blocking the ice delivery chute** - Remove or separate the clogged ice, using a plastic utensil if necessary. Clean the ice delivery chute and the bottom of the ice storage bin using a warm damp cloth, then dry both thoroughly. To avoid clogging and to maintain a fresh supply of ice, empty the storage bin and clean both the storage bin and the delivery chute every two weeks.
- **Wrong ice has been added to the storage bin** - Use only ice cubes produced by the current ice maker.
- **Dispenser is locked** - Unlock the dispenser. See the “Water and Ice Dispensers” section in the User Instructions or User Guide.
- **Ice dispenser jams while dispensing crushed ice** - For models with the ice storage bin on the door, temporarily switch from crushed ice to cubed ice to clear the jam.
- **Dispenser pad/lever has been pressed too long** - Ice will automatically stop dispensing. Wait a few minutes for the dispenser to reset, then resume dispensing. Take large amounts of ice directly from the ice bin, not through the dispenser.
- **Water pressure to the home is not at or above 30 psi (207 kPa)** - The water pressure to the home affects the flow from the dispenser. See the “Water Supply Requirements” section.
- **Water filter is clogged or incorrectly installed** - Replace filter or reinstall it correctly. See the “Water Filtration System” section in the User Instructions or User Guide.

Ice or water has an off-taste, odor, or gray color

- **New plumbing connections** - New plumbing connections can result in off-flavored or discolored ice or water. This problem should go away over time.
- **Ice has been stored too long** - Discard the ice and wash the ice bin. Allow 24 hours for the ice maker to produce new ice.
- **Odor has transferred from food** - Use airtight moisture-proof packaging to store food.
- **Use of non-recommended water supply line** - Odors and tastes can transfer from certain materials used in non-recommended water supply lines. Use only a recommended water supply line. See the “Water Supply Requirements” section.
- **There are minerals (such as sulfur) in the water** - A water filter may need to be installed in order to remove the minerals.
- **Water filter was recently installed or replaced** - Gray or dark discoloration in ice or water indicates that the water filtration system needs additional flushing. See the “Water and Ice Dispensers” section in the User Instructions or User Guide.

Water dispenser will not operate properly

- **Doors not closed completely** - Make sure both doors are firmly closed. (On some models, only the freezer door must be closed in order to operate the dispenser.)
- **Refrigerator is not connected to a water supply, or the water supply shutoff valve is not turned on** - Connect the refrigerator to a water supply and make sure the water shutoff valve is fully open.
- **Kink in the water source line** - A kink in the water line can reduce water flow to the dispenser. Straighten the water line.
- **Water pressure to the home is not at or above 30 psi (207 kPa)** - The water pressure to the home affects the flow from the dispenser. See the “Water Supply Requirements” section.
- **New installation** - After connecting the refrigerator to a water source, flush the water system. See the “Water and Ice Dispensers” section in the User Instructions or User Guide.
- **Dispenser is locked** - Unlock the dispenser. See the “Water and Ice Dispensers” section in the User Instructions or User Guide.
- **Water filter is clogged or incorrectly installed** - Replace filter or reinstall it correctly. See the “Water Filtration System” section in the User Instructions or User Guide.
- **A reverse osmosis water filtration system is connected to your cold water supply** - This can decrease water pressure. See the “Water Supply Requirements” section.

NOTE: If questions remain regarding water pressure, contact a licensed, qualified plumber.

ICE AND WATER	Possible Causes and/or Recommended Solutions
Water is leaking or dripping from the dispenser	<p>NOTE: After dispensing, a few additional drops of water are normal.</p> <ul style="list-style-type: none"> ■ Glass was not held under the dispenser long enough - Hold the glass under the dispenser for 2 to 3 seconds after releasing the dispenser pad/lever. ■ New installation, or water filter was recently installed or replaced - Air in the water lines causes the water dispenser to drip. Flush the water system to remove the air in the water lines. See the “Water and Ice Dispensers” section in the User Instructions or User Guide. ■ Residual ice in the dispenser chute is melting - Make sure the ice chute is free of ice shavings or pieces.
Water is leaking from the back of the refrigerator	<ul style="list-style-type: none"> ■ Water line connections are not fully tightened - Make sure all connections are firmly tightened. See the “Connect Water Supply” section.
Water from the dispenser is not cool enough (on some models)	<p>NOTE: Water from the dispenser is chilled to 50°F (10°C).</p> <ul style="list-style-type: none"> ■ New installation - Allow 24 hours after installation for the water supply to cool completely. ■ Recently dispensed a large amount of water - Allow 24 hours for the new water supply to cool completely. ■ Water has not been recently dispensed - The first glass of water may not be cool. Discard the first glass of water dispensed. ■ Refrigerator is not connected to a cold water pipe - Make sure the refrigerator is connected to a cold water pipe. See the “Water Supply Requirements” section.
User interface not responding	<ul style="list-style-type: none"> ■ Pressing user interface too fast - Wait 10 seconds before pressing any key. ■ User interface in Lock Mode - Press and hold LOCK for 3 seconds to exit Lock Mode.

ACCESSORIES

All Accessories can be purchased by calling **1-844-553-6667**.

Stainless Steel Cleaner and Polish:

Order Part #D22 M40083 R

Water Filter:

Order Part #9081

Click - SearsPartsDirect.com or Sears.com
 Come on in - Buy at Stores where this refrigerator is sold

PERFORMANCE DATA SHEETS

Water Filtration System Model P8WB2L/P8RFWB2L (EDR1RXD1, Filter 1) Capacity 200 Gallons (757 Liters)



System tested and certified by NSF International against NSF/ANSI Standard 42, Standard 53, Standard 401, and CSA B483.1 for the reduction of contaminants specified on the Performance Data Sheet.

This system has been tested according to NSF/ANSI Standards 42, 53, 401, and CSA B483.1 for the reduction of the substances listed below. The concentration of the indicated substances in water entering the system was reduced to a concentration less than or equal to the permissible limit for water leaving the system, as specified in NSF/ANSI Standards 42, 53, 401, and CSA B483.1

Substance Reduction Aesthetic Effects	Influent Challenge Concentration	Maximum Permissible Product Water Concentration	Average % Reduction
Chlorine Taste/Odor	2.0 mg/L ± 10%	50% reduction	97.0%
Particulate Class I*	At least 10,000 particles/mL	85% reduction	>99.9%
Contaminant Reduction	Influent Challenge Concentration	Maximum Permissible Product Water Concentration	Average % Reduction
Lead [‡] : @ pH 6.5 / @ pH 8.5	0.15 mg/L ± 10%	0.010 mg/L	>99.3% / 98.6%
Benzene	0.015 mg/L ± 10%	0.005 mg/L	93.8%
p-Dichlorobenzene	0.225 mg/L ± 10%	0.075 mg/L	99.8%
Carbofuran	0.08 mg/L ± 10%	0.040 mg/L	81.9%
Toxaphene	0.015 ± 10%	0.003 mg/L	>95%
Atrazine	0.009 mg/L ± 10%	0.003 mg/L	87.0%
Asbestos	10 ⁷ to 10 ⁸ fibers/L ^{††}	99%	>99%
Live Cysts [†]	50,000/L min.	99.95%	>99.99%
Turbidity	11 NTU ± 10%	0.5 NTU	96.9%
Lindane	0.002 ± 10%	0.0002 mg/L	>99.2%
Tetrachloroethylene	0.015 mg/L ± 10%	0.005 mg/L	96.6%
O-Dichlorobenzene	1.8 mg/L ± 10%	0.60 mg/L	92.3%
Ethylbenzene	2.1 mg/L ± 10%	0.70 mg/L	86.9%
1,2,4-Trichlorobenzene	0.210 mg/L ± 10%	0.07 mg/L	>99.8%
2,4 - D	0.210 mg/L ± 10%	0.07 mg/L	88.5%
Styrene	2.0 mg/L ± 10%	0.1 mg/L	99.6%
Toluene	3.0 mg/L ± 10%	1.0 mg/L	93.5%
Endrin	0.006 mg/L ± 10%	0.002 mg/L	81.7%
Atenolol	200 ± 20%	30 ng/L	95.7%
Trimethoprim	140 ± 20%	20 ng/L	96.1%
Linuron	140 ± 20%	20 ng/L	96.3%
Estrone	140 ± 20%	20 ng/L	95.3%
Nonylphenol	1400 ± 20%	200 ng/L	95.5%
Carbamazepine	1400 ± 20%	200 ng/L	97.94%
Phenytoin	200 ± 20%	30 ng/L	93.58%
Naproxen	140 ± 20%	20 ng/L	96.04%
Bisphenol A	2000 ± 20%	300 ng/L	99.20%

Test Parameters: pH = 7.5 ± 0.5 unless otherwise noted. Flow = 0.5 gpm (1.89 lpm). Pressure = 60 psig (413.7 kPa). Temp. = 68°F to 71.6°F (20°C to 22°C). Rated service capacity = 200 gallons (757 liters).

The compounds certified under NSF 401 have been deemed as “emerging compounds/incidental contaminants.” Emerging compounds/incidental contaminants are those compounds that have been detected in drinking water supplies at trace levels. While occurring at only trace levels, these compounds can affect the public acceptance/perception of drinking water quality.

- It is important that operational, maintenance, and filter replacement requirements be carried out for the product to perform as advertised. Property damage can occur if all instructions are not followed.
- The disposable cartridge must be changed at least every 6 months.
- Use replacement filter P8RFWB2L, part #EDR1RXD1/EDR1RXD1B. 2015 suggested retail price of \$49.99 U.S.A./\$49.99 Canada. Prices are subject to change without notice
- The filter monitor system measures the amount of water that passes through the filter and alerts you when it is time to replace the filter. Refer to the “Using the Controls” or “Water Filtration System” section (in the User Instructions or User Guide) to learn how to check the water filter status.
- After changing the water filter, flush the water system. See “Water and Ice Dispensers” or “Water Dispenser” in the User Instructions or User Guide.
- These contaminants are not necessarily in your water supply. While testing was performed under standard laboratory conditions, actual performance may vary.
- The product is for cold water use only.
- The water system must be installed in compliance with state and local laws and regulations.
- Do not use with water that is microbiologically unsafe or of unknown quality without adequate disinfection before or after the system. Systems certified for cyst reduction may be used on disinfected waters that may contain filterable cysts. EPA Est. No. 082047-TWN-001
- Refer to the “Warranty” section (in the User Instructions or User Guide) for the Manufacturer’s limited warranty, name, and telephone number.

Application Guidelines/Water Supply Parameters

Water Supply	Potable City or Well
Water Pressure	30 - 120 psi (207 - 827 kPa)
Water Temperature	33° - 100°F (0.6° - 37.8° C)
Service Flow Rate	0.50 gpm (1.89 L/min.) @ 60 psi.

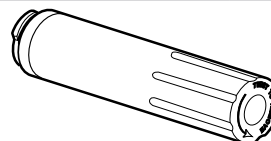

*Class I particle size: >0.5 to <1 um

†Based on the use of Cryptosporidium parvum oocysts

††Fibers greater than 10 um in length

©NSF is a registered trademark of NSF International.

NOTES

Kenmore®

Customer Care Hotline

To schedule repair service or order parts

1-844-553-6667

www.kenmore.com

