



FlexWash™

User manual

WV60A9900A*

SAMSUNG



Contents

Safety information	4
What you need to know about the safety instructions	4
Important safety symbols	4
Important safety precautions	5
CALIFORNIA PROPOSITION 65 WARNING	5
Critical installation warnings	6
Installation cautions	7
Critical usage warnings	7
Usage cautions	9
Critical cleaning warnings	12
Regulatory notice	13
FCC Notice	13
IC Notice	14
Open Source Announcement	15
Installation	16
Unpacking your washer	16
What's included	17
Installation requirements	19
Step-by-step installation	23
Before you start	32
Initial setup	32
Laundry guidelines	33
Guide to cleaning agents	36
Operations	41
Control panel	41
Operating a cycle	43
Cycle overview	45
Cycle chart	48
Options	51
System Functions	54
Special features	56
SmartThings	58



Maintenance	59
General considerations	59
Upper washer	62
Lower washer	65
Troubleshooting	71
Checkpoints	71
Information codes	75
Specifications	78
Fabric care chart	78
Protecting the environment	79
Declaration of conformity	79
Specification sheet	80



Safety information

Congratulations on your new Samsung washer. This manual contains important information on the installation, use and care of your appliance. Please take some time to read this manual to take full advantage of your washer's many benefits and features.

What you need to know about the safety instructions

Please read this manual thoroughly to ensure that you know how to safely and efficiently operate the extensive features and functions of your new appliance. Please store the manual in a safe location close to the appliance for future reference. Use this appliance only for its intended purpose as described in this instruction manual.

Warnings and Important Safety Instructions in this manual do not cover all possible conditions and situations that may occur. It is your responsibility to use common sense, caution and care when installing, maintaining and operating your washer.

Because the following operating instructions cover various models, the characteristics of your washer may differ slightly from those described in this manual and not all warning signs may be applicable. If you have any questions or concerns, contact your nearest service center or find help and information online at www.samsung.com.

Important safety symbols

What the icons and signs in this user manual mean:

WARNING

Hazards or unsafe practices that may result in **severe personal injury, death and/or property damage.**

CAUTION

Hazards or unsafe practices that may result in **personal injury and/or property damage.**

NOTE

Indicates that a risk of personal injury or material damage exists.

These warning signs are here to prevent injury to yourself and others.

Please follow them explicitly.

After reading this manual, store it in a safe place for future reference.

Read all instructions before using the appliance.

As with any equipment that uses electricity and moving parts, potential hazards exist. To safely operate this appliance, familiarize yourself with its operation and exercise care when using it.

SAVE THESE INSTRUCTIONS



Important safety precautions

WARNING

To reduce the risk of fire, electric shock, or injury to persons when using your appliance, follow basic precautions, including the following:

1. Read all instructions before using the appliance.
2. Do not wash or dry articles that have been previously cleaned in, washed in, soaked in, or spotted with gasoline, dry-cleaning solvents, other flammable or explosive substances as they give off vapors that could ignite or explode.
3. Do not allow children to play on or in the appliance. Close supervision of children is necessary when the appliance is used near children.
4. Before the appliance is removed from service or discarded, remove the door to the washing or drying compartment.
5. Do not reach into the appliance if the drum is moving.
6. Do not install or store this appliance where it will be exposed to the weather.
7. Do not tamper with controls.
8. Do not repair or replace any part of the appliance or attempt any servicing unless specifically recommended in the user-maintenance instructions or in published user repair instructions that you understand and have the skills to carry out.
9. Do not add gasoline, dry-cleaning solvents, or other flammable or explosive substances to the wash water. These substances give off vapors that could ignite or explode.
10. Under certain conditions, hydrogen gas may be produced in a hot water system that has not been used for 2 weeks or more. **HYDROGEN GAS IS EXPLOSIVE.** If the hot water system has not been used for such a period, before using a washer or combination washer-dryer, turn on all hot water faucets and let the water flow from each for several minutes. This will release any accumulated hydrogen gas. As the gas is flammable, do not smoke or use an open flame during this time.

CALIFORNIA PROPOSITION 65 WARNING

WARNING

Cancer and Reproductive Harm - www.P65Warnings.ca.gov.

SAVE THESE INSTRUCTIONS



Safety information

Critical installation warnings

WARNING

The installation of this appliance must be performed by a qualified technician or service company.

- Failure to do so may result in electric shock, fire, an explosion, problems with the product, or injury.

The appliance is heavy, therefore take care when lifting it.

Plug the power cord into a wall socket that meets local electrical specifications. Use the socket for this appliance only, and do not use an extension cord.

- Sharing a wall socket with other appliances, using a power strip, or extending the power cord may result in electric shock or fire.
- Ensure that the voltage, frequency, and current supplied to the washer matches those listed in the product specifications. Failure to do so may result in electric shock or fire. Plug the power plug into the wall socket firmly.

Remove all foreign substances such as dust or water from the power plug terminals and contact points using a dry cloth on a regular basis.

- Unplug the power plug and clean it with a dry cloth.
- Failure to do so may result in electric shock or fire.

Plug the power plug into the wall socket so that the cord is running towards the floor.

- If you plug the power plug into the socket in the opposite direction, the electric wires within the cable may be damaged and this may result in electric shock or fire.

Keep all packaging materials out of the reach of children as these may be dangerous.

- If a child places a plastic bag over his or her head, he or she can suffocate.

If the appliance, power plug, or power cord is damaged, contact your nearest service center.

This appliance must be properly grounded.

Do not ground the appliance to a gas pipe, plastic water pipe, or telephone line.

- This may result in electric shock, fire, an explosion, or problems with the product.
- Never plug the power cord into a socket that is not grounded correctly. Make sure that the socket is in accord with local and national regulations.

Do not install this appliance near a heater or any flammable material.

Do not install this appliance in a humid, oily or dusty location, or in a location exposed to direct sunlight or water (rain drops).

Do not install this appliance in a location exposed to low temperatures.

- Frost may cause the tubes to burst.

Do not install this appliance in a location where gas may leak.

- This may result in electric shock or fire.

SAVE THESE INSTRUCTIONS



Do not use an electric transformer to power the washer.

- This may result in electric shock or fire.

Do not use a damaged power plug, damaged power cord, or loose wall socket.

- This may result in electric shock or fire.

Do not pull or bend the power cord excessively.

Do not twist or tie the power cord.

Do not hook the power cord over a metal object, place a heavy object on the power cord, insert the power cord between objects, or push the power cord into the space behind the appliance.

- This may result in electric shock or fire.

Do not pull the power cord when unplugging the power plug.

- Unplug the power plug by pulling the plug.
- Failure to do so may result in electric shock or fire.

This appliance should be positioned so that the power plug, the water supply taps, and the drain pipes are accessible.

Installation cautions

CAUTION

This appliance should be positioned in such a way that the power plug is easily accessible.

- Failure to do so may result in electric shock or fire due to electric leakage.

Install your appliance on a solid, level floor that can support its weight.

- Failure to do so may result in abnormal vibrations, movement, noise, or problems with the product.

Critical usage warnings

WARNING

If the appliance is flooded, turn off the water & power supplies immediately and contact your nearest service center.

- Do not touch the power plug with wet hands.
- Failure to do so may result in electric shock.

If the appliance generates a strange noise, a burning smell, or smoke, unplug the power plug immediately and contact your nearest service center.

- Failure to do so may result in electric shock or fire.

SAVE THESE INSTRUCTIONS

Safety information

In the event of a gas leak (such as propane gas, LP gas, etc.), ventilate immediately without touching the power plug. Do not touch the appliance or power cord.

- Do not use a ventilating fan.
- A spark may result in an explosion or fire.

Do not let children play in or on the washer. In addition, when disposing of the appliance, remove the washer door lever.

- Children can suffocate to death if trapped inside the product.

Make sure to remove the packaging (sponge, styrofoam) attached to the bottom of the washer before using it.

Do not wash items contaminated with gasoline, kerosene, benzene, paint thinner, alcohol, or other inflammable or explosive substances in the washer.

- This may result in electric shock, fire, or an explosion.

Do not open the washer door by force while it is operating (high-temperature washing/drying/spinning).

- Water flowing out of the washer may result in burns or cause the floor to be slippery. This may result in injury.
- Opening the door by force may result in damage to the product or injury.

Do not insert your hand under the washer while an operation is in progress.

- This may result in injury.

Do not touch the power plug with wet hands.

- This may result in electric shock.

Do not turn the appliance off by unplugging the power plug while an operation is in progress.

- Plugging the power plug into the wall socket again may cause a spark and result in electric shock or fire.

Do not let children climb in or onto the appliance.

- This may result in electric shock, burns, or injury.

Do not insert your hand or a metal object under the washer while it is operating.

- This may result in injury.

Do not unplug the appliance by pulling the power cord. Always grip the plug firmly and pull it straight out of the outlet.

- Damage to the power cord may cause a short-circuit, fire, and/or electric shock.

Do not attempt to repair, disassemble, or modify the appliance yourself.

- Do not use a fuse (such as copper, steel wire, etc.) other than a standard fuse.
- When the appliance needs to be repaired or reinstalled, contact your nearest service center.
- Failure to do so may result in electric shock, fire, problems with the product, or injury.

If the water supply hose comes loose from the faucet and floods the appliance, unplug the power plug.

- Failure to do so may result in electric shock or fire.

SAVE THESE INSTRUCTIONS

Unplug the power plug when the appliance is not being used for long periods of time or during a thunder or lightning storm.

- Failure to do so may result in electric shock or fire.

If any foreign substance enters the appliance, unplug the power plug and contact your nearest Samsung Customer Service.

- This may result in electric shock or fire.

Do not let children (or pets) play in or on your washer. The washer door does not open easily from the inside and children may be seriously injured if trapped inside.

Usage cautions

CAUTION

If the washer is contaminated by a foreign substance such as detergent, dirt, food waste, etc., unplug the power plug and clean the washer using a damp, soft cloth.

- Failure to do so may result in discoloration, deformation, damage, or rust.

The front glass may be broken by a strong impact. Take care when using the washer.

- If the glass is broken, it may result in injury.

After a water supply failure or when reconnecting the water supply hose, open the faucet slowly.

Open the faucet slowly after a long period of non-use.

- The air pressure in the water supply hose or the water pipe may damage a product part or result in a water leak.

If a draining error occurs during an operation, check if there is a draining problem.

- If the washer is used when it is flooded because of a draining problem, it may result in electric shock or fire.

Insert the laundry into the washer completely so that the laundry does not get caught in the door.

- If laundry gets caught in the door, it may result in damage to the laundry or the washer, or result in a water leak.

Turn the water supply off when the washer is not being used.

- Ensure that the water supply hose connectors are properly tightened.

Ensure that the rubber seal and front door glass are not contaminated by a foreign substance (e.g. waste, thread, hair, etc.).

- If a foreign substance is caught in the door or the door is not completely closed, it may cause a water leak.

SAVE THESE INSTRUCTIONS



Safety information

Open the faucet and check if the water supply hose connectors are firmly tightened and that there are no water leaks before using the product.

- If the connectors on the water supply hoses are loose, it may result in a water leak.

The product you have purchased is designed for domestic use only.

Using the product for business purposes qualifies as a product misuse. If the product is used for business purposes, it will not be covered by the standard warranty provided by Samsung and no responsibility can be attributed to Samsung for malfunctions or damages resulting from such misuse.

Do not stand on the appliance or place objects (such as laundry, lighted candles, lighted cigarettes, dishes, chemicals, metal objects, etc.) on the appliance.

- This may result in electric shock, fire, problems with the product, or injury.

Do not spray volatile material such as insecticide onto the surface of the appliance.

- As well as being harmful to humans, this may result in electric shock, fire, or problems with the product.

Do not place objects that generate electromagnetic fields near the washer.

- This may result in injury due to a malfunction.

Water drained during a high-temperature wash or drying cycle is hot. Do not touch the water.

- This may result in burns or injury.

Do not wash, spin, or dry water-proof seats, mats, or clothing (*) unless your appliance has a special cycle for washing these items.

(*): Woolen bedding, rain covers, fishing vests, ski pants, sleeping bags, diaper covers, sweat suits, and bicycle, motor cycle and car covers, etc.

- Do not wash thick or hard mats even if the washer mark is on the care label. This may result in injury or damage to the washer, walls, floor, or clothing due to abnormal vibrations.
- Do not wash throw rugs or doormats with rubber backing. The rubber backing may come off and stick to inside the drum, and this may result in malfunction such as a drainage error.

Do not operate the washer when the detergent drawer is removed.

- This may result in electric shock or injury due to a water leak.

Do not touch the insides of the drum during or just after drying as it is hot.

- This may result in burns.

The door glass becomes hot during washing and drying. Therefore, do not touch the door glass.

Also, do not allow children to play around the washer or touch the door glass.

- This may result in burns.

Do not insert your hand into the detergent drawer.

- This may result in injury as your hand may be caught by the detergent input device.

SAVE THESE INSTRUCTIONS



- Do not use the liquid detergent container (on applicable models only) for powdered detergent. Remove the container and put powdered detergent directly into the Main wash compartment.

Do not place any objects (such as shoes, food waste, animals) other than laundry into the washer.

- This may result in damage to the washer, or injury and death in the case of pets, due to the abnormal vibrations.

Do not press the buttons using sharp objects such as pins, knives, fingernails, etc.

- This may result in electric shock or injury.

Do not wash laundry contaminated by oils, creams, or lotions usually found in skincare shops or massage clinics.

- This may cause the rubber seal to become deformed and result in a water leak.

Do not leave metal objects such as safety pins, hair pins or bleach in the drum for long periods of time.

- Doing either may cause the drum to rust.
- If rust starts appearing on the surface of the drum, apply a (neutral) cleansing agent to the surface and use a sponge to clean it. Never use a metal brush.

Do not use dry cleaning detergent directly and do not wash, rinse, or spin laundry contaminated by dry cleaning detergent.

- This may result in spontaneous combustion or ignition due to the heat from the oxidation of the oil.

Do not use water from water cooling/heating devices.

- This may result in problems with the washer.

Do not use natural hand-washing soap for the washer.

- If it hardens and accumulates inside the washer, it may result in problems with the product, discoloration, rust, or bad odors.

Place socks and brassieres in a washing net and wash them with the other laundry.

Do not wash large laundry items such as bedding in the washing net.

- Failure to do so may result in injury due to abnormal vibrations.

Do not use hardened detergent.

- If it accumulates inside the washer, it may result in a water leak.

Make sure that the pockets of all the clothing items to be washed are empty.

- Hard, sharp objects such as coins, safety pins, nails, screws, or stones can cause extensive damage to the appliance.

Do not wash clothing with large buckles, buttons, or other heavy metal objects in the washer.

Sort the laundry by color on the basis of its colorfastness and select the recommended cycle, water temperature, and additional functions.

- Failure to do this may result in discoloration or fabric damage.

SAVE THESE INSTRUCTIONS

Safety information

Take care that children's fingers are not caught in the door when you close it.

- Failure to do so may result in injury.

Critical cleaning warnings

WARNING

Do not clean the appliance by spraying water directly onto it.

Do not use a strong acidic cleaning agent.

Do not use benzene, thinner, or alcohol to clean the appliance.

- This may result in discoloration, deformation, damage, electric shock, or fire.

Before cleaning or performing maintenance, unplug the appliance from the wall socket.

- Failure to do so may result in electric shock or fire.

SAVE THESE INSTRUCTIONS

Regulatory notice

FCC Notice

CAUTION

Any changes or modifications not expressly approved by the party responsible for compliance could void the user's authority to operate the equipment.

This device complies with Part 15 of FCC Rules. Operation is Subject to following two conditions:

1. This device may not cause harmful interference, and
2. This device must accept any interference received including interference that cause undesired operation.

For products sold in the US and Canadian markets, only channels 1–11 are available. You cannot select any other channels.

FCC STATEMENT:

This equipment has been tested and found to comply within the limits for a Class B digital device, pursuant to part 15 of the FCC Rules. These limits are designed to provide reasonable protection against harmful interference in a residential installation.

This equipment generates, uses, and can radiate radio frequency energy and, if not installed and used in accordance with the instructions, may cause harmful interference to radio communications. However, there is no guarantee that interference will not occur in a particular installation. If this equipment does cause harmful interference to radio or television reception, which can be determined by turning the equipment off and on, the user is encouraged to try to correct the interference by one or more of the following measures:

- Reorienting or relocating the receiving antenna
- Increasing the separation between the equipment and receiver
- Connecting the equipment to an outlet that is on a different circuit than the radio or TV.
- Consulting the dealer or an experienced radio/TV technician for help.

FCC RADIATION EXPOSURE STATEMENT:

This equipment complies with FCC radiation exposure limits set forth for an uncontrolled environment. This equipment should be installed and operated so there is at least 8 inches (20 cm) between the radiator and your body. This device and its antenna(s) must not be colocated or operated in conjunction with any other antenna or transmitter.

SAVE THESE INSTRUCTIONS



Regulatory notice

English

Unintentional emitter per FCC Part 15
Product type : Electric Clothes Washing Machines
Model : WV60A9900A*
Responsible Party – U.S. Contact Information
Samsung Electronics America, Inc.
QA Lab America
19 Chapin Rd. Building D Pine Brook NJ 07058
Tel: 1-973-808-6375 Fax: 1-973-808-63

IC Notice

The term "IC" before the radio certification number only signifies that Industry Canada technical specifications were met. Operation is subject to the following two conditions:

1. This device may not cause interference, and
2. This device must accept any interference, including interference that may cause undesired operation of the device.

This Class B digital apparatus complies with Canadian ICES-003.

Cet appareil numérique de la classe B est conforme à la norme NMB-003 du Canada.

For products sold in the US and Canadian markets, only channels 1–11 are available. You cannot select any other channels.

IC RADIATION EXPOSURE STATEMENT:

This equipment complies with IC RSS-102 radiation exposure limits set forth for an uncontrolled environment. This equipment should be installed and operated so there is at least 8 inches (20 cm) between the radiator and your body. This device and its antenna(s) must not be colocated or operated in conjunction with any other antenna or transmitter.

SAVE THESE INSTRUCTIONS



Open Source Announcement

The software included in this product contains open source software.

The following URL http://opensource.samsung.com/opensource/SMART_TP2_0/seq/0 leads to open source license information as related to this product.



NOTE

Hereby, Samsung Electronics, declares that the radio equipment type appliance is in compliance with Directive 2014/53/EU. The full text of the EU declaration of conformity is available at the following internet address: The official Declaration of conformity may be found at <http://www.samsung.com>, go to Support > Search Product Support and enter the model name.

Wi-Fi max transmitter power : 20 dBm at 2.412 GHz – 2.472 GHz

SAVE THESE INSTRUCTIONS



Installation

Follow these instructions carefully to ensure proper installation of your washer and to prevent accidents when doing laundry.

⚠ WARNING

Certain internal parts are intentionally not grounded and may present a risk of electric shock only during servicing. Service personnel – Do not contact the following parts while the appliance is energized: Control board, heat sink, motor, inlet valve and pump.

Unpacking your washer

Unpack your washer and inspect it for shipping damage. Make sure you have received all the items shown on the next page. If your washer was damaged during shipping, or you do not have all of the items, call 1-800-SAMSUNG (1-800-726-7864). To prevent personal injury or strain, wear protective gloves whenever lifting or carrying the unit.

⚠ WARNING

Packing materials can be dangerous to children; Keep all packing material (plastic bags, polystyrene, etc.) well out of children's reach.

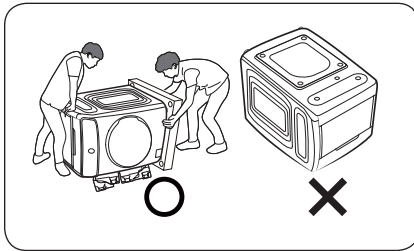

⚠ CAUTION

You must have at least 2 people unpack the washer. To remove the cushion bottom of the packing materials, do not tip the washer over on its front side.

When you lay the washer down to remove the carton base, protect the side of the washer and lay it down carefully. Never lay your washer on its back or front.

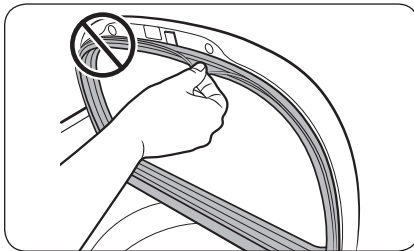

⚠ CAUTION

Do not yank out or remove the sealing of the protective cover. This may cause a leak during the washing process.



What's included

Make sure all the parts are included in the product package. If you have a question about the washer or the parts, contact a local Samsung customer center or your retailer.

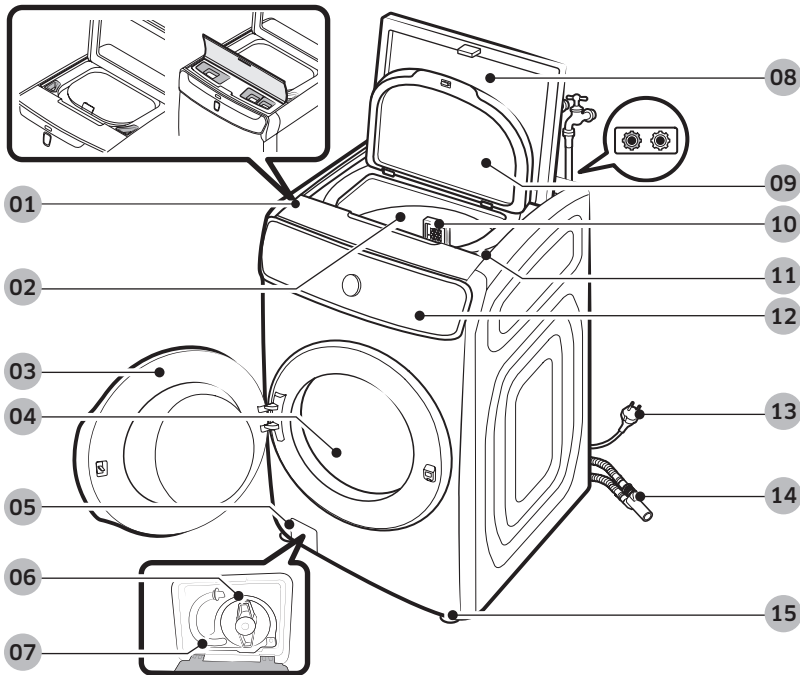

- | | | |
|--------------------------------|---|-----------------------------|
| 01 Lower detergent compartment | 02 Tub | 03 Front door |
| 04 Drum | 05 Filter cover | 06 Pump filter |
| 07 Emergency drain tube | 08 Top door | 09 Protective cover (inner) |
| 10 Lint filter | 11 Upper detergent compartment | 12 Control panel |
| 13 Power plug | 14 Pipe connector (Upper drain hose & lower drain hose) | 15 Leveling legs |



Installation

Accessories (supplied)



Bolt caps



Hose guide (x 2)



Cable tie



Aqua Pebble



Rubber cups *

* When not using the pedestal, use the rubber cups for soft floors or surfaces.

Accessories (not supplied)

You must purchase these items at a local service center.

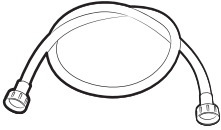

Water hoses (sold separately)



Anti-slip pads (sold separately)

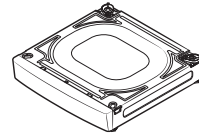

Pedestal (flex system only)

NOTE

- The number (7 to 9) of bolt caps provided depends on the model.
- The appearance of the washer and provided accessories may differ by model.
- To purchase an accessory or lost part, contact a local Samsung service center or your retailer.

CAUTION

- Make sure to use the dedicated pedestal to the flex system, "WE272N". Not using the dedicated pedestal may cause safety concerns.
- Do not reuse old water hoses, which may leak or burst, causing flooding and/or property damage.
- Make sure rubber washers are inserted in each coupling of both water hoses.





Tools required for installation (not supplied)

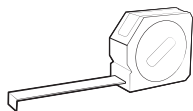

Measuring tape

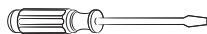

Phillips screwdriver



Level



Adjustable pliers

Installation requirements

Electrical supply and grounding

- AC 120 V / 60 Hz / 15 AMP fuse or circuit breaker is required.
- Use an individual branch circuit. Connect only the washer to the circuit.

WARNING

- Do NOT use an extension cord.
- Use only the power cord that comes with the washer.
- Do NOT connect the ground wire to plastic plumbing, gas lines, or hot water pipes.
- Improperly connected grounding conductors may cause electric shock.
- To ensure proper grounding, the washer comes with a power cord featuring a three-prong grounding plug for use in a properly installed and grounded outlet. Check with a qualified electrician or service person if you are not sure about the grounding.
- Do not modify the provided plug. If it does not fit the outlet, call a qualified electrician to install a proper outlet.
- To prevent unnecessary risk of fire, electrical shock, or personal injury, all wiring and grounding must be done in accordance with local codes, or in the absence of local codes, in accordance with the National Electrical Code, ANSI/ NFPA No. 70-Latest Revision (for the U.S.) or the Canadian Electrical Code CSA C22.1 – Latest Revisions and local codes and ordinances. It is your responsibility to provide adequate electrical service for your washer.





Installation

Water supply

Water pressure less than 20 psi (137 kPa) may cause the water valve not to close completely. Or, it may take longer to fill the drum, causing the washer to turn off. Taps must be within 4 feet (122 cm) from the rear of the washer so that the provided inlet hoses reach the washer. To reduce the risk of leaks:

To reduce the risk of leaks:

- Make sure taps are easily accessible.
- Turn off the taps when the washer is not in use.
- Check for any leaks at the water inlet hose fittings on a regular basis.

CAUTION

Before using the washer for the first time, check all connections at the water valve and taps for any leaks.

Drain

Samsung recommends a standpipe 18 inches (46 cm) high. The drain hose must be connected through the clamp ring to the standpipe, and the standpipe must fully cover the drain hose.

Flooring

For best performance, the washer must be installed on a solid floor. Wood floors may need to be reinforced to minimize vibration and/or unbalanced loads. Carpeting and soft tile surfaces do not provide good resistance to vibrations and may cause the washer to move slightly during the spin cycle.

CAUTION

Do NOT install the washer on a platform or a poorly supported structure.

Water temperature

Do not install the washer in areas where water may freeze as the washer always retains some water in its water valves, pumps, and/or hoses. Frozen water left in the connection parts may cause damage to belts, the pump, and other components of the washer.



Alcove or closet installation

Minimum clearance for stable operation:

Sides	1 in. (25 mm)	Rear	6 in. (152 mm)
Top	21 in. (533 mm)	Front	2 in. (51 mm)

If both the washer and a dryer are installed in the same location, the front of the alcove or closet must have two unobstructed air openings for a combined minimum total area of 72 in² (465 cm²). Your washer alone does not require a specific air opening.

Installation on a pedestal

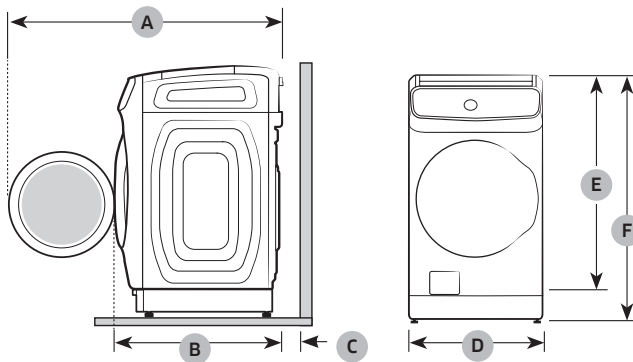

A	54.6 in. (1386 mm)	D	27 in. (686 mm)
B	34 in. (864 mm)	E	46.9 in. (1192 mm)
C	6 in. (152 mm)	F	52.2 in. (1326 mm)

Installation

English

Side by side installation

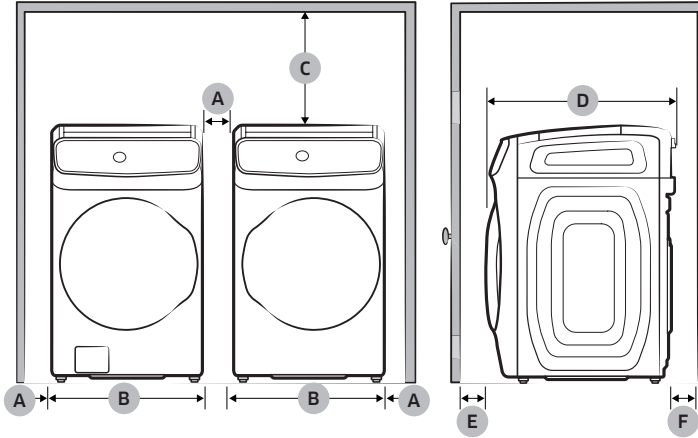

A	1 in. (25 mm)	D	34 in. (864 mm)
B	27 in. (686 mm)	E	2 in. (51 mm)
C	21 in. (533 mm)	F	6 in. (152 mm)

*This clearance is not applicable to standalone washers.

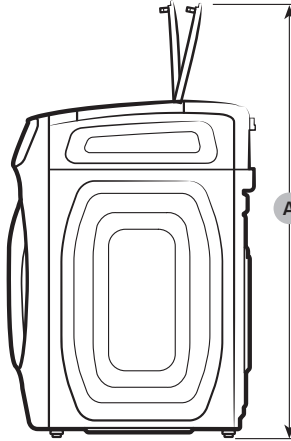

A	61 in. (1550 mm)
---	------------------

Step-by-step installation

STEP 1 Select a location

Location requirements:

- A solid, level surface without carpeting or flooring that may obstruct ventilation
- No direct sunlight
- Adequate room for ventilation and wiring
- Ambient temperature always higher than the freezing point (32 °F / 0 °C)
- Away from heat sources

STEP 2 Remove the shipping bolts

WARNING

- The shipping bolts secure the drum during product transportation and reduce the chance of suspension damage. Remove the shipping bolts before using the product and only reinsert them if you need to move the product.
- Packaging materials can be dangerous to children. Dispose all packaging material (plastic bags, polystyrene, etc.) out of children's reach.
- To ensure proper installation, all 7 shipping bolts must be removed.

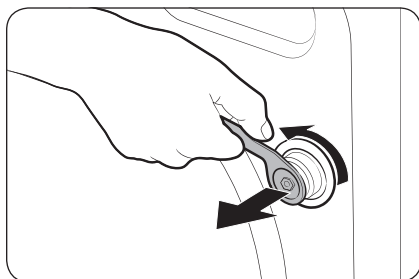

Unpack the product package and remove all shipping bolts (x7).

1. Loosen all shipping bolts on the rear of the washer using the wrench.

NOTE

An adjustable wrench or 10 mm open-end wrench is required for removing the shipping bolts.

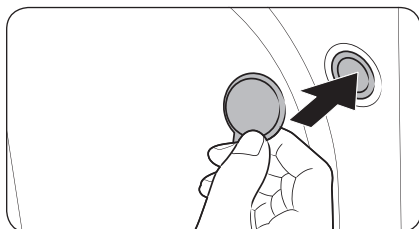

2. Fill the holes with the supplied plastic bolt caps. Keep the shipping bolts for future use.

Installation

STEP 3 Adjust the leveling legs

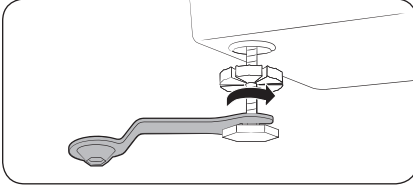

1. Gently slide the washer into position. Excessive force may damage the leveling legs.
2. Level the washer by manually adjusting the leveling legs.

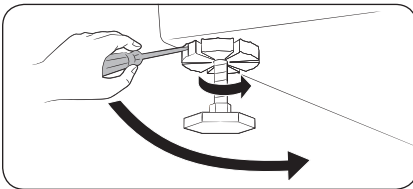

3. When leveling is complete, tighten the nuts using the Phillips screwdriver.

NOTE

An adjustable wrench or 17 mm open-end wrench is required to loosen or tighten the leveling legs.

STEP 4 Put the rubber cups on the legs (Only for soft floor or surface)

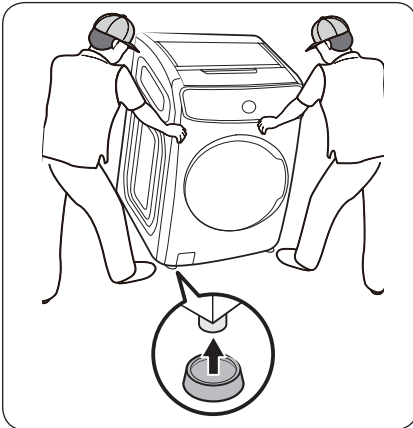

To protect a soft floor or surface, use the provided rubber cups. You don't need to use the rubber cups on a hard floor or on a pedestal.

1. Let two or more persons hold both sides of the washer.
2. While slanting the washer to one side, put the rubber cups under each leg of the washer one by one.

CAUTION

Make sure you have two or more persons insert the rubber cups. Otherwise, the washer may fall, causing physical or property damage.

STEP 5 Connect the water hose

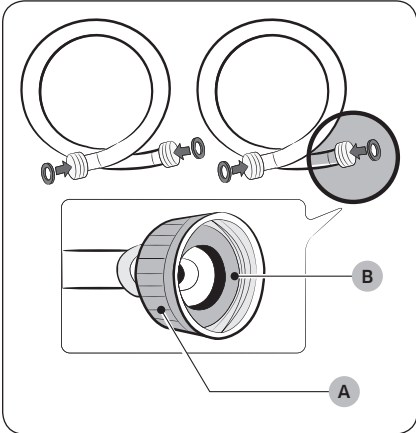

⚠ CAUTION

- Make sure you use a new water hose and that there are **rubber gaskets (B)** inside the **couplings (A)** at either end of each water hose. A water hose without the gasket may leak.
- If there is a water leak, stop using the washer and contact a local Samsung service center. A water leak may cause electric shock.
- Do not stretch the water hose by force. If the hose is too short, replace the hose with a longer, high-pressure hose.
- To prevent leaks, make sure both water hoses are not bent or kinked. A water leak may cause electric shock.

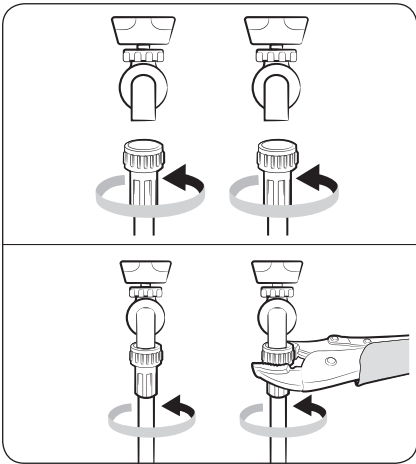

To connect the water hoses to the taps:

1. Connect one end of each water hose to the hot or cold tap.
2. Turn the fittings by hand until they are tight, and then tighten them an additional two-thirds of a turn with a pliers. To prevent damage, do not overtighten the fittings.
3. When done, pull the water hoses up and down to check if they are properly connected.

Installation

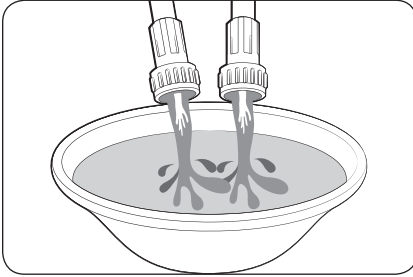

4. Put the other ends of the hoses into a bucket and open the taps for 10-15 seconds to remove impurities. When done, close the taps.

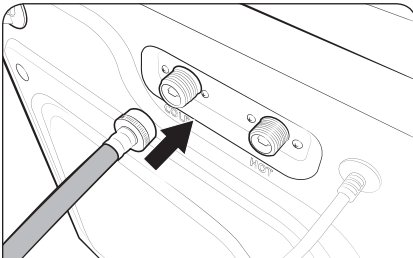

5. Connect the other ends of the water hoses to the corresponding inlets on the rear of the washer as specified. Make sure the hot water hose is connected to the hot inlet, and the cold water hose to the cold inlet.

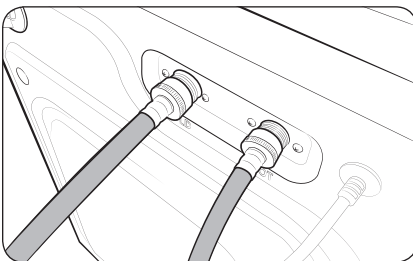
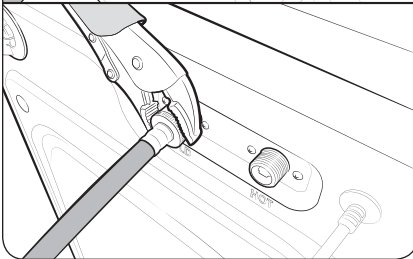

6. Repeat step 2 on the other fittings. Make sure both water hoses are connected properly. See the '4C' information code for troubleshooting.

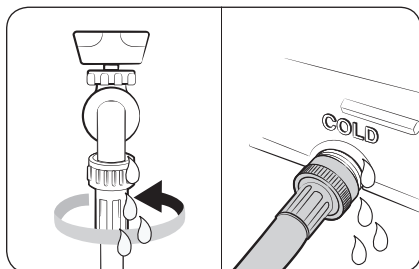

7. Open both taps, and then check if there is a leak.

⚠ CAUTION

To prevent water hoses from being bent or kinked, make sure there is at least a 6-inch (150 mm) space between the washer and the rear wall.

📖 NOTE

If you do not want to use hot water, insert the inlet cap into the hot water inlet. You must purchase the inlet cap. If the hot water inlet is closed with the inlet cap, you must select Cold for the water temperature.

STEP 6 Position the drain system

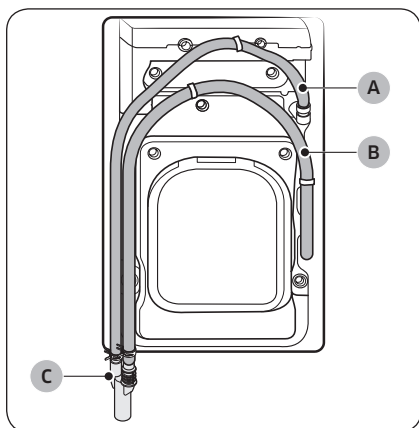

The pipe connector is attached on the product.

📖 NOTE

A : Upper drain hose

B : Lower drain hose

C : Pipe Connector

In a wall standpipe drain system

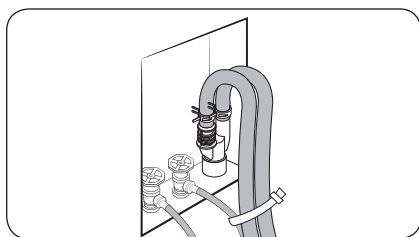

The drain hose must be placed into a wall standpipe drain system.

After inserting 2 drain hoses into the pipe connector, use the cable tie to bind the drain hoses, and then insert the pipe connector into the wall standpipe.

When complete, use the cable tie to bind the drain hose to the water hose.



Installation

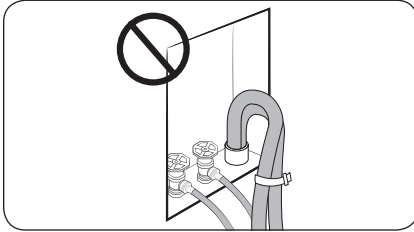

⚠ WARNING

Make sure to use the pipe connector before inserting the drain hoses. Without the pipe connector, the drain hose will not be positioned securely inside the wall standpipe, causing a water leak.

To position with the pipe connector

The pipe connector can be positioned in the following ways:

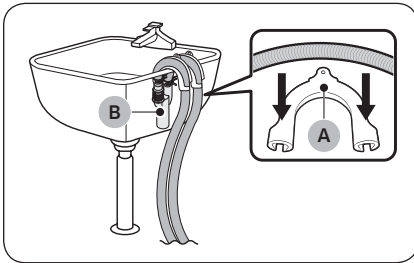

Over the edge of a wash basin

The **pipe connector (B)** must be placed at a height of between 24 inches (60 cm) and 35 inches (90 cm) from the floor. To keep the spout of the drain hose bent, use the supplied plastic **hose guide (A)**. Secure the guide to the wall using a hook to ensure stable drainage.

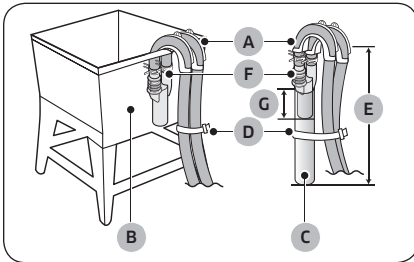

In a standpipe or laundry tub

The **laundry tub (B)** or **standpipe (C)** must be no shorter than 18 inches (46 cm) and no higher or longer than 96 inches (245 cm). Make sure the pipe connector and the standpipe are not airtight. The **height of the standpipe (E)** must be 43 inches (1100 mm) or higher from the floor.

📖 NOTE

A: Hose guide / D: Cable tie / F : Pipe Connector / G: 85 mm

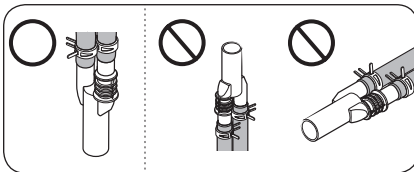

⚠ CAUTION

- Do not extend the (Y-shaped) pipe connector using an extension hose.
- Make sure you face the tip of the pipe connector downwards to the drain hole. Positioning the connector tip elsewhere can cause the drained water to flow backward.



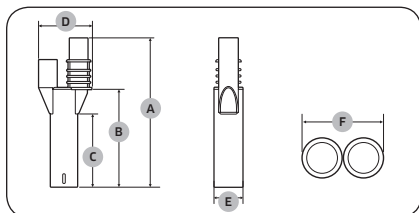

Dimensions of the pipe connector

A	172 mm	D	67 mm
B	112.5 mm	E	∅ 35
C	85 mm	F	60 mm

To position without the pipe connector

If you do not use the pipe connector, each drain hose can be positioned in the following ways:

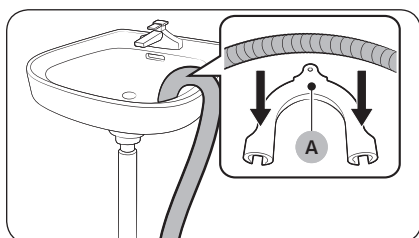

Over the edge of a wash basin

The drain hose must be placed at a height of between 24 inches (60 cm) and 35 inches (90 cm) from the floor. To keep the spout of the drain hose bent, use the supplied plastic **hose guide (A)**. Secure the guide to the wall using a hook to ensure stable drainage.

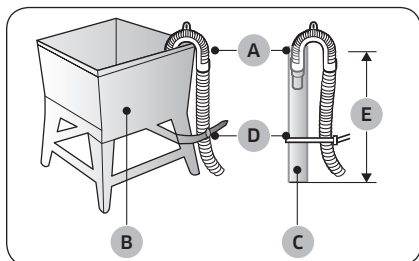

In a standpipe or laundry tub

The **laundry tub (B)** or **standpipe (C)** must be no shorter than 18 inches (46 cm) and no higher or longer than 96 inches (245 cm). Make sure the drain hose and the standpipe are not airtight. The **height of the standpipe (E)** must be 43 inches (1100 mm) or higher from the floor.

NOTE

A: Hose guide / D: Cable tie



Installation

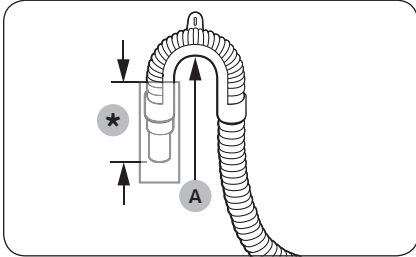

⚠ CAUTION

- Connect the **hose guide (A)** within 3–5 in. (7.6–12.7 cm)* from the end of the drain hose. If the drain hose is extended beyond the end of the hose guide, mold or microorganisms could spread inside the washer.
- The drain hose can be installed up to 96 in. (245 cm) high, but the draining capability can be reduced at the maximum height. Water remaining in the drain system may cause an odor.
- If the drain hose is installed less than 18 in. (46 cm) high, water can be drained during the process due to a siphon phenomenon. If this happens, a '4C' information code appears on the display.

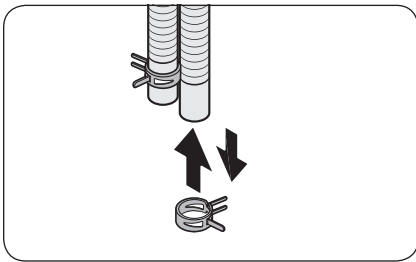

To position using the pipe connector

You washer comes with a pipe connector that is designed to join the upper drain hose and the lower drain hose. You can choose to use the connector to combine two drain hoses into a single outlet.

1. Insert the clamp ring on the end of the drain hose, one for each drain hose.

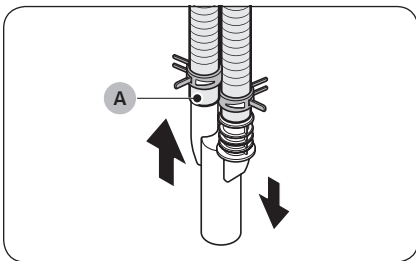

2. Insert the pipe connector into the drain hoses. Make sure the longer side **(A)** fits into the drain hose running from the lower washer.
3. Fix the position of the clamp rings near the end of each hose.

📖 NOTE

To remove the pipe connector, follow these steps above in the reverse order.



STEP 7 Final check and power on

- Before using your washer, make sure to remove the dehumidifying agent (silica gel) from inside the upper washer.
- Do not eat or swallow the dehumidifying agent (silica gel).
- The protective cover may form moisture on its surface after the washer has checked for a leak to ensure normal operation. This is normal, and does not indicate a defective part. Open the cover for a moment to remove the moisture.
- Plug the power cord into an AC 120 V / 60 Hz / 15 AMP approved electrical outlet protected by a fuse or circuit breaker. Then, tap  to turn on the washer.

Before you start

Initial setup

- When you turn on the washer for the first time, the screen shows the initial setup process. Follow the on-screen instructions to complete it.
- Once you select a language, the language selection screen will not reappear. However, you must complete a wash cycle once to stop the tutorial screen from reappearing.
- The initial setup includes language selection and a brief tutorial.
- Tap **OK** to skip to the next screen.

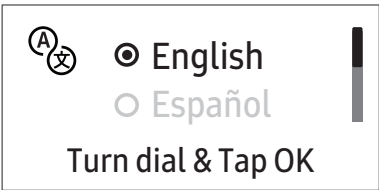
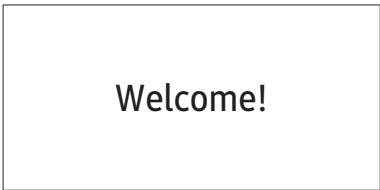
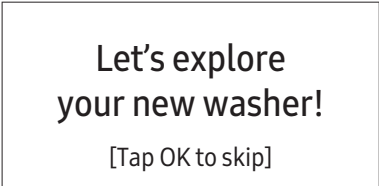
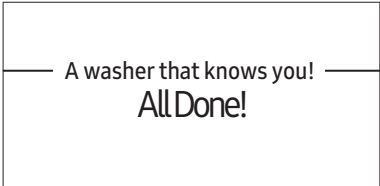
01 Language selection	02 Welcome screen
 <p>Turn dial & Tap OK</p>	 <p>Welcome!</p>
03 Tutorial	
 <p>Let's explore your new washer! [Tap OK to skip]</p>	 <p>A washer that knows you! All Done!</p>

Laundry guidelines

STEP 1 Sort

Sort the laundry according to these criteria:

- Care Label: Sort the laundry into cottons, mixed fibers, synthetics, silks, wools, and rayon.
- Color: Separate whites from colors.
- Size: Mixing different sized items together in the drum improves the washing performance.
- Sensitivity: Wash delicate items separately. For pure, new woolen items, curtains, and silk items, check the labels on the items.

 **NOTE**

Make sure to check the care label on all clothing, and sort clothing accordingly before starting the wash.

STEP 2 Empty pockets

Empty all the pockets of your laundry items

- Metal objects such as coins, pins, and buckles on clothing may damage other laundry items as well as the drum.

Turn clothing with buttons and embroideries inside out

- If pants or jacket zippers are open while washing, the drum may be damaged. Zippers should be closed and fixed with a string.
- Clothing with long strings may become entangled with other clothes. Make sure to tie the strings before starting the wash.

STEP 3 Use delicates bag

- Brassieres (water washable) are recommended to be placed in a delicates bag. Metal parts of the brassieres may break through and tear other laundry items.
- Small, light clothing such as socks, gloves, stockings, and handkerchiefs may become caught around the door. Place them inside a delicates bag.
- Do not wash the delicates bag by itself without other laundry. This may cause abnormal vibrations that could move the washer and result in injury.



Before you start

STEP 4 Determine the load capacity

Lower washer

Do not overload the washer. Overloading may cause the washer to wash improperly.

NOTE

When washing bedding or bedding covers, the wash time may be lengthened or the spin efficiency may be reduced. For bedding or bedding covers, the recommended maximum spin level is "Low or Medium Spin", and the load capacity is 7 lb (3.0 kg) or less.

CAUTION

If the laundry is unbalanced and the "Ub" information code is displayed, redistribute the load. Unbalanced laundry may reduce the spinning performance.

Upper washer

Laundry guidelines

Use the upper washer for small loads under 3.3 lb (1.5 kg).

Load	Shorts	Blue Jeans	Cotton pants	Shirts	Short-sleeved T-shirts
3.3 lb ↓ (1.5 kg ↓)	4	1	3	4	9

Load	T-shirts	Sports wear (upper)	Sports wear (pants)	Shower towel	Towel (small)
3.3 lb ↓ (1.5 kg ↓)	4	3	3	2	10

NOTE

- Use the recommended load for optimal washing performance. Overloads may reduce the performance.
- Use the lower washer for stubborn or heavily soiled loads or loads larger than recommended.



STEP 5 Add the correct detergent type

The type of detergent depends on the type of fabric (cotton, synthetic, delicate items, wool), color, wash temperature, and degree of soiling. Always use "low suds" HE laundry detergent which is designed for automatic washers.

NOTE

- Follow the detergent manufacturer's recommendations based on the weight of the laundry, the degree of soiling, and the hardness of the water in your local area. If you are not sure about the water hardness, contact your local water authority.
- Do not use detergent that has hardened or solidified. This detergent may remain after the rinse cycle, blocking the drain outlet.

CAUTION

When washing wool using the Wool cycle, use only a neutral liquid detergent. Powdered detergent used with the WOOL cycle can remain on the laundry and discolor it.

Use HE detergent only



- For the best cleaning results, use a high efficiency detergent such as Tide HE, Wisk HE, Cheer HE or Gain HE*. High efficiency detergents contain suds suppressors that reduce or eliminate suds. When fewer suds are produced, the load tumbles more efficiently and cleaning is maximized. (* Brand names are trademarks of their respective manufacturers.)

WARNING

For best results, use HE detergents only. Do not use non-HE detergent, organic detergent, natural detergent or HE detergents with natural ingredients (such as vinegar, baking soda).



Before you start

Guide to cleaning agents

Upper washer

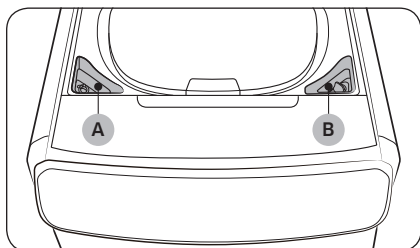

The upper washer provides two cleaning agent compartments: the left-side compartment for bleach, and the right side for fabric softener. You can apply detergent manually into the tub using the provided Aqua Pebble.

- **Bleach compartment (A):** Add non-chlorine bleach as instructed by the manufacturer.
- **Softener compartment (B):** Add a recommended amount of fabric softener as instructed by the manufacturer.

To apply cleaning agents to the upper washer

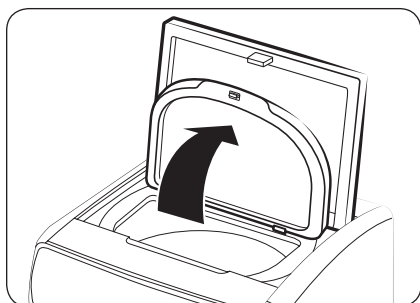

1. Open the top door, and then the protective cover. Remove the Aqua Pebble from the fabric softener container.



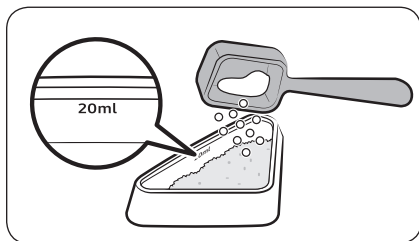

- Put a recommended amount of liquid or powdered detergent into the provided Aqua Pebble. The Aqua Pebble has a guide line (marked '20 ml') near its top, which is the max line. Do not exceed the max line.

⚠ CAUTION

- Any detergent to be added to the upper washer must be put in the provided Aqua Pebble.
- Use HE detergent only.
- If you are adding powdered detergent, use the provided detergent cup, and add only one cup of detergent. Excessive amounts of detergent may cause detergent residue.
- Make sure the powdered detergent you add is a finely ground variety.
- Do not use the Aqua Pebble for bleach and/or fabric softener.

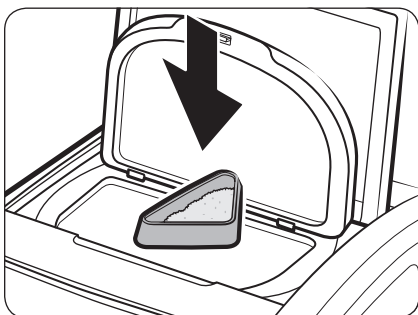

- Insert the Aqua Pebble around the center of the tub, and then put the laundry over the Aqua Pebble.

⚠ CAUTION

Make sure the Aqua Pebble is input first so it is placed under the laundry. Otherwise, detergent may not dissolve fully, causing residue after the wash is complete.

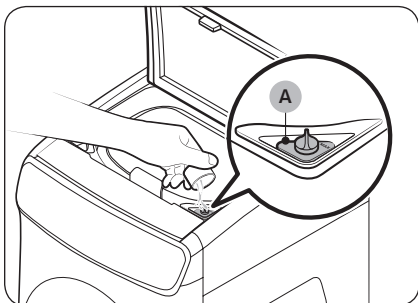

- Add a recommended amount of fabric softener to the softener compartment. Do not exceed the **max line (A)**.



Before you start

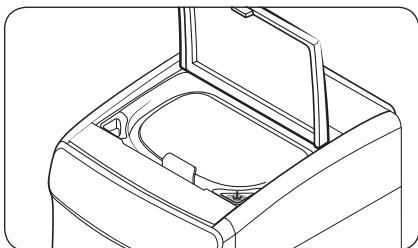

5. Add a recommended amount of non-chlorine bleach to the bleach compartment. Use caution not to overfill the compartment.
6. Close the protective cover, and then the top door.

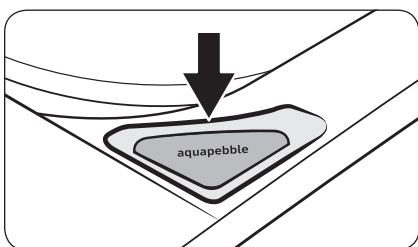

NOTE

When the cycle is complete, take out the Aqua Pebble, turn it over, and put it on the softener compartment for later use (see the figure). The Aqua Pebble is designed to fit in the softener compartment after it has been turned over.

CAUTION

- Do not use chlorine bleach, which may damage the laundry.
- Use caution when inserting the Aqua Pebble as it is supposed to be balanced at the beginning of the wash. Tipping the Aqua Pebble before the start of a wash may cause detergent residue to remain on the laundry at the end of the wash, causing discoloration of the laundry and/or reduced washing performance.
- Before each wash, make sure to clean the Aqua Pebble before adding fresh detergent.
- Do not insert the Aqua Pebble into a folded item or between different laundry items.
- Do not use liquid or powdered chlorine bleach.
- Do not put or store cleaning agents such as detergent, bleach, and fabric softener on top of your washer. Wipe up any spills immediately to prevent damage to the washer, especially the finish and the control panels.

NOTE

- It is normal for a small amount of water to remain in the detergent compartments at the end of a cycle.
- When adding color-safe bleach, we recommend you also use liquid detergent.
- When the wash is complete, remove the Aqua Pebble from the tub and clean it so that it is readily available for later use.



Lower washer

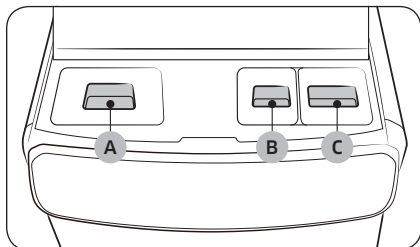

The lower washer provides three cleaning agent compartments: the left-most compartment for the main wash, the right-first one for bleach, and the far right for fabric softener.

- **Main wash compartment (A):** Add a recommended amount of liquid (or powdered) detergent to the main wash compartment.
- **Bleach compartment (B):** Add chlorine bleach as instructed by the manufacturer.
- **Softener compartment (C):** Add a recommended amount of fabric softener to the softener compartment.

⚠ CAUTION

- Do not put tablet or capsule types of detergent in the detergent compartment. Tablet or capsule types of detergent must be put directly in the drum.
- Do not use a ball type detergent.
- To prevent the compartment from clogging, concentrated or highly-enriched agents (fabric softener or detergent) must be diluted with water before being added.

To apply cleaning agents to the lower washer

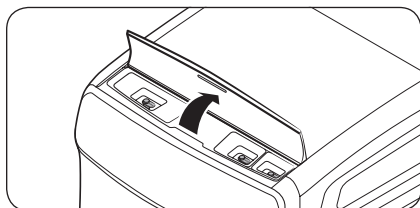

1. Open the top-front cover.

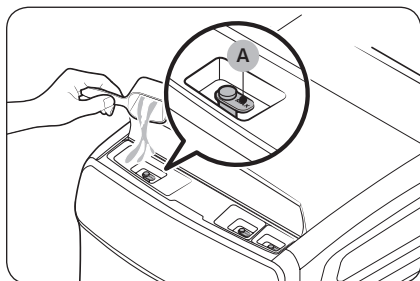

2. Add a recommended amount of liquid or powdered detergent to the detergent compartment. Do not exceed the **max line (A)**.

📖 NOTE

To apply powdered detergent, first remove the liquid detergent container.



Before you start

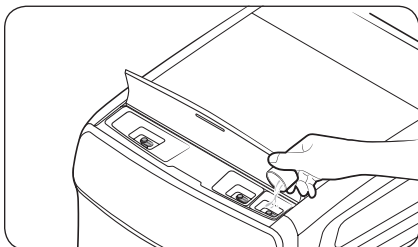

3. Add a recommended amount of fabric softener to the softener compartment. Do not exceed the max line.

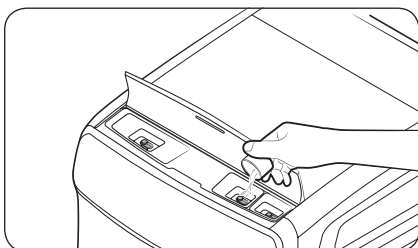

4. If you want to add bleach, add a recommended amount of chlorine bleach to the bleach compartment. Do not exceed the max line.
5. Close the top-front cover.

NOTE

- If you use a high efficiency (HE) detergent, apply 2/3 of the recommended amount to the main wash compartment.
- Oxygen boosters can increase washing performance. Make sure to add the oxygen booster after putting the laundry into the drum.
- To use both powdered detergent and powdered oxygen booster, it is more effective to put them together into the drum before loading the laundry.



Operations

Your dual loading washer features upper and the lower washers for your convenience. The upper washer is an automatic tub loader that is designed to wash relatively small loads while the lower washer is a drum loader that takes care of normal or relatively heavy loads.

⚠ WARNING

To reduce the risk of fire, electric shock, or injury to persons, read the IMPORTANT SAFETY INSTRUCTIONS before operating this washer.

Control panel

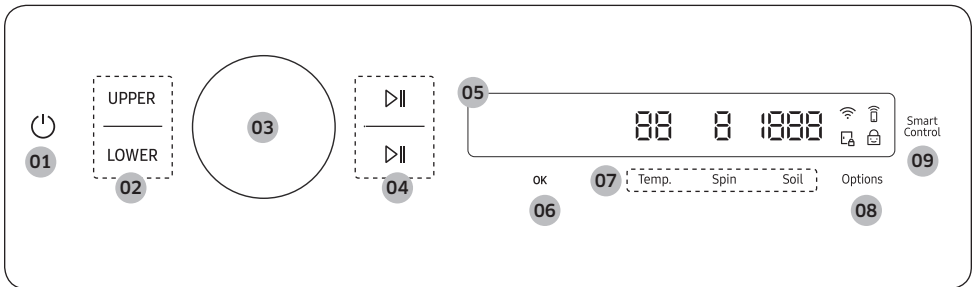





<p>01 Power </p>	<p>Tap to turn the washer on or off.</p> <ul style="list-style-type: none"> If you do not manipulate the control panel for 10 minutes after turning on the washer, the washer automatically turns off. The washer automatically turns off when the cycle completes. <p>⚠ CAUTION Do not tap to turn off the power while the cycle is in progress. Tap to pause the cycle first, and then tap to turn off the power.</p>
<p>02 UPPER / LOWER</p>	<p>Tap UPPER to select the upper washer and use its features.</p> <ul style="list-style-type: none"> You can tap and hold UPPER for 3 seconds to cancel the upper washer operation. <p>Tap LOWER to select the lower washer and use its features.</p> <ul style="list-style-type: none"> You can tap and hold LOWER for 3 seconds to cancel the lower washer operation.
<p>03 Navigation dial</p>	<p>Turn the navigation dial left or right to navigate through cycles and functions. Your selection (such as cycle, additional functions, and system functions) is displayed on the LCD as you turn the navigation dial.</p>
<p>04 Start/Pause </p>	<p>You can start or pause the operation.</p> <ul style="list-style-type: none"> The upper button controls the upper washer, and the lower button controls the lower washer. Tap and hold the button to start the operation. During the operation, tap the button to pause.

Operations

05 Display	The display shows current cycle information and estimated time remaining, or an information message when a problem occurs.
06 OK	Tap to confirm your selection of function or setting. <ul style="list-style-type: none"> The button is inactive when the selected function or setting is not supported.
07 Wash cycle settings	Tap the desired button to change the default wash cycle settings. <ul style="list-style-type: none"> Temp.: Tap to change the water temperature for the selected cycle. Spin: Tap to change the spin speed for the selected cycle. <ul style="list-style-type: none"> Drain & No Spin: The drum does not spin after the final drain process. Rinse Hold & No Spin (All indicators are off): The final rinse process is suspended so that the laundry remains in the water. To unload the laundry, run a drain or spin process. Soil: Tap to change the soil level for the current cycle.
08 Options	Tap to enter the Options menu. Tap and hold for 3 seconds to enter the System Functions menu.
09 Smart Control	Tap to activate or deactivate the Smart Control function. Tap and hold to enter pairing mode to connect to the SmartThings app. <ul style="list-style-type: none"> When the Smart Control function is activated, you can control your washer remotely using the SmartThings app on your smartphone or tablet (Android or iOS). When you tap the button, the Smart Control function activates on both the upper and lower washers.

Icon descriptions

	Wi-Fi	<ul style="list-style-type: none"> This icon indicates that the washer is connected to Wi-Fi.
	Door Lock	<ul style="list-style-type: none"> This icon indicates the door is locked and cannot be opened. The door locks automatically during a cycle and this indicator turns on. You can open the door when this icon disappears.
	Smart Control	<ul style="list-style-type: none"> This icon indicates that the washer's Smart Control is on. For more information on Smart Control, see page 56.
	Child Lock	<ul style="list-style-type: none"> This icon indicates that Child Lock is on. For more information on Child Lock, see page 53.

Operating a cycle

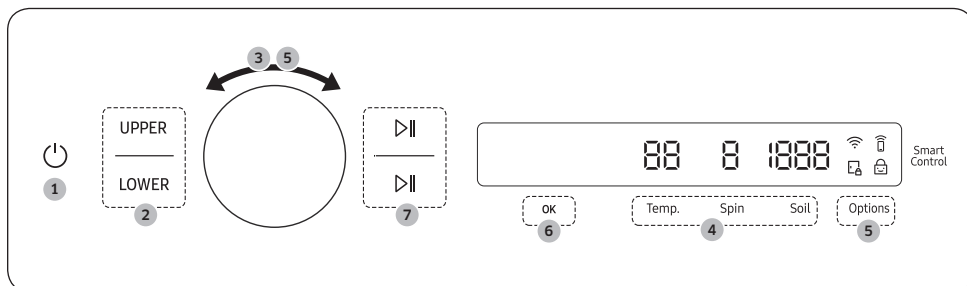



1. Tap to turn the power on.
2. Tap **UPPER** or **LOWER**.
 - Tap **UPPER** to select the upper washer and use its features.
 - Tap **LOWER** to select the lower washer and use its features.
3. Turn the **Navigation dial** to select the cycle you want.
 - For more information on **Cycle overview**, see page 45.
4. Change the default cycle options.
 - Tap **Temp.**, **Spin**, or **Soil** to change the default cycle settings.
5. Tap **Options**, and then turn the **Navigation dial** to select the desired additional function.
 - For more information on **Options**, see page 51.
6. Tap **OK** to change the settings for selected additional function.
 - Not all cycles have additional functions available.
7. Tap and hold to start operation.
 - Once you set the cycle you want, the screen displays a brief cycle description, and cycle time. You can also check the cycle progress, remaining cycle time, and information codes.



Operations

To change the cycle during operation

1. Tap  of the upper or lower washer to stop the operation temporarily.
2. Turn the **Navigation dial** to select a different cycle.
3. Tap and hold  of the upper or lower washer to start the new cycle.

WARNING

- Do not put anything on top of your washer while it is running.
- While the lower washer is operating, the protective cover may have wet steam due to the temperature difference between the upper and lower parts of the washer.

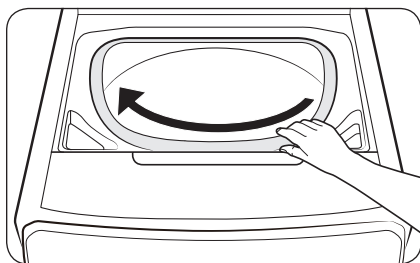

CAUTION

- When using the upper washer, you may not see all the remaining clothes after a cycle is finished, especially those in the front area of the tub.
- When the cycle is complete, turn the tub manually to check if there are any clothes remaining in the tub.

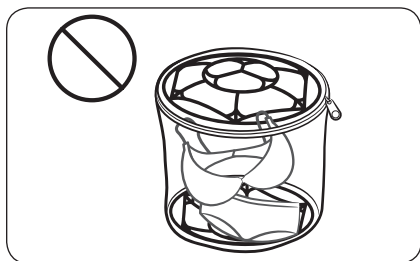

CAUTION

- When using the upper washer, do not use a delicates bag featuring a protective plastic rim. Otherwise, the net may cause a system failure.



Cycle overview

Cycle descriptions

You can add or delete cycles to personalize the cycle list in the My Cycles option. See page 52 for more information.

Upper washer

Cycle	Description
Normal	<ul style="list-style-type: none"> For lightly soiled cotton, t-shirts, towels, and mixed loads. Use to wash lightly soiled normal items, except delicate fabrics such as silk or handwash-only fabrics.
Delicates	<ul style="list-style-type: none"> For sheer fabrics, bras, lingerie, silks, and other handwash-only fabrics. For best results, use liquid detergent.
Activewear	<ul style="list-style-type: none"> For exercise wear such as training pants, shirts/tops, and other performance clothing. This cycle provides effective soil removal with controlled tub rotation for special fabric care.
Self Clean	<ul style="list-style-type: none"> Cleans the tub by removing dirt. Perform once every 20 washes. Make sure the tub is empty.
Rinse+Spin	<ul style="list-style-type: none"> Features an additional rinse process after fabric softener is applied to the laundry.
Spin Only	<ul style="list-style-type: none"> To perform the spin process only.

Operations

Lower washer

Cycle	Description
Normal	<ul style="list-style-type: none">For cottons, bed linens, table linens, underwear, towels, or shirts. The washing time and the rinse count are automatically adjusted according to the load.
Heavy Duty	<ul style="list-style-type: none">For sturdy, colorfast fabrics and heavily soiled items.
Super Speed	<ul style="list-style-type: none">Normal cycle with the Super Speed option.The shortened time may differ depending on the load/options.
Small Load	<ul style="list-style-type: none">For lightly soiled items that you want to finish washing quickly.For best performance, recommended load is 4 lb (2.0 kg) or lower.
Delicates	<ul style="list-style-type: none">For sheer fabrics, bras, lingerie (silk), and other handwash-only fabrics.
Steam Whites	<ul style="list-style-type: none">For white items. You can wash with or without bleach.
Steam Sanitize	<ul style="list-style-type: none">For colorfast fabrics and heavily soiled laundry, this cycle heats the supplied water over 60 °C to clean deeply.If you stop running the cycle while the washer is heating the water, the door remains locked for your safety.
Steam Normal	<ul style="list-style-type: none">For washing everyday garments with steam.
Towels	<ul style="list-style-type: none">For bath towels, washcloths, and mats.
Bedding	<ul style="list-style-type: none">For bulky items such as comforters, blankets, and sheets.For best results, wash only 1 type of bedding.For bulky items, use liquid detergent and do not roll the items in the drum because they might get stuck in the drum.
Outdoor	<ul style="list-style-type: none">For outdoor clothes, skiwear, and sportswear that are made of functional materials such as spandex, stretch, and micro-fiber.
Activewear	<ul style="list-style-type: none">For exercise wear such as sports jerseys, training pants, shirts/tops and other performance clothing. This cycle provides effective soil removal with controlled drum rotation for special fabric care.
Denim	<ul style="list-style-type: none">For denim and jeans.Wash inside out.Denim and jeans often contain excess dye and may run during the first few washes. Wash light and dark colored items separately.
Wool	<ul style="list-style-type: none">Specific for machine-washable wool for loads less than 4 lb (2.0 kg).The Wool cycle features fine pulsating and soaking to protect the wool fibers from shrinkage/distortion.A neutral detergent is recommended.

Cycle	Description
Colors	<ul style="list-style-type: none"> This cycle washes items in low-temperature water to prevent discoloration.
Perm Press	<ul style="list-style-type: none"> For wash-and-wear, synthetic fabrics, and lightly to normally soiled items.
Eco Cold	<ul style="list-style-type: none"> For normally and lightly soiled items. This cycle uses only cold water to save energy. Cold water also helps prevent fabric damage.
Steam Bulky	<ul style="list-style-type: none"> Bedding cycle with the steam function.
Steam Allergen	<ul style="list-style-type: none"> To remove dust, pollen, and other non-living allergen substances from fabric.
Power Steam	<ul style="list-style-type: none"> Heavy Duty cycle with the steam function.
Power Rinse	<ul style="list-style-type: none"> To wash with powerful rinsing performance.
Spin Only	<ul style="list-style-type: none"> To perform the spin process only.
Rinse+Spin	<ul style="list-style-type: none"> Features an additional rinse process after fabric softener is applied to the laundry.
Self Clean+	<ul style="list-style-type: none"> Cleans the drum by removing dirt and build-up from the drum. Perform once every 40 washes. Make sure the drum is empty.



Operations

Cycle chart

Use this chart to set the best cycle and options for your laundry.

Upperwasher

Setting	Temp.	Spin	Soil Level
● : factory setting	3 : Warm	-	-
○ : can be selected	2 : Cold	2 : Low	2 : Light
	1 : Tap Cold	1 : Extra Low	1 : Extra Light

Cycle	Functions						
	Temp.			Spin		Soil Level	
	3	2	1	2	1	2	1
Normal	●	○	○	●		●	○
Delicates	○	○	●	●	○	●	○
Activewear	●	○	○	○	●	○	●
Rinse+Spin				●	○		
Spin Only				●	○		
Self Clean	●				●	●	

Cycle	Options
	Extra Rinse
Normal	○
Delicates	
Activewear	○
Rinse+Spin	○
Spin only	
Self Clean	



Lower washer

Setting	Temp.	Spin	Soil Level
● : factory setting	5 : Extra Hot	5 : Extra High	5 : Extra Heavy
○ : can be selected	4 : Hot	4 : High	4 : Heavy
	3 : Warm	3 : Medium	3 : Normal
	2 : Cold	2 : Low	2 : Light
	1 : Tap Cold	1 : Extra Low	1 : Extra Light

Cycle	Functions														
	Temp.					Spin					Soil Level				
	5	4	3	2	1	5	4	3	2	1	5	4	3	2	1
Normal	○	○	●	○	○	○	●	○	○	○	○	○	●	○	○
Steam Normal		●				○	●	○	○	○	○	○	●	○	○
Colors					●	○	●	○	○	○	○	○	●	○	○
Power Rinse		○	●	○	○	○	●	○	○	○	○	○	●	○	○
Super Speed		○	●			○	●	○	○	○	○	○	●	○	○
Heavy Duty	○	●	○	○	○	●	○	○	○	○	●	○	○	○	○
Power Steam		●				●	○	○	○	○	●	○	○	○	○
Bedding			●	○	○			○	●	○	○	○	●	○	○
Steam Bulky			●					○	●	○	○	○	●	○	○
Steam Whites		●				○	●	○	○	○	○	○	●	○	○
Steam Sanitize	●					○	●	○	○	○	○	○	●	○	○
Steam Allergen		●				○	●	○	○	○	○	○	●	○	○
Perm Press			●	○	○		○	○	●	○	○	○	●	○	○
Small Load		○	●	○	○	●	○	○	○	○	○	○	○	○	●
Towels		○	●	○	○	○	●	○	○	○	○	○	●	○	○
Eco Cold				○	●	○	●	○	○	○	○	○	●	○	○
Activewear			●	○	○				●	○	○	○	●	○	○
Delicates			○	○	●			●	○	○	○	○	●	○	○
Wool			●	○	○				●	○			●		
Outdoor			●	○	○			●	○	○	○	○	●	○	○
Denim			●	○	○			●	○	○	○	○	●	○	○
Rinse+Spin						○	●	○	○	○					
Spin Only						○	●	○	○	○					
Self Clean+	●					●							●		

Operations

English

Cycle	Options		
	Pre Soak	Super Speed	Extra Rinse
Normal	<input type="radio"/>		<input type="radio"/>
Steam Normal	<input type="radio"/>		<input type="radio"/>
Colors	<input type="radio"/>		<input type="radio"/>
Power Rinse	<input type="radio"/>		<input type="radio"/>
Super Speed		<input checked="" type="radio"/>	<input type="radio"/>
Heavy Duty	<input type="radio"/>	<input type="radio"/>	<input type="radio"/>
Power Steam	<input type="radio"/>	<input type="radio"/>	<input type="radio"/>
Bedding	<input type="radio"/>	<input type="radio"/>	<input type="radio"/>
Steam Bulky	<input type="radio"/>	<input type="radio"/>	<input type="radio"/>
Steam Whites	<input type="radio"/>	<input type="radio"/>	<input type="radio"/>
Steam Sanitize	<input type="radio"/>		<input type="radio"/>
Steam Allergen	<input type="radio"/>		<input type="radio"/>
Perm Press	<input type="radio"/>		<input type="radio"/>
Small Load			<input type="radio"/>
Towels	<input type="radio"/>		<input type="radio"/>
Eco Cold	<input type="radio"/>		<input type="radio"/>
Activewear	<input type="radio"/>		<input type="radio"/>
Delicates			<input type="radio"/>
Wool			
Outdoor			<input type="radio"/>
Denim	<input type="radio"/>		<input type="radio"/>
Rinse+Spin			<input type="radio"/>
Spin Only			
Self Clean+			

Options

Using Options

1. Tap **UPPER** or **LOWER** to select the upper or lower washer.
2. Tap **Options**.
3. Turn the **Navigation dial** to select the desired additional function.
4. Tap **OK** to change the selected function's settings or start the function.

NOTE

- To return to the main screen, tap **Options** again or turn the **Navigation dial** to select **Back**, and then tap **OK**.
- If the selected function is not supported, the "**Currently not supported.**" message is displayed, and the **OK** button is not activated.
- When you select an additional function, a brief help message appears for the first ten times of use.
- Only the **Extra Rinse**, **My Cycles**, and **Child Lock** functions are available for the upper washer.

Super Speed

Use this function if you need to shorten the washing time.

1. Tap **Options**.
2. Turn the **Navigation dial** to select **Super Speed**, and then tap **OK**.
3. Tap **OK** to select **On** or **Off**.
 - Only available with **Super speed**, **Heavy Duty**, **Power Steam**, **Bedding**, **Steam Bulky**, and **Steam Whites** cycles.
 - The shortened time may differ depending on the load/options.

Extra Rinse

Adds an additional rinse at the end of the cycle to remove laundry additives more thoroughly.

1. Tap **UPPER** or **LOWER** to select the upper or lower washer.
2. Tap **Options**.
3. Turn the **Navigation dial** to select **Extra Rinse**, and then tap **OK**.
4. Tap **OK** to select **On** or **Off**.

Pre Soak

This adds 30 minutes of soaking time at the start of the wash cycle for better stain removal.

1. Select a cycle and change the cycle settings as necessary.
2. Tap **Options**.
3. Turn the **Navigation dial** to select **Pre Soak**, and then tap **OK**.
4. Tap **OK** to select **On** or **Off**.

Operations

My Cycles

Add or remove cycles to create a personal cycle list.

1. Tap **UPPER** or **LOWER** to select the upper or lower washer.
2. Tap **Options**.
3. Turn the **Navigation dial** to select **My Cycles**, and then tap **OK**.
 - You can only edit a cycle to create a personal cycle when the washer is not operating.
4. Turn the **Navigation dial** to select a desired cycle.
5. Tap **OK** to add or remove the selected cycle.
 - Addition and removal of the cycle is saved automatically.
6. Once you finish creating My Cycles, tap **Options** to return to the cycles screen.

NOTE

- The Normal, Self Clean (upper), and Self Clean+ (lower) cycles cannot be removed from the cycles list.
- You can also edit My Cycles in the SmartThings app.



Drum Light

You can turn the drum light on or off.

1. Tap **Options**.
2. Turn the **Navigation dial** to select **Drum Light**, and then tap **OK**.
3. Tap **OK** to select **On** or **Off**.

Delay End

You can set the washer to finish your wash automatically at a later time, choosing a delay of between 1 to 24 hours (in 1 hour increments). The hour displayed indicates the time the wash will finish.

1. Select a cycle and change the cycle settings as necessary.
2. Tap **Options**.
3. Turn the **Navigation dial** to select **Delay End**, and then tap **OK**.
4. Turn the **Navigation dial** to select the desired time, and then tap **OK**.
5. Tap and hold 
 - Status shows in the display and the washer tumbles the drum to sense the weight of the load (if load sensing is preset for the selected cycle). When load sensing is complete, the display shows the remaining time until the end of the wash cycle.
 - To cancel Delay End, tap  to restart the washer.

Child Lock

To prevent children or infants from accidentally starting or setting the washer, Child Lock locks all buttons except for  and **Options**.

1. Tap **Options**.
2. Turn the **Navigation dial** to select **Child Lock**, and then tap **OK**.
3. Tap **OK** to select **On** or **Off**.

NOTE

- Child Lock applies to both the upper and lower washers.
- When Child Lock is on, all buttons are disabled except for  and **Options**. The washer door also locks.
- Tapping a button while Child Lock is on triggers an alarm with the "**Child Lock On**" message.
- You cannot open the door after a wash cycle when the Child Lock is on. Turn the function off before opening the door to take out the laundry.



Operations

System Functions

Using System Functions

1. Tap and hold **Options** for 3 seconds.
2. Turn the **Navigation dial** and select the desired system function, and then tap **OK**.
3. Tap **OK** to change the selected function's settings or start the function.

NOTE

To return to the main screen, tap **Options** again or turn the **Navigation dial** to select **Back**, and then tap **OK**.

AI Pattern

This function saves frequently used cycles and settings. When you turn the function on, the washer remembers the cycles you use most and their settings (Temp., Rinse, Spin) and displays them in frequency order.

1. Tap and hold **Options** for 3 seconds.
2. Turn the **Navigation dial** to select **AI Pattern**, and then tap **OK**.
3. Tap **OK** to select **On** or **Off**.
 - The default setting is On. Set it to Off if you do not want to use this function.
 - When you turn off the function, all the saved data resets.

Alarm

You can turn the sound on or off from the washer. When this function is set to Off, the melody of cycle completion and the power-off beep does not sound. However, the other sounds stay active.

1. Tap and hold **Options** for 3 seconds.
2. Turn the **Navigation dial** to select **Alarm**, and then tap **OK**.
3. Tap **OK** to select **On** or **Off**.
 - The default setting is On.

NOTE

The setting remains unchanged even if you restart the washer.



Calibration

You can run calibration again for accurate weight detection.

1. Tap and hold **Options** for 3 seconds.
2. Turn the **Navigation dial** to select **Calibration**, and then tap **OK**.
 - Calibration does not start if the door is not closed properly.
 - The drum rotates clockwise and anticlockwise for about 4 minutes.
3. When calibration is complete, the "**Calibration complete**" message appears on the display and the washer turns off automatically.

Wi-Fi

You can turn the washer's Wi-Fi on or off.

1. Tap and hold **Options** for 3 seconds.
2. Turn the **Navigation dial** to select **Wi-Fi**, and then tap **OK**.
3. Tap **OK** to select **On** or **Off**.
 - The washer's Wi-Fi is off as a factory default setting. However, the washer's Wi-Fi turns on automatically when you turn on the washer for the first time. Then, the final Wi-Fi setting maintains regardless of the washer power status.
 - Once you turn on the washer's Wi-Fi and connect to a network, the washer remains connected to the network even when you turn off the power.
 - The Wi-Fi  indicates that the washer is connected to the router through the Wi-Fi connection.

Language

You can change the system language.

1. Tap and hold **Options** for 3 seconds.
2. Turn the **Navigation dial** to select **Language**, and then tap **OK**.
3. Turn the **Navigation dial** to select the desired language, and then tap **OK**.

Self diagnosis

You can use this function to check if there are any abnormal signs on your washer.

1. Tap and hold **Options** for 3 seconds.
2. Turn the **Navigation dial** to select **Self diagnosis**, and then tap **OK**.
 - Self diagnosis starts immediately and the result appears on the screen once the diagnosis is complete.

Factory Reset

You can reset the washer.

1. Tap and hold **Options** for 3 seconds.
2. Turn the **Navigation dial** to select **Factory Reset**, and then tap **OK**.
 - Your washer resets to the factory setting.



Operations

Special features

Smart control

You can connect to the SmartThings app and control your washer remotely.

Connecting your washer

1. Download and open the SmartThings app on your smartphone or tablet (Android & iOS).
2. Tap  to turn on the washer.
3. Tap and hold **Smart Control**.
 - a. The washer enters AP mode and connects to your smartphone or tablet.
 - b. Tap **Smart Control** to authenticate your washer.
 - c. Once the authentication process is complete, your washer is successfully connected to the app.
 - You can use various features available in the SmartThings app.

NOTE

- If your washer fails to connect with the SmartThings app, try again.
- Check your router if you experience any Internet connection problem after connecting your washer with the SmartThings app.
- If the Wi-Fi is off, tap and hold **Options** for 3 seconds to enter the System functions menu, and select Wi-Fi to turn it on.
- Turning the washer's Wi-Fi on allows you connect to the washer via SmartThings app on your smartphone or tablet, regardless of the power status of the washer. However, the washer appears offline on the SmartThings app if the washer's Wi-Fi is off.
- Close the door before starting the Smart Control function.
- If you use your washer for a while without connecting it to the SmartThings app, a pop-up message about Smart Control will show for 3 seconds on 20th, 40th, and 60th use.
- If the washer's Wi-Fi is not connected to an AP (access point), the Wi-Fi will turn off when you turn off the power.



Stay Connect

Set up the Stay Connect function in your SmartThings app to keep Smart Control turned on at the end of a cycle. Your washer stays connected to the app so you can send additional instructions, whether you are at home or away.

1. If you turn on the Stay Connect function on the SmartThings app, the washer will stay in standby power saving mode after completing a cycle.
 - The Stay Connect function will remain active for up to 24 hours if the door remains closed.
2. When the Stay Connect function is active, the Smart Control, Door Lock, and Wi-Fi icons are illuminated on your washer display.
3. You can conveniently control your washer, adding rinse, spin cycles using the SmartThings app.

NOTE

- The washer switches to standby power saving mode when operation is paused even if the machine is not connected to the SmartThings app.
- In some circumstances, only the Door Lock icon may be illuminated.



Operations

SmartThings

Wi-Fi connection

On your smartphone or tablet, go to **Settings** and turn on the wireless connection and select an AP (Access Point).

- This appliance supports the Wi-Fi 2.4 GHz protocols.

Download

On an app market (Google Play Store, Apple App Store, Samsung Galaxy Apps), find the SmartThings app by searching for "SmartThings". Download and install the app on your device.

NOTE

The app is subject to change without notice for improved performance.

Log in

You must first log into SmartThings with your Samsung account. To create a new Samsung account, follow the instructions on the app. You don't need a separate app to create your account.

NOTE

If you have a Samsung account, use the account to log in. A registered Samsung smartphone or tablet user automatically logs in.

To register your appliance to SmartThings

1. Make sure your smartphone or tablet is connected to a wireless network. If not, go to **Settings** and turn on the wireless connection and select an AP (Access Point).
2. Open **SmartThings** on your smartphone or tablet.
3. If you see the message, "**A new device is found.**", select **Add**.
4. If no message appears, select **+** and select your appliance in a list of devices available. If your appliance is not listed, select **Device Type** > **Specific Device Model**, and then add your appliance manually.
5. Register your appliance to the SmartThings app as follows.
 - a. Add your appliance to SmartThings. Make sure your appliance is connected to SmartThings.
 - b. When registration is complete, your appliance appears on your smartphone or tablet.

If you're moving out, we recommend you completely wipe the appliance and do a network reset on it before you leave it behind.

If you're moving in, the easiest way to take control and remove the previous user's access is to add it to SmartThings yourself. But if you don't plan on using SmartThings, a network reset should be performed to protect your privacy. In rental properties, there's a regular change of ownership. To ensure resident privacy, Wi-Fi and/or other connectivity settings should be reset at each change of resident. Please refer to factory reset instructions in this manual.



Maintenance

Keep the washer clean to prevent its performance from deteriorating and to preserve its life cycle.

WARNING

Certain internal parts are intentionally not grounded and may present a risk of electric shock only during servicing. Service personnel – Do not contact the following parts while the appliance is energized: Control board, heat sink, motor, inlet valve and pump.

General considerations

Cleaning

Surface of the washer

Use a soft cloth with a nonabrasive household detergent. Do not spray water onto the washer

Exterior

1. Turn off the water taps after finishing the day's washing. This will shut off the water supply to your washer and prevent the unlikely possibility of damage from escaping water. Leave the door open to allow the inside of your washer to dry out.
2. Use a soft cloth to wipe up all detergent, bleach, or other spills as they occur. Clean the following as recommended below:
 - Control panels – Clean with a soft, damp cloth. Do not use abrasive powders or cleaning pads. Do not spray cleaners directly on the panels.
 - Cabinet – Clean with soap and water.

Interior

Clean the interior of your washer periodically to remove any dirt, soil, odor, mold, mildew, or bacterial residue that may remain in your washer as a result of washing clothes.

CAUTION

Failure to follow these instructions may result in unpleasant conditions, including odors and/or permanent stains on your washer or laundry.

NOTE

Hard water deposits may be removed, if needed. Use a cleaner labeled "Washer safe".

Maintenance

Mesh filter

Clean the mesh filter of the water hose once or twice a year.

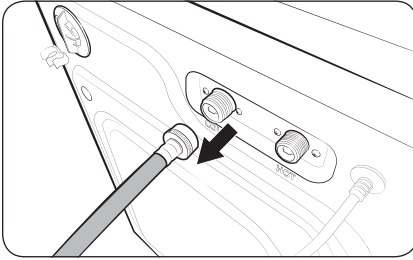

1. Turn off the washer, and then unplug the power cord.
2. Close the taps.
3. Loosen and disconnect the water hose from the back of the washer. Cover the end of each hose with a cloth to prevent water from gushing out.

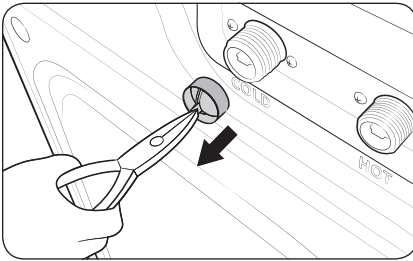

4. Use pliers to pull out the mesh filter from the inlet valve.
5. Submerge the mesh filter deeply in water so that the threaded connector is also submerged.
6. Dry the mesh filter completely in a shaded area.
7. Reinsert the mesh filter into the inlet valve, and reconnect the water hose to the inlet valve.
8. Open the tap.

NOTE

If the mesh filter is clogged, the "4C" information code appears on the washer's display.

Recovery from freezing

The washer may freeze when the temperature in its location drops below 32 °F (0 °C).

1. Turn off the washer, and then unplug the power cord.
2. Pour warm water over the tap to loosen the water hose.
3. Disconnect the water hose, and soak it in warm water.
4. Pour warm water into the drum (tub) and leave it for about 10 minutes.
5. Reconnect the water hose to the tap.

NOTE

If the washer still doesn't operate normally, repeat the steps above until it operates normally.

If the washer will not be used for an extended period of time

Avoid leaving the washer unused for an extended time. If you intend to leave the washer unused for a long period of time, follow the directions below:

1. Press **Power**, and then select **Rinse+Spin**.
2. Empty both the drum and the tub, close the door, and then press **Start/Pause**.
3. When the cycle is complete, close the tap and disconnect the water hoses.
4. Turn off the washer, and then unplug the power cord.
5. Open the doors to let air circulate through the drum and the tub.





Maintenance

Upper washer

Self Clean

Certain usage and environmental conditions may result in some residue build-up or odor in the washer tub. To prevent this build-up of residue or odor causing bacteria and keep your washer tub fresh and clean, perform the Self Clean cycle at least once a month or every 20 cycles. Perform the recommended procedure below when using the Self Clean cycle.

1. Remove all items from the washer tub and ensure the tub is empty. Laundry left in the tub during the Self Clean cycle may be damaged.
2. Tap  to turn the power on.
3. Tap **UPPER**.
4. Turn the **Navigation dial** to select **Self Clean**.
5. Tap and hold upper .

NOTE

- The water temperature for Self Clean is defaulted to 3 (Warm). This temperature cannot be changed.
- In the case where residue is present in the washer tub, add 1/3 cup (2.7 fl. oz., 80 ml) of liquid chlorine bleach directly to the empty tub before you start the Self Clean cycle. Do not use or mix any other detergent or chemicals during the Self Clean cycle.
- If necessary, run a Rinse+Spin Cycle after the Self Clean cycle has completed to help remove any remaining residue.

CAUTION

- Check the washer tub before using the Self Clean cycle. Remove any remaining water in the tub by running a Spin Only cycle prior to starting the Self Clean cycle.
- If there is chlorine bleach left in the washer tub for an extended period of time, rust can occur.

Self Clean reminder

- After 20 washing cycles, the Self Clean LED reminder icon and the Self Clean cycle LED will blink on the control panel for an hour and then turn off automatically.
- The reminder will appear on the control panel for 5 additional consecutive cycles before turning off. The next reminder will not appear until another 20 cycles have been completed.



Fabric softener/bleach compartment

Both the fabric softener compartment and the bleach compartment on the upper washer are not removable by design to facilitate visual feedback to users. To clean the softener compartment, follow these instructions. Cleaning the bleach compartment is basically the same.

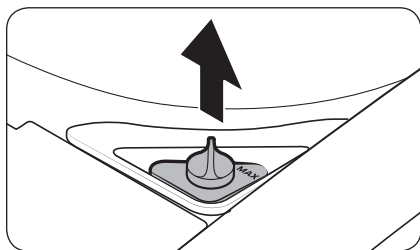

1. Open the top door, and then remove the softener cap.

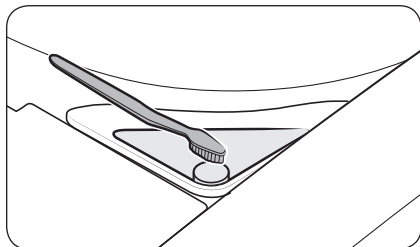

2. Use a soft brush (for example, a toothbrush) to clean inside the compartment and remove impurities.
3. Run the Rinse+Spin cycle to rinse the compartment. After supplying water and draining 5 times, the 18-minute cycle completes with the final spin process.

Maintenance

Lint filter

We recommend cleaning the lint filter every 10 washes.

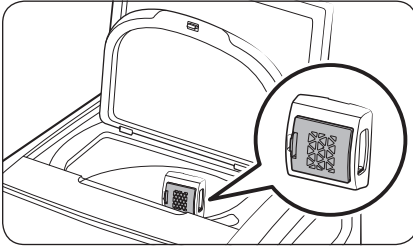

1. Remove the lint filter from the filter case on the tub of the upper washer.

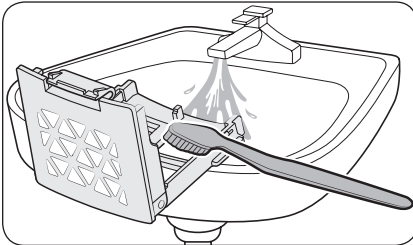
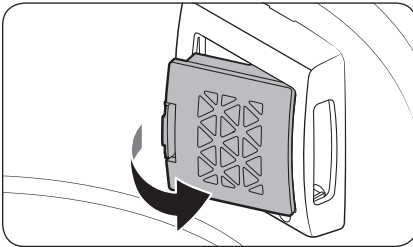



2. Open the filter, and clean it with running water and a brush.
3. When cleaning is complete, close the filter and reinsert it in its original position. You will hear a clicking sound when the filter is inserted correctly.

Lower washer

Self Clean+

Certain usage and environmental conditions may result in some residue build-up or odor in the washer drum. To prevent this build-up of residue or odor causing bacteria and keep your washer drum fresh and clean, perform the Self Clean+ cycle at least once a month or every 40 cycles. Perform the recommended procedure below when using the Self Clean+ cycle.

1. Remove all items from the washer drum and ensure the drum is empty. Laundry left in the drum during the Self Clean+ cycle may be damaged.
2. Tap  to turn the power on.
3. Tap **LOWER**.
4. Turn the **Navigation dial** to select **Self Clean+**.
5. Tap and hold lower .

NOTE

- The water temperature for Self Clean+ is defaulted to Hot. This temperature cannot be changed.
- In the case where residue is present in the washer drum, add liquid chlorine bleach to the MAX level line in the main-wash compartment before starting the Self Clean+ cycle. Do not add the liquid chlorine bleach to the bleach compartment (This is only the case for Self Clean+ cycle). Do not exceed the max line. Do not use or mix any other detergent or chemicals during the Self Clean+ cycle. If necessary, run a Rinse+Spin Cycle after the Self Clean+ cycle has completed to help remove any remaining residue.

CAUTION

If there is chlorine bleach left in the washer drum for an extended period of time, rust can occur.

Self Clean+ reminder

- After 40 washing cycles, the Self Clean+ LED reminder icon and the Self Clean+ cycle LED will blink on the control panel for an hour and then turn off automatically.
- The reminder will appear on the control panel for 5 additional consecutive cycles before turning off. The next reminder will not appear until another 40 cycles have been completed.

Maintenance

Main wash compartment

The main wash compartment needs to be cleaned periodically to remove buildup of laundry additives.

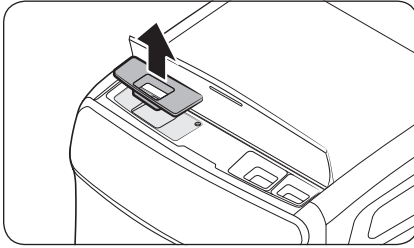

1. Open the top-front cover. Grasp the main wash compartment, and then pull up to remove.

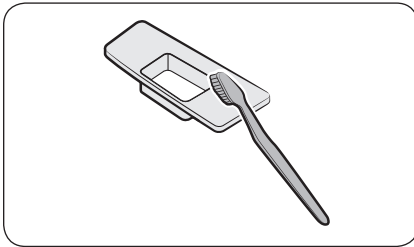

2. Remove all residue and traces of accumulated laundry agents from the compartment. Rinse it with warm water.

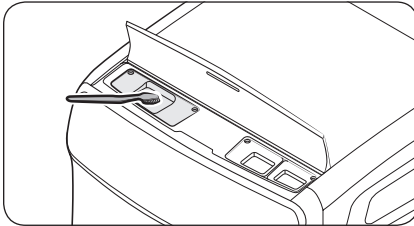

3. To clean the recess of the compartment, use a small, non-metal brush. Remove all residue from all sides of the recess.
4. Reinsert the compartment into place.

Fabric softener/bleach compartment

Both the fabric softener compartment and the bleach compartment on the lower washer are not removable by design to facilitate visual feedback to users. To clean the softener compartment, follow these instructions. Cleaning the bleach compartment is basically the same.

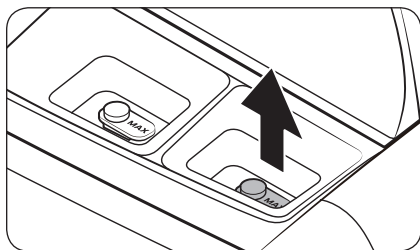

1. Open the top-front cover, and then remove the softener cap.

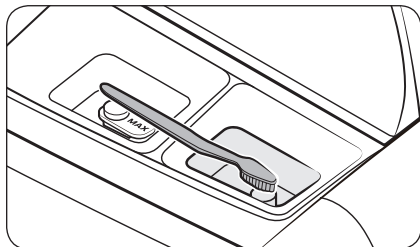

2. Use a soft brush (for example, a toothbrush) to clean inside the compartment and remove impurities.
3. Run the Rinse+Spin cycle to rinse the compartment. After supplying water and draining 5 times, the 19-minute cycle completes with the final spin process.



Maintenance

Door diaphragm

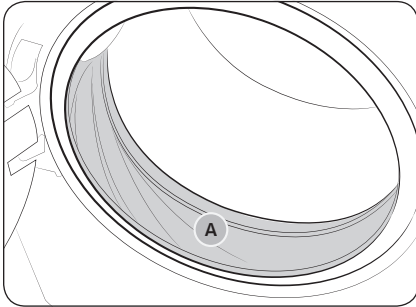

1. Open the door and empty the drum.
2. Turn out the diaphragm (sealing or gasket of the drum **(A)**), and check if it is stained. If so, follow the steps below.
3. Combine 3/4 cups of liquid chlorine bleach and 1 gallon of warm tap water.
4. Wearing rubber gloves, use a soft, clean cloth dipped in the water and chlorine solution to clean the diaphragm.
5. Let stand for 5 minutes, and then wipe up and dry well.

CAUTION

Use bleach carefully and be sure to follow the bleach manufacturer's use and care instructions.

NOTE

Dust may accumulate on the door diaphragm during washing and drying (especially for drying). Therefore, clean the diaphragm after each washing and drying cycles.

Emergency drain

In case of a power failure, drain the water inside the drum before taking out the laundry.

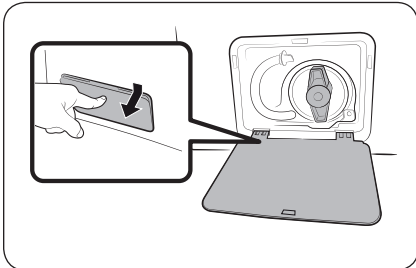

1. Power off the washer, and then unplug it from the electrical outlet.
2. Gently press the top area of the filter cover to open.



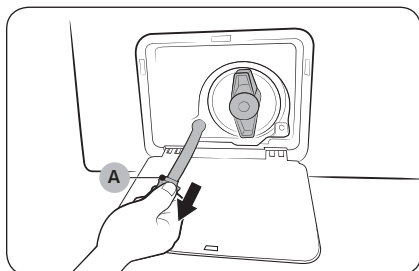

- Put an empty, spacious container in front of the cover, and stretch the emergency drain tube to the container while holding the **tube cap (A)**.

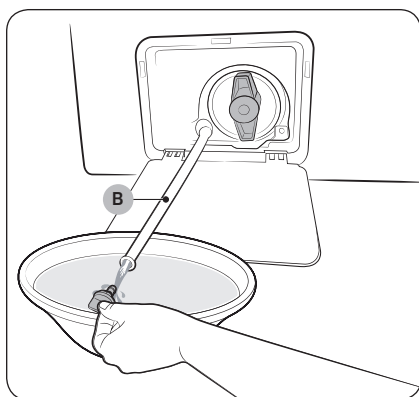

- Open the tube cap and let water in the **Emergency drain tube (B)** flow into the container.
- When done, close the tube cap, and reinsert the tube. Then, close the filter cover.

NOTE

Use a spacious container because the water in the drum may be more than expected.

Pump filter

It is advisable to clean the pump filter 5 or 6 times a year to prevent it from clogging. A clogged pump filter may reduce the bubble effect.

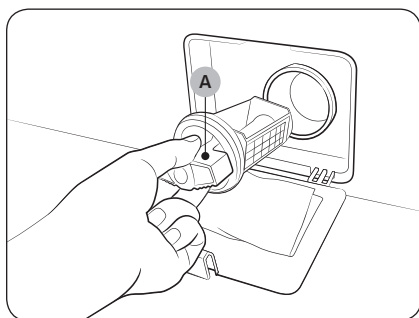

- Turn off the washer, and then unplug the power cord.
- Drain the remaining water inside the drum. See the **Emergency drain** section on page 68.
- Gently press the top area of the filter cover to open.
- Turn the **pump filter knob (A)** to the left, and drain off the remaining water.

Maintenance

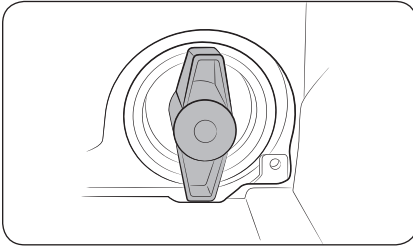
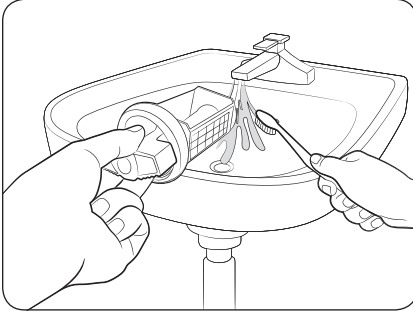

5. Clean the pump filter using a soft brush. Make sure the drain pump propeller inside the filter is not clogged.
6. Reinsert the pump filter, and then turn the filter knob to the right.
7. Close the filter cover.

NOTE

- Some pump filters feature a safety knob that is designed to prevent children from accidentally opening the filter compartment. To open the safety knob of the pump filter, push in and turn it counterclockwise. The spring mechanism of the safety knob helps open the filter.
- To close the safety knob of the pump filter, turn it clockwise. The spring makes a rattling sound, which is normal.

NOTE

If the pump filter is clogged, the "5C" information code appears on the washer's display screen.

CAUTION

- Make sure the filter knob is closed properly after cleaning the filter. Otherwise, this may cause a leak.
- Make sure the filter is inserted properly after cleaning it. Otherwise, this may cause an operational failure or a leak.



Troubleshooting

Checkpoints

If you encounter an issue to check with the washer, first check the table below and try the suggestions.

Problem	Action
Does not turn on.	<ul style="list-style-type: none"> • Make sure your home electrical system is providing electrical power that matches the requirements of the washer. See page 19 • Make sure the power plug of the washer is completely plugged in.
Does not start.	<ul style="list-style-type: none"> • Make sure the door is properly closed. • Make sure the taps are open. • Make sure to tap and hold ▷ to start the washer. • Make sure Child Lock is not activated. • Before the washer starts to fill, it will make a series of clicking noises to check the door lock and does a quick drain. • Check the fuse or reset the circuit breaker. • Check if the upper or lower washer displays an information code on the respective status bar.
Water supply is insufficient or no water is supplied.	<ul style="list-style-type: none"> • Fully open the tap. • Make sure the door is properly closed. • Make sure the water supply hose is not frozen. • Make sure the water supply hose is not kinked or clogged. • Make sure there is sufficient water pressure.
After a cycle, detergent remains in the detergent drawer.	<ul style="list-style-type: none"> • Make sure the washer is running with sufficient water pressure. • If you are using powdered detergent, do not use more than recommended. • If you are using liquid detergent, do not over fill the liquid detergent compartment. • Remove the liquid detergent and softener containers, and then clean the detergent drawer.
Excessive vibrations or makes noise.	<ul style="list-style-type: none"> • Make sure the washer is installed on a level, solid floor that is not slippery. If the floor is not level, use the leveling feet to adjust the height of the washer. • Make sure the shipping bolts are removed. • Make sure the washer is not contacting any other object. • Make sure the laundry load is balanced. • The motor can cause noise during normal operation. • Overalls or metal-decorated clothes can cause noise while being washed. This is normal. • Metal objects such as coins can cause noise. After washing, remove these objects from the drum or tub or filter case.

Troubleshooting

Problem	Action
Does not drain and/ or spin.	<ul style="list-style-type: none"> • Make sure the drain hose is neither kinked nor obstructed all the way to the drain system. If there is a drain restriction, call for service. • Make sure the debris filter is not clogged. • Close the door and tap and hold . For your safety, the washer will not tumble or spin unless the door is closed. • Make sure the drain hose is not frozen or clogged. • Make sure the drain hose is connected to a drain system that is not clogged. • If the washer is not supplied with sufficient power, the washer temporarily will not drain or spin. As soon as the washer regains sufficient power, it will operate normally.
Drains with noise.	<ul style="list-style-type: none"> • At the initial installation, or when the washer has not been used for an extended period of time, the washer may make deflating noises while draining. This is not a system failure.
The door does not open.	<ul style="list-style-type: none"> • Tap  to stop the washer. • It may take a few moments for the door lock mechanism to disengage. • The door will not open until 3 minutes after the washer has stopped or the power has been turned off. • Make sure all the water in the drum or tub is drained. • The door may not open if water remains in the drum or tub. Drain the drum or tub and open the door manually. • Make sure the door lock icon is off. The door lock icon turns off after the washer has drained.
Excessive suds.	<ul style="list-style-type: none"> • Make sure you use the recommended types of detergent. • Use high efficiency (HE) detergent to prevent oversudsing. • Reduce the detergent amount for soft water, small loads, or lightly soiled loads. • Non-HE detergent is not recommended.
Cannot add additional detergent.	<ul style="list-style-type: none"> • Do not fill the detergent or fabric softener compartments beyond the marked max fill limit.

Problem	Action
The washer stops.	<ul style="list-style-type: none"> • Plug the power cord into a live electrical outlet. • Check the fuse or reset the circuit breaker. • Close the door, and then tap and hold ▷ to start the washer. For your safety, the washer will not tumble or spin unless the door is closed. • Before the washer starts to fill, it will make a series of clicking noises to check the door lock and does a quick drain. • There may be a pause or soak period in the cycle. Wait and the washer may start. • Make sure the mesh filters of the water supply hoses at the taps are not clogged. Periodically clean the mesh filters. • If the washer is not supplied with sufficient power, the washer temporarily will not drain or spin. As soon as the washer regains sufficient power, it will operate normally.
The washer fills with the wrong temperature water.	<ul style="list-style-type: none"> • Fully open both taps. • Make sure the temperature selection is correct. • Make sure the hoses are connected to the correct taps. Flush the water lines. • Make sure your water heater is set to supply hot water with a minimum temperature of 120 °F (49 °C) at the tap. Also, check the water heater capacity and recovery rate. • Disconnect the hoses and clean the mesh filters. The mesh filters may be clogged. • While the washer fills, the water temperature may change as the automatic temperature control feature checks the incoming water temperature. This is normal. • While the washer fills, you may notice just hot and/or just cold water going through the dispenser when cold or warm temperatures are selected. This is a normal function of the automatic temperature control feature as the washer determines the water temperature.
The load is wet at the end of a cycle.	<ul style="list-style-type: none"> • Use the High or Extra High spin speed. • Use high efficiency (HE) detergent to reduce oversudsing. • The load is too small. Small loads (one or two items) may become unbalanced and not spin completely. • Make sure the drain hose is not kinked or clogged.

Troubleshooting

Problem	Action
Leaks water.	<ul style="list-style-type: none"> • Make sure the door is properly closed. • Make sure all hose connections are tight. • Make sure the end of the drain hose is correctly inserted and secured to the drain system. • Avoid overloading. • Use high efficiency (HE) detergent to prevent oversudsing.
Has odors.	<ul style="list-style-type: none"> • Excessive suds collect in recesses and can cause foul odors. • Run cleansing cycles to sanitize periodically. • Clean the door seal (diaphragm). • Dry the washer interior after a cycle has finished.
The tub or the water/drain hose is frozen.	<ul style="list-style-type: none"> • For frozen hoses, use warm water to disconnect the frozen hoses. Soak them in warm water. • For a frozen tub, fill the tub with warm water, and then wait for about 10 minutes. • For the hose connector, put a hot towel on the drain hose connector. • After thawing the hoses, reconnect them.
Water drains out immediately.	<ul style="list-style-type: none"> • Make sure the drain hose is not clogged, and is hung over the drain hose hook. Fill the tub halfway with water, and try spinning again. • Lift the end of the drain hose to prevent water from draining. Fill the tub halfway with water, and then run the spin cycle after releasing the drain hose. • Make sure the drain hose is installed correctly. See the installation section of this manual and then adjust the position of the drain hose as instructed. • Make sure the washer drains completely if it is turned off by force. If you operate the washer before it has drained completely, the washer may supply water and drain simultaneously.

If an issue continues to occur, contact a local Samsung service center.

Information codes

If the washer fails to operate, you may see an information code on the screen. Check the table below and try the suggestions.

Code		Action
Upper washer	Lower washer	
Close door and restart		<p>The door is open.</p> <ul style="list-style-type: none"> Close the door, and then press Start/Pause to resume operation.
Clean drain filter		<p>Check the drain system.</p> <ul style="list-style-type: none"> Make sure the drain filter is not clogged. If the drain filter is clogged, clean the filter, and then restart the washer.
Check water supply faucets and restart		<p>Check the water supply line.</p> <ul style="list-style-type: none"> Check the connection to the water line (including water taps). Power off and then power the washer on after 2-3 minutes, and then try again. Depending on the model, the drain system drains water automatically. The Power and Start/Pause buttons may be disabled during this process.
Check water lines		<ul style="list-style-type: none"> Make sure the cold water supply hose is firmly connected to the cold water tap. If it is connected to the hot water tap, the laundry may be deformed with some cycles.
Redistribute unbalanced load and restart		<p>Check the spinning process.</p> <ul style="list-style-type: none"> The load may not be balanced inside the drum or tub. Load is too small, or heavy items are mixed with light items. Check the drum or tub and make sure the load is balanced. Avoid washing single items, adding few extra items help to balance the load. Redistribute the load evenly. Press Start/Pause to resume operation, or power off and then power the washer on after 2-3 minutes, and then try again.
Close protective cover and restart		<p>The protective cover is open.</p> <ul style="list-style-type: none"> Close the protective cover, and then press Start/Pause to resume operation.
1 1C	1C	<p>Check the water level sensor.</p> <ul style="list-style-type: none"> Power off and then power the washer on after 2-3 minutes, and then try again. Depending on the model, the drain system drains water automatically. The Power and Start/Pause buttons may be disabled during this process.

Troubleshooting

Code		Action
Upper washer	Lower washer	
1 dC1	dC1	<p>Check the door switch..</p> <ul style="list-style-type: none"> Power off and then power the washer on after 2-3 minutes, and then try again.
1 LC	LC	<p>Check for water leaks.</p> <ul style="list-style-type: none"> Power the washer off, and then check the drain system for any leaks. Once the leak issue is resolved, power the washer on after 2-3 minutes. Depending on the model, the drain system drains water automatically. The Power and Start/Pause buttons may be disabled during this process.
1 LC1	LC1	<p>Check the drain hose.</p> <ul style="list-style-type: none"> Make sure the end of the drain hose is placed on the floor. Make sure the drain hose is not clogged. If the information code remains, contact a customer service center. <p>Others</p> <ul style="list-style-type: none"> Use caution not to overfill any of the compartments (main wash/fabric softener/bleach). Do not spray or use water when cleaning the top door of the upper washer. Use a cloth to wipe up.
1 HC	HC	<p>Check the washing heater.</p> <ul style="list-style-type: none"> Power off the washer, and then contact a Samsung customer service center.
1 8C 1 8C1 1 8C2	8C 8C1 8C2	<p>Check the MEMS sensor.</p> <ul style="list-style-type: none"> Power off and then power the washer on after 2-3 minutes, and then try again.
1 OC	OC	<p>Water may overflow.</p> <ul style="list-style-type: none"> Close the water tap, and then call for service.
1 3C	3C	<p>Check the motor.</p> <ul style="list-style-type: none"> Power off and then power the washer on after 2-3 minutes, and then try again.
1 AC6	AC6	<p>Check the PBA communication status.</p> <ul style="list-style-type: none"> Power off and then power the washer on after 2-3 minutes, and then try again.
1 9C1 1 9C2	9C1 9C2	<p>The electronic control needs to be checked.</p> <ul style="list-style-type: none"> Check if power is supplied properly. If the information code remains, contact a Samsung service center.

Code		Action
Upper washer	Lower washer	
1 SF	SF	System failed. <ul style="list-style-type: none"> Power off the washer, and then contact a Samsung service center.
1 AC	AC	Check communications between main and sub PBAs. <ul style="list-style-type: none"> Try powering off and restarting the cycle. If the information code remains, contact a customer service center.





If any information code keeps appearing on the screen, contact a local Samsung service center.

Specifications



Fabric care chart

The following symbols provide garment care direction. The clothing care labels include symbols for drying, bleaching, drying and ironing, or dry cleaning when necessary. The use of symbols ensures consistency among garment manufacturers of domestic and imported items. Follow care label directions to optimize garment life and reduce laundering problems.

Wash cycle

	Normal
	Permanent press/Wrinkle resistant/ Wrinkle control
	Gentle/Delicates
	Hand wash



Water temperature

	Hot
	Warm
	Cold



NOTE

The temperature range for Hot is 135 °F (57 °C) or below, 95 °F (35 °C) or below for Warm, and 68 °F (20 °C) or below for Cold. Wash water temperature must be a minimum of 60 °F (16 °C) for detergent activation and effective cleaning.



Bleach

	Any bleach (when needed)
	Only non-chlorine (color-safe) bleach (when needed)
	Tumble dry





Normal

	Permanent press/Wrinkle resistant/ Wrinkle control
	Gentle/Delicates



Special instructions

	Line dry/Hang to dry
	Drip dry
	Dry flat







Heat setting

	High
	Medium
	Low
	Any heat
	No heat / Air





Iron dry or steam temperatures

	High
	Medium
	Low

Warning symbols for laundering

	Do not wash
	Do not wring
	Do not bleach
	Do not tumble dry
	No steam (added to iron)
	Do not iron

Dry-clean

	Dry-clean
	Do not dry-clean
	Line dry/Hang to dry
	Drip dry
	Dry flat

Protecting the environment

- This appliance is manufactured from recyclable materials. If you decide to dispose of it, please observe local waste disposal regulations. Cut off the power cord so that the appliance cannot be connected to a power source. Remove the lid so that animals and small children cannot get trapped inside the appliance.
- Do not exceed the detergent quantities recommended in the detergent manufacturers' instructions.
- Use stain removal products and bleaches before the wash cycle only when necessary.
- Save water and electricity by only washing full loads (the exact amount depends upon the program used).

Declaration of conformity

This appliance complies with UL2157.

Specifications

Specification sheet

English

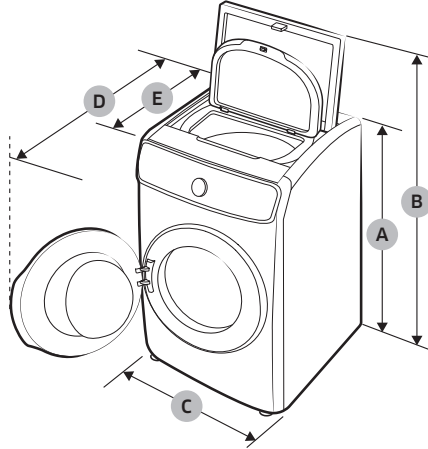

Type		Dual loading washer	
Dimensions (inches (mm))	A. Height - top door closed	46.9 in. (1192 mm)	
	B. Height - top door opened	61 in. (1550 mm)	
	C. Width	27 in. (686 mm)	
	D. Depth with door open	54.6 in. (1386 mm)	
	E. Depth	34 in. (864 mm)	
Water pressure (psi (kPa))		20 - 116 (137 - 800)	
NET weight (lb (kg))		304 (138)	
Spin revolution	Upper washer	800 rpm	
	Lower washer	1300 rpm	
Heater rating	Washing and heating	120 V	900 W
Annual energy consumption		Upper washer	60 kWh/year
		Lower washer	110 kWh/year
Annual water consumption		Upper washer	3540 gal/year
		Lower washer	4278 gal/year

LIMITED WARRANTY (U.S.A.)

SAMSUNG WASHER

LIMITED WARRANTY TO ORIGINAL PURCHASER WITH PROOF OF PURCHASE

This SAMSUNG brand product, as supplied and distributed by SAMSUNG ELECTRONICS AMERICA, INC. (SAMSUNG) and delivered new, in the original carton to the original consumer purchaser, is warranted by SAMSUNG against manufacturing defects in materials or workmanship for the limited warranty period, starting from the date of original purchase, of:

- One (1) year parts and labor,
- Three (3) years stainless tub part (Part Only),
- Ten (10) years washing DD motor part (Part Only)

This limited warranty is valid only on products purchased and used in the United States that have been installed, operated, and maintained according to the instructions attached to or furnished with the product. To receive warranty service, the purchaser must contact SAMSUNG at the address or phone number provided below for problem determination and service procedures. Warranty service can only be performed by a SAMSUNG authorized service center. The original dated bill of sale must be presented upon request as proof of purchase to SAMSUNG or SAMSUNG's authorized service center to receive warranty service.

SAMSUNG will provide in-home service within the contiguous United States during the warranty period at no charge, subject to availability of SAMSUNG authorized servicers within the customer's geographic area. If in-home service is not available, SAMSUNG may elect, at its option, to provide transportation of the product to and from an authorized service center. If the product is located in an area where service by a SAMSUNG authorized servicer is not available, you may be responsible for a trip charge or required to bring the product to a SAMSUNG authorized service center for service.

To receive in-home service, product must be unobstructed and accessible to the service agent.

During the applicable warranty period, a product will be repaired, replaced, or the purchase price refunded, at the sole option of SAMSUNG. SAMSUNG may use new or reconditioned parts in repairing a product, or replace the product with a new or reconditioned product. Replacement parts and products are warranted for the remaining portion of the original product's warranty or ninety (90) days, whichever is longer. All replaced parts and products are the property of SAMSUNG and you must return them to SAMSUNG.

LIMITED WARRANTY (U.S.A.)

This limited warranty covers manufacturing defects in materials or workmanship encountered in normal household, noncommercial use of this product and shall not cover the following: damage that occurs in shipment, delivery, installation, and uses for which this product was not intended; damage caused by unauthorized modification or alteration of the product; product where the original factory serial numbers have been removed, defaced, changed in any way, or cannot be readily determined; cosmetic damage including scratches, dents, chips, and other damage to the product's finishes; damage caused by abuse, misuse, pest infestations, accident, fire, floods, or other acts of nature or God; damage caused by use of equipment, utilities, services, parts, supplies, accessories, applications, installations, repairs, external wiring or connectors not supplied or authorized by SAMSUNG; damage caused by incorrect electrical line current, voltage, fluctuations and surges; damage caused by failure to operate and maintain the product according to instructions; in-home instruction on how to use your product; and service to correct installation not in accordance with electrical or plumbing codes or correction of household electrical or plumbing (i.e., house wiring, fuses, or water inlet hoses). The cost of repair or replacement under these excluded circumstances shall be the customer's responsibility.

Visits by a Service Engineer to explain functions, maintenance or installation is not covered by warranty. Please contact your Samsung call agent for help with any of these issues.

EXCLUSION OF IMPLIED WARRANTIES

IMPLIED WARRANTIES, INCLUDING THE IMPLIED WARRANTIES OF MERCHANTABILITY OR FITNESS FOR A PARTICULAR PURPOSE, ARE LIMITED TO ONE YEAR OR THE SHORTEST PERIOD ALLOWED BY LAW.

Some states do not allow limitations on how long an implied warranty lasts, so the above limitations or exclusions may not apply to you. This warranty gives you specific rights, and you may also have other rights, which vary from state to state.

LIMITATION OF REMEDIES

YOUR SOLE AND EXCLUSIVE REMEDY IS PRODUCT REPAIR, PRODUCT REPLACEMENT, OR REFUND OF THE PURCHASE PRICE AT SAMSUNG'S OPTION, AS PROVIDED IN THIS LIMITED WARRANTY. SAMSUNG SHALL NOT BE LIABLE FOR SPECIAL, INCIDENTAL OR CONSEQUENTIAL DAMAGES, INCLUDING BUT NOT LIMITED TO TIME WAY FROM WORK, HOTELS AND/OR RESTAURANT MEALS, REMODELING EXPENSES, LOSS OF REVENUE OR PROFITS, FAILURE TO REALIZE SAVINGS OR OTHER BENEFITS REGARDLESS OF THE LEGAL THEORY ON WHICH THE CLAIM IS BASED, AND EVEN IF SAMSUNG HAS BEEN ADVISED OF THE POSSIBILITY OF SUCH DAMAGES. Some states do not allow exclusion or limitation of incidental or consequential damages, so the above limitations or exclusions may not apply to you. This warranty gives you specific rights, and you may also have other rights, which vary from state to state.

SAMSUNG does not warrant uninterrupted or error-free operation of the product. No warranty or guarantee given by any other person, firm, or corporation with respect to this product shall be binding on SAMSUNG.

To obtain warranty service, please contact SAMSUNG at:

Samsung Electronics America, Inc.

85 Challenger Road

Ridgefield Park, NJ 07660

1-800-SAMSUNG (726-7864)

www.samsung.com/us/support

Warranty (CANADA)

SAMSUNG WASHER

LIMITED WARRANTY TO ORIGINAL PURCHASER

This SAMSUNG brand product, as supplied and distributed by SAMSUNG ELECTRONICS CANADA, INC. (SAMSUNG) and delivered new, in the original carton to the original consumer purchaser, is warranted by SAMSUNG against manufacturing defects in materials and workmanship for a limited warranty period of:

One (1) year part and labor, Ten (10) years washing DD motor (Part only)

This limited warranty begins on the original date of purchase, and is valid only on products purchased and used in the Canada. To receive warranty service, the purchaser must contact SAMSUNG for problem determination and service procedures. Warranty service can only be performed by a SAMSUNG authorized service center. The original dated bill of sale must be presented upon request as proof of purchase to SAMSUNG or SAMSUNG's authorized service center. SAMSUNG will provide in-home service during the warranty period at no charge, subject to availability within the Canada. In-home service is not available in all areas.

To receive in-home service, product must be unobstructed and accessible to the service agent. If service is not available, SAMSUNG may elect to provide transportation of the product to and from an authorized service center.

SAMSUNG will repair, replace, or refund this product at our option and at no charge as stipulated herein, with new or reconditioned parts or products if found to be defective during the limited warranty period specified above. All replaced parts and products become the property of SAMSUNG and must be returned to SAMSUNG. Replacement parts and products assume the remaining original warranty, or ninety (90) days, whichever is longer. This limited warranty covers manufacturing defects in materials and workmanship encountered in normal, noncommercial use of this product and shall not apply to the following: damage that occurs in shipment; delivery and installation; applications and uses for which this product was not intended; altered product or serial numbers; cosmetic damage or exterior finish; accidents, abuse, neglect, fire, water, lightning, or other acts of nature or God; use of products, equipment, systems, utilities, services, parts, supplies, accessories, applications, installations, repairs, external wiring or connectors not supplied or authorized by SAMSUNG that damage this product or result in service problems; incorrect electrical line voltage, fluctuations and surges; customer adjustments and failure to follow operating instructions, maintenance and environmental instructions that are covered and prescribed in the instruction book; product removal and reinstallation; problems caused by pest infestations. This limited warranty does not cover problems resulting from incorrect electric current, voltage or supply, light bulbs, house fuses, house wiring, cost of a service call for instructions, or fixing installation errors. SAMSUNG does not warranty uninterrupted or error-free operation of the product.

EXCEPT AS SET FORTH HEREIN, THERE ARE NO WARRANTIES ON THIS PRODUCT EITHER EXPRESS OR IMPLIED, AND SAMSUNG DISCLAIMS ALL WARRANTIES INCLUDING, BUT NOT LIMITED TO, ANY IMPLIED WARRANTIES OF MERCHANTABILITY, INFRINGEMENT OR FITNESS FOR A PARTICULAR PURPOSE.

NO WARRANTY OR GUARANTEE GIVEN BY ANY PERSON, FIRM, OR CORPORATION WITH RESPECT TO THIS PRODUCT SHALL BE BINDING ON SAMSUNG. SAMSUNG SHALL NOT BE LIABLE FOR LOSS OF REVENUE OR PROFITS, FAILURE TO REALIZE SAVINGS OR OTHER BENEFITS, OR ANY OTHER SPECIAL, INCIDENTAL OR CONSEQUENTIAL DAMAGES CAUSED BY THE USE, MISUSE, OR INABILITY TO USE THIS PRODUCT, REGARDLESS OF THE LEGAL THEORY ON WHICH THE CLAIM IS BASED, AND EVEN IF SAMSUNG HAS BEEN ADVISED OF THE POSSIBILITY OF SUCH DAMAGES.

NOR SHALL RECOVERY OF ANY KIND AGAINST SAMSUNG BE GREATER IN AMOUNT THAN THE PURCHASE PRICE OF THE PRODUCT SOLD BY SAMSUNG AND CAUSING THE ALLEGED DAMAGE. WITHOUT LIMITING THE FOREGOING, PURCHASER ASSUMES ALL RISK AND LIABILITY FOR LOSS, DAMAGE, OR INJURY TO PURCHASER AND PURCHASER'S PROPERTY AND TO OTHERS AND THEIR PROPERTY ARISING OUT OF THE USE, MISUSE, OR INABILITY TO USE THIS PRODUCT. THIS LIMITED WARRANTY SHALL NOT EXTEND TO ANYONE OTHER THAN THE ORIGINAL PURCHASER OF THIS PRODUCT, IS NONTRANSFERABLE AND STATES YOUR EXCLUSIVE REMEDY.

Some provinces do not allow limitations on how long an implied warranty lasts, or the exclusion or limitation of incidental or consequential damages, so the above limitations or exclusions may not apply to you.

This warranty gives you specific rights, and you may also have other rights, which vary from province to province.

To obtain warranty service, please contact SAMSUNG at:

Samsung Electronics Canada Inc.

2050 Derry Road West,

Mississauga, Ontario L5N 0B9 Canada

1-800-SAMSUNG (726-7864)

www.samsung.com/ca/support (English)

www.samsung.com/ca_fr/support (French)

FAX : 1-866-436-4617

Visits by a Service Engineer to explain functions, maintenance, or installation are not covered by warranty.

Please contact the Samsung call center for help with any of these issues.

Memo

Memo

SAMSUNG



Scan the QR code* or visit
www.samsung.com/spsn
to view our helpful
How-to Videos and Live Shows

*Requires reader to be installed on your smartphone

Scan this with your smartphone

QUESTIONS OR COMMENTS?

COUNTRY	CALL	OR VISIT US ONLINE AT
U.S.A	1-800-SAMSUNG (726-7864)	www.samsung.com/us/support
CANADA	1-800-SAMSUNG(726-7864)	www.samsung.com/ca/support (English) www.samsung.com/ca_fr/support (French)



DC68-04316A-01