



Washer

User manual

WF50A88**A*

SAMSUNG



Contents

Safety information	4
What you need to know about the safety instructions	4
Important safety symbols	4
Important safety precautions	5
CALIFORNIA PROPOSITION 65 WARNING	5
Critical installation warnings	6
Installation cautions	7
Critical usage warnings	7
Usage cautions	9
Critical cleaning warnings	12
Regulatory notice	13
FCC Notice	13
IC Notice	14
Open Source Announcement	15
Installation	16
Unpacking your washer	16
What's included	17
Installation requirements	19
Step-by-step installation	23
Before you start	28
Initial setup	28
Laundry guidelines	29
Detergent drawer guidelines	31
Operations	36
Multi-control panel	36
Operating a cycle	39
Cycle overview	40
Cycle chart	42
Options	44
System Functions	47
Special features	50
SmartThings	52



Maintenance	53
Self Clean+	53
Emergency drain	54
Cleaning	55
Recovery from freezing	60
Care for an extended period of non-use	60
Cleaning the exterior	61
Cleaning the interior	61
Troubleshooting	62
Checkpoints	62
Information codes	66
Specifications	68
Fabric care chart	68
Protecting the environment	69
Declaration of conformity	69
Specification sheet	70



Safety information

Congratulations on your new Samsung washer. This manual contains important information on the installation, use and care of your appliance. Please take some time to read this manual to take full advantage of your washer's many benefits and features.

What you need to know about the safety instructions

Please read this manual thoroughly to ensure that you know how to safely and efficiently operate the extensive features and functions of your new appliance. Please store the manual in a safe location close to the appliance for future reference. Use this appliance only for its intended purpose as described in this instruction manual.

Warnings and Important Safety Instructions in this manual do not cover all possible conditions and situations that may occur. It is your responsibility to use common sense, caution and care when installing, maintaining and operating your washer.

Because the following operating instructions cover various models, the characteristics of your washer may differ slightly from those described in this manual and not all warning signs may be applicable. If you have any questions or concerns, contact your nearest service center or find help and information online at www.samsung.com.

Important safety symbols

What the icons and signs in this user manual mean:

WARNING

Hazards or unsafe practices that may result in **severe personal injury, death and/or property damage.**

CAUTION

Hazards or unsafe practices that may result in **personal injury and/or property damage.**

NOTE

Indicates that a risk of personal injury or material damage exists.

These warning signs are here to prevent injury to yourself and others.

Please follow them explicitly.

After reading this manual, store it in a safe place for future reference.

Read all instructions before using the appliance.

As with any equipment that uses electricity and moving parts, potential hazards exist. To safely operate this appliance, familiarize yourself with its operation and exercise care when using it.

SAVE THESE INSTRUCTIONS



Important safety precautions

WARNING

To reduce the risk of fire, electric shock, or injury to persons when using your appliance, follow basic precautions, including the following:

1. Read all instructions before using the appliance.
2. Do not wash or dry articles that have been previously cleaned in, washed in, soaked in, or spotted with gasoline, dry-cleaning solvents, other flammable or explosive substances as they give off vapors that could ignite or explode.
3. Do not allow children to play on or in the appliance. Close supervision of children is necessary when the appliance is used near children.
4. Before the appliance is removed from service or discarded, remove the door to the washing or drying compartment.
5. Do not reach into the appliance if the drum is moving.
6. Do not install or store this appliance where it will be exposed to the weather.
7. Do not tamper with controls.
8. Do not repair or replace any part of the appliance or attempt any servicing unless specifically recommended in the user-maintenance instructions or in published user repair instructions that you understand and have the skills to carry out.
9. Do not add gasoline, dry-cleaning solvents, or other flammable or explosive substances to the wash water. These substances give off vapors that could ignite or explode.
10. Under certain conditions, hydrogen gas may be produced in a hot water system that has not been used for 2 weeks or more. **HYDROGEN GAS IS EXPLOSIVE.** If the hot water system has not been used for such a period, before using a washer or combination washer-dryer, turn on all hot water faucets and let the water flow from each for several minutes. This will release any accumulated hydrogen gas. As the gas is flammable, do not smoke or use an open flame during this time.

CALIFORNIA PROPOSITION 65 WARNING

WARNING

Cancer and Reproductive Harm - www.P65Warnings.ca.gov.

SAVE THESE INSTRUCTIONS



Safety information

Critical installation warnings

WARNING

The installation of this appliance must be performed by a qualified technician or service company.

- Failure to do so may result in electric shock, fire, an explosion, problems with the product, or injury.

The appliance is heavy, therefore take care when lifting it.

Plug the power cord into a wall socket that meets local electrical specifications. Use the socket for this appliance only, and do not use an extension cord.

- Sharing a wall socket with other appliances, using a power strip, or extending the power cord may result in electric shock or fire.
- Ensure that the voltage, frequency, and current supplied to the washer matches those listed in the product specifications. Failure to do so may result in electric shock or fire. Plug the power plug into the wall socket firmly.

Remove all foreign substances such as dust or water from the power plug terminals and contact points using a dry cloth on a regular basis.

- Unplug the power plug and clean it with a dry cloth.
- Failure to do so may result in electric shock or fire.

Plug the power plug into the wall socket so that the cord is running towards the floor.

- If you plug the power plug into the socket in the opposite direction, the electric wires within the cable may be damaged and this may result in electric shock or fire.

Keep all packaging materials out of the reach of children as these may be dangerous.

- If a child places a plastic bag over his or her head, he or she can suffocate.

If the appliance, power plug, or power cord is damaged, contact your nearest service center.

This appliance must be properly grounded.

Do not ground the appliance to a gas pipe, plastic water pipe, or telephone line.

- This may result in electric shock, fire, an explosion, or problems with the product.
- Never plug the power cord into a socket that is not grounded correctly. Make sure that the socket is in accord with local and national regulations.

Do not install this appliance near a heater or any flammable material.

Do not install this appliance in a humid, oily or dusty location, or in a location exposed to direct sunlight or water (rain drops).

Do not install this appliance in a location exposed to low temperatures.

- Frost may cause the tubes to burst.

Do not install this appliance in a location where gas may leak.

- This may result in electric shock or fire.

SAVE THESE INSTRUCTIONS



Do not use an electric transformer to power the washer.

- This may result in electric shock or fire.

Do not use a damaged power plug, damaged power cord, or loose wall socket.

- This may result in electric shock or fire.

Do not pull or bend the power cord excessively.

Do not twist or tie the power cord.

Do not hook the power cord over a metal object, place a heavy object on the power cord, insert the power cord between objects, or push the power cord into the space behind the appliance.

- This may result in electric shock or fire.

Do not pull the power cord when unplugging the power plug.

- Unplug the power plug by pulling the plug.
- Failure to do so may result in electric shock or fire.

This appliance should be positioned so that the power plug, the water supply taps, and the drain pipes are accessible.

Installation cautions

CAUTION

This appliance should be positioned in such a way that the power plug is easily accessible.

- Failure to do so may result in electric shock or fire due to electric leakage.

Install your appliance on a solid, level floor that can support its weight.

- Failure to do so may result in abnormal vibrations, movement, noise, or problems with the product.

Critical usage warnings

WARNING

If the appliance is flooded, turn off the water & power supplies immediately and contact your nearest service center.

- Do not touch the power plug with wet hands.
- Failure to do so may result in electric shock.

If the appliance generates a strange noise, a burning smell, or smoke, unplug the power plug immediately and contact your nearest service center.

- Failure to do so may result in electric shock or fire.

SAVE THESE INSTRUCTIONS



Safety information

In the event of a gas leak (such as propane gas, LP gas, etc.), ventilate immediately without touching the power plug. Do not touch the appliance or power cord.

- Do not use a ventilating fan.
- A spark may result in an explosion or fire.

Do not let children play in or on the washer. In addition, when disposing of the appliance, remove the washer door lever.

- Children can suffocate to death if trapped inside the product.

Make sure to remove the packaging (sponge, styrofoam) attached to the bottom of the washer before using it.

Do not wash items contaminated with gasoline, kerosene, benzene, paint thinner, alcohol, or other inflammable or explosive substances in the washer.

- This may result in electric shock, fire, or an explosion.

Do not open the washer door by force while it is operating (high-temperature washing/drying/spinning).

- Water flowing out of the washer may result in burns or cause the floor to be slippery. This may result in injury.
- Opening the door by force may result in damage to the product or injury.

Do not insert your hand under the washer while an operation is in progress.

- This may result in injury.

Do not touch the power plug with wet hands.

- This may result in electric shock.

Do not turn the appliance off by unplugging the power plug while an operation is in progress.

- Plugging the power plug into the wall socket again may cause a spark and result in electric shock or fire.

Do not let children climb in or onto the appliance.

- This may result in electric shock, burns, or injury.

Do not insert your hand or a metal object under the washer while it is operating.

- This may result in injury.

Do not unplug the appliance by pulling the power cord. Always grip the plug firmly and pull it straight out of the outlet.

- Damage to the power cord may cause a short-circuit, fire, and/or electric shock.

Do not attempt to repair, disassemble, or modify the appliance yourself.

- Do not use a fuse (such as copper, steel wire, etc.) other than a standard fuse.
- When the appliance needs to be repaired or reinstalled, contact your nearest service center.
- Failure to do so may result in electric shock, fire, problems with the product, or injury.

If the water supply hose comes loose from the faucet and floods the appliance, unplug the power plug.

- Failure to do so may result in electric shock or fire.

SAVE THESE INSTRUCTIONS



Unplug the power plug when the appliance is not being used for long periods of time or during a thunder or lightning storm.

- Failure to do so may result in electric shock or fire.

If any foreign substance enters the appliance, unplug the power plug and contact your nearest Samsung Customer Service.

- This may result in electric shock or fire.

Do not let children (or pets) play in or on your washer. The washer door does not open easily from the inside and children may be seriously injured if trapped inside.

Usage cautions

CAUTION

If the washer is contaminated by a foreign substance such as detergent, dirt, food waste, etc., unplug the power plug and clean the washer using a damp, soft cloth.

- Failure to do so may result in discoloration, deformation, damage, or rust.

The front glass may be broken by a strong impact. Take care when using the washer.

- If the glass is broken, it may result in injury.

After a water supply failure or when reconnecting the water supply hose, open the faucet slowly.

Open the faucet slowly after a long period of non-use.

- The air pressure in the water supply hose or the water pipe may damage a product part or result in a water leak.

If a draining error occurs during an operation, check if there is a draining problem.

- If the washer is used when it is flooded because of a draining problem, it may result in electric shock or fire.

Insert the laundry into the washer completely so that the laundry does not get caught in the door.

- If laundry gets caught in the door, it may result in damage to the laundry or the washer, or result in a water leak.

Turn the water supply off when the washer is not being used.

- Ensure that the water supply hose connectors are properly tightened.

Ensure that the rubber seal and front door glass are not contaminated by a foreign substance (e.g. waste, thread, hair, etc.).

- If a foreign substance is caught in the door or the door is not completely closed, it may cause a water leak.

SAVE THESE INSTRUCTIONS



Safety information

Open the faucet and check if the water supply hose connectors are firmly tightened and that there are no water leaks before using the product.

- If the connectors on the water supply hoses are loose, it may result in a water leak.

The product you have purchased is designed for domestic use only.

Using the product for business purposes qualifies as a product misuse. If the product is used for business purposes, it will not be covered by the standard warranty provided by Samsung and no responsibility can be attributed to Samsung for malfunctions or damages resulting from such misuse.

Do not stand on the appliance or place objects (such as laundry, lighted candles, lighted cigarettes, dishes, chemicals, metal objects, etc.) on the appliance.

- This may result in electric shock, fire, problems with the product, or injury.

Do not spray volatile material such as insecticide onto the surface of the appliance.

- As well as being harmful to humans, this may result in electric shock, fire, or problems with the product.

Do not place objects that generate electromagnetic fields near the washer.

- This may result in injury due to a malfunction.

Water drained during a high-temperature wash or drying cycle is hot. Do not touch the water.

- This may result in burns or injury.

Do not wash, spin, or dry water-proof seats, mats, or clothing (*) unless your appliance has a special cycle for washing these items.

(*): Woolen bedding, rain covers, fishing vests, ski pants, sleeping bags, diaper covers, sweat suits, and bicycle, motor cycle and car covers, etc.

- Do not wash thick or hard mats even if the washer mark is on the care label. This may result in injury or damage to the washer, walls, floor, or clothing due to abnormal vibrations.
- Do not wash throw rugs or doormats with rubber backing. The rubber backing may come off and stick to inside the drum, and this may result in malfunction such as a drainage error.

Do not operate the washer when the detergent drawer is removed.

- This may result in electric shock or injury due to a water leak.

Do not touch the insides of the drum during or just after drying as it is hot.

- This may result in burns.

The door glass becomes hot during washing and drying. Therefore, do not touch the door glass.

Also, do not allow children to play around the washer or touch the door glass.

- This may result in burns.

Do not insert your hand into the detergent drawer.

- This may result in injury as your hand may be caught by the detergent input device.

SAVE THESE INSTRUCTIONS



- Do not use the liquid detergent container (on applicable models only) for powdered detergent. Remove the container and put powdered detergent directly into the Main wash compartment.

Do not place any objects (such as shoes, food waste, animals) other than laundry into the washer.

- This may result in damage to the washer, or injury and death in the case of pets, due to the abnormal vibrations.

Do not press the buttons using sharp objects such as pins, knives, fingernails, etc.

- This may result in electric shock or injury.

Do not wash laundry contaminated by oils, creams, or lotions usually found in skincare shops or massage clinics.

- This may cause the rubber seal to become deformed and result in a water leak.

Do not leave metal objects such as safety pins, hair pins or bleach in the drum for long periods of time.

- Doing either may cause the drum to rust.
- If rust starts appearing on the surface of the drum, apply a (neutral) cleansing agent to the surface and use a sponge to clean it. Never use a metal brush.

Do not use dry cleaning detergent directly and do not wash, rinse, or spin laundry contaminated by dry cleaning detergent.

- This may result in spontaneous combustion or ignition due to the heat from the oxidation of the oil.

Do not use water from water cooling/heating devices.

- This may result in problems with the washer.

Do not use natural hand-washing soap for the washer.

- If it hardens and accumulates inside the washer, it may result in problems with the product, discoloration, rust, or bad odors.

Place socks and brassieres in a washing net and wash them with the other laundry.

Do not wash large laundry items such as bedding in the washing net.

- Failure to do so may result in injury due to abnormal vibrations.

Do not use hardened detergent.

- If it accumulates inside the washer, it may result in a water leak.

Make sure that the pockets of all the clothing items to be washed are empty.

- Hard, sharp objects such as coins, safety pins, nails, screws, or stones can cause extensive damage to the appliance.

Do not wash clothing with large buckles, buttons, or other heavy metal objects in the washer.

Sort the laundry by color on the basis of its colorfastness and select the recommended cycle, water temperature, and additional functions.

- Failure to do this may result in discoloration or fabric damage.

SAVE THESE INSTRUCTIONS

Safety information

Take care that children's fingers are not caught in the door when you close it.

- Failure to do so may result in injury.

Critical cleaning warnings

WARNING

Do not clean the appliance by spraying water directly onto it.

Do not use a strong acidic cleaning agent.

Do not use benzene, thinner, or alcohol to clean the appliance.

- This may result in discoloration, deformation, damage, electric shock, or fire.

Before cleaning or performing maintenance, unplug the appliance from the wall socket.

- Failure to do so may result in electric shock or fire.

SAVE THESE INSTRUCTIONS

Regulatory notice

FCC Notice

CAUTION

Any changes or modifications not expressly approved by the party responsible for compliance could void the user's authority to operate the equipment.

This device complies with Part 15 of FCC Rules. Operation is Subject to following two conditions:

1. This device may not cause harmful interference, and
2. This device must accept any interference received including interference that cause undesired operation.

For products sold in the US and Canadian markets, only channels 1–11 are available. You cannot select any other channels.

FCC STATEMENT:

This equipment has been tested and found to comply within the limits for a Class B digital device, pursuant to part 15 of the FCC Rules. These limits are designed to provide reasonable protection against harmful interference in a residential installation.

This equipment generates, uses, and can radiate radio frequency energy and, if not installed and used in accordance with the instructions, may cause harmful interference to radio communications. However, there is no guarantee that interference will not occur in a particular installation. If this equipment does cause harmful interference to radio or television reception, which can be determined by turning the equipment off and on, the user is encouraged to try to correct the interference by one or more of the following measures:

- Reorienting or relocating the receiving antenna
- Increasing the separation between the equipment and receiver
- Connecting the equipment to an outlet that is on a different circuit than the radio or TV.
- Consulting the dealer or an experienced radio/TV technician for help.

FCC RADIATION EXPOSURE STATEMENT:

This equipment complies with FCC radiation exposure limits set forth for an uncontrolled environment. This equipment should be installed and operated so there is at least 8 inches (20 cm) between the radiator and your body. This device and its antenna(s) must not be colocated or operated in conjunction with any other antenna or transmitter.

SAVE THESE INSTRUCTIONS



Regulatory notice

IC Notice

The term “IC” before the radio certification number only signifies that Industry Canada technical specifications were met. Operation is subject to the following two conditions:

1. This device may not cause interference, and
2. This device must accept any interference, including interference that may cause undesired operation of the device.

This Class B digital apparatus complies with Canadian ICES-003.

Cet appareil numérique de la classe B est conforme à la norme NMB-003 du Canada.

For products sold in the US and Canadian markets, only channels 1–11 are available. You cannot select any other channels.

IC RADIATION EXPOSURE STATEMENT:

This equipment complies with IC RSS-102 radiation exposure limits set forth for an uncontrolled environment. This equipment should be installed and operated so there is at least 8 inches (20 cm) between the radiator and your body. This device and its antenna(s) must not be colocated or operated in conjunction with any other antenna or transmitter.



SAVE THESE INSTRUCTIONS



Open Source Announcement

The software included in this product contains open source software. You may obtain the complete corresponding source code for a period of three years after the last shipment of this product by contacting our support team via <http://opensource.samsung.com> (Please use the "Inquiry" menu.)

It is also possible to obtain the complete corresponding source code in a physical medium such as a CD-ROM; a minimal charge will be required.

The following URL http://opensource.samsung.com/opensource/SMART_AT_051/seq/0 leads to the open source license information as related to this product. This offer is valid to anyone in receipt of this information.



NOTE

Hereby, Samsung Electronics, declares that the radio equipment type appliance is in compliance with Directive 2014/53/EU. The full text of the EU declaration of conformity is available at the following internet address: The official Declaration of conformity may be found at <http://www.samsung.com>, go to Support > Search Product Support and enter the model name.

Wi-Fi max transmitter power : 20 dBm at 2.412 GHz – 2.472 GHz

SAVE THESE INSTRUCTIONS

Installation

Follow these instructions carefully to ensure proper installation of the washer and to prevent accidents when doing laundry.

⚠ WARNING

Certain internal parts are intentionally not grounded and may present a risk of electric shock only during servicing. Service personnel – Do not contact the following parts while the appliance is energized: Control board, heat sink, motor, inlet valve and pump.

Unpacking your washer

Unpack your washer and inspect it for shipping damage. Make sure you have received all the items shown on the next page. If your washer was damaged during shipping, or you do not have all of the items, call 1-800-SAMSUNG (1-800-726-7864). To prevent personal injury or strain, wear protective gloves whenever lifting or carrying the unit.

WARNING — Packing materials can be dangerous to children; Keep all packing material (plastic bags, polystyrene, etc.) well out of children's reach.

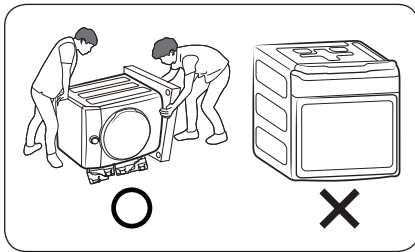

⚠ CAUTION

You must have at least 2 people unpack the washer. To remove the cushion bottom of the packing materials, do not tip the washer over on its front side.

When you lay the washer down to remove the carton base, protect the side of the washer and lay it down carefully. Never lay your washer on its back or front.

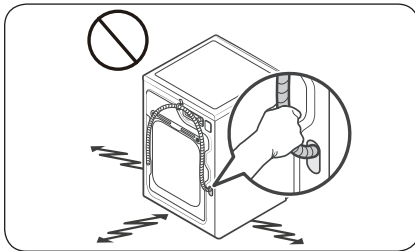

⚠ CAUTION

Do not grab or pull the drain hose to drag and move the product.

What's included

Make sure all the parts are included in the product package. If you have a problem with the washer or the parts, contact a local Samsung customer centre or the retailer.

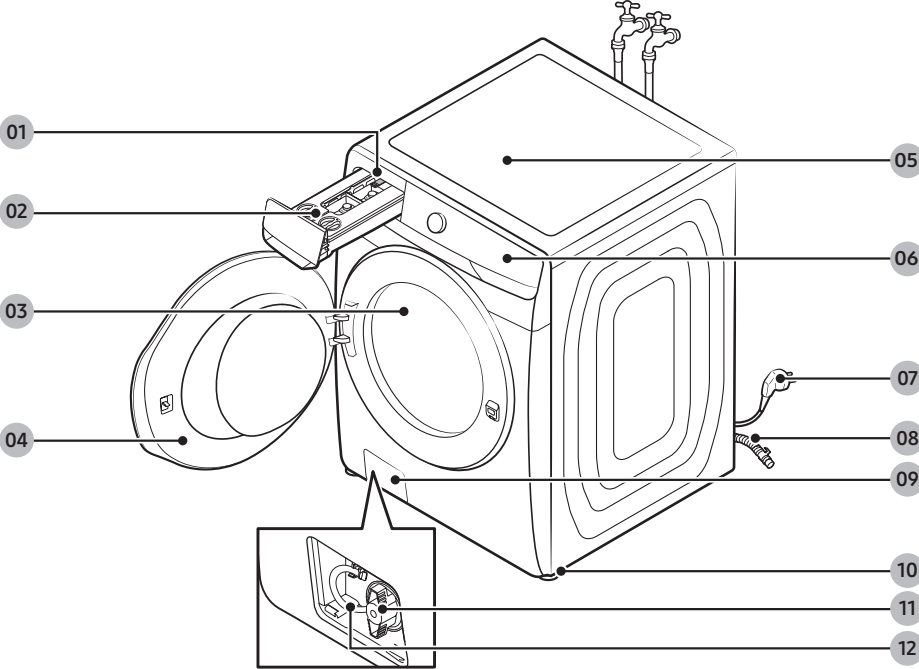

- | | | |
|-------------------|--------------------------------------|-------------------------|
| 01 Release lever | 02 Detergent drawer (Auto dispenser) | 03 Drum |
| 04 Door | 05 Worktop | 06 Multi-control panel |
| 07 Power plug | 08 Drain hose | 09 Filter cover |
| 10 Levelling feet | 11 Debris filter | 12 Emergency drain tube |



Installation

Parts supplied



Wrench



Bolt caps



Hose guide



Cable tie



Anti-slip pads

Parts not supplied

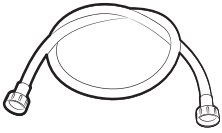

Water hoses (sold separately)

Tools needed for installation

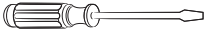

Phillips screwdriver



Level



Adjustable pliers

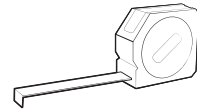

Measuring tape

NOTE

- Bolt caps: The number (3 to 6) of bolt caps provided depends on the model.
- The appearance of the washer and provided accessories may differ with the model.
- To purchase an accessory or lost part, contact a local Samsung service center or the retailer.

CAUTION

- Do not reuse old water hoses, which may leak or burst, causing flooding and/or property damage.
- Make sure rubber washers are inserted in each coupling of both water hoses.



Installation requirements

Electrical supply and grounding

- AC 120 V / 60 Hz / 15 AMP fuse or circuit breaker is required.
- Use an individual branch circuit. Connect only the washer to the circuit.

To ensure proper grounding, the washer comes with a power cord featuring a three-prong grounding plug for use in a properly installed and grounded outlet.

Check with a qualified electrician or service person if you are not sure about the grounding.

Do not modify the provided plug. If it does not fit the outlet, call a qualified electrician to install a proper outlet.

WARNING

- Do NOT use an extension cord.
- Use only the power cord that comes with the washer.
- Do NOT connect the ground wire to plastic plumbing, gas lines, or hot water pipes.
- Improperly connected grounding conductors may cause electric shock.
- To prevent unnecessary risk of fire, electrical shock, or personal injury, all wiring and grounding must be done in accordance with local codes, or in the absence of local codes, in accordance with the National Electrical Code, ANSI/NFPA No. 70-Latest Revision (for the U.S.) or the Canadian Electrical Code CSA C22.1 – Latest Revisions and local codes and ordinances. It is your responsibility to provide adequate electrical service for your washer.

Water supply

Proper water pressure for this washer is between 20-116 psi (137-800 kPa). Water pressure less than 20 psi (137 kPa) may cause the water valve not to close completely. Or, it may take longer to fill the drum, causing the washer to turn off. Water taps must be within 4 ft. (122 cm) from the rear of the washer so that the provided inlet hoses reach the washer.

To reduce the risk of leaks:

- Make sure water taps are easily accessible.
- Turn off the taps when the washer is not in use.
- Check for any leaks at the water inlet hose fittings on a regular basis.

CAUTION

Before using the washer for the first time, check all connections at the water valve and taps for any leaks.

Installation

Drain

Samsung recommends a standpipe 18 in. (460 mm) high. The drain hose must be connected through the hose clip to the standpipe, and the standpipe must fully cover the drain hose.

Flooring

For best performance, the washer must be installed on a solid floor. Wood floors may need to be reinforced to minimize vibration and/or unbalanced loads. Carpeting and soft tile surfaces do not provide good resistance to vibrations and may cause the washer to move slightly during the spin cycle.

⚠ CAUTION

Do NOT install the washer on a platform or a poorly supported structure.

Water temperature

Do not install the washer in areas where water may freeze as the washer always retains some water in its water valves, pumps, and/or hoses. Frozen water can cause damage to belts, the pump, and other components of the washer.

Dimensions

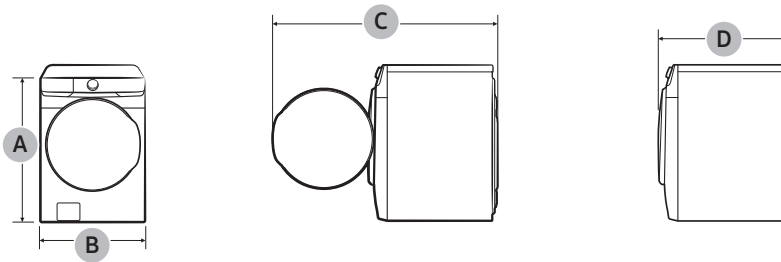

A. Overall height	38.7 in. (984 mm)
B. Width	27 in. (686 mm)
C. Depth with door open	54.8 in. (1392 mm)
D. Depth	33.5 in. (850 mm)

Clearance requirement

This clearance requirement is applicable for washers only.

NOTE

- For dryer's clearance requirement, see the dryer's user manual.
- If the washer and dryer have different clearance requirements, use the one with the larger value.

Alcove or closet installations

Minimum clearance for stable operation:

Sides	Top	Rear	Front
1 in. (25 mm)	1 in. (25 mm)	5 in. (127 mm)	1 in. (25 mm)

If both the washer and a dryer are installed in the same location, the front of the alcove or closet must have two unobstructed air openings for a combined minimum total area of 72 in.² (465 cm²).

Undercounter installation

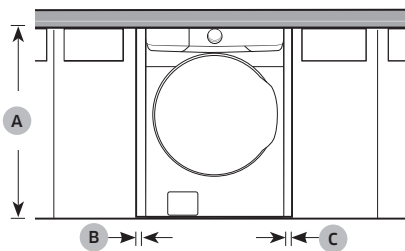

A	39.6 in. (1006 mm)
B	1 in. (25 mm)
C	1 in. (25 mm)

Pedestal installation

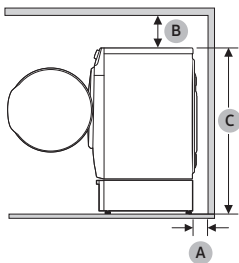

A	5 in. (127 mm)
B	6 in. (152 mm)
C	52.0 in. (1320 mm)

Installation

This clearance requirement is applicable for washer and dryer pair installation.

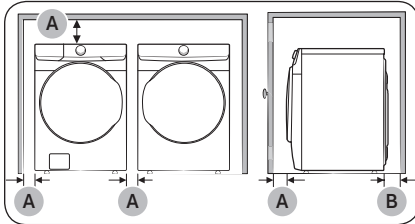

A	1 in. (25 mm)
B	5.9 in. (150 mm)
C	7.3 in. (185 mm)
D	6 in. (152 mm)
E	78.5 in. (1994 mm)

Side by side installation

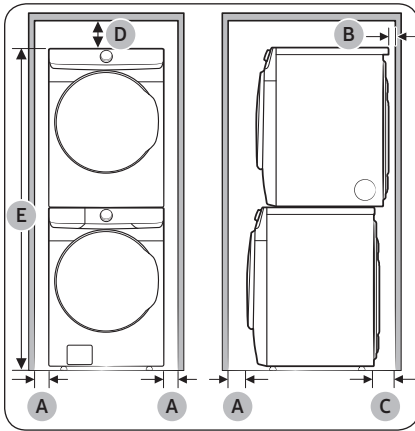

⚠ WARNING

- Samsung's washers and dryers can be stacked to maximize usable space.
- The dryer feet need to be removed to stack the washer and dryer. You can purchase an optional stacking kit from your Samsung retailer.
- You must purchase the MultiControl KIT (Model: DV-MCK) if you want a multi-control connection.

Stacked installation (Model: SKK-8K)

Step-by-step installation

STEP 1 Select a location

Location requirements:

- A solid, level surface without carpeting or flooring that may obstruct ventilation
- No direct sunlight
- Adequate room for ventilation and wiring
- Ambient temperature always higher than the freezing point (32 °F / 0 °C)
- Away from heat sources

STEP 2 Remove the shipping bolts

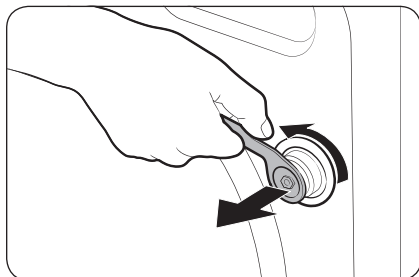

Unpack the product package and remove all shipping bolts.

1. Loosen all shipping bolts on the rear of the machine using the spanner.

NOTE

Use the enclosed end of the supplied wrench to remove the shipping bolts.

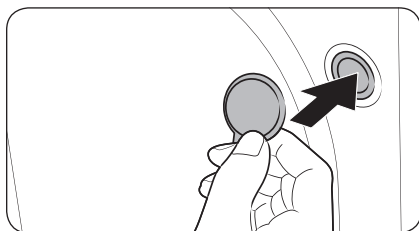

2. Fill the holes with the supplied plastic bolt caps. Keep the shipping bolts for future use.

WARNING

- The shipping bolts secure the tub during product transportation and reduce the chance of suspension damage. Remove the shipping bolts before using the product and only reassemble them back in case you need to move the product.
- Packaging materials can be dangerous to children. Dispose all packaging material (plastic bags, polystyrene, etc.) out of children's reach.



Installation

STEP 3 Adjust the leveling feet

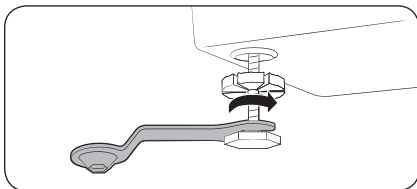

1. Gently slide the washer into position. Excessive force may damage the leveling feet.
2. Using a wrench, turn the leveling feet clockwise or counterclockwise to adjust the height until the washer is level.

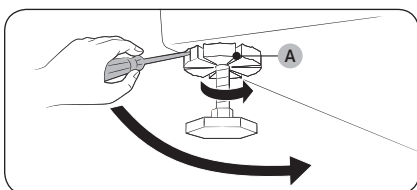

3. Using a flathead screwdriver, tighten the **locking nuts (A)**.

NOTE

Use the open-end of the supplied wrench to adjust the leveling feet.

STEP 4 Connect the water hose

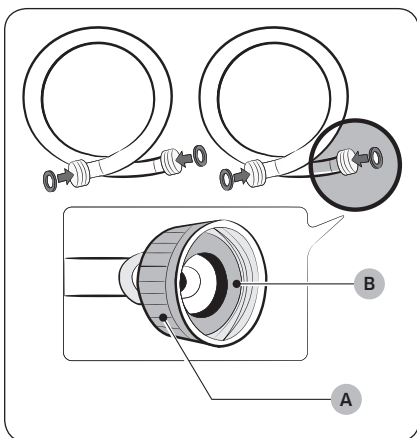

CAUTION

- Make sure to use new water hoses and that **rubber gaskets (B)** are inside the **couplings (A)** at both ends of the hoses. Water hoses without the gaskets may leak.
- Allow 5 in. (127 mm) of space between the back of the washer and the wall to prevent water hoses from being kinked. Kinked hoses may cause water leaks.
- If there is a water leak, stop using the washer and contact a local Samsung service center. A water leak may cause electric shock.
- Do not stretch the water hoses by force. If a hose is too short, replace the hose with a longer hose.



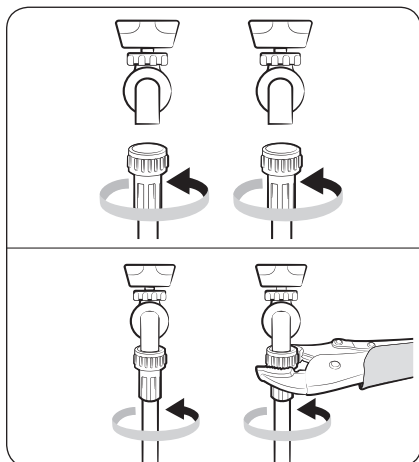

1. Attach the water hoses to the hot and cold water taps, and then hand tighten the water hose fittings until they are tight. Then, use pliers to tighten the fittings by an additional two-thirds of a turn. To avoid damaging the fittings, do not overtighten them.
2. Pull the water hoses to check if they are firmly connected.

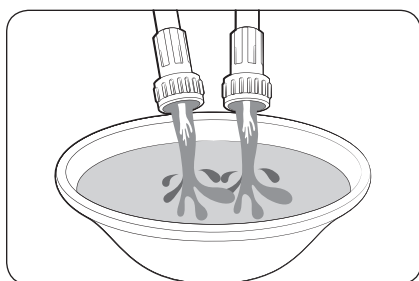

3. Put the other ends of the hoses into a bucket, and then open the water taps for 10 - 15 seconds to remove impurities. When done, close the taps.

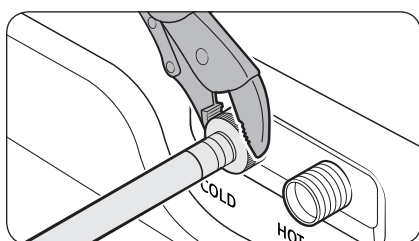

4. Attach the water hoses to the hot and cold water inlets on the back of the washer, and then hand tighten the water hose fittings until they are tight. Then, use pliers to tighten the fittings by an additional two-thirds of a turn.

NOTE

If you do not want to use the hot water supply hose, attach the water intake cap to the hot water supply intake. When you do a wash, press **Temp.** to select Cold.



Installation

English

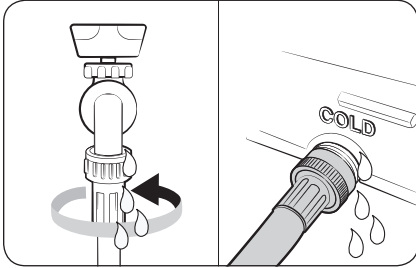

5. Open the water taps, and check for leaks.

STEP 5 Connect the drain hose

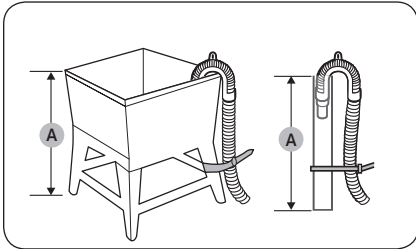

To a Laundry Tub or Drain Pipe

1. Check the **height (A)** of your drain system and make sure the minimum and maximum heights shown below are met.

Minimum	18 in. (46 cm)
Maximum	96 in. (245 cm)

NOTE

- Make sure to measure the height from the floor where the washer is placed.
- Draining efficiency may be reduced if the drain system is at the maximum height.
- To prevent the washer from siphoning water, do not use a drain system below the minimum height.

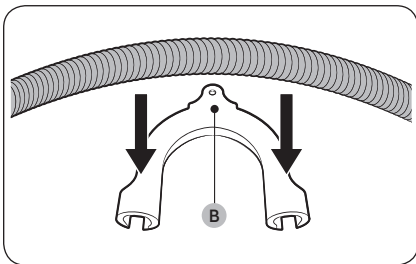

2. Attach the drain hose to the **plastic hose guide (B)**.



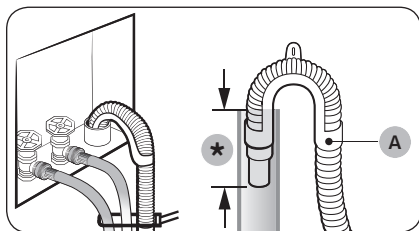

(*): Min. 6 in. (152 mm), Max. 8 in. (203 mm)

3. Route the drain hose to the drain system.

⚠ CAUTION

- If using a standpipe, make sure the standpipe and drain hose connection is not airtight.
- If using a standpipe, make sure the drain hose is inserted at least 6 in. (152 mm) but no more than 8 in. (203 mm) into the standpipe.

4. Secure the drain hose with cable ties.

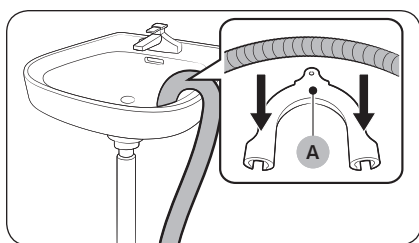

Over the edge of a wash basin

The drain hose must be placed no lower than 24 in. (60 cm) and no higher than 35 in. (90 cm) from the floor. To keep the spout of the drain hose bent, use the supplied plastic **hose guide (A)**. Secure the guide to the wall using a hook to ensure stable drainage.

STEP 6 Remove the film inside the door

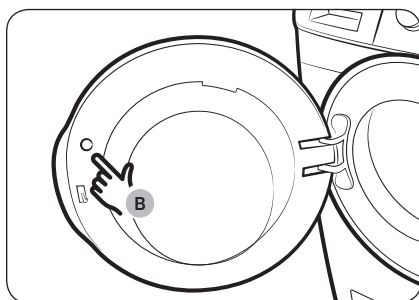

Remove the **small circle of film (B)** above the door latch before use.



STEP 7 Power on

Plug the power cord into an AC 120 V / 60 Hz / 15 AMP approved electrical outlet protected by a fuse or circuit breaker. Then, press **Power** to turn on the washer.

Before you start

Initial setup

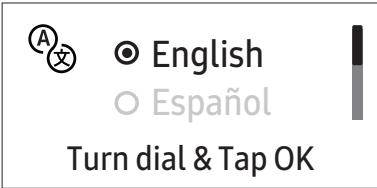
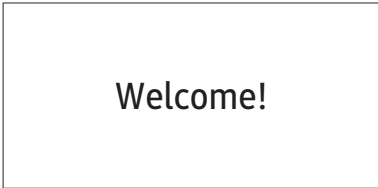
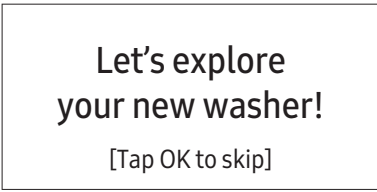
- When you turn on the washer for the first time, the screen shows the initial setup process. Follow the on-screen instructions to complete it.
- Once you select a language, the language selection screen will not reappear. However, you must complete a wash cycle once to stop the tutorial screen from reappearing.
- The initial setup includes language selection and a brief tutorial.
- Tap **OK** to skip to the next screen.

01 Language selection	02 Welcome screen
 <p>Turn dial & Tap OK</p>	 <p>Welcome!</p>
03 Tutorial	
 <p>Let's explore your new washer! [Tap OK to skip]</p>	 <p>A washer that knows you! All Done!</p>

Laundry guidelines

STEP 1 Sort

Sort the laundry according to these criteria:

- Care Label: Sort the laundry into cottons, mixed fibers, synthetics, silks, wools, and rayon.
- Color: Separate whites from colors.
- Size: Mixing different sized items together in the drum improves the washing performance.
- Sensitivity: Wash delicate items separately. For pure, new woolen items, curtains, and silk items, check the labels on the items.

 **NOTE**

Make sure to check the care label on all clothing, and sort clothing accordingly before starting the wash.

STEP 2 Empty pockets

Empty all the pockets of your laundry items

- Metal objects such as coins, pins, and buckles on clothing may damage other laundry items as well as the drum.

Turn clothing with buttons and embroideries inside out

- If pants or jacket zippers are open while washing, the drum may be damaged. Zippers should be closed and fixed with a string.
- Clothing with long strings may become entangled with other clothes. Make sure to tie the strings before starting the wash.

STEP 3 Use a laundry net

- Brassieres (water washable) must be placed in a laundry net. Metal parts of the brassieres may break through and tear other laundry items.
- Small, light clothing such as socks, gloves, stockings, and handkerchiefs may become caught around the door. Place them inside a fine laundry net.
- Do not wash the laundry net by itself without other laundry. This may cause abnormal vibrations that could move the washer and result in injury.



Before you start

STEP 4 Determine the load capacity

Do not overload the washer. Overloading may cause the washer to wash improperly.

NOTE

When washing bedding or bedding covers, the wash time may be lengthened or the spin efficiency may be reduced.

For bedding or bedding covers, the recommended maximum spin level is Level 2 or Level 3, and the load capacity is 3.0 kg or less.

CAUTION

If the laundry is unbalanced and the “**Unbalanced laundry detected**” information code is displayed, redistribute the load. Unbalanced laundry may reduce spinning performance.

STEP 5 Add the correct detergent type

The type of detergent you use - general purpose, specifically for woolens, etc. - depends on the type of fabric (cotton, synthetic, delicate items, wool), color, wash temperature, and degree of soiling. Regardless of the specific type of detergent you use, always use “low suds” HE laundry detergent which is designed for automatic washers.

NOTE

- Follow the detergent manufacturer’s recommendations based on the weight of the laundry, the degree of soiling, and the hardness of the water in your local area. If you are not sure about the water hardness, contact your local water authority.
- Do not use detergent that tends to harden or solidify. This detergent may remain after the rinse cycle, blocking the drain outlet.

CAUTION

When washing wool using the WOOL cycle, use only a neutral liquid detergent. Powdered detergent used with the WOOL cycle can remain on the laundry and discolor it.

Use HE detergent only



For the best cleaning results, use a high efficiency detergent such as Tide HE, Wisk HE, Cheer HE or Gain HE*. High efficiency detergents contain suds suppressors that reduce or eliminate suds. When fewer suds are produced, the load tumbles more efficiently and cleaning is maximized. (* Brand names are trademarks of their respective manufacturers.)

WARNING

For best results, use HE detergents only. Do not use non-HE detergent, organic detergent, natural detergent or HE detergents with natural ingredients (such as vinegar, baking soda).



Detergent drawer guidelines

The automatic dispenser models provide a four-compartment dispenser: two compartments for auto-dispensing and another parts for manual input. With the automatic dispensing option on, the washer dispenses an adequate amount of detergent or fabric softener for each load. See below for details:

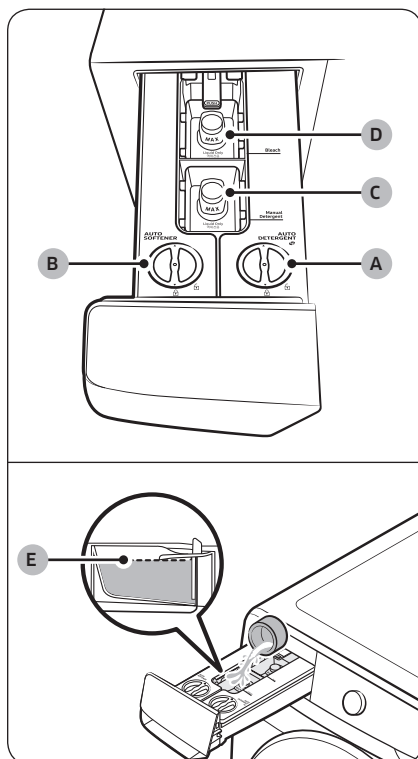

A. Auto detergent compartment

- Use liquid detergent only.

B. Auto softener compartment

- Use fabric softener only.

C. Manual detergent compartment

- If necessary, add detergent manually as instructed by the detergent manufacturer.
- To use the detergent in this compartment, make sure the auto-dispensing option is off. (For more information on turning the auto-dispensing off, see the "Dose per Wash" and "Dose per Rinse" section on page 45.
- Do not exceed the **max line (E)** when adding liquid detergent.
- If you want to use the powdered detergent, remove the liquid detergent container before putting the powdered detergent.

D. Manual bleach compartment

- Add liquid chlorine bleach. Do not exceed the max line.

⚠ CAUTION

- Auto dispensing feature is on automatically as a default setting which can be turned off from Options menu. When Auto Dispensing is on and the Auto Dispensing cartridge is not filled with detergent, then the user will receive the following message each time of use: "**Detergent low**", "**Softener low**", "**Detergent & Softner low**".
- Do not add an excessive amount of detergent. This may affect the washing results adversely.
- Do not use any cleaning agents for cleaning the drum. Chemical residue in the drum deteriorates the washing performance.

Before you start

- When using the manual detergent/bleach compartments, make sure to add the detergent and bleach into the correct compartment. When adding the liquid detergent or bleach, make sure the liquid detergent/bleach container is in the correct compartment. Otherwise, it may result in poor washing performance.

CAUTION

- Do not operate the washer with the compartments not placed in the detergent drawer.
 - A water leak may cause electric shock or injury.
- Do not use the following types of detergent in the drawer.
 - Tablet, capsule, ball, or net types.
- Do not use gel-type or viscous detergent/softener in the detergent drawer as they may not flow well.
 - Read the detergent/softener manufacturer's instructions before using them in the washer.
- Do not carry any removed compartment. Put the compartment back in place.
 - Otherwise, the compartment may shake and cause the content to spill out.
- Empty the compartments in the detergent drawer before moving the washer to prevent any content from spilling out on the floor.

NOTE

- The "**Detergent drawer is open**" message appears if the detergent drawer is not completely closed. Close the detergent drawer before you start the washer.
- If message "**Refill detergent**", "**Refill softener**", or "**Refill detergent & softener**" appears on the display, refill the corresponding compartment.
- Detergent/softener is not automatically dispensed in the Wool, Delicates, Outdoor, and Activewear cycles. To dispense detergent/softener in the Wool, Delicates, Outdoor, and Activewear cycles, you must manually set the input level of detergent/softener.
- Do not exceed the max line when filling detergent and softener.
- For special detergent or softener (for wool, baby clothes, etc.), purchase additional compartments and use the new compartments exclusively for the special detergent or softener.
- It may be hard to open the detergent drawer with just your fingertips. Grab the detergent drawer handle firmly with your hand and pull to open it.
- Push the detergent drawer all the way to the end to close it. You will hear a click sound when the drawer is properly closed.
- If you feel softener scent is weak, set the softener input level to High.

To use the bleach compartment

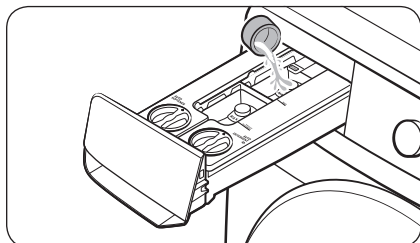

Add only liquid chlorine bleach to the **bleach compartment**. Do not exceed the **max line**.

⚠ CAUTION

- Do not add the liquid bleach without the liquid bleach container in the manual bleach compartment.
- Do not add undiluted liquid chlorine bleach directly to the load or to the drum. It is a powerful chemical and can cause fabric damage, such as weakening of the fibers or color loss if not used properly.

To use oxygen boosters or color-safe bleach

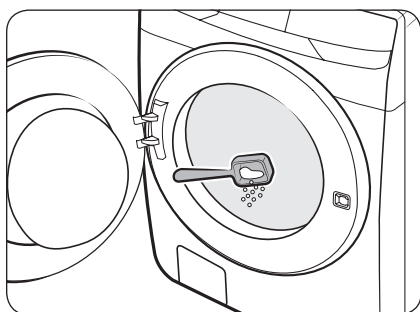

Oxygen boosters or color-safe bleach can increase washing performance. Make sure to add the oxygen booster or color-safe bleach after putting the laundry into the drum.

📖 NOTE

To use both powdered detergent and powdered oxygen booster or powdered color-safe bleach, it is more effective to put them together into the drum before loading the laundry.

To apply washing agents to the auto dispenser

📖 NOTE

- If message "**Refill detergent**", "**Refill softener**", or "**Refill detergent & softener**" appears on the display, refill the corresponding compartment.
- Once you refill the auto detergent/softener compartments, the washer will start to detect the detergent/softener amount when you tap and hold ▶||.
 - The detection time may vary depending on the type of the detergent/softener.

Before you start

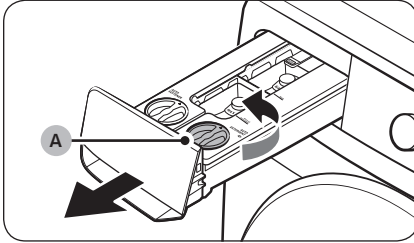

1. Pull the detergent drawer to open.
2. Turn the **auto detergent compartment cover (A)** anticlockwise to open.

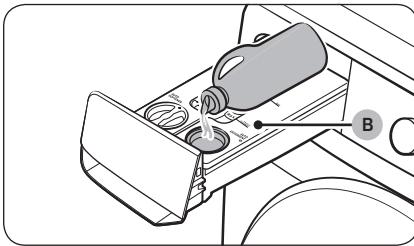

3. Apply an appropriate amount of detergent to the **auto detergent compartment (B)**.
 - After you finish, put the cover back and turn it clockwise to close.

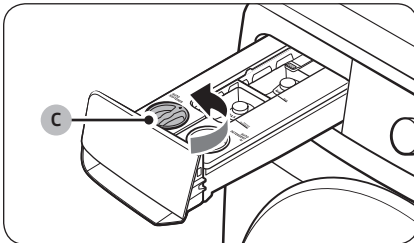

4. Turn the **auto softener compartment cover (C)** anticlockwise to open.

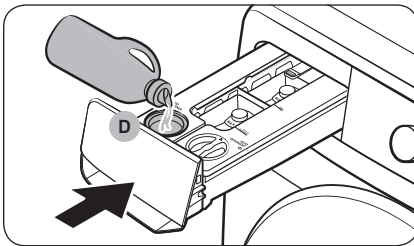

5. Apply an appropriate amount of softener to the **auto softener compartment (D)**.
 - After you finish, put the cover back and turn it clockwise to close.
6. Push the detergent drawer to close.
 - Push the detergent drawer all the way to the end. You will hear a click sound when the drawer is properly closed.

 **CAUTION**

- Do not apply detergent/softener to the drawer without the detergent/softener compartment.
 - If you do, clean the drawer and then reinsert both compartments.
- Use only liquid detergent/softener with the detergent/softener compartments. Do not use powdered detergent.
- Make sure both detergent/softener compartments are inserted completely.
 - If they are not, the washer may not start operating or fail to dispense washing agents.
- Clean the detergent/softener compartment before refilling them with the same or a different type of detergent or softener.
- Do not leave detergent/softener in the detergent/softener compartments for more than 6 weeks.
- Do not mix detergent with fabric softener in either compartment.
- To prevent detergent/softener from hardening, do not open the cover once the detergent/softener has been applied to the compartment.
- Do not use any bleach that may cause corrosion and/or generate the gas.
- Do not turn any compartment upside down.
 - The content may spill.
- Do not press the outlet at the rear of either compartment while moving it.
 - The content may leak.
- Use caution when inputting detergent or fabric softener in the applicable compartment.
 - The content may spill.
- When removing the detergent/softener compartment to check the remaining content (upon an error message or before the message appears), the drawer may have content remaining or leaking from the bottom of the drawer.
- Make sure all the compartments in the detergent drawer are empty before moving the washer.
- The input or refill level of the detergent/softener depends on the type or the remaining amount of detergent/softener.
- If you see the "**Refill detergent**", "**Refill softener**", or "**Refill detergent & softener**" message on the display, immediately refill the corresponding compartment. A later refill may cause the input level of the agent to decrease.
- Applying detergent directly on laundry cause discolouration. Apply detergent in the detergent compartment.
- Do not use hardened detergent/softener.





 **NOTE**

- Moisture on powder detergent compartment causes the powdered detergent to stick. Therefore, wipe the moisture with dry cloth before adding the powdered detergent.
- Use detergent and bleach for washer only.
- Do not put organic, natural, or handmade laundry detergent/softener into the Auto detergent/softener compartment, as they may not be detected properly by the washing machine.
- Do not use gel-type or viscous detergent/softener in the detergent drawer as they may not flow well.
 - Read the detergent/softener manufacturer's instructions before using them in the washer.

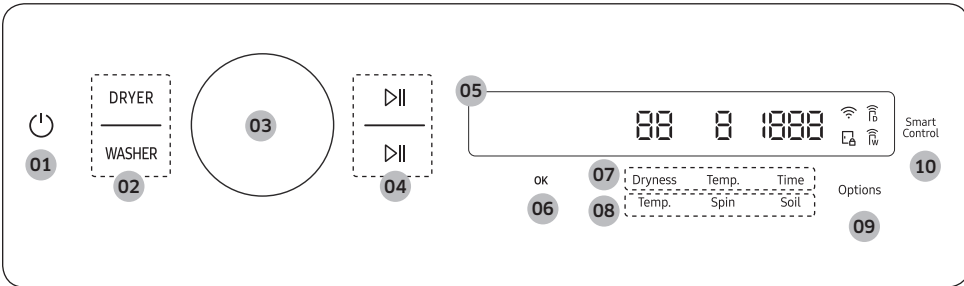
Operations

Multi-control panel







<p>01 Power </p>	<p>Tap to turn the washer on or off.</p> <ul style="list-style-type: none"> After connecting the washer and the dryer with the multi-control cable, only the washer will turn on when you tap the button. Once the washer turns on, tap DRYER to turn on the dryer. If you do not manipulate the control panel for 10 minutes after turning on the washer, the washer automatically turns off. The washer automatically turns off when the cycle completes. <p>⚠ CAUTION Do not tap  to turn off the power while the cycle is in progress. Tap  to pause the cycle first, and then tap  to turn off the power.</p>
<p>02 WASHER / DRYER</p>	<p>Tap WASHER to select the washer and use its features.</p> <ul style="list-style-type: none"> You can tap and hold WASHER for 3 seconds to cancel the washer operation. <p>Tap DRYER to select the dryer and use its features.</p> <ul style="list-style-type: none"> You can tap and hold DRYER for 3 seconds to cancel the washer operation. <p>📖 NOTE Dryer can be operated from the washer when units are stacked using DV-MCK accessory (sold separately).</p>
<p>03 Navigation dial</p>	<p>Turn the navigation dial left or right to navigate through cycles and functions. Your selection (such as cycle, additional functions, and system functions) is displayed on the LCD as you turn the navigation dial.</p>
<p>04 Start/Pause </p>	<p>You can start or pause the operation.</p> <ul style="list-style-type: none"> The upper button controls the dryer, and the lower button controls the washer. Tap and hold the button to start the operation. During the operation, tap the button to pause.
<p>05 Display</p>	<p>The display shows current cycle information and estimated time remaining, or an information message when a problem occurs.</p>

06 OK	<p>Tap to confirm your selection of function or setting.</p> <ul style="list-style-type: none"> The button is inactive when the selected function or setting is not supported.
07 Dry cycle settings	<p>Tap the desired button to change the default dry cycle settings.</p> <ul style="list-style-type: none"> Dryness: Tap to change the dry level. You can select from levels 1 to 5, but the available level depends on the selected cycle. <ul style="list-style-type: none"> 4 or 5: Suitable for large and thick items. 3: Standard drying level. 2: The Damp dry level is designed to partially dry items. Use for items that lay flat or hang to dry. 1: Gently dries items to protect the fabric. Suitable for delicate items or items you want to naturally dry (by hanging or laying flat on the drying rack) while they are damp. Temp.: Temperature can only be adjusted in TIME DRY cycle. Tap to change the temperature of the current cycle. Time: Tap to change the cycle time. <ul style="list-style-type: none"> Some cycles do not support a time setting. You can set the drying time between 10 minutes and 90 minutes. However, available drying time depends on the selected cycle.
08 Wash cycle settings	<p>Tap the desired button to change the default wash cycle settings.</p> <ul style="list-style-type: none"> Temp.: Tap to change the water temperature for the selected cycle. Spin: Tap to change the spin speed for the selected cycle. <ul style="list-style-type: none"> Drain & No Spin: The drum does not spin after the final drain process. Rinse Hold & No Spin (All indicators are off): The final rinse process is suspended so that the laundry remains in the water. To unload the laundry, run a drain or spin process. Soil: Tap to change the soil level for the current cycle.
09 Options	<p>Tap to enter the Options menu. Tap and hold for 3 seconds to enter the System Functions menu.</p>
10 Smart Control	<p>Tap to activate or deactivate the Smart Control function. Tap and hold to enter pairing mode to connect to the SmartThings app.</p> <ul style="list-style-type: none"> When the Smart Control function is activated, you can control your washer remotely using the SmartThings app on your smartphone or tablet (Android or iOS). When you tap the button, the Smart Control function activates on both the washer and the dryer. For more information on Smart Control, see page 50.

Operations

Icon descriptions

	Wi-Fi	<ul style="list-style-type: none">This icon indicates that the washer is connected to Wi-Fi.
	Door Lock	<ul style="list-style-type: none">This icon indicates the door is locked and cannot be opened.The door locks automatically during a cycle and this indicator turns on.You can open the door when this icon disappears.
	Smart Control	<ul style="list-style-type: none">This icon indicates that the washer's Smart Control is on.For more information on Smart Control, see page 50.
		<ul style="list-style-type: none">This icon indicates that the dryer's Smart Control is on.For more information on Smart Control, see page 50.

Operating a cycle

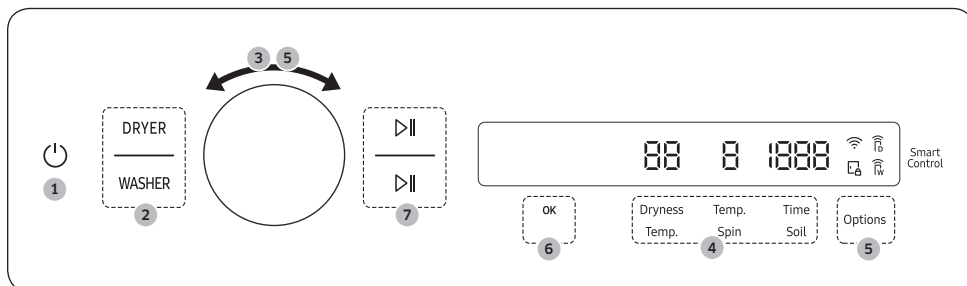

1. Tap to turn the power on.
2. Tap **DRYER** or **WASHER**.
 - Tap **WASHER** to select the washer and use its features.
 - Tap **DRYER** to select the dryer and use its features.
3. Turn the **Navigation dial** to select the cycle you want.
 - For more information on **Cycle overview**, see page **40**.
 - For more information on the dryer's cycles, please see the dryer's user manual.
4. Change the default cycle options.
 - For the washer, tap **Temp.**, **Spin**, or **Soil** to change the default cycle settings.
 - For the dryer, tap **Dryness**, **Temp.**, or **Time** to change the default cycle settings.
5. Tap **Options**, and then turn the **Navigation dial** to select the desired additional function.
 - For more information on **Options**, see page **44**.
 - For more information on the dryer's additional functions, please see the dryer's user manual.
6. Tap **OK** to change the settings for selected additional function.
 - Not all cycles have additional functions available.
7. Tap and hold to start operation.
 - Once you set the cycle you want, the screen displays a brief cycle description, and cycle time. You can also check the cycle progress, remaining cycle time, and information codes.

NOTE

For detailed information on the dryer's cycles and using the dryer, please see the dryer's user manual.

Operations

Cycle overview

NOTE

For more information on the dryer's cycles, please see the dryer's user manual.

Cycle descriptions

You can add or delete cycles to personalize the cycle list in the My Cycles option. See page 45 for more information.

Cycle	Description
Normal	<ul style="list-style-type: none">For cottons, bed linens, table linens, underwear, towels, or shirts. The washing time and the rinse count are automatically adjusted according to the load.
OptiWash	<ul style="list-style-type: none">Adjusts the amount of detergent and the cycle according to the load and the soil severity. This cycle is best used with the Auto Dispense function.
Heavy Duty	<ul style="list-style-type: none">For sturdy, colorfast fabrics and heavily soiled items.
Super Speed	<ul style="list-style-type: none">Normal cycle with the Super Speed option.The shortened time may differ depending on the load/options.
Small Load	<ul style="list-style-type: none">For lightly soiled items that you want to finish washing quickly.For best performance, recommended load is 4 lb or lower.
Delicates	<ul style="list-style-type: none">For sheer fabrics, bras, lingerie (silk), and other handwash-only fabrics.The default setting for "Dose per Wash" and "Dose per Rinse" option is Off in this cycle.
Steam Whites	<ul style="list-style-type: none">For white items. You can wash with or without bleach.
Steam Sanitize	<ul style="list-style-type: none">For colourfast fabrics and heavily soiled laundry, this cycle heats the supplied water over 60 °C to clean deeply.If you stop running the cycle while the washer is heating the water, the door remains locked for your safety.
Steam Normal	<ul style="list-style-type: none">For washing everyday garments with steam.
Towels	<ul style="list-style-type: none">For bath towels, washcloths, and mats.
Bedding	<ul style="list-style-type: none">For bulky items such as comforters, blankets, and sheets.For best results, wash only 1 type of bedding.For bulky items, use liquid detergent and do not roll the items in the drum because they might get stuck in the drum.

Cycle	Description
Outdoor	<ul style="list-style-type: none"> For outdoor clothes, skiwear, and sportswear that are made of functional materials such as spandex, stretch, and micro-fibre. The default setting for “Dose per Wash” and “Dose per Rinse” option is Off in this cycle.
Activewear	<ul style="list-style-type: none"> For exercise wear such as sports jerseys, training pants, shirts/tops and other performance clothing. This cycle provides effective soil removal with controlled drum rotation for special fabric care. The default setting for “Dose per Wash” and “Dose per Rinse” option is Off in this cycle.
Denim	<ul style="list-style-type: none"> For denim and jeans. Wash inside out. Denim and jeans often contains excess dye and may run during the first few washes. Wash light and dark colored items separately.
Wool	<ul style="list-style-type: none"> Specific for machine-washable wool for loads less than 2.0 kg. The Wool cycle features fine pulsating and soaking to protect the wool fibres from shrinkage/distortion. A neutral detergent is recommended. The default setting for “Dose per Wash” and “Dose per Rinse” option is Off in this cycle.
Colors	<ul style="list-style-type: none"> This cycle washes items in low-temperature water to prevent discoloration
Perm Press	<ul style="list-style-type: none"> For wash-and-wear, synthetic fabrics, and lightly to normally soiled items.
Eco Cold	<ul style="list-style-type: none"> For normally and lightly soiled items. This cycle uses only cold water to save energy. Cold water also helps prevent fabric damage.
Steam Bulky	<ul style="list-style-type: none"> Bedding cycle with the steam function.
Steam Allergen	<ul style="list-style-type: none"> To remove dust, pollen, and other non-living allergen substances from fabric.
Power Steam	<ul style="list-style-type: none"> Heavy Duty cycle with the steam function.
Power Rinse	<ul style="list-style-type: none"> To wash with powerful rinsing performance.
Spin Only	<ul style="list-style-type: none"> To perform the spin process only.
Rinse+Spin	<ul style="list-style-type: none"> Features an additional rinse process after fabric softener is applied to the laundry.
Self Clean+	<ul style="list-style-type: none"> Cleans the drum by removing dirt and build-up from the drum. Perform once every 40 washes. Make sure the drum is empty.

Operations

Cycle chart

Use this chart to set the best cycle and options for your laundry.

Temp.	Spin	Soil level
1 : Tap Cold	1 : Extra Low	1 : Extra Light
2 : Cold	2 : Low	2 : Light
3 : Warm	3 : Medium	3 : Normal
4 : Hot	4 : High	4 : heavy
5 : Extra Hot	5 : Extra High	5 : Extra Heavy

● : factory setting, ○ : can be selected

Cycle	Functions														
	Temp.					Spin					Soil level				
	5	4	3	2	1	5	4	3	2	1	5	4	3	2	1
Normal	○	○	●	○	○	○	●	○	○	○	○	○	●	○	○
OptiWash		○	●	○	○	○	●	○	○	○			●		
Heavy Duty	○	●	○	○	○	●	○	○	○	○	●	○	○	○	○
Super speed		○	●			○	●	○	○	○	○	○	●	○	○
Small load		○	●	○	○	●	○	○	○	○	○	○	○	○	●
Delicates			○	○	●		●	○	○	○	○	○	●	○	○
Steam Whites		●				○	●	○	○	○	○	○	●	○	○
Steam Sanitize	●					○	●	○	○	○	○	○	●	○	○
Steam Normal		●				○	●	○	○	○	○	○	●	○	○
Towels		○	●	○	○	○	●	○	○	○	○	○	●	○	○
Bedding			●	○	○		○	●	○	○	○	○	●	○	○
Outdoor			●	○	○		●	○	○	○	○	○	●	○	○
Activewear			●	○	○			●	○	○	○	○	●	○	○
Denim			●	○	○		●	○	○	○	○	○	●	○	○
Wool			●	○	○			●	○				●		
Colors					●	○	●	○	○	○	○	○	●	○	○
Perm Press			●	○	○		○	○	●	○	○	○	●	○	○
Eco Cold				○	●	○	●	○	○	○	○	○	●	○	○
Steam Bulky			●					○	●	○	○	○	●	○	○
Steam Allergen		●				○	●	○	○	○	○	○	●	○	○
Power Steam		●				●	○	○	○	○	●	○	○	○	○
Power Rinse		○	●	○	○	○	●	○	○	○	○	○	●	○	○

Cycle	Functions														
	Temp.					Spin					Soil level				
	5	4	3	2	1	5	4	3	2	1	5	4	3	2	1
Spin only						○	●	○	○	○					
Rinse+Spin						○	●	○	○	○					
Self clean+	●					●							●		

Cycle	Option		
	Super speed	Extra rinse	Pre soak
Normal		○	○
OptiWash		○	○
Heavy Duty	○	○	○
Super speed	●	○	
Small load		○	
Delicates		○	
Steam Whites	○	○	○
Steam Sanitize		○	○
Steam Normal		○	○
Towels		○	○
Bedding	○	○	○
Outdoor		○	
Activewear		○	○
Denim		○	○
Wool			
Colors		○	○
Perm Press		○	○
Eco Cold		○	○
Steam Bulky	○	○	○
Steam Allergen		○	○
Power Steam	○	○	○
Power Rinse		○	○
Spin only			
Rinse+Spin		○	
Self clean+			



Operations

Options

Using Options

1. Tap **Options**.
2. Turn the **Navigation dial** to select the desired additional function.
3. Tap **OK** to change the selected function's settings or start the function.

NOTE

- To return to the main screen, tap **Options** again or turn the **Navigation dial** to select **Back** and tap **OK**.
- If the selected function is not supported, the "**Currently not supported**" message is displayed, and the **OK** button is not activated.
- When you select an additional function, a brief help message appears for the first ten times of use.

Super Speed

Use this function if you need to shorten the washing time.

1. Tap **Options**.
2. Turn the **Navigation dial** to select **Super Speed**, and then tap **OK**.
3. Tap **OK** to select **On** or **Off**.
 - Only available with **Superspeed**, **Heavy Duty**, **Power Steam**, **Bedding**, **Steam Bulky**, and **Steam Whites** cycles.
 - The shortened time may differ depending on the load/options.

Extra Rinse

Adds an additional rinse at the end of the cycle to remove laundry additives more thoroughly.

1. Tap **Options**.
2. Turn the **Navigation dial** to select **Extra Rinse**, and then tap **OK**.
3. Tap **OK** to select **On** or **Off**.

Pre Soak

This adds 30 minutes of soaking time at the start of the wash cycle for better stain removal.

1. Select a cycle and change the cycle settings as necessary.
2. Tap **Options**.
3. Turn the **Navigation dial** to select **Pre Soak**, and then tap **OK**.
4. Tap **OK** to select **On** or **Off**.



Dose per Wash

You can increase or decrease the amount of detergent dispensed automatically.

1. Tap **Options**.
2. Turn the **Navigation dial** to select **Dose per Wash**, and then tap **OK**.
3. Tap **OK** to select the desired setting.
 - Default setting is Med. (Medium).
 - You can select from Med., High, Off, or Low.

Dose per Rinse

You can increase or decrease the amount of softener dispensed automatically.

1. Tap **Options**.
2. Turn the **Navigation dial** to select **Dose per Rinse**, and then tap **OK**.
3. Tap **OK** to select the desired setting.
 - Default setting is Med. (Medium).
 - You can select from Med., High, Off, or Low.

My Cycles

Add or remove cycles to create a personal cycle list.

1. Tap **Options**.
2. Turn the **Navigation dial** to select **My Cycles**, and then tap **OK**.
 - You can only edit a cycle to create a personal cycle when the washer is not operating.
3. Turn the **Navigation dial** to select a desired cycle.
4. Tap **OK** to add or remove the selected cycle.
 - Addition and removal of the course is saved automatically.
5. Once you finish creating My Cycles, tap **Options** to return to the cycles screen.

NOTE

- The Normal and Self Clean+ cycles cannot be removed from the cycles list.
- You can also edit My Cycles in the SmartThings app.



Operations

Drum Light

This turns on the light inside the drum so you can check the status of the items inside.

1. Tap **Options**.
2. Turn the **Navigation dial** to select **Drum Light**, and then tap **OK**.
 - Even if the washer is turned off, the drum light will turn on as long as the power cable is connected.
 - Once the Drum Light function is enabled, the drum light will turn off automatically after 2 minutes.
 - Opening the washer door automatically turns on the drum light. The light will then turn off automatically after 2 minutes.
 - Water droplets on the surface of the drum light can scatter light such that it resembles a yellow stain. This is merely an optical illusion and not a malfunction.

Delay End

You can set the washer to finish your wash automatically at a later time, choosing a delay of between 1 to 24 hours (in 1 hour increments). The hour displayed indicates the time the wash will finish.

1. Select a cycle and change the cycle settings as necessary.
2. Tap **Options**.
3. Turn the **Navigation dial** to select **Delay End**, and then tap **OK**.
4. Turn the **Navigation dial** to select the desired time, and then tap **OK**.
5. Tap and hold **▶||**.
 - Status shows in the display and the washer tumbles the drum to sense the weight of the load (if load sensing is preset for the selected cycle). When load sensing is complete, the display shows the remaining time until the end of the wash cycle.
 - To cancel Delay End, tap **⏻** to restart the washer.

Child Lock

To prevent children or infants from accidentally starting or setting the washer, Child Lock locks all buttons except for **⏻** and **Options**.

1. Tap **Options**.
2. Turn the **Navigation dial** to select **Child Lock**, and then tap **OK**.
3. Tap **OK** to select **On** or **Off**.

NOTE

- When Child Lock is on, all buttons are disabled except for **⏻** and **Options**. The washer door also locks.
- Tapping a button while Child Lock is on triggers an alarm with the “**Child Lock On**” message.
- You cannot open the door after a wash cycle when the Child Lock is on. Turn the function off before opening the door to take out the laundry.
- Setting Child Lock on the multi-control panel applies the function to both the washer and the dryer.
 - You can individually change the Child Lock setting for the dryer on the dryer’s control panel.



System Functions

Using System Functions

1. Tap and hold **Options** for 3 seconds.
2. Turn the **Navigation dial** and select the desired system function, and then tap **OK**.
3. Tap **OK** to change the selected function's settings or start the function.

NOTE

To return to the main screen, tap **Options** again or turn the **Navigation dial** to select **Back** and tap **OK**.

Detergent

You can change the concentration level of the detergent.

1. Tap and hold **Options** for 3 seconds.
2. Turn the **Navigation dial** to select **Detergent**, and then tap **OK**.
3. Tap **OK** to select the desired setting.
 - The default setting is 1x.
 - You can select from 1x, 2x, or 3x.

NOTE

The dispense amount of detergent decreases as the concentration level increases.

Softener

You can change the concentration level of the softener.

1. Tap and hold **Options** for 3 seconds.
2. Turn the **Navigation dial** to select **Softener**, and then tap **OK**.
3. Tap **OK** to select the desired setting.
 - The default setting is 1x.
 - You can select from 1x, 2x, or 3x.

NOTE

The dispense amount of softener decreases as the concentration level increases.

Operations

AI Pattern

This function saves frequently used cycles and settings. When you turn the function on, the washer remembers the cycles you use most and their settings (Temp., Rinse, Spin) and displays them in frequency order.

1. Tap and hold **Options** for 3 seconds.
2. Turn the **Navigation dial** to select **AI Pattern**, and then tap **OK**.
3. Tap **OK** to select **On** or **Off**.
 - The default setting is On. Set it to Off if you do not want to use this function.
 - When you turn off the function, all the saved data resets.

Alarm

You can turn on or off the sound from the washer. When this function is set to Off, the melody of cycle completion and the power-off beep does not sound. However, the other sounds stay active.

1. Tap and hold **Options** for 3 seconds.
2. Turn the **Navigation dial** to select **Alarm**, and then tap **OK**.
3. Tap **OK** to select **On** or **Off**.
 - The default setting is On.

NOTE

- The setting remains unchanged even if you restart the washer.
- If you turn on Alarm after connecting your washer and the dryer with the multi-control connection cable, the sound only plays on the multi-control panel.
- If you disconnect the multi-control connection, the sound plays on each appliance which you manipulate.

Calibration

You can run calibration again for accurate weight detection.

1. Tap and hold **Options** for 3 seconds.
2. Turn the **Navigation dial** to select **Calibration**, and then tap **OK**.
 - Calibration does not start if the door is not closed properly.
 - The drum rotates clockwise and anticlockwise for about 3 minutes.
3. When calibration is complete, the "Calibration complete" message appears on the display and the washer turns off automatically.

Wi-Fi

You can turn the washer's Wi-Fi on or off.

1. Tap and hold **Options** for 3 seconds.
2. Turn the **Navigation dial** to select **Wi-Fi**, and then tap **OK**.
3. Tap **OK** to select **On** or **Off**.
 - The washer's Wi-Fi is off as a factory default setting. However, the washer's Wi-Fi turns on automatically when you turn on the washer for the first time. Then, the final Wi-Fi setting maintains regardless of the washer power status.
 - Once you turn on the washer's Wi-Fi and connect to a network, the washer remains connected to the network even when you turn off the power.
 - The Wi-Fi  indicates that the washer is connected to the router through the Wi-Fi connection.

Language

You can change the system language.

1. Tap and hold **Options** for 3 seconds.
2. Turn the **Navigation dial** to select **Language**, and then tap **OK**.
3. Turn the **Navigation dial** to select the desired language, and then tap **OK**.

Self Diagnosis

You can use this function to check if there are any abnormal signs on your washing machine.

1. Tap and hold **Options** for 3 seconds.
2. Turn the **Navigation dial** to select **Self Diagnosis**, and then tap **OK**.
 - Self Diagnosis starts immediately and "Testing..." is displayed during the self diagnosis process.
 - Once the self diagnosis process starts, only the  button remains active.
 - If the washing machine detects any errors, an information code and the solution is displayed on the control panel.

Factory Reset

You can reset the washer.

1. Tap and hold **Options** for 3 seconds.
2. Turn the **Navigation dial** to select **Factory Reset**, and then tap **OK**.
 - Your washer resets to the factory setting.



Operations

Special features

Smart control

You can connect to the SmartThings app and control your washer remotely.

Connecting your washer

1. Download and open the SmartThings app on your smartphone or tablet (Android & iOS).
2. Tap  to turn on the washer.
3. Tap and hold **Smart Control**.
 - a. The washer enters AP mode and connects to your smartphone or tablet.
 - b. Tap **Smart Control** to authenticate your washer.
 - c. Once the authentication process is complete, your washer is successfully connected to the app.
 - You can use various features available in the SmartThings app.

NOTE

- If your washer fails to connect with the SmartThings app, try again.
- Check your router if you experience any Internet connection problem after connecting your washer with the SmartThings app.
- If the Wi-Fi is off, tap and hold **Options** for 3 seconds to enter the System functions menu, and select Wi-Fi to turn it on.
- Turning the washer's Wi-Fi on allows you connect to the washer via SmartThings app on your smartphone or tablet, regardless of the power status of the washer. However, the washer appears offline on the SmartThings app if the washer's Wi-Fi is off.
- Close the door before starting the Smart Control function.
- If you use your washer for a while without connecting it to the SmartThings app, a pop-up message about Smart Control will show for 3 seconds on 20th, 40th, and 60th use.
- If the washer's Wi-Fi is not connected to an AP (access point), the Wi-Fi will turn off when you turn of the power.
- You can turn on or off the Smart Control function simultaneously for both the washer and the dryer on the multi-control panel. However, you must complete EasySetup on both appliances in prior.
- If you turn on the Smart Control function on the multi-control panel after you complete EasySetup for both appliances, Smart Control icons for both appliances appear on display.



Stay Connect

Set up the Stay Connect function in your SmartThings app to keep Smart Control turned on at the end of a cycle. Your washer stays connected to the app so you can send additional instructions, whether you are at home or away.

1. If you turn on the Stay Connect function on the SmartThings app, the washer will stay in standby power saving mode after completing a cycle.
 - The Stay Connect function will remain active for up to 24 hours if the door remains closed.
2. When the Stay Connect function is active, the Smart Control, Door Lock, and Wi-Fi icons are illuminated on your washer display.
3. You can conveniently control your washer, adding rinse, spin cycles using the SmartThings app.

NOTE

- The washer switches to standby power saving mode when operation is paused even if the machine is not connected to the SmartThings app.
- In some circumstances, only the Door Lock icon may be illuminated.



Operations

SmartThings

Wi-Fi connection

On your smartphone or tablet, go to **Settings** and turn on the wireless connection and select an AP (Access Point).

- This appliance supports the Wi-Fi 2.4 GHz protocols.

Download

On an app market (Google Play Store, Apple App Store, Samsung Galaxy Apps), find the SmartThings app with a search term of "SmartThings". Download and install the app on your device.

NOTE

The app is subject to change without notice for improved performance.

Log in

You must first log into SmartThings with your Samsung account. To create a new Samsung account, follow the instructions on the app. You don't need a separate app to create your account.

NOTE

If you have a Samsung account, use the account to log in. A registered Samsung smartphone or tablet user automatically logs in.

To register your appliance to SmartThings

1. Make sure your smartphone or tablet is connected to a wireless network. If not, go to **Settings** and turn on the wireless connection and select an AP (Access Point).
2. Open **SmartThings** on your smartphone or tablet.
3. If a message of "A new device is found.", select **Add**.
4. If no message appears, select **+** and select your appliance in a list of devices available. If your appliance is not listed, select **Device Type** > **Specific Device Model**, and then add your appliance manually.
5. Register your appliance to the SmartThings app as follows.
 - a. Add your appliance to SmartThings. Make sure your appliance is connected to SmartThings.
 - b. When registration is complete, your appliance appears on your smartphone or tablet.



Maintenance



Keep the washer clean to prevent deteriorated performance and to preserve its life cycle.

WARNING

Certain internal parts are intentionally not grounded and may present a risk of electric shock only during servicing. Service personnel – Do not contact the following parts while the appliance is energized: Control board, heat sink, motor, inlet valve and pump.

Self Clean+

Certain usage and environmental conditions may result in some residue build-up or odor in the washer drum. To prevent this build-up or odor and keep your washer drum fresh and clean, perform the Self Clean+ cycle at least once a month or every 40 cycles. Perform the recommended procedure below when using the Self Clean+ cycle.

1. Tap .
2. Turn the **Navigation dial** to select **Self Clean+**.
3. Tap and hold .

CAUTION

If there is chlorine bleach left in the washer drum for an extended period of time, rust can occur.

NOTE

- The water temperature for Self Clean+ is defaulted to Extra Hot. This temperature cannot be changed.
- In the case where residue is present in the washer drum, add liquid chlorine bleach to the MAX level line in the Manual detergent compartment before starting the Self Clean+ cycle. Do not add the liquid chlorine bleach to the other compartments (This is only the case for Self Clean+ cycle).
- Do not exceed the max line. Do not use or mix any other detergent or chemicals during the Self Clean+ cycle. If necessary, run a Rinse+Spin cycle after the Self Clean+ cycle has completed to help remove any remaining residue.

Self Clean+ reminder

- After every 40 cycles, the washer displays the “**Drum Clean needed**” message for an hour to alert you to run the **Self Clean+** cycle.
- It is recommended to run the cycle regularly for hygienic purposes.
- You will see the **Self Clean+** alert message when the washer completes a cycle. If you open the door, the message disappears, and the display shows the **Self Clean+** cycle setting screen automatically. At this time, the dryer control panel displays the recommended drying cycle.
- The reminder will appear on the control panel for 5 additional consecutive cycles before turning off. The next reminder will not appear until another 40 cycles have been completed.



Maintenance

Emergency drain

In case of a power failure, drain the water inside the drum before taking out the laundry.

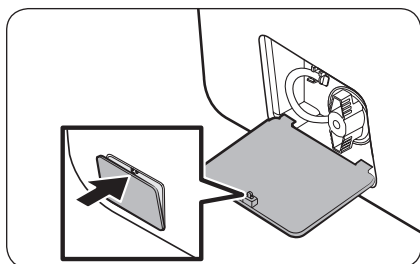

1. Power off and unplug the washer from the electrical outlet.
2. Gently press the top area of the **filter cover** to open.

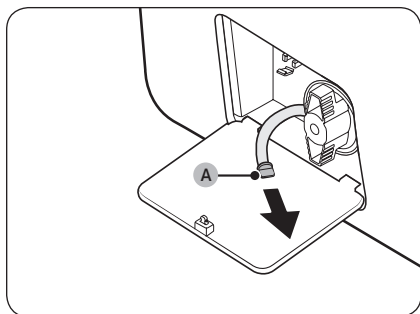

3. Put an empty, spacious container around the cover, and stretch the emergency drain tube to the container while holding the **tube cap (A)**.

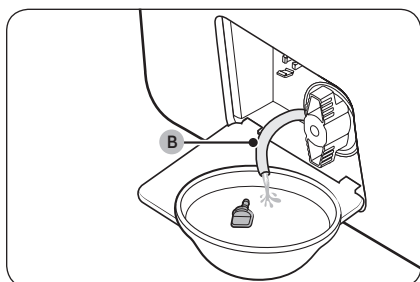

4. Open the tube cap and let water in the **emergency drain tube (B)** flow into the container.
5. When done, close the tube cap, and reinsert the tube. Then, close the filter cover.

NOTE

Use a spacious container because the water in the drum may be more than expected.



Cleaning

Surface of the washer

Use a soft cloth with a nonabrasive household detergent. Do not spray water onto the washer.

Mesh filter

Clean the mesh filter of the water hose once or twice a year.

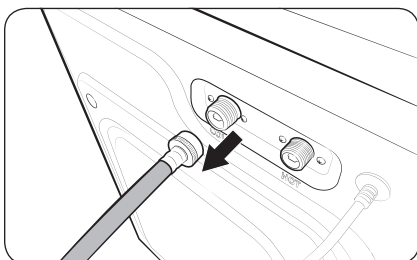

1. Turn off the washer, and unplug the power cord.
2. Close the water tap.
3. Loosen and disconnect the water hose from the back of the washer. Cover the hose with a cloth to prevent water from gushing out.

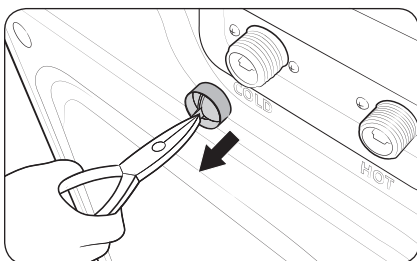

4. Use pliers to pull out the mesh filter from the inlet valve.
5. Submerge the mesh filter deeply in water so that the threaded connector is also submerged.
6. Dry the mesh filter completely in the shade.
7. Reinsert the mesh filter into the inlet valve, and reconnect the water hose to the inlet valve.
8. Open the water tap.

NOTE

If the mesh filter is clogged, an information code of "4C" appears on the screen.

Maintenance

Debris filter

It is advisable to clean the debris filter every 2 months to prevent its clogging. A clogged debris filter may reduce the bubble effect.

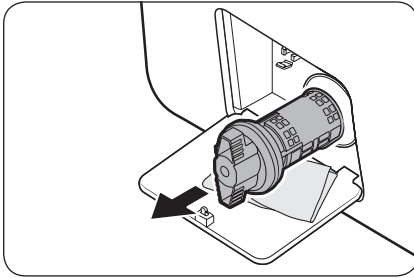

1. Turn off the washer, and unplug the power cord.
2. Drain the remaining water inside the drum. See the **Emergency drain** section.
3. Gently press the top area of the **filter cover** to open.
4. Turn the debris filter knob to the left, and drain off the remaining water.

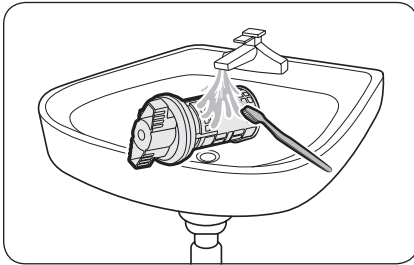

5. Clean the debris filter using soft brushes. Make sure the drain pump propeller inside the filter is unclogged.
6. Reinsert the debris filter, and turn the filter knob to the right.

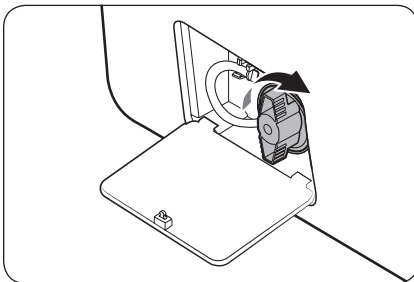

NOTE

- Some debris filters feature a safety knob that is designed to prevent accidents by children. To open the safety knob of the debris filter, push in and turn it anticlockwise. The spring mechanism of the safety knob helps open the filter.
- To close the safety knob of the debris filter, turn it clockwise. The spring makes a rattling sound, which is normal.

NOTE

If the pump filter is clogged, an information code of "5C" appears on the screen.

CAUTION

- Make sure the filter knob is closed properly after cleaning the filter. Otherwise, this may cause a leak.
- Make sure the filter is inserted properly after cleaning it. Otherwise, this may cause an operational failure or a leak.

Detergent drawer

To prevent the detergent residue buildup in the detergent drawer, clean the detergent/softener compartments once or twice a month, and whenever you refill or change the detergent or softener.

⚠ CAUTION

- Make sure to turn off the washer and unplug the power cord before cleaning.
- If you are not going to use the washer for a long time, empty the detergent/softener compartments and clean them thoroughly.

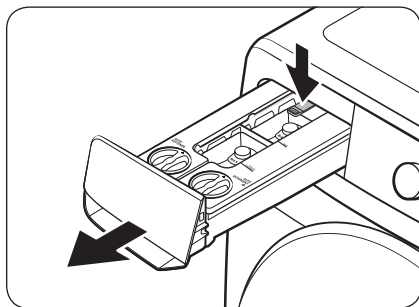

1. While holding down the **release lever** on the inner of the drawer, pull the detergent drawer to remove.

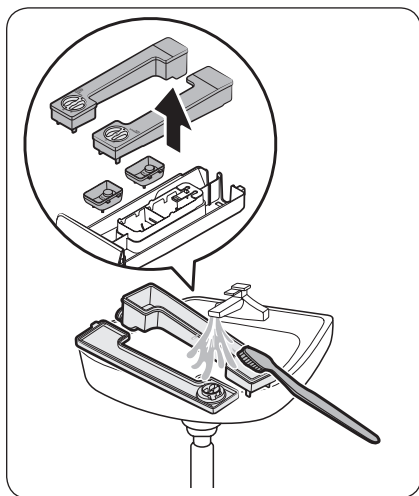

2. Remove the tops of both compartments using the pull tabs located on the back of the lid, then clean inside the compartments under warm running water with a soft brush.
3. Clean the drawer components in warm running water using a soft brush.
 - Wipe all components with a dry towel or cloth after cleaning.



Maintenance

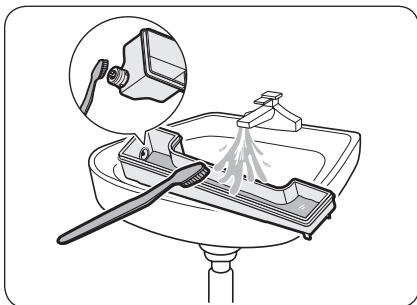

NOTE

If the cleaning agent in the compartment is hardened, open the compartment, and pour lukewarm water into the compartment to dissolve the hardened agents. Then, clean inside the compartment and its rear valve thoroughly.

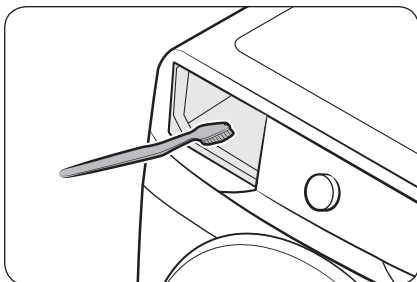

4. Clean the drawer recess using a soft brush to remove detergent residues and limescale on the drawer recess.

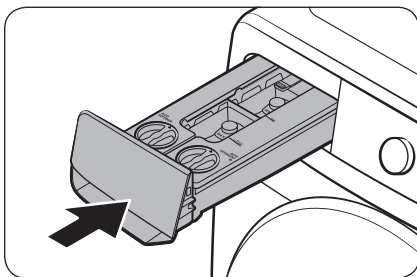

5. Insert the detergent drawer back into the washer.

NOTE

- Make sure the drawer recess is completely dry before inserting the detergent drawer.
- Tightly attach the tops of both compartments before inserting them back into the drawer.

CAUTION

Do not spray water into the detergent drawer recess. It may cause electric shock or fire.



Door diaphragm

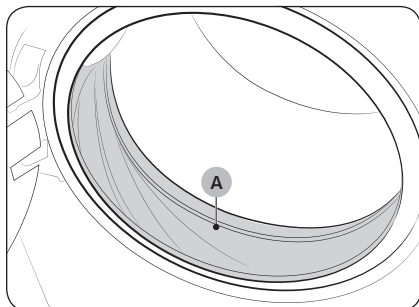

1. Open the door, and then empty the drum.
2. Combine 3/4 cups of liquid chlorine bleach and 1 gallon of warm tap water.
3. Wearing rubber gloves, use a soft, clean cloth dipped in the water and bleach solution to clean the diaphragm.
4. Let stand 5 minutes, and then wipe up and dry well.

CAUTION

Use bleach carefully and be sure to follow the bleach manufacturer's use and care instructions.

Maintenance

Recovery from freezing

The washer may freeze when the temperature in its location drops below 32 °F (0 °C).



1. Turn off the washer, and then unplug the power cord.
2. Pour warm water over the water tap to loosen the water hose.
3. Disconnect the water hose, and then soak it in warm water.
4. Pour warm water into the drum and leave it for about 10 minutes.
5. Reconnect the water hose to the water tap.

NOTE

If the washer still doesn't operate normally, repeat the steps above.

Care for an extended period of non-use

Avoid leaving the washer unused for an extended time. However, if you intend to leave the washer unused for a long period of time, follow the directions below:

1. Tap .
2. Turn the **Navigation dial** to select **Rinse+Spin**.
3. Empty the drum, and then tap and hold .
4. When the cycle is complete, close the water taps and disconnect the water hoses.
5. Turn off the washer, and then unplug the power cord.
6. Open the door to let air circulate through the drum.

Cleaning the exterior

1. Turn off the water taps after finishing the day's washing.
This will shut off the water supply to your washer and prevent the unlikely possibility of damage from escaping water. Leave the door open to allow the inside of your washer to dry out.
2. Use a soft cloth to wipe up all detergent, bleach, or other spills as they occur. Clean the following as recommended below:
 - Control Panel – Clean with a soft, damp cloth. Do not use abrasive powders or cleaning pads. Do not spray cleaners directly on the panel.
 - Cabinet – Clean with soap and water.

Cleaning the interior

Clean the interior of your washer periodically to remove any dirt, soil, odor, mold, mildew, or bacterial residue that may remain in your washer as a result of washing clothes.

 **CAUTION**

Failure to follow these instructions may result in unpleasant conditions, including odors and/or permanent stains on your washer or laundry.

 **NOTE**

Hard water deposits may be removed, if needed. Use a cleaner labeled "Washer safe".



Troubleshooting

If there is any problem, check the information message on the LCD screen and follow the on-screen instructions.

If the problem persists, please contact the service center.

Checkpoints

If you encounter a problem with the washer, first check the table below and try these suggestions.

Problem	Action
Does not start.	<ul style="list-style-type: none"> • Make sure the washer is plugged in. • Make sure the door is properly closed. • Make sure the water taps are open. • Tap and hold ▷ to start the washer. • Make sure Child Lock is not activated. • Before the washer starts to fill, it will make a series of clicking noises to check the door lock and will do quick drain. • Check the fuse or reset the circuit breaker. • Check if power is supplied properly. • Low voltage detected. <ul style="list-style-type: none"> - Check if the power cord is plugged in. • Make sure laundry is not caught in the door.
Water supply is insufficient, or no water is supplied.	<ul style="list-style-type: none"> • Fully open the water tap. • Make sure the door is properly closed. • Make sure the water supply hose is not frozen. • Make sure the water supply hose is not kinked or clogged. • Make sure there is sufficient water pressure. • Make sure that the cold water tap and the hot water tap are properly connected. • Clean the mesh filter as it may be clogged.
After a cycle, detergent remains in the detergent drawer.	<ul style="list-style-type: none"> • Make sure the washer is running with sufficient water pressure. • Make sure the detergent is added to the centre of the detergent drawer. • Make sure the rinse cap is inserted properly. • If using granular detergent, make sure the detergent selector is in the upper position. • Remove the rinse cap and clean the detergent drawer.



Problem	Action
<p>Excessive vibrations or makes noise.</p>	<ul style="list-style-type: none"> • Make sure the washer is installed on a level, solid floor that is not slippery. If the floor is not level, use the levelling feet to adjust the height of the washer. • Make sure the shipping bolts are removed. • Make sure the washer is not in contact with any other object. • Make sure the laundry load is balanced. • The motor can cause noise during normal operation. • Overalls or clothes with metallic decorations can cause noise while being washed. This is normal. • Metal objects such as coins can cause noise. After washing, remove these objects from the drum or filter case. • Redistribute the load. If only one item of clothing needs washing, such as a bathrobe or pair of jeans, the final spin result might be unsatisfactory, and a “Unbalanced laundry detected” check message will be shown in the display.
<p>Does not drain and/or spin.</p>	<ul style="list-style-type: none"> • Make sure the drain hose is straightened all the way to the drain system. If you encounter a drain problem, call for service. • Make sure the debris filter is not clogged. • Close the door and tap and hold ▷ . For your safety, the washer will not tumble or spin unless the door is closed. • Make sure the drain hose is not frozen or clogged. • Make sure the drain hose is connected to a drain system that is not clogged. • If the washer is not supplied with sufficient power, the washer will temporarily not drain or spin. As soon as the washer regains sufficient power, it will operate normally. • Make sure the drain hose is positioned correctly, depending on the connection type. • Clean the debris filter as it may be clogged.
<p>The door does not open.</p>	<ul style="list-style-type: none"> • Tap ▷ to stop the washer. • It may take a few moments for the door lock mechanism to disengage. • The door will not open until 3 minutes after the washer has stopped or the power has been off. • Make sure all the water in the drum is drained. • The door may not open if water remains in the drum. Drain the drum and open the door manually. • Make sure the door lock light is off. The door lock light turns off after the washer has drained.

Troubleshooting

Problem	Action
Excessive suds.	<ul style="list-style-type: none"> • Make sure you use the recommended types of detergent as appropriate. • Use high efficiency (HE) detergent to prevent oversudsing. • Reduce the detergent amount for soft water, small loads, or lightly soiled loads. • Non-HE detergent is not recommended.
Cannot add additional detergent.	<ul style="list-style-type: none"> • Make sure the remaining amount of detergent and fabric softener is not over the limit.
Stops.	<ul style="list-style-type: none"> • Plug the power cord into a live electrical outlet. • Check the fuse or reset the circuit breaker. • Close the door, and tap and hold ▷ to start the washer. For your safety, the washer will not tumble or spin unless the door is closed. • Before the washer starts to fill, it will make a series of clicking noises to check the door lock and will do quick drain. • There may be a pause or soak period in the cycle. Wait briefly, and the washer may start. • Make sure the mesh filter of the water supply hose at the water taps is not clogged. Periodically clean the mesh filter. • If the washer is not supplied with sufficient power, the washer will temporarily not drain or spin. As soon as the washer regains sufficient power, it will operate normally.
Fills with the wrong water temperature.	<ul style="list-style-type: none"> • Fully open both taps. • Make sure the temperature selection is correct. • Make sure the hoses are connected to the correct taps. Flush water lines. • Make sure the water heater is set to supply a minimum of 49 °C hot water at the tap. Also, check the water heater capacity and recovery rate. • Disconnect the hoses and clean the mesh filter. The mesh filter may be clogged. • While the washer fills, the water temperature may change as the automatic temperature control feature checks incoming water temperature. This is normal. • While the washer fills, you may notice just hot and/or just cold water going through the dispenser when cold or warm temperatures are selected. This is a normal function of the automatic temperature control feature as the washer determines the water temperature.
Load is wet at the end of a cycle.	<ul style="list-style-type: none"> • Use the High or Extra High spin speed. • Use high efficiency (HE) detergent to reduce oversudsing. • Load is too small. Small loads (one or two items) may become unbalanced and not spin completely. • Make sure the drain hose is not kinked or clogged.

Problem	Action
Leaks water.	<ul style="list-style-type: none"> • Make sure the door is properly closed. • Make sure all hose connections are tight. • Make sure the end of the drain hose is correctly inserted and secured to the drain system. • Avoid overloading. • Use high efficiency (HE) detergent to prevent oversudsing. • Check the drain hose. <ul style="list-style-type: none"> - Make sure the end of the drain hose is not placed on the floor. - Make sure the drain hose is not clogged.
Has odours.	<ul style="list-style-type: none"> • Excessive suds collect in recesses and can cause foul odours. • Run cleansing cycles to sanitise periodically. • Clean the door seal (diaphragm). • Dry the washer interior after a cycle has finished.
A message appears on the display to alert that dispenser is open.	<ul style="list-style-type: none"> • Check if the detergent drawer is closed properly. <ul style="list-style-type: none"> - Open the detergent drawer and close it again. Make sure it's closed properly.
The "Refill detergent", "Refill softener", or "Refill detergent & softener" message does not disappear after refilling the detergent/softener.	<ul style="list-style-type: none"> • After refilling the auto detergent/softener compartments, close the detergent drawer, and then tap and hold ▷ . Then, the washer will start to detect the detergent/softener, and the message will disappear. • Depending on the type of detergent/softener, the message may not disappear immediately.
Detergent/softener is not dispensed.	<ul style="list-style-type: none"> • Check if the "Dose per Wash" or "Dose per Rinse" option is set to Off. <ul style="list-style-type: none"> - Auto detergent/softener compartment does not dispense the detergent/softener if the option is set to Off. - Tap Options, select Dose per Wash or Dose per Rinse, and then tap OK to select the desired input level of detergent/softener. - The "Dose per Wash" and "Dose per Rinse" options automatically turns off in the Wool, Delicates, Outdoor, and Activewear cycles. To dispense detergent/softener in the Wool, Delicates, Outdoor, and Activewear cycles, tap Options, select Dose per Wash or Dose per Rinse, and then tap OK to select the desired input level of detergent/softener.
Excessive or insufficient amount of detergent/softener is dispensed.	<ul style="list-style-type: none"> • Check the "Dose per Wash" and "Dose per Rinse" settings. <ul style="list-style-type: none"> - Tap Options, select Dose per Wash or Dose per Rinse, and then tap OK to select the desired input level of detergent/softener.

If a problem persists, contact a service center. The number of the service center is on the label attached to the product.



Troubleshooting

Information codes

If the washer fails to operate, you may see an information code on the screen. Check the table below and try the suggestions.

Code	Action
Check drainage	<p>Water is not draining.</p> <ul style="list-style-type: none"> • Make sure the drain hose is not frozen or clogged. • Make sure the drain hose is positioned correctly, depending on the connection type. • Clean the debris filter as it may be clogged. • Make sure the drain hose is straightened all the way to the drain system. • If the information code remains, contact a customer service centre
Check water supply	<p>Water is not supplied.</p> <ul style="list-style-type: none"> • Make sure the water taps are open. • Make sure the water hoses are not clogged. • Make sure the water taps are not frozen. • Make sure the washer is operating with sufficient water pressure. • Make sure that the cold water tap and the hot water tap are properly connected. • Clean the mesh filter as it may be clogged. • All buttons will be disabled for 3 minutes after the information code appears. • When the "Check water supply" message appears, the machine drains water for 3 minutes. In the meantime, the Power button will be disabled.
Check water lines	<ul style="list-style-type: none"> • Make sure the cold water supply hose is firmly connected to the cold water tap. If it is connected to the hot water tap, the laundry may be deformed with some cycles.
Unbalanced laundry detected	<p>Spinning does not work.</p> <ul style="list-style-type: none"> • Make sure laundry is spread out evenly. • Make sure the washer is on a flat, stable surface. • Redistribute the load. If only one item of clothing needs washing, such as a bathrobe or pair of jeans, the final spin result might be unsatisfactory, and an "Unbalanced laundry detected" check message will be shown in the display.
Door is open	<p>Operating the washer with the door open.</p> <ul style="list-style-type: none"> • Make sure the door is properly closed. • Make sure laundry is not caught in the door.



Code	Action
OC	Water has overflowed. <ul style="list-style-type: none"> Restart after spinning. If the information code remains on the display, contact a local Samsung service centre.
LC, LC1	Check the drain hose. <ul style="list-style-type: none"> Make sure the end of the drain hose is not placed on the floor. Make sure the drain hose is not clogged. If the information code remains, contact a customer service centre.
3C	Check the drum motor for operation. <ul style="list-style-type: none"> Try restarting the cycle. If the information code remains, contact a customer service centre.
HC	High temperature heating check. <ul style="list-style-type: none"> If the information code remains, contact a customer service centre.
1C	The Water Level sensor is not working properly. <ul style="list-style-type: none"> Turn the machine off, and restart the cycle. If the information code remains, contact a customer service centre.
AC	Check communications between main and sub PBAs. <ul style="list-style-type: none"> Turn the machine off, and restart the cycle. If the information code remains, contact a customer service centre.
AC6	Check communications between the main and the inverter PBAs. <ul style="list-style-type: none"> Depending on the state, the machine may automatically returns to normal operation. Turn the machine off, and restart the cycle. If the information code remains, contact a customer service centre.
DC1	The Main Door lock/unlock is not working properly. <ul style="list-style-type: none"> Turn the machine off, and restart the cycle. If the information code remains, contact a customer service centre.





If any information code keeps appearing on the screen, contact a local Samsung service centre.

Specifications



Fabric care chart

The following symbols provide garment care direction. The clothing care labels include symbols for drying, bleaching, drying and ironing, or dry cleaning when necessary. The use of symbols ensures consistency among garment manufacturers of domestic and imported items. Follow care label directions to optimize garment life and reduce laundering problems.

Wash cycle

	Normal
	Permanent press/Wrinkle resistant/ Wrinkle control
	Gentle/Delicates
	Hand wash



Water temperature

	Hot
	Warm
	Cold



NOTE

The temperature range for Hot is 135 °F (57 °C) or below, 95 °F (35 °C) or below for Warm, and 68 °F (20 °C) or below for Cold. Wash water temperature must be a minimum of 60 °F (16 °C) for detergent activation and effective cleaning.



Bleach

	Any bleach (when needed)
	Only non-chlorine (color-safe) bleach (when needed)
	Tumble dry





Normal

	Permanent press/Wrinkle resistant/ Wrinkle control
	Gentle/Delicates

Special instructions

	Line dry/Hang to dry
	Drip dry
	Dry flat







Heat setting

	High
	Medium
	Low
	Any heat
	No heat / Air





Iron dry or steam temperatures

	High
	Medium
	Low

Warning symbols for laundering

	Do not wash
	Do not wring
	Do not bleach
	Do not tumble dry
	No steam (added to iron)
	Do not iron

Dry-clean

	Dry-clean
	Do not dry-clean
	Line dry/Hang to dry
	Drip dry
	Dry flat

Protecting the environment

- This appliance is manufactured from recyclable materials. If you decide to dispose of it, please observe local waste disposal regulations. Cut off the power cord so that the appliance cannot be connected to a power source. Remove the lid so that animals and small children cannot get trapped inside the appliance.
- Do not exceed the detergent quantities recommended in the detergent manufacturers' instructions.
- Use stain removal products and bleaches before the wash cycle only when necessary.
- Save water and electricity by only washing full loads (the exact amount depends upon the program used).

Declaration of conformity

This appliance complies with UL2157.

Specifications

English

Specification sheet

Type		Front loading washer	
		WF50A88**A*	
Water pressure (psi (kPa))		20-116 (137-800)	
NET weight (lb (kg))		218 (99.0)	
Spin revolution		1200 rpm	
Heating rating		900 W	
Power consumption	Washing	120 V	200 W
	Washing and heating		1150 W
	Spin		550 W
	Drain		80 W

LIMITED WARRANTY (U.S.A.)

SAMSUNG WASHER

LIMITED WARRANTY TO ORIGINAL CONSUMER PURCHASER WITH PROOF OF PURCHASE

This SAMSUNG brand product, as supplied and distributed by SAMSUNG ELECTRONICS AMERICA, INC. (SAMSUNG) and delivered new, in the original carton to the original consumer purchaser, is warranted by SAMSUNG against manufacturing defects in materials or workmanship for the limited warranty period, starting from the date of original purchase, of:

- One (1) year parts and labor,
- Three (3) years stainless tub part (Part Only),
- Ten (10) years washing DD motor part (Part Only)

This limited warranty is valid only on products purchased and used in the United States that have been installed, operated, and maintained according to the instructions attached to or furnished with the product. To receive warranty service, the purchaser must contact SAMSUNG at the address or phone number provided below for problem determination and service procedures. Warranty service can only be performed by a SAMSUNG authorized service center. The original dated bill of sale must be presented upon request as proof of purchase to SAMSUNG or SAMSUNG's authorized service center to receive warranty service.

SAMSUNG will provide in-home service within the contiguous United States during the warranty period at no charge, subject to availability of SAMSUNG authorized servicers within the customer's geographic area. If in-home service is not available, SAMSUNG may elect, at its option, to provide transportation of the product to and from an authorized service center. If the product is located in an area where service by a SAMSUNG authorized servicer is not available, you may be responsible for a trip charge or required to bring the product to a SAMSUNG authorized service center for service.

To receive in-home service, product must be unobstructed and accessible to the service agent.

During the applicable warranty period, a product will be repaired, replaced, or the purchase price refunded, at the sole option of SAMSUNG. SAMSUNG may use new or reconditioned parts in repairing a product, or replace the product with a new or reconditioned product. Replacement parts and products are warranted for the remaining portion of the original product's warranty or ninety (90) days, whichever is longer. All replaced parts and products are the property of SAMSUNG and you must return them to SAMSUNG.

LIMITED WARRANTY (U.S.A.)

This limited warranty covers manufacturing defects in materials or workmanship encountered in normal household, noncommercial use of this product and shall not cover the following: damage that occurs in shipment, delivery, installation, and uses for which this product was not intended; damage caused by unauthorized modification or alteration of the product; product where the original factory serial numbers have been removed, defaced, changed in any way, or cannot be readily determined; cosmetic damage including scratches, dents, chips, and other damage to the product's finishes; damage caused by abuse, misuse, pest infestations, accident, fire, floods, or other acts of nature or God; damage caused by use of equipment, utilities, services, parts, supplies, accessories, applications, installations, repairs, external wiring or connectors not supplied or authorized by SAMSUNG; damage caused by incorrect electrical line current, voltage, fluctuations and surges; damage caused by failure to operate and maintain the product according to instructions; in-home instruction on how to use your product; and service to correct installation not in accordance with electrical or plumbing codes or correction of household electrical or plumbing (i.e., house wiring, fuses, or water inlet hoses). The cost of repair or replacement under these excluded circumstances shall be the customer's responsibility.

Visits by an authorized servicer to explain product functions, maintenance or installation are not covered by this limited warranty. Please contact SAMSUNG at the number below for assistance with any of these issues.

EXCLUSION OF IMPLIED WARRANTIES

IMPLIED WARRANTIES, INCLUDING THE IMPLIED WARRANTIES OF MERCHANTABILITY OR FITNESS FOR A PARTICULAR PURPOSE, ARE LIMITED TO ONE YEAR OR THE SHORTEST PERIOD ALLOWED BY LAW.

Some states do not allow limitations on how long an implied warranty lasts, so the above limitations or exclusions may not apply to you. This warranty gives you specific rights, and you may also have other rights, which vary from state to state.

LIMITATION OF REMEDIES

YOUR SOLE AND EXCLUSIVE REMEDY IS PRODUCT REPAIR, PRODUCT REPLACEMENT, OR REFUND OF THE PURCHASE PRICE AT SAMSUNG'S OPTION, AS PROVIDED IN THIS LIMITED WARRANTY. SAMSUNG SHALL NOT BE LIABLE FOR SPECIAL, INCIDENTAL OR CONSEQUENTIAL DAMAGES, INCLUDING BUT NOT LIMITED TO TIME AWAY FROM WORK, HOTELS AND/OR RESTAURANT MEALS, REMODELING EXPENSES, LOSS OF REVENUE OR PROFITS, FAILURE TO REALIZE SAVINGS OR OTHER BENEFITS REGARDLESS OF THE LEGAL THEORY ON WHICH THE CLAIM IS BASED, AND EVEN IF SAMSUNG HAS BEEN ADVISED OF THE POSSIBILITY OF SUCH DAMAGES. Some states do not allow exclusion or limitation of incidental or consequential damages, so the above limitations or exclusions may not apply to you. This warranty gives you specific rights, and you may also have other rights, which vary from state to state.

SAMSUNG does not warrant uninterrupted or error-free operation of the product. No warranty or guarantee given by any other person, firm, or corporation with respect to this product shall be binding on SAMSUNG.

To obtain warranty service, please contact SAMSUNG at:

Samsung Electronics America, Inc.

85 Challenger Road

Ridgefield Park, NJ 07660

1-800-SAMSUNG (726-7864)

www.samsung.com/us/support

Memo

Memo

SAMSUNG



Scan the QR code* or visit
www.samsung.com/spsn
to view our helpful
How-to Videos and Live Shows

*Requires reader to be installed on your smartphone

Scan this with your smartphone

QUESTIONS OR COMMENTS?

COUNTRY	CALL	OR VISIT US ONLINE AT
U.S.A	1-800-SAMSUNG (726-7864)	www.samsung.com/us/support



DC68-04067C-01