



WF42H5200A*

WF42H5100A*

Washing Machine user manual

Imagine the possibilities

Thank you for purchasing this Samsung product.

SAMSUNG

contents

INSTALLING YOUR WASHER

11

- 11 Unpacking your washer
- 11 Overview of your washer
- 12 Electrical
- 12 Grounding
- 12 Water
- 13 Drain facility
- 13 Flooring
- 13 Location considerations
- 13 Alcove or closet installation
- 13 Undercounter installation (washer only)
- 14 With optional pedestal base or stacking kit
- 15 Important note to installer
- 15 Installation flow chart



OPERATING INSTRUCTIONS

19

- 19 Loading your washer
- 19 Washing clothes: Basic Instructions

WASHING A LOAD OF LAUNDRY

20

- 20 Overview of the control panel
- 22 **Child Lock** 
- 23 Garment+ 
- 23 Delay End
- 23 My Cycle
- 23 Sound
- 24 Smart Care
- 25 Washing clothes using the cycle selector
- 26 Using steam wash
- 26 ATC (Auto Temperature Control)
- 27 Detergent use
- 27 Features

MAINTAINING YOUR WASHER

29

- 29 Cleaning the exterior
- 29 Cleaning the interior
- 29 Cleaning the dispensers
- 29 Storing your washer
- 30 Cleaning the debris filter
- 31 Cleaning the door Diaphragm
- 31 Preserving the top cover and the front frame
- 32 Self Clean+

TROUBLESHOOTING

33

- 33 Check these solutions if your washer...
- 35 Information codes

APPENDIX

37

- 37 Fabric care chart
- 38 Cycle chart
- 40 Helping the environment
- 40 Declaration of conformity
- 40 Specification

safety information











Congratulations on your new Samsung washer. This manual contains important information on the installation, use, and care of your appliance. Please take time to read this manual to take full advantage of your washer's many benefits and features.

WHAT YOU NEED TO KNOW ABOUT SAFETY INSTRUCTIONS

Warnings and Important Safety Instructions in this manual do not cover all possible conditions and situations that may occur. It is your responsibility to use common sense, caution, and care when installing, maintaining, and operating your washer.

IMPORTANT SAFETY SYMBOLS AND PRECAUTIONS

What the icons and signs in this user manual mean:

 WARNING	Hazards or unsafe practices that may result in severe personal injury or death . To reduce the risk of fire, explosion, electric shock, or personal injury when using your washer, follow these basic safety precautions:
 CAUTION	Hazards or unsafe practices that may result in minor personal injury or property damage .
	Do NOT attempt.
	Do NOT disassemble.
	Do NOT touch.
	Follow directions explicitly.
	Unplug the power plug from the wall socket.
	Make sure the machine is grounded to prevent electric shock.
	Call the service center for help.
	Note

These warning signs are here to prevent injury to you and others.

Please follow them explicitly.

After reading this section, keep it in a safe place for future reference.

-  Read all instructions before using the appliance.

SAVE THESE INSTRUCTIONS

safety information

CALIFORNIA PROPOSITION 65 WARNING

WARNING:

Cancer and Reproductive Harm - www.P65Warnings.ca.gov.

Important safety precautions

 **WARNING:** To reduce the risk of fire, electric shock, or injury to persons when using your appliance, follow basic precautions, including the following:

1. Read all instructions before using the appliance.
2. Do not wash or dry articles that have been previously cleaned in, washed in, soaked in, or spotted with gasoline, dry-cleaning solvents, other flammable or explosive substances as they give off vapors that could ignite or explode.
3. Do not allow children to play on or in the appliance. Close supervision of children is necessary when the appliance is used near children.
4. Before the appliance is removed from service or discarded, remove the door to the washing or drying compartment.
5. Do not reach into the appliance if the drum is moving.
6. Do not install or store this appliance where it will be exposed to the weather.
7. Do not tamper with controls.
8. Do not repair or replace any part of the appliance or attempt any servicing unless specifically recommended in the user-maintenance instructions or in published user-repair instructions that you understand and have the skills to carry out.
9. Do not add gasoline, dry-cleaning solvents, or other flammable or explosive substances to the wash water. These substances give off vapors that could ignite or explode.
10. Under certain conditions, hydrogen gas may be produced in a hot water system that has not been used for 2 weeks or more. **HYDROGEN GAS IS EXPLOSIVE.** If the hot water system has not been used for such a period, before using a washer or combination washer-dryer, turn on all hot water faucets and let the water flow from each for several minutes. This will release any accumulated hydrogen gas. As the gas is flammable, do not smoke or use an open flame during this time.

SAVE THESE INSTRUCTIONS



SEVERE WARNING SIGNS FOR INSTALLATION



Plug the power cord into an AC 120 V / 60 Hz / 10 A wall socket or higher and use the socket for this appliance only. In addition, do not use an extension cord.

- Sharing a wall socket with other appliances using a power strip or extending the power cord may result in electric shock or fire.
- Do not use an electric transformer. It may result in electric shock or fire.
- Ensure that the power voltage, frequency and current are the same as those of the product specifications. Failing to do so may result in electric shock or fire.

The installation of this appliance must be performed by a qualified technician or service company.

- Failing to do so may result in electric shock, fire, an explosion, problems with the product, or injury.

Remove all foreign substances such as dust or water from the power plug terminals and contact points using a dry cloth on a regular basis.

- Unplug the power plug and clean it with a dry cloth.
- Failing to do so may result in electric shock or fire.

Plug the power plug into the wall socket in the right direction so that the cord runs towards the floor.

- If you plug the power plug into the socket in the opposite direction, the electric wires within the cable may be damaged and this may result in electric shock or fire.
-



This appliance must be properly grounded.

Do not ground the appliance to a gas pipe, plastic water pipe, or telephone line.

- This may result in electric shock, fire, an explosion, or problems with the product.
 - Never plug the power cord into a socket that is not grounded correctly and make sure that it is in accordance with local and national codes.
-



Do not install this appliance near a heater or inflammable material.

Do not install this appliance in a humid, oily or dusty location, in a location exposed to direct sunlight and water (rain drops).

Do not install this appliance in a location where gas may leak.

- This may result in electric shock or fire.

Plug the power plug into the wall socket firmly. Do not use a damaged power plug, damaged power cord or loose wall socket.

- This may result in electric shock or fire.

Do not pull or excessively bend the power cord.

Do not twist or tie the power cord.

Do not hook the power cord over a metal object, place a heavy object on the power cord, insert the power cord between objects, or push the power cord into the space behind the appliance.

- This may result in electric shock or fire.

Do not pull the power cord when unplugging the power plug.

- Unplug the power plug by holding the plug.
- Failing to do so may result in electric shock or fire.

SAVE THESE INSTRUCTIONS

safety information

-  When the power plug or power cord is damaged, contact your nearest service center.



CAUTION SIGNS FOR INSTALLATION

-  This appliance should be positioned in such a way that it is accessible to the power plug.
- Failing to do so may result in electric shock or fire due to electric leakage.

Install your appliance on a level and hard floor that can support its weight.

- Failing to do so may result in abnormal vibrations, noise, or problems with the product.
-

-  Unplug the power plug when the appliance is not being used for long periods of time or during a thunder/lightning storm.

- Failing to do so may result in electric shock or fire.



SEVERE WARNING SIGNS FOR USING

-  If the appliance is flooded, cut the power immediately and contact your nearest service center.

If the appliance generates a strange noise, a burning smell or smoke, unplug the power plug immediately and contact your nearest service center.

- Failing to do so may result in electric shock or fire.

In the event of a gas leak (such as propane gas, LP gas, etc.), ventilate immediately without touching the power plug. Do not touch the appliance or power cord.

- Do not use a ventilating fan.
- A spark may result in an explosion or fire.

Do not wash items contaminated with gasoline, kerosene, benzene, paint thinner, alcohol or other flammable or explosive substances.

- This may result in electric shock, fire or an explosion.

Do not open the washer door by force while it is operating (high-temperature washing/drying/spinning).

- Water flowing out of the washer may result in burns or cause the floor to be slippery. This may result in injury.
- Opening the door by force may result in damage to the product or injury.

Make sure to remove the packaging (sponge, styrofoam) attached to the bottom of the washer before using it.

Do not insert your hand under the washer.

- This may result in injury.

SAVE THESE INSTRUCTIONS



Do not touch the power plug with wet hands.

- This may result in electric shock.

Do not turn the appliance off by unplugging the power plug while an operation is in progress.

- Plugging the power plug into the wall socket again may cause a spark and result in electric shock or fire.

Keep all packaging materials well out of the reach of children, as packaging materials can be dangerous to children.

- If a child places a bag over their head, they may result in suffocation.

Do not let children or infirm persons use this washer unsupervised.

- Failing to do so may result in electric shock, burns or injury.

Do not insert your hand or a metal object under the washer while it is operating.

- This may result in injury.

Make sure the detergent drawer is closed before you put laundry into the washer or remove laundry from the washer.

- If the detergent drawer is open, you could strike the drawer with your head and injure yourself.



Do not attempt to repair, disassemble, or modify the appliance yourself.

- Do not use any fuse (such as cooper, steel wire, etc.) other than the standard fuse.
- When repairing or reinstalling the appliance is required, contact your nearest service center.
- Failing to do so may result in electric shock, fire, problems with the product, or injury.



If any foreign substance such as water has entered the appliance, unplug the power plug and contact your nearest service center.

- Failing to do so may result in electric shock or fire.

When the water supply hose comes loose from the faucet and floods the appliance, unplug the power plug.

- Failing to do so may result in electric shock or fire.

If any foreign substance enters the appliance, unplug the power plug and contact you nearest service center.

- Failing to do so may result in electric shock or fire.

SAVE THESE INSTRUCTIONS

safety information



CAUTION SIGNS FOR USING



When the washer is contaminated by a foreign substance such as detergent, dirt, food waste, etc., unplug the power plug and clean the washer using a damp and soft cloth.

- Failing to do so may result in discoloration, deformation, damage or rust.

The front glass may be broken by a strong impact. Take care when using the washer.

- When the glass is broken, it may result in injury.

After a water supply failure or when reconnecting the water supply hose, open the faucet slowly.

Open the faucet slowly after a long period of non-use.

- The air pressure in the water supply hose or the water pipe may result in damage to a part or in water leakage.

If a drain error occurs during an operation, check if there is a draining problem.

- If the washer is used when it is flooded because of a draining problem, it may result in electric shock or fire due to electric leakage.

Insert the laundry into the washer completely so that laundry does not get caught in the door.

- If laundry gets caught in the door, it may result in damage to the laundry or the washer, or result in water leakage.

Ensure that the faucet is turned off when the washer is not being used.

- Ensure that the screw on the water supply hose connector is properly tightened.
- Failing to do so may result in property damage or injury.

Take care that the Rubber Seal and the Front Door Glass are not contaminated by a foreign substance (e.g. waste, thread, hair, etc.).

- If a foreign substance is caught in the door or the door is not completely closed, it may cause a water leakage.

Open the faucet and check if the water supply hose connector is firmly tightened and that there is no water leaking before using the product.

- If the screws or the water supply hose connector are loose, it may result in water leak.

The product you have purchased is designed for domestic use only.

The use for business purposes qualifies as product misuse. In this case, the product will not be covered by the standard warranty provided by Samsung and no responsibility can be attributed to Samsung for malfunctions or damages resulting from such misuse.

If the wash is not started and the laundry is left for a period of time after you have added detergent or applied stain remover or pre-treatment onto the laundry, the laundry may be discolored.

Select the recommended cycle and temperature on the basis of the laundry items, sort the laundry by color on the basis of its colorfastness and select the appropriate cycle.

Make sure that foreign objects such as pins, buttons and coins are removed from clothing items when adding laundry to the washer. Wash dirty laundry separately from relatively clean items and wash fragile items separately from tougher textiles.

If an item is stained, wash it as soon as possible. Use stain remover or detergent only after testing the colorfastness of the item by applying a small quantity to an inside seam.

SAVE THESE INSTRUCTIONS



Do not stand on top of the appliance or place objects (such as laundry, lighted candles, lighted cigarettes, dishes, chemicals, metal objects, etc.) on the appliance.

- This may result in electric shock, fire, problems with the product, or injury.

Do not operate the appliance with wet hands.

- This may result in electric shock.

Do not spray volatile material such as insecticide onto the surface of the appliance.

- As well as being harmful to humans, it may also result in electric shock, fire or problems with the product.

Do not place an object that generates an electromagnetic field near the washer.

- This may result in injury due to a malfunction.

Since the water drained during a high-temperature wash or drying cycle is hot, do not touch the water.

- This may result in burns or injury.

Do not wash, spin or dry water-proof seats, mats or clothing (*).

- Do not wash thick, hard mats even if the washer mark is on the care label.
- This may result in injury or damage to the washer, walls, floor or clothing due to abnormal vibrations.

* Woolen Bedding, rain covers, fishing vests, ski pants, sleeping bags, diaper covers, sweat suits, and bicycle, motor cycle, car covers, etc.

Do not operate the washer when the detergent box is removed.

- This may result in electric shock or injury due to water leakage.

Do not touch the inside of the tub during or just after drying as it is hot.

- This may result in burns.

Do not insert your hand into the detergent dispenser after opening it.

- This may result in injury as your hand may be caught.

Do not place any objects (such as shoes, food waste, animals) other than laundry into the washer.

- This may result in damage to the washer, or injury and death in the case of pets due to the abnormal vibrations.

Do not press the buttons using sharp objects such as pins, knives, fingernails, etc.

- This may result in electric shock or injury.

Do not wash laundry contaminated by oils, creams or lotions usually found in skincare shops or massage clinics.

- This may result in the rubber seal becoming deformed and water leakage.

Do not leave metal objects such as a safety pin or hair pin, or bleach in the tub for long periods of time.

- This may cause the tub to rust.
- If rust starts appearing on the surface of the tub, apply a cleansing agent (neutral) to the surface and use a sponge to clean it. Never use a metal brush.

SAVE THESE INSTRUCTIONS

safety information

Do not use dry cleaning detergent directly and do not wash, rinse, or spin laundry contaminated by dry cleaning detergent.

- This may result in spontaneous combustion or ignition due to the heat of the oxidation of the oil.

Do not use hot water from water cooling/heating devices.

- This may result in problems with the washer.

Do not use natural hand-washing soap for the washer.

- If it hardens and accumulates inside the washer, it may result in problems with the product, discoloration, rust or bad odors.

Do not wash large laundry items such as Bedding in the washing net.

- Failing to do so may result in injury due to abnormal vibrations.
- Place smaller items, such as lace socks and lingerie in the washing net.

Do not use hardened detergent.

- If it accumulates inside the washer, it may result in water leakage.

Do not wash throw rugs or doormats.

- If you wash throw rugs or doormats, the sand will accumulate inside the washer. It may result in error such as no draining.

Take care that children's fingers are not caught in the door when closing it. This may result in injury.



SEVERE WARNING SIGNS FOR CLEANING



Do not clean the appliance by spraying water directly onto it.

Do not use the strong acid cleaning agent.

Do not use benzene, thinner or alcohol to clean the appliance.

- This may result in discoloration, deformation, damage, electric shock or fire.

Before cleaning or performing maintenance, unplug the appliance from the wall socket.

- Failing to do so may result in electric shock or fire.

SAVE THESE INSTRUCTIONS

installing your washer

UNPACKING YOUR WASHER

Unpack your washer and inspect it for shipping damage. Make sure you have received all the items shown below. If your washer was damaged during shipping, or you do not have all of the items, contact 1-800-SAMSUNG (726-7864).

To prevent personal injury or strain, wear protective gloves whenever lifting or carrying the unit.



Packing materials can be dangerous to children. Keep all packing material (plastic bags, polystyrene, etc.) well out of the reach of children.



Certain internal parts are intentionally not grounded and may present a risk electric shock only during servicing. Service personnel – Do not contact the following parts while the appliance is energized: Control board, heat sink, motor, inlet valve and pump.

OVERVIEW OF YOUR WASHER

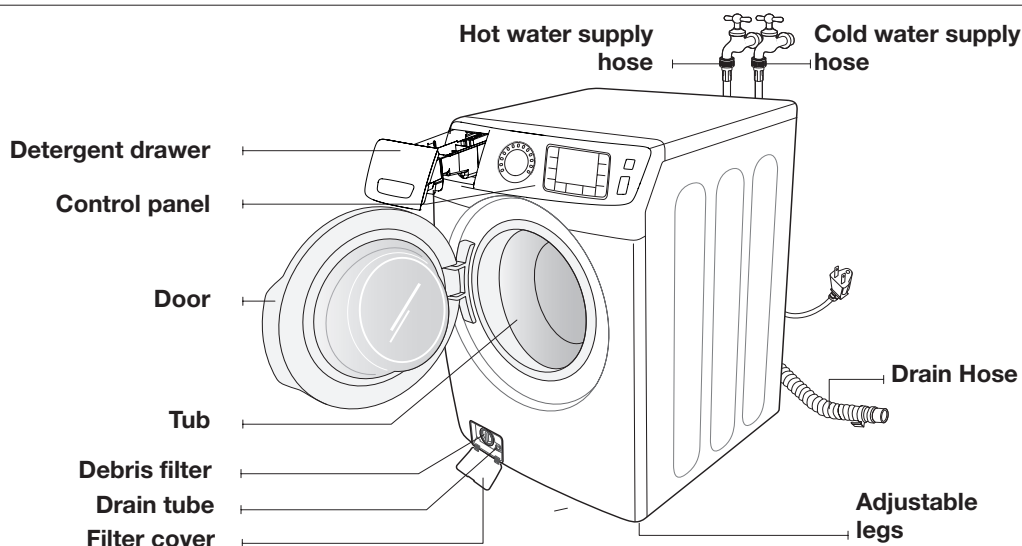

Parts supplied



Bolt Hole Covers



Hose Guide



Plastic Zip Hose Tie

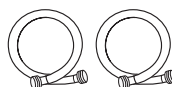

Water Supply Hoses

Tools needed for installation



Philips screwdriver



Level



Adjustable Plier

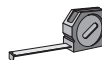

Measuring tape

Parts needed (Sold separately)



anti-slip pads



Wrench



- If you lose an accessory and want to purchase a replacement, contact the Samsung service center (1-800-SAMSUNG(1-800-726-7864)).
- The design of the parts and accessories may differ from the pictures above. Their design is subject to change without notice for product improvement.
- Do not reuse old hoses. Only use new water supply hoses when you install the washing machine. Old water supply hoses can leak or burst causing flooding and property damage.
- Confirm that there are rubber washers inside each coupling of the water supply hoses.



* Bolt hole covers : The number of bolt hole covers depends on the model (3~6 covers).

installing your washer

BASIC LOCATION REQUIREMENTS

Electrical

- 120 Volt 60 Hz 10 AMP fuse or circuit breaker
- Individual branch circuit serving only your washer is recommended.
- Your washer is equipped with a power cord.



NEVER USE AN EXTENSION CORD.

Grounding

ELECTRICAL GROUNDING IS REQUIRED FOR THIS APPLIANCE.

This appliance must be grounded. In the event of malfunction or breakdown, grounding will reduce the risk of electric shock by providing a path of least resistance for electric current.

This appliance is equipped with a power cord having a three-prong grounding plug for use in a properly installed and grounded three-prong outlet.

The plug must be plugged into an appropriate outlet that is properly installed and grounded in accordance with all local codes and ordinances.



An improperly connected equipment-grounding conductor can increase the risk of electrical shock. Check with a qualified electrician or serviceman if you are not sure whether the appliance is properly grounded. Do not modify the plug provided with the appliance – if it does not fit the outlet, have a proper outlet installed by a qualified electrician.

IMPORTANT SAFETY PRECAUTIONS

- To prevent unnecessary risk of fire, electrical shock or personal injury, all wiring and grounding must be done in accordance with the National Electrical Code ANSI/FNPA, No. 70 Latest Revision and local codes and ordinances. It is the personal responsibility of the appliance owner to provide adequate electrical service for this appliance.



NEVER CONNECT THE GROUND WIRE TO PLASTIC PLUMBING LINES, GAS LINES, OR HOT WATER PIPES.

Water

Using bad quality water may cause the water supply valve to operate abnormally.

To correctly fill your washer in the proper amount of time, water pressure of 20-116 psi (137-800 kPa) is required.

Water pressure less than 20 psi may cause water valve failure, may not allow the water valve to shut off completely, or may extend the fill time beyond what your washer controls allow, causing your washer to turn off. A time limit is built into the controls to prevent extensive flooding in your home if an internal hose becomes loose.

The water faucets must be within 4 feet / 122 cm of the back of your washer to match the inlet hoses provided with your washer.



Accessory inlet hoses are available in various lengths up to 10 feet/305 cm for faucets that are further away from the back of your washer.

To avoid the possibility of water damage:

- Have water faucets easily accessible.
- Turn off faucets when the washer is not in use.
- Periodically check that there is no leakage from the water inlet hose fittings.



CHECK ALL CONNECTIONS AT THE WATER VALVE AND FAUCET FOR LEAKS.

Drain facility

The recommended height of the standpipe is 18 in/46 cm. The drain hose must be routed through the drain hose clip to the standpipe. The standpipe must be large enough to accept the outside diameter of the drain hose. The drain hose is attached at the factory.

Flooring

For best performance, you must install your washer on a solidly constructed floor. Wood floors may need to be reinforced to minimize vibration and/or unbalanced load situations. Carpeting and soft tile surfaces are contributing factors to vibration which can cause your washer to move slightly during the spin cycle.

Never install your washer on a platform or weakly supported structure.

Location considerations

Do not install your washer in areas where water may freeze, since your washer will always retain some water in its water valve, pump, and hose areas. Freezing water can damage the belts, the pump, hoses and other components.

Alcove or closet installation

MINIMUM CLEARANCES FOR CLOSET AND ALCOVE INSTALLATIONS:

Sides – 1 in / 25 mm

Top – 17 in / 432 mm

Rear – 5.9 in / 150 mm

Closet Front – 2 in / 51 mm

If the washer and dryer are installed together, the closet front must have at least a 72 in² (465 cm²) unobstructed air opening. Your washer alone does not require a specific air opening.

A. Recessed area

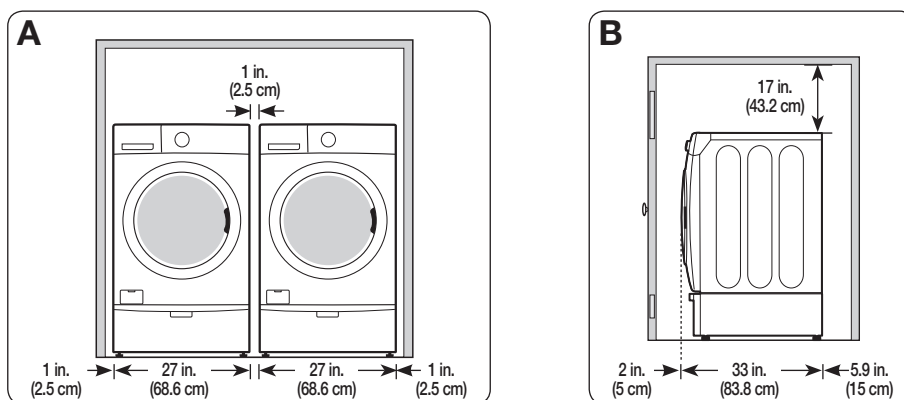

B. Side view - closet or confined area

Undercounter installation (washer only)

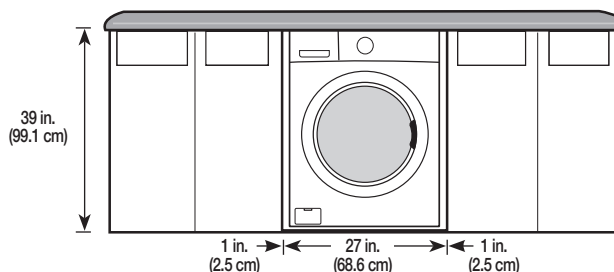

installing your washer

With optional pedestal base or stacking kit

Required Dimensions for Installation With Pedestal (Model No : WE357*)

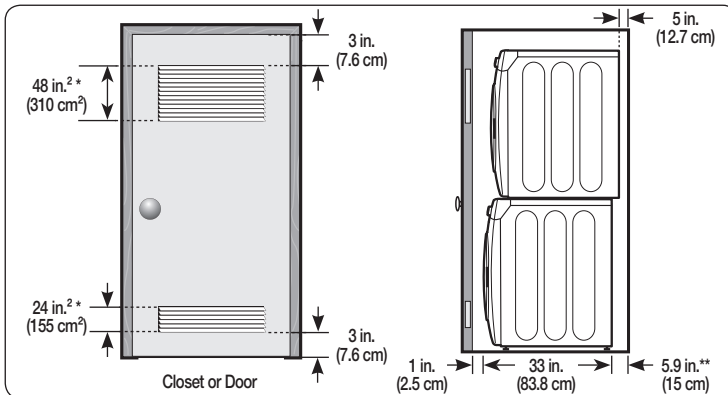
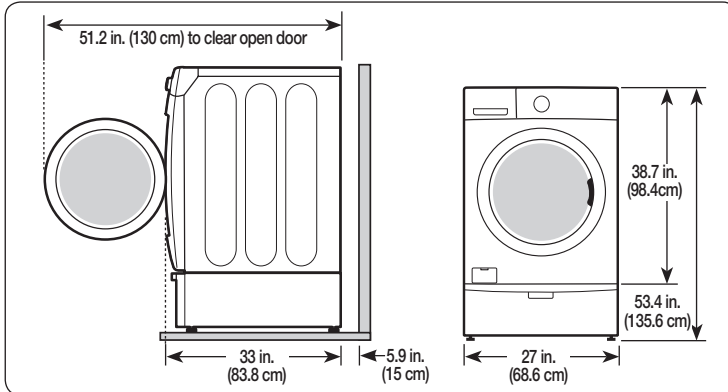

Required Dimensions for Installation With Stacking Kit (Model No : SK-5A)

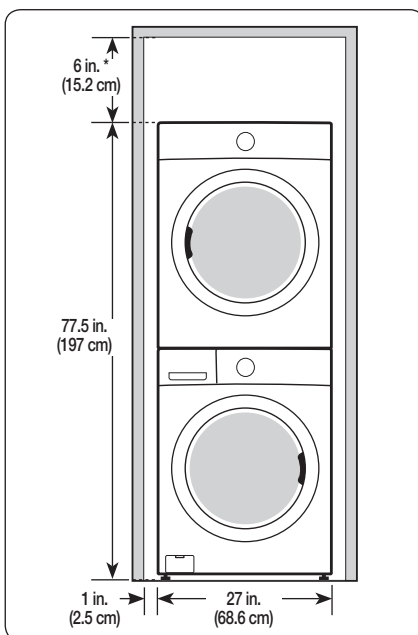

* Required spacing

** External exhaust elbow requires additional space.

IMPORTANT NOTE TO INSTALLER

Please read the following instructions carefully before installing the washer.

These instructions should be retained for future reference.

We recommend you hire a professional to install this washer.

Installation flow chart

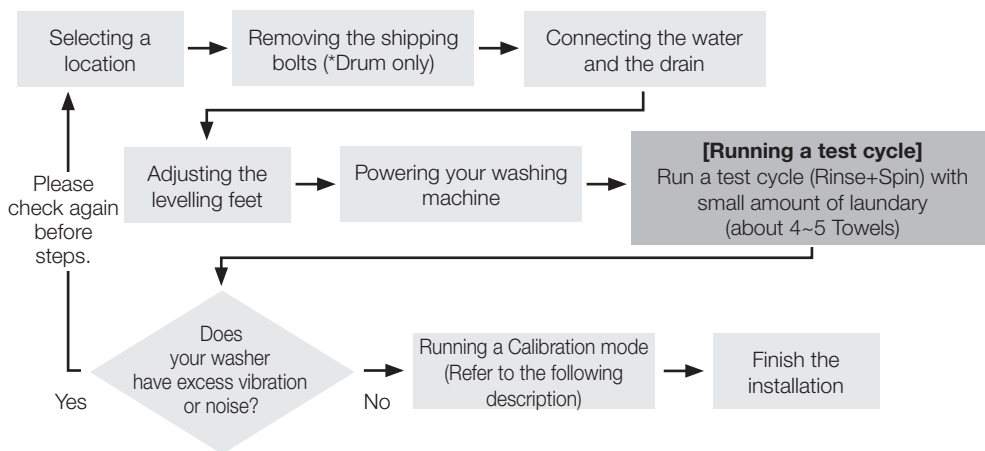

STEP 1 Removing the Shipping Bolts

Before using your washer, you must remove all shipping bolts from the back of the unit.

1. Loosen all the bolts with the wrench.
2. Slide the bolt and spacer up and remove the bolt with the spacer through the hole in the rear wall of your washer. Repeat for each bolt.
3. Cover the holes with the supplied Bolt Hole Covers (See page 11).
4. Keep the shipping bolts and spacers for future use.

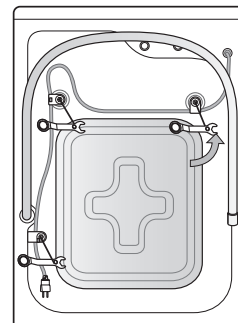

STEP 2 Selecting a Location

 Before you install your washer, make sure the location:

- Has a hard, level surface.
- Is away from direct sunlight.
- Has adequate ventilation.
- Will not freeze (temperatures are never below 32 °F or 0 °C).
- Is away from heat sources such as oil or gas.
- Has enough room for the power cord.
- Doesn't have any carpeting that will obstruct ventilation openings.

installing your washer

STEP 3 Installing your Washer

To connect the water hoses to the faucets:

1. Connect one end of each water hose to the Hot or Cold tap.
2. Turn the fittings by hand until they are tight, and then tighten them by just an additional two-thirds of a turn with a spanner. Do not overtighten the fittings. You can damage them.
3. When done, pull the water hoses up and down to check if they are properly connected.
4. Put the other ends of the hoses into a bucket and open the taps for 10-15 seconds to remove impurities. When done, close the taps.
5. Tighten Coupling by hand until it is snug.
6. Then tighten two-thirds of a turn with pliers.
7. Run water in a bowl or basin to get rid of any debris inside hose. Check for HOT and Cold water supply.
8. Connect one end of the COLD/HOT water supply hoses to the each COLD/HOT water supply intakes at the back of the washer.
9. Tighten Coupling by hand until it is snug.
10. Then tighten two-thirds of a turn with pliers.
11. For proper operation, make sure both Hot & Cold hoses from faucets are connected to the corresponding Hot / Cold water inlets on the washer.



12. Connect the other ends of the water hoses to the corresponding inlets on the rear of the machine as specified. Make sure the hot water hose is connected to the hot inlet, and the cold water hose to the cold inlet.
13. Repeat step 2 above on the other fittings. Make sure both water hoses are connected properly. See the '4E' information code for troubleshooting.
14. Open both faucets, and check if there is a leak.



If you do not want to use the hot water hose, insert the inlet cap into the hot water inlet. In this case, you must select Tap Cold for the water temperature. All other water indicators turn off.



To prevent water hoses from being bent or kinked, make sure there is at least a 6 inch (150 mm) space between the washer and the rear wall.

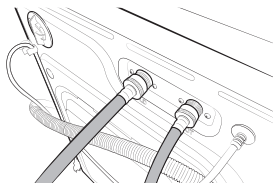
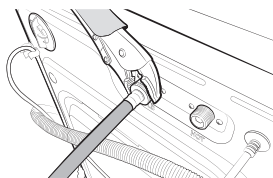
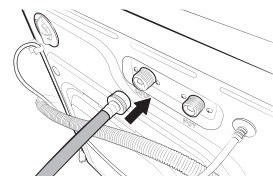

Wall standpipe drain system

1. The drain hose must be placed into a wall standpipe drain system. To keep the end of the drain hose bent, use the supplied hose guide (A). Secure the guide to the wall using a hook to ensure stable drainage.
2. Open the water tap and check if there are any leaks around the connection areas. If there are water leaks, repeat the steps above.

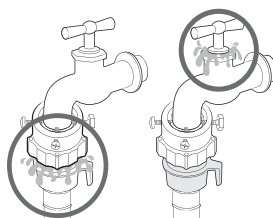
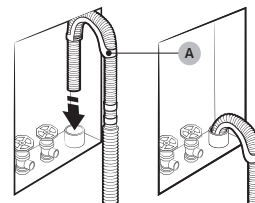

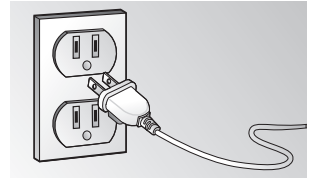

installing your washer

3. Slide your washer into position.
4. Level the washer by manually adjusting the levelling feet.. When your washer is level, tighten the locking nuts using the wrench or (-) flathead screwdriver.
5. Plug the power cord into a 3-Prong, well grounded 120 volt 60 Hz approved electrical outlet protected by a 10-amp fuse or comparable circuit breaker.
Your washer is grounded through the third prong of the power cord when plugged into a three-prong grounded receptacle.

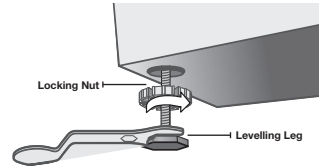

-  Your washer must be leveled on all four sides. A carpenter's level should be used on all four corners of your washer. We recommend you recheck your washer after a dozen or so washes to make sure it's still level.



-  Avoid damage to the legs. Do not move the washer unless the Locking-nuts are fastened to the bottom of the washer.

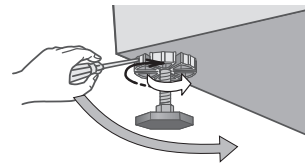

- Test run**
-  Make sure that you install your washing machine correctly by running the **Rinse+Spin** cycle after the installation is complete.

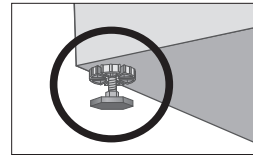
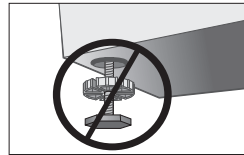

STEP 4 Calibration mode

Your Samsung washing machine automatically detects the weight of the laundry. For more accurate weight detection, please run Calibration Mode after the installation. To run Calibration Mode, follow these steps:

1. Turn on the washer.
2. Press the **Temp.** button and **Delay End** button simultaneously for at least 3 seconds.
3. Remove any contents in the tub and close the door.
4. Press the **Start/Pause** button.
5. The drum rotates clockwise and counterclockwise for approximately 3 minutes.
6. When Calibration Mode is finished, the "En/End" appears on the display and the washing machine turns off automatically. The washing machine is now ready for use.

operating instructions



To reduce the risk of fire, electric shock, or injury to persons, read the IMPORTANT SAFETY INSTRUCTIONS before operating this appliance.

LOADING YOUR WASHER

- Fill the tub with dry, unfolded clothes evenly around in order to enhance washing efficiency and prevent excess wear, or wrinkling of the load.
- Wash delicate items such as bras, hosiery, and other lingerie in the Delicates cycle with similar lightweight items.
- When washing big bulky items or a few smaller items that don't fill the tub completely – a rug, a pillow, stuffed toys, or one or two sweaters, for example – add a few towels to improve tumbling and spin performance.



During the spin cycle, the washer may add additional water to redistribute the clothes and correct an imbalance inside the drum.

- To ensure good cleaning result when washing heavily soiled loads, do not overload your washer.
- When the “” light is ON (see page 23), you can add or remove laundry items during a wash.
 1. Press the **Start/Pause** Button.
 2. Wait for the Door Lock light to go out (5 seconds).
 3. Add the item, close the door, and press the **Start/Pause** Button.
After a 10-second pause, the cycle will resume.



To ensure thorough cleaning, add items within five minutes of starting the wash cycle.

WASHING CLOTHES: BASIC INSTRUCTIONS

1. Press the **Power** button, open the door, and then load the washer.
2. Close the door.



Push the laundry into the drum completely to prevent the laundry from being caught in the door or from falling out of the drum.

3. Add detergent and additives to the dispenser (see pages 27~28).
4. Select the appropriate cycle and options for the load (see pages 20~22).
5. Press the **Start/Pause** Button.



The drum automatically rotates and measures the weight of the laundry without supplying water in order to adjust the wash time. (The rotating display on the display panel indicates that the weight of the laundry is being measured.)

6. The Wash Indicator light will illuminate.
7. The estimated cycle time will appear in the display.
The time may fluctuate to indicate the time remaining in the cycle better.



The actual time required for a cycle may differ from the estimated time in the display depending on the water pressure, water temperature, detergent, and laundry.

8. Before your washer starts to fill, it will make a series of clicking noises to check the door lock and do a quick drain.



- When the cycle is complete, the Door Lock light will go out and “End” will appear in the display.
- DO NOT attempt to open the door until the Door Lock light is off. To add a forgotten item, see the “Loading your Washer” section above.
- When your washer is restarted after a pause, expect a delay of up to 15 seconds before the cycle continues.
- Pressing the **Power** button cancels the cycle and stops your washer.
- The Wash, Rinse, and Spin indicator lights will illuminate during those portions of the cycle.



Do not place anything on top of your washer while it is running.

washing a load of laundry

OVERVIEW OF THE CONTROL PANEL

WF42H5200A*

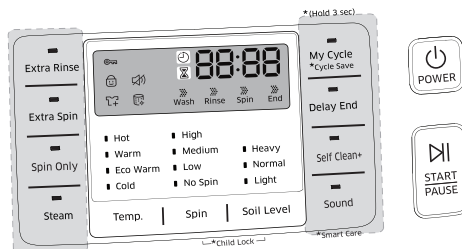
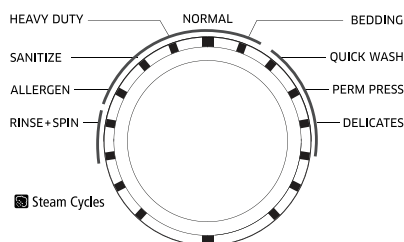

WF42H5100A*

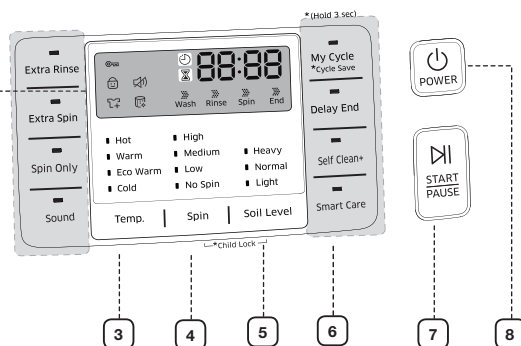
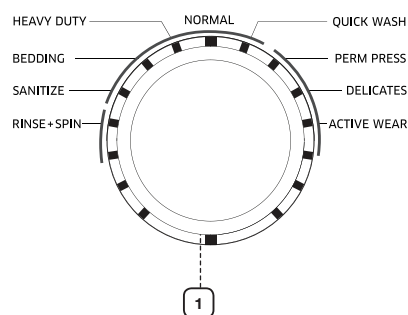

1 Cycle Selector

Select the appropriate cycle for the type of load.

This will determine the tumble pattern and spin speed for the cycle.



To minimize wrinkling of laundry, select the Perm Press cycle.

NORMAL - For most fabrics including cottons, linens, and normally soiled garments.

HEAVY DUTY - For sturdy, colorfast fabrics and heavily soiled garments.

SANITIZE - For heavily soiled, colorfast garments. This cycle heats the water to 150 °F to eliminate bacteria.



If you select pause during the heating portion of the Sanitize Cycle, your Washer door will remain locked for your safety.

ALLERGEN - This course is applied to remove dust mites, pet dander or other allergic substances of the fabric. (Only for WF42H5200A*models)

RINSE + SPIN - Use for loads that need rinsing only or to add rinse-added fabric softener to a load.

BEDDING - For bulky items such as blankets, comforters and sheets. When you are washing bulky items, use liquid detergent.

QUICK WASH - For lightly soiled garments needed quickly.

PERM PRESS - For wash-and-wear, synthetic fabrics, and lightly to normally soiled garments.

DELICATES - For sheer fabrics, bras, lingerie silk, and other handwash only fabrics. For best results, use liquid detergent.

ACTIVE WEAR - Use this cycle to wash exercise wear such as sports jerseys, training pants, shirts/tops and other performance clothing. This cycle provides effective soil removal with gentle action for special fabric care. (Only for WF42H5100A*models)

2 Digital display	The large Digital Display is easy to use. It provides instructions and diagnostics while keeping you updated on the cycle status and time remaining.
3 Temperature selection button	<p>Press the button repeatedly to cycle through the different water temperature options.</p> <p>Hot - Whites and heavily soiled, colorfast items.</p> <p>Warm - Colorfast items. When warm rinse is selected, only the final rinse will be warm.</p> <p>The other rinses will be cold to conserve energy.</p> <p>Eco Warm - Moderately soiled, colorfast items; most wrinkle-free items.</p> <p>Cold - Brightly colored, very lightly soiled items.</p>
4 Spin selection button	<p>Press the button repeatedly to cycle through the different spin speed options. (Rins hold (All Lamp Turn Off) → No Spin → Low → Medium → High)</p> <p> To minimize wrinkling of wrinkle free and no iron fabrics, DO NOT use overload your Washer.</p> <p>High - Use for underwear, t-shirts, jeans and sturdy cottons.</p> <p>Medium - Use for jeans, wrinkle-free or wash-and-wear items and synthetics.</p> <p>Low - Use for delicate items needing a slow spin speed.</p> <p>No Spin - Drains your Washer without spinning. Use for extremely delicate items that cannot tolerate any spin.</p> <p>Rinse Hold (All Lamp Turn Off) - The laundry remains soaking in the final rinse water. Either a drain or spin cycle must be performed to unload the laundry.</p>
5 Soil Level selection button	<p>Press the button to select the soil level/washing time. (Light → Normal → Heavy)</p> <p>Heavy - For heavily soiled loads.</p> <p>Normal - For moderately soiled loads. This setting is best for most loads.</p> <p>Light - For lightly soiled loads.</p>
6 Select Cycle Option	<p>Press these buttons to select different cycle options.</p> <p>Extra Rinse - Add an additional rinse at the end of the cycle to remove laundry additives and perfumes more thoroughly.</p> <p>Extra Spin - Add additional time to remove more water from loads.</p> <p>Spin Only - The option to start only Spin of each course.</p> <p>Steam - Press this button to use the Steam Wash function. Steam Wash is available with the Normal, Heavy Duty, Bedding, Sanitize and Allergen cycles. For heavily soiled, colorfast garments, Steam Wash improves stain treatment and uses less water (See page 26). (Only for WF42H5200A* models.)</p> <p>Sound - When you activate the Sound off function, the “Sound [🔊]” lamp illuminates.</p> <p>My Cycle - Choose your favorite cycle including temperature, spin, soil level, options, etc. (see page 23)</p> <p>Delay End - Any cycle can be delayed for up to 24 hours in one-hour increments. Displayed hour indicates the time at which the wash will be ended. (See page 23).</p> <p>Self Clean+ - Use to clean dirt and possible mold from the drum. Regular use (after every 40 washes) is recommended. No detergent or bleach is needed (see page 32).</p> <p>Smart Care - This function enables you to check the status of the washing machine using a smartphone.</p>
7 Start/Pause selection button	Press to pause and restart programs.
8 Power button	Press once to turn your washer on, press again to turn your washer off. If the washer is left on for more than 10 minutes without any buttons being touched, the power automatically turns off.

washing a load of laundry



Child Lock

Child Lock prevents children from playing with your washer.

Once you have activated the Child Lock function, the control panel cannot be activated, preventing children from playing with the washer.

Activating the Child Lock function

Press and hold both the **Soil Level** and **Spin** buttons simultaneously for 3 seconds.

- When you activate the Child Lock function, the door locks and the “Child Lock ” lamp illuminates.
- If you press the **START/PAUSE** button after you have activated the Child Lock function, none of the buttons will work except for the **POWER** button.
- If you press a button when the buttons are locked, the “Child Lock ” lamp blinks.

Pausing the Child Lock function

When the door is locked or the buttons are locked by the Child Lock function, you can pause the Child Lock operation for 1 minute by pressing and holding both the **Soil Level** and **Spin** buttons simultaneously for approximately 3 seconds.

- If you pause the Child Lock mode temporarily, the door lock is released for 1 minute for user convenience. During this period, the “Child Lock ” lamp blinks.
- If you open the door after the minute is over, an alarm sounds for up to 2 minutes.
- If you close the door within the 2 minutes, the door is locked and the Child Lock function is reactivated. If you close the door after the 2 minutes, the door is not locked automatically and no alarm sounds.

Deactivating the Child Lock function

Press and hold both the **Soil Level** and **Spin** buttons simultaneously for approximately 6 seconds.

- When you deactivate the Child Lock function, the door is unlocked and the “Child Lock ” is turned off.



- The Child Lock function prevents children or the infirm from accidentally operating the washer and injuring themselves.
- If a child enters the washing machine, the child may become trapped and suffocate.
- Once you have activated the Child Lock function, it continues working even if the power is turned off.
- Opening the door by force can result in injury due to damage to the product.



To add laundry after you have activated the Child Lock function, you must first pause or deactivate the Child Lock function.



If you want to open the door of the washing machine when the Child Lock function is activated:

- Pause or deactivate the Child Lock function.
- Turn the washing machine off and then on again.

Garment+

You can add or take out laundry items even after the wash has started, as long as the “” light is on. Pushing the **START/PAUSE** button unlocks the door, unless the water is too hot or if there is too much water in your washer. If you are able to unlock the door and wish to continue the wash cycle, close the door, and then press the **START/PAUSE** button.

Delay End



You can set the washing machine to start your wash automatically at a later time, choosing a delay time. The hour displayed indicates the time at which the wash will be ended.

1. Set your wash cycles.
2. Press the **Delay End** button repeatedly until the delay time is set.
3. Press the **START/PAUSE** button. The “**Delay End** ” indicator will be lit, and the clock will begin counting down until it reaches the set time.
4. To cancel a Delay End function, press the **POWER** button and then turn the washing machine on again.

My Cycle

Lets you save a custom wash cycle (temperature, spin, soil level, etc.) and then recall and use it with one button convenience.

To save a cycle and selected options as your My Cycle, follow these steps:

1. Select the cycle using the **Cycle Selector** dial.
 2. After cycle selection, set each option.
-  See page 38–39 for available option settings with each cycle.
3. You can then store the selected cycle and options by pressing and holding the **My Cycle** button for longer than 3 seconds. The cycle and options you select will be displayed the next time you choose the My Cycle function.
 4. Press the My Cycle button to load and use the saved My Cycle options. The “My Cycle” light will indicate activation. Also, the chosen course and option lights will flicker
-  You can change the “**My Cycle**” settings by repeating the process above. The washer displays the last settings used the next time you choose “**My Cycle**”.
-  If you press My Cycle and release it within 3 seconds, the previously saved cycles and options appear. If you press and hold My Cycle for 3 second or longer, the currently set cycles and options are saved and the LED blinks for 3 seconds.

Sound

The Sound Off function can be selected during all courses.

washing a load of laundry

Smart Care

This function enables you to check the status of the washing machine using a smartphone.

1. To enable the Smart Care function

1) WF42H5200A*

press and hold the **Sound** button for 3 seconds within 10 seconds after turning the power on by pressing the Power button.

2) WF42H5100A* model

Press **Smart Care** button to use.

2. If the Smart Care function is activated, the LED on the window display rotates for 2 or 3 seconds and then the Smart Care indicator is lit on the display.
3. Run the **Smart Care** app on your smart phone.
4. The Smart Care function is optimized with Galaxy and iPhone Series.
5. Focus your smart phone's camera on the display panel of the washing machine.
6. If the smart phone's camera is focused on the display panel of the washing machine, the panel and error message is automatically recognized and the error type and countermeasures are displayed on the smart phone.
7. If the smartphone fails to recognize the error code more than twice, please enter the error code displayed on the display panel of the washer manually into the Smart Care app.

Downloading the Smart Care app

- Download the Samsung Laundry App into your mobile phone from the Android market or Apple App store. **(Search word : Samsung Smart Washer/Dryer)**

 Precautions when using Smart Care

- If a lighting device (e.g. fluorescent or lamp) is reflected on the display panel of the washing machine, the result on the display panel may not be recognized easily.
- If an error occurs more than twice, please manually enter the error code displayed on the display panel of the washing machine into the Smart Care app.
- If the angle of the smartphone camera and the display panel of the washing machine is incorrect, the error may not be recognized properly. Please try to hold the smart phone at an angle to the display panel as shown by the figure.

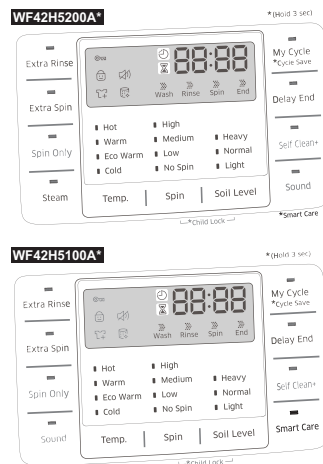

Washing clothes using the cycle selector

Your new washing machine makes washing clothes easy, using Samsung's "Fuzzy Control" automatic control system. When you select a wash program, the machine will set the correct temperature, washing time, and washing speed.

1. Turn on your sink's water tap.
2. Press the Power button.
3. Open the door.
4. Load the articles of clothing one at a time loosely into the drum, without overfilling it.
5. Close the door.
6. Add detergent, softener, and pre-wash detergent (if necessary) into the appropriate compartments.
7. Use the Cycle Selector to select the appropriate cycle according to the type of material: NORMAL, HEAVY DUTY, BEDDING, SANITIZE, ALLERGEN (Only for WF42H5200A* model), RINSE+SPIN, QUICK WASH, PERM PRESS, DELICATES, ACTIVE WEAR (Only for WF42H5100A* models). The relevant indicators will illuminate on the control panel.
8. At this time, you can control the wash temperature, the number of rinse cycles, the spinning speed, and the delay time by pressing the appropriate option button.
9. Press the **Start/Pause** button on the Cycle Selector and the wash will begin. The process indicator will light up and the remaining time for the cycle will appear in the display.

Pause Option

1. Within 5 minutes of starting a wash, it is possible to add/remove laundry items to/from the wash.
2. Press the Start/Pause button to unlock the door.
3. The door cannot be opened when the water is too HOT or the water level is too HIGH.
4. After closing the door, press the Start/Pause button to restart the wash.

When the cycle is finished:

After the total cycle has finished, the power will turn off automatically.

1. Open the door.
2. Remove laundry.

washing a load of laundry

USING STEAM WASH

If you select steam, the steam acts at the most effective times for the detected amount of laundry, maximizing the effect of the steam, increasing the wash temperature, enhancing the Soak effect, and improving wash performance. (Only for WF42H5200A* models)

1. Load the washer.
2. Press the **Power** button.
3. Turn the Cycle Selector and select a **Steam Cycle**. (The Deep Steam course automatically selects Steam.)
4. Press the **Steam** button.
5. Add detergent to the dispenser tray and add fabric softener up to the marked line.
6. Press the **Start/Pause** button.
: The washer automatically selects the optimal wash conditions by sensing the weight of the laundry.

 Steam may not necessarily be visible during the steam cycles. Steam may not be present during the entire steam wash cycle.

ATC (AUTO TEMPERATURE CONTROL)

ATC is the control function that the washer controls water temperature with temperature sensor (thermistor).

 Because there are numerous water temperatures depending on the customer's environments (cold areas, warm areas, various water temperature, settings of heater temperature, etc), ATC function in our washer maintains the certain level of wash temperature to output the best washing performance at each cycle.

 If you select normal & heavy duty cycles, those cycles are the regulation and UL course. Since new washers must reduce the amount of energy usage at first priority, customers will notice more cold water entering the washer. But This is Normal, not a problem.

 In those regulation cycles, Hot temperature is similar to acceptable adult bath-water temperature and warm temperature is similar to comfortable swimming-pool water temperature.
If customers want to wash clothes in specific water temperature, customers should choose a different cycles at each temperature (Hot/Warm/Eco Warm)

DETERGENT USE

Your Washer is designed to use high efficiency (HE) detergents.

- For best cleaning results, use a high efficiency detergents such as Tide HE, Wisk HE, Cheer HE, or Gain HE*. High efficiency detergents contain suds suppressors that reduce or eliminate suds. When fewer suds are produced, the load tumbles more efficiently and cleaning is maximized.



Regular detergent is NOT recommended. Please use HE detergents only.

- ☞ Reducing the amount of detergent may reduce the quality of cleaning. It is important to pre-treat stains, sort carefully by color and soil level, and avoid overloading.

* Brand names are trademarks of their respective manufacturers.

FEATURES

Automatic dispenser

Your washer has separate compartments for dispensing detergent and color-safe bleach, chlorine bleach, and fabric softener. Add all laundry additives to their respective compartments before starting your washer.

The automatic dispenser **MUST ALWAYS** be in place before you start your washer.

DO NOT open the automatic dispenser when your washer is running.

Usage Pointers:

- Never exceed the manufacturer's recommendations when adding detergent.
- This compartment holds liquid detergent for the main wash cycle, which the washer adds to the load at the beginning of the cycle.

- ☞ Before using powdered detergent, remove the Liquid Detergent holder from the compartment. Powdered detergent will not dispense from the Liquid Detergent holder.

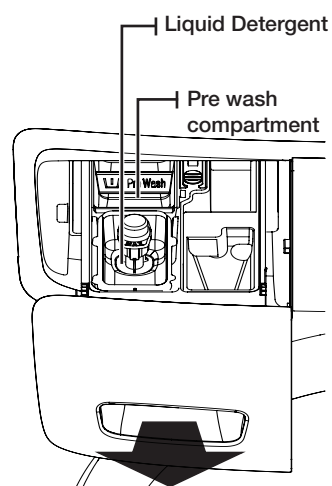

Detergent compartment

- Pour the recommended amount of laundry detergent directly into the detergent compartment before starting your washer.

washing a load of laundry

Bleach compartment

(Liquid chlorine bleach only)

1. Add chlorine bleach to the bleach compartment. DO NOT exceed the MAX FILL line.
2. Avoid splashing or over-filling the compartment.
3. Your washer automatically dispenses bleach into the tub at the appropriate time.
4. The dispenser automatically dilutes liquid chlorine bleach before it reaches the wash load.



- Never pour undiluted liquid chlorine bleach directly onto the load or into the tub. It is a powerful chemical and can cause fabric damage, such as weakening of the fibers or color loss, if not used properly.
- Oxi-type boosters or color-safe bleach can be added to the drum prior to adding laundry.
- Put the laundry into the drum only after confirming that the oxi-type boosters or color-safe bleach has completely entered the hole of the drum.
- To use powdered detergent and powder oxi-type boosters or powdered color-safe bleach at the same time, it is more effective to put them in the drum together before adding the laundry. When you use powdered detergent, remember to remove the Liquid Detergent holder from the detergent compartment.

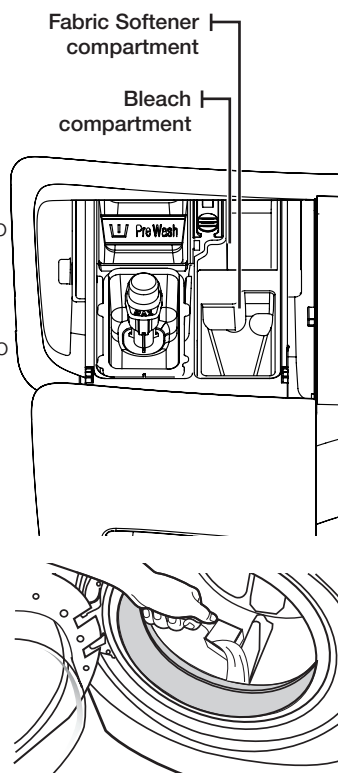

Fabric softener compartment

1. Pour the recommended amount of liquid fabric softener into the softener compartment. For smaller loads, use less than one capful.
2. Dilute the fabric softener with water until it reaches MAX FILL in the compartment.
3. The dispenser automatically releases liquid fabric softener at the proper time during the rinse cycle.



- Use the softener compartment ONLY for liquid fabric softeners.
- DO NOT use a Downy Ball* in the Fabric softener compartment of this washer. It will not be added at the appropriate time. Use the detergent compartment.

* Brand names are trademarks of their respective manufacturers.



If you overfill the detergent, bleach, or softener compartments, the contents of the compartment will automatically be released into the washer. This could damage any garments that are in the drum.

maintaining your washer



Certain internal parts are intentionally not grounded and may present a risk electric shock only during servicing. Service personnel – Do not contact the following parts while the appliance is energized: Control board, heat sink, motor, inlet valve and pump.

CLEANING THE EXTERIOR

Turn off the water faucets after finishing the day's washing.

This will shut off the water supply to your washer and prevent the unlikely possibility of damage from escaping water. Leave the door open to allow the inside of your washer to dry out.

Use a soft cloth to wipe up all detergent, bleach or other spills as they occur.

Clean the following as recommended below:

Control Panel – Clean with a soft, damp cloth. Do not use abrasive powders or cleaning pads. Do not spray cleaners directly on the panel.

Cabinet – Clean with soap and water.

CLEANING THE INTERIOR

Clean the interior of your washer periodically to remove any dirt, soil, odor, mold, mildew, or bacterial residue that may remain in your washer as a result of washing clothes.

Failure to follow these instructions may result in unpleasant conditions, including odors and/or permanent stains on your washer or laundry.

Hard water deposits may be removed, if needed. Use a cleaner labeled "Washer safe".

CLEANING THE DISPENSERS

You may need to clean the automatic dispenser periodically to remove laundry additive buildup.

1. Pull out the Liquid Detergent holder from the detergent compartment.
2. Remove the siphon cap from the fabric softener and bleach compartments.
3. Wash all of the parts under running water.
4. Clean the dispenser recess with a soft brush.
5. Reinsert the siphon cap and push it firmly into place.
6. Push the Liquid Detergent holder back into place.
7. Run a **Rinse+Spin** cycle without any load in your washer.

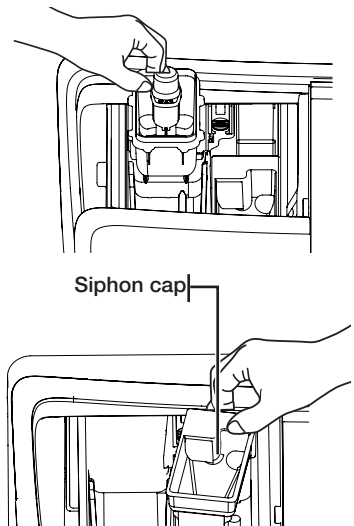

STORING YOUR WASHER

Washers can be damaged if water is not removed from hoses and internal components before storage. Prepare your washer for storage as follows:

- Select the Quick Wash cycle and add bleach to the automatic dispenser. Run your washer through the cycle without a load.
- Turn the water faucets off and disconnect the inlet hoses.
- Unplug your washer from the electrical outlet and leave your washer door open to let air circulate inside the tumbler.
- If you store your washer in below-freezing temperatures, make sure you allow time for any leftover water in your washer to thaw before use.

maintaining your washer

CLEANING THE DEBRIS FILTER

We recommend cleaning the debris filter when water does not drain well or the "5E" error message is displayed.

1. Unplug the washing machine from the power supply.
2. Gently press the top area of the filter cover to open.

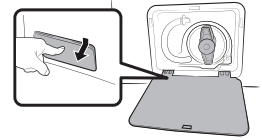

3. Holding the drain cap, pull the drain tube that is hooked on the guide hook to the front. Do not pull the drain tube with excessive force.
4. Place a bowl under the washing machine to catch any remaining water. Then, hold the drain tube with one hand, and turn the drain cap counter clockwise with the other hand to separate it from the drain tube.
5. Drain the remaining water completely.

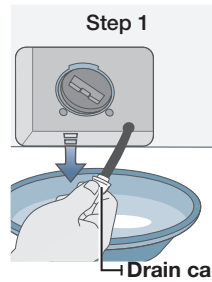

6. Turn the debris cap counterclockwise, and then pull the debris cap and debris filter assembly out of the washer.

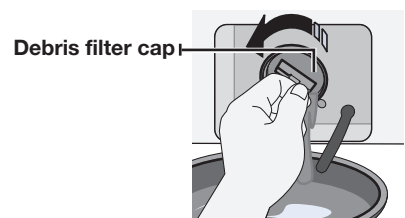

7. Wash any dirt or other material from the debris filter. Make sure the drain pump propeller behind the debris filter is not blocked.

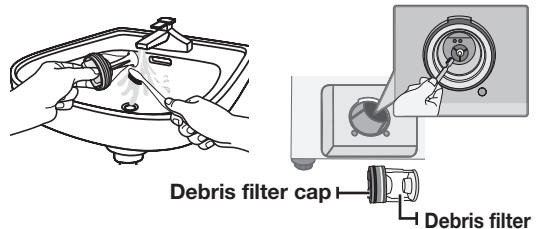

8. When you have finished cleaning the filter, insert the debris cap and filter assembly back into the washer. Turn the debris filter cap clockwise until the indicator on the debris filter cap is in the 12 o'clock position, pointing to the indicator on the washer.
9. Re-attach the emergency drain cap to the drain tube, and then hook the tube to the hook guide.
10. Re-install the filter cover.

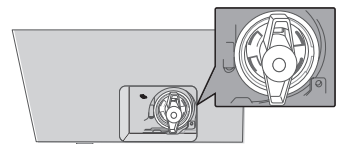

For models with the safety filter cap

- To open, push in, and then turn the safety filter cap counterclockwise. The spring in the cap will make opening the cap easy.
- To close, turn the safety filter cap clockwise. As you turn the cap, the spring will make a rattling sound. The rattling sound is normal.

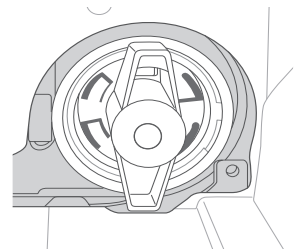

CLEANING THE DOOR DIAPHRAGM

1. Open the washer door and remove any clothing or items from the washer.
2. Check if there are any foreign substances on the grey Diaphragm ① between the lid and the drum. To check this, turn the Diaphragm ② out.

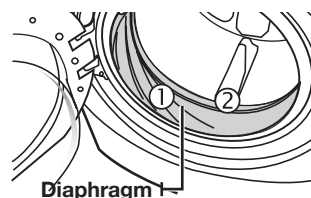

3. If there are any foreign substances, remove them.
4. If you find stained areas, wipe them down using the procedure below:
 - a) Carefully combine $\frac{3}{4}$ cup (177 mL) of liquid chlorine bleach with 1 gal. (3.8 L) of warm tap water.
 - b) Wipe the Diaphragm area with the dilute solution using a damp cloth.
 - c) Let stand 5 minutes.
 - d) Wipe down the area thoroughly with a dry cloth and let the washer interior air dry with the door open.



IMPORTANT:

- Wear rubber gloves when cleaning for prolonged periods.
- Refer to the bleach manufacturer's instructions for proper use.

PRESERVING THE TOP COVER AND THE FRONT FRAME

Do not place any heavy or sharp objects or a detergent box on the washing machine. They can scratch or damage its top cover. Keep them in the pedestal (if purchased) or in a separate storage box.



Since the entire washing machine has a high-gloss finish, the surface can be scratched or damaged. Avoid scratching or damaging the surface when using the washing machine.

maintaining your washer

SELF CLEAN+

Self Clean+ is a self-cleaning cycle that removes mold that may occur inside the washing machine.

1. Press the **Power** button.
2. Press the **Self Clean+** button.
 - Once the Self Clean+ button is pressed, the only function that can be set is Delay End.
3. Press the **Start/Pause** button.
 - When you press the Start/Pause button, Self Clean+ begins.

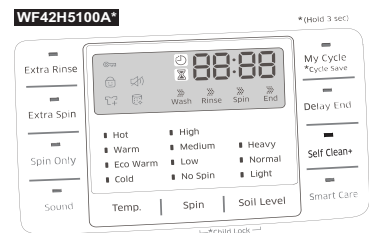
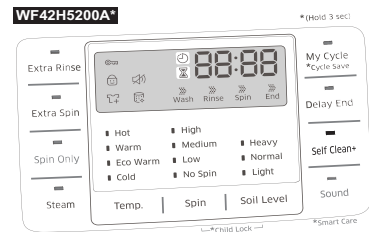

- Using Self Clean+, you can clean the drum, tub and diaphragm without using a cleansing agent.
- Never use Self Clean+ when laundry is in the washing machine. It may cause damage to the laundry or a problem with the washing machine.
- **If you want to use a drum cleansing agent, use only 1/10 of the amount of the drum cleansing agent recommended by the cleansing agent manufacturer.** (When using a powder-type cleansing agent, remove the liquid detergent compartment.)



The Self Clean+ Auto Indicator Function

- If the **"Self Clean+"** button is lit after a wash, it indicates that tub (drum) cleaning is required. In this case, remove the laundry from the washing machine, turn the power on, and clean the drum by running Self Clean.
- If you do not run Self Clean+ after every 40 washes, the **"Self Clean+"** indicator turns off after one hour. However, the **"Self Clean+"** indicator will light again after five washes. Not running Self Clean+ at this point will not cause a problem with the washing machine.
- Although the Self Clean+ Auto Indicator appears once a month or so, the frequency may differ depending on the number of times the washing machine is used.

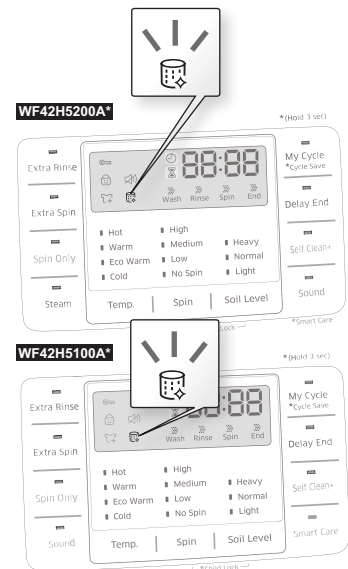

troubleshooting

CHECK THESE SOLUTIONS IF YOUR WASHER...



PROBLEM	SOLUTION
Will not start.	<ul style="list-style-type: none">• Make sure the door is firmly closed.• Make sure your washer is plugged in.• Make sure the water source faucets are open.• Make sure to press the Start/Pause Button to start your washer.• Make sure the Child Lock is not activated. See page 22.• Before your washer starts to fill, it will make a series of clicking noises to check the door lock and do a quick drain.• Check the fuse or reset the circuit breaker
Has no water or not enough water.	<ul style="list-style-type: none">• Turn both faucets on fully.• Make sure the door is tightly closed.• Straighten the water inlet hoses.• Disconnect hoses and clean the screens. Hose filter screens may be clogged.• Open and close the door, then press the Start/Pause Button.
Has detergent remains in the automatic dispenser after the wash cycle is complete.	<ul style="list-style-type: none">• Make sure your washer is running with sufficient water pressure.• Make sure the Detergent Selector dial is in the upper position when using granular detergent.
Vibrates or is too noisy.	<ul style="list-style-type: none">• Make sure your washer is set on a level surface. If the surface is not level, adjust your washer feet to level the appliance.• Make sure that the shipping bolts are removed.• Make sure your washer is not touching any other object.• Make sure the laundry load is balanced.
Stops	<ul style="list-style-type: none">• Plug the power cord into a live electrical outlet.• Check the fuse or reset the circuit breaker.• Close the door and press the Start/Pause Button to start your washer. For your safety, your washer will not tumble or spin unless the door is closed.• Before your washer starts to fill, it will make a series of clicking noises to check the door lock and do a quick drain.• There may be a pause or soak period in the cycle. Wait and it may start.• Check the screens on the inlet hoses at the faucets for obstructions. Clean the screens periodically.

troubleshooting

PROBLEM	SOLUTION
Fills with the wrong temperature water.	<ul style="list-style-type: none"> • Turn both faucets on fully. • Make sure the temperature selection is correct. • Make sure the hoses are connected to the correct faucets. Flush water lines. • Check the water heater. It should be set to deliver a minimum 120 °F (49 °C) hot water at the tap. Also check the water heater capacity and recovery rate. • Disconnect the hoses and clean the screens. The hose filter screens may be plugged. • As your washer is filling, the water temperature may change as the automatic temperature control feature checks incoming water temperature. This is normal. • While your washer is filling, you may notice just hot and/or just cold water going through the dispenser when you have selected cold or warm wash temperatures. This is a normal function of the automatic temperature control feature as your washer determines the temperature of the water.
Door locked or will not open.	<ul style="list-style-type: none"> • Press the Start/Pause Button to stop your washer. • Your washer door will remain locked during the heating portion of the Sanitize Cycle • It may take a few moments for the door lock mechanism to disengage.
Does not drain and/or spin.	<ul style="list-style-type: none"> • Check the fuse or reset the circuit breaker. • Straighten the drain hoses. Eliminate kinked hoses. If there is a drain restriction, call for service. • Close the door and press the Start/Pause Button. For your safety, your washer will not tumble or spin unless the door is closed. • Make sure the debris filter is not clogged.
Load is too wet at the end of the cycle.	<ul style="list-style-type: none"> • Use the High or Extra High spin speed. • Use high efficiency detergent to reduce over-sudsing. • The load is too small. Very small loads (one or two items) may become unbalanced and not spin out completely.
Leaks water.	<ul style="list-style-type: none"> • Make sure the door is firmly closed. • Make sure all hose connections are tight. • Make sure the end of the drain hose is correctly inserted and secured to the drainage system. • Avoid overloading. • Use high efficiency detergent to prevent over-sudsing.
Has excessive suds.	<ul style="list-style-type: none"> • Use high efficiency detergent to prevent over-sudsing. • Reduce the detergent amount for soft water, small or lightly soiled loads. • Non-HE detergent is NOT recommended.
Has an odor.	<ul style="list-style-type: none"> • Excessive suds collect in nooks and crannies and can cause foul odors. • Run cleansing cycles to sanitize the machine periodically. (Sanitize Cycle or Self Clean+) • Clean the door seal (Diaphragm). • Dry the interior of your washer after the total cycle has finished.

INFORMATION CODES

The washer may display information codes to help you better understand what is occurring with your washer.

ERROR CODE	MEANING & SOLUTION
UE	Unbalanced load prevented your washer from spinning. Redistribute the load, press the Start/Pause button.
dE	The door is open when the washer is running. Close the door tightly and restart the cycle. If the code reappears, call customer service.
dE1	Your washer failed to lock or unlock the door.
HE	A water temperature control problem. (Heater control problem) Call customer service.
LE	Your washer has tried to fill, but has not reached the proper water level. Call customer service.  When washer displays "LE", washer do draining for 3 minutes, At this time, Power button is invalid.
5E	Your washer is not draining. This can also mean that the unit senses a small clog while draining. 1. Turn off the unit for 10 seconds and then turn it on again. 2. Select the Spin Only cycle. 3. Press the Start/Pause to drain the water. If it still does not drain, call for service.
4E	Your washer has tried to fill but was unsuccessful. Make sure the water faucets are open all the way. Check for bent hoses. Check the inlet screens on the hoses. If you are using a Flood Safety Device, please remove the device and connect the water hoses directly to the unit. Check if the hot water supply hose is connected. You must connect the hot water supply hose because hot water is supplied by the Auto Temperature Control (A.T.C.) function if the temperature of the cold water is lower than 59°F.  When washer displays "4E", washer do draining for 3 minutes. At this time, Power button is invalid
4E2	The hot/cold water hose connection is not correct. Please connect the hot/cold water hose connection correctly.
OE	A fault is detected in the water level sensor. Call customer service.
1E	The Water Level sensor is not working properly. Call customer service.  When washer displays "1E", washer do draining for 3 minutes, At this time, Power button is invalid
BE2	A jammed key. Call customer service.

troubleshooting



































ERROR IMAGE	MEANING & SOLUTION
tE1	A temperature sensor problem. Restart the cycle. If the code reappears, call customer service..
3E	A motor problem. Restart the cycle. If the code reappears, call customer service.
9E1/9E2	High/Low voltage detected. Restart the cycle. If the code reappears, call customer service.
AE	A Communication error between the SUB(Sensor) PBA and the MAIN PBA Call customer service.
AE8	A Communication error between the MAIN PBA and the INVERTER PBA. Call customer service.
8E	A MEMS sensor problem. Call customer service.
SF1 SF2 SF3	A system error. Call customer service.
SUd	Too many suds are detected during the wash session. The unit is put on hold until the amount of suds have been reduced. The unit will then go back to operating.

For any codes not listed above, call 1-800-726-7864 (1-800-SAMSUNG)

appendix

FABRIC CARE CHART

The following symbols provide garment care direction. The Clothing care labels include symbols for washing, bleaching, drying and ironing, or dry cleaning when necessary. The use of symbols ensures consistency among garment manufacturers of domestic and imported items. Follow care label directions to maximize garment life and reduce laundering problems.

Wash Cycle		Special Instructions		Warning Symbols for Laundering	
	Normal		Line Dry/ Hang to Dry		Do Not Wash
	Permanent Press / Wrinkle Resistant / Wrinkle Control		Drip Dry		Do Not Wring
	Gentle/Delicates		Dry Flat		Do Not Bleach
	Hand Wash	Heat Setting			Do Not Tumble Dry
Water Temperature**			High		No Steam (added to iron)
	Hot		Medium		Do Not Iron
	Warm		Low	Dryclean	
	Cold		Any Heat		Dry Clean
Bleach			No Heat/Air		Do Not Dry Clean
	Any Bleach (when needed)	Iron-Dry or Steam Temperatures			Line Dry/ Hang to Dry
	Only Non-Chlorine (color-safe) Bleach (when needed)		High		Drip Dry
	Tumble Dry Cycle		Medium		Dry Flat
Normal			Low		
	Permanent Press/ Wrinkle Resistant/ Wrinkle Control				
	Gentle/ Delicates				

** The dot symbols represent appropriate wash water temperatures for various items. The temperature range for Hot is 105° - 125 °F / 41° - 52 °C, for Warm 85° - 105 °F / 29° - 41 °C and for Cold 60° - 85 °F / 16° - 29 °C. (Wash water temperature must be a minimum of 60 °F / 16 °C for detergent activation and effective cleaning.) The clothes washer can not ensure these temperatures because the actual temperature of the water entering your washer is dependent on water heater settings and regional water supply temperatures. For example, cold water entering the home in the northern states during winter may be 40 °F / 4 °C which is too cold for effective cleaning. The water temperature in this situation will need to be adjusted by selecting a warm setting, adding some hot water to the MAX FILL line or using your washer's heating option, if available.

appendix

CYCLE CHART

Use this chart to set the best cycle and option for you laundry.

Model: WF42H5200A*

(● : factory setting , ● : selectable)

Course	Functions										
	Temp.				Spin				Soil Level		
	H	W	EW	C	H	M	L	NS	H	N	L
NORMAL	●	●	●	●	●	●	●	●	●	●	●
HEAVY DUTY	●	●	●	●	●	●	●	●	●	●	●
SANITIZE	●				●	●	●	●	●	●	●
ALLERGEN	●				●	●	●	●	●	●	●
RINSE + SPIN					●	●	●	●			
DELICATES		●	●	●			●	●	●	●	●
PERM PRESS		●	●	●	●	●	●	●	●	●	●
QUICK WASH	●	●	●	●	●	●	●	●	●	●	●
BEDDING		●	●	●		●	●	●	●	●	●
SELF CLEAN+	●						●				

Course	Options						
	Extra Rinse	Extra Spin	Spin Only	Steam	Sound	Delay End	My Cycle
NORMAL	●	●	●	●	●	●	●
HEAVY DUTY	●	●	●	●	●	●	●
SANITIZE	●	●	●	●	●	●	●
ALLERGEN	●	●	●	●	●	●	●
RINSE + SPIN	●	●	●		●	●	●
DELICATES	●		●		●	●	●
PERM PRESS	●	●	●		●	●	●
QUICK WASH	●		●		●	●	●
BEDDING	●	●	●	●	●	●	●
SELF CLEAN+					●	●	

Temp.	Spin	Soil Level
H: Hot	H: High	H: Heavy
W: Warm	M: Medium	N: Normal
EW: Eco Warm	L: Low	L: Light
C: Cold	NS: No Spin	

Model: WF42H5100A*

(● : factory setting , ● : selectable)

Course	Functions										
	Temp.				Spin				Soil Level		
	H	W	EW	C	H	M	L	NS	H	N	L
NORMAL	●	●	●	●	●	●	●	●	●	●	●
HEAVY DUTY	●	●	●	●	●	●	●	●	●	●	●
BEDDING		●	●	●		●	●	●	●	●	●
SANITIZE	●				●	●	●	●	●	●	●
RINSE + SPIN					●	●	●	●			
ACTIVE WEAR		●	●	●		●	●	●	●	●	●
DELICATES		●	●	●			●	●	●	●	●
PERM PRESS		●	●	●	●	●	●	●	●	●	●
QUICK WASH	●	●	●	●	●	●	●	●	●	●	●
SELF CLEAN+	●						●				

Course	Options						
	Extra Rinse	Extra Spin	Spin Only	Sound	Smart Care	Delay End	My Cycle
NORMAL	●	●	●	●	●	●	●
HEAVY DUTY	●	●	●	●	●	●	●
BEDDING	●	●	●	●	●	●	●
SANITIZE	●	●	●	●	●	●	●
RINSE + SPIN	●	●	●	●	●	●	●
ACTIVE WEAR	●	●	●	●	●	●	●
DELICATES	●		●	●	●	●	●
PERM PRESS	●	●	●	●	●	●	●
QUICK WASH	●		●	●	●	●	●
SELF CLEAN+				●	●	●	

Temp.	Spin	Soil Level
H: Hot	H: High	H: Heavy
W: Warm	M: Medium	N: Normal
EW: Eco Warm	L: Low	L: Light
C: Cold	NS: No Spin	

appendix

HELPING THE ENVIRONMENT

- Your washer is manufactured from recyclable materials. If you decide to dispose of it, please observe local waste disposal regulations. Cut off the power cord so that the appliance cannot be connected to a power source. Remove the door so that animals and small children cannot get trapped inside the appliance.
- Do not exceed the detergent quantities recommended in the detergent manufacturers' instructions.
- Use stain removal products and bleaches before the wash cycle only when necessary.
- Save water and electricity by only washing full loads (the exact amount depends upon the program used).

DECLARATION OF CONFORMITY

This appliance complies with UL2157.

SPECIFICATION

TYPE	FRONT LOADING WASHER	
DIMENSIONS	Div	Inches (mm)
	A. Height-Overall	38.7" (984)
	B. Width	27" (686)
	C. Depth with door open 90°	51.2" (1300)
	D. Depth	33" (838)

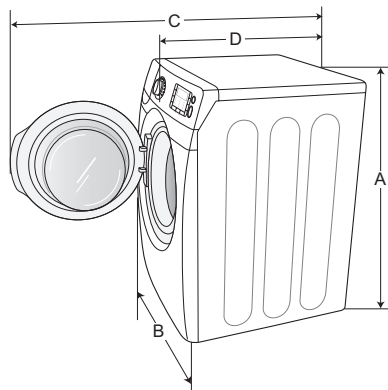

WATER PRESSURE		20-116 psi(137-800 kPa)	
MODEL		WF42H5200**/WF42H5100**	
WEIGHT		87 kg (192 lb)	
HEATER RATING		900 W	
POWER CONSUMPTION	WASHING	120 V	300 W
	WASHING AND HEATING	120 V	1200 W
	SPIN	120 V	700 W
	DRAIN	120 V	80 W
SPIN REVOLUTION		1200 rpm	

LIMITED WARRANTY (U.S.A.)

SAMSUNG WASHER

LIMITED WARRANTY TO ORIGINAL CONSUMER PURCHASER WITH PROOF OF PURCHASE

This SAMSUNG brand product, as supplied and distributed by SAMSUNG ELECTRONICS AMERICA, INC. (SAMSUNG) and delivered new, in the original carton to the original consumer purchaser, is warranted by SAMSUNG against manufacturing defects in materials or workmanship for the limited warranty period, starting from the date of original purchase, of:

One (1) year parts and labor,

Three (3) years stainless tub part (Part Only),

Ten (10) years washing DD motor part (Part Only)

This limited warranty is valid only on products purchased and used in the United States that have been installed, operated, and maintained according to the instructions attached to or furnished with the product. To receive warranty service, the purchaser must contact SAMSUNG at the address or phone number provided below for problem determination and service procedures. Warranty service can only be performed by a SAMSUNG authorized service center. The original dated bill of sale must be presented upon request as proof of purchase to SAMSUNG or SAMSUNG's authorized service center to receive warranty service.

SAMSUNG will provide in-home service within the contiguous United States during the warranty period at no charge, subject to availability of SAMSUNG authorized servicers within the customer's geographic area. If in-home service is not available, SAMSUNG may elect, at its option, to provide transportation of the product to and from an authorized service center. If the product is located in an area where service by a SAMSUNG authorized servicer is not available, you may be responsible for a trip charge or required to bring the product to a SAMSUNG authorized service center for service.

SAMSUNG will provide in-home service within the contiguous United States during the warranty period at no charge, subject to availability of SAMSUNG authorized servicers within the customer's geographic area. If in-home service is not available, SAMSUNG may elect, at its option, to provide transportation of the product to and from an authorized service center. If the product is located in an area where service by a SAMSUNG authorized servicer is not available, you may be responsible for a trip charge or required to bring the product to a SAMSUNG authorized service center for service.

To receive in-home service, product must be unobstructed and accessible to the service agent.

During the applicable warranty period, a product will be repaired, replaced, or the purchase price refunded, at the sole option of SAMSUNG. SAMSUNG may use new or reconditioned parts in repairing a product, or replace the product with a new or reconditioned product. Replacement parts and products are warranted for the remaining portion of the original product's warranty or ninety (90) days, whichever is longer. All replaced parts and products are the property of SAMSUNG and you must return them to SAMSUNG.

warranty (U.S.A)

This limited warranty covers manufacturing defects in materials or workmanship encountered in normal household, noncommercial use of this product and shall not cover the following: damage that occurs in shipment, delivery, installation, and uses for which this product was not intended; damage caused by unauthorized modification or alteration of the product; product where the original factory serial numbers have been removed, defaced, changed in any way, or cannot be readily determined; cosmetic damage including scratches, dents, chips, and other damage to the product's finishes; damage caused by abuse, misuse, pest infestations, accident, fire, floods, or other acts of nature or God; damage caused by use of equipment, utilities, services, parts, supplies, accessories, applications, installations, repairs, external wiring or connectors not supplied or authorized by SAMSUNG; damage caused by incorrect electrical line current, voltage, fluctuations and surges; damage caused by failure to operate and maintain the product according to instructions; in-home instruction on how to use your product; and service to correct installation not in accordance with electrical or plumbing codes or correction of household electrical or plumbing (i.e., house wiring, fuses, or water inlet hoses). The cost of repair or replacement under these excluded circumstances shall be the customer's responsibility.

Visits by an authorized servicer to explain product functions, maintenance or installation are not covered by this limited warranty. Please contact SAMSUNG at the number below for assistance with any of these issues.

EXCLUSION OF IMPLIED WARRANTIES

IMPLIED WARRANTIES, INCLUDING THE IMPLIED WARRANTIES OF MERCHANTABILITY OR FITNESS FOR A PARTICULAR PURPOSE, ARE LIMITED TO ONE YEAR OR THE SHORTEST PERIOD ALLOWED BY LAW. Some states do not allow limitations on how long an implied warranty lasts, so the above limitations or exclusions may not apply to you. This warranty gives you specific rights, and you may also have other rights, which vary from state to state.

LIMITATION OF REMEDIES

YOUR SOLE AND EXCLUSIVE REMEDY IS PRODUCT REPAIR, PRODUCT REPLACEMENT, OR REFUND OF THE PURCHASE PRICE AT SAMSUNG'S OPTION, AS PROVIDED IN THIS LIMITED WARRANTY. SAMSUNG SHALL NOT BE LIABLE FOR SPECIAL, INCIDENTAL OR CONSEQUENTIAL DAMAGES, INCLUDING BUT NOT LIMITED TO TIME AWAY FROM WORK, HOTELS AND/OR RESTAURANT MEALS, REMODELING EXPENSES, LOSS OF REVENUE OR PROFITS, FAILURE TO REALIZE SAVINGS OR OTHER BENEFITS REGARDLESS OF THE LEGAL THEORY ON WHICH THE CLAIM IS BASED, AND EVEN IF SAMSUNG HAS BEEN ADVISED OF THE POSSIBILITY OF SUCH DAMAGES. Some states do not allow exclusion or limitation of incidental or consequential damages, so the above limitations or exclusions may not apply to you. This warranty gives you specific rights, and you may also have other rights, which vary from state to state.

SAMSUNG does not warrant uninterrupted or error-free operation of the product. No warranty or guarantee given by any other person, firm, or corporation with respect to this product shall be binding on SAMSUNG.

To obtain warranty service, please contact SAMSUNG at:

Samsung Electronics America, Inc. 85 Challenger Road

Ridgefield Park, NJ 07660

1-800-SAMSUNG (726-7864)

www.samsung.com/us/support

warranty(CANADA)

SAMSUNG WASHER

LIMITED WARRANTY TO ORIGINAL PURCHASER

This SAMSUNG brand product, as supplied and distributed by SAMSUNG ELECTRONICS CANADA, INC. (SAMSUNG) and delivered new, in the original carton to the original consumer purchaser, is warranted by SAMSUNG against manufacturing defects in materials and workmanship for a limited warranty period of: One (1) year part and labor, Ten (10) years washing DD motor (Part only)

This limited warranty begins on the original date of purchase, and is valid only on products purchased and used in the Canada. To receive warranty service, the purchaser must contact SAMSUNG for problem determination and service procedures. Warranty service can only be performed by a SAMSUNG authorized service center. The original dated bill of sale must be presented upon request as proof of purchase to SAMSUNG or SAMSUNG's authorized service center. SAMSUNG will provide in-home service during the warranty period at no charge, subject to availability within the Canada. In-home service is not available in all areas.

To receive in-home service, product must be unobstructed and accessible to the service agent. If service is not available, SAMSUNG may elect to provide transportation of the product to and from an authorized service center.

SAMSUNG will repair, replace, or refund this product at our option and at no charge as stipulated herein, with new or reconditioned parts or products if found to be defective during the limited warranty period specified above. All replaced parts and products become the property of SAMSUNG and must be returned to SAMSUNG. Replacement parts and products assume the remaining original warranty, or ninety (90) days, whichever is longer. This limited warranty covers manufacturing defects in materials and workmanship encountered in normal, noncommercial use of this product and shall not apply to the following: damage that occurs in shipment; delivery and installation; applications and uses for which this product was not intended; altered product or serial numbers; cosmetic damage or exterior finish; accidents, abuse, neglect, fire, water, lightning, or other acts of nature or God; use of products, equipment, systems, utilities, services, parts, supplies, accessories, applications, installations, repairs, external wiring or connectors not supplied or authorized by SAMSUNG that damage this product or result in service problems; incorrect electrical line voltage, fluctuations and surges; customer adjustments and failure to follow operating instructions, maintenance and environmental instructions that are covered and prescribed in the instruction book; product removal and reinstallation; problems caused by pest infestations. This limited warranty does not cover problems resulting from incorrect electric current, voltage or supply, light bulbs, house fuses, house wiring, cost of a service call for instructions, or fixing installation errors. SAMSUNG does not warrant uninterrupted or error-free operation of the product.

warranty(CANADA)

EXCEPT AS SET FORTH HEREIN, THERE ARE NO WARRANTIES ON THIS PRODUCT EITHER EXPRESS OR IMPLIED, AND SAMSUNG DISCLAIMS ALL WARRANTIES INCLUDING, BUT NOT LIMITED TO, ANY IMPLIED WARRANTIES OF MERCHANTABILITY, INFRINGEMENT OR FITNESS FOR A PARTICULAR PURPOSE.

NO WARRANTY OR GUARANTEE GIVEN BY ANY PERSON, FIRM, OR CORPORATION WITH RESPECT TO THIS PRODUCT SHALL BE BINDING ON SAMSUNG. SAMSUNG SHALL NOT BE LIABLE FOR LOSS OF REVENUE OR PROFITS, FAILURE TO REALIZE SAVINGS OR OTHER BENEFITS, OR ANY OTHER SPECIAL, INCIDENTAL OR CONSEQUENTIAL DAMAGES CAUSED BY THE USE, MISUSE, OR INABILITY TO USE THIS PRODUCT, REGARDLESS OF THE LEGAL THEORY ON WHICH THE CLAIM IS BASED, AND EVEN IF SAMSUNG HAS BEEN ADVISED OF THE POSSIBILITY OF SUCH DAMAGES.

NOR SHALL RECOVERY OF ANY KIND AGAINST SAMSUNG BE GREATER IN AMOUNT THAN THE PURCHASE PRICE OF THE PRODUCT SOLD BY SAMSUNG AND CAUSING THE ALLEGED DAMAGE. WITHOUT LIMITING THE FOREGOING, PURCHASER ASSUMES ALL RISK AND LIABILITY FOR LOSS, DAMAGE, OR INJURY TO PURCHASER AND PURCHASER'S PROPERTY AND TO OTHERS AND THEIR PROPERTY ARISING OUT OF THE USE, MISUSE, OR INABILITY TO USE THIS PRODUCT. THIS LIMITED WARRANTY SHALL NOT EXTEND TO ANYONE OTHER THAN THE ORIGINAL PURCHASER OF THIS PRODUCT, IS NONTRANSFERABLE AND STATES YOUR EXCLUSIVE REMEDY.

Some provinces do not allow limitations on how long an implied warranty lasts, or the exclusion or limitation of incidental or consequential damages, so the above limitations or exclusions may not apply to you. This warranty gives you specific rights, and you may also have other rights, which vary from province to province.

To obtain warranty service, please contact SAMSUNG at:

Samsung Electronics Canada Inc.

2050 Derry Road West, Mississauga, Ontario L5N 0B9 Canada

1-800-SAMSUNG (726-7864)

www.samsung.com/ca/support (English)

www.samsung.com/ca_fr/support (French)

FAX:1-866-436-4617

Visits by a Service Engineer to explain functions, maintenance or installation is not covered by warranty. Please contact your Samsung call agent for help with any of these issues.

memo

memo

SAMSUNG



Scan the QR code* or visit
www.samsung.com/spsn
to view our helpful
How-to Videos and Live Shows

*Requires reader to be installed on your smartphone

bit.ly/samsungwashers

QUESTIONS OR COMMENTS?

Country	CALL	OR VISIT US ONLINE AT
U.S.A	1-800-SAMSUNG (726-7864)	www.samsung.com/us/support
MEXICO	01-800-SAMSUNG (726-7864)	www.samsung.com/mx/support
CANADA	1-800-SAMSUNG (726-7864)	www.samsung.com/ca/support (English) www.samsung.com/ca_fr/support (French)

Visits by a Service Engineer to explain functions, maintenance or installation is not covered by warranty.
Please contact your Samsung call agent for help with any of these issues.

Code No. DC68-03397D-01_EN