

OWNER'S MANUAL

SIDE BY SIDE

REFRIGERATOR

Please read this owner's manual thoroughly before operating and keep it handy for reference at all times.

Model Name(*=color)

| | | |
|------------|---------|------------|
| LSXS26326* | GS73SGS | LSXS26336* |
| LSXS26366* | GS74SDS | GS73SGG |
| LSXS26466* | GS73SDS | LSXC22386* |
| LSXS26386* | GS74SGS | LSXC22336* |
| LSXC22326* | GS73SDD | |

TABLE OF CONTENTS

3 PRODUCT FEATURES

4 IMPORTANT SAFETY INSTRUCTIONS

7 COMPONENTS

- 7 Refrigerator Exterior
- 8 Refrigerator Interior

10 INSTALLATION

- 10 Installation Overview
- 10 Specifications
- 11 Unpacking Your Refrigerator
- 11 Choosing the Proper Location
 - 11 - Flooring
 - 12 - Ambient Temperature
 - 12 - Measuring the Clearances
- 12 Removing/Assembling the Refrigerator Door Handles
- 13 Removing/Assembling the Refrigerator Doors
 - 13 - Removing the Left (Freezer) Door
 - 13 - Removing the Right (Refrigerator) Door
 - 14 - Reinstalling the Right (Refrigerator) Door
 - 14 - Reinstalling the Left (Freezer) Door
- 15 Connecting the Water Line
 - 15 - Before You Begin
 - 15 - Water Pressure
 - 15 - What You Will Need
 - 17 - Water Line Installation Instructions
- 18 Turning On the Power
- 19 Leveling
- 19 Door Alignment

20 HOW TO USE

- 20 Before Use
- 21 Control Panel
 - 21 - Airflow
 - 22 - Control Panel Features
- 24 Automatic Icemaker
 - 24 - When You Should Turn the Icemaker Off
 - 24 - Normal Sounds You May Hear
 - 24 - Preparing for Vacation
 - 24 - Power Failure
- 26 Ice and Water Dispenser
- 27 Storing Food
 - 27 - Food Preservation Location
 - 29 - Food Storage Tips
 - 29 - Storing Frozen Food
- 30 Detaching and Assembling the Storage Bins
- 32 Door-In-Door
- 33 Adjusting the Refrigerator Shelves

34 MAINTENANCE

- 34 Cleaning
- 35 Replacing the Water Filter

39 SMART DIAGNOSIS™

- 39 Using Smart Diagnosis™

40 TROUBLESHOOTING

- 40 Common Product Questions
- 41 Noises You Might Hear
- 42 Before Calling for Service

51 WARRANTY (USA)

53 WARRANTY (CANADA)

PRODUCT FEATURES

* Depending on the model, some of the following functions may not be available.

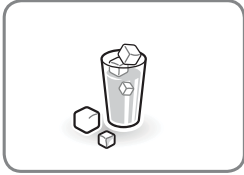

DOOR-IN-DOOR REFRESHMENT CENTER

The Door-in-Door Refreshment Center provides a convenient area for frequently-used items that require easy access.



FRESH ZONE DRAWERS

The Fresh Zone drawers are designed to help keep your fruits and vegetables fresh.



DOOR ALARM

The Door Alarm function is designed to prevent refrigerator malfunctioning that could occur if a refrigerator door remains open. If a refrigerator door is left open for more than 60 seconds, a warning alarm sounds at 30 second intervals.



AUTO CLOSING HINGE

The refrigerator doors close automatically with a slight push. (The door only closes automatically when it is open at an angle less than 30°.)

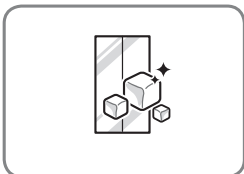

ICE PLUS

Ice production can be increased by approximately 20 percent when the freezer section is maintained at the coldest temperature for a 24-hour period.

IMPORTANT SAFETY INSTRUCTIONS

READ ALL INSTRUCTIONS BEFORE USING THE APPLIANCE.

This guide contains many important safety messages. Always read and obey all safety messages.



This is the safety alert symbol. It alerts you to safety messages that inform you of hazards that can kill or hurt you or others, or cause damage to the product.

All safety messages will be preceded by the safety alert symbol and the hazard signal word WARNING or CAUTION. These words mean:



WARNING You can be killed or seriously injured if you do not follow instructions.



CAUTION Indicates an imminently hazardous situation which, if not avoided, may result in minor or moderate injury, or product damage.



WARNING

To reduce the risk of fire, electric shock, or personal injury when using your product, basic safety precautions should be followed, including the following:

Power

- NEVER unplug your refrigerator by pulling on the power cord. Always grip the plug firmly and pull it straight out from the outlet.
- Immediately call a technician to repair or replace all power cords that have become frayed or otherwise damaged. Do not use a cord that shows cracks or abrasion damage along its length or at either the plug or connector end.
- Do not use an uncertified power outlet.
- Unplug the power plug immediately in the event of a blackout or thunderstorm.
- Plug in the power plug with the power cord facing downward.
- Do not plug appliance into a damaged wall outlet.
- If the appliance is submerged or partially submerged in water, cut off power to the appliance immediately from the main circuit breakers. Contact the nearest service center

Installation

- Contact an authorized service center when you install or relocate the refrigerator.
- When moving your refrigerator away from the wall, be careful not to roll over or damage the power cord.
- Your refrigerator must always be plugged to its own outlet which is adequately grounded. The energy current should only be 115 V ~ 60 Hz, 127 V ~ 60 Hz or 220 V ~ 50/60 Hz, AC (according to the National rating type). with a 15 A fuse for voltages between 115 and 127 V or 10 A to 220 V independent voltage protection system from the main supply of your home. (The electrical installation must be verified by a qualified technician).

- Do not install the refrigerator where there may be a danger of the unit falling.

Use

- DO NOT allow children to climb, stand, or hang on the refrigerator doors or on the shelves in the refrigerator. They could damage the refrigerator and seriously injure themselves.
- Do not hang on to or place heavy objects on the refrigerator's dispenser.
- Do not place heavy or dangerous objects (bottles with liquid) on the refrigerator.
- Do not put live animals inside the refrigerator.
- Do not allow children to climb into the product when it is in use.
- In the event of a gas leak (propane/LPG), ensure adequate ventilation and contact an authorized service center before resuming use. Do not touch or disassemble the electrical outlet of the refrigerator.
- In the event of a refrigerant leak, move flammable objects away from the refrigerator. Ensure adequate ventilation and contact an authorized service center.
- Do not use or place flammable substances (chemicals, medicine, cosmetics, etc) near the refrigerator or store them inside the refrigerator. Do not place the refrigerator in the vicinity of flammable gas.
- Do not overfill or pack items too tightly into door bins. Doing so may cause damage to the bin or personal injury if items are removed with excessive force.

IMPORTANT SAFETY INSTRUCTIONS

READ ALL INSTRUCTIONS BEFORE USING THE APPLIANCE.

To reduce the risk of fire, electric shock, or personal injury when using your product, basic safety precautions should be followed, including the following:

- This product is not to be used for special purposes such as the storage of medicine or test materials or for use on ships, etc.
- Unplug the power plug before cleaning or repairing the refrigerator.
- When a technician replaces the LED lamp in the refrigerator, unplug the refrigerator or turn off the power.
- Do not modify or extend the power cord.
- Do not use a dryer to dry the interior. Do not light a candle to remove interior odors.
- We do not recommend the use of extension cables. However, if you still choose to utilize an extension cable, it is absolutely necessary that it is listed in the UL (in the United States) or CSA (in Canada), that it supports three-pronged plugs and that the electrical current support a 15 A fuse for voltages between 115 and 127 V or 10 A to 220 V. (Verify the electric specification of your country.)
- Do not use an outlet that can be turned off with a switch. Do not use an extension cord. It is the user's responsibility to replace a standard 2-prong wall outlet with a standard 3-prong wall outlet.
- Do not, under any circumstances, cut or remove the third (ground) prong from the power cord (Verify the electric specification of your country.).
- Do not use an adapter plug and plug the power plug into a multi-outlet extension cord.
- Disconnect the power cord immediately if you hear a noise, smell a strange odor or detect smoke coming from the appliance.
- Turn the power off if water or dust penetrates into the refrigerator. Call a service agent.
- Do not disassemble or modify the refrigerator.
- Do not put hands, feet, or metal objects below or behind the refrigerator.
- Do not operate the refrigerator or touch the power cord with wet hands.
- Children should be supervised to ensure they do not use the device as a toy
- In refrigerators with automatic icemakers, avoid contact with the moving parts of the ejector mechanism or with the heating element that releases the cubes. Do not place fingers or hands on the automatic ice-making mechanism while the refrigerator is plugged in.
- When dispensing ice from the dispenser, do not use crystal ceramics.
- Do not touch the cold surfaces in the freezer compartment with wet or damp hands, when your refrigerator is in operation.
- Do not put glass containers, glass bottles or soda in the freezer.
- This appliance is not intended for use by persons (including children) with reduced physical, sensory or mental capabilities, or lack of experience and knowledge, unless they have been given supervision or instruction concerning the use of the appliance by a person responsible for their safety.
- Do not refreeze frozen food that has thawed completely. Doing so may result in a serious health issue.
- If you are throwing away your old refrigerator, make sure the CFC or HCFC coolant is removed for proper disposal by a qualified servicer. If you release CFC/HCFC coolant, you may be fined or imprisoned in accordance with the relevant environmental law.
- Junked or abandoned refrigerators are dangerous, even if they are sitting for only a few days. When disposing of the refrigerator, remove the packing materials from the door or take off the doors but leave the shelves in place so that children may not easily climb inside.
- If the refrigerator is connected to a circuit protected by fuses, use time delay fuses.

IMPORTANT SAFETY INSTRUCTIONS

READ ALL INSTRUCTIONS BEFORE USING THE APPLIANCE.

To reduce the risk of fire, electric shock, or personal injury when using your product, basic safety precautions should be followed, including the following:



CAUTION

Installation

- The refrigerator must be properly installed in accordance with the Installer Instructions that were taped to the front of the refrigerator.
- Be careful when you unpack and install the refrigerator. Immediately dispose of plastic and other packing materials out of the reach of children.
- The appliance must be positioned for easy access to a power source.

Use

- Close the door carefully when children are around.
- Keep fingers out of pinch point areas; clearances between the doors and cabinets are necessarily small. Be careful closing doors when children are nearby.
- If you store food improperly, be aware that it may fall and cause injury.
- Do not use aerosols near the refrigerator.
- Do not store articles on the top of the appliance.
- If the appliance's power cord is damaged, the cord must be replaced by the manufacturer or its service agent or a similarly qualified technician in order to avoid hazard. Do not operate the appliance with a damaged power cord.
- Caution: This device is meant to be used in applications domestic and the like, such as: areas of kitchen staff in shops, offices and other environments I work; cottages and customers in hotels, motels and other environments residential; environments bed and breakfast rate; hospitality non-commercial and similar applications.
- Refrigerator compartment's lamps are interior lighting LED type, so maintenance must be performed by a qualified technician.

- Do not use extension cords or ungrounded (two prong) adapters.
- Do not store explosive substances such as aerosol cans with a flammable propellant in this appliance.

Maintenance

- Do not use strong detergents like wax or thinners for cleaning. Clean with a soft cloth.
 - Wipe foreign objects (such as dust and water) off the prongs of the power plug and contact areas regularly.
 - Do not store, disassemble or repair the refrigerator by yourself.
 - Remove any dust or foreign matter from the power plug pins.
 - Do not use a wet or damp cloth when cleaning the plug.
 - If the refrigerator is disconnected from the power supply, wait for at least five minutes before plugging it back in.
- If you notice a chemical or burning plastic smell or see smoke, unplug the refrigerator immediately and contact your LG Electronics Service Center.

The insulation in this unit contains cyclopentane or a pentane like blowing gas for insulation which is flammable and requires a special elimination process. Before discontinuing use of this refrigerator, contact local authorities to arrange for safe disposal of the unit.

IMPORTANT : Use only new water hose-sets, do not reuse old water hose -sets



NOTE

Before a technician installs, cleans or changes lights, unplug the refrigerator. When finished reconnects refrigerator and reset the control (of thermostat, refrigerator or freezer, depending on your model) to the desired position.

SAVE THESE INSTRUCTIONS

COMPONENTS

Use this page to become more familiar with the parts and features of your refrigerator.

*The appearance and specifications of the actual product may differ depending on the model.

Refrigerator Exterior for Door-In-Door Models

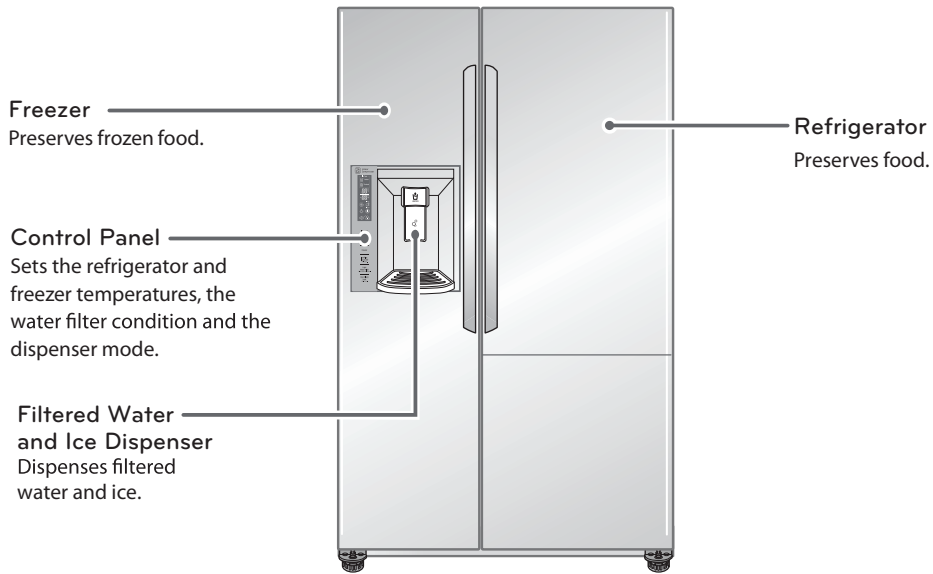

Refrigerator Exterior for Standard Model

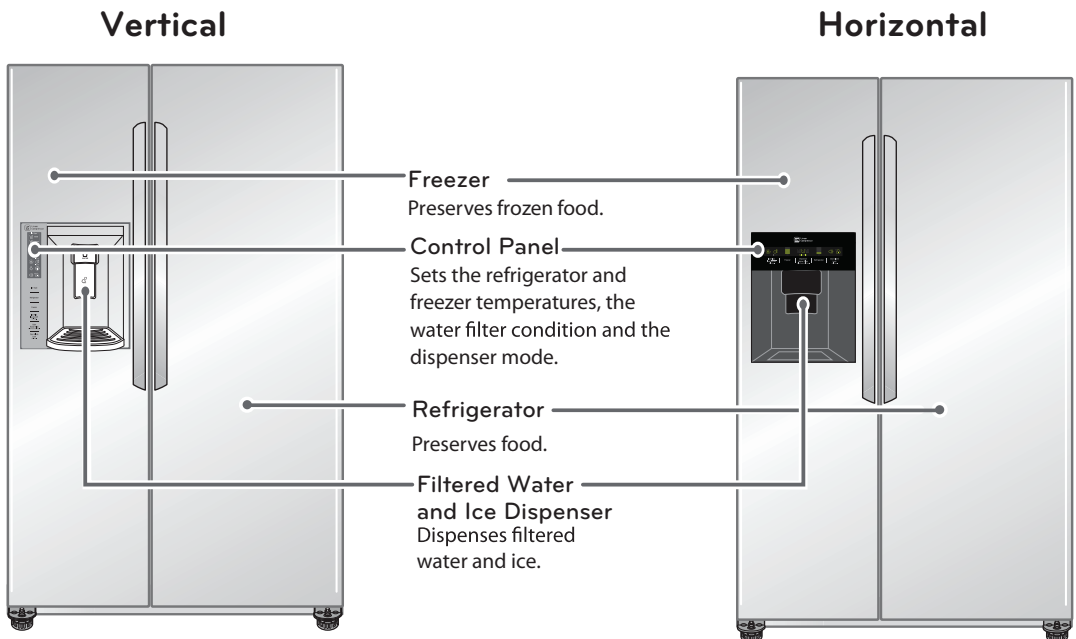

Refrigerator Interior for Door-In-Door Models

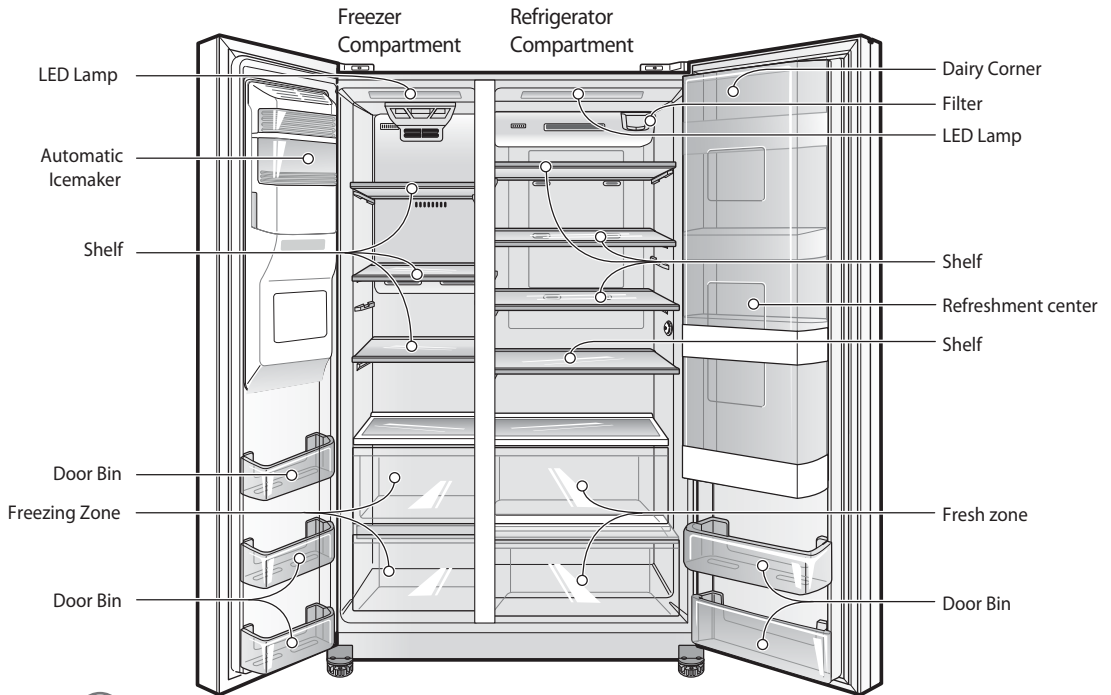

NOTE

Parts, features and options vary by model.
Your model may not include every option.

Refrigerator Interior for Standard Model

Vertical Display

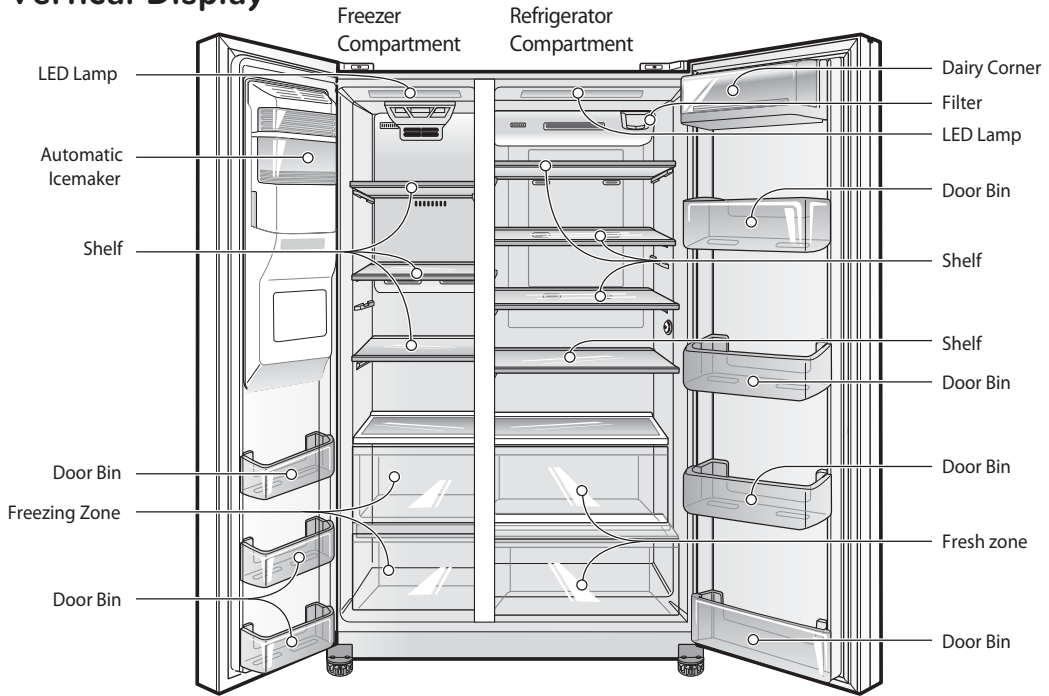

Horizontal Display

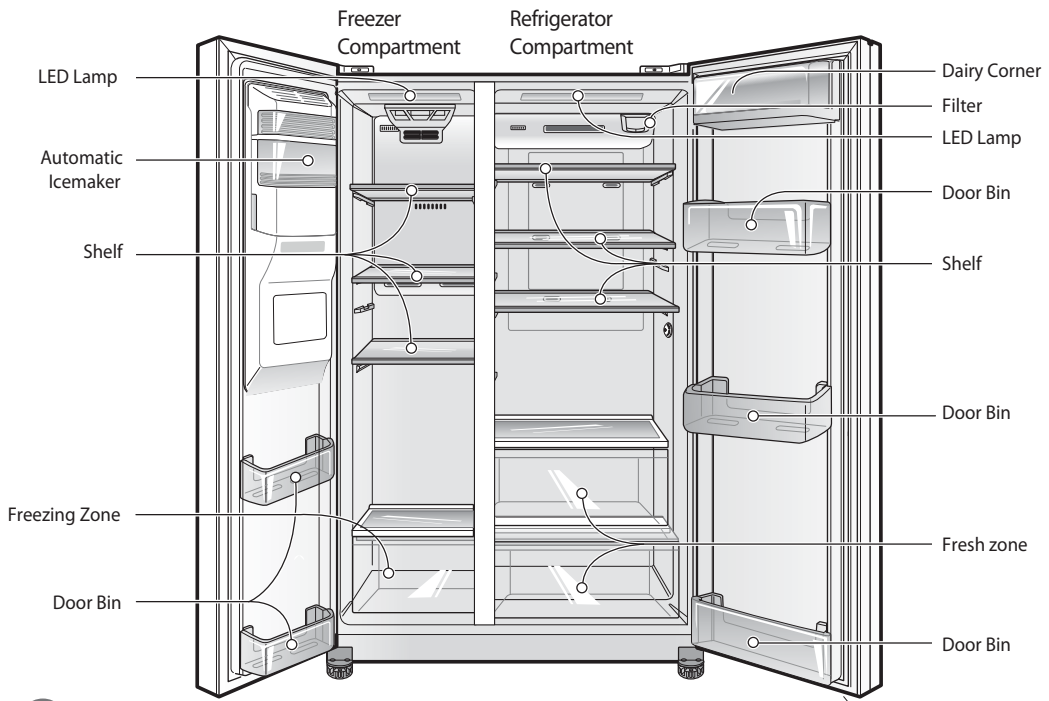

NOTE

Parts, features and options vary by model. Your model may not include every option.

INSTALLATION

Installation Overview

Please read the following installation instructions first after purchasing this product or transporting it to another location.

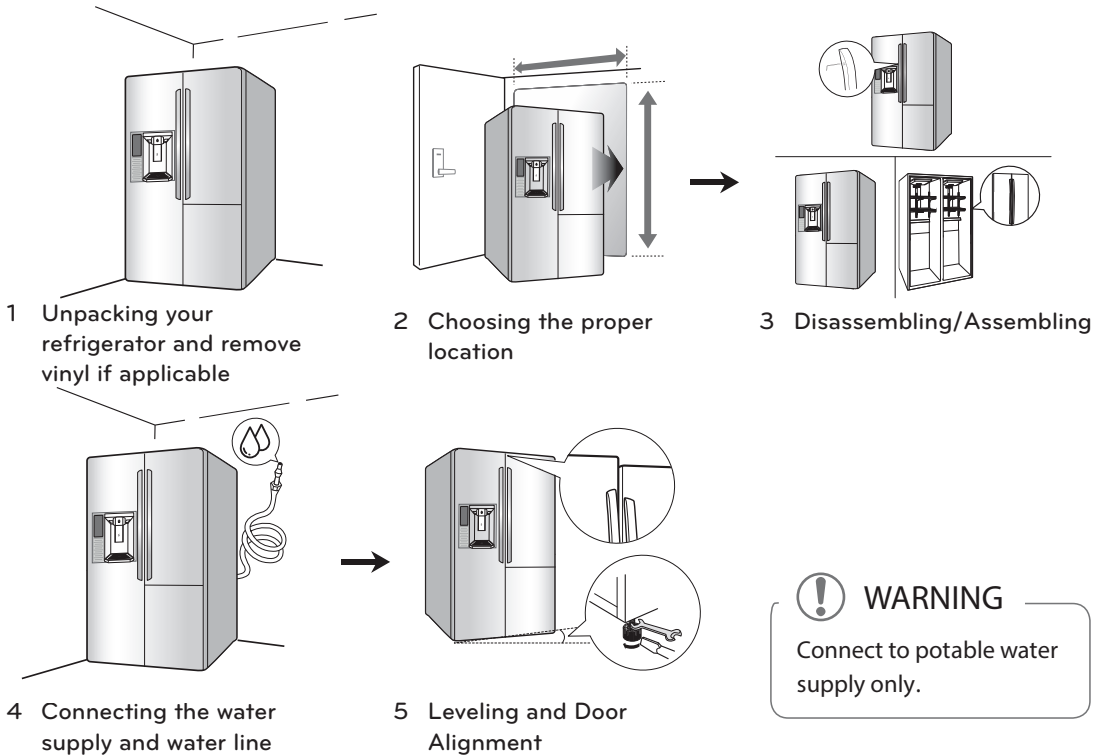

Specifications

The appearance and specifications listed in this manual may vary due to constant product improvements.

| Side by Side refrigerator model | |
|---|--|
| Description | Side by Side refrigerator |
| Electrical requirements | 115 V ~ 60 Hz and fused at 15 A 127 V ~ 60 Hz and fused at 15 A 220 V ~ 50/60 Hz and fused at 10 A (Refer to rating label inside refrigerator compartment). |
| Min. / Max. Water pressure | 20 - 120 psi (138 - 827 kPa) on models without water filter 40 - 120 psi (276 - 827 kPa) on models with filter |
| Dimensions for Standard Depth Models LSXS26****, GS7**** | 35.8" (W) X 36.3" (D) X 70.3" (H), 51.1" (D w/ door open) 909 mm (W) X 922 mm (D) X 1785 mm (H), 1298 mm (D w/ door open) After Door Removal: 29.1" (739 mm) (D) |
| Dimensions for Counter Depth Models LSXC22**** | 35.9" (W) X 31.8" (D) X 70.3" (H), 46.5" (D w/ door open) 912 mm (W) X 807 mm (D) X 1785 mm (H), 1180 mm (D w/ door open) After Door Removal: 24.6" (624 mm) (D) |
| Net weight for Standard Depth Models LSXS26****, GS7**** | DID Model: 304.3 lb (138 kg) Basic Model Vertical: 277.8 lb (126 kg) Basic Model Horizontal: 264.6 lb (120 kg) |
| Net weight for Counter Depth Models LSXC22**** | DID Model: 277.8 lb (126 kg) Non DID Model: 251.4 lb (114 kg) |
| Net weight for Counter Depth Models LSXC22336* | Non DID Model: 280 lb (127 kg) |

Unpacking Your Refrigerator



WARNING

- Use two or more people to move and install the refrigerator. Failure to do so can result in back or other injury.
- Your refrigerator is heavy. When moving the refrigerator for cleaning or service, be sure to protect the floor. Always pull the refrigerator straight out when moving it. Do not wiggle or walk the refrigerator when trying to move it, as floor damage could occur.
- Keep flammable materials and vapors, such as gasoline, away from the refrigerator. Failure to do so can result in fire, explosion, or death.

Remove tape and any temporary labels from your refrigerator before using. Do not remove any warning-type labels, the model and serial number label.

To remove any remaining tape or glue, rub the area briskly with your thumb. Tape or glue residue can also be easily removed by rubbing a small amount of liquid dish soap over the adhesive with your fingers. Wipe with warm water and dry.

Please remove vinyl from doors before connecting unit to the electrical supply (on some models).

Do not use sharp instruments, rubbing alcohol, flammable fluids, or abrasive cleaners to remove tape or glue. These products can damage the surface of your refrigerator.

Refrigerator shelves are installed in the shipping position. Please reinstall shelves according to your individual storage needs.

Choosing the Proper Location

- Select a place where a water supply can be easily connected for the automatic icemaker.



NOTE

The water pressure must be between 20 and 120 psi (138 and 827 kPa) on models without a water filter and between 40 and 120 psi (276 and 827 kPa) on models with a water filter.

- The refrigerator should always be plugged into its own individual properly grounded electrical outlet. This provides the best performance and also prevents overloading house wiring circuits which could cause a fire hazard from overheated wires. It is recommended that a separate circuit serving only this appliance be provided.



WARNING

To reduce the risk of electric shock, do not install the refrigerator in a wet or damp area.

Flooring

To avoid noise and vibration, the unit must be leveled and installed on a solidly constructed floor. If required, adjust the leveling legs to compensate for unevenness of the floor. The front should be slightly higher than the rear to aid in door closing. Leveling legs can be turned easily by tipping the cabinet slightly. Turn the leveling legs to the left to raise the unit or to the right to lower it. (See Leveling and Door Alignment.)



NOTE

Installing on carpeting, soft tile surfaces, a platform or weakly supported structure is not recommended.

Ambient Temperature

Install this appliance in an area where the temperature is between 55°F (13°C) and 110°F (43°C). If the temperature around the appliance is too low or high, cooling ability may be adversely affected.

Measuring the Clearances

Too small of a distance from adjacent items may result in lowered freezing capability and increased electricity consumption charges.

Allow at least 24 inches (61 cm) in front of the refrigerator to open the doors, and at least 2 inches (5.08 cm)

between the back of the refrigerator and the wall as well as on the sides of the refrigerator and adjacent walls or objects.

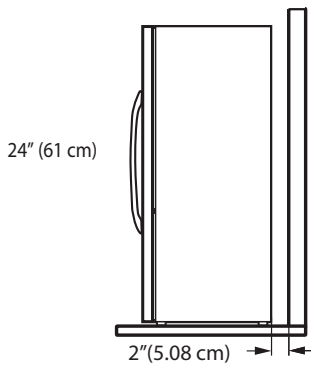

Replacement of lamp

The refrigerator compartment lamp is a LED interior lighting, so maintenance must be performed by a qualified technician.

Removing/Assembling the Refrigerator Door Handles

NOTE

When it is necessary to move the refrigerator through a narrow opening, removing the doors is the recommended procedure. If it is necessary to remove the handles, follow the directions below. The appearance of the handle may vary from what is shown in the illustrations

Removing the Handles

- 1 Loosen the set screws with a 3/32 in. Allen wrench and remove the handle.
- 2 Loosen the mounting fasteners that connect to the refrigerator door and handle using a 1/4 in. Allen wrench, remove the mounting fasteners.

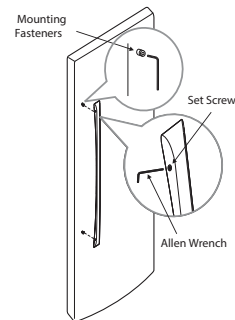

Assembling the Handles

- 1 Assemble the mounting fasteners at both ends of the handle using a 1/4 in. Allen wrench.
- 2 Place the handle on the door by fitting the handle footprints over the mounting fasteners and tightening the set screws with a 3/32 in. Allen wrench.

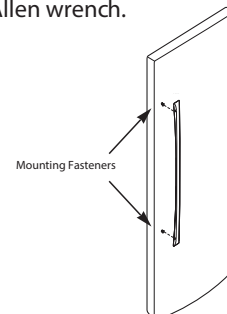

Removing and replacing refrigerator doors

WARNING

Excessive Weight Hazard:

- Use two or more people to remove and install the refrigerator doors. Failure to do so can result in back or other injury.

Electrical Shock Hazard

- Disconnect the electrical supply to the refrigerator before installing. Failure to do so could result in serious injury or death.
- Do not put hands, feet or other objects into the air vents or bottom of the refrigerator. You may be injured or receive an electrical shock.

Removing the Left (Freezer) Door with Water Line Connection

1. Disconnect the 2 water line connections, located on the back of the refrigerator. Hold the water supply connection and gently push the collet to detach the water supply line as shown.

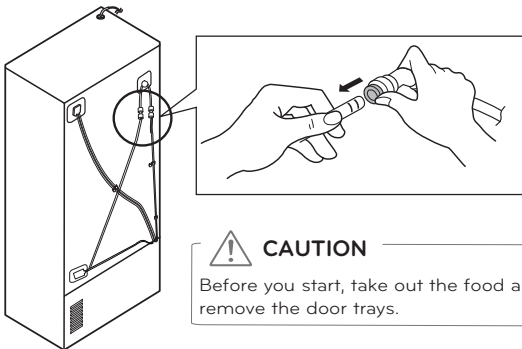

 **CAUTION**
Before you start, take out the food and remove the door trays.

2. Open the door. Remove the top hinge cover screw.
3. Use a flat-blade screwdriver to pry back the hooks (not shown) of the hinge cover from the top of the refrigerator cabinet. Lift up the cover.
4. Disconnect all the wire harnesses and remove the hinge cover.
5. Pull out the water supply lines.
6. Unscrew the ground wire.

CAUTION

When lifting the hinge free of the latch, be careful that the door does not fall forward.

7. Rotate the hinge lever counterclockwise. Lift the upper hinge free of the hinge lever latch.

8. Lift the door from the lower hinge pin and place it, inside facing up, on a non-scratching surface.

Removing the right (refrigerator) door

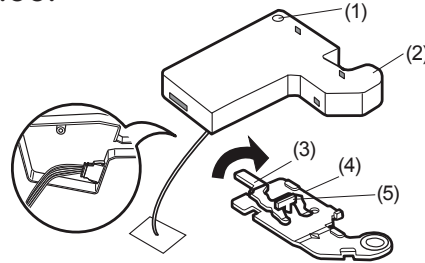

1. Open the door. Remove the screw from the cover of the upper hinge (1). Lift the lid (2).
2. Use a flat screwdriver to make lever and lift the hooks (not seen in the image) located at the bottom front of the lid. Lift the lid.
3. Turn the hinge lever (3) on the clockwise. Lift the upper hinge (4) separated from the bra of the hinge lever (5).
4. Place the door, with the inner part up, on a surface that does not scratch.

CAUTION

When you lift the hinge separate from the clamp, be careful that the Door does not fall forward.

- Lift the door from the power plug middle hinge and remove the door.
- Place the door, with the inner part up, on a surface that does not scratch.

5. Raise the door from the bottom pin of The hinge.

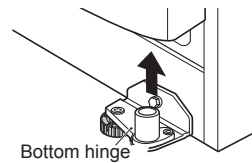

CAUTION

- When releasing the handle hinge, be careful that the door does not fall forward.
- Place the door, the inside looking outward, on a scratched surface, have Be careful not to damage the water lines.

Reinstalling the Left (Freezer) Door

1. Lower the door onto the hinge pin of the means, medium.
2. Make sure the door is aligned with the interior cabinet.
3. Place the top hinge on the fastener of the hinge lever and in place. Turn the clockwise lever and adjustment the hinge.

Disassembling/Assembling the water lines

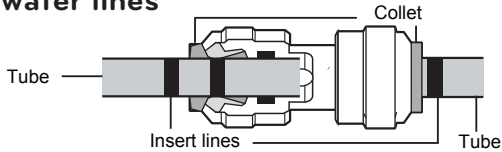

4. Reconnect the water lines by inserting them into the connectors. The water lines are inserted correctly when only one of the two guidelines remains visible.

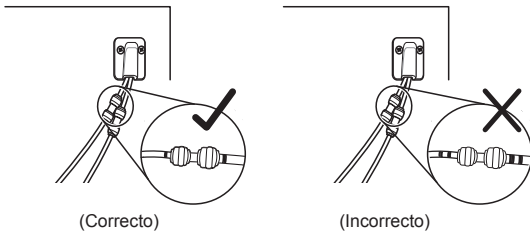

NOTE

- Water hoses should be cut leaving a clean and straight edge to avoid losses.



5. Reconnect all of the wire harnesses.

6. Reconnect the ground wire.

7. Hook the tab on the switch side of the cover under the edge of the wire opening in the cabinet top. Position the cover in place. Insert and tighten the cover screw.

Reinstalling the right (Refrigerator) Door

1. Position the door from the bottom pin of the hinge.

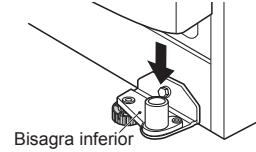

2. Place the top hinge above the latch the hinge lever and place it instead. Rotate the lever in direction counter clockwise and secure the hinge.

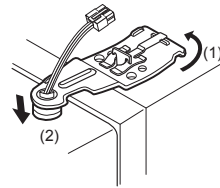

3. Reconnect all harnesses. Hook the tab on the side switch of the lid, under the edge of the opening in the top of the cabinet. Place the lid and replace screw.

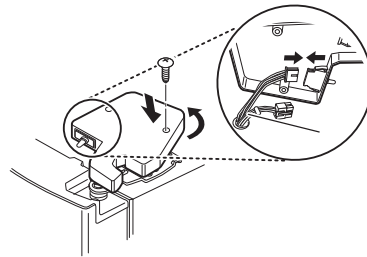

Connecting the Water Line

Before You Begin

This water line installation is not covered by the refrigerator warranty. Follow these instructions carefully to minimize the risk of expensive water damage.

Water hammer (water banging in the pipes) in house plumbing can cause damage to refrigerator parts and can lead to water leakage or flooding. Call a qualified plumber to correct water hammer before installing the water supply line to the refrigerator.



CAUTION

To prevent burns and product damage, only connect the refrigerator water line to a cold water supply.



CAUTION

Do not install the icemaker tubing in areas where temperatures fall below freezing.

Water Pressure

You will need a cold water supply. The water pressure must be between 20 and 120 psi (138 – 827 kPa) on models without a water filter and between 40 and 120 psi (276 – 827 kPa) on models with a water filter. If the water pressure does not reach the minimum required pressure, a separate booster pump may be required for normal automatic icemaker and cool water dispensing operation.

If a reverse osmosis water filtration system is connected to your cold water supply, this water line installation is not covered by the refrigerator warranty. Follow these instructions carefully to minimize the risk of expensive water damage.

If a reverse osmosis water filtration system is connected to your cold water supply, the water pressure to the reverse osmosis system needs to be a minimum of 40 to 60 psi (276 - 413 kPa, or less than 2.0~3.0 sec. to fill a cup of 7 oz capacity).



CAUTION

Wear eye protection during installation to prevent injury.

If the water pressure from the reverse osmosis system is less than 21 psi or 1.5 kgf/cm² (takes more than 4.0 sec to fill a cup of 7 oz capacity):

- Check to see if the sediment filter in the reverse osmosis system is blocked. Replace the filter if necessary.
- Allow the storage tank on the reverse osmosis system to refill after heavy usage.
- If the issue concerning water pressure from reverse osmosis remains, call a licensed, qualified plumber.
- All installations must be in accordance with local plumbing code requirements.

What You Will Need

- **Copper Tubing**, ¼ in. outer diameter, to connect the refrigerator to the water supply. Be sure both ends of the tubing are cut square.

To determine how much tubing you need: measure the distance from the

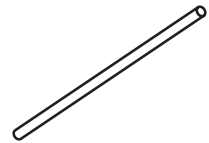

water valve on the back of the refrigerator to the water supply pipe. Then, add 8 feet (2.4 m). Be sure there is sufficient extra tubing (about 8 feet [2.4 m] coiled into 3 turns of about 10 in. [25 cm] diameter) to allow the refrigerator to move out from the wall after installation. Keep the total length of the feed water pipe tube within 26 ft (8 m). Be careful to avoid getting a kink in the tube. If the tube is longer than 26 ft (8 m), it may cause the water feed to malfunction.

- **Power drill.**
- **½ in. or adjustable wrench.**
- **Flat blade and Phillips head screwdrivers.**
- **Two ¼ in. outer diameter compression**

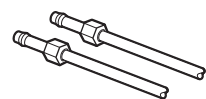
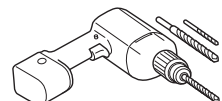

nuts and 2 ferrules (sleeves) to connect the copper tubing to the shutoff valve and the refrigerator water valve.

- If your existing copper water line has a flared fitting at the end, you will need an **adapter** (available at plumbing supply stores) to connect the water line to the refrigerator OR you can cut off the flared fitting with a tube cutter and then use a compression fitting.

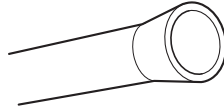

- **Shutoff valve to connect to the cold water line.** The shutoff valve should have a water inlet with a minimum inside diameter of 5/32 in. at the point of connection to the COLD WATER LINE. Saddle-type shutoff valves are included in many water supply kits.

Before purchasing, make sure a saddle-type valve complies with your local plumbing codes.

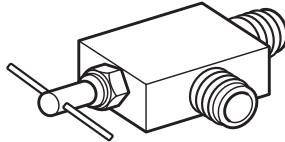
**NOTE**

A self-piercing saddle type water valve should not be used.

**WARNING****Electrical Shock Hazard:**

When using any electrical device (such as a power drill) during installation, be sure the device is battery powered, double insulated or grounded in a manner that will prevent the hazard of electric shock.

Water Line Installation Instructions

WARNING

- When using any electrical device (such as a power drill) during installation, be sure the device is battery powered, double insulated or grounded in a manner that will prevent the hazard of electric shock.

Install the shutoff valve on the nearest frequently used drinking water line.

- 1 SHUT OFF THE MAIN WATER SUPPLY**
Turn on the nearest faucet to relieve the pressure on the line.

- 2 CHOOSE THE VALVE LOCATION**
Choose a location for the valve that is easily accessible. It is best to connect into the side of a vertical water pipe. When it is necessary to connect into a horizontal water pipe, make the connection to the top or side, rather than at the bottom, to avoid drawing off any sediment from the water pipe.

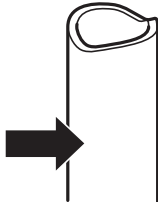

- 3 DRILL THE HOLE FOR THE VALVE**
Drill a 1/4 in. hole in the water pipe using a sharp bit. Remove any burrs resulting from drilling the hole in the pipe. Be careful not to allow water to drain into the drill. Failure to drill a 1/4 in. hole may result in reduced ice production or smaller cubes.

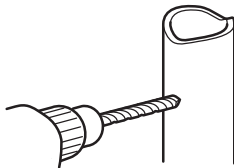

NOTE

The hookup line cannot be white, plastic tubing. Licensed plumbers must use only copper tubing (NDA tubing #49595 or #49599) or Cross Link Polyethylene (PEX) tubing.

- 4 FASTEN THE SHUTOFF VALVE**
Fasten the shutoff valve to the cold water pipe with the pipe clamp.

- 5 TIGHTEN THE PIPE CLAMP**

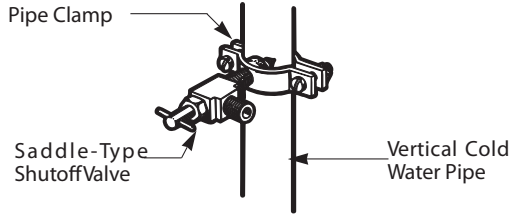

NOTE

Commonwealth of Massachusetts Plumbing Codes 248CMR shall be adhered to. Saddle valves are illegal and use is not permitted in Massachusetts. Consult with your licensed plumber.

Tighten the clamp screws until the sealing washer begins to swell.

NOTE: Do not overtighten clamp or you may crush the tubing.

- 6 ROUTE THE TUBING**

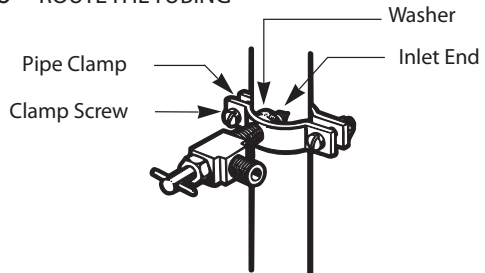

Route the tubing between the cold water line and the refrigerator.

Route the tubing through a hole drilled in the wall or floor (behind the refrigerator or adjacent base cabinet) as close to the wall as possible.

NOTE

Be sure there is sufficient extra tubing (about 8 feet (2,4 m) coiled into 3 turns of about 10 in. (0,25 m) diameter) to allow the refrigerator to move out from the wall after installation.

- 7 **CONNECT THE TUBING TO THE VALVE**
Place the compression nut and ferrule (sleeve) for copper tubing onto the end of the tubing and connect it to the shutoff valve. Make sure the tubing is fully inserted into the valve. Tighten the compression nut securely.

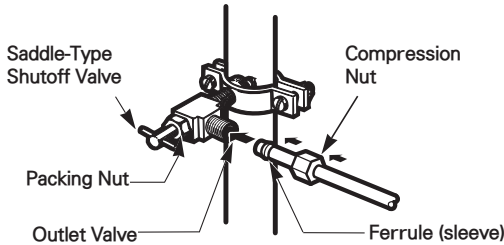

- 8 **FLUSH OUT THE TUBING**
Turn the main water supply on and flush out the tubing until the water is clear.

Shut the water off at the water valve after about one quart of water has been flushed through the tubing.



- 9 **CONNECT THE TUBING TO THE REFRIGERATOR**
NOTE: Before making the connection to the refrigerator, be sure that the refrigerator power cord is not plugged into the wall outlet.

- Remove the plastic flexible cap from the water valve.
- Place the compression nut and ferrule (sleeve) onto the end of the tubing as shown.
- Insert the end of the copper tubing into the connection as far as possible. While holding the tubing, tighten the fitting.

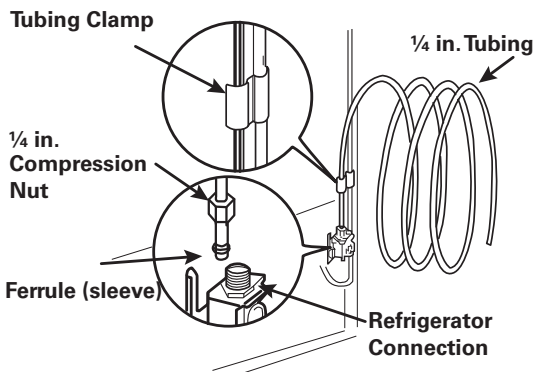

- 10 **TURN THE WATER ON AT THE SHUTOFF VALVE**
Tighten any connections that leak.

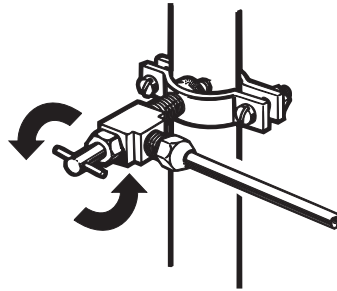

CAUTION

Check to see if leaks occur at the water line connections.

- 11 **PLUG IN THE REFRIGERATOR**
Arrange the coil of tubing so that it does not vibrate against the back of the refrigerator or against the wall. Push the refrigerator back to the wall.

- 12 **START THE ICEMAKER**
The icemaker will not begin to operate until it reaches its operating temperature of 15°F (-9°C) or below.

Turning On The Power

- 1 Plug in the refrigerator.

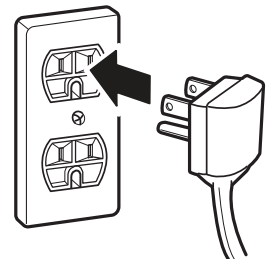

CAUTION

- Connect to a rated power outlet.
- Have a certified electrician check the wall outlet and wiring for proper grounding.
- Do not damage or cut off the ground terminal of the power plug.

Leveling

After installing, plug the refrigerator's power cord into a 3-prong grounded outlet and push the refrigerator into the final position.

Your refrigerator has two front leveling legs—one on the right and one on the left. Adjust the legs to alter the tilt from front-to-back or side-to-side. If your refrigerator seems unsteady, or you want the doors to close more easily, adjust the refrigerator's tilt using the instructions below:

NOTE: Tools Required: 11/16" (18mm) wrench or flat blade screwdriver.

- 1 Turn the leveling leg counterclockwise to raise that side of the refrigerator or clockwise to lower it. It may take several turns of the leveling leg to adjust the tilt of the refrigerator.

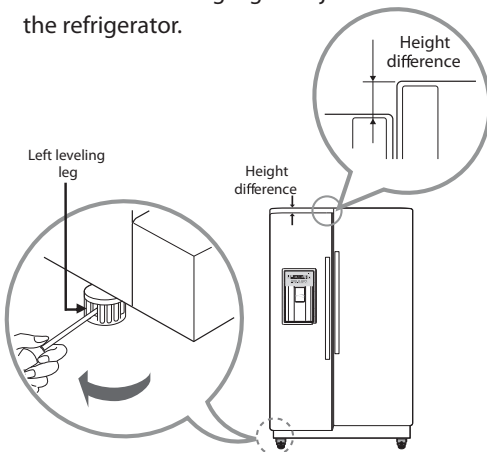

NOTE: Having someone push backward against the top of the refrigerator takes some weight off of the leveling legs. This makes it easier to adjust the legs.

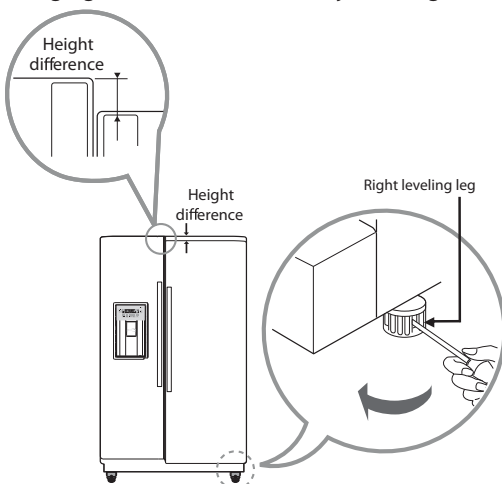

- 2 Open both doors again and check to make sure that they close easily. If the doors do not close easily, tilt the refrigerator slightly more to the rear by turning both leveling legs counterclockwise. It may take several more turns, and you should turn both leveling legs the same amount.

Door Alignment

If the doors are still uneven after the refrigerator has been leveled, finish adjusting the doors by following the instructions below:

Adjusting tools: 5/16" (8mm) wrench and 3/4" (19mm) wrench.

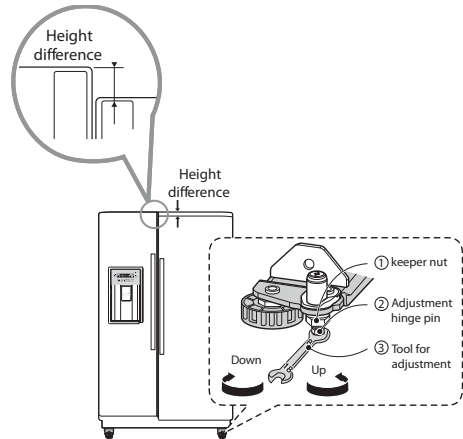

- Using a 3/4" (19mm) wrench, turn the keeper nut counterclockwise to loosen the keeper nut.
- Using a 5/16" (8mm) wrench, turn the adjustment hinge pin clockwise or counterclockwise to level the door.
- After leveling the door, turn the keeper nut clockwise to tighten it.

⚠ CAUTION: Do not overtighten the door adjustment screw. The hinge pin can be pulled out (adjustable range of height is a maximum of 2 in. (5 cm)).

HOW TO USE

Before Use

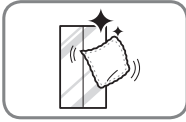

Clean the refrigerator.

Clean your refrigerator thoroughly and wipe off all dust that accumulated during shipping.

! CAUTION

- Do not scratch the refrigerator with a sharp object or use a detergent that contains alcohol, a flammable liquid or an abrasive when removing any tape or adhesive from the refrigerator.
- Do not peel off the model or serial number label or the technical information on the rear surface of the refrigerator.

! NOTE

Remove adhesive residue by wiping it off with your thumb or dish detergent.

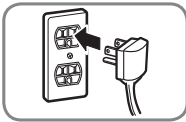

Connect the power supply.

Check if the power supply is connected before use.
Read the "Turning On The Power" section.

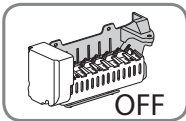

Turn off the icemaker if the refrigerator is not yet connected to the water supply.

Plug the power plug of the refrigerator into the grounded electric outlet and then turn off the automatic icemaker.

*This is applicable only to certain models.

! CAUTION

Running the automatic icemaker before connecting it to the water supply may cause the refrigerator to malfunction.

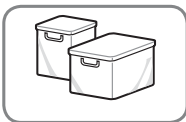

Wait for the refrigerator to cool.

Allow your refrigerator to run for at least two to three hours before putting food in it. Check the flow of cold air in the freezer compartment to ensure proper cooling.

! CAUTION

Putting food in the refrigerator before it has cooled could cause the food to spoil, or a bad odor could linger inside the refrigerator.



The refrigerator makes a loud noise after initial operation.

This is normal. The volume will decrease as the temperature lowers.

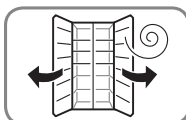

Open refrigerator and freezer doors to ventilate the interior.

The inside of the refrigerator may smell like plastic at first. Remove any adhesive tape from inside the refrigerator and open the refrigerator and freezer doors for ventilation.

Control Panel

The refrigerator control functions as the thermostat for the entire appliance (refrigerator and freezer sections). The colder the setting, the longer the compressor will run to keep the temperature colder. The freezer control adjusts the cold air flow from the freezer to the refrigerator. Setting the freezer control to a lower temperature keeps more cold air in the freezer compartment to make it colder.

Airflow

Cold air circulates from the freezer to the fresh food section and back again through air vents in the wall dividing the two sections. Be sure not to block vents while packing your refrigerator. Doing so will restrict airflow and may cause the refrigerator temperature to become too warm or cause interior moisture buildup. (See air flow diagram below.)

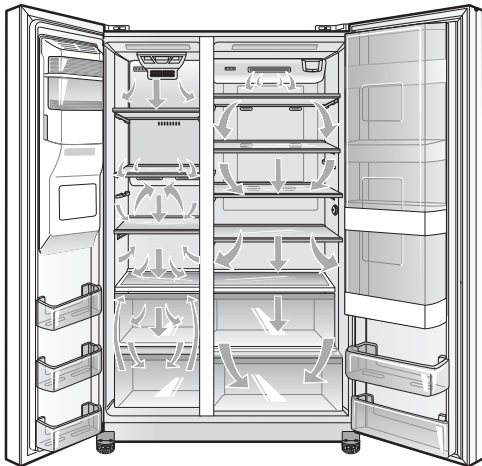

IMPORTANT:

Because air circulates between both sections, any odors formed in one section will transfer to the other. You must thoroughly clean both sections to eliminate odors.

To prevent odor transfer and dried out food, wrap or cover foods tightly. (See the Food Storage Guide section for details.)

NOTE: If you close the refrigerator door, you may see the freezer door open and close again due to pressure from internal air flow.

Control Panel Features

* Depending on the model, some of the following functions may not be available.

Vertical Display

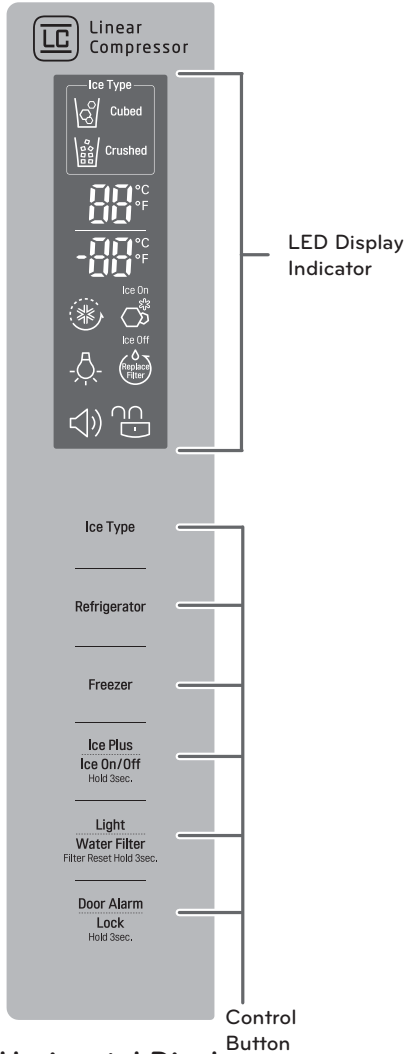

Horizontal Display

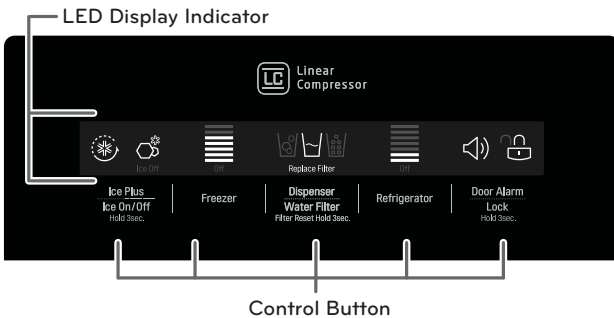

Ice Type

Vertical Display

Select Crushed Ice or Cubed Ice by pressing the Ice Type button repeatedly to choose the selection desired. The Crushed Ice or Cubed Ice icon will light up to indicate your selection.



Selecting this icon indicates that cubed ice will be dispensed when the dispenser pad is activated.



Selecting this icon indicates that crushed ice will be dispensed when the dispenser pad is activated.

Horizontal Display

Select Crushed Ice, Cubed Ice or Water by pressing the Dispenser button repeatedly to choose the selection desired. The Icon will light up to indicate your selection.



To dispense water or ice, gently push your cup against the dispenser pad (see page 26).
NOTE: Hold your cup in place for a couple of seconds after dispensing ice or water so the last few drops go in your cup instead of on the floor.

Temperature

- The Refrigerator Temp. Control ranges from 33°F to 46°F (1°C to 8°C). Press the Refrigerator button to cycle through the available temperature settings one increment at a time.
- The Freezer Temp. Control range is from -6°F to 8°F (-21°C to -13°C). Press the Freezer button to cycle through the available temperature settings one increment at a time.

NOTE: When changing control settings, wait 24 hours before making additional adjustments. The controls are set correctly when milk or juice is as cold as you would like and when ice cream is firm. If the temperature in either compartment is too cold or too warm, change the setting one increment at a time. Wait 24 hours for the change to stabilize before adjusting again.

Temperature Mode Switch Function (°F <->°C)

If you want to convert °F to °C or vice versa, press and hold the Freezer and Refrigerator buttons at the same time for approximately five seconds. (Type 2 is not available)

Ice Plus

- When you press the Ice Plus button, the graphic will illuminate in the display and will continue for 24 hours. The function will automatically shut off after 24 hours.
- You can stop this function manually by pressing the button one more time.
- This function increases both ice making and freezing capabilities.

Ice ON/OFF

- To turn off the automatic icemaker, press and hold the Ice ON/OFF button for three seconds until the Ice Off text is illuminated. To turn on the automatic ice maker, press and hold until the Ice On text is illuminated.

Light

This light has two settings: ON and OFF. Press the Light button to turn the dispenser light on and off. (Not available on all models)

Water Filter Reset

When the water filter indicator turns on, you need to replace the water filter. After replacing the water filter, press and hold the Replace Filter button for three seconds to turn the indicator light off. You need to replace the water filter approximately every six months.

Door Alarm

- When power is connected to the refrigerator, the door alarm is initially set to ON. When you press the Door Alarm button, the display will change to OFF and the Door Alarm function will deactivate.
- When either the refrigerator or the freezer door is left open for more than 60 seconds, the alarm tone will sound to let you know that the door is open.
- When you close the door, the door alarm will stop.

Lock

- When power is initially connected to the refrigerator, the Lock function is off.
- If you want to activate the Lock function to lock other buttons, press and hold the Door Alarm button for three seconds or more. The Lock icon will display and the Lock function is now enabled.
- When the Lock function is activated, no other buttons will work. The dispenser pad is also deactivated.
- To disable the Lock function, press and hold the Door Alarm button for approximately three seconds.

Display Off Mode

When the refrigerator is in the Display Off Mode, the display will remain off until a door is opened or a button is pressed. Once on, the display will remain on for 20 seconds.

Demo Mode (For Store Use Only)

The Demo Mode disables all cooling in the refrigerator and freezer sections to conserve energy while on display in a retail store. When activated, OFF will display on the control panel.

To deactivate:

With either refrigerator door opened, press and hold the Refrigerator Temp. and Ice Plus buttons at the same time for five seconds. The control panel will beep and the temperature settings will display to confirm that Demo Mode is deactivated. Use the same procedure to activate the Demo Mode .

Automatic Icemaker

Ice is made in the automatic icemaker and sent to the dispenser. The icemaker will produce 7 cubes per cycle - approximately 70-120 cubes in a 24-hour period, depending on freezer compartment temperature, room temperature, number of door openings and other operating conditions.

- It takes about 12 to 24 hours for a newly installed refrigerator to begin making ice. Wait 72 hours for full ice production to occur.
- Ice making stops when the ice storage bin is full. When full, the ice bin holds approximately 6 to 8 (12-16 oz) glasses of ice.
- To turn off the automatic icemaker, set the Ice ON/OFF button on the display to Ice Off . To turn on the automatic icemaker, set the ON/OFF button on the display to Ice On .
- The water pressure must be between 20 and 120 psi (138 – 827 kPa) on models without a water filter and between 40 and 120 psi on (276 – 827 kPa) models with a water filter to produce the normal amount and size of ice cubes.

When You Should Turn the Icemaker Off

Set the Ice ON/OFF Button to "Ice Off":

- When the water supply will be shut off for several hours.
- When the ice bin is removed for more than one or two minutes.
- When the refrigerator will not be used for several days.

NOTE: The ice bin should be emptied when the Ice ON/OFF button is set to the Ice Off mode.

Normal Sounds You May Hear

NOTE: Keeping the Ice ON/OFF button set to the Ice On mode before the water line is connected can damage the icemaker.

- You will hear the sound of cubes dropping into the bin and water running in the pipes as the icemaker refills.



WARNING

Personal Injury Hazard

DO NOT place fingers or hands on the automatic ice making mechanism while the refrigerator is plugged in.

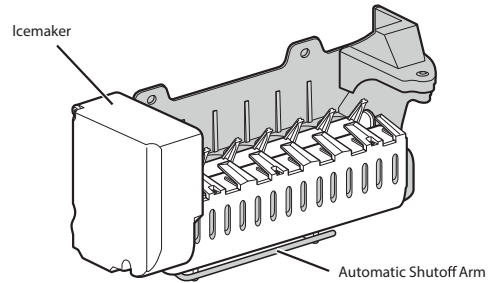

Preparing for Vacation

Set the Ice ON/OFF button to the Ice Off mode and shut off the water supply to the refrigerator.

NOTE: The ice bin should be emptied any time the Ice ON/OFF button is set to the Ice Off mode.

If the ambient temperature will drop below freezing, have a qualified technician drain the water supply system to prevent serious property damage due to flooding caused by ruptured water lines or connections.

Power Failure

During a power failure, ice may drop into the freezer compartment. Remove the ice storage bin and discard all the ice. Dry the storage bin and reinstall it. Once power is restored, crushed ice will be selected by default.

NOTE: Do not dispense ice continuously for more than 30 sec. Depress and release the dispenser pad for cycles of 30 seconds ON and 60 seconds OFF.

Automatic Icemaker (continued)



CAUTION

- The first ice and water dispensed may include particles or odor from the water supply line or the water tank.
- Throw away the first few batches of ice (about 24 cubes). This is also necessary if the refrigerator has not been used for a long time.
- Never store beverage cans or other items in the ice bin for the purpose of rapid cooling. Doing so may damage the icemaker or the containers may burst.
- If discolored ice is dispensed, check the water filter and water supply. If the problem continues, contact a qualified service center. Do not use the ice or water until the problem is corrected.
- Keep children away from the dispenser. Children may play with or damage the controls.
- The ice passage may become blocked with frost if only crushed ice is used. Remove the frost that accumulates by removing the ice bin and clearing the passage with a rubber spatula. Dispensing cubed ice can also help prevent frost buildup.
- Never use thin crystal glass or crockery to collect ice. Such containers may chip or break resulting in glass fragments in the ice.
- Dispense ice into a glass before filling it with water or other beverages. Splashing may occur if ice is dispensed into a glass that already contains liquid.
- Never use a glass that is exceptionally narrow or deep. Ice may jam in the ice passage and refrigerator performance may be affected.
- Keep the glass at a proper distance from the ice outlet. A glass held too close to the outlet may prevent ice from dispensing.
- To avoid personal injury, keep hands out of the ice door and passage.
- Never remove the dispenser cover.

Ice and Water Dispenser

* Depending on the model, some of the following functions may not be available.



CAUTION

Keep children away from the dispenser. Children may play with or damage the controls.

Dispenser structure

Water Switch

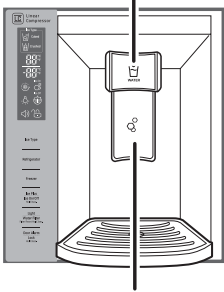

Ice Switch

Ice & Water Switch

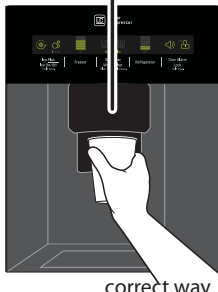

correct way

Using the dispenser

- To dispense cold water, push on the water switch with a glass.
- To dispense ice, push on the ice switch with a glass.



NOTE

- If discolored ice is dispensed, check the water filter and water supply. If the problem continues, contact a qualified service center. Do not use the ice or water until the problem is corrected.
- The dispenser will not operate when either of the refrigerator doors are open.
- If dispensing water or ice into a container with a small opening, place it as close to the dispenser as possible.
- Some dripping may occur after dispensing. Hold your cup beneath the dispenser for a few seconds after dispensing to catch all of the drops.

| | Incorrect Way | Correct Way |
|-------|---------------|-------------|
| Water | | |
| Ice | | |



CAUTION

Throw away the first few batches of ice (about 24 cubes). This is also necessary if the refrigerator has not been used for a long time.

Locking the dispenser

Press and hold the Alarm and Lock button simultaneously for 3 seconds to lock the dispenser and all the control panel functions. Follow the same instructions to unlock.

Cleaning the dispenser stand

The dispenser drip tray has no self-draining function. It should be cleaned regularly. (Models with a combined ice and water switch do not have a drip tray).

- 1 To remove, grip the tray with both hands and pull it out. Wipe out dirty areas and dry with a clean cloth.

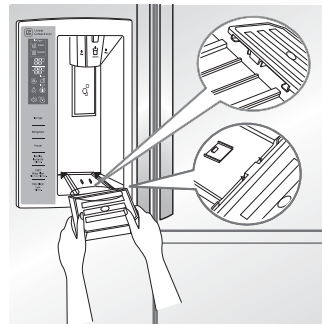

- 2 To reinstall the tray, slightly tilt the front of the tray and snap the ribs into the holes.

Storing Food

Food Preservation Location

Each compartment inside the refrigerator is designed to store different types of food.

Store your food in the optimal space to enjoy the freshest taste.

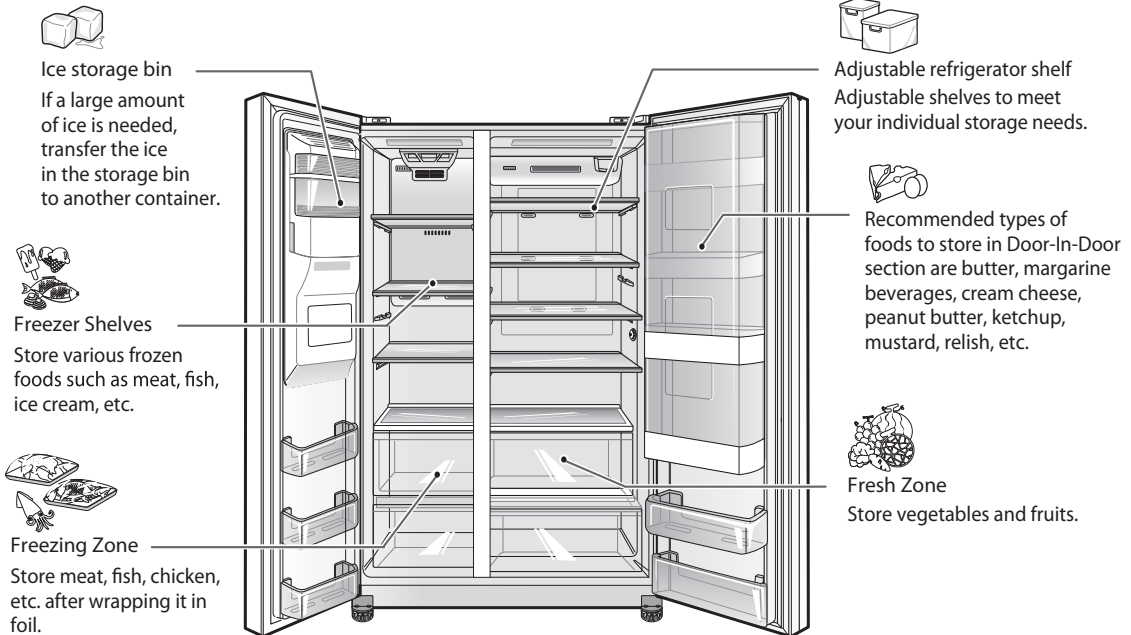

DOOR-IN-DOOR MODEL



CAUTION

- Do not store food with high moisture content towards the top of the refrigerator. The moisture could come in direct contact with the cold air and freeze.
- Wash food before storing it in the refrigerator. Vegetables and fruit should be washed, and food packaging should be wiped down to prevent adjacent foods from being contaminated.
- If the refrigerator is kept in a hot and humid place, frequent opening of the door or storing a lot of vegetables in the refrigerator may cause condensation to form. Wipe off the condensation with a clean cloth or a paper towel.
- If the refrigerator or freezer door is opened or closed too often, warm air may penetrate the refrigerator and raise its temperature. This can increase the running costs of the unit.
- Do not overfill or pack items too tightly into door bins. Doing so may cause damage to the bin or personal injury if items are removed with excessive force.
- Do not store glass containers in the freezer. Contents may expand when frozen, break the container and cause injury.



NOTE

- If you are leaving home for a short period of time, like a short vacation, the refrigerator should be left on. Refrigerated foods that are able to be frozen will stay preserved longer if stored in the freezer.
- If you are leaving the refrigerator turned off for an extended period of time, remove all food and unplug the power cord. Clean the interior, and leave the doors open to prevent fungi from growing in the refrigerator.

Storing Food

Food Preservation Location

Each compartment inside the refrigerator is designed to store different types of food.

Store your food in the optimal space to enjoy the freshest taste.

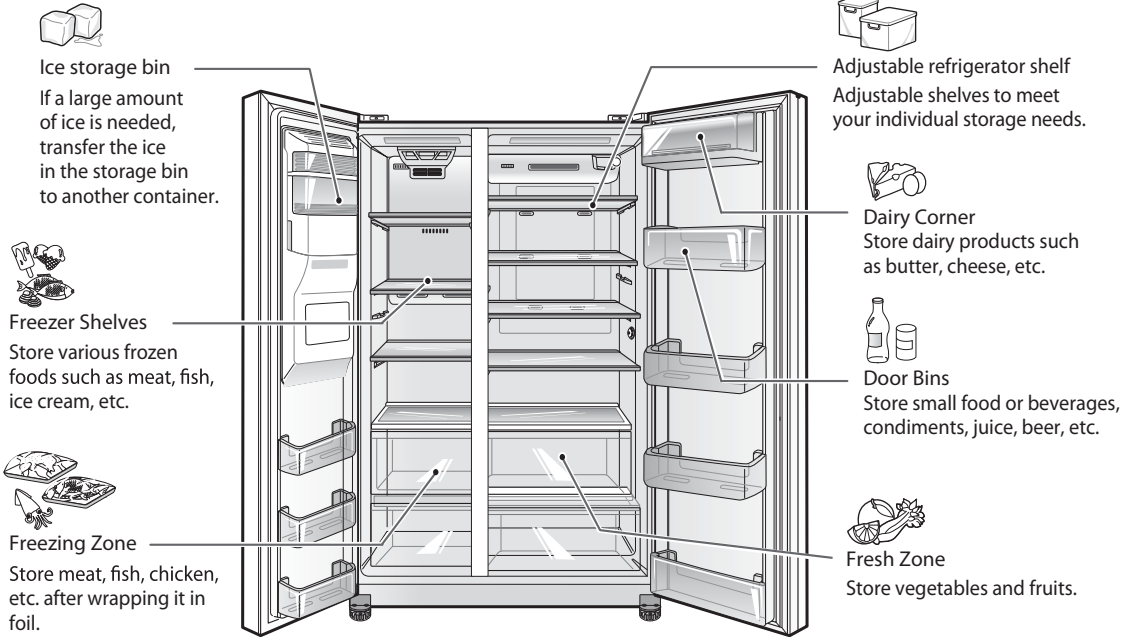

ALL STANDARD DOOR MODELS



CAUTION

- Do not store food with high moisture content towards the top of the refrigerator. The moisture could come in direct contact with the cold air and freeze.
- Wash food before storing it in the refrigerator. Vegetables and fruit should be washed, and food packaging should be wiped down to prevent adjacent foods from being contaminated.
- If the refrigerator is kept in a hot and humid place, frequent opening of the door or storing a lot of vegetables in the refrigerator may cause condensation to form. Wipe off the condensation with a clean cloth or a paper towel.
- If the refrigerator or freezer door is opened or closed too often, warm air may penetrate the refrigerator and raise its temperature. This can increase the running costs of the unit.
- Do not overfill or pack items too tightly into door bins. Doing so may cause damage to the bin or personal injury if items are removed with excessive force.
- Do not store glass containers in the freezer. Contents may expand when frozen, break the container and cause injury.



NOTE

- If you are leaving home for a short period of time, like a short vacation, the refrigerator should be left on. Refrigerated foods that are able to be frozen will stay preserved longer if stored in the freezer.
- If you are leaving the refrigerator turned off for an extended period of time, remove all food and unplug the power cord. Clean the interior, and leave the doors open to prevent fungi from growing in the refrigerator.
- Parts, features and options vary by model. Your model may not include every option.

Food Storage Tips

* The following tips may not be applicable depending on the model.

Wrap or store food in the refrigerator in airtight and moisture-proof material unless otherwise noted. This prevents food odor and taste transfer throughout the refrigerator. For dated products, check date code to ensure freshness.

| Food | How To |
|---|--|
| Butter or Margarine | Keep opened butter in a covered dish or closed compartment. When storing an extra supply, wrap in freezer packaging and freeze. |
| Cheese | Store in the original wrapping until you are ready to use it. Once opened, rewrap tightly in plastic wrap or aluminum foil. |
| Milk | Wipe milk cartons. For coldest milk, place containers on an interior shelf. |
| Eggs | Store in original carton on interior shelf, not on door shelf. |
| Fruit | Do not wash or hull the fruit until it is ready to be used. Sort and keep fruit in its original container, in a crisper, or store in a completely closed paper bag on a refrigerator shelf. |
| Leafy Vegetables | Remove store wrapping and trim or tear off bruised and discolored areas. Wash in cold water and drain. Place in plastic bag or plastic container and store in vegetable drawer. |
| Vegetables with skins (carrots, peppers) | Place in plastic bags or plastic container and store in vegetable drawer. |
| Fish | Store fresh fish and shellfish in the freezer section if they are not being consumed the same day of purchase. It is recommended to consume fresh fish and shellfish the same day purchased. |
| Leftovers | Cover leftovers with plastic wrap or aluminum foil, or store in plastic containers with tight lids. |
| Ice Cream | When storing frozen food like ice cream for a long period, place it on the freezer shelf, not in the door bins. |

Storing Frozen Food



NOTE

Check a freezer guide or a reliable cookbook for further information about preparing food for freezing or food storage times.

Freezing

Your freezer will not quick-freeze a large quantity of food. Do not put more unfrozen food into the freezer than will freeze within 24 hours (no more than 2 to 3 lbs. of food per cubic foot of freezer space). Leave enough space in the freezer for air to circulate around packages. Be careful to leave enough room at the front so the door can close tightly.

Storage times will vary according to the quality and type of food, the type of packaging or wrap used (how airtight and moisture-proof) and the storage temperature. Ice crystals inside a sealed package are normal. This simply means that moisture in the food and air inside the package have condensed, creating ice crystals.



NOTE

Allow hot foods to cool at room temperature for 30 minutes, then package and freeze. Cooling hot foods before freezing saves energy.

Storing Frozen Food (continued)

Packaging

Successful freezing depends on correct packaging. When you close and seal the package, it must not allow air or moisture in or out. If it does, you could have food odor and taste transfer throughout the refrigerator and could also dry out frozen food.

Packaging recommendations:

- Rigid plastic containers with tight-fitting lids
- Straight-sided canning/freezing jars
- Heavy-duty aluminum foil
- Plastic-coated paper
- Non-permeable plastic wraps
- Specified freezer-grade self-sealing plastic bags

Follow package or container instructions for proper freezing methods.

Do not use

- Bread wrappers
- Non-polyethylene plastic containers
- Containers without tight lids
- Wax paper or wax-coated freezer wrap
- Thin, semi-permeable wrap

Detaching and Assembling the Storage Bins

Fresh Zone Drawers

The Fresh Zone drawers provide storage for fruit and vegetables.

To remove the Fresh Zone drawers, pull out the drawer to full extension ①, lift the front up ②, and pull straight out.

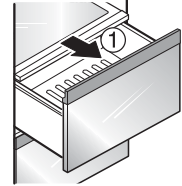

To install, slightly tilt up the front, insert the drawer into the frame and push it back into place.

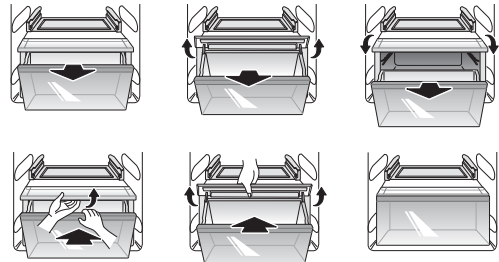
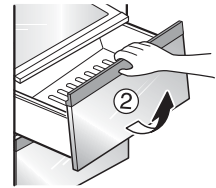

NOTE: When removing or installing the lower Fresh Zone drawer, lift the cover to help remove or insert the drawer.

CAUTION

- Use both hands to assemble and disassemble the Fresh Zone. The compartment is heavy when filled with food and may cause injury if dropped.
- Open the refrigerator door fully when disassembling or reassembling the Fresh Zone.

To Remove the Fresh Zone Cover

Hold the cover with both hands and pull it out.

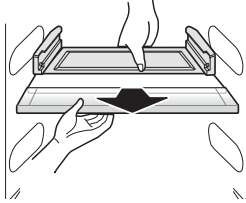

NOTE: Remove the Fresh Zone drawers before removing the Fresh Zone cover.

Door Bins

The door bins are removable for easy cleaning and adjustment.

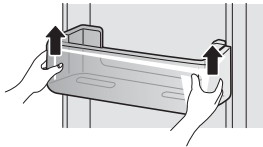

- 1 To remove the bin, simply lift the bin up and pull straight out.

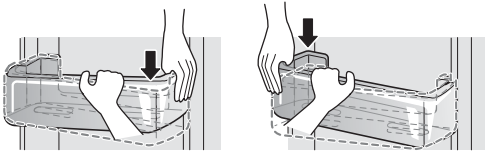

- 2 To replace the bin, slide it in above the desired support and push down one side at a time until it snaps into place.

! NOTE

Some bins may vary in appearance and will only fit in one location.

! CAUTION

- Do not apply excessive force while detaching or assembling the storage bins.
- Do not use the dishwasher to clean the storage bins and shelves.
- Regularly detach and wash the storage bins and shelves; they can become easily contaminated by the food.

Water Tank

! CAUTION: You will see the water tank while removing the Fresh Zone drawer. Do not remove the water tank or water leakage may occur. The water tank is not a removable part.

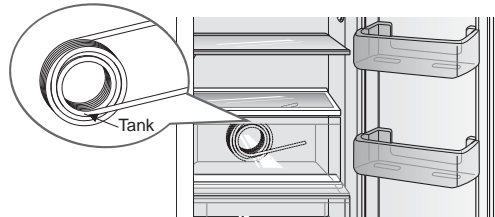

Dairy Corner (Basic Model)

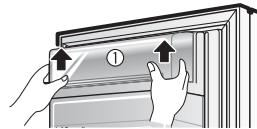

- 1 To remove the Dairy Corner, simply lift the bin up and pull straight out.
- 2 To replace the Dairy Corner, slide it in above the desired support and push down until it snaps into place.

NOTE: If you close the refrigerator door with the Dairy Corner open, the refrigerator door may not close properly. Make sure to close the Dairy Corner completely after use.

Door-in-Door (Door-in-Door Model)

The Door-in-Door compartment allows for easy access to commonly used food items. The outer Door-in-Door door includes three additional door bins.



Door-in-Door Compartment

To access the Door-in-Door compartment, lightly press the button on the right refrigerator door handle until you hear a click to open the door.

Door-in-Door Case

To open the Door-In-Door case, pull evenly on the marked area. The Door-In-Door Case is removable for easy cleaning and adjustment.

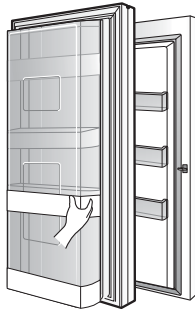

CAUTION: Remove contents from Door-in-Door case before disassembly.

- 1 To remove the Door-In-Door case, lift up and pull out.
- 2 To replace the Door-In-Door case, line the tabs on the Door-In-Door Case with the slots on the door and push down until it snaps into place.

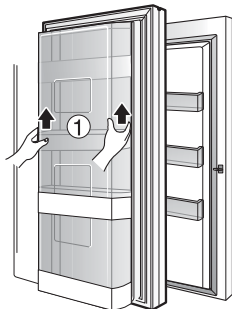

Door-in-Door Door Bins

The Door-in-Door inner and outer door bins are removable for easy cleaning.

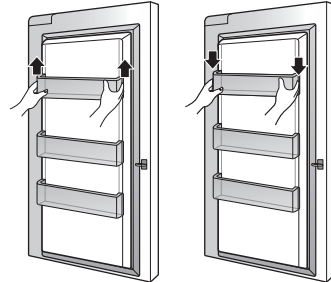

- 1 To remove the door bins, lift up and pull out.
- 2 To replace the door bins, slide the door bin in above the desired support and push down until it snaps into place.

Ice storage bin

The ice bin stores the ice cubes made by the icemaker. If you need to remove the ice storage bin, do so as follows:

NOTE: Use both hands to remove the ice bin to avoid dropping it.

Lift the ice storage bin slightly ① and pull it out ② as shown in the figure.

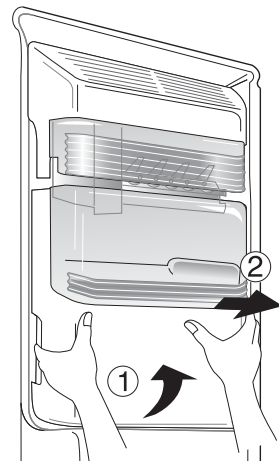

Adjusting the Refrigerator Shelves

The shelves in your refrigerator are adjustable to meet your individual storage needs.

Adjusting the shelves to fit items of different heights will make finding the exact item you want easier. Doing so will also reduce the amount of time the refrigerator door is open which will save energy.

Detaching the Shelf

- 1 Remove all items from the shelf. Lift the back of the shelf slightly to disengage the rail stops.
- 2 Holding the shelf with both hands, tilt the shelf and pull it out.

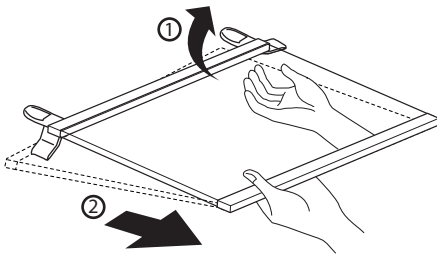

Assembling the Shelf

Tilt the front of the shelf up and guide the shelf into the slots at a desired height, keeping shelf holder down. ① Slide the shelf in, then lower the front of the shelf. ②

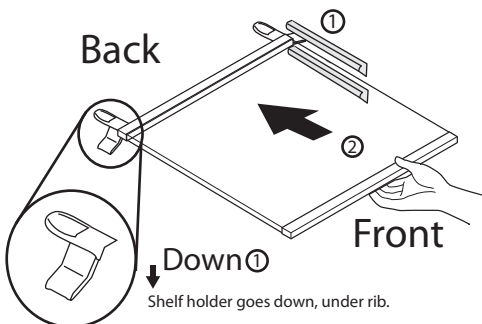

CAUTION

Make sure that shelves are level from one side to the other. Failure to do so may result in the shelf falling or food spilling.

Suggested Placement of Shelves

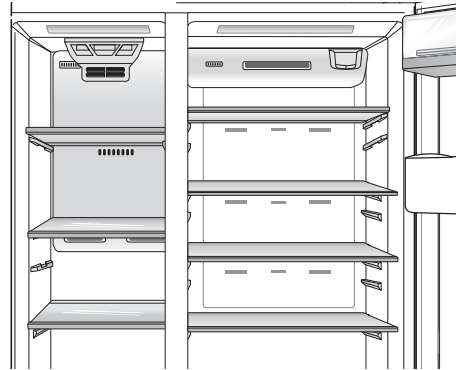

NOTE

- Parts, features and options vary by model. Your model may not include every option.
- Standard door models with a horizontal display have three refrigerator shelves.
- All models have two different sizes of freezer shelf. The larger shelf fits in the lower section of the freezer

CAUTION

- Do not clean glass shelves with warm water while they are cold. Shelves may break if exposed to sudden temperature changes or impact.
- Glass shelves are heavy. Use special care when removing them.

MAINTENANCE

Cleaning

- Both the refrigerator and freezer sections defrost automatically; however, clean both sections about once a month to prevent odors.
- Wipe up spills immediately.
- Always unplug the refrigeration before cleaning.

General Cleaning Tips

- Unplug refrigerator or disconnect power.
- Remove all removable parts, such as shelves, crispers, etc.
- Use a clean sponge or soft cloth and a mild detergent in warm water. Do not use abrasive or harsh cleaners.
- Hand wash, rinse and dry all surfaces thoroughly.

Exterior

Waxing external painted metal surfaces helps provide rust protection. Do not wax plastic parts. Wax painted metal surfaces at least twice a year using appliance wax (or auto paste wax). Apply wax with a clean, soft cloth.

For products with a stainless steel exterior, use a clean sponge or soft cloth and a mild detergent in warm water. Do not use abrasive or harsh cleaners. Dry thoroughly with a soft cloth.



CAUTION

- Do not use a rough cloth or sponge when cleaning the interior and exterior of the refrigerator.
- Do not place your hand on the bottom surface of the refrigerator when opening and closing.



WARNING

Use non-flammable cleaner. Failure to do so can result in fire, explosion, or death.

Inside Walls (allow freezer to warm up so the cloth will not stick)

To help remove odors, you can wash the inside of the refrigerator with a mixture of baking soda and warm water. Mix 2 tablespoons of baking soda to 1 quart of water (26 g soda to 1 liter water.) Be sure the baking soda is completely dissolved so it does not scratch the surfaces of the refrigerator.

Door Liners and Gaskets

Use a clean sponge or soft cloth and a mild detergent in warm water. Do not use cleaning waxes, concentrated detergents, bleaches, or cleaners containing petroleum on plastic refrigerator parts.

Plastic Parts (covers and panels)

Use a clean sponge or soft cloth and a mild detergent in warm water. Do not use window sprays, abrasive cleansers, or flammable fluids. These can scratch or damage the material.

Condenser Coils

Use a vacuum cleaner with an attachment to clean the condenser cover and vents. Do not remove the panel covering the condenser coil area.

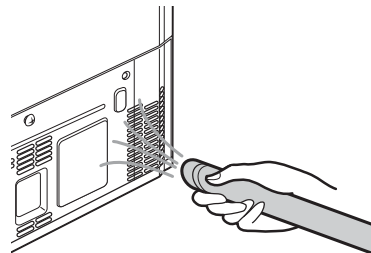

Replacing the Water Filter

It is recommended that you replace the water filter:

- Approximately every six months.
- When the water filter indicator turns on.
- When the water dispenser output decreases.
- When the ice cubes are smaller than normal.

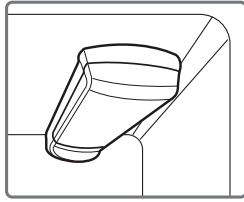

1 Remove the old water filter.

Lower or remove the top left shelf to allow the water filter to rotate all the way down.

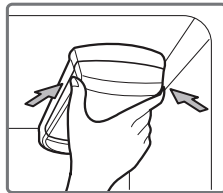

Pinch the sides to open the water filter cover.

NOTE: Replacing the water filter causes a small amount of water (around 1 oz. or 25 cc) to drain. Place a cup under the front end of the water filter cover to collect any leaking water. Hold the water filter upright, once it is removed, to prevent any remaining water from spilling out of the water filter.

Pull the water filter downward and turn it counterclockwise to pull it out. Make sure to rotate the filter down completely before pulling it out of the manifold hole.

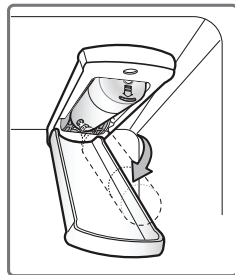

2 Replace with a new water filter.

Take the new water filter out of its packing and remove the protective cover from the o-rings. With water filter tabs in the horizontal position, push the new water filter into the manifold hole until it stops.

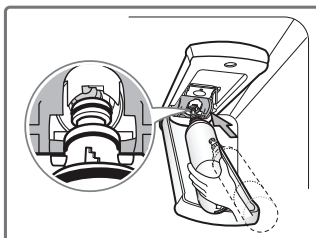

Rotate the water filter up into position and close the cover. The cover will click when closed correctly.

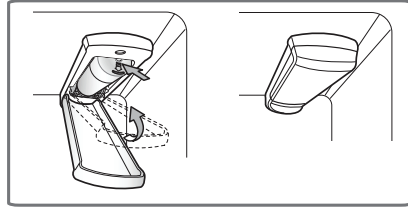

3 After the water filter is replaced, dispense 2.5 gallons of water (flush for approximately five minutes) to remove trapped air and contaminants from the system. Do not dispense the entire 2.5 gallon amount continuously. Depress and release the dispenser pad for cycles of 30 seconds ON and 60 seconds OFF.

! NOTE

- A water filter is not necessary to operate this refrigerator. Install a water filter to improve the quality of the ice and water dispensed.

! NOTE

- To purchase a replacement water filter:
Visit your local dealer or distributor
Web: Find Parts & Accessories from Support section of lg.com
Call : 1-800-243-0000 (USA)
1-888-542-2623 (Canada)
- Part number of the replacement water filter: ADQ73613401 (LT800P)
ADQ74793501(LT1000P)

NOTE

The following information applies only for the next models : LSXS26326*,LSXS26366*,LSXS26466*,LSXS26386*,LSXC22326*,GS73SGS,GS74SDS,GS73SDS,GS74SGS,GS73SDD,LSXS26336D,LSXS26336V,GS73SGG,LSXC22386*,LSXC22336*.

Performance Data Sheet

Use Replacement Cartridge : ADQ73613401(LT800P)

The concentration of the indicated substances in water entering the system was reduced to a concentration less than or equal to the permissible limit for water leaving the system as specified in NSF/ANSI Standard 42 and Standard 53.



System tested and certified by NSF International against NSF/ANSI Standard 42 and Standard 53 for the reduction of substances listed below.

Capacity 200 Gallons (757 Liters) Contaminant Reduction Determined by NSF testing.

| Contaminant Reduction | Average Influent | NSF specified Challenge Concentration | Average Reduction | Average Product Water Concentration | Max. Permissible Product Water Concentration | NSF Reduction Requirements |
|--|------------------|--|-------------------|-------------------------------------|--|----------------------------|
| Chlorine Taste and Odor | 2.0 mg/L | 2.0 mg/L ± 10 % | 97.5 % | 0.05 mg/L | N/A | ≥ 50 % |
| Nominal Particulate Class I >0.5µm to >1µm | 5,600,000 pts/mL | At least 10,000 particles/mL | 99.3 % | 73.000 pts/mL | N/A | ≥ 85 % |
| Asbestos | 170 MFL | 10 ⁷ to 10 ⁸ MFL; fibers greater than 10µm in length | >99 % | < 1 MFL | N/A | ≥ 99 % |
| Atrazine | 0.0087 mg/L | 0.009 mg/L ± 10 % | 94.2 % | 0.0005 mg/L | 0.003 mg/L | N/A |
| Benzene | 0.017 mg/L | 0.015 mg/L ± 10 % | 97.0 % | < 0.0005 mg/L | 0.005 mg/L | N/A |
| Carbofuran | 0.073 mg/L | 0.08 mg/L ± 10 % | 98.8 % | 0.001 mg/L | 0.04 mg/L | N/A |
| Lindane | 0.002 mg/L | 0.002 mg/L ± 10 % | 98.8 % | 0.00002 mg/L | 0.0002 mg/L | N/A |
| P-Dichlorobenzene | 0.263 mg/L | 0.225 mg/L ± 10 % | 99.6 % | 0.001 mg/L | 0.075 mg/L | N/A |
| Toxaphene | 0.015 mg/L | 0.015 mg/L ± 10 % | 93.5 % | 0.001 mg/L | 0.003 mg/L | N/A |
| 2,4-D | 0.25 mg/L | 0.210 mg/L ± 10 % | 99.5 % | 0.0012 mg/L | 0.07 mg/L | N/A |
| Lead pH6.5 | 0.150 mg/L | 0.15 mg/L ± 10 % | > 99.3 % | 0.001 mg/L | 0.010 mg/L | N/A |
| Lead pH8.5 | 0.150 mg/L | 0.15 mg/L ± 10 % | > 99.3 % | 0.001 mg/L | 0.010 mg/L | N/A |
| Mercury pH6.5 | 0.006 mg/L | 0.006 mg/L ± 10 % | 96.5 % | 0.0002 mg/L | 0.002 mg/L | N/A |
| Mercury pH8.5 | 0.0062 mg/L | 0.006 mg/L ± 10 % | 86.9 % | 0.0081 mg/L | 0.002 mg/L | N/A |
| Cyst* | 200,000 cysts/L | Minimum 50,000 cyst/L | > 99.99 % | < 1 cysts/L | N/A | ≥ 99.95 % |

* Based on the use of Cryptosporidium parvum oocysts

NOTE

The following information applies only for the next models : LSXS26336S

Use Replacement Cartridge: ADQ74793501 (LT1000P)

Capacity 200 Gallons (757 Liters) Substance Reduction Determined by NSF testing.

| Substance Reduction | Average Influent Challenge | NSF specified Challenge Concentration | Avg % Reduction | Average Product Water Concentration | Max Permissible Product Water Concentration | NSF Reduction Requirement |
|--|----------------------------|---|-----------------|-------------------------------------|---|---------------------------|
| Chlorine Taste and Odor | 2.0 µg/L | 2.0 µg/L± 10% | >97.5% | 0.050 µg/L | N/A | ≥ 50.00% |
| Nominal Particulate Class I, ≥ 0.5 to < 1.0 µm | 12,000,000 pts/mL | At least 10,000 particles/mL | 99.80% | 24,000 pts/ml | N/A | ≥ 85.00% |
| Asbestos | 180 MFL | 10 ⁷ to 10 ⁸ MFL; fibers greater than 10 µg/L in length | >99.00% | < 1 MFL | N/A | ≥ 99.00% |
| Atrazine | 8.5 µg/L | 9.0 µg/L ± 10% | >94.10% | 0.500 µg/L | 3.0 µg/L | NA |
| Benzene | 15.0 µg/L | 15.0 µg/L ± 10% | >96.60% | 0.510 µg/L | 5.0 µg/L | NA |
| Carbofuran | 74.0 µg/L | 80.0 µg/L ± 10% | 98.30% | 1.258 µg/L | 4.0 µg/L | NA |
| Lindane | 1.9 µg/L | 2.0 µg/L ± 10% | >99.00% | 0.019 µg/L | 0.2 µg/L | NA |
| P-Dichlorobenzene | 230.0 µg/L | 225.0 µg/L ± 10% | >99.80% | 0.460 µg/L | 75.0 µg/L | NA |
| 2,4-D | 210.0 µg/L | 210.0 µg/L ± 10% | >99.90% | 0.210 µg/L | 70.0 µg/L | NA |
| Lead @ pH 6.5 | 140.0 µg/L | 150.0 µg/L ± 10% | 99.60% | 0.560 µg/L | 10.0 µg/L | NA |
| Lead @ pH 8.5 | 150.0 µg/L | 150.0 µg/L ± 10% | >99.70% | < 0.500 µg/L | 10.0 µg/L | NA |
| Mercury @ pH 6.5 | 5.9 µg/L | 6.0 µg/L ± 10% | 91.00% | 0.531 µg/L | 2.0 µg/L | NA |
| Mercury @ pH 8.5 | 5.6 µg/L | 6.0 µg/L ± 10% | 92.50% | 0.420 µg/L | 2.0 µg/L | NA |
| Cyst* | 100,000 cysts/L | Minimum 50,000 cysts/L | >99.99% | 10 cysts/L | N/A | ≥ 99.95% |
| Atenolol | 240 ng/L | 200 ± 40% ng/L | > 95.50% | 10.80 ng/L | 30 ng/L | NA |
| Carbamazepine | 1600 ng/L | 1400 ± 40% ng/L | 98.40% | 25.60 ng/L | 200 ng/L | NA |
| DEET | 1600 ng/L | 1400 ± 40% ng/L | 97.10% | 46.40 ng/L | 200 ng/L | NA |
| Trimethoprim | 170 ng/L | 140 ± 40% ng/L | >96.80% | 5.44 ng/L | 20 ng/L | NA |
| Linuron | 160 ng/L | 140 ± 40% ng/L | >96.60% | 5.44 ng/L | 20 ng/L | NA |
| Phenytoin | 200 ng/L | 200 ± 40% ng/L | >94.80% | 10.40 ng/L | 30 ng/L | NA |
| Ibuprofene | 400 ng/L | 400 ± 40% ng/L | >94.50% | 22.00 ng/L | 60 ng/L | NA |
| Naproxen | 140 ng/L | 140 ± 40% ng/L | >96.10% | 5.46 ng/L | 20 ng/L | NA |
| Estrone | 120 ng/L | 140 ± 40% ng/L | >96.10% | 4.68 ng/L | 20 ng/L | NA |
| Bisphenol A | 2000 ng/L | 2000 ± 40% ng/L | >98.90% | 22.00 ng/L | 300 ng/L | NA |
| Nonyl Phenol | 1600 ng/L | 1400 ± 40% ng/L | >97.10% | 46.40 ng/L | 200 ng/L | NA |

* Based on the use of Cryptosporidium parvum oocysts

| Application Guidelines/ Water Supply Parameters | |
|--|-----------------------------|
| Service Flow | 0.5 gpm (1.9 lpm) |
| Water Supply | - Potable Water |
| Water Pressure | 20 -120 psi (138 - 827 kPa) |
| Water Temperature | 33°F - 100°F (0.6°C - 38°C) |

It is essential that the manufacturer's recommended installation, maintenance and filter replacement requirements be carried out for the product to perform as advertised.



NOTE

- While the testing was performed under standard laboratory conditions, actual performance may vary.

Replacement Cartridge:

- ADQ73613401(LT800P)
- ADQ74793501(LT1000P)

For estimated costs of replacement elements please call 01 8000 910 683 (24 hours per day/7 days per week) or visit our website at www.lge.com



WARNING

To reduce the risk associated with choking:

- Do not allow children under 3 years of age to have access to small parts during the installation of this product.

To reduce the risk associated with the ingestion of contaminants:

- Do not use with water that is microbiologically unsafe or of unknown quality without adequate disinfection before or after the system. Systems certified for cyst reduction may be used on disinfected water that may contain filterable cysts. EPA Establishment # 070595-MEX-001



CAUTION

To reduce the risk associated with property damage due to water leakage:

- Read and follow Use Instructions before installation and use of this system.
- Installation and use MUST comply with all state and local plumbing codes.
- Do not install if water pressure exceeds 120 psi (827 kPa). If your water pressure exceeds 80 psi (552 kPa), you must install a pressure limiting valve. Contact a plumbing professional if you are uncertain how to check your water pressure.
- Do not install where water hammer conditions may occur. If water hammer conditions exist you must install a water hammer arrester. Contact a plumbing professional if you are uncertain how to check for this condition.
- Do not install on hot water supply lines. The maximum operating water temperature of this filter system is 100°F (37.8°C).
- Protect filter from freezing. Drain filter when temperatures drop below 40°F (4.4°C).
- The disposable filter cartridge MUST be replaced every 6 months, at the rated capacity or if a noticeable reduction in flow rate occurs.
- Protect from freezing, remove filter cartridge when temperatures are expected to drop below 33° F (0.6 °C).
- Do not install systems in areas where ambient temperatures may go above 110° F (43.3° C). Where a backflow prevention device is installed on a water system, a device for controlling pressure due to thermal expansion must be installed.
- Ensure all tubing and fittings are secure and free of leaks.

Manufactured for LG Electronics by MCM Co., Ltd. 45-10, Nowon-Ri, Yiwol-Myun, Jinchun-Kun, Chung-Buk, Korea.

NSF International

RECOGNIZES

MCM Co., Ltd.
Republic of Korea

AS COMPLYING WITH NSF/ANSI 42, 53 AND ALL APPLICABLE REQUIREMENTS.
PRODUCTS APPEARING IN THE NSF OFFICIAL LISTING ARE
AUTHORIZED TO BEAR THE NSF MARK.



This certificate is the property of NSF International and must be returned upon request. For the most current and complete information, please access NSF's website (www.nsf.org).

October 4, 2013
Certificate# C0174200 - 02

A handwritten signature in black ink, appearing to read "David Purkiss".

David Purkiss
General Manager, Water Systems

SMART DIAGNOSIS

Should you experience any problems with your refrigerator, it has the capability of transmitting data via your telephone to the LG service center. This gives you the capability of speaking directly to our trained specialists. The specialist records the data transmitted from your machine and uses it to analyze the issue, providing a fast and effective diagnosis.

If you experience problems with your refrigerator, call to the LG service center. Only use the Smart Diagnosis™ feature when instructed to do so by the LG call center agent. The transmission sounds that you will hear are normal sounds similar to fax machine.

Smart Diagnosis™ cannot be activated unless your refrigerator is connected to power. If your refrigerator is unable to turn on, then troubleshooting must be done without using Smart Diagnosis.™

USING SMART DIAGNOSIS™

First, call to the LG service center. Only use the Smart Diagnosis™ feature when instructed to do so by the LG callcenter agent.

- 1 Lock the display. To lock the display, press and hold the Lock button for three seconds. (If the display has been locked for over five minutes, you must deactivate the lock and then reactivate it.)
- 2 Open the refrigerator door.

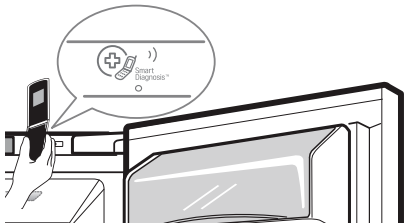

- 3 Hold the mouthpiece of your phone in front of the speaker that is located on the right hinge of the refrigerator door, when instructed to do so by the call center.

- 4 Press and hold the Freezer button for three seconds while continuing to hold your phone to the speaker.

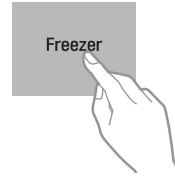

- 5 After you hear three beeps, release the Freezer button.
- 6 Keep the phone in place until the tone transmission has finished. This takes about three seconds, and the display will count down the time. Once the countdown is over and the tones have stopped, resume your conversation with the specialist, who will then be able to assist you in using the information transmitted for analysis.

NOTE

- For best results, do not move the phone while the tones are being transmitted.
- If the call center agent is not able to get an accurate recording of the data, you may be asked to try again.

NOTE

- Call quality differences by region may affect the function.
- Use the home telephone for better communication performance, resulting in better service.
- Bad call quality may result in poor data transmission from your phone to the machine, which could cause Smart Diagnosis™ to malfunction.

TROUBLESHOOTING

Common Product Questions

How do I unclog the ice dispenser chute?
Eliminate the frost or ice fragments by removing the ice bin and clearing the chute with a plastic utensil. Dispensing cubed ice can also help prevent frost or ice fragment buildup.

Make sure that the refrigerator doors are closed before attempting to dispense ice.

Why are ice crystals and frost forming on my frozen food?

When the doors are opened often or for long periods of time, warm, humid air enters the compartment. This raises the temperature and moisture level within the compartment. Increased moisture will lead to frost and condensation. To lessen the effect, reduce the frequency and duration of door openings.

How long will it take for my ice bin to fill completely?

Once the ice supply in the bin has been completely exhausted, it may take up to 90 minutes before additional ice is available, and approximately 72 hours to completely refill the bin.

Why does my ice and water taste unusual?

It is recommended that you replace the water filter:

- Approximately every 6 months.
- When the water filter indicator turns on.
- When the water dispenser output decreases.
- When the ice cubes are smaller than normal.

If your refrigerator was recently installed, dispense 2.5 gallons of water (flush for approximately 5 minutes) to remove trapped air and contaminants from the system. Do not dispense the entire 2.5 gallon amount continuously. Depress and release the dispenser pad for cycles of 30 seconds ON and 60 seconds OFF.

Noises You Might Hear

| Noise | Possible Causes | Solutions |
|---------------------------------|--|---|
| Clicking | The defrost control will click when the automatic defrost cycle begins and ends. The thermostat control (or refrigerator control on some models) will also click when cycling on and off. | Normal Operation |
| Rattling | Rattling noises may come from the flow of refrigerant, the water line on the back of the unit, or items stored on top of or around the refrigerator. | Normal Operation |
| | Refrigerator is not resting solidly on the floor. | Floor is weak or uneven or leveling legs need to be adjusted. See the Door Alignment section. |
| | Refrigerator with linear compressor was jarred while running. | Normal Operation |
| Whooshing | Evaporator fan motor is circulating air through the refrigerator and freezer compartments. | Normal Operation |
| | Air is being forced over the condenser by the condenser fan. | Normal Operation |
| Gurgling | Refrigerant flowing through the cooling system. | Normal Operation |
| Popping | Contraction and expansion of the inside walls due to changes in temperature. | Normal Operation |
| Sizzling | Water dripping on the defrost heater during a defrost cycle. | Normal Operation |
| Vibrating | If the side or back of the refrigerator is touching a cabinet or wall, some of the normal vibrations may make an audible sound. | To eliminate the noise, make sure that the sides and back cannot vibrate against any wall or cabinet. |
| Dripping | Water running into the drain pan during the defrost cycle. | Normal Operation |
| Pulsating or high-pitched sound | Your refrigerator is designed to run more efficiently to keep your food items at the desired temperature. The high efficiency compressor may cause your new refrigerator to run longer than your old one, but it is still more energy efficient than previous models. While the refrigerator is running, it is normal to hear a pulsating or high-pitched sound. | Normal Operation |

Before Calling for Service

Review this section before calling for service; doing so will save you both time and money.

Cooling

| Problem | Possible Causes | Solutions |
|---|--|--|
| Refrigerator and Freezer section are not cooling. | The refrigerator control is set to OFF (some models). | Turn the control ON. Refer to the Setting the Controls section for proper temperature settings. |
| | Refrigerator is set to Demo Mode | Demo Mode allows the lights and control display to work normally while disabling cooling, to save energy while the refrigerator is on the showroom floor. See the FAQs or the Setting the Controls section of this manual for instructions on how to disable Demo Mode. |
| | Refrigerator is in the defrost cycle. | During the defrost cycle, the temperature of each compartment may rise slightly. Wait 30 minutes and confirm the proper temperature has been restored once the defrost cycle has completed. |
| | Refrigerator was recently installed. | It may take up to 24 hours for each compartment to reach the desired temperature. |
| | Refrigerator was recently relocated. | If the refrigerator was stored for a long period of time or moved on its side, it is necessary for the refrigerator to stand upright for 24 hours before connecting it to power. |
| Cooling System runs too much. | Refrigerator is replacing an older model. | Modern refrigerators require more operating time but use less energy due to more efficient technology. |
| | Refrigerator was recently plugged in or power restored. | The refrigerator will take up to 24 hours to cool completely. |
| | The door is opened often or a large amount of food / hot food was added. | Adding food and opening the door warms the refrigerator, requiring the compressor to run longer in order to cool the refrigerator back down. In order to conserve energy, try to get everything you need out of the refrigerator at once, keep food organized so it is easy to find, and close the door as soon as the food is removed. (Refer to the Food Storage Guide .) |
| | Doors are not closed completely. | Firmly push the doors shut. If they will not shut all the way, see the Doors will not close completely or pop open section in Troubleshooting. |
| | Refrigerator is installed in a hot location. | The compressor will run longer under warm conditions. At normal room temperatures (70°F) expect your compressor to run about 40% to 80% of the time. Under warmer conditions, expect it to run even more often. The refrigerator should not be operated above 110°F. |
| | Condenser / back cover is clogged. | Use a vacuum cleaner with an attachment to clean the condenser cover and vents. Do not remove the panel covering the condenser coil area. |

Cooling

| Problem | Possible Causes | Solutions |
|---|---|---|
| Refrigerator or Freezer section is too warm. | Refrigerator was recently installed. | It may take up to 24 hours for each compartment to reach the desired temperature. |
| | The air vents are blocked. Cold air circulates from the freezer to the fresh food section and back again through air vents in the wall dividing the two sections. | Locate air vents by using your hand to sense airflow and move all packages that block vents and restrict airflow. Rearrange items to allow air to flow throughout the compartment. (Refer to the Airflow diagram in the Using Your Refrigerator section.) |
| | Doors are opened often or for long periods of time. | When the doors are opened often or for long periods of time, warm, humid air enters the compartment. This raises the temperature and moisture level within the compartment. To lessen the effect, reduce the frequency and duration of door openings. |
| | A large amount of food or hot food was added to either compartment. | Adding food warms the compartment requiring the cooling system to run. Allowing hot food to cool to room temperature before putting it in the refrigerator will reduce this effect. |
| | Doors not closed correctly. | See the Doors will not close correctly or pop open section in Parts & Features Troubleshooting. |
| | Temperature control is not set correctly. | If the temperature is too warm, adjust the control one increment at a time and wait for the temperature to stabilize. Refer to the Setting the Controls section for more information. |
| | Defrost cycle has recently completed. | During the defrost cycle, the temperature of each compartment may rise slightly and condensation may form on the back wall. Wait 30 minutes and confirm the proper temperature has been restored once the defrost cycle has completed. |
| Refrigerator or Freezer section is too cold. | Incorrect temperature control settings. | If the temperature is too cold, adjust the control one increment at a time and wait for the temperature to stabilize. Refer to the Setting the Controls section for more information. |
| Items in the Cheese & Butter and Condiment bins are not as cool as other items in the refrigerator. | The Cheese & Butter and Condiment bins will be slightly warmer than the refrigerator compartment. | This is normal. Items that you would like to keep cooler should be stored in the refrigerator section. |

Cooling

| Problem | Possible Causes | Solutions |
|---|---|---|
| Interior moisture buildup. | Doors are opened often or for long periods of time. | When the doors are opened often or for long periods of time, warm, humid air enters the compartment. This raises the temperature and moisture level within the compartment. To lessen the effect, reduce the frequency and duration of door openings. |
| | Doors not closed correctly. | See the Doors will not close correctly section in the Troubleshooting section. |
| | Weather is humid. | Humid weather allows additional moisture to enter the compartments when the doors are opened leading to condensation or frost. Maintaining a reasonable level of humidity in the home will help to control the amount of moisture that can enter the compartments. |
| | Defrost cycle recently completed. | During the defrost cycle, the temperature of each compartment may raise slightly and condensation may form on the back wall. Wait 30 minutes and confirm that the proper temperature has been restored once the defrost cycle has completed. |
| | Food is not packaged correctly. | Food stored uncovered or unwrapped, and damp containers can lead to moisture accumulation within each compartment. Wipe all containers dry and store food in sealed packaging to prevent condensation and frost. |
| Food is freezing in the refrigerator compartment. | Food with high water content was placed near an air vent. | Rearrange items with high water content away from air vents. |
| | Refrigerator temperature control is set incorrectly. | If the temperature is too cold, adjust the control one increment at a time and wait for the temperature to stabilize. Refer to the Setting the Controls section for more information. |
| | Refrigerator is installed in a cold location. | When the refrigerator is operated in temperatures below 41°F (5°C), food can freeze in the refrigerator compartment. The refrigerator should not be operated in temperatures below 55°F (13°C). |
| Frost or ice crystals form on frozen food (outside of package). | Door is opened frequently or for long periods of time. | When the doors are opened often or for long periods of time, warm, humid air enters the compartment. This raises the temperature and moisture level within the compartment. Increased moisture will lead to frost and condensation. To lessen the effect, reduce the frequency and duration of door openings. |
| | Door is not closing properly. | Refer to the Doors will not close correctly or pop open section in the Troubleshooting section. |

Cooling/Ice & Water

| Problem | Possible Causes | Solutions |
|--|--|--|
| Frost or ice crystals on frozen food (inside of sealed package). | Condensation from food with a high water content has frozen inside of the food package. | This is normal for food items with a high water content. |
| | Food has been left in the freezer for a long period of time. | Do not store food items with high water content in the freezer for a long period of time. |
| Icemaker is not making enough ice. | Demand exceeds ice storage capacity. | The icemaker will produce approximately 70-120 cubes in a 24 hour period. |
| | House water supply is not connected, valve is not turned on fully, or valve is clogged. | Connect the refrigerator to a cold water supply with adequate pressure and turn the water shutoff valve fully open. If the problem persists, it may be necessary to contact a plumber. |
| | Water fi lter has been exhausted. | Replacing the water fi lter is recommended: <ul style="list-style-type: none"> • Approximately every six months. • When the water fi lter indicator turns on. • When the water dispenser output decreases. • When the ice cubes are smaller than normal. |
| | Low house water supply pressure. | The water pressure must be between 20 and 120 psi (138 - 827 kPa) on models without a water fi lter and between 40 and 120 psi (276 - 827 kPa) on models with a water fi lter. If the problem persists, it may be necessary to contact a plumber. |
| | Reverse Osmosis fi ltration system is used. | Reverse osmosis fi ltration systems can reduce the water pressure below the minimum amount and result in icemaker issues. (Refer to Water Pressure section.) |
| | Tubing connecting refrigerator to house supply valve is kinked. | The tubing can kink when the refrigerator is moved during installation or cleaning resulting in reduced water fl ow. Straighten or repair the water supply line and arrange it to prevent future kinks. |
| | Doors are opened often or for long periods of time. | If the doors of the unit are opened often, ambient air will warm the refrigerator which will prevent the unit from maintaining the set temperature. Low ering the refrigerator temperature can help, as well as not opening the doors as frequently. |
| | Doors are not closed completely. | If the doors are not properly closed, ice production will be affected. See the Doors will not close completely or pop open section in Parts & Features Troubleshooting for more information. |
| The temperature setting for the freezer is too warm. | The recommended temperature for the freezer compartment for normal ice production is 0°F. If the freezer temperature is warmer, ice production will be affected. | |

Ice & Water

| Problem | Possible Causes | Solutions |
|--|---|---|
| Icemaker is not making enough ice (continued). | Refrigerator was recently installed or icemaker recently connected. | It may take up to 24 hours for each compartment to reach the desired temperature and for the icemaker to begin making ice. |
| | Icemaker not turned on. | Locate the icemaker ON/OFF button on the display and confirm that it is set to the Ice On mode. |
| | The ice detecting sensor is obstructed. | Foreign substances or frost on the ice-detecting sensor can interrupt ice production. Make sure that the sensor area is clean at all times for proper operation. |
| | The refrigerator is not connected to a water supply or the supply shutoff valve is not turned on. | Connect the refrigerator to the water supply and turn the water shutoff valve fully open. |
| | Icemaker shutoff (arm or sensor) obstructed. | If your icemaker is equipped with an ice shutoff arm, make sure that the arm moves freely. If your icemaker is equipped with the electronic ice shutoff sensor, make sure that there is a clear path between the two sensors. |
| Ice has bad taste or odor. | Water supply contains minerals such as sulfur. | A water filter may need to be installed to eliminate taste and odor problems. NOTE: In some cases, a filter may not help. It may not be possible to remove all minerals/odor/taste in all water supplies. |
| | Icemaker was recently installed. | Ice that has been stored for too long will shrink, become cloudy, and may develop a stale taste. Throw away old ice and make a new supply. |
| | The food has not been stored properly in either compartment. | Rewrap the food. Odors may migrate to the ice if food is not wrapped properly. |
| | The interior of the refrigerator needs to be cleaned. | See the Care and Cleaning section for more information. |
| | The ice storage bin needs to be cleaned. | Empty and wash the bin (discard old cubes). Make sure that the bin is completely dry before reinstalling it. |
| Icemaker is making too much ice. | Icemaker shutoff (arm/sensor) is obstructed | Empty the ice bin. If your icemaker is equipped with an ice shutoff arm, make sure that the arm moves freely. If your icemaker is equipped with the electronic ice shutoff sensor, make sure that there is a clear path between the two sensors. Reinstall the ice bin and wait 24 hours to confirm proper operation. |

Ice & Water

| Problem | Possible Causes | Solutions |
|-----------------------------|--|---|
| Ice is not dispensing. | Doors are not closed completely. | Ice will not dispense if any of the refrigerator doors are left open. |
| | Infrequent use of the dispenser. | Infrequent use of the ice dispenser will cause the cubes to stick together over time, which will prevent them from properly dispensing. Check the ice bin for ice cubes clumping/sticking together. If they are, break up the ice cubes to allow for proper operation. |
| | The delivery chute is clogged with frost or ice fragments. | Eliminate the frost or ice fragments by removing the ice bin and clearing the chute with a plastic utensil. Dispensing cubed ice can also help prevent frost or ice fragment buildup. |
| | The dispenser display is locked. | Press and hold the Lock button for three seconds to unlock the control panel and dispenser. |
| | Ice bin is empty. | It may take up to 24 hours for each compartment to reach the desired temperature and for the icemaker to begin making ice. Make sure that the shutoff (arm/sensor) is not obstructed. Once the ice supply in the bin has been completely exhausted, it may take up to 90 minutes before additional ice is available, and approximately 24 hours to completely refill the bin. |
| Water is dispensing slowly. | Water filter has been exhausted. | Replacing the water filter is recommended: <ul style="list-style-type: none"> • Approximately every six months. • When the water filter indicator turns on. • When the water dispenser output decreases. • When the ice cubes are smaller than normal. |
| | Reverse osmosis filtration system is used. | Reverse osmosis filtration systems can reduce the water pressure below the minimum amount and result in icemaker issues. If the problem persists, it may be necessary to contact a plumber or install a booster pump to compensate for the low pressure. |
| | Low house water supply pressure. | The water pressure must be between 20 and 120 psi (138 - 827 kPa) on models without a water filter and between 40 and 120 psi (276 - 827 kPa) on models with a water filter. If the problem persists, it may be necessary to contact a plumber or install a booster pump to compensate for the low pressure. |

Ice & Water

| Problem | Possible Causes | Solutions |
|--------------------------|---|--|
| Water is not dispensing. | New installation or water line recently connected. | Dispense 2.5 gallons of water (flush for approximately 5 minutes) to remove trapped air and contaminants from the system. Do not dispense the entire 2.5 gallon amount continuously. Depress and release the dispenser pad for cycles of 30 seconds ON and 60 seconds OFF. |
| | The dispenser panel is locked. | Press and hold the Lock button for three seconds to unlock the control panel and dispenser. |
| | Refrigerator or freezer doors are not closed properly. | Water will not dispense if any of the refrigerator doors are left open. |
| | Water filter has been recently removed or replaced. | After the water filter is replaced, dispense 2.5 gallons of water (flush for approximately 5 minutes) to remove trapped air and contaminants from the system. Do not dispense the entire 2.5 gallon amount continuously. Depress and release the dispenser pad for cycles of 30 seconds ON and 60 seconds OFF. |
| | Tubing connecting refrigerator to house supply valve is kinked. | The tubing can kink when the refrigerator is moved during installation or cleaning resulting in reduced water flow. Straighten or repair the water supply line and arrange it to prevent future kinks. |
| | The house water supply is not connected, the valve is not turned on fully, or the valve is clogged. | Connect the refrigerator to the water supply and turn the water shutoff valve fully open. If the problem persists, it may be necessary to contact a plumber. |
| Dispensing warm water. | Refrigerator was recently installed. | Allow 24 hours after installation for the water storage tank to cool completely. |
| | The water dispenser has been used recently and the storage tank was exhausted. | Depending on your specific model, the water storage capacity will range from approximately 20 to 30 oz. |
| | Dispenser has not been used for several hours. | If the dispenser has not been used for several hours, the first glass dispensed may be warm. Discard the first 10 oz. |
| | Refrigerator is connected to the hot water supply. | Make sure that the refrigerator is connected to a cold water pipe. WARNING: Connecting the refrigerator to a hot water line may damage the icemaker. |

Ice & Water/Parts & Features

| Problem | Possible Causes | Solutions |
|---|---|--|
| Water has bad taste or odor. | Water supply contains minerals such as sulfur. | A water filter may need to be installed to eliminate taste and odor problems. |
| | Water filter has been exhausted. | Replacing the water filter is recommended: <ul style="list-style-type: none"> • Approximately every six months. • When the water filter indicator turns on. • When the water dispenser output decreases. • When the ice cubes are smaller than normal. |
| | Refrigerator was recently installed. | Dispense 2.5 gallons of water (flush for approximately 5 minutes) to remove trapped air and contaminants from the system. Do not dispense the entire 2.5 gallon amount continuously. Depress and release the dispenser pad for cycles of 30 seconds ON and 60 seconds OFF. |
| Doors will not close correctly or pop open. | Food packages are blocking the door open. | Rearrange food containers to clear the door and door shelves. |
| | Ice bin, crisper cover, pans, shelves, door bins, or baskets are out of position. | Push bins all the way in and put crisper cover, pans, shelves and baskets into their correct positions. See the Using Your Refrigerator section for more information. |
| | The doors were removed during product installation and not properly replaced. | Remove and replace the doors according to the Removing and Replacing Refrigerator Handles and Doors section. |
| | Refrigerator is not leveled properly. | See Door Alignment in the Refrigeration Installation section to level refrigerator. |
| Doors are difficult to open. | The gaskets are dirty or sticky. | Clean the gaskets and the surfaces that they touch. Rub a thin coat of appliance polish or kitchen wax on the gaskets after cleaning. |
| | Door was recently closed. | When you open the door, warmer air enters the refrigerator. As the warm air cools, it can create a vacuum. If the door is hard to open, wait one minute to allow the air pressure to equalize, then see if it opens more easily. |
| Refrigerator wobbles or seems unstable. | Leveling legs are not adjusted properly. | Refer to the Leveling and Door Alignment section. |
| | Floor is not level. | It may be necessary to add shims under the leveling legs or rollers to complete installation. |
| Lights do not work. | LED interior lighting failure. | The lamps are LED interior lighting, and service should be performed by a qualified technician. |

Parts & Features

| Problem | Possible Causes | Solutions |
|--|--|--|
| The interior of the refrigerator is covered with dust or soot. | The refrigerator is located near a fire source, such as a fireplace, chimney, or candle. | Make sure that the refrigerator is not located near a fire source, such as a fireplace, chimney or candle. |

LG ELECTRONICS U.S.A., INC.
LG REFRIGERATOR LIMITED WARRANTY - U.S.A.

ARBITRATION NOTICE: THIS LIMITED WARRANTY CONTAINS AN ARBITRATION PROVISION THAT REQUIRES YOU AND LG TO RESOLVE DISPUTES BY BINDING ARBITRATION INSTEAD OF IN COURT, UNLESS YOU CHOOSE TO OPT OUT. IN ARBITRATION, CLASS ACTIONS AND JURY TRIALS ARE NOT PERMITTED. PLEASE SEE THE SECTION TITLED "PROCEDURE FOR RESOLVING DISPUTES" BELOW. Should your LG Refrigerator ("Product") fail due to a defect in materials or workmanship under normal and proper use, during the warranty period set forth below, LG Electronics ("LG") will, at its option, repair or replace the Product. This limited warranty is valid only to the original retail purchaser of the Product and applies only when purchased and used within the United States including U.S. Territories.

| WARRANTY PERIOD | | | |
|--|--|--|--|
| Refrigerator/Freezer | Sealed System (Condenser, Dryer, Connecting Tube and Evaporator) | Compressor | |
| One (1) year from the date of original retail purchase | Five (5) years from the date of original retail purchase | Five (5) years from the date of original retail purchase | Linear / Inverter Compressor Only : Parts Only for years 6-10 from the date of original retail purchase (Consumer will be charged for labor) |
| Parts and Labor (internal/ functional parts only) | Parts and Labor | Parts and Labor | |

- Replacement products and parts are warranted for the remaining portion of the original warranty period or ninety (90) days, whichever is greater.
- Replacement products and parts may be new, reconditioned, refurbished, or otherwise factory remanufactured.
- Proof of original retail purchase specifying the Product model and date of purchase is required to obtain warranty service under this limited warranty.

EXCEPT TO THE EXTENT PROHIBITED BY APPLICABLE LAW, ANY IMPLIED WARRANTY OF MERCHANTABILITY OR FITNESS FOR A PARTICULAR PURPOSE ON THE PRODUCT IS LIMITED IN DURATION TO THE DURATION OF THE ABOVE LIMITED WARRANTY. UNDER NO CIRCUMSTANCES SHALL LG OR ITS U.S. DISTRIBUTORS/DEALERS BE LIABLE FOR ANY INDIRECT, INCIDENTAL, CONSEQUENTIAL, SPECIAL, OR PUNITIVE DAMAGES, INCLUDING, WITHOUT LIMITATION, LOST GOODWILL, LOST REVENUES OR PROFITS, WORK STOPPAGE, IMPAIRMENT OF OTHER GOODS, COST OF REMOVAL AND REINSTALLATION OF THE PRODUCT, LOSS OF USE, OR ANY OTHER DAMAGES WHETHER BASED IN CONTRACT, TORT, OR OTHERWISE. LG'S TOTAL LIABILITY, IF ANY, SHALL NOT EXCEED THE PURCHASE PRICE PAID BY YOU FOR THE PRODUCT.

Some states do not allow the exclusion or limitation of incidental or consequential damages or limitations on how long an implied warranty lasts, so the above exclusions or limitations may not apply to you. This limited warranty gives you specific legal rights and you may also have other rights that vary from state to state.

THIS LIMITED WARRANTY DOES NOT COVER:

- Service trips to deliver, pick up, or install, educate how to operate, correct wiring, or correct unauthorized repairs.
- Damage or failure of the Product to perform during power failures and interrupted or inadequate electrical service.
- Damage or failure caused by leaky or broken water pipes, frozen water pipes, restricted drain lines, inadequate or interrupted water supply or inadequate supply of air.
- Damage resulting from operating the product in a corrosive atmosphere or contrary to the product owner's manual.
- Damage or failure to the Product caused by accidents, pests and vermin, lightning, wind, fire, floods, acts of God, or any other causes beyond the control of LG.
- Damage or failure caused by unauthorized modification or alteration, or if used for other the intended purpose.
- Damage or failure resulting from misuse, abuse, improper installation, repair, or maintenance. Improper repair includes use of parts not authorized by LG. Improper installation or maintenance includes installation or maintenance contrary to the Product owner's manual.
- Damage or failure caused by incorrect electrical current, voltage, or plumbing codes.
- Damage or failure caused by transportation and handling, including scratches, dents, chips, and/or other damage to the finish of the product, unless such damage is reported within one (1) week of delivery.
- Damage or missing items to any display, open box, or discounted Product.
- Refurbished Product or any Product sold "As Is", "Where Is", "With all Faults", or similar disclaimer.
- Products with original serial numbers that have been removed, altered, or cannot be readily determined.
- Increases in utility costs and additional utility expenses.
- Any noises associated with normal operation.
- Use of accessories (e.g., water filters, etc.), components, or consumable cleaning products that are not authorized by LG.
- Replacement or light bulbs, filters, or any consumable parts.
- When Product is used for other than normal and proper household use (e.g. commercial or industrial use, offices, and recreational facilities or vehicles) or contrary to the instructions outlined in the Product's owner's manual.
- Costs associated with removal and reinstallation of your Product for repairs.
- Shelves, door bins, drawers, handle and accessories, except for internal/functional parts covered under this limited warranty.

The cost of repair or replacement under these excluded circumstances shall be borne by the consumer.

TO OBTAIN WARRANTY SERVICE AND ADDITIONAL INFORMATION Call 1-800-243-0000 and select the appropriate option from the menu. Or visit our website at <http://www.lg.com>. Or by mail: LG Electronics Customer Service P.O. Box 240007 Huntsville, AL 35813 ATTN: CIC

PROCEDURE FOR RESOLVING DISPUTES:

ALL DISPUTES BETWEEN YOU AND LG ARISING OUT OF OR RELATING IN ANY WAY TO THIS LIMITED WARRANTY OR THE PRODUCT SHALL BE RESOLVED EXCLUSIVELY THROUGH BINDING ARBITRATION, AND NOT IN A COURT OF GENERAL JURISDICTION. BINDING ARBITRATION MEANS THAT YOU AND LG ARE EACH WAIVING THE RIGHT TO A JURY TRIAL AND TO BRING OR PARTICIPATE IN A CLASS ACTION.

Definitions. For the purposes of this section, references to "LG" mean LG Electronics U.S.A., Inc., its parents, subsidiaries and affiliates, and each of their officers, directors, employees, agents, beneficiaries, predecessors in interest, successors, assigns and suppliers; references to "dispute" or "claim" shall include any dispute, claim or controversy of any kind whatsoever (whether based in contract, tort, statute, regulation, ordinance, fraud, misrepresentation or any other legal or equitable theory) arising out of or relating in any way to the sale, condition or performance of the product or this Limited Warranty.

Notice of Dispute. In the event you intend to commence an arbitration proceeding, you must first notify LG in writing at least 30 days in advance of initiating the arbitration by sending a letter to LG at LG Electronics, USA, Inc. Attn: Legal Department- Arbitration 1000 Sylvan Ave, Englewood Cliffs 07632. You and LG agree to engage in good faith discussions in an attempt to amicably resolve your claim. The notice must provide your name, address, and telephone number; identify the product that is the subject of the claim; and describe the nature of the claim and the relief being sought. If you and LG are unable to resolve the dispute within 30 days, either party may proceed to file a claim for arbitration.

Agreement to Binding Arbitration and Class Action Waiver. Upon failure to resolve the dispute during the 30 day period after sending written notice to LG, you and LG agree to resolve any claims between us only by binding arbitration on an individual basis, unless you opt out as provided below. Any dispute between you and LG shall not be combined or consolidated with a dispute involving any other person's or entity's product or claim. More specifically, without limitation of the foregoing, any dispute between you and LG shall not under any circumstances proceed as part of a class or representative action. Instead of arbitration, either party may bring an individual action in small claims court, but that small claims court action may not be brought on a class or representative basis.

Arbitration Rules and Procedures. To begin arbitration of a claim, either you or LG must make a written demand for arbitration. The arbitration will be administered by the American Arbitration Association ("AAA") and will be conducted before a single arbitrator under the AAA's Consumer Arbitration Rules that are in effect at the time the arbitration is initiated (referred to as the "AAA Rules") and under the procedures set forth in this section. The AAA Rules are available online at www.adr.org/consumer. Send a copy of your written demand for arbitration, as well as a copy of this provision, to the AAA in the manner described in the AAA Rules. You must also send a copy of your written demand to LG at LG Electronics, USA, Inc. Attn: Legal Department- Arbitration 1000 Sylvan Avenue Englewood Cliffs, NJ 07632. If there is a conflict between the AAA Rules and the rules set forth in this section, the rules set forth in this section will govern. This arbitration provision is governed by the Federal Arbitration Act. Judgment may be entered on the arbitrator's award in any court of competent jurisdiction. All issues are for the arbitrator to decide, except that issues relating to the scope and enforceability of the arbitration provision and to the arbitrability of the dispute are for the court to decide. The arbitrator is bound by the terms of this provision.

Governing Law. The law of the state of your residence shall govern this Limited Warranty and any disputes between us except to the extent that such law is preempted by or inconsistent with applicable federal law.

Fees/Costs. You do not need to pay any fee to begin an arbitration. Upon receipt of your written demand for AAA unless you seek more than \$25,000 in damages, in which case the payment of these fees will be governed by the AAA Rules. Except as otherwise provided for herein, LG will pay AAA filing, administration and arbitrator fees for any arbitration initiated in accordance with the AAA Rules and this arbitration provision. If you prevail in the arbitration, LG will pay your attorneys' fees and expenses as long as they are reasonable, by considering factors including, but not limited to, the purchase amount and claim amount. Notwithstanding the foregoing, if applicable law allows for an award of reasonable attorneys' fees and expenses, an arbitrator can award them to the same extent that a court would. If the arbitrator finds either the substance of your claim or the relief sought in the demand is frivolous or brought for an improper purpose (as measured by the standards set forth in Federal Rule of Civil Procedure 11(b)), then the payment of all arbitration fees will be governed by the AAA Rules. In such a situation, you agree to reimburse LG for all monies previously disbursed by it that are otherwise your obligation to pay under the AAA Rules. Except as otherwise provided for, LG waives any rights it may have to seek attorneys' fees and expenses from you if LG prevails in the arbitration.

Hearings and Location. If your claim is for \$25,000 or less, you may choose to have the arbitration conducted solely on the basis of (1) documents submitted to the arbitrator, (2) through a telephonic hearing, or (3) by an in-person hearing as established by the AAA Rules. If your claim exceeds \$25,000, the right to a hearing will be determined by the AAA Rules. Any in-person arbitration hearings will be held at a location within the federal judicial district in which you reside unless we both agree to another location or we agree to a telephonic arbitration.

Opt Out. You may opt out of this dispute resolution procedure. If you opt out, neither you nor LG can require the other to participate in an arbitration proceeding. To opt out, you must send notice to LG no later than 30 calendar days from the date of the first consumer purchaser's purchase of the product by either: (i) sending an e-mail to optout@lge.com, with the subject line: "Arbitration Opt Out" or (ii) calling 1-800-980-2973. You must include in the opt out e-mail or provide by telephone: (a) your name and address; (b) the date on which the product was purchased; (c) the product model name or model number; and (d) the serial number (the serial number can be found (i) on the product; or (ii) online by accessing <https://www.lg.com/us/support/repair-service/schedule-repair-continued> and clicking on "Find My Model & Serial Number").

You may only opt out of the dispute resolution procedure in the manner described above (that is, by e-mail or telephone); no other form of notice will be effective to opt out of this dispute resolution procedure. Opting out of this dispute resolution procedure will not affect the coverage of the Limited Warranty in any way, and you will continue to enjoy the full benefits of the Limited Warranty. If you keep this product and do not opt out, then you accept all terms and conditions of the arbitration provision described above.

LG ELECTRONICS CANADA, INC.
LG REFRIGERATOR LIMITED WARRANTY - Canada

ARBITRATION NOTICE: THIS LIMITED WARRANTY CONTAINS AN ARBITRATION PROVISION THAT REQUIRES YOU AND LG TO RESOLVE DISPUTES BY BINDING ARBITRATION INSTEAD OF IN COURT, UNLESS THE LAWS OF YOUR PROVINCE OR TERRITORY DO NOT PERMIT THAT, OR, IN OTHER JURISDICTIONS, IF YOU CHOOSE TO OPT OUT. IN ARBITRATION, CLASS ACTIONS AND JURY TRIALS ARE NOT PERMITTED. PLEASE SEE THE SECTION TITLED "PROCEDURE FOR RESOLVING DISPUTES" BELOW.

Should your LG Refrigerator ("Product") fail due to a defect in materials or workmanship under normal and proper use, during the warranty period set forth below, LG Electronics Canada, Inc. ("LGECI") will, at its option, repair or replace the Product upon receipt of proof of the original retail purchase. This limited warranty is valid only to the original retail purchaser of the Product and applies only to a Product distributed, purchased and used within Canada, as determined at the sole discretion of LGECI.

| WARRANTY PERIOD (Note: If the original date of purchase cannot be verified, the warranty will begin sixty (60) days from the date of manufacture) | | | |
|--|---|--|---|
| Refrigerator | Sealed System (Condenser, Dryer, Connecting Tube and Evaporator) | | Linear / Inverter Compressor |
| One (1) year from the date of original retail purchase | One (1) year from the date of original retail purchase | Seven (7) years from the date of original retail purchase | Ten (10) years from the date of original retail purchase |
| Parts and Labor (internal/functional parts only) | Parts and Labor | Parts only (Consumer will be charged for labor) | Part only (Consumer will be charged for labor) |

- Replacement products and parts are warranted for the remaining portion of the original warranty period or ninety (90) days, whichever is greater.
- Replacement products and parts may be new, reconditioned, refurbished, or otherwise factory remanufactured, all at the sole discretion of LGECI.
- Proof of original retail purchase specifying the Product model and date of purchase is required to obtain warranty service under this Limited Warranty.

LGECI'S SOLE LIABILITY IS LIMITED TO THE LIMITED WARRANTY SET OUT ABOVE. EXCEPT AS EXPRESSLY PROVIDED ABOVE, LGECI MAKES NO, AND HEREBY DISCLAIMS, ALL OTHER WARRANTIES AND CONDITIONS RESPECTING THE PRODUCT, WHETHER EXPRESS OR IMPLIED, INCLUDING BUT NOT LIMITED TO, ANY IMPLIED WARRANTY OR CONDITION OF MERCHANTABILITY OR FITNESS FOR A PARTICULAR PURPOSE, AND NO REPRESENTATIONS SHALL BE BINDING ON LGECI. LGECI DOES NOT AUTHORIZE ANY PERSON TO CREATE OR ASSUME FOR IT ANY OTHER WARRANTY OBLIGATION OR LIABILITY IN CONNECTION WITH THE PRODUCT. TO THE EXTENT THAT ANY WARRANTY OR CONDITION IS IMPLIED BY LAW, IT IS LIMITED TO THE WARRANTY PERIOD SET OUT ABOVE. UNDER NO CIRCUMSTANCES SHALL LGECI, THE MANUFACTURER OR DISTRIBUTOR OF THE PRODUCT, BE LIABLE FOR ANY INCIDENTAL, CONSEQUENTIAL, SPECIAL, DIRECT, INDIRECT, PUNITIVE OR EXEMPLARY DAMAGES, INCLUDING, WITHOUT LIMITATION, LOSS OF GOODWILL, LOST PROFITS, LOSS OF ANTICIPATED PROFITS, LOST REVENUE, LOSS OF USE, OR ANY OTHER DAMAGE, WHETHER ARISING DIRECTLY OR INDIRECTLY FROM ANY CONTRACTUAL BREACH, FUNDAMENTAL BREACH, TORT OR OTHERWISE, OR FROM ANY ACTS OR OMISSIONS. LGECI'S TOTAL LIABILITY, IF ANY, SHALL NOT EXCEED THE PURCHASE PRICE PAID BY YOU FOR THE PRODUCT.

This Limited Warranty gives you specific legal rights. You may also have other rights that vary from province to province depending on applicable provincial laws. Any term of this Limited Warranty that negates or varies any implied condition or warranty under provincial law is severable where it conflicts with such provincial law without affecting the remainder of this warranty's terms.

THIS LIMITED WARRANTY DOES NOT COVER:

- Service trips to i) deliver, pick up, or install or; educate on how to operate the Product; ii) correct wiring or plumbing; or iii) correct unauthorized repairs or installations of the Product;
- Damage or failure of the Product to perform during power failures and interrupted or inadequate electrical service;
- Damage or failure caused by leaky or broken water pipes, frozen water pipes, restricted drain lines, inadequate or interrupted water supply or inadequate supply of air;
- Damage or failure resulting from operating the Product in a corrosive atmosphere or contrary to the instructions outlined in the Product's owner's manual;
- Damage or failure to the Product caused by accidents, pests and vermin, lightning, wind, fire, floods, acts of God, or any other causes beyond the control of LGECI or the manufacturer;
- Damage or failure resulting from misuse, abuse, improper installation, repair, or maintenance of the Product. Improper repair includes use of parts not authorized or specified by LGECI. Improper installation or maintenance includes installation or maintenance contrary to the Product's owner's manual;
- Damage or failure caused by unauthorized modification or alteration of the Product, or if used for other than the intended household purpose/use of the Product, or damage or failure resulting from any water leakage due to improper installation of the Product;
- Damage or failure caused by incorrect electrical current, voltage or plumbing codes;
- Damage or failure caused by use that is other than normal household use, including, without limitation, commercial or industrial use, including use in commercial offices or recreational facilities, or as otherwise outlined in the Product's owner's manual;
- Damage or failure caused by the use of any accessories, components or cleaning products, including, without limitation, water filters, that are not approved/authorized by LGECI;
- Replacement of the water filter cartridge due to water pressure that is outside the specified operating range or due to excessive sediment in the water supply;
- Damage or failure caused by transportation and handling, including scratches, dents, chips and/or other damage to the finish of the Product, **unless** such damage results from defects in materials or workmanship and is reported to LGECI within one (1) week of delivery of the Products;
- Damage or missing items to any display, open box, refurbished or discounted Product;
- Refurbished Product or any Product sold "As Is", "Where Is", "With all Faults", or any similar disclaimer;
- Products with original serial numbers that have been removed, altered or cannot be readily determined at the discretion of LGECI;
- Increases in utility costs and additional utility expenses in any way associated with the Product;

- Any noises associated with normal operation of the Product;
 - Replacement of light bulbs, filters, fuses or any other consumable parts;
 - Replacement of any part that was not originally included with the Product;
 - Costs associated with removal and/or reinstallation of the Product for repairs; and
 - Shelves, door bins, drawers, handle and accessories to the Product, except for internal/functional parts covered under this Limited Warranty.
- Coverage for "in Home" repairs, for products in-warranty, will be provided if the Product is within a 150 km radius from the nearest authorized service center (ASC), as determined by LG Canada. If your Product is located outside a 150 km radius from a ASC, as determined by LG Canada, it will be your responsibility to bring the Product, at your sole expense, to the ASC for in-warranty repair.

All costs and expenses associated with the above excluded circumstances, listed under the heading, This Limited Warranty Does Not Cover, shall be borne by the consumer. TO OBTAIN WARRANTY SERVICE AND ADDITIONAL INFORMATION, PLEASE CALL OR VISIT OUR WEBSITE: Call 1-888-542-2623 (7 A.M. to 12 A.M., 365 days a year) and select the appropriate option from the menu, or. Visit our website at <http://www.lg.com>

PROCEDURE FOR RESOLVING DISPUTES:

EXCEPT WHERE PROHIBITED AT LAW, ALL DISPUTES BETWEEN YOU AND LG ARISING OUT OF OR RELATING IN ANY WAY TO THIS LIMITED WARRANTY OR THE PRODUCT SHALL BE RESOLVED EXCLUSIVELY THROUGH BINDING ARBITRATION, AND NOT IN A COURT OF GENERAL JURISDICTION. EXCEPT WHERE PROHIBITED AT LAW, YOU AND LG BOTH IRREVOCABLY AGREE TO WAIVE THE RIGHT TO A JURY TRIAL AND TO BRING OR PARTICIPATE IN A CLASS ACTION.

Definitions. For the purposes of this section, references to "LG" mean LG Electronics Canada, Inc., its parents, subsidiaries and affiliates, and each of their officers, directors, employees, agents, beneficiaries, predecessors in interest, successors, assigns and suppliers; references to "dispute" or "claim" shall include any dispute, claim or controversy of any kind whatsoever (whether based in contract, tort, statute, regulation, ordinance, fraud, misrepresentation or any other legal or equitable theory) arising out of or relating in any way to the sale, condition or performance of the product or this Limited Warranty.

Notice of Dispute. In the event you intend to commence an arbitration proceeding, you must first notify LG in writing at least 30 days in advance of initiating the arbitration by sending a letter to LG Electronics, Canada, Inc., Attn: Legal Department-Arbitration, 20 Norelco Drive, North York, Ontario M9L 2X6. You and LG agree to engage in good faith discussions in an attempt to amicably resolve your claim. The notice must provide your name, address, and telephone number; identify the product that is the subject of the claim; and describe the nature of the claim and the relief being sought. If you and LG are unable to resolve the dispute within 30 days, either party may proceed to file a claim for arbitration.

Agreement to Binding Arbitration and Class Action Waiver. Upon failure to resolve the dispute during the 30 day period after sending written notice to LG, you and LG agree to resolve any claims between you and LG only by binding arbitration on an individual basis, unless you opt out as provided below, or you reside in a jurisdiction that prevents full application of this clause in the circumstances of the claims at issue (in which case if you are a consumer, this clause will only apply if you expressly agree to the arbitration). To the extent permitted by applicable law, any dispute between you and LG shall not be combined or consolidated with a dispute involving any other person's or entity's product or claim. More specifically, without limitation of the foregoing, except to the extent such a prohibition is not permitted at law, any dispute between you and LG shall not under any circumstances proceed as part of a class or representative action. Instead of arbitration, either party may bring an individual action in small claims court, but that small claims court action may not be brought on a class or representative basis except to the extent this prohibition is not permitted at law in your province or territory of jurisdiction as it relates to the claims at issue between you and LG.

Arbitration Rules and Procedures. To begin arbitration of a claim, either you or LG must make a written demand for arbitration. The arbitration will be private and confidential, and conducted on a simplified and expedited basis before a single arbitrator chosen by the parties under the provincial or territorial commercial arbitration law and rules of the province or territory of your residence. You must also send a copy of your written demand to LG at LG Electronics, Canada, Inc., Attn: Legal Department-Arbitration, 20 Norelco Drive, North York, Ontario M9L 2X6. This arbitration provision is governed by your applicable provincial or territorial commercial arbitration legislation. Judgment may be entered on the arbitrator's award in any court of competent jurisdiction. All issues are for the arbitrator to decide, except that, issues relating to the scope and enforceability of the arbitration provision and to the arbitrability of the dispute are for the court to decide. The arbitrator is bound by the terms of this provision.

Governing Law. The law of the province or territory of your residence shall govern this Limited Warranty and any disputes between you and LG except to the extent that such law is preempted by or inconsistent with applicable federal or provincial/territorial law. Should arbitration not be permitted for any claim, action, dispute or controversy between you and LG, you and LG agree to the exclusive jurisdiction of the courts of the province or territory of your residence for the resolution of the claim, action, dispute or controversy between you and LG.

Fees/Costs. You do not need to pay any fee to begin an arbitration. Upon receipt of your written demand for arbitration, LG will promptly pay all arbitration filing fees unless you seek more than \$25,000 in damages, in which case the payment of these fees will be governed by the applicable arbitration rules. Except as otherwise provided for herein, LG will pay all filing, administration and arbitrator fees for any arbitration initiated in accordance with the applicable arbitration rules and this arbitration provision. If you prevail in the arbitration, LG will pay your attorneys' fees and expenses as long as they are reasonable, by considering factors including, but not limited to, the purchase amount and claim amount. Notwithstanding the foregoing, if applicable law allows for an award of reasonable attorneys' fees and expenses, an arbitrator can award them to the same extent that a court would. If the arbitrator finds either the substance of your claim or the relief sought in the demand is frivolous or brought for an improper purpose (as measured by the applicable laws), then the payment of all arbitration fees will be governed by the applicable arbitration rules. In such a situation, you agree to reimburse LG for all monies previously disbursed by it that are otherwise your obligation to pay under the applicable arbitration rules. Except as otherwise provided for, LG waives any rights it may have to seek attorneys' fees and expenses from you if LG prevails in the arbitration.

Hearings and Location. If your claim is for \$25,000 or less, you may choose to have the arbitration conducted solely (1) on the basis of documents submitted to the arbitrator, (2) through a telephonic hearing, or (3) by an in-person hearing as established

by the applicable arbitration rules. If your claim exceeds \$25,000, the right to a hearing will be determined by the applicable arbitration rules. Any in-person arbitration hearings will be held at the nearest, most mutually-convenient arbitration location available within the province or territory in which you reside unless you and LG both agree to another location or agree to a telephonic arbitration.

Severability and Waiver. If any portion of this Limited Warranty (including these arbitration procedures) is unenforceable, the remaining provisions will continue in full force and effect to the maximum extent permitted by applicable law. Should LG fail to enforce strict performance of any provision of this Limited Warranty (including these arbitration procedures), it does not mean that LG intends to waive or has waived any provision or part of this Limited Warranty.

Opt Out. You may opt out of this dispute resolution procedure. If you opt out, neither you nor LG can require the other to participate in an arbitration proceeding. To opt out, you must send notice to LG no later than 30 calendar days from the date of the first consumer purchaser's purchase of the product by either (i) sending an e-mail to optout@lge.com, with the subject line: "Arbitration Opt Out;" or (ii) calling 1-800-980-2973. You must include in the opt out e-mail or provide by telephone: (a) your name and address; (b) the date on which the product was purchased; (c) the product model name or model number; and (d) the serial number (the serial number can be found (i) on the product; or (ii) online by accessing https://www.lg.com/ca_en/support/repair-service/schedule-repair and clicking on "Find My Model & Serial Number").

In the event that you "Opt Out", the law of the province or territory of your residence shall govern this Limited Warranty and any disputes between you and LG except to the extent that such law is preempted by or inconsistent with applicable federal or provincial/territorial law. Should arbitration not be permitted for any claim, action, dispute or controversy between you and LG, you and LG agree to attorn to the exclusive jurisdiction of the courts of the province or territory of your residence for the resolution of the claim, action, dispute or controversy between you and LG. You may only opt out of the dispute resolution procedure in the manner described above (that is, by e-mail or telephone); no other form of notice will be effective to opt out of this dispute resolution procedure. Opting out of this dispute resolution procedure will not affect the coverage of the Limited Warranty in any way, and you will continue to enjoy the full benefits of the Limited Warranty. If you keep this product and do not opt out, then you accept all terms and conditions of the arbitration provision described above.

Conflict of Terms. In the event of a conflict or inconsistency between the terms of this Limited Warranty and the End User License Agreement ("EULA") in regards to dispute resolution, the terms of this Limited Warranty shall control and govern the rights and obligations of the parties and shall take precedence over the EULA.



LG Customer Information Center

For inquiries or comments,
visit www.lg.com or call:

| | |
|----------------|----------------------|
| 1-800-243-0000 | USA, Consumer User |
| 1-888-865-3026 | USA, Commercial User |
| 1-888-542-2623 | CANADA |

Register your product Online!

www.lg.com