



Electric Free-Standing RANGES

SAFETY INFORMATION 3

USING THE RANGE

Surface Units..... 8

Oven Controls.....12

Special Features.....14

Sabbath Mode14

Oven Racks15

Aluminum Foil and Oven Liners.....15

Cookware.....15

Cooking Modes.....16

Cooking Guide17

CARE AND CLEANING

Cleaning the Range - Exterior.....18

Cleaning the Range - Interior21

Cleaning the Glass Cooktop..... 22

Oven Light..... 24

Oven Door 25

Storage Drawer..... 25

TROUBLESHOOTING TIPS..... 26

LIMITED WARRANTY 30

ACCESSORIES31

CONSUMER SUPPORT 32

OWNER'S MANUAL

Write the model and serial numbers here:

Model # _____

Serial # _____

You can find the rating label on the front behind the range drawer.

ESPAÑOL

Para consultar una version en español de este manual de instrucciones, visite nuestro sitio de internet GEAppliances.com.

THANK YOU FOR MAKING GE APPLIANCES A PART OF YOUR HOME.

Whether you grew up with GE Appliances, or this is your first, we're happy to have you in the family.

We take pride in the craftsmanship, innovation and design that goes into every GE Appliances product, and we think you will too. Among other things, registration of your appliance ensures that we can deliver important product information and warranty details when you need them.

Register your GE appliance now online. Helpful websites and phone numbers are available in the Consumer Support section of this Owner's Manual. You may also mail in the pre-printed registration card included in the packing material.



GE APPLIANCES

IMPORTANT SAFETY INFORMATION

READ ALL INSTRUCTIONS BEFORE USING THE APPLIANCE

▲WARNING Read all safety instructions before using the product. Failure to follow these instructions may result in fire, electrical shock, serious injury or death.

ANTI-TIP DEVICE

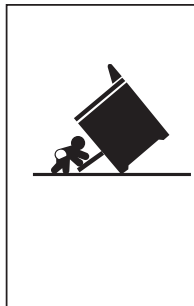

▲WARNING

Tip-Over Hazard

- A child or adult can tip the range and be killed.
- Install the anti-tip bracket to the wall or floor.
- Engage the range to the anti-tip bracket by sliding the range back such that the foot is engaged.
- Re-engage the anti-tip bracket if the range is moved.
- Failure to do so can result in death or serious burns to children or adults.

To reduce the risk of tipping the range, the range must be secured by a properly installed anti-tip bracket. See installation instructions shipped with the bracket for complete details before attempting to install.

For Free-Standing and Slide-In Ranges

To check if the bracket is installed and engaged properly, look underneath the range to see that the rear leveling leg is

engaged in the bracket. On some models, the storage drawer or kick panel can be removed for easy inspection. If visual inspection is not possible, slide the range forward, confirm the anti-tip bracket is securely attached to the floor or wall, and slide the range back so the rear leveling leg is under the anti-tip bracket.

If the range is pulled from the wall for any reason, always repeat this procedure to verify the range is properly secured by the anti-tip bracket.

Never completely remove the leveling legs or the range will not be secured to the anti-tip device properly.

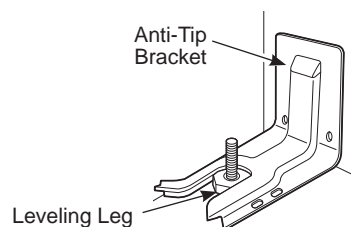

Free-Standing and Slide-In Ranges

▲WARNING GENERAL SAFETY INSTRUCTIONS

- Use this appliance only for its intended purpose as described in this Owner's Manual.
- **FIRE HAZARD:** Never leave the range unattended with the cooktop ON above a Lo setting. Keep flammable items away from the cooktop. Turn off all controls when done cooking. Failure to follow these instructions can result in fire, serious injury or death.
- Be sure your appliance is properly installed and grounded by a qualified installer in accordance with the provided installation instructions.
- Do not attempt to repair or replace any part of your range unless it is specifically recommended in this manual. All other servicing should be transferred to a qualified technician.
- Before performing any service, unplug the range or disconnect the power supply at the household distribution panel by removing the fuse or switching off the circuit breaker.
- Do not leave children alone—children should not be left alone or unattended in an area where an appliance is in use. They should never be allowed to climb, sit or stand on any part of the appliance.
- **▲CAUTION** Do not store items of interest to children above a range or on the backguard of a range—children climbing on the range to reach items could be seriously injured.
- Use only dry pot holders—moist or damp pot holders on hot surfaces may result in burns from steam. Do not let pot holders touch hot surface units or heating elements. Do not use a towel or other bulky cloth in place of pot holders.
- Never use your appliance for warming or heating the room.

READ AND SAVE THESE INSTRUCTIONS

IMPORTANT SAFETY INFORMATION

READ ALL INSTRUCTIONS BEFORE USING THE APPLIANCE

▲WARNING GENERAL SAFETY INSTRUCTIONS (Cont.)

- Do not touch the surface units, the heating elements or the interior surface of the oven. These surfaces may be hot enough to burn even though they are dark in color. During and after use, do not touch, or let clothing or other flammable materials contact the surface units, areas nearby the surface units or any interior area of the oven; allow sufficient time for cooling first. Other surfaces of the appliance may become hot enough to cause burns. Potentially hot surfaces include the cooktop, areas facing the cooktop, oven vent opening, surfaces near the opening and crevices around the oven door.
- Do not heat unopened food containers. Pressure could build up and the container could burst, causing an injury.
- Do not use any type of foil or liner to cover the oven bottom or anywhere in the oven, except as described in this manual. Oven liners can trap heat or melt, resulting in damage to the product and risk of shock, smoke or fire.
- Avoid scratching or impacting glass doors, cook tops or control panels. Doing so may lead to glass breakage. Do not cook on a product with broken glass. Shock, fire or cuts may occur.
- Cook food thoroughly to help protect against foodborne illness. Minimum safe food temperature recommendations can be found at IsItDoneYet.gov and fsis.usda.gov. Use a food thermometer to take food temperatures and check several locations.

▲WARNING KEEP FLAMMABLE MATERIALS AWAY FROM THE RANGE

Failure to do so may result in fire or personal injury.

- Do not store or use flammable materials in an oven or near the cooktop, including paper, plastic, pot holders, linens, wall coverings, curtains, drapes and gasoline or other flammable vapors and liquids.
- Never wear loose-fitting or hanging garments while using the appliance. These garments may ignite if they contact hot surfaces causing severe burns.
- Do not let cooking grease or other flammable materials accumulate in or near the range. Grease in the oven or on the cooktop may ignite.
- Clean ventilating hoods frequently. Grease should not be allowed to accumulate on the hood or filter.

▲WARNING IN THE EVENT OF A FIRE, TAKE THE FOLLOWING STEPS TO PREVENT INJURY AND FIRE SPREADING

- Do not use water on grease fires. Never pick up a flaming pan. Turn the controls off. Smother a flaming pan on a surface unit by covering the pan completely with a well-fitting lid, cookie sheet or flat tray. Use a multi-purpose dry chemical or foam-type fire extinguisher.
- If there is a fire in the oven during baking, smother the fire by closing the oven door and turning the oven off or by using a multi-purpose dry chemical or foam-type fire extinguisher.
- If there is a fire in the oven during self-clean, turn the oven off and wait for the fire to go out. Do not force the door open. Introduction of fresh air at self-clean temperatures may lead to a burst of flame from the oven. Failure to follow this instruction may result in severe burns.

READ AND SAVE THESE INSTRUCTIONS

IMPORTANT SAFETY INFORMATION

READ ALL INSTRUCTIONS BEFORE USING THE APPLIANCE

▲WARNING COOKTOP SAFETY INSTRUCTIONS

- Never leave the surface units unattended with the cooktop ON above a Lo setting. Boilovers cause smoking and greasy spillovers that may catch on fire.
- Always be present at the range when cooking with oil or grease. Surface cooking is an "attended" activity.
- Never leave oil unattended while frying. If allowed to heat beyond its smoking point, oil may ignite resulting in fire that may spread to surrounding cabinets. Use a deep fat thermometer whenever possible to monitor oil temperature.
- To avoid oil spillover and fire, use a minimum amount of oil when shallow pan-frying and avoid cooking frozen foods with excessive amounts of ice.
- Use proper pan size—select cookware having flat bottoms large enough to cover the surface heating element. The use of undersized cookware will expose a portion of the surface unit to direct contact and may result in ignition of clothing. Proper relationship of cookware to surface unit will also improve efficiency.
- Only certain types of glass, glass/ceramic, earthenware or other glazed containers are suitable for cooktop service; others may break because of the sudden change in temperature.
- To minimize the possibility of burns, ignition of flammable materials and spillage, the handle of a container should be turned toward the center of the range without extending over nearby surface units.
- When preparing flaming foods under a hood, turn the fan on.
- If power is lost to an electric cooktop while a surface unit is ON, the surface unit will turn back on as soon as power is restored. In the event of power loss, failure to turn all surface unit knobs to the OFF position may result in ignition of items on or near the cooktop, leading to serious injury or death.

▲WARNING COIL COOKTOP SAFETY INSTRUCTIONS

- Do not immerse or soak the removable surface units. Do not put them in a dishwasher. Do not self-clean the surface units in an oven. Doing so may cause them to fail presenting a burn or fire hazard.
- Do not use a surface unit (heating element) if it develops a glowing spot during use or shows other signs of damage. A glowing spot indicates the surface unit may fail and present a potential burn, fire, or shock hazard. Turn the surface unit off immediately and have it replaced by a qualified service technician.
- To avoid the possibility of a burn or electric shock, always be certain that the controls for all surface units are at the OFF position and all coils are cool before attempting to lift or remove a coil surface unit.
- Do not use aluminum foil to line drip pans. Foil can trap heat or melt, resulting in damage to the product and a shock or fire hazard.
- Be sure the drip pans are not covered and are in place. Their absence during cooking could damage range parts and wiring.

READ AND SAVE THESE INSTRUCTIONS

IMPORTANT SAFETY INFORMATION

READ ALL INSTRUCTIONS BEFORE USING THE APPLIANCE

▲WARNING RADIANT COOKTOP SAFETY INSTRUCTIONS

- Use care when touching the cooktop. The glass surface of the cooktop will retain heat after the controls have been turned off.
- Do not cook on a broken cooktop. If glass cooktop should break, cleaning solutions and spills may penetrate the broken cooktop and create a risk of electric shock. Contact a qualified technician immediately.
- Avoid scratching the glass cooktop. The cooktop can be scratched with items such as knives, sharp instruments, rings or other jewelry, and rivets on clothing.
- Do not place or store items that can melt or catch fire on the glass cooktop, even when it is not being used. If the cooktop is inadvertently turned on, they may ignite. Heat from the cooktop or oven vent after it is turned off may cause them to ignite also.
- Use ceramic cooktop cleaner and a non-scratch cleaning pad to clean the cooktop. Wait until the cooktop cools and the indicator light goes out before cleaning. A wet sponge or cloth on a hot surface can cause steam burns. Some cleaners can produce noxious fumes if applied to a hot surface. **NOTE:** Sugar spills are an exception. They should be scraped off while still hot using an oven mitt and a scraper. See the Cleaning the glass cooktop section for detailed instructions.
- Read and follow all instructions and warnings on the cleaning cream label.

▲WARNING OVEN SAFETY INSTRUCTIONS

- Stand away from the range when opening the oven door. Hot air or steam which escapes can cause burns to hands, face and/or eyes.
- Do not use the oven if a heating element develops a glowing spot during use or shows other signs of damage. A glowing spot indicates the heating element may fail and present a potential burn, fire, or shock hazard. Turn the oven off immediately and have the heating element replaced by a qualified service technician.
- Keep the oven vent unobstructed.
- Keep the oven free from grease buildup. Grease in the oven may ignite.
- Place oven racks in desired location while oven is cool. If rack must be moved while oven is hot, do not let pot holder contact hot heating element in oven.
- When using cooking or roasting bags in the oven, follow the manufacturer's directions.
- Pull the oven rack to the stop-lock position when loading and unloading food from the oven. This helps prevent burns from touching hot surfaces of the door and oven walls.
- Do not leave items such as paper, cooking utensils or food in the oven when not in use. Items stored in an oven can ignite.
- Never place cooking utensils, pizza or baking stones, or any type of foil or liner on the oven floor. These items can trap heat or melt, resulting in damage to the product and risk of shock, smoke or fire.

READ AND SAVE THESE INSTRUCTIONS

IMPORTANT SAFETY INFORMATION

READ ALL INSTRUCTIONS BEFORE USING THE APPLIANCE

▲WARNING SELF-CLEANING OVEN SAFETY INSTRUCTIONS (on some models)

The self-cleaning feature operates the oven at temperatures high enough to burn away food soils in the oven. Follow these instructions for safe operation.

- Do not touch oven surfaces during self-clean operation. Keep children away from the oven during self-cleaning. Failure to follow these instructions may cause burns.
- Before operating the self-clean cycle, remove pans, shiny metal oven racks and other utensils from the oven. Only gray porcelain-coated oven racks may be left in the oven. Do not use self-clean to clean other parts, such as drip pans or bowls.
- Before operating the self-clean cycle, wipe grease and food soils from the oven. Excessive amount of grease may ignite leading to smoke damage to your home.
- If the self-cleaning mode malfunctions, turn the oven off and disconnect the power supply. Have it serviced by a qualified technician.
- Do not clean the door gasket. The door gasket is essential for a good seal. Care should be taken not to rub, damage or move the gasket.
- Do not use oven cleaners. No commercial oven cleaner or oven liner protective coating of any kind should be used in or around any part of the oven.

How to Remove Protective Shipping Film and Packaging Tape

Carefully grasp a corner of the protective shipping film with your fingers and slowly peel it from the appliance surface. Do not use any sharp items to remove the film. Remove all of the film before using the appliance for the first time.

To assure no damage is done to the finish of the product, the safest way to remove the adhesive from packaging tape on new appliances is an application of a household liquid dishwashing detergent. Apply with a soft cloth and allow to soak.

NOTE: The adhesive must be removed from all parts. It cannot be removed if it is baked on.

READ AND SAVE THESE INSTRUCTIONS

Surface Units

▲ WARNING FIRE HAZARD: Never leave the range unattended with the cooktop ON above a Lo setting. Keep flammable items away from the cooktop. Turn off all controls when done cooking. Failure to follow these instructions can result in fire, serious injury or death.

Throughout this manual, features and appearance may vary from your model.

How to Set

Push the knob in and turn in either direction to the setting you want.

A surface ON indicator light will glow when any surface unit is on

For glass cooktop surfaces:

A **HOT COOKTOP** indicator light will:

- come on when the unit is hot to the touch.
- stay on even after the unit is turned off.
- stay on until the unit is cooled to approximately 150°F.

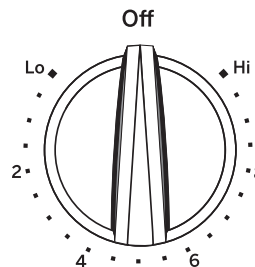

At both **OFF** and **HI** the control clicks into position. You may hear slight clicking sounds during cooking, indicating the control is maintaining your desired setting.

Be sure you turn the control knob to **OFF** when you finish cooking.

Coil Cooktops

Each coil surface unit uses "SENSI-TEMP TECHNOLOGY" to reduce the risk of cooktop oil and grease fires. This feature is located in the center of each surface unit. Power to the surface unit is temporarily interrupted when a pot or pan exceeds expected cooking

temperatures. Even after the surface units are turned off, the surface unit retains enough heat to continue cooking. To avoid overcooking, remove pans from the surface units when the food is cooked. Avoid placing anything on the surface unit until it has cooled completely.

Cookware for Coil Cooktops

The following information will help you choose cookware which will give good performance on coil cooktops.

NOTE: Follow all cookware manufacturer's recommendations when using any type of cookware on the coil cooktop.

Recommended

Stainless Steel

Thin unclad stainless steel will give poor performance.

Aluminum

Heavy weight recommended.

Good conductivity. Because of its low melting point, thin weight aluminum should not be used.

Copper Bottom

Enamel (painted) on Cast Iron

Cast Iron

Avoid/Not Recommended

Enamel (painted) on Steel

Glass-ceramic

Poor performance.

Stoneware

Poor performance.

Surface Units (Cont.)

Radiant Glass Cooktop

The radiant cooktop features heating units beneath a smooth glass surface.

NOTE: A slight odor is normal when a new cooktop is used for the first time. It is caused by the heating of new parts and insulating materials and will disappear in a short time.

NOTE: On models with light-colored glass cooktops, it is normal for the cooking zones to change color when hot or cooling down. This is temporary and will disappear as the glass cools to room temperature.

The surface unit will cycle on and off to maintain your selected control setting.

It is safe to place hot cookware on the glass surface even when the cooktop is cool.

Even after the surface units are turned off, the glass cooktop retains enough heat to continue cooking. To avoid overcooking, remove pans from the surface units when the food is cooked. Avoid placing anything on the surface unit until it has cooled completely.

- Water stains (mineral deposits) are removable using the cleaning cream or full-strength white vinegar.
- Use of window cleaner may leave an iridescent film on the cooktop. The cleaning cream will remove this film.
- Don't store heavy items above the cooktop. If they drop onto the cooktop, they can cause damage.
- Do not use the surface as a cutting board.



Never cook directly on the glass. Always use cookware.



Always place the pan in the center of the surface unit you are cooking on.



Do not slide cookware across the cooktop because it can scratch the glass—the glass is scratch-resistant, not scratch proof.

Temperature Limiter on Radiant Glass Cooktops

Every radiant surface unit has a temperature limiter.

The temperature limiter protects the glass cooktop from getting too hot.

The temperature limiter may cycle the surface units off for a time if:

- the pan boils dry.
- the pan bottom is not flat.
- the pan is off-center.
- there is no pan on the unit.

Surface Units (Cont.)

Cookware for Radiant Glass Cooktops

The following information will help you choose cookware which will give good performance on glass cooktops.

NOTE: Follow all cookware manufacturer's recommendations when using any type of cookware on the ceramic cooktop.

Recommended

Stainless Steel

Aluminum

Heavy weight recommended.

Good conductivity. Aluminum residues sometimes appear as scratches on the cooktop but can be removed if cleaned immediately. Because of its low melting point, thin weight aluminum should not be used.

Copper Bottom

Copper may leave residues which can appear as scratches. The residues can be removed, as long as the cooktop is cleaned immediately. However, do not let these pots boil dry. Overheated metal can bond to glass cooktops. An overheated copper bottom pot will leave a residue that will permanently stain the cooktop if not removed immediately.

Enamel (painted) on Cast Iron

Recommended if bottom of pan is coated.

Avoid/Not Recommended

Enamel (painted) on Steel

Heating empty pans can cause permanent damage to cooktop glass. The enamel can melt and bond to the ceramic cooktop.

Glass-ceramic

Poor performance. Will scratch the surface.

Stoneware

Poor performance. May scratch the surface.

Cast Iron

Not recommended—unless designed specifically for glass cooktops.

Poor conductivity and slow to absorb heat. Will scratch the cooktop surface.

Surface Units (Cont.)

More about Cookware

- Place only dry pans on the surface elements. Do not place lids on the surface elements, particularly wet lids. Wet pans and lids may stick to smooth surface when cool.
- Do not use woks that have support rings. This type of wok will not heat on the cooktop.
- We recommend that you use only a flat-bottomed wok. They are available at your local retail store. The bottom of the wok should have the same diameter as the surface element to ensure proper contact.
- Some special cooking procedures require specific cookware such as pressure cookers or deep-fat fryers. All cookware must have flat bottoms and be the correct size.

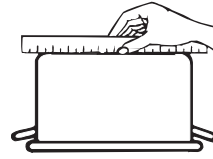

Check pans for flat bottoms by using a straight edge. You should not be able to pass a US nickel coin under the straight edge.



Do not place wet pans on the glass cooktop.



Pans with rounded, curved, ridged or warped bottoms are not recommended.



Do not use woks with support rings on the glass cooktop.



Use flat-bottomed woks on the glass cooktop.

Home Canning Tips

- Be sure the canner is centered over the surface unit.
- Make sure the canner is flat on the bottom.
- To prevent burns from steam or heat, use caution when canning.

Use recipes and procedures from reputable sources. These are available from manufacturers such as Ball® and Kerr® and the Department of Agriculture Extension Service.

Flat-bottomed canners are recommended. Use of water bath canners with rippled bottoms may extend the time required to bring the water to a boil.

Oven Controls

Throughout this manual, features and appearance may vary from your model.

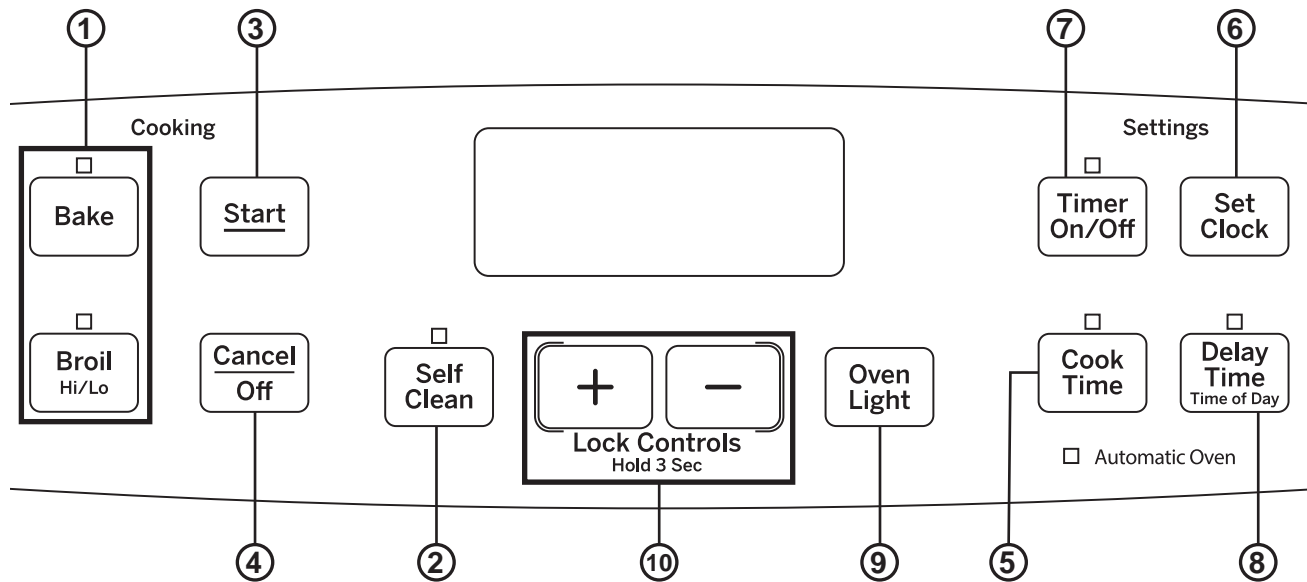

- 1. Traditional Cooking Modes:** Your oven has the following traditional cooking modes: Bake and Broil Hi/Lo. See the Cooking Modes section for more information.
- 2. Self Clean:** See the Cleaning the Oven section for important information about using this mode.
- 3. Start:** Must be pressed to start any cooking, cleaning, or timed function.
- 4. Cancel/Off:** Cancels ALL oven operations except the clock and timer.
- 5. Cook Time:** Counts down cooking time and turns off the oven when the cooking time is complete. Press the **Cook Time** pad, use the +/- pads to program a cooking time in hours and minutes, then press **Start**. This can only be used with Bake.
- 6. Clock:** Sets the oven clock time. Press the **Set Clock** or **Clock** pad and the +/- pads to program the clock. Press **Start** to save the time.
- 7. Timer:** Works as a countdown timer. Press the **Timer** pad and the +/- pads to program the time in hours and minutes. Press the **Start** pad. The timer countdown is complete. To turn the timer off press the **Timer** pad.
- 8. Delay Time:** Delays when the oven will turn on. Use this to set a time when you want the oven to start. Press the **Delay Time** pad and use the +/- pads to program the time of day for the oven to turn on then press **Start**. Press the desired cooking mode and temperature then press **Start**. A cook time may also be programmed if desired. Follow the directions under Cook Time for setting this feature. This can only be used with Bake and Self-Clean.
NOTE: When using the delay time feature, foods that spoil easily—such as milk, eggs, fish, stuffings, poultry and pork—should not be allowed to sit for more than 1 hour before or after cooking. Room temperature promotes the growth of harmful bacteria. Be sure that the oven light is off because heat from the bulb will speed harmful bacteria growth.
- 9. Oven Light:** Turns the oven light on or off.
- 10. Lock Controls:** Locks out the control so that pressing the pads does not activate the controls. Press and hold the +/- pads for three seconds to lock or unlock the control. **Cancel/Off** is always active, even when the control is locked.

Oven Controls (Cont.)

Oven Temperature Knob (on some models)

Turn the **OVEN TEMP** knob to the setting you want.

- Preheat the oven for 10 minutes for baking.
- For models that do not have the self clean feature the oven heating light comes on when the burner is on. It will cycle on and off during cooking.
- For models that have the self clean feature the oven heating light comes on when you set your oven temperature knob. The light will stay on until you set your knob back to the off position.

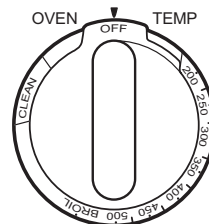

Front of OVEN TEMP knob
(knob appearance may vary)

To Adjust the Thermostat (on models with an OVEN TEMP Knob)

1. Pull the **Oven Temp** knob off the range and look at the back side. To make an adjustment, loosen (approximately one turn), but do not completely remove, the two screws on the back of the knob.
2. With the back of the knob facing you, hold the outer edge of the knob with one hand and turn the front of the knob with the other hand.
3. After the adjustment is made, retighten screws so they are snug, but be careful not to overtighten.
4. Replace the knob, matching the flat area of the knob to the shaft, and check performance.

To increase the oven temperature, move the top screw toward the right. You'll hear a click for each notch you move the knob.

To decrease the oven temperature, move the top screw toward the left.

Each click will change the oven temperature approximately 10°F. (Range is plus or minus 60°F from the arrow.) We suggest that you make the adjustment one click from the original setting and check oven performance before making any additional adjustments.

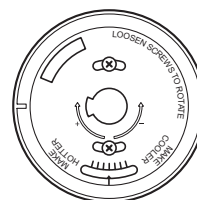

Back of OVEN TEMP knob
(knob appearance may vary)

Special Features

There are several different special features on your range. To change the settings of these special features:

- Press the **Bake** and **Broil** pads at the same time and hold for three seconds.
- “SF” will appear in the display.
- For instructions on how to select different features, refer to the section below that corresponds to the special feature of interest.
- When the change has been made, press the **Start** key to save the change and exit the special features menu.

Adjust the Oven Temperature

This feature allows the oven baking temperature to be adjusted up to 35°F hotter or down to 35°F cooler. Use this feature if you believe your oven temperature is too hot or too cold and wish to change it. This adjustment affects every cooking mode except broil.

After entering the special features menu, press the **Bake** pad to enter the temperature adjustment mode. A number between 35 and - 35 will display. Use the **+** or **-** pads to set the desired temperature adjustment. Press the **Start** pad to save the temperature adjustment.

12-Hour Auto Shut-Off

12-hour auto shut-off turns off the oven after 12 hours of continuous operation. The 12-hour auto shut-off may be “on” or “oFF.”. Enter into the special features menu as outlined above and repeatedly press the **Set Clock** pad until the desired setting is displayed. If your model does not have a **Set Clock** pad, then repeatedly press the **Cook Time** pad until the desired setting is displayed. Press the **Start** pad to save the setting.

Clock Display (on some models)

This feature specifies if the time of day is displayed. The clock display may be “on” or “oFF.” If your model has a **Set Clock** pad, see the Oven Controls section for instructions on adjusting the display. If your model does not have a **Set Clock** pad, enter into the special features menu as outlined above. Press the **Timer** pad to see the current setting. Press the **Timer** pad again to change the setting. Press the **Start** pad to save the display setting.

Increment/Decrement Speed

A setting (i.e. temperature) may be rapidly adjusted by pressing and holding the **+** or **-** pad. To adjust the increment/decrement speed, enter into the special features menu as outlined above. Press the **+** pad to increase the speed or press the **-** pad to decrease the speed. Settings vary from 1 (slowest) to 5 (fastest). Press the **Start** pad to save the speed setting.

Sabbath Mode

The Sabbath mode feature complies with standards set forth by Star K. Only continuous baking or timed baking is allowed in the Sabbath mode. All tones are disabled in the Sabbath mode; however the oven light is not disabled, so the light should be removed to ensure it does not come on when the door is opened. Cooking in the Sabbath mode is a two-step process, first the Sabbath mode must be set and then the bake mode must be set.

Setting the Sabbath Mode

Press the **Bake** and **Broil** pads at the same time and hold for three seconds. “SF” will appear in the display. Press the **Set Clock** pad until “SAb” appears in the display and then press **Start**. If your model does not have a **Set Clock** pad, then press the **Cook Time** pad until “SAb” appears in the display and then press **Start**. A single bracket “[” will appear in the display indicating that the Sabbath mode is set. Continuous bake or timed bake can now be set as outlined below.

Start a Continuous Bake

Press **Bake**, if a temperature other than 350F is desired then press the **+** or **-** pads to adjust the temperature in 25 degree increments, then press **Start**. After a delay, a second bracket “[” will appear in the display indicating that the oven is baking.

Adjusting the Temperature

Press **Bake**, then press the **+** or **-** pads to adjust the temperature in 25 degree increments, then press **Start**. An oven thermometer can be used if some indication of temperature setting is desired.

Start a Timed Bake

Press **Cook Time**, then press the **+** or **-** pads to adjust the cook time in one minute increments. Press **Bake**, if a temperature other than 350F is desired then press the **+** or **-** pads to adjust the temperature in 25 degree increments, then press **Start**. After a delay, a second bracket “[” will appear in the display indicating that the oven is baking. When the cook time expires the display will change back to a single bracket “[” indicating that the oven is no longer baking.

Sabbath Mode (Cont.)

Exit the Sabbath Mode

Exiting the Sabbath mode should be done after the Sabbath is over. Press **Cancel/Off** to end any bake mode that may be running. Press **Bake** and **Broil** pads at the same time and hold for three seconds. "SF" will appear in the display. Press the **Set Clock** pad until "On" appears in the display and then press **Start**. If your model does not have a Set Clock pad, then press the **Cook Time** pad until "On" appears in the display and then press **Start**. The display will change from a single bracket "]" to the time of day indicating that the Sabbath mode has been exited.

Sabbath Mode Power Outage Note

If a power outage occurs, the Sabbath mode will not resume when power is restored.

Oven Racks

Recommended rack positions for various types of foods are provided in the Cooking Guide. Adjusting rack position is one way to impact cooking results. For example, if you would prefer darker tops on cakes, muffins, or cookies, try moving food one rack position higher. If you find foods are too brown on top try moving them down next time.

When baking with multiple pans and on multiple racks, ensure there is sufficient space between pans to allow air flow. This may improve cooking evenness.

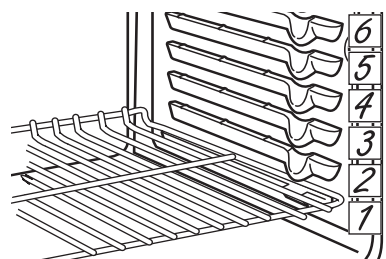

The number of rack positions may vary by model.

Aluminum Foil and Oven Liners

▲ CAUTION Do not use any type of foil or oven liner to cover the oven bottom. These items can trap heat or melt, resulting in damage to the product and risk of shock, smoke or fire. Damage from improper use of these items is not covered by the product warranty.

Foil may be used to catch spills by placing a sheet on a lower rack, several inches below the food. Do not use more foil than necessary and never entirely cover an oven rack with aluminum foil. Keep foil at least 1-1/2" from oven walls to prevent poor heat circulation.

Cookware

Cookware Guidelines

The material, finish, and size of cookware affect baking performance.

Dark, coated and dull pans absorb heat more readily than light, shiny pans. Pans that absorb heat more readily can result in a browner, crisper, and thicker crust. If using dark and coated cookware check food earlier than minimum cook time. If undesirable results are obtained with this type of cookware consider reducing oven temperature by 25° F next time.

Shiny pans can produce more evenly cooked baked goods such as cakes and cookies.

Glass and ceramic pans heat slowly but retain heat well. These types of pans work well for dishes such as pies and custards.

Air insulated pans heat slowly and can reduce bottom browning.

Keep cookware clean to promote even heating.

Cooking Modes

Your new oven has a variety of cooking modes to help you get the best results. These modes are described below. Refer to the Cooking Guide section for recommendations for specific foods. Remember, your new oven may perform differently than the oven it is replacing.

Baking Modes

When preparing baked goods such as cakes, cookies, and pastries always preheat the oven first. Follow recipe recommendations for food placement. If no guidelines are provided, center food in the oven.

Traditional Bake

The traditional bake mode is intended for single rack cooking. This mode uses heat primarily from the lower element but also from the upper element to cook food. To use this mode press the **Bake** pad, enter a temperature, and then press **Start**. Preheating is generally recommended when using this mode.

Broiling Modes

The oven must be closed during broiling. Monitor food closely while broiling. Use caution when broiling on upper rack positions as placing food closer to the broil element increases smoking, spattering, and the possibility of fats igniting. For best performance center food below the broil heating element. **Broiling on rack position 6 is not recommended.**

Try broiling foods that you would normally grill. Adjust rack positions to adjust the intensity of the heat to the food. Place foods closer to the broil element when a seared surface and rare interior is desired. Thicker foods and foods that need to be cooked through should be broiled on a rack position farther from the broiler or by using Broil Lo.

Broil Hi

The Traditional Broil Hi mode uses intense heat from the upper element to sear foods. Use Broil Hi for thinner cuts of meat and/or foods you prefer less done on the interior. To use this mode press the **Broil** pad once and then press **Start**. It is not necessary to preheat when using this mode.

Broil Lo

The Traditional Broil Lo mode uses less intense heat from the upper element to cook food thoroughly while also producing surface browning. Use Broil Lo for thicker cuts of meat and/or foods that you would like cooked all the way through. To use this mode press the **Broil** pad **twice** and then press **Start**. It is not necessary to preheat when using this mode.

Cooking Guide

FOOD TYPE	RECOMMENDED MODE(S)	RECOMMENDED RACK POSITION(S)	ADDITIONAL SUGGESTIONS
Baked Goods			
Layer Cakes, sheet cakes, bundt cakes, muffins, quick breads on a Single Rack	Bake	3	Use shiny cookware.
Layer cakes* on Multiple Racks	Bake	2 and 4	Ensure adequate airflow (see illustration below).
Chiffon cakes (angel food)	Bake	R	Use shiny cookware.
Cookies, biscuits, scones on a Single Rack	Bake	3	Use shiny cookware.
Cookies, biscuits, scones on Multiple Racks	Bake	2 and 4	Ensure adequate airflow.
Beef & Pork			
Hamburgers	Broil Hi	5	Use a broil pan; move food down for more doneness/less searing. Watch food closely when broiling. For best performance center food below the broil heating element.
Steaks & Chops	Broil Hi	5	Use a broil pan; move food down for more doneness/less searing. Watch food closely when broiling. For best performance center food below the broil heating element.
Roasts	Bake	2 or 3	Use a low sided pan such as a broil pan. Preheating is not necessary.
Poultry			
Whole chicken	Bake	3 or 4	Use a low sided pan such as a broil pan.
Bone-in chicken breasts, legs, thighs	Broil Hi	1	If breaded or coated in sauce avoid Broil Hi modes. Broil skin side down first. Watch food closely when broiling. For best performance when broiling, center food below the broil heating element.
	Broil Lo Bake	1 or 2	
Boneless chicken breasts	Broil Lo Bake	1 or 2	If breaded or coated in sauce avoid Broil Hi modes. Broil skin side down first. Watch food closely when broiling. For best performance when broiling, center food below the broil heating element
Whole turkey	Bake	1 or 2	Use a low sided pan such as a broil pan.
Turkey Breast	Bake	1 or 2	Use a low sided pan such as a broil pan.
Fish	Broil Lo	5 (1/2 thick or less) 4 (>1/2 inch)	Watch food closely when broiling. For best performance center food below the broil heating element.
Casseroles	Bake	3	
Frozen Convenience Foods			
Pizza, french fries, tator tots, chicken nuggets, appetizers on a Single Rack	Bake	3	Use shiny cookware.
Pizza, french fries, tator tots, chicken nuggets, appetizers on Multiple Racks	Bake	2 and 4	Use shiny cookware.

*When baking four cake layers at a time, use racks 2 and 4. Place the pans as shown so that one pan is not directly above another.

Cook food thoroughly to help protect against food borne illness. Minimum safe food temperature recommendations for food safety can be found at IsItDoneYet.gov. Make sure to use a food thermometer to take food temperatures.

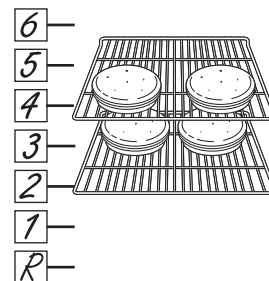

Rack position for baking 4 layer cakes.

Cleaning the Range – Exterior

Be sure all controls are off and all surfaces are cool before cleaning any part of the range.



⚠ WARNING

If your range is removed for cleaning, servicing or any reason, be sure the anti-tip device is reengaged properly when the range is replaced. Failure to take this precaution could result in tipping of the range and can result in death or serious burns to children or adults.

Control Knobs

The control knobs may be removed for easier cleaning. Make sure the knobs are in the **OFF** positions and pull them straight off the stems for cleaning.

The knobs can be cleaned in a dishwasher or they may also be washed with soap and water. Make sure the inside of the knobs are dry before replacing.

Replace the knobs, in the **OFF** position to ensure proper placement.

Control Panel

It's a good idea to wipe the control panel after each use. Clean with mild soap and water or vinegar and water, rinse with clean water and polish dry with a soft cloth.

Do not use abrasive cleansers, strong liquid cleansers, plastic scouring pads or oven cleaners on the control panel—they will damage the finish.

Oven Exterior

Do not use oven cleaners, abrasive cleansers, strong liquid cleansers, steel wool, plastic scouring pads, or cleaning powders on the interior or exterior of the oven. Clean with a mild soap and water or vinegar and water solution. Rinse with clean water and dry with a soft cloth. When cleaning surfaces, make sure that they are at room temperature and not in direct sunlight.

If stain on the door vent trim is persistent, use a mild abrasive cleaner and a sponge-scrubber for best results.

Spillage of marinades, fruit juices, tomato sauces and basting liquids containing acids may cause discoloration and should be wiped up immediately. Let hot surfaces cool, then clean and rinse.

Painted Surfaces

Painted surfaces include the sides of the range and the door, top of control panel and the drawer front. Clean these with soap and water or a vinegar and water solution.

Do not use commercial oven cleaners, cleaning powders, steel wool or harsh abrasives on any painted surface.

Stainless Steel Surfaces (on some models)

Do not use a steel wool pad; it will scratch the surface.

To clean the stainless steel surface, use warm sudsy water or a stainless steel cleaner or polish. Always wipe the surface in the direction of the grain. Follow the cleaner instructions for cleaning the stainless steel surface.

Cleaners with oxalic acid such as Bar Keepers Friend Soft Cleanser™ will remove surface rust, tarnish and small blemishes. Use only a liquid cleanser free of grit and rub in the direction of the brush lines with a damp, soft sponge.

To inquire about purchasing cleaning products including stainless steel appliance cleaner or polish, see the Accessories and Consumer Support sections at the end of this manual.

For easier cleaning, the control knobs may be removed by pulling them directly outwards once the knobs are in the **OFF** position. Do not pull knobs up or down or hang objects on them. This can damage the gas valve shaft. The knobs can be washed by hand with soap and water or in a dishwasher.

To replace knobs after cleaning, align the hole on the knob backside with the gas valve shaft and push inward until the knob is securely fastened. All knobs are interchangeable

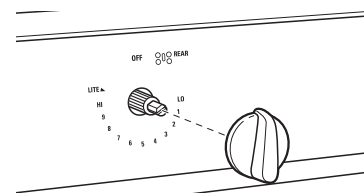

Surface burner knob

Cleaning the Range – Exterior (Cont.)

Porcelain Enamel Cooktop

The porcelain enamel finish is sturdy but breakable if misused. This finish is acid-resistant. However, any acidic foods spilled (such as fruit juices, tomato or vinegar) should not be permitted to remain on the finish.

If acids spill on the cooktop while it is hot, use a dry paper towel or cloth to wipe it up right away. When the surface has cooled, wash with soap and water. Rinse well.

For other spills such as fat splatterings, wash with soap and water or cleansing powders after the surface has cooled. Rinse well. Polish with a dry cloth.

Surface Units

▲ WARNING

- Be sure the controls are turned to OFF and the surface units are cool before attempting to remove them.
- Do not immerse the surface units in liquids of any kind.
- Do not clean the surface units in a dishwasher.
- Do not bend the surface unit plug terminals.
- Do not attempt to clean, adjust or in any way repair the plug-in receptacle.
- Do not pull on the SENSI-TEMP TECHNOLOGY sensor cap.

To clean the surface units, turn the control to the highest setting for a minute. The coils will burn off any soil. To clean the Sensi-Temp Technology Sensor cap, wipe with a damp sponge or cloth. For cooked-on food spills, remove the burner from the range and gently scrub the cap and supports with a damp plastic scouring pad. Do not use steel wool. Allow the burner to dry over night before re-installing it.

To remove a surface unit:

To remove the drip pans for cleaning, the surface units must be removed first.

1. Push the surface unit back toward the receptacle.
2. Lift the surface unit about 1 inch above the drip pan and pull it out.

Do not lift the surface unit more than 1 inch. If you do, it may not lie flat on the drip pan when you plug it back in.

NOTE: Repeated lifting of the surface unit more than 1 inch above the drip pan can permanently damage the receptacle.

To replace a surface unit:

1. Replace the drip pan into the recess in the cooktop. Make sure the opening in the pan lines up with the receptacle.
2. Insert the terminals of the surface unit through the opening in the drip pan and into the receptacle.
3. Push the surface unit in and down so it rests evenly in the cooktop.

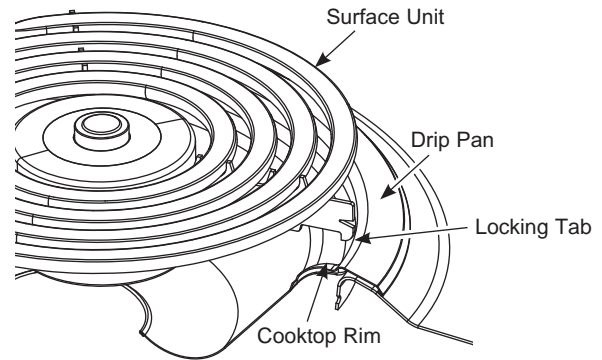

When properly seated, the locking tab should lock onto the cooktop rim through the notch in the drip pan.

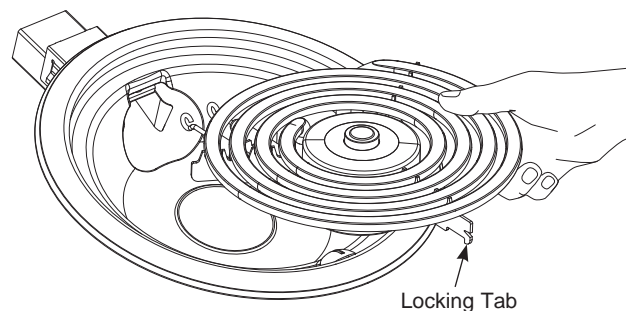
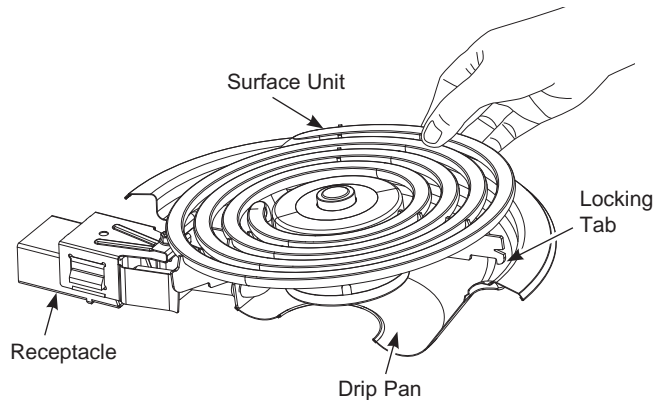

Cleaning the Range – Exterior (Cont.)

Drip Pans

Remove the surface units. Then lift out the drip pans.

For best results, clean the drip pans by hand. Place them in a covered container (or a plastic bag) with ¼ cup ammonia to loosen the soil. Rinse with clean water and polish with a clean soft cloth.

The drip pans may also be cleaned in a dishwasher.

Clean the area under the drip pans often. Built-up soil, especially grease, may catch fire.

Do not cover the drip pans with foil. Using foil so close to the receptacle could cause shock, fire or damage to the range.

NOTE: If your cooktop is equipped with shiny, silver-colored drip pans, do not clean them in the self-cleaning oven. Permanent damage to the finish can occur.

If your cooktop is equipped with black or gray porcelain-coated drip pans, they can be cleaned in the oven during the self-cleaning cycle. Before you begin a self-cleaning cycle, remove any heavy soil from the drip pans and place them on the porcelain-coated oven racks. Do not place the drip pans directly on the oven bottom. After the self-cleaning cycle is completed and the drip pans are cool, wipe them with a damp cloth to remove any remaining ash or residue.

Lift-Up Cooktop

The entire cooktop may be lifted up and supported in the up position for easier cleaning.

The surface units do not need to be removed; however, you may remove one to make raising the cooktop easier. There are two side supports that lock into position when the cooktop is lifted up.

After cleaning under the cooktop with hot, mild soapy

water and a clean cloth, lower the cooktop. Be careful not to pinch your fingers.

To lower the cooktop, push the rods back and gently lower the cooktop until it rests in place.

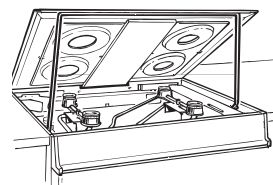

Be sure all surface units are turned off before raising the Cooktop.

Cleaning The Oven - Interior

The interior of your new oven can be cleaned manually or by using Self Clean.

Spillage of marinades, fruit juices, tomato sauces and basting liquids containing acids may cause discoloration and should be wiped up immediately. Let hot surfaces cool, then clean and rinse.

Manual Cleaning

Do not use oven cleaners, abrasive cleaners, strong liquid cleansers, steel wool, scouring pads, or cleaning powders on the interior of the oven. Clean with a mild

soap and water or vinegar and water solution. Rinse with clean water and dry with a soft cloth. When cleaning surfaces, make sure that they are at room temperature.

Self Clean Mode (on some models)

Read Self-Cleaning Oven Safety Instructions at the beginning of this manual before using Self Clean Mode. Self clean uses very high temperatures to clean the oven interior. You will need to lock the oven door when using this feature. Before operating the self-clean cycle, wipe up grease and soils from the oven. Remove all items from the oven other than enameled (dark color) racks. Shiny or silver racks and any cookware or other items should all be removed from the oven before initiating a self-clean cycle. Close the door. Latch the door.

NOTE: Never force the latch. If the oven is too hot, you will not be able to slide the latch. Allow the oven to cool. If your range has a knob turn knob to self clean position or if your range has an oven control press the **Self Clean** pad and a default self-clean time is displayed. The clean time can be changed to any time between 3:00 and 5:00 hours by using the +/- pads to enter a different time and pressing **Start**. For heavily soiled ovens, the maximum 5 hour clean time is recommended. If you wish to use the default time, press the **Start** pad immediately after pressing the **Self Clean** pad. The oven will turn off automatically when the self-clean cycle is complete and the self-clean light will be off. Slide the latch handle to the left as far as it will go and open the door. Never force the latch handle. Forcing the handle will damage the door lock mechanism. After the oven has cooled down wipe any ash out of the oven.

We recommend venting your kitchen with an open window or using a ventilation fan or hood during the first self-clean cycle.

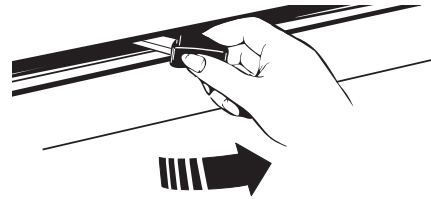

Soil on the front frame of the range and outside the gasket on the door will need to be cleaned by hand. Clean these areas with hot water, soap-filled steel-wool pads or cleansers such as Soft Scrub®. Rinse well with clean water and dry.

Do not clean the gasket. The fiberglass material of the oven door gasket cannot withstand abrasion. It is essential for the gasket to remain intact. If you notice it becoming worn or frayed, replace it.

Make sure the oven light bulb cover is in place and the oven light is off.

IMPORTANT: The health of some birds is extremely sensitive to the fumes given off during the self-cleaning cycle of any range. Move birds to another well-ventilated room.

To Stop a Self-Clean Cycle

Press **Cancel/Off** and wait for self clean light to go off. Wait until the oven has cooled below the locking temperature to unlatch the door. You will not be able to open the door right away unless the oven has cooled below the locking temperature.

Racks

All racks can be washed with warm, soapy water.

Racks may be more difficult to slide, especially after a self-clean. Put some vegetable oil on a soft cloth or paper towel and rub onto the left and right edges.

Oven Heating Elements

Do not clean the bake element or the broil element. Any soil will burn off when the elements are heated.

To clean the oven floor, gently lift the bake element. Clean the oven floor with warm, soapy water.

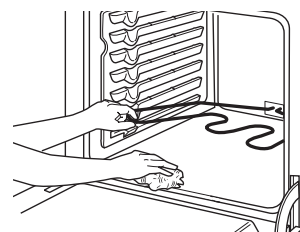

Gently lift the bake element

Cleaning the Glass Cooktop

Normal Daily Use Cleaning

ONLY use ceramic cooktop cleaner on the glass cooktop. Other creams may not be as effective.

To maintain and protect the surface of your glass cooktop, follow these steps:

1. Before using the cooktop for the first time, clean it with ceramic cooktop cleaner. This helps protect the top and makes cleanup easier.
2. Regular use of ceramic cooktop cleaner will help keep the cooktop looking new.
3. Shake the cleaning cream well. Apply a few drops of ceramic cooktop cleaner directly to the cooktop.
4. Use a paper towel or non-scratch cleaning pad for ceramic cooktops to clean the entire cooktop surface.

5. Use a dry cloth or paper towel to remove all cleaning residue. No need to rinse.

NOTE: It is very important that you **DO NOT** heat the cooktop until it has been cleaned thoroughly.

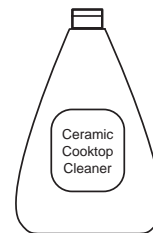

Clean your cooktop after each spill. Use ceramic cooktop cleaner.

Burned-On Residue

NOTE: DAMAGE to your glass surface may occur if you use scrub pads other than those recommended.

1. Allow the cooktop to cool.
2. Spread a few drops of ceramic cooktop cleaner on the entire burned residue area.
3. Using a non-scratch cleaning pad for ceramic cooktops, rub the residue area, applying pressure as needed.
4. If any residue remains, repeat the steps listed above as needed.
5. For additional protection, after all residue has been removed, polish the entire surface with ceramic cooktop cleaner and a paper towel.

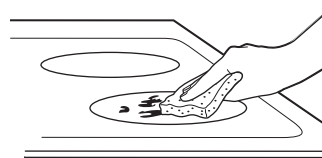

Use a non-scratch cleaning pad for ceramic cooktops.

Heavy, Burned-On Residue

1. Allow the cooktop to cool.
2. Use a single-edge razor blade scraper at approximately a 45° angle against the glass surface and scrape the soil. It will be necessary to apply pressure to the razor scraper in order to remove the residue.
3. After scraping with the razor scraper, spread a few drops of ceramic cooktop cleaner on the entire burned residue area. Use a non-scratch cleaning pad to remove any remaining residue.
4. For additional protection, after all residue has been removed, polish the entire surface with ceramic cooktop cleaner and a paper towel.

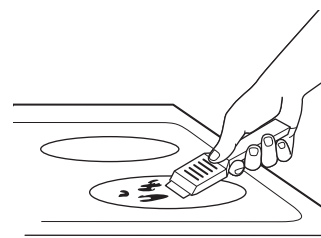

A non-scratch ceramic cooktop scraper and all recommended supplies are available through our Parts Center. See the Accessories and Consumer Support sections at the end of this manual.

NOTE: Do not use a dull or nicked blade.

Cleaning the Glass Cooktop (Cont.)

Metal Marks and Scratches

1. Be careful not to slide pots and pans across your cooktop. It will leave metal markings on the cooktop surface.

These marks are removable using the ceramic cooktop cleaner with a non-scratch cleaning pad for ceramic cooktops.

2. If pots with a thin overlay of aluminum or copper are allowed to boil dry, the overlay may leave black discoloration on the cooktop.

This should be removed immediately before heating again or the discoloration may be permanent.

NOTE: Carefully check the bottom of pans for roughness that would scratch the cooktop.

Cooktop Seal

To clean the cooktop seal around the edges of the glass, lay a wet cloth on it for a few minutes, then wipe clean with nonabrasive cleaners.

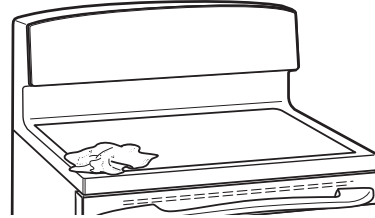

Damage from Sugary Spills and Melted Plastic

Special care should be taken when removing hot substances **to avoid permanent damage of the glass surface**. Sugary spillovers (such as jellies, fudge, candy, syrups) or melted plastics can cause pitting of the surface of your cooktop (not covered by the warranty) unless the spill is removed while still hot. Special care should be taken when removing hot substances.

Be sure to use a new, sharp razor scraper.

Do not use a dull or nicked blade.

1. Turn off all surface units. Remove hot pans.

2. Wearing an oven mitt:

- a. Use a single-edge razor blade scraper to move the spill to a cool area on the cooktop.
- b. Remove the spill with paper towels.

3. Any remaining spillover should be left until the surface of the cooktop has cooled.

4. Don't use the surface units again until all of the residue has been completely removed.

NOTE: If pitting or indentation in the glass surface has already occurred, the cooktop glass will have to be replaced. In this case, service will be necessary.

Oven Light

⚠ WARNING **SHOCK OR BURN HAZARD:** Before replacing oven light bulb, disconnect the electrical power to the range at the main fuse or circuit breaker panel. Failure to do so may result in electric shock or burn.

⚠ CAUTION **BURN HAZARD:** The glass cover and bulb should be removed when cool. Touching hot glass with bare hands or a damp cloth can cause burns.

Oven Light Replacement (on some models)

To remove:

1. Turn the glass cover counterclockwise 1/4 turn until the tabs of the glass cover clear the grooves of the socket. Wearing latex gloves may offer a better grip.
2. Remove the bulb by turning it counter-clockwise.

To replace:

1. Replace bulb with a new 40-watt appliance bulb. Insert the bulb and turn it clockwise until it is tight.
2. Place the tabs of the glass cover into the grooves of the socket. Turn the glass cover clockwise 1/4 turn.

For improved lighting inside the oven, clean the glass cover frequently using a wet cloth. This should be done when the oven is completely cool.

3. Reconnect electrical power to the oven.

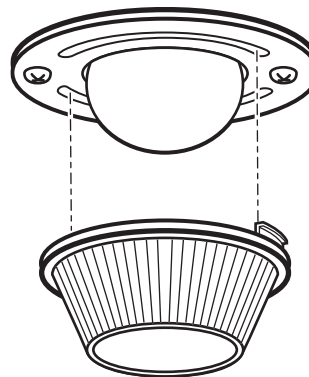

Glass cover on Self Clean models only.

Oven Door

The door is very heavy. Be careful when removing and lifting the door. Do not lift door by the handle.

▲ WARNING If improperly removed, oven door hinges may suddenly open and can cause personal injury to appendages near the hinge. Follow instructions below to avoid a risk of injury when removing and re-installing the oven door.

To Remove the Door:

1. Fully open the oven door.
2. On each hinge, slide the hinge lock up, making sure it snaps into its fully raised position.
3. Firmly grasp both sides of the door at near the top.
4. Close door until the top of the door is approximately 3" from the range frame.
5. Lift door up and away from the range until both hinge arms are clear of the slots in the range frame.

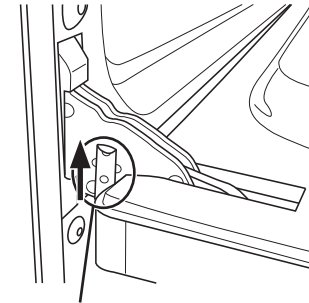

Pull hinge locks up to unlock

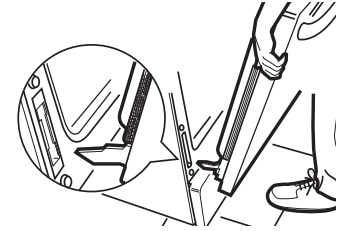

Removal position

To Replace the Door:

1. Firmly grasp both sides of the door near the top.
2. With the door at the same angle as the removal position, rest the notch in the bottom of the left hinge arm on the bottom edge of the left hinge slot. The notch in the hinge arm must be fully seated onto the bottom of the slot. Repeat for the right side.
3. Fully open the door. If the door will not fully open, the notches in the bottoms of the hinge arms are not seated correctly onto the bottom edge of the slot. Lift the door off the range and repeat Step 2.
4. Push the hinge locks down to the locked position
5. Close the oven door.

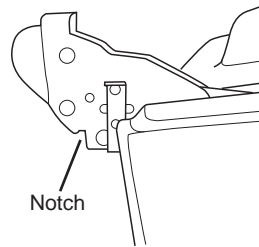

Notch

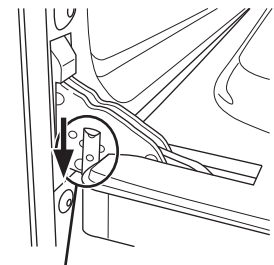

Push hinge locks down to lock

Storage Drawer (on some models)

To remove the drawer:

1. Pull the drawer out until it stops.
2. Lift the front of the drawer until the stops clear the guides.
3. Remove the drawer.

To replace the drawer:

1. Place the drawer rails on the guides.
2. Push the drawer back until it stops.
3. Lift the front of the drawer and push back until the stops clear the guides.
4. Lower the front of the drawer and push back until it closes.

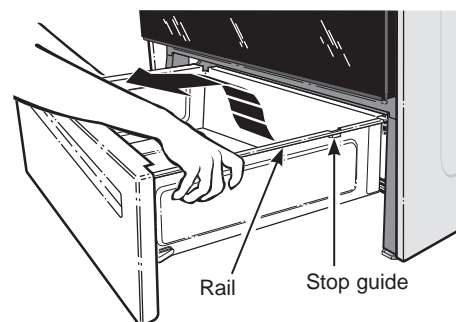

Troubleshooting Tips ... Before you call for service

Save time and money! Review the charts on the following pages first and you may not need to call for service.

Problem	Possible Cause	What To Do
Surface units will not maintain a rolling boil or cooking is not fast enough	Improper cookware being used.	Use pans which are flat and match the diameter of the surface unit selected.
	In some areas, the power (voltage) may be low.	Cover pan with a lid until desired heat is obtained.
Coil surface units do not work properly	The surface units are not plugged in solidly.	With the controls off, check to make sure the surface unit is plugged completely into the receptacle.
	The surface unit controls improperly set.	Check to see the correct control is set for the surface unit you are using.
	The drip pans are not set securely in the cooktop.	With the controls off, check to make sure the drip pan is in the recess in the cooktop and that the opening in the pan lines up with the receptacle.
	A fuse in your home may be blown or the circuit breaker tripped.	Replace the fuse or reset the circuit breaker.
	Sensi-Temp Technology sensor cap is overly soiled.	Clean Sensi-temp Technology sensor cap per cleaning the range section.
	Sensi-temp sensor cap stuck or will not flex up and down.	Call a qualified technician for replacement. Replace coil surface units with only the exact replacement part.
Surface units do not work properly	A fuse in your home may be blown or the circuit breaker tripped.	Replace the fuse or reset the circuit breaker.
	Cooktop controls improperly set.	Check to see the correct control is set for the surface unit you are using.
Surface unit stops glowing when turned to a lower setting	The unit is still on and hot.	This is normal.
Scratches (may appear as cracks) on cooktop glass surface	Incorrect cleaning methods being used.	Scratches are not removable. Tiny scratches will become less visible in time as a result of cleaning.
	Cookware with rough bottoms being used or coarse particles (salt or sand) were between the cookware and the surface of the cooktop. Cookware has been slid across the cooktop surface.	To avoid scratches, use the recommended cleaning procedures. Make sure bottoms of cookware are clean before use, and use cookware with smooth bottoms.
Areas of discoloration on the cooktop	Food spillovers not cleaned before next use.	See the Cleaning the glass cooktop section.
	Hot surface on a model with a light-colored cooktop.	This is normal. The surface may appear discolored when it is hot. This is temporary and will disappear as the glass cools.
Plastic melted to the surface	Hot cooktop came into contact with plastic placed on the hot cooktop.	See the Glass surface—potential for permanent damage section in the Cleaning the glass cooktop section.
Pitting (or indentation) of the cooktop	Hot sugar mixture spilled on the cooktop.	Call a qualified technician for replacement.
Frequent cycling off and on of surface units	Improper cookware being used.	Use only flat cookware to minimize cycling.
My new oven doesn't cook like my old one. Is something wrong with the temperature settings?	Your new oven has a different cooking system from your old oven and therefore may cook differently than your old oven.	For the first few uses, follow your recipe times and temperatures carefully. If you still think your new oven is too hot or too cold, you can adjust the temperature yourself to meet your specific cooking preference. NOTE: This adjustment affects Bake temperatures; it will not affect Broil or Clean.

Troubleshooting Tips ... Before you call for service

Problem	Possible Cause	What To Do
Food does not bake properly	Oven controls improperly set.	See the Cooking Modes section.
	Rack position is incorrect or rack is not level.	See the Cooking Modes section and Cooking Guide.
	Incorrect cookware or cookware of improper size being used.	See the Cookware section.
	Oven temperature needs adjustment.	See the Special Features section.
	Ingredient substitution	Substituting ingredients can change the recipe outcome.
Food does not broil properly	Oven controls improperly set.	Make sure you select the appropriate broil mode.
	Improper rack position being used.	See Cooking Guide for rack location suggestions.
	Food being cooked in a hot pan.	Make sure cookware is cool.
	Cookware not suited for broiling.	Use a pan specifically designed for broiling.
	Aluminum foil used on the broiling pan and grid has not been fitted properly and slit as recommended.	If using aluminum foil conform to pan slits.
	In some areas the power (voltage) may be low.	Preheat the broil element for 10 minutes.
Oven temperature too hot or too cold	Oven temperature needs adjustment.	See the Special Features section or adjust the thermostat (on models with oven temperature knob).
Oven does not work or appears not to work	A fuse in your home may be blown or the circuit breaker tripped.	Replace the fuse or reset the circuit breaker.
	Oven controls improperly set.	See the Using the Oven section.
	A single bracket "]" shows in the display	Press Bake and Broil pads at the same time and hold for three seconds. "SF" will appear in the display. Press the Set Clock pad or the Cook Time pad until "On" appears in the display and then press Start . The display will change from a single bracket "]" to the time of day.
"Crackling" or "popping" sound	This is the sound of the metal heating and cooling during both the cooking and cleaning functions.	This is normal.
Why is my range making a "clicking" noise when using my oven?	Your range cycles the heating elements by turning relays on and off to maintain the oven temperature.	This is normal.
Clock and timer do not work	A fuse in your home may be blown or the circuit breaker tripped.	Replace the fuse or reset the circuit breaker.
	Plug on range is not completely inserted in the electrical outlet.	Make sure electrical plug is plugged into a live, properly grounded outlet.
	Oven controls improperly set.	See the Using the kitchen timer section.
Storage drawer won't close	Power cord may be obstructing drawer in the lower back of the range.	Reposition the drawer and power cord. See the Storage Drawer Removal instructions in the Care and cleaning of the range section.
	Rear drawer support is on top of the guide rail.	Reposition the drawer. See the Storage Drawer Removal instructions in the Care and cleaning of the range section.
Oven door is crooked	The door is out of position.	Because the oven door is removable, it sometimes gets out of position during installation. To straighten the door, push down on the high corner.

Troubleshooting Tips ... Before you call for service

Problem	Possible Cause	What To Do
Oven light does not work	Light bulb is loose or defective.	Tighten or replace bulb.
	Pad operating light is broken.	Call for service.
Oven will not self-clean	The temperature is too high to set a self-clean operation.	Allow the oven to cool and reset the controls.
	Oven controls improperly set.	See the Cleaning the Oven section.
Excessive smoking during clean cycle	Excessive soil or grease.	Press the Cancel/Off pad. Open the windows to rid the room of smoke. Wait until the LOCKED light goes off. Wipe up the excess soil and reset the clean cycle.
Excessive smoking during broiling	Food too close to burner element.	Lower the rack position of the food.
Oven door will not open after a clean cycle	Oven too hot.	Allow the oven to cool below locking temperature.
Oven not clean after a clean cycle	Oven controls improperly set.	See the Cleaning the Oven section.
	Oven was heavily soiled.	Clean up heavy spillovers before starting the clean cycle. Heavily soiled ovens may need to self-clean again or for a longer period of time.
"LOCK DOOR" flashes in the display	The self-clean cycle has been selected but the door is not closed.	Close the oven door.
DOOR LOCK light is on when you want to cook	The oven door is locked because the temperature inside the oven has not dropped below the locking temperature.	Press the Cancel/Off pad. Allow the oven to cool.
"F— and a number or letter" flash in the display	You have a function error code.	Press the Cancel/Off pad. Allow the oven to cool for one hour. Put the oven back into operation.
	If the function code repeats.	Disconnect all power to the oven for at least 30 seconds and then reconnect power. If the function error code repeats, call for service.
Display goes blank	A fuse in your home may be blown or the circuit breaker tripped.	Replace the fuse or reset the circuit breaker.
	The clock is turned off.	See the Special features section.
	Oven is in Sabbath Mode.	Verify that the oven is not in Sabbath Mode. See the Special Features section.
Power outage, clock flashes	Power outage or surge	Reset the clock. If the oven was in use, you must reset it by pressing the Cancel/Off pad, setting the clock and resetting any cooking function.
"Burning" or "oily" odor emitting from the vent	This is normal in a new oven and will disappear in time.	To speed the process, set a self-clean cycle for a minimum of 3 hours. See the Cleaning the Oven section.
Strong odor	An odor from the insulation around the inside of the oven is normal for the first few times the oven is used.	This is temporary and will go away after several uses or a self-clean cycle.
My oven door glass appears to be "tinted" or have a "rainbow" color. Is this defective?	No. The inner oven glass is coated with a heat barrier to reflect the heat back into the oven to prevent heat loss and keep the outer door cool while baking.	This is normal. Under certain light or angles, you may see this tint or rainbow color.

Troubleshooting Tips ... Before you call for service

Problem	Possible Cause	What To Do
Sometimes the oven takes longer to preheat to the same temperature	Cookware or food in oven.	The cookware or food in the oven will cause the oven to take longer to preheat. Remove items to reduce preheat time.
	Number of racks in oven.	Adding more racks to the oven will cause the oven to take longer to preheat. Remove some racks.
Display flashes	Power failure.	Reset the clock.
Unable to get the display to show "SF"	Oven control pads were not touched properly.	The Broil Hi/Lo and Bake pads must be touched at the same time and held for 3 seconds.
Control signals after entering cooking time or start time	You forgot to enter a bake temperature or cleaning time.	Touch the Bake pad and desired temperature or the Self Clean pad and desired clean time.
Oven racks are difficult to slide	The shiny, silver-colored racks were cleaned in a self-clean cycle.	Apply a small amount of vegetable oil to a paper towel and wipe the edges of the oven racks with the paper towel. Do not spray with Pam® or other lubricant sprays.
Drawer does not slide smoothly or drags	The drawer is out of alignment.	Fully extend the drawer and push it all the way in. See the Care and cleaning of the range section.
	Drawer is over-loaded or load is unbalanced.	Reduce weight. Redistribute drawer contents.
Steam from the vent	When using the ovens, it is normal to see steam coming out of the oven vents. As the number of racks or amount of food being cooked increases, the amount of visible steam will increase.	This is normal.
Excessive condensation in the drawer	Liquid in drawer.	Remove liquid.
	Uncovered foods.	Cover food with lid or aluminum foil.
	Temperature setting too high.	Reduce temperature setting.

GE Appliances Electric Range Limited Warranty

GEAppliances.com

All warranty service is provided by our Factory Service Centers, or an authorized Customer Care® technician. To schedule service online, visit us at GEAppliances.com/service, or call GE Appliances at 800.GE.CARES (800.432.2737). Please have your serial number and your model number available when calling for service.

Servicing your appliance may require the use of the onboard data port for diagnostics. This gives a GE Appliances factory service technician the ability to quickly diagnose any issues with your appliance and helps GE Appliances improve its products by providing GE Appliances with information on your appliance. If you do not want your appliance data to be sent to GE Appliances, please advise your technician not to submit the data to GE Appliances at the time of service.

For the period of	GE Appliances will replace
One year From the date of the original purchase	Any part of the range which fails due to a defect in materials or workmanship. During this limited one-year warranty , GE Appliances will provide, free of charge , all labor and in-home service to replace the defective part.

What GE Appliances will not cover:

- Service trips to your home to teach you how to use the product.
- Improper installation, delivery or maintenance.
- Failure of the product if it is abused, misused, modified or used for other than the intended purpose or used commercially.
- Damage to the glass cooktop caused by use of cleaners other than the recommended cleaning creams and pads.
- Damage to the glass cooktop caused by hardened spills of sugary materials or melted plastic that are not cleaned according to the directions in the Owner's Manual.
- Replacement of house fuses or resetting of circuit breakers.
- Damage to the product caused by accident, fire, floods or acts of God.
- Damage to finish, such as surface rust, tarnish, or small blemishes not reported within 48 hours of delivery.
- Incidental or consequential damage caused by possible defects with this appliance.
- Damage caused after delivery.
- Product not accessible to provide required service.
- Service to repair or replace light bulbs, except for LED lamps.
- Immersing or tampering with the Sensi-Temp Technology coil surface units.

EXCLUSION OF IMPLIED WARRANTIES

Your sole and exclusive remedy is product repair as provided in this Limited Warranty. Any implied warranties, including the implied warranties of merchantability or fitness for a particular purpose, are limited to one year or the shortest period allowed by law.

This limited warranty is extended to the original purchaser and any succeeding owner for products purchased for home use within the USA. If the product is located in an area where service by a GE Appliances Authorized Servicer is not available, you may be responsible for a trip charge or you may be required to bring the product to an Authorized GE Appliances Service location for service. In Alaska, the limited warranty excludes the cost of shipping or service calls to your home.

Some states do not allow the exclusion or limitation of incidental or consequential damages. This limited warranty gives you specific legal rights, and you may also have other rights which vary from state to state. To know what your legal rights are, consult your local or state consumer affairs office or your state's Attorney General.

Warrantor: GE Appliances, a Haier company

Louisville, KY 40225

Extended Warranties: Purchase a GE Appliances extended warranty and learn about special discounts that are available while your warranty is still in effect. You can purchase it online anytime at

GEAppliances.com/extended-warranty

or call 800.626.2224 during normal business hours. GE Appliances Service will still be there after your warranty expires.

Staple your receipt here. Proof of the original purchase date is needed to obtain service under the warranty.

Accessories

Looking For Something More?

GE Appliances offers a variety of accessories to improve your cooking and maintenance experiences!

Refer to the Consumer Support page for phone numbers and website information.

The following products and more are available:

Accessories

Small Broiler Pan (8 ¾" x 1 ¼" x 13 ½")

Large* Broiler Pan (12 ¾" x 1 ¼" x 16 ½")

XL** Broiler Pan (17" x 1 ¼" x 19 ¼")

Parts

Oven racks

Oven burners

Light bulbs

Cleaning Supplies

CitruShine™ Stainless Steel Wipes

Stainless Steel Appliance Cleaner

Cleaning Pads for Ceramic Cooktops

Ceramic Cooktop Cleaner

Ceramic Cooktop Scraper

Kit (Kit includes cream and cooktop scraper)

Graphite Lubricant

*The large broiler pan does not fit in 20"/24" ranges.

**The XL broiler pan does not fit in 24" wall ovens, 27" drop ins or 20"/24" ranges

Consumer Support

GE Appliances Website

Have a question or need assistance with your appliance? Try the GE Appliances Website 24 hours a day, any day of the year! You can also shop for more great GE Appliances products and take advantage of all our on-line support services designed for your convenience. In the US: GEAppliances.com

Register Your Appliance

Register your new appliance on-line at your convenience! Timely product registration will allow for enhanced communication and prompt service under the terms of your warranty, should the need arise. You may also mail in the pre-printed registration card included in the packing material. In the US: GEAppliances.com/register

Schedule Service

Expert GE Appliances repair service is only one step away from your door. Get on-line and schedule your service at your convenience any day of the year. In the US: GEAppliances.com/service or call 800.432.2737 during normal business hours.

Extended Warranties

Purchase a GE Appliances extended warranty and learn about special discounts that are available while your warranty is still in effect. You can purchase it on-line anytime. GE Appliances Services will still be there after your warranty expires. In the US: GEAppliances.com/extended-warranty or call 800.626.2224 during normal business hours.

Remote Connectivity

For assistance with wireless network connectivity (for models with remote enable), visit our website at GEAppliances.com/connect or call 800.220.6899 in the US.

Parts and Accessories

Individuals qualified to service their own appliances can have parts or accessories sent directly to their homes (VISA, MasterCard and Discover cards are accepted). Order on-line today 24 hours every day. In the US: GEApplianceparts.com or by phone at 877.959.8688 during normal business hours.

Instructions contained in this manual cover procedures to be performed by any user. Other servicing generally should be referred to qualified service personnel. Caution must be exercised, since improper servicing may cause unsafe operation.

Contact Us

If you are not satisfied with the service you receive from GE Appliances, contact us on our Website with all the details including your phone number, or write to:

In the US: General Manager, Customer Relations | GE Appliances, Appliance Park | Louisville, KY 40225
GEAppliances.com/contact