

Use & Care Guide

Manual de uso y cuidado

English / Español

Table of Contents...2 / Índice...21

Models/Modelos: 110.31642\*, 110.31643\*

# Kenmore Elite<sup>®</sup>

Top-Loading High Efficiency  
Low-Water Washer

Lavadora de carga superior de alto  
rendimiento con nivel bajo de agua

P/N W11443621B

Transform SR Brands Management LLC,

Hoffman Estates, IL 60179 U.S.A.

[www.kenmore.com](http://www.kenmore.com)



## TABLE OF CONTENTS

WASHER SAFETY .....	2	WASHER MAINTENANCE .....	13
WHAT'S NEW UNDER THE LID? .....	4	TROUBLESHOOTING .....	15
CONTROL PANEL AND FEATURES .....	5	ASSISTANCE OR SERVICE .....	Back Cover
DISPENSERS .....	7		
CYCLE GUIDE .....	8		
USING YOUR WASHER .....	9		

## WASHER SAFETY

### Your safety and the safety of others are very important.

We have provided many important safety messages in this manual and on your appliance. Always read and obey all safety messages.



This is the safety alert symbol.

This symbol alerts you to potential hazards that can kill or hurt you and others.

All safety messages will follow the safety alert symbol and either the word "DANGER" or "WARNING."

These words mean:

 **DANGER**

You can be killed or seriously injured if you don't immediately follow instructions.

 **WARNING**

You can be killed or seriously injured if you don't follow instructions.

All safety messages will tell you what the potential hazard is, tell you how to reduce the chance of injury, and tell you what can happen if the instructions are not followed.

## IMPORTANT SAFETY INSTRUCTIONS

**WARNING:** To reduce the risk of fire, electric shock, or injury to persons when using the washer, follow basic precautions, including the following:

- Read all instructions before using the washer. 
- Do not wash articles that have been previously cleaned in, washed in, soaked in, or spotted with gasoline, dry-cleaning solvents, other flammable, or explosive substances as they give off vapors that could ignite or explode.
- Do not add gasoline, dry-cleaning solvents, or other flammable, or explosive substances to the wash water. These substances give off vapors that could ignite or explode.
- Under certain conditions, hydrogen gas may be produced in a hot water system that has not been used for 2 weeks or more. **HYDROGEN GAS IS EXPLOSIVE.** If the hot water system has not been used for such a period, before using the washing machine, turn on all hot water faucets and let the water flow from each for several minutes. This will release any accumulated hydrogen gas. As the gas is flammable, do not smoke or use an open flame during this time.
- Do not allow children to play on or in the washer. Close supervision of children is necessary when the washer is used near children.
- Before the washer is removed from service or discarded, remove the door or lid.
- Do not reach into the washer if the drum, tub or agitator is moving.
- Do not install or store the washer where it will be exposed to the weather.
- Do not tamper with controls.
- Do not repair or replace any part of the washer or attempt any servicing unless specifically recommended in this manual or in published user-repair instructions that you understand and have the skills to carry out.
- See Installation Instructions for grounding instructions.

**SAVE THESE INSTRUCTIONS**

## WHAT'S NEW UNDER THE LID?

Your new washer will operate differently than your past agitator-style washer.

### Cleaning with Less Water

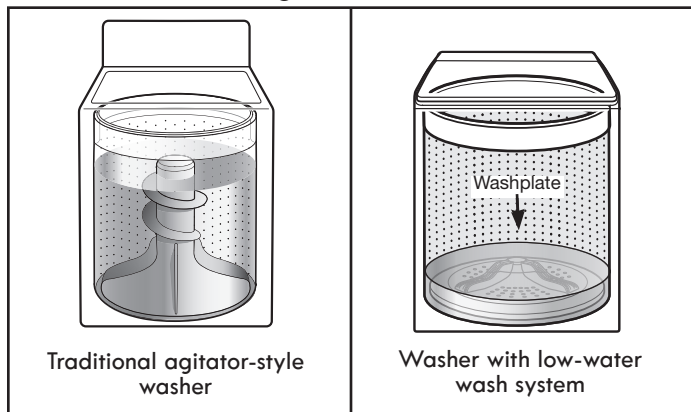

A striking difference in your new washer is the low-water washplate wash system. The washer automatically adjusts the water level to the load size—no water level selector is needed.

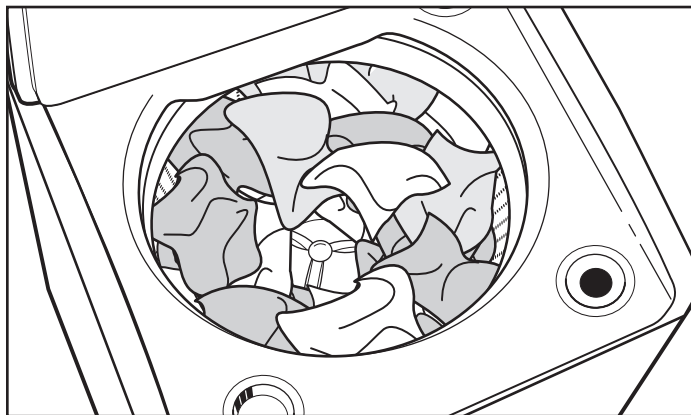

For best performance, it is recommended to load items in loose heaps evenly around the washplate.

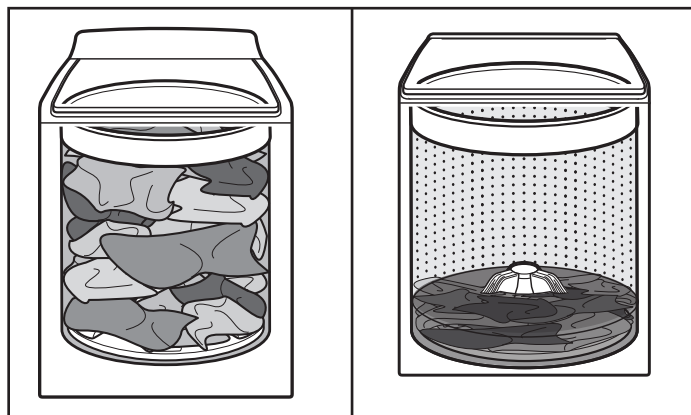

As the washer dampens and moves the load, the level of the items will settle in the basket. This is normal, and does not indicate that more items should be added.

**IMPORTANT:** You will not see a washer basket full of water as with your past agitator-style washer. It is normal for some of the load to be above the water line.

### Automatic Load Size Sensing

Once you start the cycle, the lid will lock, and the washer will begin the sensing process to determine the correct water level for the load.

Initially the basket will start to spin prior to adding water, this is part of the sensing process and is normal. This low-water wash method uses less water and energy compared to a traditional agitator-style washer.

### Choosing the Right Detergent

Use only High Efficiency detergents. The package will be marked "HE" or "High Efficiency." Low-water washing creates excessive sudsing with a non-HE detergent. Using non-HE detergent will likely result in longer cycle times and reduced rinsing performance. It may also result in component malfunction and, over time, buildup of mold or mildew. HE detergents should be low-sudsing and quick-dispersing to produce the right amount of suds for the best performance. They should hold soil in suspension so it is not redeposited onto clean clothes. Not all detergents labeled as High Efficiency are identical in formulation and their ability to reduce suds. For example, natural, organic, or homemade HE detergents may generate a high level of suds. Always follow the detergent manufacturer's instructions to determine the amount of detergent to use.



Use only High Efficiency (HE) detergent.

### Improved Cleaning

Low-water cleaning means concentrated cleaning. Rather than diluting detergent as done in an agitator-style washer, this washer delivers the detergent directly to the soils. This low water wash also allows the clothing to move in a more effective way to remove soils.

### Normal Sounds You Can Expect

At different stages of the wash cycle, you may hear sounds and noises that are different from those of your previous washer. For example, you may hear a clicking and hum at the beginning of the cycle, as the lid lock goes through a self-test. There will be different kinds of humming sounds as the washplate moves the load and as basket is slowing down to stop. And sometimes, you may hear nothing at all, as the washer determines the correct water level for your load or allows time for clothes to soak.

# CONTROL PANEL AND FEATURES

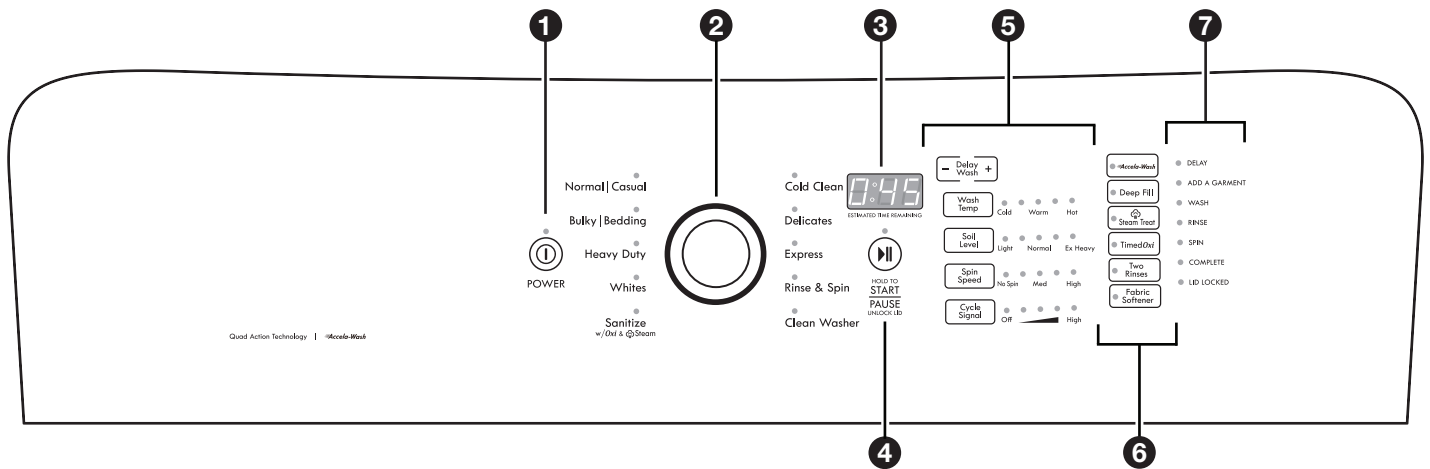

Not all features and options are available on all models.

Appearance may vary.

**NOTE:** The control panel features a sensitive surface that responds to a light touch of your finger. To ensure your selections are registered, touch the control panel with your finger tip, not your fingernail. When selecting a setting or option, simply touch its name until the desired section is illuminated.

## 1 POWER BUTTON

Touch to turn the washer ON. Touching once while the washer is on will cancel the current cycle and turn the washer OFF.

## 2 WASH CYCLE KNOB

Use the Wash Cycle knob to select cycles on your washer. See "Cycle Guide" for detailed descriptions of cycles.

## 3 ESTIMATED TIME REMAINING DISPLAY

The Estimated Time Remaining display shows the time required for the cycle to complete. Factors such as load size and water pressure may affect the time shown in the display. Tightly packed loads, unbalanced loads, or excessive suds may cause the washer to adjust the cycle time, as well.

If you have set a delay start to the cycle, the Estimated Time Remaining display will show the delay time adjusted.

When the cycle is complete, the display will show END until the lid is opened.

## 4 START/PAUSE/UNLOCK LID BUTTON

Press and hold the START/PAUSE/Unlock Lid button to begin the selected cycle; touch again to pause a cycle and unlock the lid.

**NOTE:** If the washer is spinning, it may take several minutes to unlock the lid. Press and hold for 3 seconds to cancel a cycle.

## 5 CYCLE MODIFIERS

When you select a cycle, its default settings or the previous cycle selection used will light up.

### DELAY WASH

Touch Delay Wash to delay the start of the wash cycle up to 12 hours "12h". Touch Delay Wash until a "0h" appears in the status display to turn off, or touch POWER.

### WASH TEMP

Temperature control senses and maintains uniform water temperatures by regulating incoming hot and cold water.

Select a wash temperature based on the type of fabric and soils being washed. For best results and following the garment label instructions, use the warmest wash water safe for your fabric.

- On some cycles, warm and hot water may be cooler than your previous washer.
- Even for cold wash settings, some warm water may be added to the washer to maintain a minimum temperature.

### SOIL LEVEL

Soil Level (wash time) is preset for each wash cycle. As you touch the Soil Level pad, the cycle time (minutes) will increase or decrease in the Estimated Time Remaining display and a different wash time will appear.

Select the most suitable setting for your load. For heavily soiled items, select Ex Heavy for more wash time. For lightly soiled items, select Light for less wash time. A lighter soil level setting will help reduce tangling and wrinkling.

### SPIN SPEED

This washer automatically selects the spin speed based on the cycle selected. The preset speeds can be changed. Not all spin speeds are available with all cycles.

- Faster spin speeds mean shorter dry times but may increase wrinkling in your load.
- Slower spin speeds mean less wrinkling, but will leave your load more damp.

### CYCLE SIGNAL

Use this to adjust the volume of button sounds and/or the signal indicating the end of a wash cycle.

**NOTE:** You may also turn off the tones that sound when a feature, setting, or option is touched.

## 6 OPTIONS

You may add or remove options for each cycle. Not all options can be used with all cycles, and some are preset to work with certain cycles.

### ACCELA WASH

Adding this option reduces the cycle time while maintaining a wash performance similar to the same cycle without ACCELA WASH.

### DEEP FILL

If you would like to add the maximum amount of water to your wash cycle, select the Deep Fill option.

**NOTE:** Expect longer cycle times due to extended fill times when using the Deep Fill option.

### STEAM TREAT

The Steam Treat option adds additional soak and wash time to many cycles to help remove tough stains, as well as a steam boost for added cleaning power. Steam Treat uses a heater within the washer to maintain the selected temperature setting throughout the wash period. Steam Treat may be selected as an option with other cycles.

**NOTE:** The Steam Treat option may increase the selected temperature.

### TIMED OXI

This option must be selected if using Oxi products during a cycle. It ensures that the Oxi product is added at the correct time in the cycle for even distribution.

### TWO RINSES

This option can be used to automatically add a second rinse to most cycles.

### FABRIC SOFTENER

This option must be selected if using fabric softener during a cycle. It ensures that fabric softener is added at the correct time in the rinse for even distribution.

## 7 CYCLE STATUS LIGHTS

The Cycle Status Lights show the progress of a cycle. At each stage of the process, you may notice sounds or pauses that are different from traditional washers.

### DELAY

When Delay Wash has been selected, the Delay light will illuminate and remain illuminated until the cycle begins.

### ADD A GARMENT

When Add A Garment is lit, you may pause the washer, open the lid, and add items. Touch and hold START/PAUSE/Unlock Lid to start the washer again.

### WASH

During the first stage of the wash cycle, water will partially fill the washer and begin to move the load. You will hear the impeller rotate followed by a several second pause. This process will repeat for several minutes, allowing the entire load to become saturated. It is normal for the load to be above the water line during this stage. At the beginning of the second stage, the washer will add water to the correct level based on the load size. You will hear the impeller increase speed during this stage of the wash cycle. The motor sounds may change at different stages in the wash cycle.

### RINSE

You will hear sounds similar to the wash cycle as the washer rinses and moves the load. You may hear the motor turning on briefly (short hum) to move the basket while filling.

### SPIN

The washer spins the load at increasing speeds for proper water removal based on the selected cycle and spin speed.

### COMPLETE

Once the cycle is complete, this light will come on. For best results, promptly remove the load.

### LID LOCKED

The Lid Locked feature allows for higher spin speeds. When lit, the lid is locked and cannot be opened without pausing the cycle. When the light is off, the lid can be opened.

To open the lid after it has been locked, press START/PAUSE/Unlock Lid. The lid will unlock once the washer movement has stopped. This may take several minutes if the load was spinning at high speed. Press START/PAUSE/Unlock Lid while the lid is closed to resume the cycle.



## DISPENSERS

### A DETERGENT DISPENSER

Pour measured amount of liquid HE detergent into the detergent dispenser. The detergent will dispense at the optimum time during the wash cycle.

**NOTE:** Do not place single-dose laundry packets or powder detergent into the dispenser. Add single-dose laundry packets or powder detergent directly to the washer basket.



Use only High Efficiency (HE) detergent.

### B LIQUID FABRIC SOFTENER DISPENSER

Pour measured liquid fabric softener into the liquid fabric softener dispenser, if desired. It will dispense automatically at the optimum time.

- Use only liquid fabric softener in this dispenser.

### C LIQUID CHLORINE BLEACH AND OXI DISPENSER

The bleach will be automatically diluted and dispensed at the optimum time during the wash cycle. This dispenser cannot dilute powdered bleach.

**NOTE:** If a gel bleach is used, the Oxi button must be pressed to assist in dispensing the gel.

This dispenser holds up to 3/4 cup (180 mL) Oxi booster or other laundry booster, such as powdered or liquid color-safe bleach. Laundry boosters are automatically dispensed at the proper time during the wash cycle. Be sure to select Oxi from the options to ensure proper dispensing.

**NOTE:** Fill dispenser with only Oxi. Do not mix with bleach.

**IMPORTANT:** Even on cold cycles, using the Oxi booster option will cause the washer to use some warm water to assist in dispensing the Oxi liquid/powder.

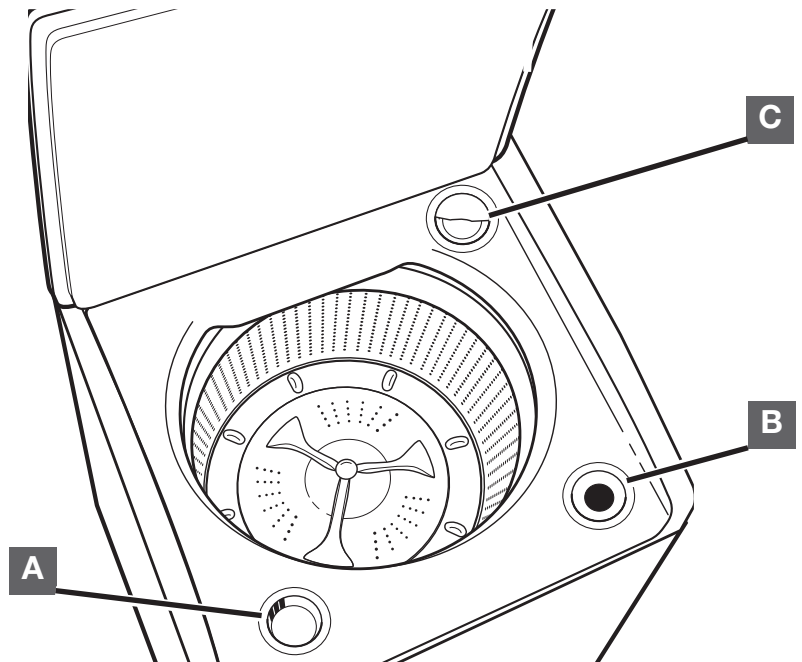

## CYCLE GUIDE

For best fabric care, choose the cycle that best fits the load being washed. Recommended settings for best performance are shown in **Bold**. Not all settings and options are available on each cycle.

Items to wash:	Cycle:	Wash Temp*:	Spin Speed:	Cycle Details:
Cottons, linens, and mixed-garment loads	Normal/ Casual	Hot <b>Warm</b> Cool Lights Cool Darks Cold	Medium	Use this cycle for normally soiled cottons and mixed-fabric loads.
Large items such as sheets, sleeping bags, small comforters, jackets, small washable rugs	Bulky/Bedding	Hot <b>Warm</b> Cool Lights Cool Darks Cold	Low	Use this cycle to wash large items such as jackets and small comforters. The washer will fill with enough water to wet down the load before the wash portion of the cycle begins and uses a higher water level than other cycles.
Sturdy fabrics, colorfast items, towels, sheets, jeans	Heavy Duty	Hot Warm Cool Lights Cool Darks Cold	Medium/ High	Use this cycle for heavily soiled or sturdy items. Water-level sensing process may take longer for some items than for others because they will absorb more water than other fabric types.
Heavily soiled fabrics	Whites	Hot Warm Cool Lights Cool Darks Cold	Medium/ High	Use this cycle for heavily soiled white fabrics.
Heavily soiled, colorfast fabrics	Sanitize w/ Oxi & Steam*	Hot Warm Cool Lights Cool Darks Cold	Medium/ High	Use this cycle to eliminate 99.9% of bacteria when used in conjunction with the Oxi option. Preset cycle settings must be used to achieve the proper sanitization. Be sure to add an Oxi product to the Oxi dispenser.  Combines a rinse and spin for loads requiring an additional rinse cycle or to complete a load after power interruption. Also use for loads that require rinsing only. To use a spin only, turn off the Two Rinses option.
Bright or darkly colored cottons, linens, casual and mixed loads	Cold Clean	Hot Warm Cool Lights Cool Darks <b>Cold</b>	Medium/ High	Cold water with an additional wash action gently lifts stains while caring for fabrics. Settings may be adjusted as desired, but must use only cold water settings.
Machine-wash silks, lingerie, washable wools	Delicates	Hot Warm <b>Cool Lights</b> Cool Darks Cold	Low	Use this cycle to wash lightly soiled items indicating "Machine Washable Silks" or "Gentle" cycle on the care label. Place small items in mesh garment bags before washing.
Lightly soiled fabrics	Express	Hot <b>Warm</b> Cool Lights Cool Darks Cold	High	Use this cycle to quickly clean a small number of lightly soiled items.
Swimsuits and items requiring rinsing without detergent	Rinse & Spin	Cold Rinse Only	Low	Combines a rinse and spin for loads requiring an additional rinse cycle or to complete a load after power interruption. Also use for loads that require rinsing only. To use a spin only, turn off the Two Rinses option.
No clothes in washer	Clean Washer	NA	NA	Use this cycle every 30 washes to keep the inside of your washer fresh and clean. This cycle uses a higher water level. Use with liquid chlorine bleach to thoroughly clean the inside of your washer. This cycle should not be interrupted. See "Washer Care." <b>IMPORTANT:</b> Do not place garments or other items in the washer during the Clean Washer cycle. Use this cycle with an empty wash tub.

\*Extended hot water cycle intended to help sanitize items such as sheets and towels. This cycle is not recommended for all fabrics. For best results, this cycle should be run to completion to ensure sanitation and should not be interrupted.



## USING YOUR WASHER

### ⚠ WARNING



#### Fire Hazard

Never place items in the washer that are dampened with gasoline or other flammable fluids.

No washer can completely remove oil.

Do not dry anything that has ever had any type of oil on it (including cooking oils).

Doing so can result in death, explosion, or fire.

### ⚠ WARNING



#### Electrical Shock Hazard

Plug into a grounded 3 prong outlet.

Do not remove ground prong.

Do not use an adapter.

Do not use an extension cord.

Failure to follow these instructions can result in death, fire, or electrical shock.

### 1. Sort and prepare your laundry

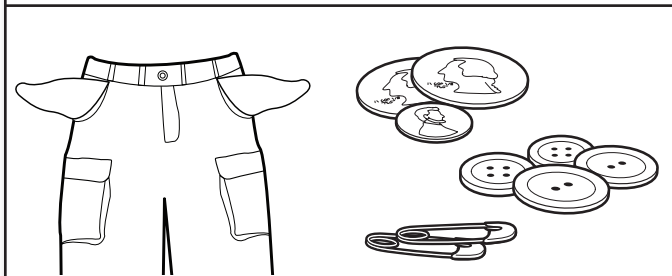

- Empty pockets. Loose change, buttons, or any small object can pass under the washplate and become trapped, causing unexpected sounds.
- Sort items by recommended cycle, water temperature, and colorfastness.
- Separate heavily soiled items from lightly soiled.
- Separate delicate items from sturdy fabrics.
- Do not dry items if stains remain after washing; heat can set stains into fabric.
- Treat stains promptly.
- Close zippers, fasten hooks, tie strings and sashes. Remove non-washable trim and ornaments.
- Mend rips and tears to avoid further damage to items during washing.

#### Helpful Tips:

- For best performance, use HE liquid detergent when washing bulky items.
- When washing waterproof or water-resistant items, load evenly.
- Use mesh bags to help avoid tangling when washing delicate or small items.
- Turn knits inside out to avoid pilling. Separate lint-takers from lint-givers. Synthetics, knits, and corduroy fabrics will pick up lint from towels, rugs, and chenille fabrics.
- Wash large, absorbent items with other water absorbent items or alone. Do not mix water absorbent items with items that do not absorb water as this can cause imbalance.

**NOTE:** Always read and follow fabric care labels instructions to avoid damage to your items.

### 2. Add laundry products

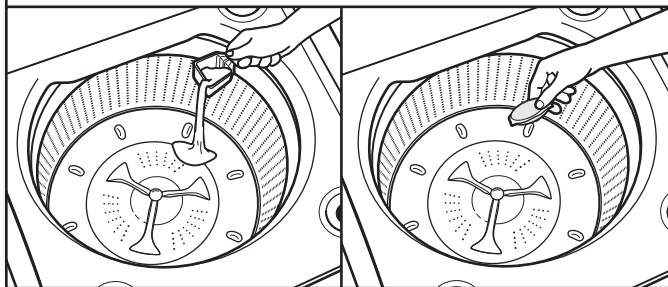

Single-dose laundry packets, powder detergent, or fabric softener crystals should be added to the basket prior to adding laundry.

**NOTE:** Always follow manufacturer's instructions, and never add single-dose laundry packets, powder detergent, or fabric softener crystals to the single-dose dispensers. They will not dispense correctly. Add to the basket prior to adding laundry.

### 3. Load laundry into washer

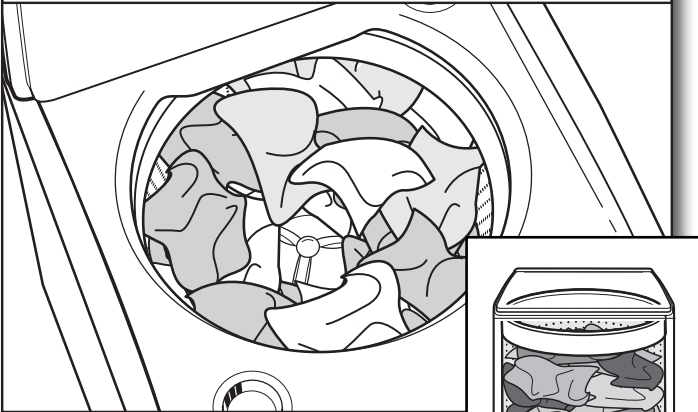

For best performance, load items in loose heaps evenly around the washplate. Try mixing different sized items to reduce tangling.

**IMPORTANT:** Items need to move freely for best cleaning and to reduce wrinkling and tangling.

### 4. Using the liquid detergent dispenser

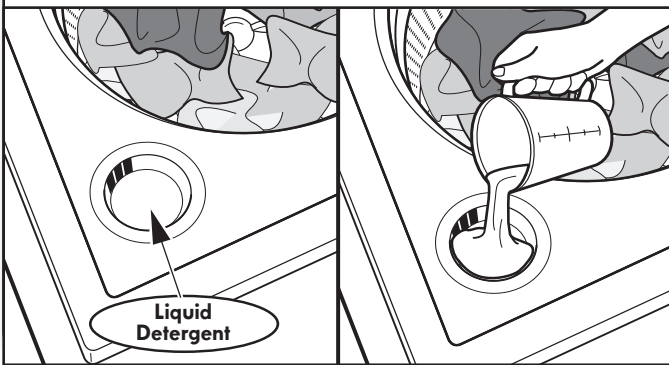

Pour a measured amount of HE detergent into dispenser; always follow manufacturer's directions for correct amount of detergent based on your load size.

### 5. Add liquid chlorine bleach or Oxi to dispenser

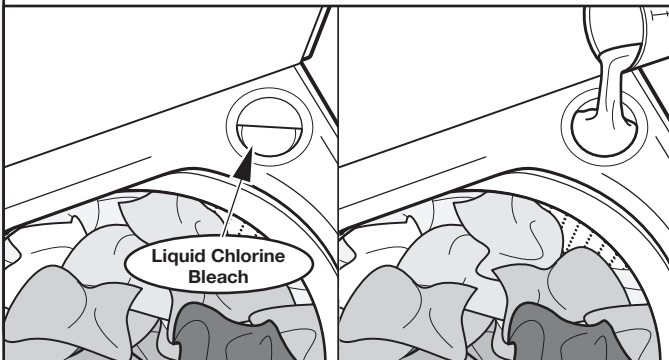

Do not overfill, dilute, or use more than 1 cup (236 mL) of liquid chlorine bleach. Pour a measured amount of Oxi-type boosters, into dispenser; always follow manufacturer's directions for correct amount of Oxi-type boosters based on your load size. Oxi is added during main wash.

### 6. Add liquid fabric softener to dispenser

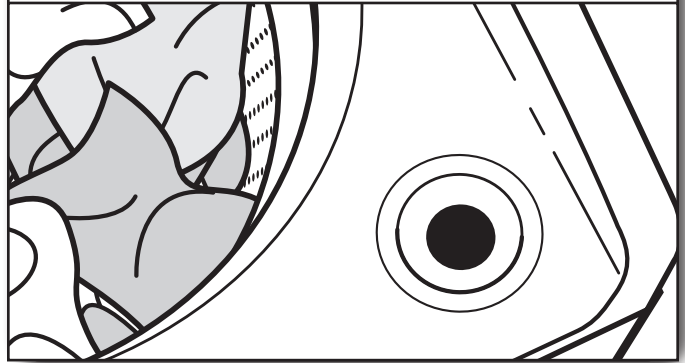

Pour a measured amount of liquid fabric softener into dispenser; always follow manufacturer's directions for correct amount of fabric softener based on your load size. Fabric Softener is added during rinse.

**IMPORTANT:** Do not overfill or dilute. Overfilling dispenser will cause fabric softener to immediately dispense into washer. Do not put fabric softener crystals into dispenser.

If Extra Rinse option is selected, fabric softener will be dispensed into the last rinse. It is normal for a small amount of water to remain in the dispenser at the end of a cycle.

### 7. Touch POWER to turn on washer



Close the lid and touch POWER to turn on the washer.

## 8. Select cycle

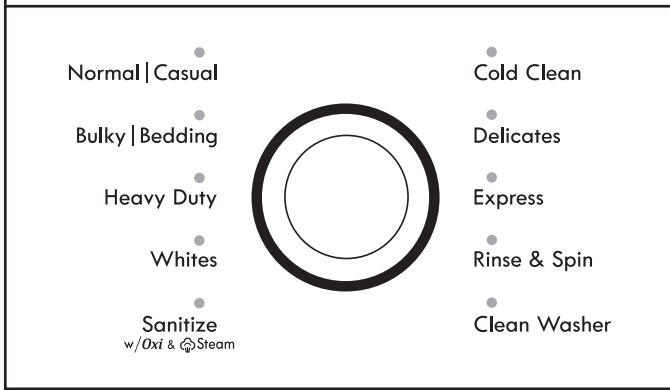

Turn the cycle knob to choose your wash cycle. For more information, see "Cycle Guide."

Estimated Time Remaining will light up with a cycle time. You may notice time adjusting during the cycle. This is normal.

If you do not want to begin a cycle immediately, you may choose DELAY WASH option.

### To choose a delay time:

1. Touch DELAY WASH button to select desired delay time. Time will increase in hour increments up to 12 hours.
2. Press and hold the START/PAUSE/Unlock Lid button to start delay start time.

**IMPORTANT:** When delaying a cycle, use liquid HE detergent only in the dispenser. Powdered detergents may absorb moisture from a previous cycle and clump before the wash cycle begins.

### To cancel Delay Wash:

1. Touch POWER to cancel Delay Wash.

### To pause Delay Wash:

1. Touch START/PAUSE/Unlock Lid button to pause Delay Wash.
2. Touch START/PAUSE/Unlock Lid button again to start Delay Wash time.



## 9. Select cycle modifiers

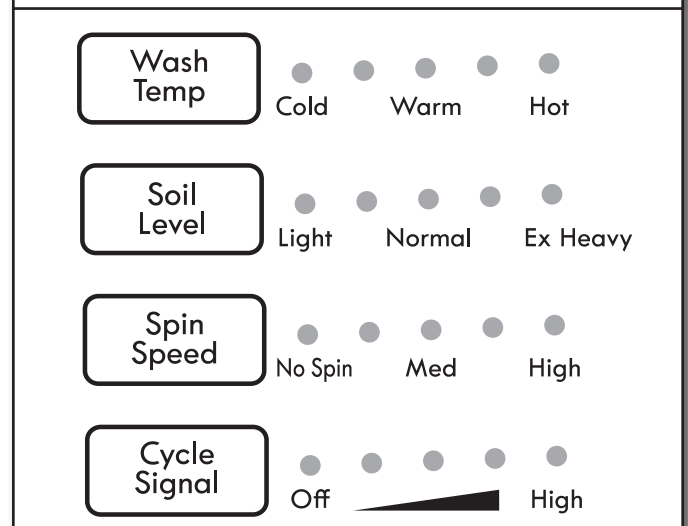

Once you select a cycle, the default modifiers or the previous set modifiers for that cycle will be lit. Touch the cycle settings buttons to change the Wash Temp, Soil Level, and Spin Speed, if desired. Not all settings are available with all cycles.

**NOTE:** Always read and follow fabric care labels instructions to avoid damage to your items. If not sure on which temperature to use, refer to the chart below or select a cooler temperature.

### Temperature suggestions

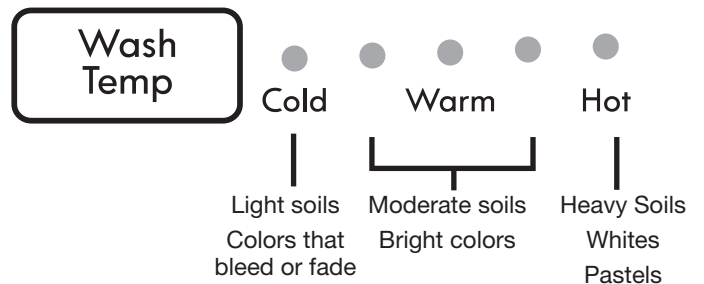

**NOTE:** Even for cold wash settings, some warm water may automatically enter the tub to maintain a minimum temperature.

## 10. Select cycle options

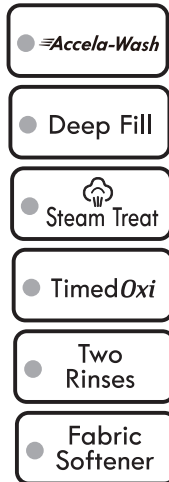

Select any other cycle options you may wish to add, if not previously set. Some cycles will automatically add certain options such as Two Rinses. These may be turned off, if desired.

**NOTE:** Not all options are available with all cycles. Touch control panel to select any other options.

## 11. Touch and hold START/PAUSE/Unlock Lid button to begin wash cycle



Press and hold the START/PAUSE/Unlock Lid button to start the wash cycle. When the cycle has finished, the end of cycle signal will sound (if set). Promptly remove items when cycle is done to avoid odor, reduce wrinkling, and rusting of metal hooks, zippers, and snaps.

### Unlocking the lid to add items

#### If you need to open the lid to add 1 or 2 missed items:

Touch START/PAUSE/Unlock Lid button to pause washer; the lid will unlock once the washer movement has stopped. This may take several minutes if the load was spinning at a high speed. Then close lid and press and hold the START/PAUSE/Unlock Lid button again to restart the cycle.

**IMPORTANT:** If lid is left open for more than 10 minutes the water will pump out and F8E6 error code will appear on the display.

# WASHER MAINTENANCE

## WATER INLET HOSES

Replace inlet hoses after 5 years of use to reduce the risk of hose failure. Periodically inspect and replace inlet hoses if bulges, kinks, cuts, wear, or leaks are found.

When replacing your inlet hoses, mark the date of replacement on the label with a permanent marker.

**NOTE:** This washer does not include inlet hoses. See the "Installation Instructions" for more information.

## WASHER CARE

### Recommendations to Help Keep Your Washer Clean and Performing at its Best

1. Always follow the detergent manufacturer's instructions regarding the amount of detergent to use. Never use more than the recommended amount because that may increase the rate at which detergent and soil residue accumulate inside your washer, which in turn may result in undesirable odor.
2. Use warm and hot wash water settings sometimes (not exclusively cold water washes), because they do a better job of controlling the rate at which soils and detergent accumulate.
3. Always leave the washer lid open between uses to help dry out the washer and prevent the buildup of odor-causing residue.

### Cleaning Your Top Loading Washer

Read these instructions completely before beginning the routine cleaning processes recommended below. This Washer Maintenance Procedure should be performed, at a minimum, once per month or every 30 wash cycles, whichever occurs sooner, to control the rate at which soils and detergent may otherwise accumulate in your washer.

### Cleaning the Inside of the Washer

To keep your washer odor-free, follow the usage instructions provided above, and use this recommended monthly cleaning procedure:

### Recommended Cycle for Cleaning the Washer

Refer to the "Cycle Guide" for the optimal cycle for cleaning the inside of the washer. Use this cycle with liquid chlorine bleach as described below.

### Begin procedure

#### Chlorine Bleach Procedure

- a. Open the washer lid and remove any clothing or items.
- b. Add 1 cup (236 mL) of liquid chlorine bleach to the bleach compartment.  
**NOTE:** Use of more liquid chlorine bleach than is recommended above could cause washer damage over time.
- c. Close the washer lid.
- d. Do not add any detergent or other chemical to the washer when following this procedure.
- e. Select the cycle recommended for cleaning the inside of the washer.
- f. Press the START/PAUSE/Unlock Lid button to start the cycle.

**NOTE:** For best results, do not interrupt cycle. If cycle must be interrupted, press START/PAUSE/Unlock Lid once. After the cycle has stopped, run a RINSE/SPIN cycle to rinse cleaner from washer.

## WASHER CARE (cont.)

### Cleaning the Dispensers

After a period of using your washer, you may find some residue buildup in the washer's dispensers. To remove residue from the dispensers, wipe them with a damp cloth and towel dry. Do not attempt to remove the dispensers or trim for cleaning. The dispensers and trim are not removable. If your model has a dispenser drawer, however, remove the drawer and clean it before or after you run the Clean Washer cycle. Use an all-purpose surface cleaner, if needed.

### Cleaning the Outside of the Washer

Use a soft, damp cloth or sponge to wipe away any spills. Use only mild soaps or cleaners when cleaning external washer surfaces.

**IMPORTANT:** To avoid damaging the washer's finish, do not use abrasive products.

## NON-USE AND VACATION CARE

Operate your washer only when you are home. If moving, or not using your washer for a period of time, follow these steps:

1. Unplug or disconnect power to washer.
2. Turn off water supply to washer, to avoid flooding due to water pressure surge.

## WINTER STORAGE CARE

**IMPORTANT:** To avoid damage, install and store washer where it will not freeze. Because some water may stay in hoses, freezing can damage washer. If storing or moving during freezing weather, winterize your washer.

### To winterize washer:

1. Shut off both water faucets; disconnect and drain water inlet hoses.
2. Put 1 qt. (1 L) of R.V.-type antifreeze in basket and run washer on Rinse/Spin cycle for about 30 seconds to mix antifreeze and remaining water.
3. Unplug washer or disconnect power.

## TRANSPORTING YOUR WASHER

1. Shut off both water faucets. Disconnect and drain water inlet hoses.
2. If washer will be moved during freezing weather, follow Winter Storage Care directions before moving.
3. Disconnect drain from drain system and drain any remaining water into a pan or bucket. Disconnect drain hose from back of washer.
4. Unplug power cord.
5. Place inlet hoses and drain hose inside washer basket.
6. Drape power cord over edge and into washer basket.
7. Place packing tray from original shipping materials back inside washer. If you do not have packing tray, place heavy blankets or towels into basket opening. Close lid and place tape over lid and down front of washer. Keep lid taped until washer is placed in new location. Transport washer in upright position.

## REINSTALLING/USING WASHER AGAIN

### To reinstall washer after non-use, vacation, winter storage, or moving:

1. Refer to "Installation Instructions" to locate, level, and connect washer.
2. Before using again, run washer through the following recommended procedure:

### To use washer again:

1. Flush water pipes and hoses. Reconnect water inlet hoses. Turn on both water faucets.

## ⚠ WARNING



### Electrical Shock Hazard

**Plug into a grounded 3 prong outlet.**

**Do not remove ground prong.**

**Do not use an adapter.**

**Do not use an extension cord.**

**Failure to follow these instructions can result in death, fire, or electrical shock.**

2. Plug in washer or reconnect power.
3. Run washer through Clean Washer cycle to clean washer and remove antifreeze, if used. Use half the manufacturer's recommended amount for a medium-size load.

# TROUBLESHOOTING

First try the solutions suggested here for assistance and to possibly avoid a service call.

If you experience	Possible Causes	Solution
<b>Vibration or Off-Balance</b>		
Vibration, rocking, or "walking"	Feet may not be in contact with the floor and locked.	Front and rear feet must be in firm contact with floor, and washer must be level to operate properly.
	Washer may not be level.	Check floor for flexing or sagging. If flooring is uneven, a 3/4" (19 mm) piece of plywood under your washer will reduce sound. See "Level the Washer" in the Installation Instructions.
Vibration during spinning or washer stopped	Load could be unbalanced.	Load items in loose heaps evenly around the washplate. Adding wet items to washer or adding more water to basket could unbalance washer.
		Avoid washing single items. Balance a single item such as a rug or jeans jacket with a few extra items. Redistribute the load, close the lid, and touch and hold START/PAUSE/Unlock Lid.
		Use Bulky/Sheets Deep Water Wash cycle for oversized, non-absorbent items such as comforters or poly-filled jackets. Other items are not appropriate for Bulky/Sheets Normal cycle. See "Cycle Guide."
		Item or load not suitable for selected cycle. See "Cycle Guide" and "Using Your Washer."
<b>Noises – For normal operating sounds, go to <a href="http://www.kenmore.com">www.kenmore.com</a>.</b>		
Clicking or metallic noises	Objects may be caught in washer drain system.	Empty pockets before washing. Loose items such as coins could fall between basket and tub or may block pump. It may be necessary to call for service to remove items.
		It is normal to hear metal items on clothing such as metal snaps, buckles, or zippers touch against the stainless steel basket.
Gurgling or humming	Washer may be draining water.	It is normal to hear the pump making a continuous humming sound with periodic gurgling or surging as final amounts of water are removed during the spin/drain cycles.
Humming	Load sensing may be occurring.	You may hear the hum of the sensing spins after you have started the washer. This is normal.
Whirring	Basket may be slowing down.	You may hear the whirring sound of the basket slowing down. This is normal.
<b>Water Leaks</b>		
Check the following for proper installation:	Washer not level.	See Installation Instructions for details on how to level your washer.
	Fill hoses not attached tightly.	Tighten fill-hose connection.
	Fill hose washers.	Make sure all four fill hose flat washers are properly seated.
	Drain hose connection.	Pull drain hose from washer cabinet and properly secure it to drainpipe or laundry tub.
		Do not place tape over drain opening.
	Check household plumbing for leaks or clogged sink or drain.	Water can back up out of a clogged sink or drainpipe. Check all household plumbing for leaks (laundry tubs, drain pipe, water pipes, and faucets.)
Washer not loaded as recommended.	An unbalanced load can cause basket to be out of alignment and cause water to splash off tub. See "Using Your Washer" for loading instructions.	
<b>Washer not performing as expected</b>		
Not enough water in washer	Load not completely covered in water.	This is normal operation for an HE low-water washer. The load will not be completely underwater. The washer senses load sizes and adds correct amount of water for optimal cleaning. See "What's New under the Lid." <b>IMPORTANT:</b> Do not add more water to washer. Adding water lifts the items off the washplate, resulting in less effective cleaning.
		Run clean washer cycle to optimize the water level and wash performance.

# TROUBLESHOOTING

First try the solutions suggested here for assistance and to possibly avoid a service call.

If you experience	Possible Causes	Solution
<b>Washer not performing as expected (cont.)</b>		
Washer won't run or fill, washer stops working	Check for proper water supply.	Both hoses must be attached and have water flowing to inlet valve.
		Both hot and cold water faucets must be turned on.
		Check that inlet valve screens have not become clogged.
		Check for any kinks in inlet hoses, which can restrict water flow.

## ⚠ WARNING



### Electrical Shock Hazard

**Plug into a grounded 3 prong outlet.**

**Do not remove ground prong.**

**Do not use an adapter.**

**Do not use an extension cord.**

**Failure to follow these instructions can result in death, fire, or electrical shock.**

Washer won't run or fill, washer stops working (cont.)	Check proper electrical supply.	Plug power cord into a grounded 3-prong outlet.	
		Do not use an extension cord.	
		Ensure there is power to outlet.	
		Reset a tripped circuit breaker. Replace any blown fuses. <b>NOTE:</b> If problems continue, contact an electrician.	
	Normal washer operation.		Lid must be closed for washer to run.
			Washer will pause during certain phases of cycle. Do not interrupt cycle.
			Washer may be stopped to reduce suds.
	Washer may be tightly packed.		Remove several items, rearrange load evenly around the washplate. Close lid, touch and hold START/PAUSE/Unlock Lid button.
			Add only 1 or 2 additional items after washer has started.
			Do not add more water to the washer.
Not using HE detergent, using too much HE detergent.		Only use HE detergent. Suds from regular detergents can slow or stop the washer. Always measure detergent and following detergent directions based on your load requirements.	
		To remove suds, cancel cycle. Select RINSE & SPIN. Touch and hold START/PAUSE/Unlock Lid button. Do not add more detergent.	
Washer not draining/spinning, loads are still wet	Small items may have been caught in pump or between basket and tub, which can slow draining.	Empty pockets and use garment bags for small items.	
	Using cycles with a lower spin speed.	Cycles with lower spin speeds remove less water than cycles with high spin speeds. Use the recommended cycle/speed spin for your item.	



# TROUBLESHOOTING

First try the solutions suggested here for assistance and to possibly avoid a service call.

If you experience	Possible Causes	Solution
<b>Washer not performing as expected (cont.)</b>		
Washer not draining/ spinning, loads are still wet (cont.)	Washer may be tightly packed or unbalanced.	Tightly packed loads may not allow the washer to spin correctly, leaving the load wetter than normal. Evenly arrange the wet load for balanced spinning. Select RINSE & SPIN to remove excess water. See "Using Your Washer" for loading recommendations.
	Load off balanced.	See "Vibration or Off-Balance" in Troubleshooting section for more information.
	Check plumbing for correct drain hose installation. Drain hose extends into standpipe farther than 4.5" (114 mm).	Check drain hose for proper installation. Use drain hose form and securely attach to drainpipe or tub. Do not tape over drain opening. Lower drain hose if the end is higher than 96" (2.4 m) above the floor. Remove any clogs from drain hose.
	Not using HE detergent, using too much HE detergent.	Suds from regular or too much detergent can slow/stop draining or spinning. Use only HE detergent. Always measure and follow directions for your load. To remove extra suds, Select RINSE & SPIN.
Incorrect or wrong wash or rinse temperatures	Check for proper water supply.	Make sure hot and cold inlet hoses are not reversed.
		Both hoses must be attached to both washer and faucet, and have both hot and cold water flowing to inlet valve.
		Check that inlet valve screens are not clogged.
		Remove any kinks in hoses.
Energy-saving controlled wash temperatures.	ENERGY STAR® qualified washers use cooler wash and rinse water temperatures than traditional top-load washers. This includes cooler hot and warm washes.	
Load not rinsed	Check for proper water supply.	Make sure hot and cold inlet hoses are not reversed.
		Both hoses must be attached and have water flowing to the inlet valve.
		Both hot and cold water faucets must be on.
		Inlet valve screens on washer may be clogged.
		Remove any kinks in the inlet hose.
	Not using HE detergent, using too much HE detergent, or using.	The suds from regular detergent can cause the washer to operate incorrectly.
		Use only HE detergent. Be sure to measure correctly.
		Always measure detergent and follow detergent directions based on load size and soil level.
	Washer may be tightly packed.	The washer is less efficient at rinsing when load is tightly packed.
		Load items in loose heaps evenly around the washplate.
Use cycle designed for the fabrics being washed.		
Add only 1 or 2 additional items after washer has started.		
Sand, pet hair, lint, etc. on load after washing	Heavy sand, pet hair, lint, and detergent or bleach residues may require additional rinsing.	Add an Extra Rinse to the selected cycle.
Load is tangling	Washer not loaded as recommended.	Load items in loose heaps evenly around the washplate. Reduce tangling by mixing types of load items. Use the recommended cycle for the type of items being washed.
	Wash action and/or spin speed too fast for load.	Select a cycle with a slower wash action and slower spin speed. Note that items will be wetter than when using a higher speed spin.
Not cleaning or removing stains	Wash load not completely covered in water.	Washer senses load size and adds correct amount of water. This is normal and necessary for clothes to move.
	Added more water to washer.	Do not add more water to washer. Adding water lifts the items off the washplate, resulting in less effective cleaning.
	Washer not loaded as recommended.	Load items in loose heaps evenly around the washplate.
		Add only 1 or 2 additional items after washer has started.

# TROUBLESHOOTING

First try the solutions suggested here for assistance and to possibly avoid a service call.

If you experience	Possible Causes	Solution
<b>Washer not performing as expected (cont.)</b>		
Not cleaning or removing stains (cont.)	Not using HE detergent, using too much HE detergent.	The suds from regular detergent can prevent washer from operating correctly.
		Use only HE detergent. Be sure to measure correctly.
		Always measure detergent and follow detergent directions based on load size and soil level.
	Not using correct cycle for fabric type.	Use a higher soil level cycle option and warmer wash temperature to improve cleaning.
		If using Quick cycle, wash only a few items.
		Use Whites Normal cycle for tough cleaning.
		See the "Cycle Guide" to match your load with the best cycle.
	Not using dispensers.	Use dispensers to avoid chlorine bleach and fabric softener staining.
		Load dispensers before starting a cycle.
		Avoid overfilling.
Do not add products directly onto load.		
Not washing like colors together.	Wash like colors together and remove promptly after the cycle is complete to avoid dye transfer.	
Using the wrong detergent concentration level.	The correct detergent concentration level must be used, and the washer must be set to the correct concentration level. See "Changing detergent concentration level" under "Dispensers."	
Odors	Monthly maintenance not done as recommended.	Run the Clean Washer cycle after every 30 washes. See "Washer Care" in "Washer Maintenance."
		Unload washer as soon as cycle is complete.
	Not using HE detergent, using too much HE detergent.	Use only HE detergent. Be sure to measure correctly.
		Always follow the detergent directions.
		See "Washer Care" section.
Fabric damage	Sharp items were in pockets during wash cycle.	Empty pockets, zip zippers, and snap or hook fasteners before washing to avoid snags and tears.
	Strings and straps could have tangled.	Tie all strings and straps before starting wash load.
	Items may have been damaged before washing.	Mend rips and broken threads in seams before washing.
	Fabric damage can occur if the load is tightly packed.	Load items in loose heaps evenly around washplate.
		Load items should move freely during wash to avoid damage.
		Use cycle designed for the fabrics being washed.
		Add only 1 or 2 additional items after washer has started.
	Garment care instructions may not have been followed.	Always read and follow garment manufacturer's care label instructions. See the "Cycle Guide" to match your load with the best cycle.
	Liquid chlorine bleach may have been added incorrectly.	Do not pour liquid chlorine bleach directly onto load. Wipe up bleach spills.
		Undiluted bleach will damage fabrics. Do not use more than recommended by manufacturer.
		Do not place load items on top of bleach dispenser when loading and unloading washer.
Do not use the liquid chlorine bleach and Oxi products at the same time.		

# TROUBLESHOOTING

First try the solutions suggested here for assistance and to possibly avoid a service call.

If you experience	Possible Causes	Solution
<b>Washer not performing as expected (cont.)</b>		
Incorrect dispenser operation	Clogged dispensers or laundry products dispensing too soon.	Do not overfill dispenser. Overfilling causes immediate dispensing.
		Load dispensers before starting a cycle.
		It is normal for small amounts of water to be remain in dispenser at the end of the cycle.
		Homes with low water pressure may result in residual powder in the dispenser. To avoid, select a warmer wash temperature if possible, depending on your load.
Single-dose laundry packet not dissolving	Adding laundry packet incorrectly.	Be sure laundry packet is added to washer basket before adding clothes. Follow the manufacturer's instructions to avoid damage to your items.
Control panel not responding to touch	Control Lock is on.	Be sure to turn the control lock off when you want to modify settings or use the control panel.
<b>Error Code Appears in Display</b>		
"LF" (F8E1) (too long to fill) appears in display	Washer taking too long to fill. Drain extends more than 4.5" (114 mm) into standpipe.	Check plumbing for correct drain hose installation. Use drain hose form and attach securely to drainpipe or tub. Do not tape over drain opening. See Installation Instructions.
F#E# code (F-type error code) appears in display	System error code.	Touch POWER to clear the code and exit cycle. Then touch POWER, select cycle, and then touch and hold START/PAUSE/Unlock Lid to start washer. If code appears again, call for service.
F1E1 ACU (Appliance control fault)	Internal ACU failure.	Call for service.
F2E3 UI/ACU mismatch	ACU/UI initialization error.	Call for service.
F3E1 Water level sensing failure	Pressure sensor on ACU failure.	Call for service.
F5E2 Lid lock will not lock is lid lock failure	An item in the load may be keeping the lid from locking.	Check for items directly under the lid.
F5E3 Lid cannot unlock	Objects on washer lid prevent it from unlocking.	Remove objects, such as baskets of laundry, from top of washer.
F6E2 or F6E3 Communication Error: UI cannot communicate	ACU or UI synchronization error.	Remove power from the washer. Let washer set for 5 minutes for the washer to completely power down. Apply power to washer and check for error codes. If the error code persists call for service.
F8E6 (Lid opened) appears in display	Washer lid left open.	Close the lid and touch Power to clear the display. If the lid is left open for more than 10 minutes, the cycle will reset and water in the washer will drain.
"drn" "dr" (F9E1) (drain pump system problem - long drain) appears in display	Washer taking too long to drain water. Drain extends more than 4.5" (114 mm) into standpipe.	Check plumbing for correct drain hose installation. Use drain hose form and attach securely to drainpipe or tub. Do not tape over drain opening.
		Lower drain hose if the end is higher than 96" (2.4 m) above the floor. Remove any clogs from drain hose. See Installation Instructions.
"Ofb" (off balance)	Load not balanced.	Open the lid, redistribute the load, close the lid, and press START/PAUSE/Unlock Lid.

# Kenmore®

## Customer Care Hotline

To schedule in-home repair service  
or order replacement parts

Para pedir servicio de reparación  
a domicilio, y ordenar piezas

# 1-844-553-6667

[www.kenmore.com](http://www.kenmore.com)

