

THANK YOU for purchasing this high-quality product. Register your range at www.kitchenaid.com. In Canada, register your range at www.kitchenaid.ca.

For future reference, please make a note of your product model and serial numbers. These can be found on the label located on the oven frame behind the top-right side of the oven door.

Model Number _____ Serial Number _____

Table of Contents

RANGE SAFETY	2
The Anti-Tip Bracket	3
KEY USAGE TIPS	5
AquaLift® Self-Cleaning Technology	5
Surface Temperatures	5
Preheating	5
Surface Burners	5
FEATURE GUIDE	6
Electronic Oven Controls	9
COOKTOP	10
Surface Burners	11
Surface Grates	12
Burner Size	12
Griddle	12
Cookware	13
OVEN	14
Aluminum Foil	14
Positioning Racks and Bakeware	14
Home Canning	14
Roll-Out Rack	15
Oven Vent	16
Sabbath Mode	16
Baking and Roasting	16
Broiling	17
Convection Cooking	17
Proofing Bread	17
Cook Time	18
Baking Drawer	18
Oven Light	18
RANGE CARE	19
Clean Cycle	19
General Cleaning	20
Remove/Replace Drawer	21
TROUBLESHOOTING	22
ACCESSORIES	24
WARRANTY	25

RANGE SAFETY

Your safety and the safety of others are very important.

We have provided many important safety messages in this manual and on your appliance. Always read and obey all safety messages.



This is the safety alert symbol.

This symbol alerts you to potential hazards that can kill or hurt you and others.

All safety messages will follow the safety alert symbol and either the word "DANGER" or "WARNING."

These words mean:

⚠ DANGER

You can be killed or seriously injured if you don't immediately follow instructions.

⚠ WARNING

You can be killed or seriously injured if you don't follow instructions.

All safety messages will tell you what the potential hazard is, tell you how to reduce the chance of injury, and tell you what can happen if the instructions are not followed.

WARNING: If the information in these instructions is not followed exactly, a fire or explosion may result causing property damage, personal injury or death.

- Do not store or use gasoline or other flammable vapors and liquids in the vicinity of this or any other appliance.
- **WHAT TO DO IF YOU SMELL GAS:**
 - Do not try to light any appliance.
 - Do not touch any electrical switch.
 - Do not use any phone in your building.
 - Immediately call your gas supplier from a neighbor's phone. Follow the gas supplier's instructions.
 - If you cannot reach your gas supplier, call the fire department.
- Installation and service must be performed by a qualified installer, service agency or the gas supplier.

WARNING: Gas leaks cannot always be detected by smell.

Gas suppliers recommend that you use a gas detector approved by UL or CSA.

For more information, contact your gas supplier.

If a gas leak is detected, follow the "What to do if you smell gas" instructions.

The Anti-Tip Bracket

The range will not tip during normal use. However, the range can tip if you apply too much force or weight to the open door without having the anti-tip bracket fastened down properly.

⚠ WARNING

Tip Over Hazard

A child or adult can tip the range and be killed.

Verify the anti-tip bracket has been properly installed and engaged per installation instructions.

Re-engage anti-tip bracket if range is moved.

Do not operate range without anti-tip bracket installed and engaged.

Failure to follow these instructions can result in death or serious burns to children and adults.

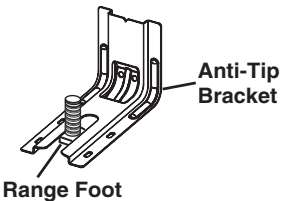

To verify the anti-tip bracket is installed and engaged:

- Slide range forward.
- Look for the anti-tip bracket securely attached to floor or wall.
- Slide range back so rear range foot is under anti-tip bracket.
- See installation instructions for details.

IMPORTANT SAFETY INSTRUCTIONS

WARNING: To reduce the risk of fire, electrical shock, injury to persons, or damage when using the range, follow basic precautions, including the following:

- **WARNING:** TO REDUCE THE RISK OF TIPPING OF THE RANGE, THE RANGE MUST BE SECURED BY PROPERLY INSTALLED ANTI-TIP DEVICES. TO CHECK IF THE DEVICES ARE INSTALLED PROPERLY, SLIDE RANGE FORWARD, LOOK FOR ANTI-TIP BRACKET SECURELY ATTACHED TO FLOOR OR WALL, AND SLIDE RANGE BACK SO REAR RANGE FOOT IS UNDER ANTI-TIP BRACKET.
 - **WARNING:** NEVER use this appliance as a space heater to heat or warm the room. Doing so may result in carbon monoxide poisoning and overheating of the oven.
 - **WARNING:** NEVER cover any slots, holes or passages in the oven bottom or cover an entire rack with materials such as aluminum foil. Doing so blocks air flow through the oven and may cause carbon monoxide poisoning. Aluminum foil linings may also trap heat, causing a fire hazard.
 - **CAUTION:** Do not store items of interest to children in cabinets above a range or on the backguard of a range – children climbing on the range to reach items could be seriously injured.
 - Do Not Leave Children Alone – Children should not be left alone or unattended in area where the range is in use. They should never be allowed to sit or stand on any part of the range.
 - Wear Proper Apparel – Loose-fitting or hanging garments should never be worn while using the range.
 - User Servicing – Do not repair or replace any part of the range unless specifically recommended in the manual. All other servicing should be referred to a qualified technician.
 - Storage in or on the Range – Flammable materials should not be stored in an oven or near surface units.
 - Do Not Use Water on Grease Fires – Smother fire or flame or use dry chemical or foam-type extinguisher.
 - Use Only Dry Potholders – Moist or damp potholders on hot surfaces may result in burns from steam. Do not let potholder touch hot heating elements. Do not use a towel or other bulky cloth.
 - DO NOT TOUCH SURFACE UNITS OR AREAS NEAR UNITS – Surface units may be hot even though they are dark in color. Areas near surface units may become hot enough to cause burns. During and after use, do not touch, or let clothing or other flammable materials contact surface units or areas near units until they have had sufficient time to cool. Among those areas are the cooktop and surfaces facing the cooktop.
 - Never Leave Surface Units Unattended at High Heat Settings – Boilover causes smoking and greasy spillovers that may ignite.
 - Glazed Cooking Utensils – Only certain types of glass, glass/ceramic, ceramic, earthenware, or other glazed utensils are suitable for range-top service without breaking due to the sudden change in temperature.
 - Utensil Handles Should Be Turned Inward and Not Extend Over Adjacent Surface Units – To reduce the risk of burns, ignition of flammable materials, and spillage due to unintentional contact with the utensil, the handle of a utensil should be positioned so that it is turned inward, and does not extend over adjacent surface units.
 - Clean Cooktop With Caution – If a wet sponge or cloth is used to wipe spills on a hot cooking area, be careful to avoid steam burn. Some cleaners can produce noxious fumes if applied to a hot surface.
 - Use Care When Opening Door – Let hot air or steam escape before removing or replacing food.
 - Do Not Heat Unopened Food Containers – Build-up of pressure may cause container to burst and result in injury.
 - Keep Oven Vent Ducts Unobstructed.
 - Placement of Oven Racks – Always place oven racks in desired location while oven is cool. If rack must be moved while oven is hot, do not let potholder contact hot heating element in oven.
 - DO NOT TOUCH HEATING ELEMENTS OR INTERIOR SURFACES OF OVEN – Heating elements may be hot even though they are dark in color. Interior surfaces of an oven become hot enough to cause burns. During and after use, do not touch, or let clothing or other flammable materials contact heating elements or interior surfaces of oven until they have had sufficient time to cool. Other surfaces of the appliance may become hot enough to cause burns – among these surfaces are oven vent openings and surfaces near these openings, oven doors, and windows of oven doors.
 - Proper Installation – The range, when installed, must be electrically grounded in accordance with local codes or, in the absence of local codes, with the *National Electrical Code, ANSI/NFPA 70*. In Canada, the range must be electrically grounded in accordance with Canadian Electrical Code. Be sure the range is properly installed and grounded by a qualified technician.
 - Disconnect the electrical supply before servicing the appliance.
 - Injuries may result from the misuse of appliance doors or drawers such as stepping, leaning, or sitting on the doors or drawers.
 - Maintenance – Keep range area clear and free from combustible materials, gasoline, and other flammable vapors and liquids.
 - Top burner flame size should be adjusted so it does not extend beyond the edge of the cooking utensil.
- For self-cleaning ranges –**
- Do Not Clean Door Gasket – The door gasket is essential for a good seal. Care should be taken not to rub, damage, or move the gasket.
 - Do Not Use Oven Cleaners – No commercial oven cleaner or oven liner protective coating of any kind should be used in or around any part of the oven.
 - Clean Only Parts Listed in Manual.
 - Before Self-Cleaning the Oven – Remove broiler pan and other utensils. Wipe off all excessive spillage before initiating the cleaning cycle.
- For units with ventilating hood –**
- Clean Ventilating Hoods Frequently – Grease should not be allowed to accumulate on hood or filter.
 - When flambéing foods under the hood, turn the fan on.

SAVE THESE INSTRUCTIONS

KEY USAGE TIPS

AquaLift® Self-Cleaning Technology



AquaLift® Self-Cleaning Technology is a first-of-its-kind cleaning solution designed to minimize the time, temperature, and odors that ordinarily come with traditional self-cleaning methods. With AquaLift® Self-Cleaning Technology, an exclusive coating on the interior of the oven, is activated with heat and water to release baked-on soil. To use AquaLift® Self-Cleaning Technology, simply wipe out loose debris, pour water into the oven bottom, and run the AquaLift® Self-Cleaning cycle. When the cycle finishes in under 1 hour at a lower temperature than in traditional self-cleaning methods, just wipe out the remaining water and loose debris. See the “Clean Cycle” section for more detailed instructions. For additional information, frequently asked questions, and videos on using AquaLift® Self-Cleaning Technology, visit our website at <http://whirlpoolcorp.com/aqualift>.

Surface Temperatures

When the range is in use, all range surfaces may become hot, such as the knobs and oven door.

Baking Drawer

When the oven is in use, the drawer may become hot. Do not store plastics, cloth, or other items that could melt or burn in the drawer.

Oven Vent

The oven vent releases hot air and moisture from the oven, and should not be blocked or covered. Do not set plastics, paper, or other items that could melt or burn near the oven vent.

Preheating

When beginning a Bake, Convection Bake or Convection Roast cycle, the oven will begin preheating after Start is pressed. The oven will take approximately 12 to 15 minutes to reach 350°F (177°C) with all of the oven racks provided with your oven inside the oven cavity. Higher temperatures will take longer to preheat. The preheat cycle rapidly increases the oven temperature. The actual oven temperature will go above your set temperature to offset the heat lost when your oven door is opened to insert food. This ensures that when you place your food in the oven, the oven will begin at the proper temperature. Insert your food when the preheat tone sounds. Do not open the door during preheat before the tone sounds.

Surface Burners

The burner bases and caps must be properly positioned before cooking. Your range comes with three sizes of burners and caps. Each round burner base is marked with a letter indicating the burner size. Align the burner bases as shown in the following illustration:

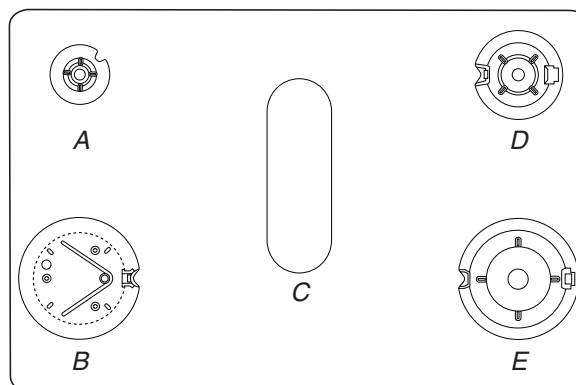

A. Small (S) C. Oval D. Medium (M)
B. X-Large (XL) E. Large (L)

Align the gas tube opening in the burner base with the orifice holder on the cooktop and the igniter electrode with the notch in the burner base.

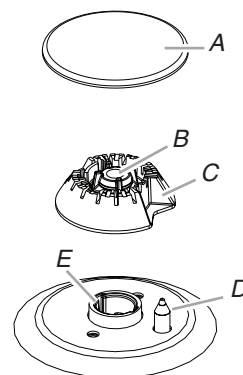

A. Burner cap D. Igniter electrode
B. Gas tube opening E. Orifice holder
C. Burner base

Place the burner caps on the appropriate burner bases. Each round burner cap is marked with a letter indicating the burner size.

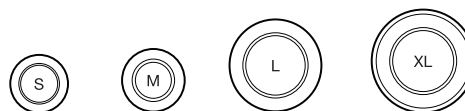

Small cap (S) Medium cap (M) Large cap (L) X-Large cap (XL)

Burner caps should be level when properly positioned. If burner caps are not properly positioned, surface burners will not light. The burner cap should not rock or wobble when properly aligned.

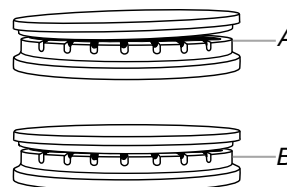

A. Incorrect
B. Correct

FEATURE GUIDE

This manual covers several models. Your model may have some or all of the items listed. Refer to this manual or the Product Help section of our website at www.kitchenaid.com for more detailed instructions. In Canada, refer to the Product Help Section at www.kitchenaid.ca.

⚠ WARNING

Food Poisoning Hazard

Do not let food sit for more than one hour before or after cooking.

Doing so can result in food poisoning or sickness.



Keypad	Feature	Instructions
CLOCK/TOOLS	Clock	The Clock can use a 12- or 24-hour cycle. See the “Electronic Oven Controls” section. <ol style="list-style-type: none"> 1. Press CLOCK/TOOLS until “CLOCK” is displayed. 2. Use the number keypads to set the time of day. 3. Press START to change the time. 4. Press “3” for AM or “6” for PM.
CLOCK/TOOLS	Settings	Enables you to personalize the audible tones and oven operation to suit your needs. See the “Electronic Oven Controls” section.
OVEN LIGHT	Oven cavity light	The oven light is controlled by a keypad on the oven control panel. While the oven door is closed, press OVEN LIGHT to turn the light On and Off. When the oven door is opened, the oven light will automatically come On.
TIMER SET/OFF	Oven timer	The Timer can be set in hours or minutes up to 9 hours and 59 minutes. <ol style="list-style-type: none"> 1. Press TIMER SET/OFF. 2. Press the number keypads to set the length of time in hr-min-min. Leading zeros do not have to be entered. For example, for 2 minutes, enter “2.” 3. Press TIMER SET/OFF to begin the countdown. If enabled, end-of-cycle tones will sound at end of countdown. 4. Press TIMER SET/OFF again to cancel the Timer and return to the time of day. Do not press the Cancel keypad because the oven will turn off. 5. If the Timer is running, but not in the display, press TIMER SET/OFF to display the countdown for 5 seconds.
START	Cooking start	The Start keypad begins any oven function. If Start is not pressed within 2 minutes after pressing a keypad, the function is canceled and the time of day is displayed.
CANCEL UPPER CANCEL LOWER (on some models)	Range function	The Cancel keypad stops any function for the appropriate oven or drawer, except the Clock and Timer.
BAKE	Baking and roasting	<ol style="list-style-type: none"> 1. Press BAKE. 2. Press the number keypads to set the desired temperature. If the temperature entered is not in the range of the temperatures allowed, the minimum or maximum allowed temperature will be displayed. Enter a temperature in the allowable range. 3. Press START. 4. To change the temperature, repeat steps 2 and 3. 5. Press CANCEL UPPER when finished.

KEYPAD	FEATURE	INSTRUCTIONS
STEAM BAKE	Steam bake	<ol style="list-style-type: none"> 1. Insert the steam rack with water reservoir in the oven. 2. Pour 1½ cups (350 mL) of warm water into the water reservoir. NOTE: Do not fill past the MAX mark. 3. Press STEAM BAKE. 4. Press the number keypad to select the desired food option. 5. Press the number keypads to set the temperature. 6. Press START. 7. (Optional) Press COOK TIME. Press the number keypads to set the cook time. 8. Press START. 9. Insert food when preheating finishes. 10. Press CANCEL UPPER when finished. NOTE: Let oven cool before removing and emptying water reservoir.
BROIL	Broiling	<ol style="list-style-type: none"> 1. Press BROIL. 2. Press the number keypads to set the desired temperature. If the temperature entered is not in the range of the temperatures allowed, the minimum or maximum allowed temperature will be displayed. Enter a temperature in the allowable range. 3. Press START and allow the oven to preheat for 5 minutes. 4. To change the temperature, repeat steps 2 and 3. 5. Position the cookware in the oven, and then close the door. 6. Press CANCEL UPPER when finished.
PROOF	Proofing bread	<ol style="list-style-type: none"> 1. Place prepared dough in oven. Press PROOF. 2. Press START. Let the dough rise until nearly doubled in size. Proofing time may vary depending on dough type and quantity. 3. Press CANCEL UPPER when finished proofing. Refer to the “Proofing Bread” section for more information.
KEEP WARM	Hold warm	<p>Food must be at serving temperature before placing it in the warmed oven.</p> <ol style="list-style-type: none"> 1. Press KEEP WARM. 2. Press the number keypads to set the desired temperature. If the temperature entered is not in the range of the temperatures allowed, the minimum or maximum allowed temperature will be displayed. Enter a temperature in the allowable range. 3. Press START. 4. Press CANCEL UPPER when finished.
EASY CONVECT BAKE	Convection cooking	<ol style="list-style-type: none"> 1. Press EASY CONVECT BAKE. 2. Press “1” to have the oven automatically convert the temperature and time for convection baking. Press “2” to manually convert the temperature and time. 3. Press the number keypads to set the desired temperature. If the temperature entered is not in the range of the temperatures allowed, the minimum or maximum allowed temperature will be displayed. Enter a temperature in the allowable range. 4. Press START. 5. (Optional) Press the number keypads to set a cook time. 6. Press START. 7. To change the temperature, repeat steps 2 and 3. 8. Press CANCEL UPPER when finished.
EASY CONVECT BROIL	Convection cooking	<ol style="list-style-type: none"> 1. Press EASY CONVECT BROIL. 2. Press “1” to have the oven automatically convert the temperature and time for convection baking. Press “2” to manually convert the temperature and time. 3. Press the number keypads to set the desired temperature. If the temperature entered is not in the range of the temperatures allowed, the minimum or maximum allowed temperature will be displayed. Enter a temperature in the allowable range. 4. Press START. 5. (Optional) Press the number keypads to set a cook time. 6. Press START. 7. To change the temperature, repeat steps 2 and 3. 8. Press CANCEL UPPER when finished.

KEYPAD	FEATURE	INSTRUCTIONS
EASY CONVECT ROAST	Convection cooking	<ol style="list-style-type: none"> 1. Press EASY CONVECT ROAST. 2. Press “1” to have the oven automatically convert the temperature and time for convection baking. Press “2” to manually convert the temperature and time. 3. Press the number keypads to set the desired temperature. If the temperature entered is not in the range of the temperatures allowed, the minimum or maximum allowed temperature will be displayed. Enter a temperature in the allowable range. 4. Press START. 5. (Optional) Press the number keypads to set a cook time. 6. Press START. 7. To change the temperature, repeat steps 2 and 3. 8. Press CANCEL UPPER when finished.
COOK TIME	Timed cooking	<p>Timed cooking allows the oven to be set to turn on at a certain time of day, cook for a set length of time, and/or shut off automatically.</p> <p>To set a Timed Cook or a Delayed Timed Cook, see the “Cook Time” section.</p>
DELAY START	Delayed start	<p>The Delay Start keypad is used to enter the starting time for an oven function with a delayed start. Delay Start should not be used for foods such as breads and cakes because they may not bake properly.</p> <p>To set a Timed Cook or a Delayed Timed Cook, see the “Cook Time” section.</p>
BAKING DRAWER BAKE (on some models)	Baking drawer	<ol style="list-style-type: none"> 1. Press BAKING DRAWER BAKE. 2. Press the number keypads to set the desired temperature. If the temperature entered is not in the range of the temperatures allowed, the minimum or maximum allowed temperature will be displayed. Enter a temperature in the allowable range. 3. Press START. 4. To change the temperature, repeat steps 2 and 3. 5. Press CANCEL LOWER when finished.
BAKING DRAWER SLOW COOK (on some models)	Slow cook drawer	<ol style="list-style-type: none"> 1. Press BAKING DRAWER SLOW COOK. 2. Press the number keypads to set the desired temperature. If the temperature entered is not in the range of the temperatures allowed, the minimum or maximum allowed temperature will be displayed. Enter a temperature in the allowable range. 3. Place the food(s) in the baking drawer. 4. Press START. 5. (Optional) Set the desired cook time using the number keypads. 6. Press START to begin heating the baking drawer. 7. Press CANCEL LOWER when finished.
BAKING DRAWER KEEP WARM (on some models)	Warming drawer	<p>Food must be at serving temperature before placing it in the warmed oven.</p> <ol style="list-style-type: none"> 1. Press BAKING DRAWER KEEP WARM. 2. Press the number keypads to set the desired temperature. If the temperature entered is not in the range of the temperatures allowed, the minimum or maximum allowed temperature will be displayed. Enter a temperature in the allowable range. 3. Press START. 4. Press CANCEL LOWER when finished.
AQUALIFT SELF CLEAN	Clean cycle	See the “Clean Cycle” section.
START (Control Lock Hold 3 Sec)	Oven control lockout	<ol style="list-style-type: none"> 1. Check that the oven is OFF. 2. Press and hold START (Hold 3 Sec) for 3 seconds. 3. A tone will sound, and “Control Locked” will scroll, and then “Locked” will be displayed. 4. Repeat to unlock. No keypads will function with the controls locked. The cooktop functions are not affected by the oven control lockout.
CLOCK/TOOLS	Energy save	<ol style="list-style-type: none"> 1. Press CLOCK/ TOOLS until “ENERGY SAVE” is displayed. 2. The current setting will be displayed. 3. Press the “1” keypad to adjust the setting. 4. Press CANCEL to exit and display the time of day. <p>If Energy Save is ON, the range will go into Sleep mode after 5 minutes of inactivity. Any keypad press will activate the display. If Energy Save is OFF, the display will be ON at all times.</p>

Electronic Oven Controls

Control Display

The display will flash when powered up or after a power loss. Press CANCEL UPPER to clear. When the oven is not in use, the time of day is displayed. If the range is in Energy Save mode, the display will be blank when not in use.

Tones

Tones are audible signals, indicating the following:

One Tone

- Valid keypad press
- Oven is preheated (long tone).
- Function has been entered.
- Reminder, repeating each minute after the end-of-cycle tones

Three Tones

- Invalid keypad press

Four Tones

- End-of-cycle

Use the Clock/Tools keypad to change the tone settings.

Energy Save

The Energy Save mode puts the range into Sleep mode and reduces energy consumption.

To Activate the Energy Save Mode:

1. Press CLOCK/TOOLS until "ENERGY SAVE" is displayed.
2. The current setting will be displayed.
3. Press the "1" keypad to adjust the setting.
4. Press CANCEL to exit and display the time of day.
5. The setting will be activated after 5 minutes.

To Deactivate the Energy Save Mode:

1. Press CLOCK/TOOLS until "ENERGY SAVE" is displayed.
2. The current setting will be displayed.
3. Press the "1" keypad to adjust the setting.
4. Press CANCEL to exit and display the time of day.
5. The clock will reappear in the display and the range can be operated as usual.

Settings

Many features of the oven control can be adjusted to meet your personal needs. These changes are made using the Clock/Tools keypad.

Use the Clock/Tools keypad to scroll through the features that can be changed. Each press of the Clock/Tools keypad will advance the display to the next setting. After selecting the feature to be changed, the control will prompt you for the required input. Then press START or CANCEL UPPER to exit and display the time of day. Details of all of the feature changes are explained in the following sections.

Press CANCEL UPPER to exit Settings.

Clock

The Clock can use a 12- or 24-hour cycle.

1. Press CLOCK/TOOLS until "CLOCK" is displayed.
2. Use the number keypads to set the time of day.
3. Press START to change the time.
4. Press "3" for AM or "6" for PM.

Fahrenheit and Celsius

The temperature is preset to Fahrenheit but can be changed to Celsius.

1. Press CLOCK/TOOLS until "TEMP UNIT" is displayed.
2. The current setting will be displayed.
3. Press the "1" keypad to adjust the setting.
4. Press START or CANCEL UPPER to exit and display the time of day.

Audible Tones Disable

Turns off all tones, including the end-of-cycle tone and keypress tones. Reminder tones are still active when all tones are disabled.

1. Press CLOCK/TOOLS until "SOUND" is displayed.
2. The current setting will be displayed.
3. Press the "1" keypad to adjust the setting.
4. Press START or CANCEL UPPER to exit and display the time of day.

Sound Volume

Sets the volume of the tone to either high or low.

1. Press CLOCK/TOOLS until "SOUND VOLUME" is displayed.
2. The current setting will be displayed.
3. Press the "1" keypad to adjust the setting.
4. Press START or CANCEL UPPER to exit and display the time of day.

End-of-Cycle Tone

Activates or turns off the tones that sound at the end of a cycle.

1. Press CLOCK/TOOLS until "END TONE" is displayed.
2. The current setting will be displayed.
3. Press the "1" keypad to adjust the setting.
4. Press START or CANCEL UPPER to exit and display the time of day.

Keypress Tones

Activates or turns off the tones when a keypad is pressed.

1. Press CLOCK/TOOLS until "KEYPRESS TONE" is displayed.
2. The current setting will be displayed.
3. Press the "1" keypad to adjust the setting.
4. Press START or CANCEL UPPER to exit and display the time of day.

Reminder Tones Disable

Turns off the short repeating tone that sounds every 1 minute after the end-of-cycle tones.

1. Press CLOCK/TOOLS until "REMINDER TONE" is displayed.
2. The current setting will be displayed.
3. Press the "1" keypad to adjust the setting.
4. Press START or CANCEL UPPER to exit and display the time of day.

12/24 Hour Clock

1. Press CLOCK/TOOLS until "12/24 HOUR" is displayed.
2. The current setting will be displayed.
3. Press the "1" keypad to adjust the setting.
4. Press START or CANCEL UPPER to exit and display the time of day.

Demo Mode

IMPORTANT: This feature is intended for use on the sales floor with 120 V power connection and permits the control features to be demonstrated without the oven turning on. If this feature is activated, the oven will not work.

1. Press CLOCK/TOOLS until “DEMO MODE” is displayed.
2. The current setting will be displayed.
3. Press the “1” keypad to adjust the setting.
4. Press START or CANCEL UPPER to exit and display the time of day.

Sabbath Mode

The Sabbath mode sets the oven to remain ON in a bake setting until turned off.

When the Sabbath mode is set, only the Bake cycle will operate. All other cooking and cleaning cycles are disabled. No tones will sound and the displays will not indicate temperature changes.

When the oven door is opened or closed, the oven light will not turn on or off and the heating elements will not turn on or off immediately.

To Enable Sabbath Mode Capability (One Time Only):

1. Press CLOCK/TOOLS until “SABBATH” is displayed.
2. The current setting will be displayed.
3. Press the “1” keypad to adjust the setting.
4. Press START or CANCEL UPPER to exit and display the time of day.

12-Hour Shutoff

The oven control is set to automatically shut off the oven 12 hours after the oven initiates a cook or clean function. This will not interfere with any timed or delay cook functions.

1. Press CLOCK/TOOLS until “12Hr AUTO_OFF” is displayed.
2. The current setting will be displayed.
3. Press the “1” keypad to adjust the setting.
4. Press START or CANCEL UPPER to exit and display the time of day.

Languages - Scrolling Display Text

Language options are English, Spanish, and French.

1. Press CLOCK/TOOLS until “LANGUAGE” is displayed.
2. The current setting will be displayed.
3. Press the “1” or “2” keypad to select the desired language.
4. Press START or CANCEL UPPER to exit and display the time of day.

Oven Temperature Offset Control

IMPORTANT: Do not use a thermometer to measure oven temperature. Elements will cycle on and off as needed to provide consistent temperature but may run slightly hot or cool at any point in time due to this cycling. Most thermometers are slow to react to temperature change and will not provide an accurate reading due to this cycling.

The oven provides accurate temperatures; however, it may cook faster or slower than your previous oven, so the temperature can be adjusted to personalize it for your cooking needs. It can be changed to Fahrenheit or Celsius.

To Adjust Oven Temperature:

1. Press CLOCK/TOOLS until “TEMP CALIB” is displayed.
2. On some models, press “1” to adjust the drawer temperature calibration. Press START, wait 10 seconds for the display to change, and then continue with Step 3.

OR

Press START to adjust the oven temperature calibration. Wait 10 seconds for the display to change, and then continue with Step 3.

3. Press the “3” keypad to increase the temperature in 5°F (3°C) increments, or press the “6” keypad to decrease the temperature in 5°F (3°C) increments. The offset range is from -30°F to +30°F (-18°C to +18°C).
4. Press START or CANCEL UPPER to exit and display the time of day.

COOKTOP

WARNING





Fire Hazard

Do not let the burner flame extend beyond the edge of the pan.

Turn off all controls when not cooking.

Failure to follow these instructions can result in death or fire.

To Set:

1. Push in and turn knob counterclockwise to  .
All surface burners will click. Only the burner with the control knob turned to  will produce a flame.
2. Turn knob to anywhere between H (high) and L (low).

REMEMBER: When range is in use, the entire cooktop area may become hot.

Power Failure

In case of prolonged power failure, the surface burners can be lit manually. Hold a lit match near a burner, and then turn knob counterclockwise to  . After burner lights, turn knob to desired setting.

Electric igniters automatically light the surface burners when control knobs are turned to  .

Before setting a control knob, place filled cookware on the grate. Do not operate a burner using empty cookware or without cookware on the grate.

Surface Burners

IMPORTANT: Do not obstruct the flow of combustion and ventilation air around the burner grate edges.

Burner cap: Always keep the burner cap in place when using a surface burner. A clean burner cap will help avoid poor ignition and uneven flames. Always clean the burner cap after a spillover, and routinely remove and clean the caps according to the "General Cleaning" section.

NOTE: Each round burner cap is marked with a letter indicating the burner size.

Alignment: Be sure to align the gas tube opening in the burner base with the orifice holder on the cooktop and the igniter electrode with the notch in the burner base.

NOTE: Each round burner cap is marked with a letter indicating the burner size.

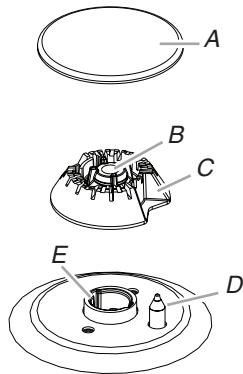

A. Burner cap D. Igniter electrode
 B. Gas tube opening E. Orifice holder
 C. Burner base

Gas Tube Opening: Gas must flow freely throughout the gas tube opening for the burner to light properly. Keep this area free of soil, and do not allow spills, food, cleaning agents or any other material to enter the gas tube opening. Keep spillovers out of the gas tube opening by always using a burner cap.

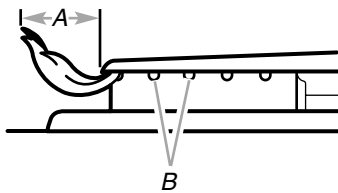

A. 1 to 1 1/2" (2.5 to 3.8 cm)
 B. Burner ports

Burner Ports: Check burner flames occasionally for proper size and shape as shown in the previous illustration. A good flame is blue in color, not yellow. Keep this area free of soil, and do not allow spills, food, cleaning agents or any other material to enter the burner ports.

To Clean:

IMPORTANT: Before cleaning, make sure all controls are off and the cooktop is cool. Do not use oven cleaners, bleach or rust removers. Do not wash in the dishwasher.

1. Remove the burner cap and the burner base and clean according to the "General Cleaning" section.
2. Clean the gas tube opening with a damp cloth.

3. Clean clogged burner ports with a straight pin as shown. Do not enlarge or distort the port. Do not use a wooden toothpick. If the burner needs to be adjusted, contact a trained repair specialist.

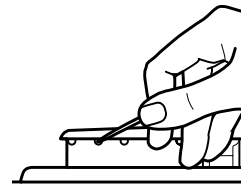

4. Replace the burner base. Each round burner base is marked with a letter indicating the burner size. See the following illustration for burner positions:

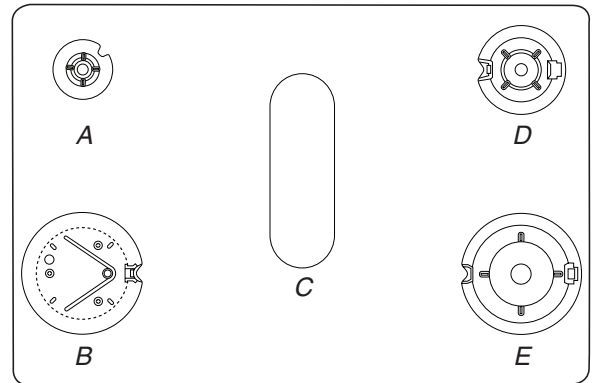

A. Small (S) C. Oval D. Medium (M)
 B. X-Large (XL) E. Large (L)

5. Replace the burner cap, making sure it is properly aligned with the burner base. The burner cap should not rock or wobble when properly aligned.

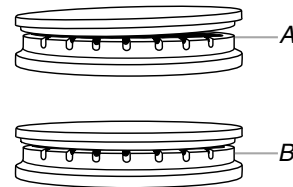

A. Incorrect
 B. Correct

IMPORTANT: The bottom of the small and medium caps are different. Do not put the wrong size burner cap on the burner base.

NOTE: Each round burner cap is marked with a letter indicating the burner size.

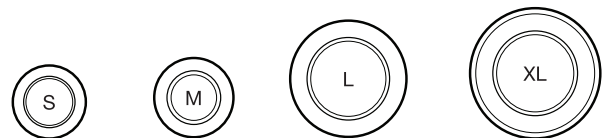

Small cap (S) Medium cap (M) Large cap (L) X-Large cap (XL)

6. Turn on the burner. If the burner does not light, check cap alignment. If the burner still does not light, turn off the burner. Do not service the burner yourself. Contact a trained repair specialist.

Surface Grates

The grates must be properly positioned before cooking. In the proper position, the grates should be flush and level. Improper installation of the grates may result in chipping or scratching of the cooktop.

To ensure proper positioning, align bumpers on grate bottom with the indentations in the cooktop.

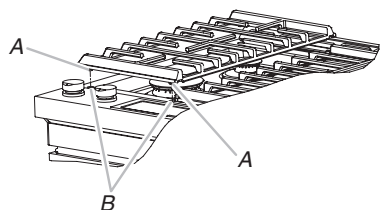

A. Bumpers
B. Alignment indentations

The surface grates interlock using the hooks on the middle grate and the indents on the end grates. To remove the grates, remove the end grates first, and then remove the middle grate. To replace the grates, replace the middle grate first, and then place the end grates on either side.

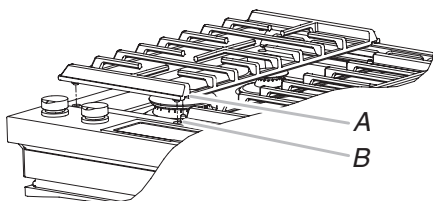

A. Indent
B. Hook

Although the burner grates are durable, they will gradually lose their shine and/or discolor due to the high temperatures of the gas flame.

Burner Size

Select a burner that best fits your cookware. See the following illustration and chart.

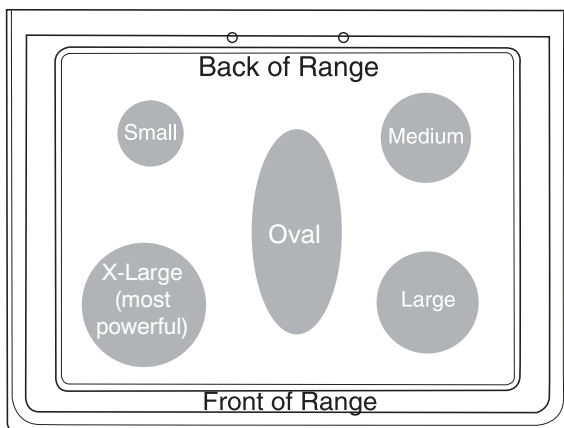

Burner Size	Recommended Use
Small	<ul style="list-style-type: none"> ■ Low-heat cooking ■ Melting chocolate or butter
Medium	<ul style="list-style-type: none"> ■ Multipurpose burner
Large	<ul style="list-style-type: none"> ■ For large cookware
X-Large (most powerful)	<ul style="list-style-type: none"> ■ For large cookware ■ Most powerful burner
Oval	<ul style="list-style-type: none"> ■ For longer dishes

Griddle

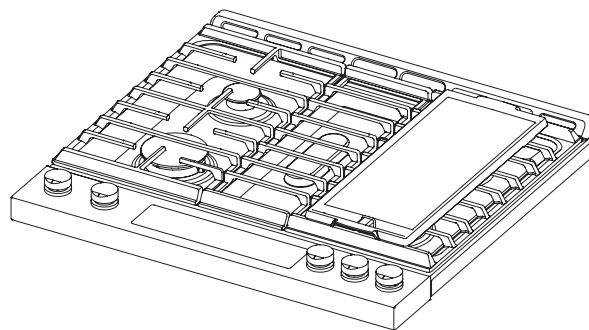

Griddle installed on right side of cooktop

To Use the Griddle:

1. Locate the griddle on the right side grate, as shown. The locating feet on the bottom of the griddle will engage the grate tines to keep the griddle from sliding.
2. Before each use, brush on a thin layer of cooking oil to keep food from sticking. Cooking sprays may leave a sticky residue on the griddle that is hard to remove.
3. Preheat the griddle for 5 minutes. Preheating the griddle slowly will ensure even heat distribution and will avoid warping the griddle.
4. For preheating and cooking, set the front burner to the lowest heat setting and the rear burner to medium-high heat for best performance.

NOTE: The griddle may also be used on the left side grate. For best results, the rear burner setting should be set to Medium-Low or Medium, and the front burner setting should be set to Low.

To Clean the Griddle:

1. Let the griddle cool, and then empty the drip tray.
2. See the "General Cleaning" section for cleaning instructions.
3. Store griddle in a cool dry place.

Cookware

IMPORTANT: Do not leave empty cookware on a hot surface cooking area, element or surface burner.

Ideal cookware should have a flat bottom, straight sides and a well-fitting lid, and the material should be of medium-to-heavy thickness.

Rough finishes may scratch the cooktop or coils. Aluminum and copper may be used as a core or base in cookware. However, when used as a base, they can leave permanent marks on the surfaces.

Cookware material is a factor in how quickly and evenly heat is transferred, which affects cooking results. A nonstick finish has the same characteristics as its base material. For example, aluminum cookware with a nonstick finish will take on the properties of aluminum.

Cookware with nonstick surfaces should not be used under the broiler.

Check for flatness by placing the straight edge of a ruler across the bottom of the cookware. While you rotate the ruler, no space or light should be visible between it and the cookware.

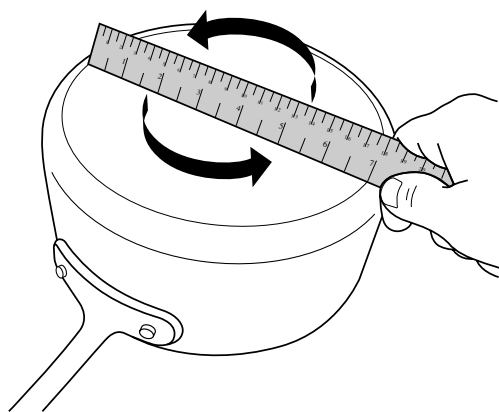

Use the following chart as a guide for cookware material characteristics.

Cookware	Characteristics
Aluminum	<ul style="list-style-type: none"> Heats quickly and evenly. Suitable for all types of cooking. Medium or heavy thickness is best for most cooking tasks. May leave aluminum residues, which may be diminished if cleaned immediately after cooking.
Cast iron	<ul style="list-style-type: none"> Heats slowly and evenly. Good for browning and frying. Maintains heat for slow cooking. Rough edges or burrs may scratch the cooktop.
Ceramic or Ceramic glass	<ul style="list-style-type: none"> Follow manufacturer's instructions. Heats slowly, but unevenly. Ideal results on low to medium heat settings. May scratch the cooktop.

Cookware	Characteristics
Copper	<ul style="list-style-type: none"> Heats very quickly and evenly. May leave copper residues, which may be diminished if cleaned immediately after cooking. Can leave a permanent stain or bond to the cooktop if overheated.
Earthenware	<ul style="list-style-type: none"> Follow manufacturer's instructions. Use on low heat settings. May scratch the cooktop.
Porcelain enamel-on-steel or cast iron	<ul style="list-style-type: none"> See stainless steel or cast iron. Porcelain enamel bakeware without the metal base may bond to the cooktop if overheated.
Stainless steel	<ul style="list-style-type: none"> Heats quickly, but unevenly. A core or base of aluminum or copper on stainless steel provides even heating.

Use flat-bottomed cookware for best cooking results and energy efficiency. The cookware should be about the same size as the cooking area outlined on the cooktop. Cookware should not extend more than 1/2" (1.3 cm) outside the area.

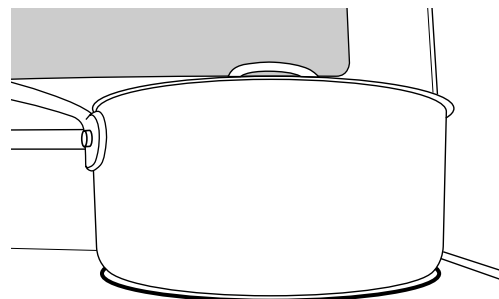

Home Canning

When canning for long periods, alternate the use of surface burners between batches. This allows time for the most recently used areas to cool.

- Center the canner on the grate above the burner.
- Do not place canner on 2 surface burners at the same time.
- For more information, contact your local agricultural extension office, or refer to published home canning guides. Companies that manufacture home canning products can also offer assistance.

OVEN

Odors and smoke are normal when the oven is used the first few times or when it is heavily soiled.

IMPORTANT: The health of some birds is extremely sensitive to the fumes given off by the oven. Exposure to the fumes may result in death to certain birds. Always move birds to another closed and well-ventilated room.

Aluminum Foil

IMPORTANT: To avoid permanent damage to the oven bottom finish, do not line the oven bottom with any type of foil or liner.

For best cooking results, do not cover entire oven rack with foil because air must be able to move freely.

Positioning Racks and Bakeware

IMPORTANT: To avoid permanent damage to the porcelain finish, do not place food or bakeware directly on the oven door or bottom.

Bakeware

To cook food evenly, hot air must be able to circulate. Allow 2" (5 cm) of space around bakeware and oven walls. Make sure that no bakeware piece is directly over another.

Racks

- Position racks before turning on the oven.
- Do not position racks with bakeware on them.
- Make sure racks are level.

To position a rack, pull it out to the stop position, raise the front edge, and then lift out. Use the following illustration and charts as guide.

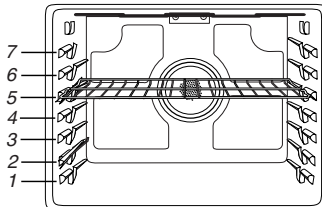

The oven has 7 positions for a flat rack, as shown in the previous illustration and the following table.

Flat Rack Position*	Type of Food
7	Broiling/searing meats, hamburgers, steaks
6	Broiled meats, poultry, fish
3 or 4	Most baked goods, casseroles, frozen foods
2	Roasted meats
1	Large roasts or poultry

For hamburger patties to have a well-seared exterior and a rare interior, use a flat rack in rack position 7. Side 1 should cook for approximately 2½ to 3½ minutes. Side 2 should cook for approximately 4 to 5 minutes. Expect a moderate degree of smoke when broiling.

*If your model has a Max Capacity Oven Rack, the recessed ends must be placed in the rack position above the desired position of the food. See the following illustration.

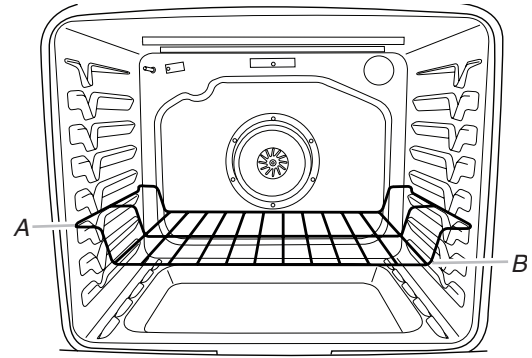

A. Ends of rack in position 3
B. Food in position 2

IMPORTANT: These rack positions are for flat racks. If a Max Capacity Oven Rack is used, the rack position must be adjusted as shown in the previous figure.

Multiple Rack Cooking

2-rack (non-convection): Use rack positions 2 and 5 or 3 and 6.

2-rack (convection): Use rack positions 2 and 5 or 3 and 6.

3-rack (convection): Use rack positions 2 and 7 and a Max Capacity Oven Rack in rack position 5.

Baking Cookies and Layer Cakes on 2 Racks

Baking Layer Cakes

For best results when baking cakes on 2 racks, use the Bake function, a flat rack in rack position 3 and a roll-out rack in rack position 5. Place the cakes on the racks as shown. Keep at least 3" (7.6 cm) of space between the front of the racks and the front cakes.

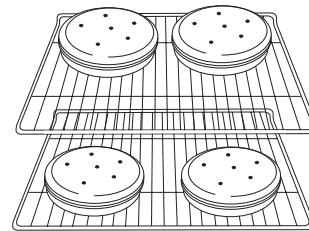

Baking Cookies

For best results when baking cookies on 2 racks, use the Convection Bake function, a flat rack in rack position 3 and a roll-out rack in rack position 4.

Roll-Out Rack

The roll-out rack allows easy access to position and remove food in the oven. It is not recommended to use the roll-out rack in the top rack, position 7, or the bottom rack, position 1.

Open Position

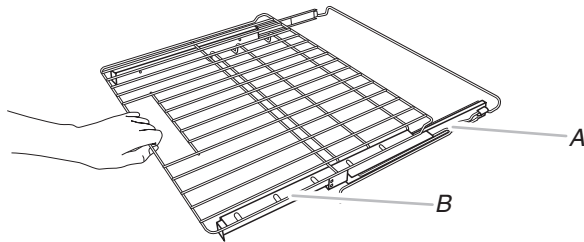

A. Rack frame
B. Sliding rack

Closed and Engaged Position

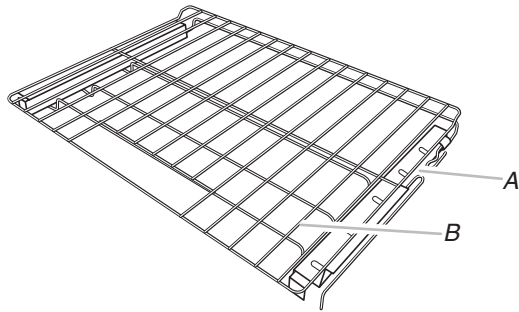

A. Rack frame
B. Sliding rack

To Insert Roll-Out Rack

1. Angle the front of the rack assembly up, and then insert the rack frame into the "V" cutout in the rack guides of the oven cavity.

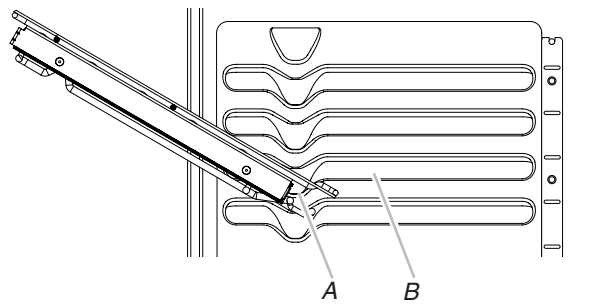

A. "V" cutout
B. Rack guides

2. Keep rack assembly lifted up at an angle, and then push in to bypass the lower "V" cutout.

3. Lower the front of the rack assembly, and then gently slide rack assembly into oven, bypassing the "V" cutouts. Push the rack assembly into the oven until it stops at the ladder in the back of the oven.

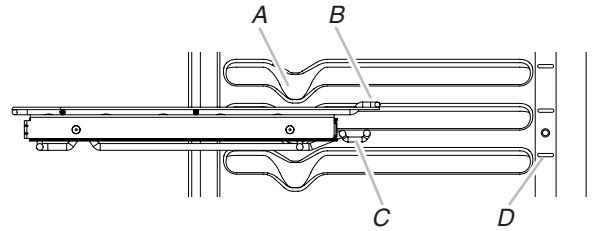

A. "V" cutout
B. Rack guides
C. Ladder hook
D. Ladder

4. Reach through the rack to hold the sliding rack and the front crossbar. Lift the front of the rack assembly, and then push the rack assembly to the back of the oven. Lower the front of the rack assembly so the ladder hook engages with the ladder on both sides of the oven.

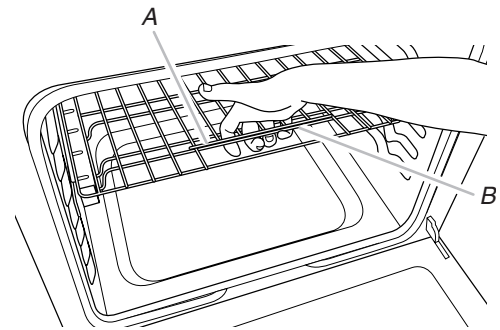

A. Sliding rack
B. Front crossbar

To Remove Roll-Out Rack

1. Push the sliding rack in completely so that it is in the closed and engaged position.
2. Reach through the rack to hold the sliding rack and the front crossbar. Lift the front of the rack assembly to disengage the ladder hook from the ladders at the rear of the oven, and then pull the rack assembly forward.
3. Using 2 hands, gently pull the sliding rack and the rack frame at the same time to the "V" cutout. Angle the rack so that the front is higher than the back, and then gently pull rack past "V" cutout and then out of the oven.

To avoid damage to the sliding rack, do not place more than 25 lbs (11.4 kg) on the rack.

Do not clean the roll-out rack in a dishwasher. It may remove the rack's lubricant and affect its ability to slide.

See the "General Cleaning" section for more information.

Oven Vent

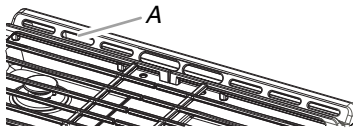

A. Oven vent

The oven vent releases hot air and moisture from the oven, and should not be blocked or covered. Blocking or covering the oven vent will cause poor air circulation, affecting cooking and cleaning results. Do not set plastics, paper, or other items that could melt or burn near the oven vent.

Sabbath Mode

The Sabbath Mode sets the oven to remain on in a bake setting until turned off.

When the Sabbath Mode is set, only the Bake cycle will operate. All other cooking and cleaning cycles are disabled. No tones will sound, and the displays will not indicate temperature changes.

When the oven door is opened or closed, the oven light will not turn on or off, and the heating elements will not turn on or off immediately.

To Enable Sabbath Mode Capability (One Time Only):

1. Press CLOCK/TOOLS until "SABBATH" is displayed. "OFF. Press (1) for On" will scroll in the display.
2. Press the "1" keypad. "ON. Press (1) for Off" will scroll in the display. Sabbath mode can be activated for baking.
3. Press START or CANCEL UPPER to exit and display the time of day.

NOTE: To disable the Sabbath mode, repeat steps 1 through 3 to change the status from "SABBATH ON" to "SABBATH OFF."

To Activate Sabbath Mode:

1. Press BAKE for the desired oven.
2. Press the number keypad to set a temperature other than 350°F (177°C).
3. Press START.
For timed cooking in Sabbath mode, press COOK TIME and then the number keypads to set the desired cook time.
4. Press CLOCK/TOOLS. Three tones will sound. Then press "7." "SAb" will appear in the display.

To Adjust Temperature (When Sabbath Mode Is Running):

1. Press the number keypad as instructed by the scrolling text to select the new temperature.
NOTE: The temperature adjustment will not appear on the display. The scrolling text will be shown on the display as it was before the keypad was pressed.
2. Press START.

To Deactivate Sabbath Mode:

Press CLOCK/TOOLS, and then press "7" to return to regular baking, or press CANCEL for the desired oven to turn off the range.

NOTE: No tones will sound while deactivating Sabbath mode.

Baking and Roasting

Preheating

When beginning a Bake, Convection Bake or Convection Roast cycle, the oven will begin preheating after Start is pressed. The oven will take approximately 12 to 15 minutes to reach 350°F (177°C) with all of the oven racks provided with your oven inside the oven cavity. Higher temperatures will take longer to preheat. The preheat cycle rapidly increases the oven temperature. The actual oven temperature will go above your set temperature to offset the heat lost when your oven door is opened to insert food. This ensures that when you place your food in the oven, the oven will begin at the proper temperature. Insert your food when the preheat tone sounds. Do not open the door during preheat before the tone sounds.

Oven Temperature

While in use, the oven elements will cycle on and off as needed to maintain a consistent temperature, but they may run slightly hot or cool at any point in time due to this cycling. Opening the oven door while in use will release the hot air and cool the oven which could impact the cooking time and performance. It is recommended to use the oven light to monitor cooking progress.

NOTE: On models with convection, the convection fan may run in the non-convection bake mode to improve oven performance.

Temperature Management System

The Temperature Management System electronically regulates the oven heat levels during preheat and bake to maintain a precise temperature range for optimal cooking results. The bake and broil elements or burners cycle on and off in intervals. On convection range models, the fan will run while preheating and may be cycled on and off for short intervals during Bake to provide the best results. This feature is automatically activated when the oven is in use.

Before baking and roasting, position racks according to the "Positioning Racks and Bakeware" section. When roasting, it is not necessary to wait for the oven preheat cycle to end before putting food in, unless it is recommended in the recipe.

Steam Bake

The Steam Bake function works in conjunction with the steam rack to provide additional moisture during baking. The steam rack contains a water reservoir which heats up and releases steam into the oven cavity during the Steam Bake cycle. There are 3 preprogrammed food options to choose from: Breads, Desserts and Fish, as well as a Refresh/Reheat option.

For best performance, place the steam rack in the lowest available rack position in the cavity and pour 1½ cups (350 mL) of water into the reservoir. Do not fill past the MAX level indicated on the reservoir.

After the Steam Bake Cycle is complete, some water may remain in the reservoir. This is normal. Wait for the oven to cool and discard the water.

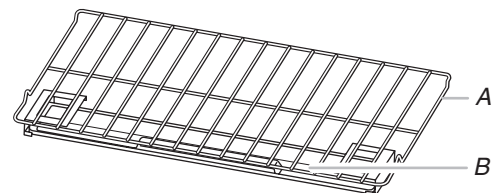

A. Steam rack
B. Water reservoir

Broiling

When broiling, preheat the oven for 2 minutes before putting food in, unless recommended otherwise in the recipe. Position food on grid in a broiler pan, and then place it in the center of the oven rack.

IMPORTANT: Close the door to ensure proper broiling temperature.

Changing the temperature when broiling allows more precise control when cooking. The lower the broil setting is, the slower the cooking. Thicker cuts and unevenly shaped pieces of meat, fish, and poultry may cook better at lower broil settings. Use rack 6 or 7 for broiling. Refer to the “Positioning Racks and Bakeware” section for more information.

On lower settings, the broil element will cycle on and off to maintain the proper temperature.

- For best results, use a broiler pan and grid. It is designed to drain juices and help avoid spatter and smoke.
If you would like to purchase a broiler pan, one may be ordered. See the “Accessories” section.

Convection Cooking

In a convection oven, the fan-circulated hot air continually distributes heat more evenly than the natural movement of air in a standard thermal oven. This movement of hot air helps maintain a consistent temperature throughout the oven, cooking foods more evenly, crisping surfaces while sealing in moisture and yielding crustier breads.

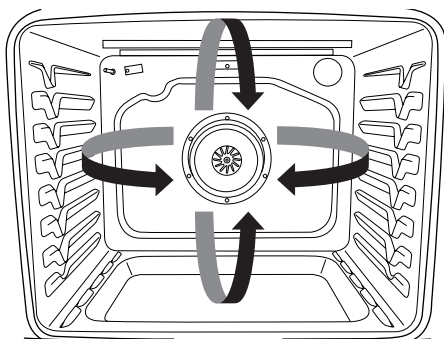

During convection baking or roasting, the bake, broil, and convection elements cycle on and off in intervals while the fan circulates the hot air. During convection broiling, the broil and convection elements cycle on and off.

If the oven door is opened during convection cooking, the fan will turn off immediately. It will come back on when the oven door is closed.

With convection cooking, most foods can be cooked at a lower temperature and/or a shorter cooking time than in a standard thermal oven. Depending upon the selected cooking mode, EasyConvect™ conversion can automatically reduce the standard recipe temperature and/or time you input for convection cooking. If you choose not to use the EasyConvect™ conversion, use the following table as a guide.

Convection Mode	Time/Temperature Guidelines
Convection Bake	25°F (15°C) lower temperature, possible shortened cooking time
Convection Roast	Cooking time shortened by up to 30%
Convection Broil	Shortened cooking time

Convect Options

Convect Bake - multiple-rack baking or cookies, biscuits, breads, casseroles, tarts, tortes, cakes

Convect Roast - whole chicken or turkey, vegetables, pork roasts, beef roasts

Convect Broil - thicker cuts or unevenly shaped pieces of meat, fish or poultry

Proofing Bread

Proofing bread prepares the dough for baking by activating the yeast. Follow the recipe directions as a guide. Proof should be used for fresh dough, thawed dough, and for the first and second rise.

To Proof:

Before first proofing, place the dough in a lightly greased bowl and cover loosely with wax paper, coated with shortening. Place on rack guide 2 and close the oven door.

NOTE: If the temperature of the oven is greater than 120°F (49°C), “Oven Cooling” will be displayed until the temperature is less than 120°F (49°C).

1. Press PROOF.
2. Press START.

Let the dough rise until nearly doubled in size. Proofing time may vary depending on dough type and quantity.

3. Press CANCEL UPPER when finished proofing.

Before second proofing, shape the dough, place it in baking pan(s) and cover loosely. Follow the same placement and control steps above. Before baking, remove the cover.

NOTE: If the oven temperature is greater than 120°F (49°C), the display will indicate “Oven Cooling” until the temperature is below 120°F (49°C).

Cook Time

⚠ WARNING

Food Poisoning Hazard

Do not let food sit in oven more than one hour before or after cooking.

Doing so can result in food poisoning or sickness.

To Set a Timed Cook:

1. Press BAKE or BROIL or press an Easy Convection function.
2. Press the number keypads to enter a temperature other than the one displayed.
3. Press COOK TIME. The Cook Time oven indicator light will light up.
4. Press the number keypads to enter the length of time to cook.
5. Press START. The display will count down the time. When the time ends, the oven will shut off automatically.
6. Press CANCEL for the desired oven to clear the display.

To Set a Delayed Timed Cook:

1. Press BAKE or BROIL or press an Easy Convection function.
2. Press the number keypads to enter a temperature other than the one displayed.
3. Press COOK TIME. The Cook Time oven indicator light will light up.
4. Press number keypads to enter the length of time to cook.
5. Press DELAY START.
6. Press number keypads to enter the number of hours and/or minutes you want to delay the start time.
7. Press START.

When the start time is reached, the oven will automatically turn on. The temperature and/or time settings can be changed anytime after the oven turns on by repeating steps 2 through 4. When the set cook time ends, the oven will shut off automatically.

8. Press CANCEL for the desired oven to clear the display.

Baking Drawer

⚠ WARNING

Food Poisoning Hazard

Do not let food sit in oven more than one hour before or after cooking.

Doing so can result in food poisoning or sickness.

The baking drawer is highly recommended for baking frozen foods. Use the temperature and medium cook time given on the frozen food packaging. For example, if the packaging suggests a cook time of 15 to 20 minutes, set the cook time for 17 minutes. Check food for doneness before removing from the baking drawer.

The baking drawer may also be used for conventional baking, slow cooking, and keeping hot cooked foods warm. It is not recommended to prepare foods taller than the height of the baking drawer rack handles or foods that may rise above 2½" (6.4 cm) in the baking drawer.

IMPORTANT: Always use the baking drawer rack when using the baking drawer.

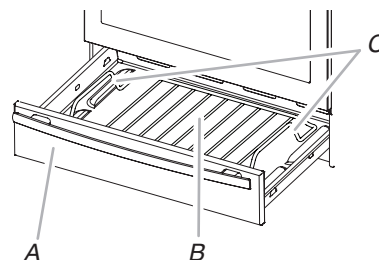

A. Baking drawer
B. Baking drawer rack
C. Baking drawer rack handles

See the "General Cleaning" section for more information.

To Bake with the Baking Drawer:

1. Press BAKING DRAWER BAKE.
2. Set the desired temperature between 170°F and 451°F (75°C and 233°C) using the number keypads. The default temperature is 350°F (180°C).
3. Press START.
4. To change the temperature, repeat steps 2 and 3.
5. Press CANCEL LOWER when finished.
6. Remove food from the drawer.

To Slow Cook with the Baking Drawer:

IMPORTANT: Brown roasts thoroughly before starting to slow cook.

1. Place food in the Baking Drawer.
2. Press BAKING DRAWER SLOW COOK.
3. Set the desired temperature between 145°F and 190°F (63°C and 88°C) using the number keypads. The default temperature is 170°F (75°C).
4. Press START.
5. (Optional) Set the desired cook time using the number keypads.
6. Press START.
7. Press CANCEL LOWER when finished.
8. Remove food from the baking drawer.

To Keep Warm with the Baking Drawer:

Food must be at serving temperature before placing it in the warmed drawer.

1. Place food in the baking drawer.
2. Press BAKING DRAWER KEEP WARM.
3. Set the desired temperature between 145°F and 190°F (63°C and 88°C) using the number keypads. The default temperature is 170°F (75°C).
4. Press START.
5. Press CANCEL LOWER when finished.
6. Remove food from the baking drawer.

Oven Light

The oven light is a standard 40 watt appliance bulb. Before replacing, make sure the oven and cooktop are cool and the control knobs are in the Off position.

To Replace:

1. Unplug range or disconnect power.
2. Turn the glass bulb cover in the back of the oven counterclockwise to remove.
3. Turn bulb counterclockwise to remove from socket.
4. Replace bulb by turning clockwise.
5. Replace bulb cover by turning clockwise.
6. Plug in range or reconnect power.

Clean Cycle

AquaLift®

Self-Cleaning Technology

AquaLift® Technology is an innovative cleaning solution that utilizes heat and water to release baked-on spills from the oven in less than 1 hour. This new cleaning technology is a low-heat, odor-free alternative to traditional self-cleaning options.

Allow the oven to cool to room temperature before using the Clean cycle. If your oven cavity is above 200°F (93°C), "Oven Cooling" will appear in the display, and the Clean cycle will not be activated until the oven cavity cools down.

To Clean:

1. Remove all racks and accessories from the oven cavity and wipe excess soil. Use a plastic scraper to remove easily-removed soils.

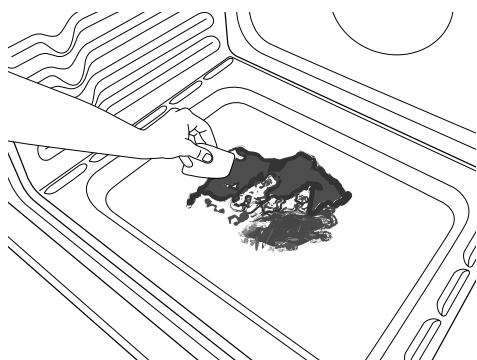

2. Pour 2 cups (16 oz [500 mL]) of distilled or filtered water onto the bottom of the empty oven and close the oven door.

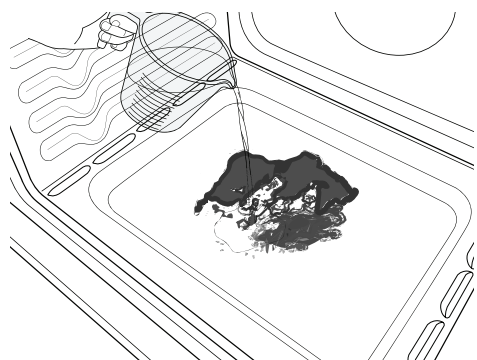

IMPORTANT: Do not use chemicals or other additives with the water. Do not open the oven door during the Clean cycle. The water on the oven bottom is hot.

3. Press AQUALIFT SELF CLEAN and then START on the oven control panel.
4. Allow 40 minutes for cleaning and cooldown. A beep will sound when the Self-Cleaning cycle is complete.
5. Press CANCEL UPPER at the end of the cycle. Cancel UPPER may be pressed at any time to stop the Clean cycle.

6. Remove the residual water and loosened soils with a sponge or cloth immediately after the Clean cycle is complete. Much of the initial 2 cups (16 oz [500 mL]) of water will remain in the oven after the cycle is completed. If additional soils remain, leave a small amount of water in the oven bottom to assist with the cleaning.

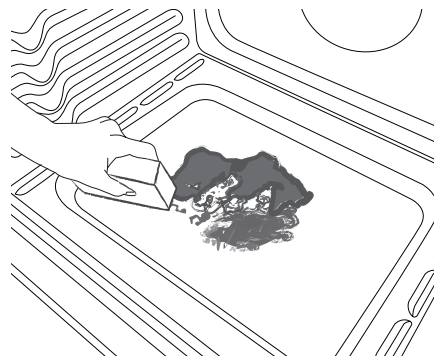

7. If any soils remain, remove them with a non-scratch scrubbing sponge or plastic scraper. Additional Clean cycles may be run to help remove the stubborn soils.

IMPORTANT: Do not use oven cleaners. The use of chemicals, including commercial oven cleaners or metal scouring pads, may cause permanent damage to the porcelain surface of the oven interior.

NOTES:

- The range should be level to ensure that the entire surface of the bottom of the oven cavity is covered by water at the beginning of the Clean cycle.
- For best results, use distilled or filtered water. Tap water may leave mineral deposits on the oven bottom.
- Before removing the residual water and loosened soils at the end of the Clean cycle, insert a cloth or paper towel between the lower edge of the oven door and the front frame to keep water from spilling onto the front of the range and the floor.
- Soil baked on through several cooking cycles will be more difficult to remove with the Clean cycle.
- Nonabrasive scrub sponges or eraser-style cleaning pads (without cleaners) can be effective for cleaning the oven cavity walls, oven door, and oven bottom for difficult soils. For best results, moisten the pads and sponges before use.
- Run an additional Clean cycle for stubborn soils.
- Affresh® Kitchen Appliance Cleaner and affresh® Cooktop Cleaner may be used to clean the oven bottom, walls, and door when the oven has finished the cycle and returned to room temperature. If affresh® Cooktop Cleaner is used, it is recommended to wipe out the cavity with distilled water as well. Refer to the "Accessories" section for information on ordering.
- Additional AquaLift® Technology Cleaning Kits may be obtained by ordering Part Number W10423113RP. See the "Accessories" section for more information.
- For assistance with AquaLift® Technology, call 1-877-258-0808 in the U.S.A. or 1-800-807-6777 in Canada, or visit our website at <http://whirlpoolcorp.com/aqualift>.

General Cleaning

IMPORTANT: Before cleaning, make sure all controls are OFF and the oven and cooktop are cool. Always follow label instructions on cleaning products. For additional information, you can visit our website at www.kitchenaid.com. In Canada, visit our website at www.kitchenaid.ca.

Soap, water, and a soft cloth or sponge are suggested first, unless otherwise noted.

EXTERIOR PORCELAIN ENAMEL SURFACES (on some models)

Food spills containing acids, such as vinegar and tomato, should be cleaned as soon as the entire range is cool. These spills may affect the finish.

Cleaning Method:

- Glass cleaner, mild liquid cleaner, or nonabrasive scrubbing pad:
Gently clean around the model/serial/rating plate because scrubbing may remove numbers.
- Affresh® Kitchen and Appliance Cleaner Part Number W10355010 (not included):
See the “Accessories” section for more information.

STAINLESS STEEL (on some models)

NOTE: To avoid damage to stainless steel surfaces, do not use soap-filled scouring pads, abrasive cleaners, Cooktop Cleaner, steel-wool pads, gritty washcloths or abrasive paper towels. Damage may occur to stainless steel surfaces, even with one-time or limited use.

Cleaning Method:

Rub in direction of grain to avoid damaging.

- Affresh® Stainless Steel Cleaner Part Number W10355016 (not included):
See the “Accessories” section for more information.

METALLIC PAINT (on some models)

Do not use abrasive cleaners, cleaners with bleach, rust removers, ammonia or sodium hydroxide (lye) because paint surface may stain.

PORCELAIN-COATED GRATES AND CAPS

Food spills containing acids, such as vinegar and tomato, should be cleaned as soon as the cooktop, grates and caps are cool. These spills may affect the finish.

To avoid chipping, do not bang grates and caps against each other or hard surfaces such as cast iron cookware.

Do not reassemble caps on burners while wet.

Cleaning Method:

- Nonabrasive plastic scrubbing pad and mildly abrasive cleanser:
Clean as soon as cooktop, grates and caps are cool.
- Dishwasher (grates only, not caps):
Use the most aggressive cycle. Cooked-on soils should be soaked or scrubbed before going into a dishwasher.
Although the burner grates are durable, they may lose their shine and/or discolor when washed in a dishwasher.
- Gas Grate and Drip Pan Cleaner Part Number 31617 (not included):
See the “Accessories” section for more information.

SURFACE BURNERS

Food spills containing acids, such as vinegar and tomato, should be cleaned as soon as the cooktop, grates and caps are cool. These spills may affect the finish.

To avoid chipping, do not bang grates and caps against each other or hard surfaces such as cast iron cookware.

Do not reassemble caps on burners while wet.

Do not clean in the Self-Cleaning cycle.

Do not clean in dishwasher.

Cleaning Method:

- Nonabrasive plastic scrubbing pad and mildly abrasive cleanser:
Clean as soon as cooktop, grates, burners and caps are cool.
- Gas Grate and Drip Pan Cleaner (not included).

COOKTOP CONTROLS

To avoid damage to the cooktop controls, do not use steel wool, abrasive cleansers or oven cleaner.

To avoid damage, do not soak knobs. When replacing knobs, make sure knobs are in the Off position.

On some models, do not remove seals under knobs.

Cleaning Method:

- Soap and water:
Pull knobs straight away from control panel to remove.

GRIDDLE

To avoid damaging the nonstick surface, do not use steel wool or abrasive cleaners.

Cleaning Method:

- Mild detergent
- Dishwasher:
Although the griddle is durable, it may lose its shine and/or discolor when washed in a dishwasher.

CONTROL PANEL AND OVEN DOOR EXTERIOR

To avoid damage to the control panel, do not use abrasive cleaners, steel-wool pads, gritty washcloths or abrasive paper towels.

Cleaning Method:

- Glass cleaner and soft cloth or sponge:
Apply glass cleaner to soft cloth or sponge, not directly on panel.
- Affresh® Kitchen and Appliance Cleaner Part Number W10355010 (not included):
See the “Accessories” section for more information.

OVEN RACKS

Cleaning Method:

- Steel-wool pad
- For racks that have discolored and are harder to slide, a light coating of vegetable oil applied to the rack guides will help them slide.
- Dishwasher (steam rack water reservoir only, not racks):
Although the water reservoir is durable, it may lose its shine and/or discolor when washed in a dishwasher.

BAKING DRAWER

Check that baking drawer is cool and empty before cleaning.

Food spills should be cleaned when oven cools. At high temperatures, foods react with porcelain. Staining, etching, pitting, or faint white spots can result.

Cleaning Method:

- Mild detergent

OVEN CAVITY

Use AquaLift® Technology regularly to clean oven spills.

Do not use oven cleaners.

Food spills should be cleaned when oven cools. At high temperatures, foods react with porcelain. Staining, etching, pitting, or faint white spots can result.

Cleaning Method:

- Clean cycle:
See the “Clean Cycle” section first.

Remove/Replace Drawer

Remove all items from inside the baking drawer, and then allow the range to cool completely before attempting to remove the drawer.

To Remove:

1. Open the drawer to its fully open position.
2. Using a flat-blade screwdriver, gently loosen the drawer from the glide alignment notch, and then lift up the drawer alignment tab from the glide.

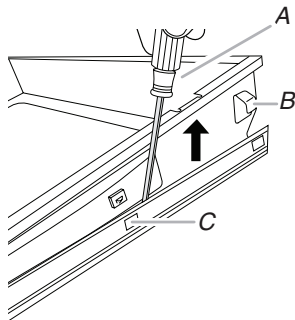

A. Flat-blade screwdriver
B. Drawer alignment tab
C. Drawer glide notch

3. Repeat Step 2 on the other side. The drawer is no longer attached to the drawer glides. Using both hands, pick up the drawer to complete the removal.

To Replace:

1. Align the forward drawer notches with the notches in the drawer glides on both sides. Place the rear alignment tabs into the drawer glides on both sides.

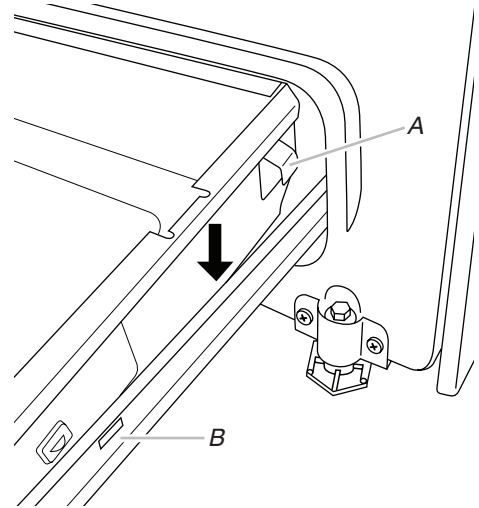

A. Drawer alignment tab
B. Drawer glide notch

2. Push the drawer in all the way.
3. Gently open and close the drawer to ensure it is seated properly on the glides on both sides.

TROUBLESHOOTING

First try the solutions suggested here. If you need further assistance or more recommendations that may help you avoid a service call, refer to the warranty page in this manual, or visit <http://www.kitchenaid.com/customer-service/>. In Canada, visit <http://www.kitchenaid.ca>.

Contact us by mail with any questions or concerns at the address below:

In the U.S.A.:

KitchenAid Brand Home Appliances
Customer eXperience Center
553 Benson Road
Benton Harbor, MI 49022-2692

In Canada:

KitchenAid Brand Home Appliances
Customer eXperience Centre
200 - 6750 Century Ave.
Mississauga, Ontario L5N 0B7

Please include a daytime phone number in your correspondence.

Problem	Possible Causes and/or Solutions
Nothing will operate	<p>Power supply cord is unplugged - Plug into a grounded outlet.</p> <p>ENERGY SAVE is active, and the display is blank - Press any keypad on the control to display the time of day. See the “Electronic Oven Controls” section for more information.</p> <p>Household fuse is blown or a circuit breaker is tripped - Replace the fuse or reset the circuit breaker. If the problem continues, call an electrician.</p> <p>The control displays an F9 or F9 E0 error code - The electrical outlet in the home may be miswired. Contact a qualified electrician to verify the electrical supply.</p>
Surface burners will not operate	<p>The control knob is not set correctly - Push in knob before turning to a setting.</p> <p>Air in the gas lines - If this is the first time the surface burners have been used, turn on any one of the surface burner knobs to release air from the gas lines.</p> <p>Clogged burner ports - See the “Sealed Surface Burners” section.</p>
Surface burner flames are uneven, yellow and/or noisy	<p>Clogged burner ports - See the “Sealed Surface Burners” section.</p> <p>Burner caps positioned improperly - See the “Sealed Surface Burners” section.</p> <p>Range converted improperly - If propane gas is being used, contact a service technician or see “Warranty” section for contact information.</p>
Excessive heat around cookware on cooktop	<p>Cookware and flame are not matched - The cookware should be centered above the burner with the bottom sitting level on the grate. The flame should be adjusted so that it does not extend up the sides of the pan.</p>
Cooktop cooking results not what expected	<p>Improper cookware - Ideal cookware should have a flat bottom, straight sides and a well fitting lid, and the material should be of a medium to heavy thickness.</p> <p>Control knob set to incorrect heat level - See the “Cooktop Use” section.</p> <p>Range is not level - Level the range. See the Installation Instructions.</p>
Oven will not operate	<p>Delay Start is set - See the “Cook Time” section.</p> <p>Control is locked - Press and hold START for 3 seconds to unlock.</p> <p>The range is in Demo mode - Demo mode will deactivate all oven elements. See “Demo Mode” in the “Electronic Oven Controls” section.</p> <p>Electronic oven control set incorrectly - See the “Electronic Oven Controls” section.</p>
Oven temperature too high or too low	<p>Oven temperature needs adjustment - See “Oven Temperature Control” in the “Electronic Oven Controls” section.</p>
Display shows messages	<p>Power failure (display shows flashing time) - Clear the display. On some models, reset the clock, if needed. See “Clock” keypad feature in the “Feature Guide” section.</p> <p>Error code (display shows letter followed by number) - Depending on your model, press CANCEL to clear the display. See “Control Display” in the “Electronic Oven Controls” section. If it reappears, call for service. See the “Warranty Section” for contact information.</p> <p>Start needs to be pressed so a cycle can begin (display shows “PUSH” or “PSH”) - See the “Start” keypad feature in the “Feature Guide” section.</p> <p>Range is in Sabbath mode (display shows “SAb”) - Press CANCEL to exit Sabbath mode.</p>
Clean cycle did not work on all spills	<p>Several cooking cycles between Clean cycles or spills on oven walls and doors - Run additional Clean cycles. Use the AquaLift® Technology Cleaning Kit. Affresh® Kitchen and Appliance Cleaner or affresh® Cooktop Cleaner can be used for stubborn soils. See the “Accessories” and “Clean Cycle” sections for more information.</p>

Problem	Possible Causes and/or Solutions
Mineral deposits are left on the oven bottom after the Clean cycle	<p>Tap water was used in the Clean cycle - Use distilled or filtered water in the Clean cycle. To remove deposits, use a cloth soaked with vinegar. Then use a cloth dampened with water to thoroughly remove any vinegar residue.</p> <p>Range is not level - Mineral deposits will collect on dry areas of the oven bottom during the Clean cycle. Level the range. See the Installation Instructions. To remove deposits, use a cloth soaked with vinegar. Then use a cloth dampened with water to thoroughly remove any vinegar residue.</p>
Oven cooking results not what expected	<p>Range is not level - Level the range. See the Installation Instructions.</p> <p>The set temperature was incorrect - Double-check the recipe in a reliable cookbook.</p> <p>Oven temperature needs adjustment - See "Oven Temperature Control" in the "Electronic Oven Controls" section.</p> <p>Oven was not preheated - See the "Baking and Roasting" section.</p> <p>Racks were positioned improperly - See the "Positioning Racks and Bakeware" section.</p> <p>Not enough air circulation around bakeware - See the "Positioning Racks and Bakeware" section.</p> <p>Darker browning of food caused by dull or dark bakeware - Lower oven temperature 25°F (15°C) or move rack to a higher position in the oven.</p> <p>Lighter browning of food caused by shiny or light colored bakeware - Move rack to a lower position in the oven.</p> <p>Batter distributed unevenly in pan - Check that batter is level in the pan.</p> <p>Incorrect length of cooking time was used - Adjust cooking time.</p> <p>Oven door was not closed - Be sure that the bakeware does not keep the door from closing.</p> <p>Oven door was opened during cooking - Oven peeking releases oven heat and can result in longer cooking times.</p> <p>Rack is too close to bake burner, making baked items too brown on bottom - Move rack to higher position in the oven.</p> <p>Pie crusts browning too quickly - Use aluminum foil to cover the edge of the crust and/or reduce baking temperature.</p>

Noises

PROBLEM	POSSIBLE CAUSES AND/OR SOLUTIONS
Surface burner making popping noises	Wet burner - Allow it to dry.

ACCESSORIES

For accessories in the U.S.A., you can visit our website at www.kitchenaid.com or call us at **1-800-422-1230**.
In Canada, visit our website at www.kitchenaid.ca or call us at **1-800-807-6777**.

Complete Cooktop Cleaner Kit
(ceramic glass models)
(includes cleaner, protectant, protectant
applicator, scraper, and cleaner pads)
Order Part Number 31605

Cooktop Protectant
(ceramic glass models)
Order Part Number 31463A

Affresh® Stainless Steel Cleaning
Wipes
(stainless steel models)
Order Part Number W10355049

Affresh® Cooktop Cleaner
(ceramic glass models)
Order Part Number W10355051

Cooktop Cleaning Pads
(ceramic glass models)
Order Part Number W10391473

Affresh® Stainless Steel Cleaner
(stainless steel models)
Order Part Number W10355016

Affresh® Kitchen and Appliance
Cleaner
Order Part Number W10355010

AquaLift® Oven Cleaning Kit
Order Part Number W10423113RP

Cooktop Scraper
(ceramic glass models)
Order Part Number WA906B

Granite Cleaner and Polish
Order Part Number W10275756

Gas Grate and Drip Pan Cleaner
Order Part Number 31617A

Canning Unit Kit
(coil models)
Order Part Number 242905

Gourmet Griddle
Order Part Number W10432539

Standard Flat Oven Rack
Order Part Number W10551060

Roll-Out Oven Rack
Order Part Number W10554008

Steam Oven Rack
Rack - HD, Steam - Order Part Number
W10554007
Kit - Reservoir, Steam Rack - Order Part
Number - W10686408
Reservoir - HD, Steam Rack - Order Part
Number - W10567015
Box - Reservoir, Steam Rack - Order Part
Number - W10686405

Split Oven Rack
Order Part Number 4396927

Max Capacity Oven Rack
Order Part Number W10289145

Porcelain Broiler Pan and Grid
Order Part Number 4396923

Premium Broiler Pan and Roasting
Rack
Order Part Number W10123240

Trim Assembly
5/8" (1.7 cm) White - Order Part Number
W10675027
5/8" (1.7 cm) Black - Order Part Number
W10675026
5/8" (1.7 cm) Stainless Steel - Order Part
Number W10675028
1 1/8" (2.9 cm) White - Order Part Number
W10731885
1 1/8" (2.9 cm) Black - Order Part Number
W10731886
1 1/8" (2.9 cm) Stainless Steel - Order Part
Number W10731887

Backsplash Assembly
White - Order Part Number W10655448
Black - Order Part Number W10655449
Stainless Steel - Order Part Number
W10655450

Grill Kit
Order Part Number W10432545

KITCHENAID® MAJOR APPLIANCE LIMITED WARRANTY

ATTACH YOUR RECEIPT HERE. PROOF OF PURCHASE IS REQUIRED TO OBTAIN WARRANTY SERVICE.

Please have the following information available when you call the Customer eXperience Center:

- Name, address and telephone number
- Model number and serial number
- A clear, detailed description of the problem
- Proof of purchase including dealer or retailer name and address

IF YOU NEED SERVICE:

1. Before contacting us to arrange service, please determine whether your product requires repair. Some questions can be addressed without service. Please take a few minutes to review the Troubleshooting or Problem Solver section of the Use and Care Guide, or visit <http://www.kitchenaid.com/customer-service>.
2. All warranty service is provided exclusively by our authorized KitchenAid Service Providers. In the U.S. and Canada, direct all requests for warranty service to:

KitchenAid Customer eXperience Center

In the U.S.A., call 1-800-422-1230. In Canada, call 1-800-807-6777.

If outside the 50 United States or Canada, contact your authorized KitchenAid dealer to determine whether another warranty applies.

ONE YEAR LIMITED WARRANTY

WHAT IS COVERED

For one year from the date of purchase, when this major appliance is installed, operated and maintained according to instructions attached to or furnished with the product, KitchenAid brand of Whirlpool Corporation or Whirlpool Canada LP (hereafter "KitchenAid") will pay for Factory Specified Replacement Parts and repair labor to correct defects in materials or workmanship that existed when this major appliance was purchased, or at its sole discretion replace the product. In the event of product replacement, your appliance will be warranted for the remaining term of the original unit's warranty period.

YOUR SOLE AND EXCLUSIVE REMEDY UNDER THIS LIMITED WARRANTY SHALL BE PRODUCT REPAIR AS PROVIDED HEREIN. Service must be provided by a KitchenAid designated service company. This limited warranty is valid only in the United States or Canada and applies only when the major appliance is used in the country in which it was purchased. This limited warranty is effective from the date of original consumer purchase. Proof of original purchase date is required to obtain service under this limited warranty.

WHAT IS NOT COVERED

1. Commercial, non-residential, multiple-family use, or use inconsistent with published user, operator or installation instructions.
2. In-home instruction on how to use your product.
3. Service to correct improper product maintenance or installation, installation not in accordance with electrical or plumbing codes or correction of household electrical or plumbing (i.e. house wiring, fuses or water inlet hoses).
4. Consumable parts (i.e. light bulbs, batteries, air or water filters, preservation solutions, etc.).
5. Defects or damage caused by the use of non-genuine KitchenAid parts or accessories.
6. Conversion of products from natural gas or propane gas.
7. Damage from accident, misuse, abuse, fire, floods, acts of God or use with products not approved by KitchenAid.
8. Repairs to parts or systems to correct product damage or defects caused by unauthorized service, alteration or modification of the appliance.
9. Cosmetic damage including scratches, dents, chips, and other damage to the appliance finishes unless such damage results from defects in materials and workmanship and is reported to KitchenAid within 30 days.
10. Discoloration, rust or oxidation of surfaces resulting from caustic or corrosive environments including but not limited to high salt concentrations, high moisture or humidity or exposure to chemicals.
11. Food or medicine loss due to product failure.
12. Pick-up or delivery. This product is intended for in-home repair.
13. Travel or transportation expenses for service in remote locations where an authorized KitchenAid servicer is not available.
14. Removal or reinstallation of inaccessible appliances or built-in fixtures (i.e. trim, decorative panels, flooring, cabinetry, islands, countertops, drywall, etc.) that interfere with servicing, removal or replacement of the product.
15. Service or parts for appliances with original model/serial numbers removed, altered or not easily determined.

The cost of repair or replacement under these excluded circumstances shall be borne by the customer.

DISCLAIMER OF IMPLIED WARRANTIES

IMPLIED WARRANTIES, INCLUDING ANY IMPLIED WARRANTY OF MERCHANTABILITY OR IMPLIED WARRANTY OF FITNESS FOR A PARTICULAR PURPOSE, ARE LIMITED TO ONE YEAR OR THE SHORTEST PERIOD ALLOWED BY LAW. Some states and provinces do not allow limitations on the duration of implied warranties of merchantability or fitness, so this limitation may not apply to you. This warranty gives you specific legal rights, and you also may have other rights that vary from state to state or province to province.

DISCLAIMER OF REPRESENTATIONS OUTSIDE OF WARRANTY

KitchenAid makes no representations about the quality, durability, or need for service or repair of this major appliance other than the representations contained in this warranty. If you want a longer or more comprehensive warranty than the limited warranty that comes with this major appliance, you should ask KitchenAid or your retailer about buying an extended warranty.

LIMITATION OF REMEDIES; EXCLUSION OF INCIDENTAL AND CONSEQUENTIAL DAMAGES

YOUR SOLE AND EXCLUSIVE REMEDY UNDER THIS LIMITED WARRANTY SHALL BE PRODUCT REPAIR AS PROVIDED HEREIN. KITCHENAID SHALL NOT BE LIABLE FOR INCIDENTAL OR CONSEQUENTIAL DAMAGES. Some states and provinces do not allow the exclusion or limitation of incidental or consequential damages, so these limitations and exclusions may not apply to you. This warranty gives you specific legal rights, and you also may have other rights that vary from state to state or province to province.