



# Use and Care Guide

GSD600  
GSD600G  
GSD600L  
GSD640G  
GSD640L

## Dishwasher

10-15-88

PUB#  
49-5392

### Contents

Air Gap	14	Problem Solver	11-13
Appliance Registration	2	Repair Service	15
Care and Cleaning	14	Rinse Agent	6
China, Crystal, Sterling	10	Safety Instructions	3
Cycle Features	4, 5	User Maintenance Instructions	14
Detergent, Detergent Guide	6, 7	Warranty	Back Cover
Dispenser Cups	7	Water Temperature	6
Energy Saver Switch	4, 5	Winter Storage	14
Energy-Saving Tips	2		
Front Panel Color Change	15		
Loading	8, 9		
Model and Serial Numbers	2		
Operating Instructions	4, 5		
Cycle Selection	5		
Drying Options	4, 5	<b>GE Answer Center®</b>	
Potscrubber	4, 5	<b>800.626.2000</b>	

**Built-in Models**  
GSD600G  
GSD640G

ERRDATE 10-5-88

49-5392

## Help us help you...

### **Before using your dishwasher, read this book carefully.**

It is intended to help you operate and maintain your new dishwasher properly.

Keep it handy for answers to your questions.

If you don't understand something or need more help, write (include your phone number):

Consumer Affairs  
GE Appliances  
Appliance Park  
Louisville, KY 40225

### **Write down the model and serial numbers.**

You'll find them on a label just inside the dishwasher door.

These numbers are also on the Consumer Product Ownership Registration Card that came with your dishwasher. Before sending in this card, please write these numbers here:

\_\_\_\_\_

Model Number

\_\_\_\_\_

Serial Number

Use these numbers in any correspondence or service calls concerning your dishwasher.

## Energy-saving tips

- **Operate dishwasher only when it's full.** Let the dishes accumulate in dishwasher. When you put in only a partial load, use the RINSE ONLY cycle to rinse off heavy soils. Be sure to latch the door when waiting for a full load. This helps keep soils moist, easier to remove.
- If you don't need your dishes right away, use your **ENERGY SAVER no-heat drying feature** that turns the drying heater off automatically. Dishes dry naturally over a longer period such as overnight.
- **Always select the cycle that uses least amount of water that will remove the soil from the load.** See pages 4 and 5.

# IMPORTANT SAFETY INSTRUCTIONS

Read all instructions before using this appliance.

**WARNING**—When using this appliance, always exercise basic safety precautions, including the following:

- Use this appliance only for its intended purpose, as you will find described in this Use and Care Book.

- This dishwasher must be properly installed and located in accordance with the Installation Instructions before it is used. If you did not receive an Installation Instructions sheet with your dishwasher, you can obtain one by contacting the service location nearest you.

—This appliance must be connected to a grounded metal, permanent wiring system; or an equipment-grounding conductor must be run with the circuit conductors and connected to the equipment-grounding terminal or lead of the appliance.

—Connect to a properly rated, protected and sized power-supply circuit to avoid electrical overload.

- Use only powder or liquid detergents or wetting agents recommended for use in a dishwasher.

- Do not wash plastic items unless marked “dishwasher safe” or the equivalent. For plastic items not so marked, check the manufacturer’s recommendations.

- Load light plastic items so they will not become dislodged and drop to the bottom of the dishwasher—they might come into contact with the heating unit and be damaged.

To minimize the possibility of injury.

- When loading items to be washed:

A. Locate sharp items so that they are not likely to damage the door seal, and

B. Load sharp knives with the handles up to reduce the risk of cut-type injuries.

- Do not touch the heating element during or immediately after use.

- Do not operate your dishwasher unless all enclosure panels are properly in place.

- Do not tamper with controls.

- Do not abuse, sit on, or stand on the door or dish rack of the dishwasher.

- Close supervision is necessary if this appliance is used by or near children. Do not allow children to play inside, on or with this appliance or any discarded appliance. Dispose of discarded appliances and shipping or packing material properly. Before discarding a dishwasher, remove the door of the washing compartment.

- Keep all washing detergents and wetting agents out of the reach of children, preferably in a locked cabinet. Observe all warnings on container labels to avoid personal injury.

- **HYDROGEN GAS** is produced by the chemical action within your water heater. It can accumulate in the water heater and/or water pipes if hot water has not been used for a period of two weeks or longer. **HYDROGEN GAS IS EXPLOSIVE.** To prevent the possibility of damage or injury, if you have not used hot water for two weeks or more, or move into a residence in which the hot water system may not have been used for some time, turn on all hot water faucets and allow them to run for several minutes before using any electrical appliance which is connected to the hot water system. This will allow any hydrogen gas to escape. Also, since the gas is flammable, do not smoke or use an open flame or appliance during this process.

## SAVE THESE INSTRUCTIONS

# How to operate your dishwasher

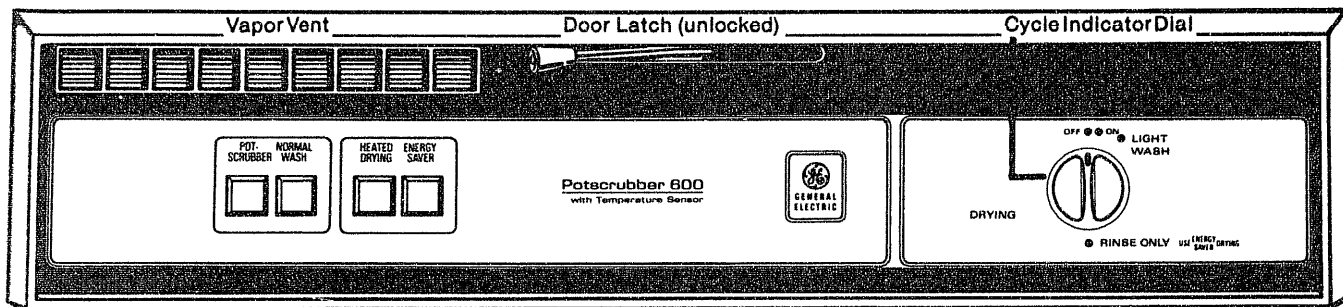

**STEP 1.** Load your dishwasher with dishes, silverware, pots, pans, bowls, etc. according to instructions on pages 8 and 9.

**STEP 2.** Add detergent to the detergent dispenser. Make sure the Cycle Indicator Dial is at OFF position before adding detergent. (See pages 6 and 7.)

Use rinse aid agent to help prevent spotting. Occasionally check to make sure the rinse agent container is at least half full. (See page 6.)

**STEP 3.** Select Drying Option.

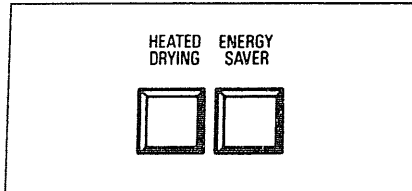

**HEATED DRYING.** Turns the drying heater on for fast drying.

**ENERGY SAVER (no-heat drying).** Turns the drying heater off to save energy. Dishes will dry naturally over a longer period such as overnight.

If you need your dishes sooner, open the dishwasher door after the cycle is complete to reduce the natural drying time.

Use of this option reduces the electrical energy used by this model approximately 7% for the NORMAL WASH cycle.

Estimated yearly savings, depending on your local electrical rates, are as follows:

Electric Rate (per Kwh)	\$ .05	\$ .08	\$ .11
Est. Yearly Savings	\$4.25	\$6.80	\$9.35

**STEP 4.** Select the cycle and start the dishwasher. See Cycle Selection Hints on the next page.

If your dishwasher drains into a food waste disposer, operate the disposer until it is empty before starting the dishwasher.

• **For POTSCRUBBER and NORMAL WASH cycles:**

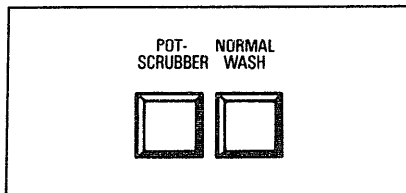

- Push selected cycle button.
- Latch the door.

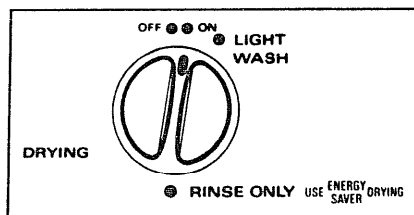

- Slowly turn Cycle Indicator Dial to ON position to start the cycle. You will hear the motor start.

To obtain the benefits of a complete cycle, be careful that you **do not turn the dial any further than necessary** to start the dishwasher.

• **For LIGHT WASH cycle:**

- Be sure door is unlatched.
- Push NORMAL WASH button.



- Slowly turn Cycle Indicator Dial to LIGHT WASH position.
- Latch door to start the cycle.

• **For RINSE ONLY cycle:**

- Be sure door is unlatched.
- Select ENERGY SAVER drying option.

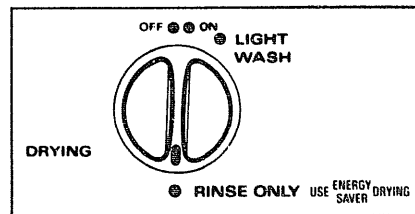

- Slowly turn Cycle Indicator Dial to RINSE ONLY position.
- Latch the door to start the cycle.

## Cycle selection hints

It is important to follow the loading instructions on pages 8 and 9.

**POTSCRUBBER**—For items such as pots, pans and casseroles with dried-on or baked-on soils. Everyday dishes may be included.

**NORMAL WASH**—For loads of everyday dishes, glasses and cookware.

**LIGHT WASH**—For dishes that are lightly soiled with soils that have not dried on. Also for everyday dishes that have extra preparation before loading.

**RINSE ONLY**—For rinsing partial loads which will be washed later.  
*Do not use detergent.*

## What happens in each cycle

- You'll hear occasional clicking sounds:
  - Soft food disposer shredding action.
  - Drain valve opening to pump water out.
  - Timer control as cycle progresses.
  - Detergent cup opening.
- During the drying period:
  - The motor stops.
  - Water vapor comes through the vent by the door latch during drying and when water is being pumped out.

Wash Cycles	Water Use Gallons (approx.)	Wash Cycle Time Minutes (approx.)	Cycle Sequence						
			Wash/Rinse	Rinse	Rinse	Main Wash	Rinse	Rinse	Rinse
<b>POTSCRUBBER</b>	12.1	65*	Wash/Rinse	Rinse	Rinse	Main Wash	Rinse	Rinse	Rinse
<b>NORMAL WASH</b>	12.1	50*	Wash/Rinse	Rinse	Rinse	Main Wash	Rinse	Rinse	Rinse
<b>LIGHT WASH</b>	10.3	45*	Wash/Rinse	Rinse	Main Wash	Rinse	Rinse	Rinse	
<b>RINSE ONLY</b>	4.9	14					Rinse	Rinse	Rinse

\*Unextended times. These cycle times may be increased up to 7½ minutes if necessary for your dishwasher to heat the water to proper temperature for good washability.

### Drying Options:

**HEATED DRYING.** Available on all wash cycles except RINSE ONLY. Add 25 minutes to wash cycle time.

**ENERGY SAVER.** Drying heater is turned off. Dishes dry naturally.

## Temperature Sensor System

To get dishes clean and dry you need hot water. To help you get water of the proper temperature, your dishwasher has a water heating feature that automatically senses the temperature of the water in the wash cycle and heats it, if necessary, to the proper temperature. This water heating feature may allow you to turn down your household water heater and save energy if you're willing to let the dishwasher run a little longer while it heats water to the proper temperature. For good washing and drying, the entering water must be at least 120°F. To prevent dish damage, inlet water should not exceed 150°F.

### How to test water temperature:

Check the water temperature inside your dishwasher with a candy or meat thermometer.

Let the dishwasher run through one fill and pump out cycle, then let the dishwasher fill with water the second time.

When you hear the water stop filling, unlatch the door and slowly open it.

Measure the temperature of the water in the bottom of the tub this way:

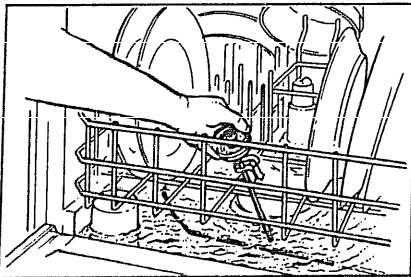

Remove the silverware basket and place a candy or meat thermometer in the water towards the middle of the tub. If the temperature is less than 120°F, you will not get good washing results. Higher water temperature is needed to dissolve grease and activate powder detergents.

**Helpful hints:** If outside temperatures are unusually low, or if your water travels a long distance from water heater to dishwasher, you may need to set your water heater's thermostat up. If you have not used hot water for some time, the water in the pipes will be cold. Turn on the hot water faucet at the sink and allow it to run until the water is hot. Then start the dishwasher. If you've recently done laundry or run hot water for showers, give your water heater time to recover before operating the dishwasher.

To improve washability if the water is less than 120°F and you cannot adjust your water heater: Select a longer cycle and fill both detergent cups at least half-full with detergent.

### How to use a rinse agent.

A rinse agent makes water flow off dishes quicker than usual. This lessens water spotting and makes drying faster, too.

For best dishwashing performance, use of a rinse agent such as JET-DRY brand is recommended.

Rinse agents come in either liquid or solid form. Your dishwasher's dispenser uses the liquid form.

**How to fill the rinse agent dispenser.** Unscrew the cap. Add the liquid rinse agent until it just reaches the bottom of the lip inside the dispenser opening. Replace the cap. The dispenser automatically releases the rinse agent into the final rinse water.

**If you accidentally spill:** Wipe up the rinse agent with a damp cloth. Don't leave the spill in the dishwasher. It can keep your detergent from working.

**If you can't find any rinse agent,** write:

BENCKISER CONSUMER PRODUCTS, INC.

("JET DRY")

1210 W County Road E.  
Arden Hills, MN 55112

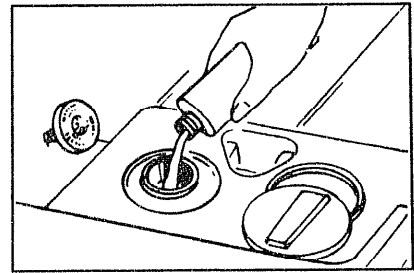

Your dishwasher's rinse agent container holds 4½ ounces. This should last about 3 months. Fill as needed. Do not overfill.

### How to choose and use detergent.

**First, use only powder or liquid detergents specifically made for use in dishwashers. Other types will cause oversudsing.**

**Second, check the phosphate content.** Phosphate helps prevent hard-water materials from forming spots or film on your dishes. If your water is hard (7 grains or more), your detergent has to work harder. Detergents with a higher phosphate level will probably work better. If the phosphate content is low (8.7% or less), you'll have to use extra detergent with hard water.

**Your water department can tell you how hard your water is.** So can your county extension agent. Or your area's water softener company. Just call and ask them how many "grains of hardness" there are in your water.

**How much detergent should you use?** That depends. Is your water "hard" or "soft"? With hard water, you need extra detergent to get dishes clean. With soft water, you need less detergent.

Too much detergent with soft water not only wastes money, it can be harmful. It can cause a permanent cloudiness of glassware, called "etching." An outside layer of glass is etched away! Of course, this takes some time. But why take a chance when it's easy to find out the hardness of your water.

Keep your detergent fresh and dry. Under the sink isn't a good place to store detergent. Too much moisture. Don't put powder detergent into the dispenser until you're ready to wash dishes, either. (It won't be fresh OR dry.)

If your powder detergent gets old or lumpy, throw it away. It won't wash well. Old detergent often won't dissolve.

If you use a liquid dishwasher detergent, these precautions are not necessary because liquid detergents don't "lump" as they age or come in contact with water.

You'll find two detergent dispensers on the inside door of your dishwasher. There are two, because some cycles use two washes.

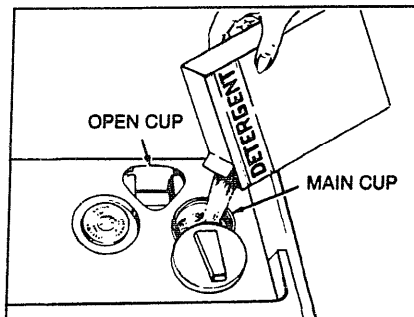

See "Detergent Usage Guide" below. (Be sure the Cycle Indicator Dial is at OFF position before adding detergent. Otherwise, the detergent cup lid will not close and latch properly.)

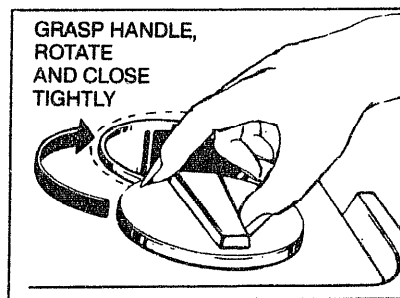

Always close the main cup tightly. When it is firmly latched, you will hear a clicking sound. Do not overtighten.

NOTE: Detergent cup may be opened manually with no harm. Turn handle counterclockwise until it releases. A snapping sound is normal when it opens.

### How to prepare the dishes for washing

If this is your first dishwasher, or if you're replacing a much older model, you may wonder how much pre-preparation your dishes need. Actually very little. Pre-rinsing of normal food soils is not necessary. With common sense and a little practice, you'll soon know what foods to remove. Here are some guidelines:

1. Scrape off bones, seeds, skins, toothpicks and other hard solids. It is also best to remove hard shelled vegetables, meat trimmings, leafy vegetables and crusts. Remove excessive quantities of oil or grease.

2. Remove large quantities of any food. Your dishwasher has a built-in soft food disposer that pulverizes soft food bits and flushes them away. It can handle *small* amounts of soft foods, but large amounts will be difficult to handle.

3. Try to remove food scraps and place dishes in dishwasher before soil has a chance to dry and become hard. Dishes with dried-on soil are more difficult to wash and may not come clean in the NORMAL WASH cycle. Remember to use your RINSE ONLY cycle for small "holding" loads.

Note: The foods mentioned here are for examples only. Other foods not mentioned may also need to be removed from your dishes. You may also want to consider removing foods such as mustard, mayonnaise, vinegar, lemon juice and other foods that can cause discoloration of stainless steel if allowed to remain on dishes for a long period of time.

When using the POTSCRUBBER cycle, less preparation is required before loading. The POTSCRUBBER cycle can wash heavily-soiled dishes and remove dried-on and baked-on soils from pots, pans and casseroles. Items with burned-on soils may not come clean. And the dishwasher cannot remove burn marks or restore fading caused by overheating during cooking.

### Detergent Usage Guide (powder or liquid)

CYCLES	SOFT WATER (0-3 grains hardness)		MEDIUM WATER (3-7 grains)		HARD WATER (7-12 grains*)	
	Main Cup‡	Open Cup‡	Main Cup‡	Open Cup‡	Main Cup‡	Open Cup‡
POTSCRUBBER and NORMAL WASH cycles	1 Tablespoon minimum	1 Tablespoon minimum	Half Full	Half Full	Completely Full	Completely Full
LIGHT WASH cycle	1 Tablespoon minimum	None	Half Full	None	Completely Full	None
RINSE ONLY cycle	Use no detergent		Use no detergent		Use no detergent	

\*12 grains and up is extremely hard water. A water softener is recommended. Without it, lime can build up in water valve. Water valve may stick while open and cause flooding.

‡Filled Main Cup holds 3 tablespoons; Filled Open Cup holds 2 tablespoons.

## How to load your dishwasher

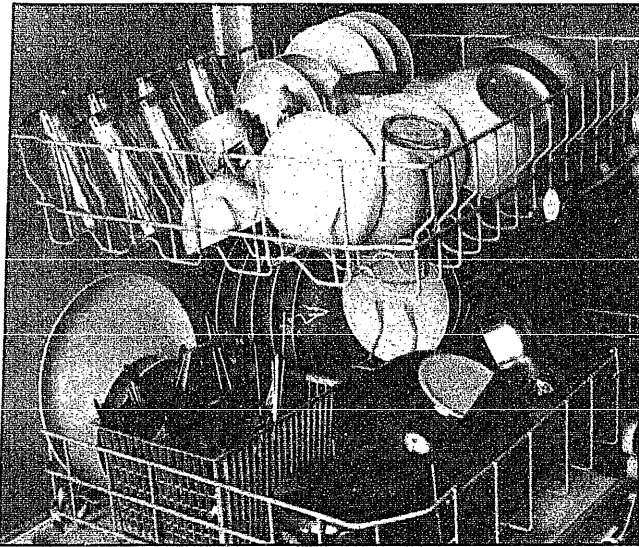

*This is a random mixed load, the most common type you will have.*

Make sure dishes are properly loaded to insure that water can reach the soiled surfaces. The wash arm in the bottom sprays water up. The tower that rises in the center sends water out over the dishes to wash the items in the upper rack.

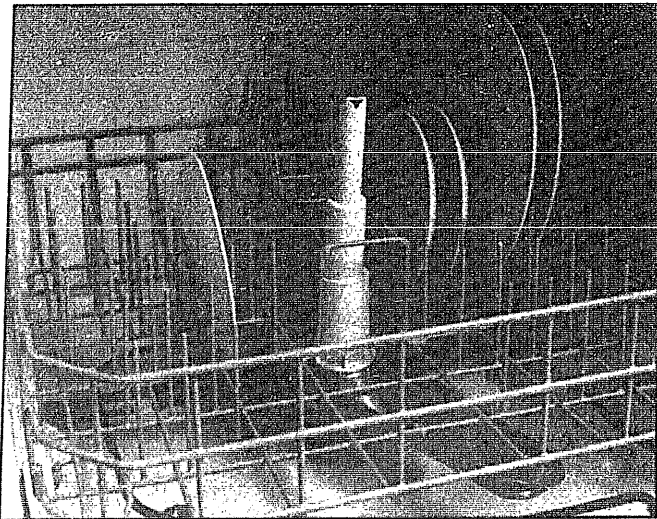

### **WATCH OUT FOR THIS.**

The wash tower rises through the center of the bottom rack during the wash and rinse portions of the cycle. Don't block it or load tall things next to it. Also, be careful not to let portions of items such as knives, skewers or pot handles extend through the bottom rack or the silverware basket.

## How to load the TOP RACK

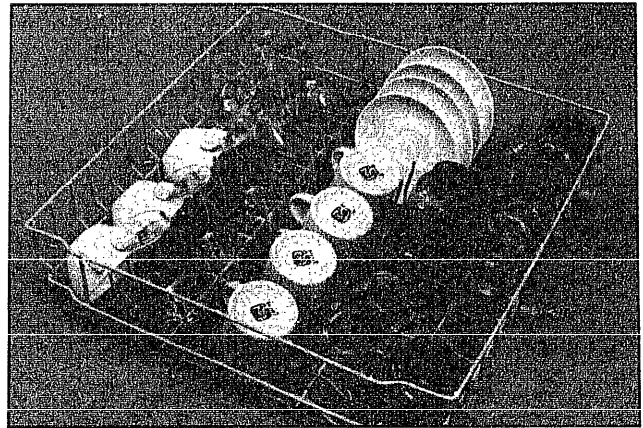

Place glasses, cups and saucers in the rack face down, so the water and detergent will reach the soiled surfaces.



When loading dishwasher-safe plastics, place plastic items along the back and be sure that each plastic tumbler is secured over two fingers. This will prevent dislodging; tumbler will not fall through the rack onto the heating unit.

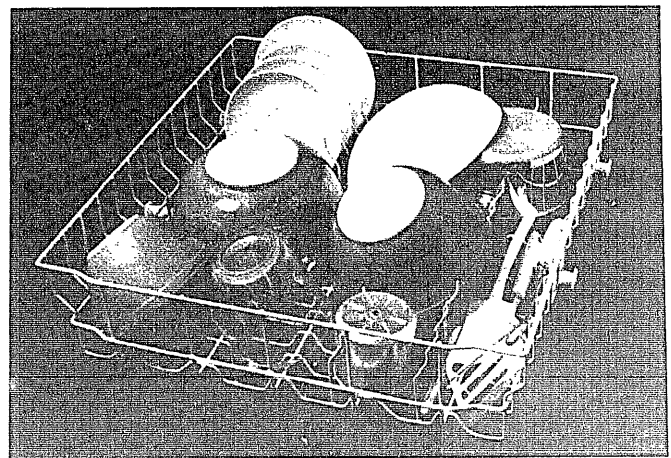

Saucepans, mixing bowls and other small items may be placed—face down—in the top rack. The top rack is handy for all kinds of odd shapes.



## How to load the BOTTOM RACK

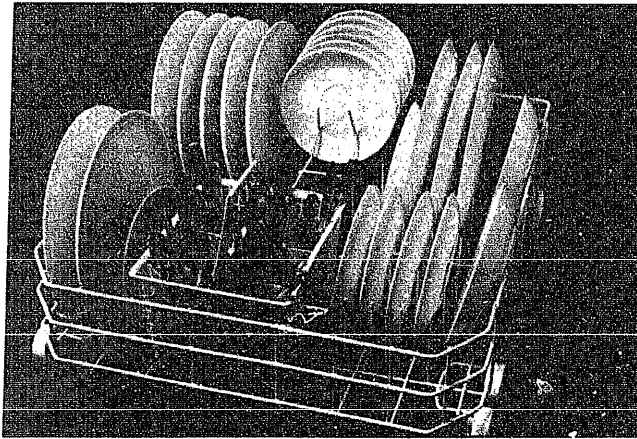

Fit plates and saucers between the pins.

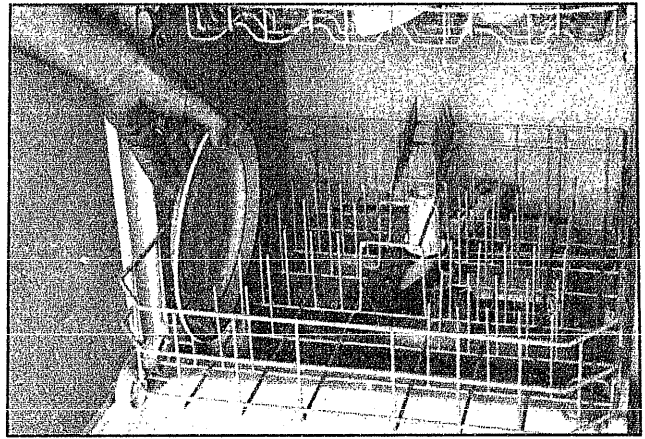

As shown here, this plate is being placed so that water and detergent from wash arm can reach soiled surfaces.

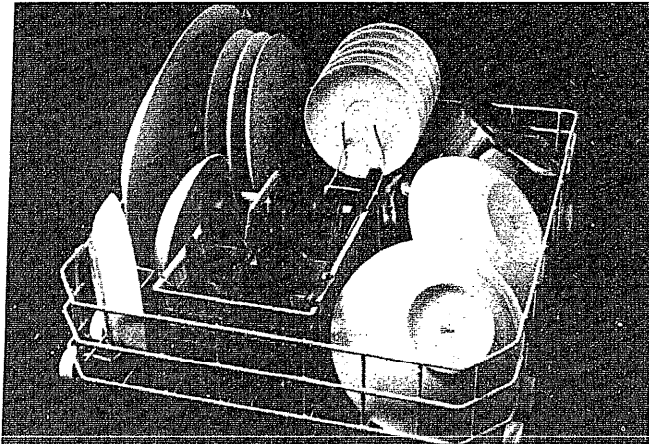

Load platters, pots and bowls along the sides, in corners or in the back. All large plastic items, such as pitchers, salad bowls and mixing bowls, should be washed in the lower rack.

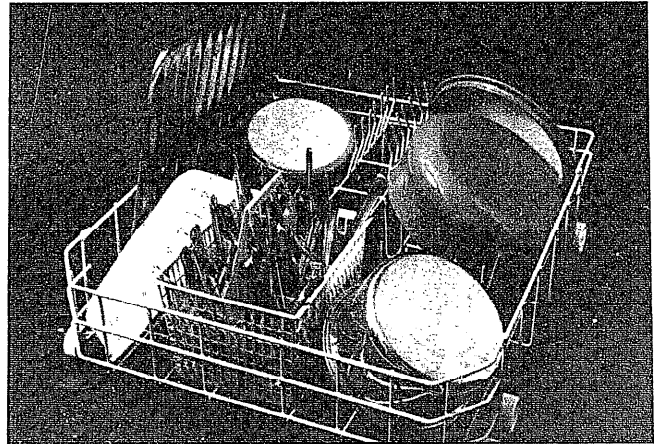

Heavily soiled pots, pans and casseroles **MUST** be loaded in the bottom rack, facing down. Prop the broiler pan and rack along the edge, tilted toward the center.

Put flatware in the removable silverware basket with handles up to protect your hands. Mix knives, forks and spoons so they don't nest together. Distribute evenly. Small plastic items, such as measuring spoons and lids from small containers, are not recommended for automatic dishwashing. If placed in the dishwasher, they should go in the bottom of the silverware basket with the silverware on top.

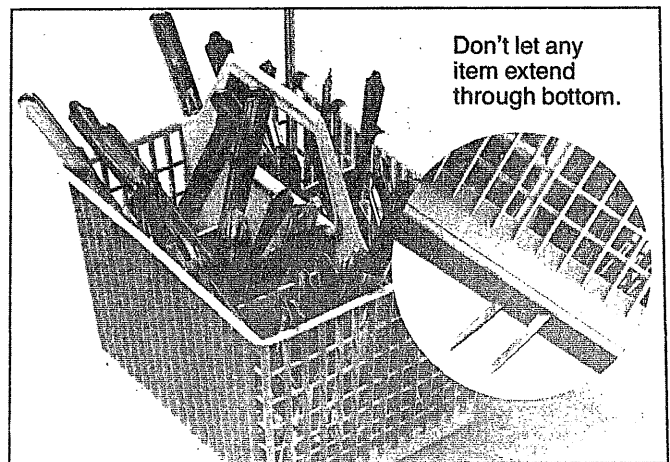

Don't let any item extend through bottom.

## What you can usually wash safely in your dishwasher. And what you can't.

Material	Usually Safe	Exceptions (not safe)	Special Instructions
Aluminum	YES	Some colored anodized aluminum can fade.	Some darkening or spotting possible. Remove by scouring with soap-filled steel wool pads.
China/ Stoneware	YES	Antique, metal-trimmed, hand-painted or over-the-glaze patterns fade. Gold leaf will discolor.	If in doubt, check with the manufacturer. Or test wash one piece daily for at least a month. Compare with the rest of the set.
Crystal	YES	Antique, metal-trimmed or hand-painted patterns fade. Gold leaf will discolor.	Load securely to prevent movement.
Non-dishware items—such as electronic air cleaner filters, furnace filters, paint brushes, etc.	NO		Do not wash in dishwasher. Damage to dishwasher and discoloration or staining of dishwasher may result.
Glass	YES	Milk Glass may yellow.	
Iron	NO	Iron will rust.	
Pewter	NO	Pewter tarnishes.	
Plastics	YES		If it doesn't say DISHWASHER SAFE, test one piece in the top rack before dishwashing an entire set. Wash in top rack only.
Stainless steel	YES		Rinse if not washing immediately. Salty or acid foods can stain if left on.
Sterling Silver and Silver plate	YES	Don't put in same silverware basket with stainless steel. Contact between metals can damage silver. Don't use copper utensils in the same load. Silver may get a brown film. Adhesive used to attach some hollow-handle knives can loosen.	Rinse if not washing immediately. Salty or acid foods can stain if left on. Dry detergent can cause difficult-to-remove black spots. Place in back section of silverware basket to avoid exposure to detergent from the detergent cup.
Non-stick coatings	YES		After washing, wipe the non-stick coating area with vegetable oil to keep it from losing its non-stick quality.
Tin	NO	Tin can rust.	
Wood	NO	Wood can warp, crack or lose its finish with any type washing.	

### Forget a dish? Here's when you can add it.

Add dishes any time during the RINSE ONLY cycle. With other wash cycles, you can add dishes at any time BEFORE the main detergent wash portion of the cycle.

However, opening the door during any cycle lessens cleaning power because the temperature inside the dishwasher is lowered. So try to load everything at the beginning.

Here's how to add a forgotten dish:

1. Push the door latch to the left. Washing will stop.

2. Wait a few seconds until the water calms. Then open the door.  
3. Add dishes you've forgotten.  
4. Close the door and push the latch to the far right. When the door is locked, washing will continue.



## Questions? Use This Problem Solver

PROBLEM	POSSIBLE CAUSE AND REMEDY
DISHWASHER WON'T RUN	A fuse in your home may be blown, or the circuit breaker tripped. Replace fuse or reset circuit breaker. Remove any other appliances from the circuit.
UNUSUAL NOISE	Utensils may not be secure on rack pins, or something small may have dropped from the rack. Water is causing utensils to rattle. Make sure everything is securely placed in dishwasher.
DISHES DON'T DRY	Make sure inlet water temperature is correct. (See page 6.) Unload the bottom rack first. Water from dishes in the top rack may be spilling into the bottom rack. Check for improper loading. Dishes shouldn't nest together. Avoid overloading. Check the rinse agent dispenser to see that it's not empty.
UNCLEAN DISHES AND FLATWARE	Check inlet water temperature. It should be at least 120°F. (To test, see page 6.) To obtain the benefits of a complete cycle, be careful that you <b>do not turn the dial any further than necessary</b> to start the dishwasher. Water pressure may be temporarily low. Turn on a faucet. Is water coming out slower than usual? If so, wait until pressure is normal before using your dishwasher. Plugged air gap. (See page 14.) Improper rack loading. (See pages 8 and 9.)
BLACK OR GRAY MARKS ON DISHES	Aluminum deposits often leave marks when they rub against other things. Remove marks with a mild abrasive cleanser.
DETERGENT LEFT IN DISPENSER CUPS	Water may not be reaching the detergent cups. Move dishes that may be blocking detergent cup. The dispenser cover may not be opening or may be blocked by improperly loaded items. If you used a powder detergent, open the cup and remove any caked-on detergent. If the cup still doesn't open automatically, call for service. Detergent may be old. If the powder detergent is hard or caked in the box, throw it away. The detergent may not be working well. Try another brand.
DETERGENT CUP LID WON'T LATCH AFTER ADDING DETERGENT	Cycle Indicator dial must be in OFF position for cup lid to close and latch properly. If you unlatch the door and open it to dry your dishes, the Cycle Indicator does not advance to OFF by itself.
YELLOW OR BROWN FILM	Tea or coffee can stain cups. Remove the stains by hand, using a solution of 1/2 cup bleach and 3 cups warm water. An overall yellow or brown film on dishes or glassware can be caused by iron deposits in water. A special filter in the water supply line is the only way to correct this problem. Your water softener company can tell you about the filter. Yellow film on sterling silver results when you wash copper utensils in the same load. Silver polish will usually remove this stain.

(continued on next page)

# The Problem Solver (continued)

PROBLEM	POSSIBLE CAUSE AND REMEDY
<p><b>SPOTS AND FILMING ON GLASSES AND FLATWARE</b></p>	<p>Spotting can be caused by all these things:</p> <ul style="list-style-type: none"> <li>• Extremely hard water. (See page 6.)</li> <li>• Low inlet water temperature. (To test, see page 6.)</li> <li>• Overloading the dishwasher.</li> <li>• Improper loading. (See pages 8 and 9.)</li> <li>• Old or damp powder detergent.</li> <li>• Phosphate level in detergent too low. (See page 6.)</li> <li>• Rinse agent dispenser empty. (See page 6.)</li> <li>• Too little detergent. (See page 7.)</li> </ul> <p>Local water conditions and personal preferences vary. Try several brands of detergents to find one that gives the best results for you. A liquid dishwashing detergent may help reduce filming.</p> <p><b>To remove stubborn spots and film from glassware:</b></p> <ol style="list-style-type: none"> <li>1. Remove all metal utensils from the dishwasher.</li> <li>2. Do not add detergent.</li> <li>3. Select POTSCRUBBER cycle.</li> <li>4. Start the dishwasher and allow to run for 15 to 20 minutes. The dishwasher will now be in the main wash.</li> <li>5. Then open the door and pour 2 cups (500 ml) of white vinegar into the bottom of the dishwasher.</li> <li>6. Close the door and allow to complete the cycle.</li> </ol> <p><b>If vinegar rinse doesn't work:</b> Repeat as above, except use 1/4 cup (60 ml) of citric acid crystals instead of vinegar. (Most drugstores carry citric acid crystals. If yours doesn't, call GE Factory Service.)</p> <p>Using a vinegar or citric acid crystal rinse more than twice a month? Consider a home water softener.</p>
<p><b>CLOUDINESS ON GLASSWARE</b></p>	<p>If vinegar or citric acid crystal rinse doesn't work, the cloudiness is "etching." The film cannot be removed.</p> <p><b>It can be prevented:</b> Use less detergent if you have soft water. Wash glassware in the shortest cycle that will get them clean.</p> <p>Water temperature entering dishwasher exceeds 150°F.</p>
<p><b>CHIPPING OF CHINA</b></p>	<p>Rough handling can cause chipping. Load with care. Make sure glassware and china are secure and can't jar loose. (See page 8 for correct way to load glassware.) Make sure tall glasses and stemware will clear the top of the tub when you push the rack into the dishwasher.</p> <p>Always use the top rack for delicate items.</p>

PROBLEM	POSSIBLE CAUSE AND REMEDY
SMALL AMOUNT OF WATER STANDING IN THE BOTTOM OF THE TUB	Water around the outlet on the tub bottom at the back of the tub is normal. It is clean water. It's there to keep the water seal lubricated.
WATER WON'T PUMP OUT OF THE TUB	<p>If the entire bottom of the tub has water, you may have a drain problem. Clean the air gap, if you have one. (See page 14.)</p> <p>Check the kitchen sink. Is it draining well? You may need a plumber.</p> <p>If dishwasher drains into disposer, run disposer to clear. Be sure disposer is not clogged.</p>
SUDS IN THE TUB	<p>Sudsing detergents are not meant for dishwashers. <b>USE ONLY AUTOMATIC DISHWASHER DETERGENTS TO AVOID SUDSING.</b></p> <p><b>To remove suds from the tub:</b> Open the dishwasher. Let suds evaporate. Add 1 gallon of cold water to the tub. Close and latch the dishwasher. Pump out water by slowly turning the control dial until a drain period is reached.</p> <p>Repeat if necessary.</p>
DISHWASHER LEAKS	<p>Suds can cause unit to overflow. That's why it's so important to use a detergent that's designed for automatic dishwashers.</p> <p>Spilling the rinse agent can cause foam during washing. This can lead to overflowing. Wipe up accidental spill of rinse agent with a damp cloth.</p>

**If you need more help...call, toll free:**  
**GE Answer Center®**  
**800.626.2000**  
**consumer information service**

# Care and Cleaning

## USER MAINTENANCE INSTRUCTIONS

Clean the control panel with a **lightly dampened cloth**. Dry thoroughly. Do not use abrasives or sharp objects on the panel. They can damage it.

Clean the outside with a **good appliance polish wax**. The outside cabinet finish is durable, but it can scratch. So use no scouring pads, or harsh or gritty cleaners.

Appliance Polish Wax & Cleaner (Cat. No. WR97X216) is available from GE Appliance Parts Marts.

**The inside usually takes care of itself.** If it should ever need cleaning, use a mild cleansing powder. Scouring pads and harsh cleaners can mar the finish.

## Built-in dishwashers often use an air gap. Keep it clean.

An air gap is a plumbing device. It protects your dishwasher against water backing up into it if a drain clogs. The air gap is not a part of the dishwasher. And you may not even have one. Not all plumbing codes require air gaps.

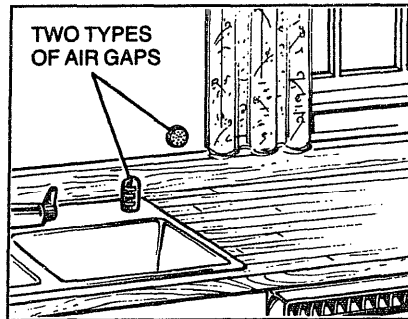

If you have an air gap, check it at least once a month. **IT IS NOT PART OF YOUR DISHWASHER. IT IS NOT COVERED IN YOUR WARRANTY.**

**The air gap is easy to clean.** With most types, first turn off the dishwasher, then lift off the chrome cover. Then unscrew the plastic cap and check for any buildup of grit. A toothpick makes cleaning easy.

**Check the air gap any time your dishwasher isn't draining well.**

## Not using your dishwasher in winter? Protect against freezing.

If your dishwasher is left in an unheated place during the winter, ask a service technician to:

- Cut off electric power to the dishwasher. Remove fuses or trip circuit breaker.
- Turn off the water supply.
- Disconnect the water inlet line from the water valve.
- Drain water from the inlet line and water valve. (Use a pan to catch the water.)
- Reconnect the water inlet line to the water valve.
- Remove the plastic pump cover in the tub bottom and use a sponge to soak up water in the rubber boot.

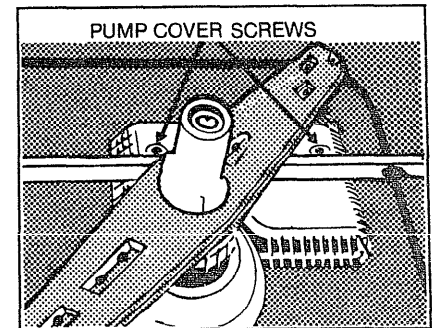

## How to change color panels

If you are redecorating, you can change your dishwasher's front panels to match or blend with your new colors.

The panels are held in place by the door trim and the trim on the panel below the door. Each side of each panel is a different color. Or you can paint a panel with the color of your own choice.

Model	Door Panel Colors	Lower Panel Colors
GSD640G	4	4
GSD600G	2	2

### How to change door panel inserts:

1. Take out three trim screws on either side of the dishwasher door. Remove the side trim.
2. Slide out both insert panels.
3. Put the color you want in front. (Careful—edges may be sharp.)
4. Replace insert panels, side trim and screws.

### How to change lower panel inserts:

1. Remove four panel attachment screws. (Two above the panel, two below the panel.)
2. Remove the entire panel.
3. Take out three screws and remove top trim.
4. Slide out both insert panels together.
5. Put the color you want in front.
6. Replace insert panels, top trim and screws.
7. Replace entire panel and four attachment screws.

Color insert panels for both door and lower panel can be replaced by 1/4" thick wood inserts to match your kitchen cabinets. Get them from your nearest cabinet or lumber dealer.

Dimensions for 1/4" wood inserts:

Door Panel: 19<sup>1</sup>/<sub>8</sub>" H × 23<sup>9</sup>/<sub>16</sub>" W.

Lower Panel: 3<sup>11</sup>/<sub>16</sub>" H × 23<sup>9</sup>/<sub>16</sub>" W.

**Note: Do not operate dishwasher while changing panels or when lower access panel is removed.**

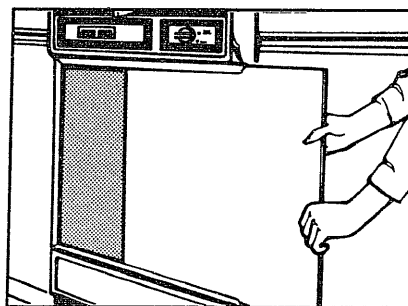

*Change color in minutes. Just remove trim and change.*

## If you need service

To obtain service, see your warranty on the back page of this book.

We're proud of our service and want you to be pleased. If for some reason you are not happy with the service you receive, here are three steps to follow for further help.

**FIRST**, contact the people who serviced your appliance. Explain why you are not pleased. In most cases, this will solve the problem.

**NEXT**, if you are still not pleased, write all the details—including your phone number—to:

Manager, Consumer Relations  
GE Appliances  
Appliance Park  
Louisville, Kentucky 40225

**FINALLY**, if your problem is still not resolved, write:

Major Appliance  
Consumer Action Panel  
20 North Wacker Drive  
Chicago, Illinois 60606

# YOUR GENERAL ELECTRIC DISHWASHER WITH PERMATUF® INTERIOR WARRANTY

Save proof of original purchase date such as your sales slip or cancelled check to establish warranty period.

## WHAT IS COVERED

### FULL ONE-YEAR WARRANTY

For one year from date of original purchase, we will provide, free of charge, parts and service labor in your home to repair or replace **any part of the dishwasher** that fails because of a manufacturing defect.

### FULL TEN-YEAR WARRANTY

For ten years from date of original purchase, we will provide, free of charge, parts and service labor in your home to repair or replace **the PermaTuf® tub or door liner** if it fails to contain water because of a manufacturing defect such as cracking, chipping, peeling or rusting.

### LIMITED SECOND-YEAR WARRANTY

For the second year from date of original purchase, we will provide, free of charge, replacement parts for **any part of the Water Distribution System** (as illustrated below) that fails because of a manufacturing defect. Associated inlet and drain plumbing parts are not covered by this warranty. You pay for the service trip to your home and service labor charges.

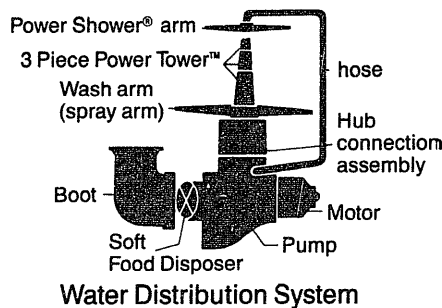

This warranty is extended to the original purchaser and any succeeding owner for products purchased for ordinary home use in the 48 mainland states, Hawaii and Washington, D.C. In Alaska the warranty is the same except that it is LIMITED because you must pay to ship the product to the service shop or for the service technician's travel costs to your home.

All warranty service will be provided by our Factory Service Centers or by our authorized Customer Care® servicers during normal working hours.

Look in the White or Yellow Pages of your telephone directory for GENERAL ELECTRIC COMPANY, GENERAL ELECTRIC FACTORY SERVICE, GENERAL ELECTRIC-HOTPOINT FACTORY SERVICE or GENERAL ELECTRIC CUSTOMER CARE® SERVICE.

## WHAT IS NOT COVERED

- Service trips to your home to teach you how to use the product.

**Read your Use and Care material.** If you then have any questions about operating the product, please contact your dealer or our Consumer Affairs office at the address below, or call, toll free:

GE Answer Center®  
800.626.2000  
consumer information service

- Improper installation.

If you have an installation problem, contact your dealer or installer. You are responsible for providing adequate electrical, plumbing and other connecting facilities.

- Replacement of house fuses or resetting of circuit breakers.

- Cleaning or servicing of air gap device in drain line.

- Failure of the product if it is used for other than its intended purpose or used commercially.

- Damage to product caused by accident, fire, floods or acts of God.

**WARRANTOR IS NOT RESPONSIBLE FOR CONSEQUENTIAL DAMAGES.**

Some states do not allow the exclusion or limitation of incidental or consequential damages, so the above limitation or exclusion may not apply to you. This warranty gives you specific legal rights, and you may also have other rights which vary from state to state. To know what your legal rights are in your state, consult your local or state consumer affairs office or your state's Attorney General.

**Warrantor: General Electric Company**

If further help is needed concerning this warranty, write:  
Manager—Consumer Affairs, GE Appliances, Louisville, KY 40225