



DRYER INSTALLATION INSTRUCTIONS

27" Wide Models - U.S.A. ONLY

Para obtener acceso al manual de uso y cuidado en español, o para obtener información adicional acerca de su producto, visite: www.maytag.com

Tenga listo su número de modelo completo. Puede encontrar el número de modelo y de serie dentro de la cavidad superior de la puerta.

Table of Contents

- DRYER SAFETY 2
- INSTALLATION REQUIREMENTS..... 4
 - Tools and Parts..... 4
- LOCATION REQUIREMENTS..... 5
- ELECTRICAL REQUIREMENTS..... 7
 - Electrical Requirements 7
- INSTALL LEVELING LEGS..... 8
- ELECTRICAL CONNECTION 8
 - Power Supply Cord 8
 - Power Supply Cord Connection..... 9
 - Direct Wire Connection..... 11
 - Optional 3-Wire Connection..... 13
- VENTING..... 14
 - Venting Requirements..... 14
 - Venting Kits..... 16
 - Install Vent System..... 16
 - Connect Vent 17
- LEVEL DRYER 17
- COMPLETE INSTALLATION CHECKLIST 18
- REVERSE DOOR SWING (OPTIONAL) 18
- TROUBLESHOOTING BACK COVER

INSTALLATION NOTES

Date of purchase: _____

Date of installation: _____

Installer: _____

Model number: _____

Serial number: _____



DRYER SAFETY

Your safety and the safety of others are very important.

We have provided many important safety messages in this manual and on your appliance. Always read and obey all safety messages.



This is the safety alert symbol.

This symbol alerts you to potential hazards that can kill or hurt you and others.

All safety messages will follow the safety alert symbol and either the word “DANGER” or “WARNING.”

These words mean:

⚠ DANGER

You can be killed or seriously injured if you don't immediately follow instructions.

⚠ WARNING

You can be killed or seriously injured if you don't follow instructions.

All safety messages will tell you what the potential hazard is, tell you how to reduce the chance of injury, and tell you what can happen if the instructions are not followed.



WARNING - “Risk of Fire”

- Clothes dryer installation must be performed by a qualified installer.
- Install the clothes dryer according to the manufacturer's instructions and local codes.
- Do not install a clothes dryer with flexible plastic venting materials or flexible metal (foil type) duct. If flexible metal duct is installed, it must be of a specific type identified by the appliance manufacturer as suitable for use with clothes dryers. Flexible venting materials are known to collapse, be easily crushed, and trap lint. These conditions will obstruct clothes dryer airflow and increase the risk of fire.
- To reduce the risk of severe injury or death, follow all installation instructions.
- Save these instructions.

IMPORTANT SAFETY INSTRUCTIONS

When discarding or storing your old clothes dryer, remove the door.

SAVE THESE INSTRUCTIONS

IMPORTANT SAFETY INSTRUCTIONS

WARNING: To reduce the risk of fire, electric shock, or injury to persons when using the dryer, follow basic precautions, including the following:

- Read all instructions before using the dryer.
- Do not place items exposed to cooking oils in your dryer. Items contaminated with cooking oils may contribute to a chemical reaction that could cause a load to catch fire.
- To reduce the risk of fire due to contaminated loads, the final part of a tumble dryer cycle occurs without heat (cool down period). Avoid stopping a tumble dryer before the end of the drying cycle unless all items are quickly removed and spread out so that the heat is dissipated.
- Do not dry articles that have been previously cleaned in, washed in, soaked in, or spotted with gasoline, dry-cleaning solvents, or other flammable or explosive substances as they give off vapors that could ignite or explode.
- Do not allow children to play on or in the dryer. Close supervision of children is necessary when the dryer is used near children.
- Before the dryer is removed from service or discarded, remove the door to the drying compartment.
- Do not reach into the dryer if the drum is moving.
- Do not install or store the dryer where it will be exposed to the weather.
- Do not tamper with controls.
- Do not repair or replace any part of the dryer or attempt any servicing unless specifically recommended in this Use and Care Guide or in published user-repair instructions that you understand and have the skills to carry out.
- Do not use fabric softeners or products to eliminate static unless recommended by the manufacturer of the fabric softener or product.
- Do not use heat to dry articles containing foam rubber or similarly textured rubber-like materials.
- Clean lint screen before or after each load.
- Keep area around the exhaust opening and adjacent surrounding areas free from the accumulation of lint, dust, and dirt.
- The interior of the dryer and exhaust vent should be cleaned periodically by qualified service personnel.
- See Installation Instructions for grounding instructions.

SAVE THESE INSTRUCTIONS

INSTALLATION REQUIREMENTS

Tools and Parts

Gather the required tools and parts before starting installation. Read and follow the instructions provided with any tools listed here.

Tools needed for all installations:

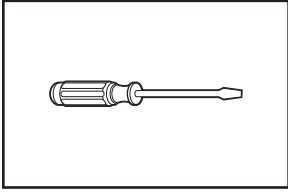

Flat-blade screwdriver

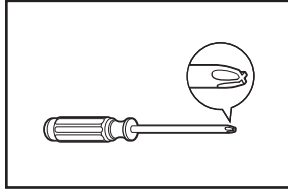

#2 Phillips screwdriver

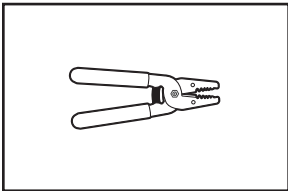

Wire stripper
(direct wire installations)

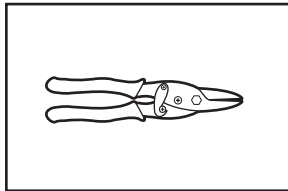

Tin snips (new vent installations)

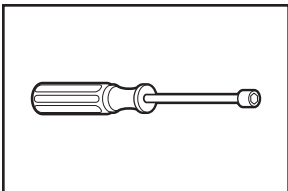

1/4" (6 mm) nut driver or socket wrench (recommended)

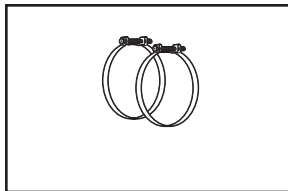

Vent clamps

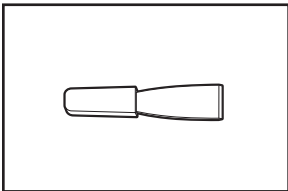

Putty knife

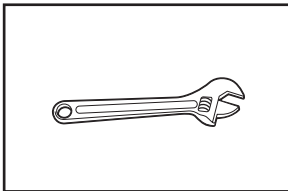

Adjustable wrench that opens to 1" (25 mm) or hex-head socket wrench

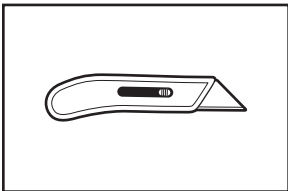

Utility knife

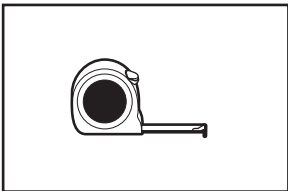

Tape measure

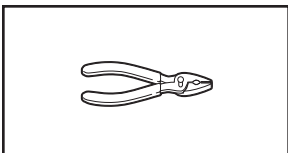

Pliers

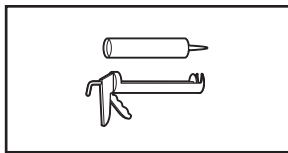

Caulking gun and compound (for installing new exhaust vent)

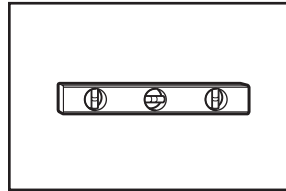

Level

Parts supplied:

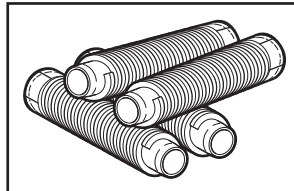

Leveling legs (4)

Parts package is located in dryer drum. Check that all parts are included.

Parts needed:

Check local codes. Check existing electrical supply and venting, and read "Electrical Requirements" and "Venting Requirements" before purchasing parts.

Mobile home installations require metal exhaust system hardware, available for purchase from the dealer from whom you purchased your dryer. For further information, please reference the "Assistance or Service" section of the Use and Care Guide.

If using a power supply cord::

Use a UL Listed power supply cord kit marked for use with clothes dryers. The kit should contain:

- A UL Listed 30 A power supply cord, rated 120/240 V minimum. The cord should be type SRD or SRDT and be at least 4 ft. (1.22 m) long. The wires that connect to the dryer must end in ring terminals or spade terminals with upturned ends.
- A UL Listed strain relief.

LOCATION REQUIREMENTS

⚠ WARNING



Explosion Hazard

Keep flammable materials and vapors, such as gasoline, away from dryer.

Place dryer at least 18 inches (460 mm) above the floor for a garage installation.

Failure to do so can result in death, explosion, or fire.

You will need:

- A location allowing for proper exhaust installation. See "Venting Requirements."
- A separate 30 A circuit.
- If you are using power supply cord, a grounded electrical outlet located within 2 ft. (610 mm) of either side of dryer.
- A sturdy floor to support the total weight (dryer and load) of 200 lbs. (90.7 kg). The combined weight of a companion appliance should also be considered.
- Level floor with maximum slope of 1" (25 mm) under entire dryer. (If slope is greater than 1" [25 mm], install Extended Dryer Feet Kit, Part Number 279810). If not level, clothes may not tumble properly and automatic sensor cycles may not operate correctly.

Do not operate your dryer at temperatures below 45°F (7°C). At lower temperatures, the dryer might not shut off at the end of an automatic cycle. Drying times can be extended.

The dryer must not be installed or stored in an area where it will be exposed to water and/or weather.

Check code requirements. Some codes limit, or do not permit, installation of the dryer in garages, closets, mobile homes, or sleeping quarters. Contact your local building inspector.

Installation clearances:

The location must be large enough to allow the dryer door to open fully.

Dryer Dimensions

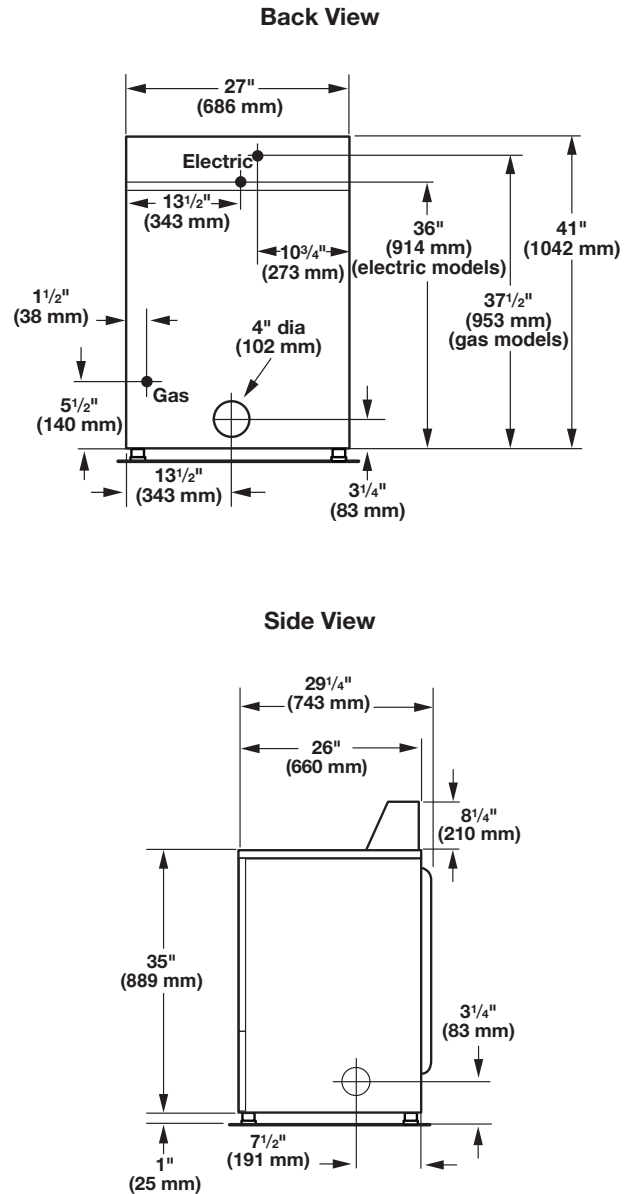

Most installations require a minimum 5 1/2" (140 mm) clearance behind the dryer for the exhaust vent with elbow. See "Venting Requirements."

Minimum spacing for recessed area or closet installation

The dimensions shown following are for the minimum spacing allowed.

- Additional spacing should be considered for ease of installation and servicing.
- Additional clearances might be required for wall, door, and floor moldings.
- Additional spacing of 1" (25 mm) on all sides of the dryer is recommended to reduce noise transfer.
- For closet installation, with a door, minimum ventilation openings in the top and bottom of the door are required. Louvered doors with equivalent ventilation openings are acceptable.
- Companion appliance spacing should also be considered.

Mobile home – Additional installation requirements

This dryer is suitable for mobile home installations. The installation must conform to the Manufactured Home Construction and Safety Standard, Title 24 CFR, Part 3280 (formerly the Federal Standard for Mobile Home Construction and Safety, Title 24, HUD Part 280).

- Metal exhaust system hardware, which is available for purchase from your dealer.
- Special provisions must be made in mobile homes to introduce outside air into the dryer. The opening (such as a nearby window) should be at least twice as large as the dryer exhaust opening.

Minimum Required Spacing

Recessed Area Installation

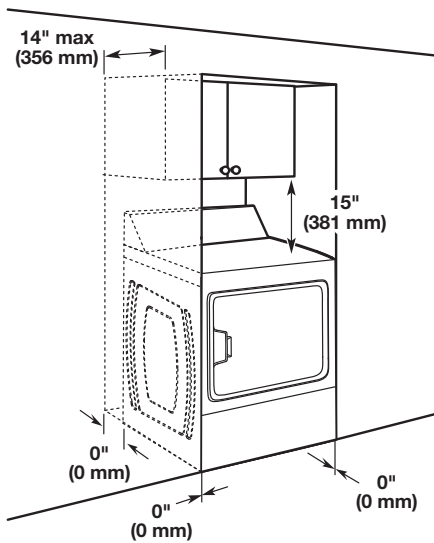

Closet Installation

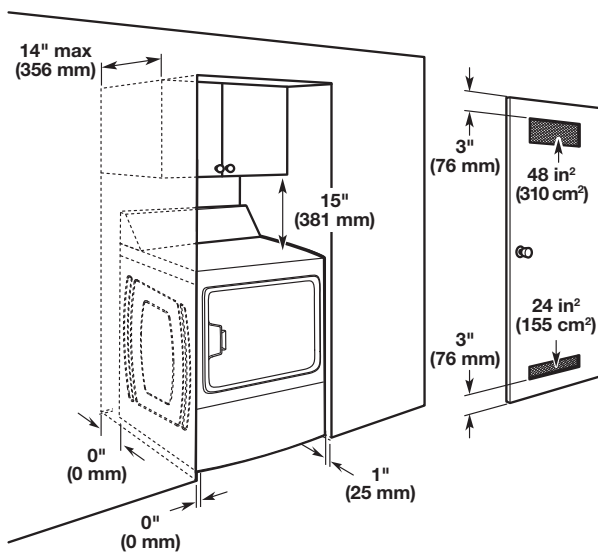

Additional spacing recommended

ELECTRICAL REQUIREMENTS

Electrical Requirements

It is your responsibility:

- To contact a qualified electrical installer.
- To be sure that the electrical connection is adequate and in conformance with the National Electrical Code, ANSI/NFPA 70 – latest edition and all local codes and ordinances.

The National Electrical Code requires a 4-wire power supply connection for homes built after 1996, dryer circuits involved in remodeling after 1996, and all mobile home installations.

A copy of the above code standards can be obtained from: National Fire Protection Association, One Batterymarch Park, Quincy, MA 02269.

- To supply the required 3- or 4-wire, single phase, 120/240 V, 60 Hz, AC-only electrical supply (or 3- or 4-wire, 120/208 V electrical supply, if specified on the serial/rating plate) on a separate 30 A circuit, fused on both sides of the line. A time-delay fuse or circuit breaker is recommended. Connect to an individual branch circuit. Do not have a fuse in the neutral or grounding circuit.
- Do not use an extension cord.
- If codes permit and a separate ground wire is used, it is recommended that a qualified electrician determine that the ground path is adequate.

Electrical Connection

To properly install your dryer, you must determine the type of electrical connection you will be using and follow the instructions provided for it here.

- If local codes do not permit the connection of a neutral ground wire to the neutral wire, see “Optional 3-wire connection” section.
- This dryer is manufactured ready to install with a 3-wire electrical supply connection. The neutral ground wire is permanently connected to the neutral conductor (white wire) within the dryer. If the dryer is installed with a 4-wire electrical supply connection, the neutral ground wire must be removed from the external ground connector screw (green screw), and secured under the neutral terminal (center or white wire) of the terminal block. When the neutral ground wire is secured under the neutral terminal (center or white wire) of the terminal block, the dryer cabinet is isolated from the neutral conductor.
- A 4-wire power supply connection must be used when the dryer is installed in a location where grounding through the neutral conductor is prohibited. Grounding through the neutral is prohibited for (1) new branch-circuit installations, (2) mobile homes, (3) recreational vehicles, and (4) areas where local codes prohibit grounding through the neutral conductors.

If using a power supply cord:

Use a UL Listed power supply cord kit marked for use with clothes dryers. The kit should contain:

- A UL Listed 30 A power supply cord, rated 120/240 V minimum. The cord should be type SRD or SRDT and be at least 4 ft. (1.22 m) long. The wires that connect to the dryer must end in ring terminals or spade terminals with upturned ends.
- A UL Listed strain relief.

If your outlet looks like this:

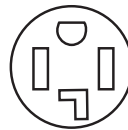

4-wire receptacle
(14-30R)

Then choose a 4-wire power supply cord with ring or spade terminals and UL Listed strain relief. The 4-wire power supply cord, at least 4 ft. (1.22 m) long, must have four 10-gauge copper wires and match a 4-wire receptacle of NEMA Type 14-30R. The ground wire (ground conductor) may be either green or bare. The neutral conductor must be identified by a white cover.

If your outlet looks like this:

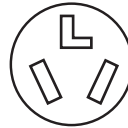

3-wire receptacle
(10-30R)

Then choose a 3-wire power supply cord with ring or spade terminals and UL Listed strain relief. The 3-wire power supply cord, at least 4 ft. (1.22 m) long, must have three 10-gauge copper wires and match a 3-wire receptacle of NEMA Type 10-30R.

Choose a standard power supply cord connector:

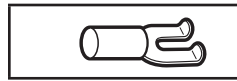

Flanged spade connectors

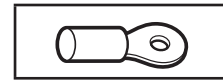

Ring connectors

If connecting by direct wire:

Power supply cable must match power supply (4-wire or 3-wire) and be:

- Flexible armored cable or nonmetallic sheathed copper cable (with ground wire), covered with flexible metallic conduit. All current-carrying wires must be insulated.
- 10-gauge solid copper wire (do not use aluminum).
- At least 5 ft. (1.52 m) long.

GROUNDING INSTRUCTIONS

- For a grounded, cord-connected dryer:
This dryer must be grounded. In the event of malfunction or breakdown, grounding will reduce the risk of electric shock by providing a path of least resistance for electric current. This dryer uses a cord having an equipment-grounding conductor and a grounding plug. The plug must be plugged into an appropriate outlet that is properly installed and grounded in accordance with all local codes and ordinances.
- For a permanently connected dryer:
This dryer must be connected to a grounded metal, permanent wiring system, or an equipment-grounding conductor must be run with the circuit conductors and connected to the equipment-grounding terminal or lead on the dryer.

WARNING: Improper connection of the equipment-grounding conductor can result in a risk of electric shock. Check with a qualified electrician or service representative or personnel if you are in doubt as to whether the dryer is properly grounded. Do not modify the plug on the power supply cord: if it will not fit the outlet, have a proper outlet installed by a qualified electrician.

SAVE THESE INSTRUCTIONS

INSTALL LEVELING LEGS

⚠ WARNING

Excessive Weight Hazard

**Use two or more people to move and install dryer.
Failure to do so can result in back or other injury.**

1. Prepare dryer for leveling legs

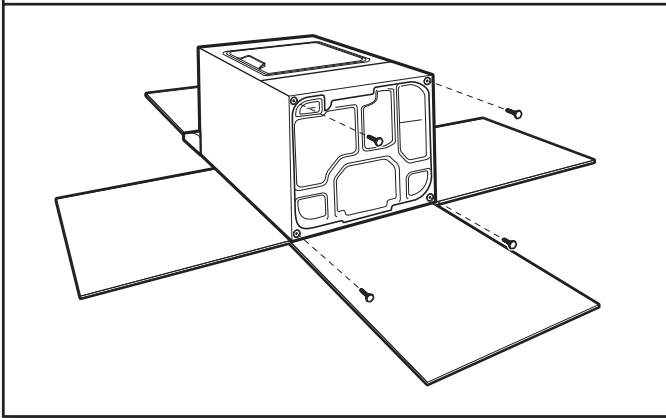

To avoid damaging floor, use a large flat piece of cardboard from dryer carton; place under entire back edge of dryer. Firmly grasp dryer body (not console panel) and gently lay dryer down on cardboard.

2. Screw in leveling legs

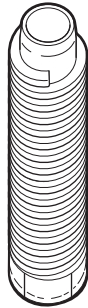

Using a wrench and tape measure, screw legs into leg holes until bottom of foot is approximately 1½" (38 mm) from bottom of dryer.

Now stand the dryer on its legs. Slide the dryer until it is close to its final location. Leave enough room for electrical connection and to connect the exhaust vent.

NOTE: Refer to "Dryer Dimensions" in "Location Requirements."

ELECTRICAL CONNECTION

1. Choose electrical connection type

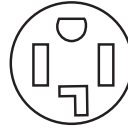

Power supply cord 4-wire receptacle (NEMA Type 14-30R): Go to "4-Wire Power Supply Cord Connection" section. Then, go to "Venting Requirements."



Power supply cord 3-wire receptacle (NEMA Type 10-30R): Go to "3-Wire Power Supply Cord Connection" section. Then go to "Venting Requirements."



4-wire direct connection: Go to "4-Wire Direct Wire Connection" section. Then go to "Venting Requirements."



3-wire direct connection: Go to "3-Wire Direct Wire Connection" section. Then go to "Venting Requirements."

NOTE: If local codes do not permit connection of a cabinet-ground conductor to neutral wire, go to "Optional 3-Wire Connection" section. This connection may be used with either a power supply cord or a direct wire connection.

2. Remove terminal block cover

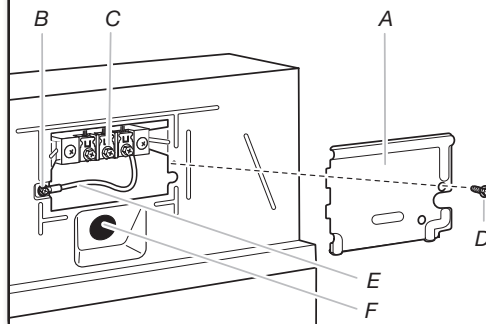

Before you start, disconnect power. Remove hold-down screw (D) and terminal block cover (A).

- A. Terminal block cover
- B. External ground conductor
- C. Center terminal block screw
- D. Hold-down screw
- E. Neutral ground wire
- F. Hole below terminal block cover

Power Supply Cord Connection

⚠ WARNING



Fire Hazard

Use a new UL listed 30 amp power supply cord.

Use a UL listed strain relief.

Disconnect power before making electrical connections.

Connect neutral wire (white or center wire) to center terminal (silver).

Ground wire (green or bare wire) must be connected to green ground connector.

Connect remaining 2 supply wires to remaining 2 terminals (gold).

Securely tighten all electrical connections.

Failure to do so can result in death, fire, or electrical shock.

Power supply cord strain relief

1. Attach power supply cord strain relief

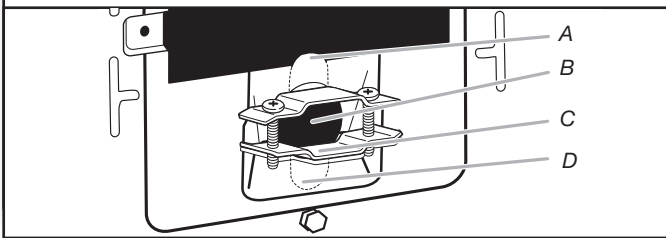

Remove the screws from a 3/4" (19 mm) UL Listed strain relief. Put the tabs of the two clamp sections (C) into the hole below the terminal block opening (B) so that one tab is pointing up (A) and the other is pointing down (D), and hold in place. Tighten strain relief screws just enough to hold the two clamp sections (C) together.

2. Attach power supply cord strain relief

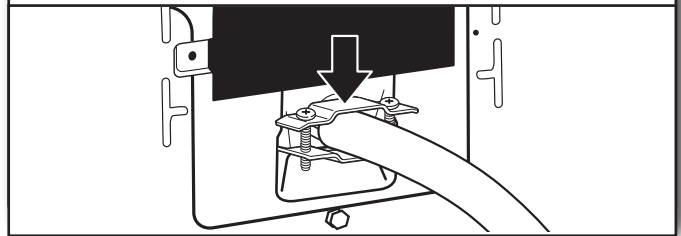

Put power supply cord through the strain relief. Be sure that the wire insulation on the power supply cord is inside the strain relief. The strain relief should have a tight fit with the dryer cabinet and be in a horizontal position. Do not further tighten strain relief screws at this point.

If your outlet looks like this:

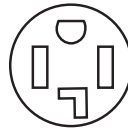

Power supply cord 4-wire receptacle (NEMA Type 14-30R):

Go to "4-Wire Power Supply Cord Connection" on page 10.



Power supply cord 3-wire receptacle (NEMA Type 10-30R):

Go to "3-Wire Power Supply Cord Connection" on page 10.

4-Wire Power Supply Cord Connection

IMPORTANT: A 4-wire connection is required for mobile homes and where local codes do not permit the use of 3-wire connections.

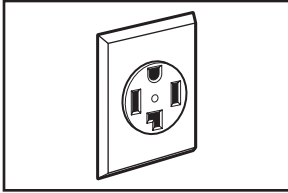

4-wire receptacle
(NEMA type 14-30R)

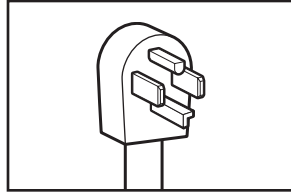

4-prong plug

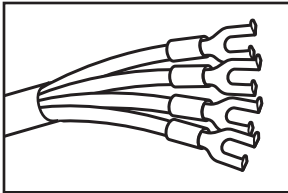

Spade terminals
with upturned ends

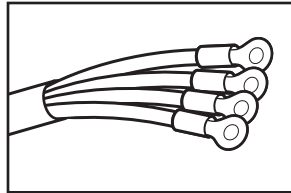

Ring terminals

1. Prepare to connect neutral ground wire and neutral wire

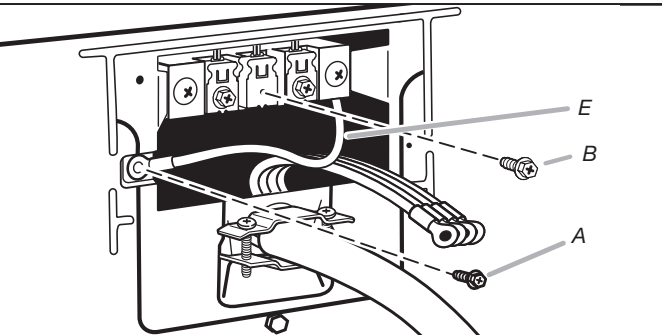

Remove center terminal block screw (B). Remove neutral ground wire (E) from external ground conductor screw (A).

2. Connect neutral ground wire and neutral wire

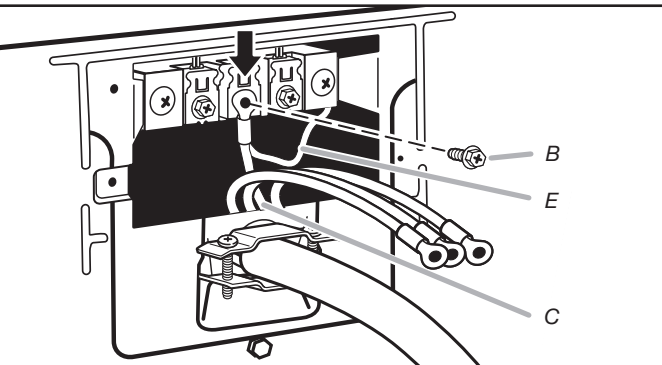

Connect neutral ground wire (E) and neutral wire (white or center) (C) of power supply cord under center terminal block screw (B). Tighten screw.

3. Connect ground wire

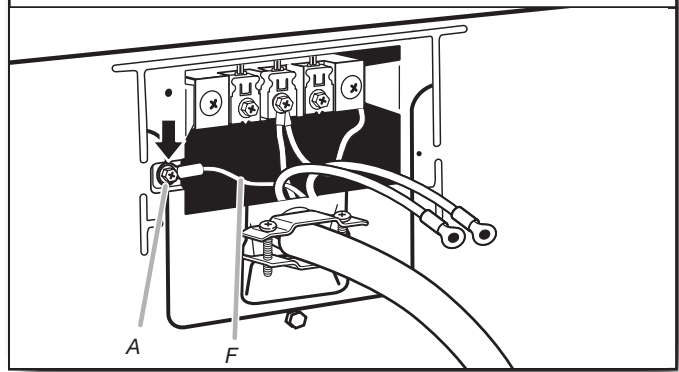

Connect ground wire (F) (green or bare) of power supply cord to external ground conductor screw (A). Tighten screw.

4. Connect remaining wires

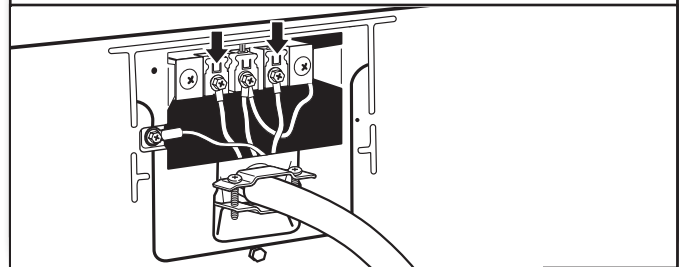

Connect remaining wires to outer terminal block screws. Tighten screws. Finally, reinsert tab of terminal block cover into slot of dryer rear panel. Secure cover with hold-down screw. Now, go to Venting Requirements.

3-Wire Power Supply Cord Connection

IMPORTANT: Use where local codes permit connecting cabinet-ground conductor to neutral wire.

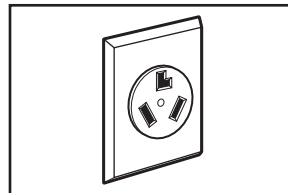

3-wire receptacle
(NEMA type 10-30R)

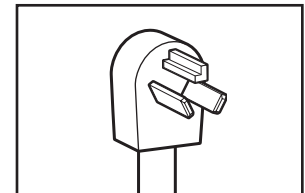

3-prong plug

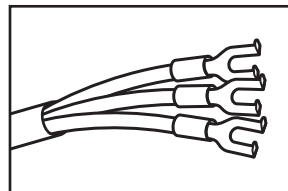

Spade terminals
with upturned ends

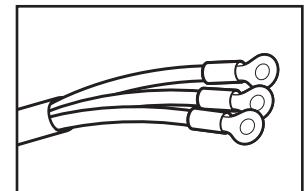

Ring terminals

1. Remove center screw

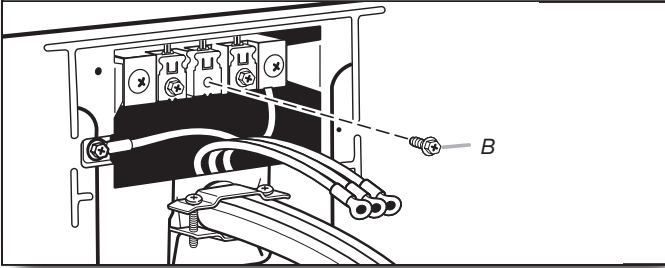

Remove center terminal block screw (B).

2. Connect neutral wire

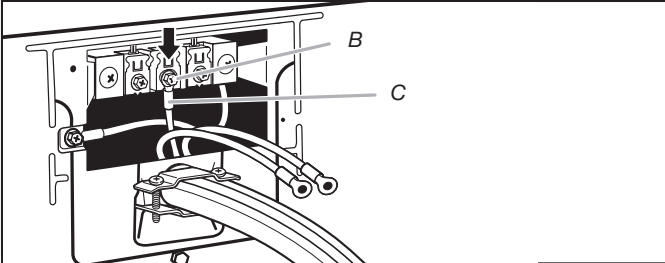

Connect neutral wire (white or center) (C) of power supply cord to center terminal block screw (B). Tighten screw.

3. Connect remaining wires

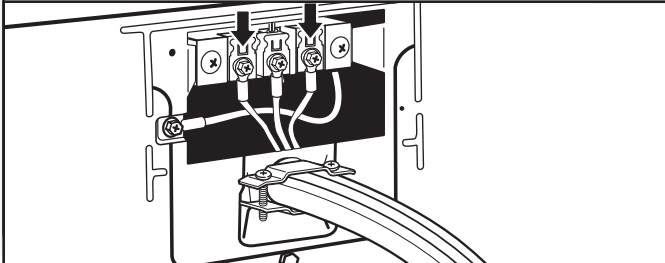

Connect remaining wires to outer terminal block screws. Tighten screws. Finally, reinsert tab of terminal block cover into slot of dryer rear panel. Secure cover with hold-down screw. Now, go to "Venting Requirements".

Direct Wire Connection

⚠ WARNING



Fire Hazard

Use 10 gauge copper wire.

Use a UL listed strain relief.

Disconnect power before making electrical connections.

Connect neutral wire (white or center wire) to center terminal.

Ground wire (green or bare wire) must be connected to green ground connector.

Connect remaining 2 supply wires to remaining 2 terminals (gold).

Securely tighten all electrical connections.

Failure to do so can result in death, fire, or electrical shock.

Direct wire strain relief

1. Attach direct wire strain relief

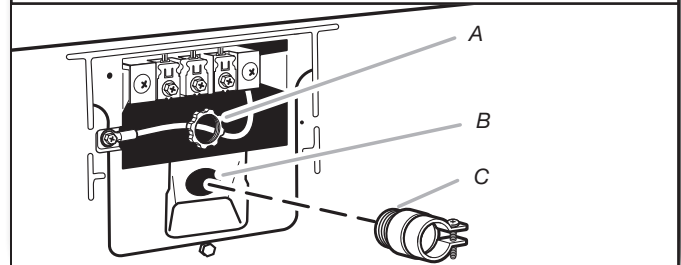

Unscrew the removable conduit connector (A) and any screws from a 3/4" (19 mm) UL Listed strain relief. Put the threaded section of the strain relief (C) through the hole below the terminal block opening (B). Reaching inside the terminal block opening, screw the removable conduit connector (A) onto the strain relief threads.

2. Attach direct wire cable to strain relief

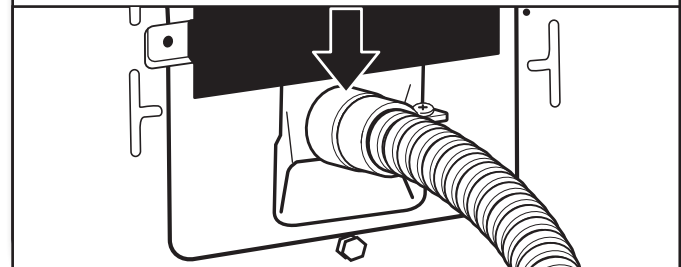

Put direct wire cable through the strain relief. The strain relief should have a tight fit with the dryer cabinet and be in a horizontal position. Tighten strain relief screw against the direct wire cable.

If your wiring looks like this:



4-wire direct connection:

Go to "4-Wire Direct Connection" on page 12.



3-wire direct connection:

Go to "3-Wire Direct Connection" on page 12.

4-Wire Direct Wire Connection

IMPORTANT: A 4-wire connection is required for mobile homes and where local codes do not permit 3-wire connections.

1. Prepare your 4-wire cable for direct connection

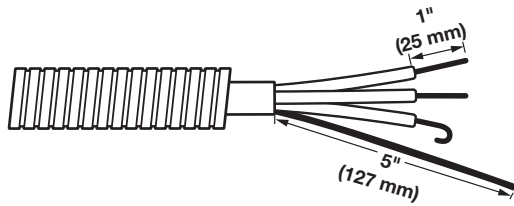

Direct wire cable must have 5 ft. (1.52 m) of extra length so dryer may be moved if needed.

Strip 5" (127 mm) of outer covering from end of cable, leaving bare ground wire at 5" (127 mm). Cut 1½" (38 mm) from remaining 3 wires. Strip insulation back 1" (25 mm). Shape ends of wires into hooks.

2. Prepare to connect neutral ground wire and neutral wire

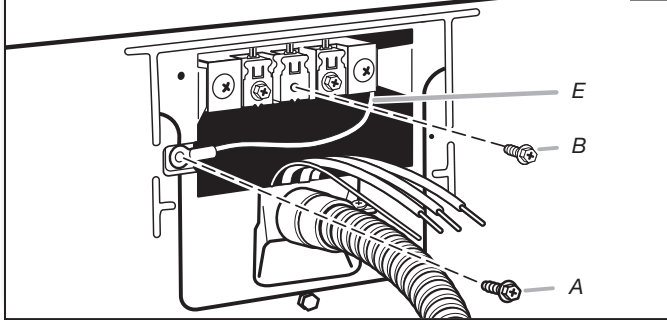

Remove center terminal block screw (B). Remove neutral ground wire (E) from external ground conductor screw (A).

3. Connect neutral ground wire and neutral wire

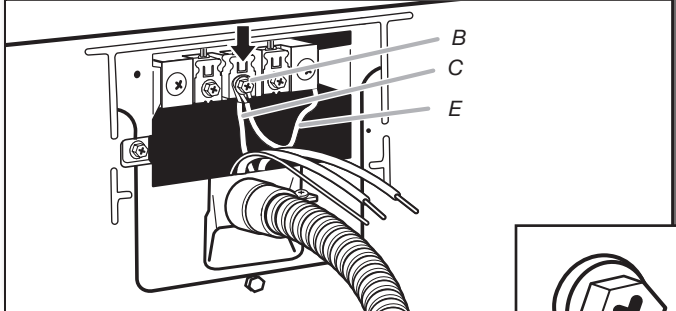

Connect neutral ground wire (E) and place hooked end (hook facing right) of neutral wire (white or center wire) (C) of direct wire cable under center screw of terminal block (B).

Squeeze hooked ends together and tighten screw.

4. Connect ground wire

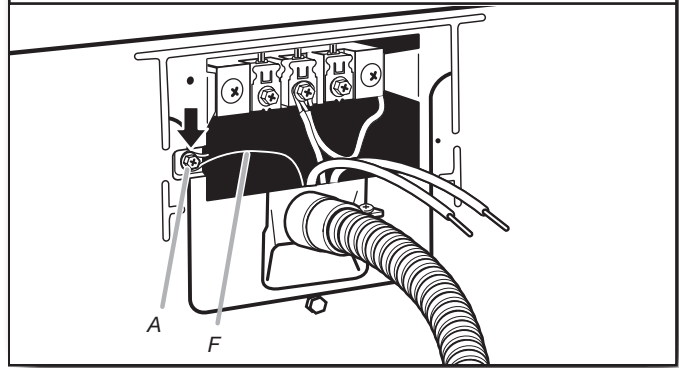

Connect ground wire (green or bare) (F) of direct wire cable to external ground conductor screw (A). Tighten screw.

5. Connect remaining wires

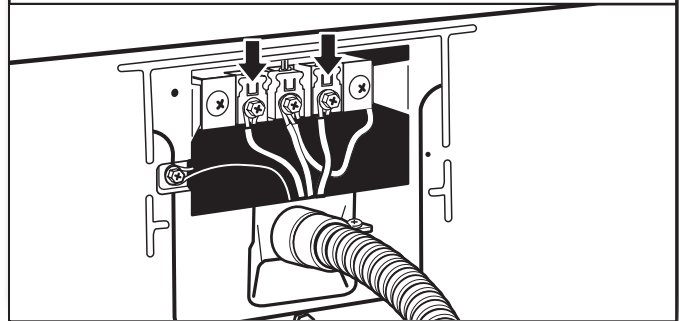

Place hooked ends of remaining direct wire cable wires under outer terminal block screws (hooks facing right). Squeeze hooked ends together and tighten screws. Finally, reinsert tab of terminal block cover into slot of dryer rear panel. Secure cover with hold-down screw. Now, go to "Venting Requirements."

3-Wire Direct Wire Connection

IMPORTANT: Use where local codes permit connecting cabinet-ground conductor to neutral wire.

1. Prepare your 3-wire cable for direct connection

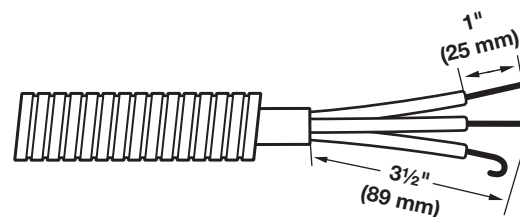

Direct wire cable must have 5 ft. (1.52 m) of extra length so dryer may be moved if needed.

Strip 3½" (89 mm) of outer covering from end of cable. Strip insulation back 1" (25 mm). If using 3-wire cable with ground wire, cut bare wire even with outer covering. Shape wire ends into hooks.

2. Remove center screw

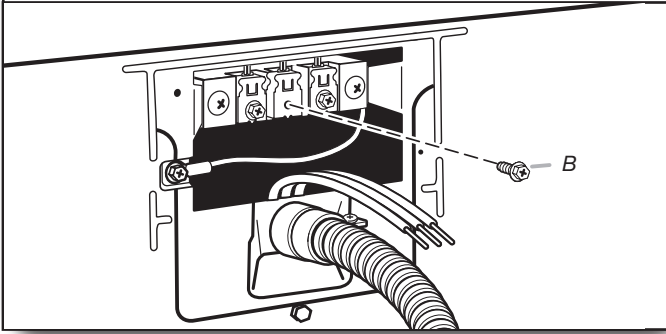

Remove center terminal block screw (B).

3. Connect neutral wire

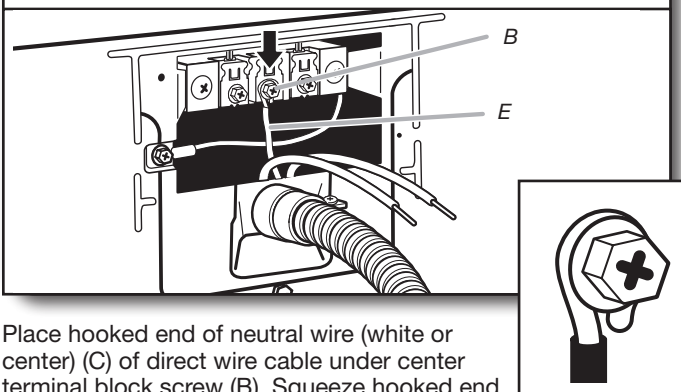

Place hooked end of neutral wire (white or center) (C) of direct wire cable under center terminal block screw (B). Squeeze hooked end together. Tighten screw.

4. Connect remaining wires

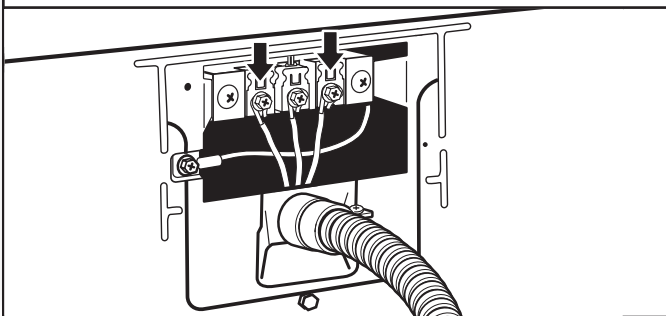

Place hooked ends of remaining direct wire cable wires under outer terminal block screws (hooks facing right). Squeeze hooked ends together and tighten screws. Finally, reinsert tab of terminal block cover into slot of dryer rear panel. Secure cover with hold-down screw.
Now, go to "Venting Requirements."

Optional 3-Wire Connection

IMPORTANT: You must verify with a qualified electrician that this grounding method is acceptable before connecting.

1. Prepare to connect neutral ground wire and neutral wire

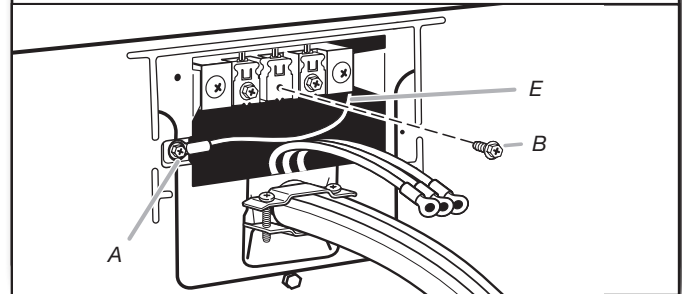

Remove center terminal block screw (B). Remove neutral ground wire (E) from external ground conductor screw (A).

2. Connect neutral ground wire and neutral wire

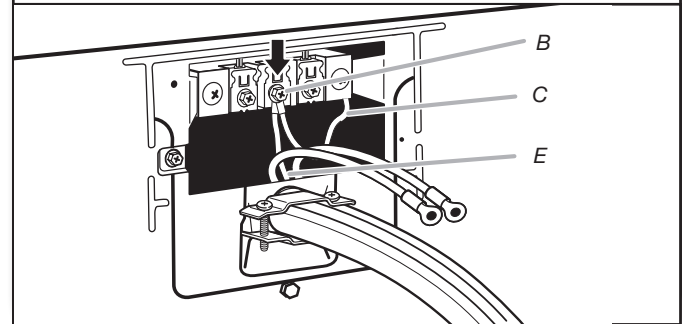

Connect neutral ground wire (E) and neutral wire (white or center wire) (C) of power supply cord or cable under center terminal block screw (B). Tighten screw.

3. Connect remaining wires

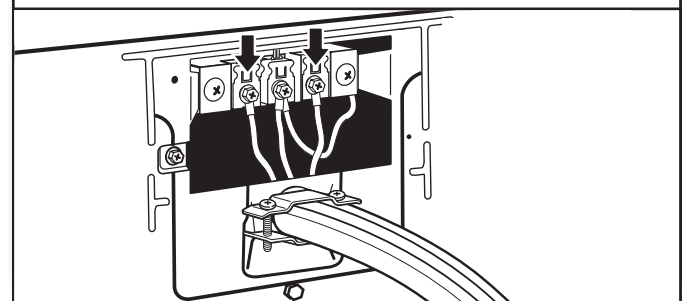

Place hooked ends of remaining wires under outer terminal block screws (hooks facing right). Tighten screws.

4. Connect external ground wire

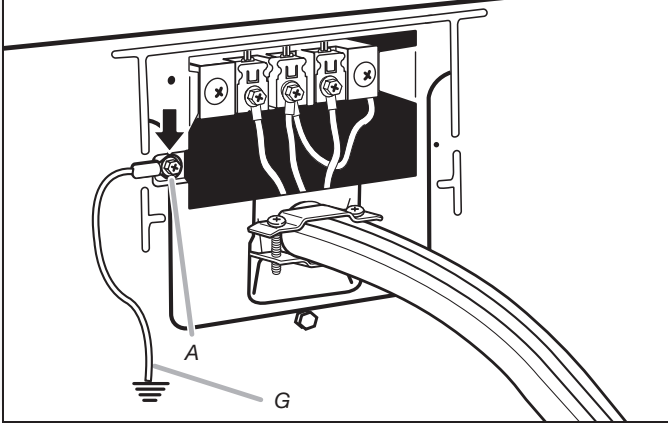

Connect a separate copper ground wire (G) from the external ground conductor screw (A) to an adequate ground. Finally, reinsert tab of terminal block cover into slot of dryer rear panel. Secure cover with hold-down screw. Now, go to "Venting Requirements".

VENTING

Venting Requirements

⚠ WARNING



Fire Hazard

Use a heavy metal vent.

Do not use a plastic vent.

Do not use a metal foil vent.

Failure to follow these instructions can result in death or fire.

WARNING: To reduce the risk of fire, this dryer **MUST BE EXHAUSTED OUTDOORS.**

IMPORTANT: Observe all governing codes and ordinances. Dryer exhaust must not be connected into any gas vent, chimney, wall, ceiling, attic, crawlspace, or a concealed space of a building. Only rigid or flexible metal vent shall be used for exhausting.

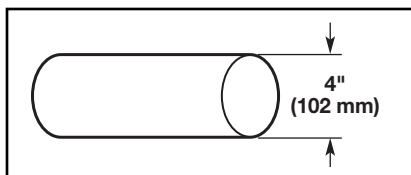

4" (102 mm) heavy metal exhaust vent

- Only a 4" (102 mm) heavy metal exhaust vent and clamps may be used.
- Do not use plastic or metal foil vent.

Rigid metal vent:

- Recommended for best drying performance and to avoid crushing and kinking.

Flexible metal vent: (Acceptable only if accessible to clean)

- Must be fully extended and supported in final dryer location.
- Remove excess to avoid sagging and kinking that may result in reduced airflow and poor performance.
- Do not install in enclosed walls, ceilings, or floors.
- The total length should not exceed 7³/₄ ft. (2.4 m).

NOTE: If using an existing vent system, clean lint from entire length of the system and make sure exhaust hood is not plugged with lint. Replace plastic or metal foil vents with rigid metal or flexible metal vents. Review "Vent System Chart" and, if necessary, modify existing vent system to achieve best drying performance.

Exhaust hoods:

- Must be at least 12" (305 mm) from ground or any object that may obstruct exhaust (such as flowers, rocks, bushes, or snow).

Recommended Styles:

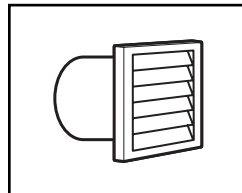

Louvered hood

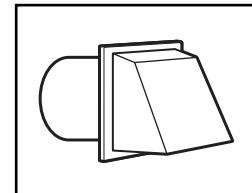

Box hood

Acceptable Style:

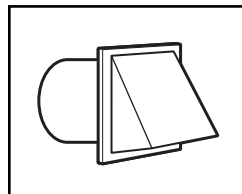

Angled hood

Elbows:

- 45° elbows provide better airflow than 90° elbows.

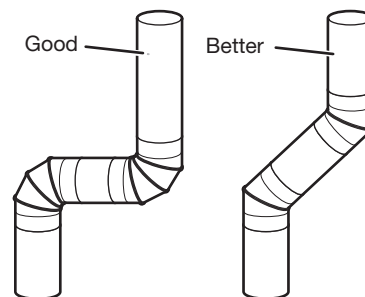

Clamps:

- Use clamps to seal all joints.
- Exhaust vent must not be connected or secured with screws or other fastening devices that extend into interior of duct and catch lint. Do not use duct tape.

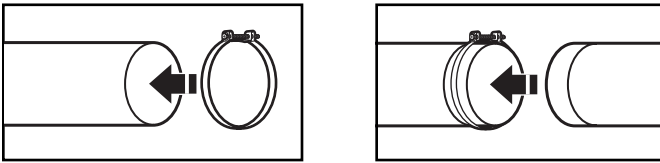

See "Venting Kits" for more information.

Plan Vent System

Recommended exhaust installations

Typical installations vent the dryer from the rear of the dryer. Other installations are possible.

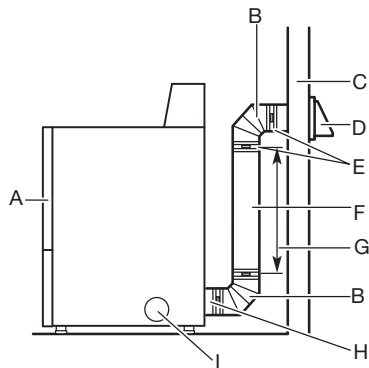

- A. Dryer
- B. Elbow
- C. Wall
- D. Exhaust hood
- E. Clamps
- F. Rigid metal or flexible metal vent
- G. Vent length necessary to connect elbows
- H. Exhaust outlet
- I. Optional side exhaust outlet

Optional exhaust installations:

Exhaust can be converted out the right side, left side, or through the bottom (4-way vent kit). Each kit includes step-by-step instructions. For ordering information, see "Venting Kits."

⚠ WARNING

Fire Hazard

Cover unused exhaust holes with a manufacturer's exhaust cover kit.

Contact your local dealer.

Failure to follow these instructions can result in death, fire, electrical shock, or serious injury.

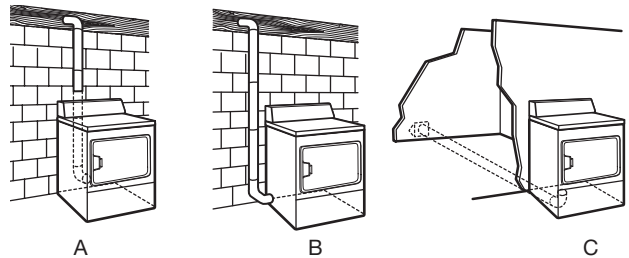

- A. Standard rear offset exhaust installation
- B. Left or right side exhaust installation
- C. Bottom exhaust installation

Alternate installations for close clearances

Venting systems come in many varieties. Select the best type for your installation. Two close-clearance installations are shown. Refer to the manufacturer's instructions.

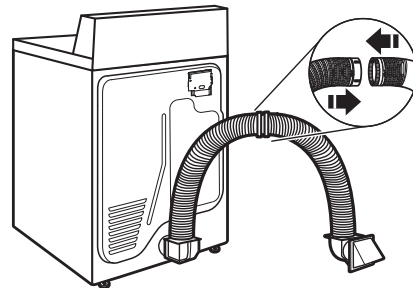

Over-The-Top installation (also available with one offset elbow)

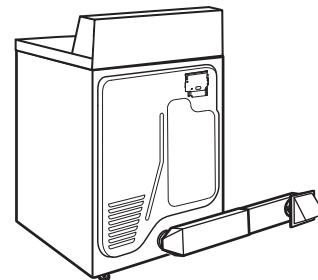

Periscope installation

NOTE: The following kits for close clearance alternate installations are available for purchase.

Venting Kits

For more information, call 1-800-344-1274, or visit us at www.maytagreplacementparts.com.

Part Number	Descriptions
8171587RP	0"-5" Metal vent periscope
4396037RP	0"-18" Metal vent periscope
4396011RP	18"-29" Metal vent periscope
4396014	29"-50" Metal vent periscope
4392892	In-wall metal DuraVent™ periscope
W10186596	4-way vent kit – universal grey
4396028	Sure Connect™ venting kit (over-the-top installation)
4396009RP	5' Universal connect vent, flexible dryer venting
4396010RP	6' SecureConnect™ vent, flexible dryer venting
4396013RB	Dryer vent installer's kit
4396033RP	5' flexible dryer venting with clamps
4396727RP	8' flexible dryer venting with clamps
4396004	Dryer offset elbow
4396005	Wall offset elbow
4396006RW	DuraSafe™ close elbow
4396007RW	Through-the-wall vent cap
4396008RP	4" steel dryer venting clamps – 2 pack
8212662	Flush mounting louvered vent hood, 4"

Special provisions for mobile home installations:

The exhaust vent must be securely fastened to a noncombustible portion of the mobile home structure and must not terminate beneath the mobile home. Terminate the exhaust vent outside.

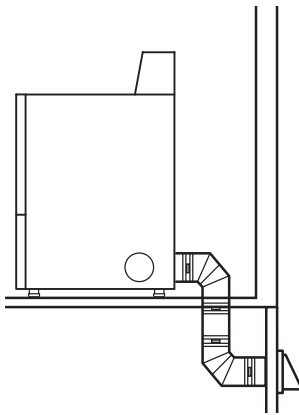

Determine vent path:

- Select route that will provide straightest and most direct path outdoors.
- Plan installation to use fewest number of elbows and turns.
- When using elbows or making turns, allow as much room as possible.
- Bend vent gradually to avoid kinking.
- Use as few 90° turns as possible.

Determine vent length and elbows needed for best drying performance:

- Use following Vent System Chart to determine type of vent material and hood combinations acceptable to use.

NOTE: Do not use vent runs longer than those specified in Vent System Chart. Exhaust systems longer than those specified will:

- Shorten life of dryer.
- Reduce performance, resulting in longer drying times and increased energy usage.

The Vent System Chart provides venting requirements that will help achieve best drying performance.

Vent System Chart			
Number of 90° turns or elbows	Type of vent	Box/louvered hoods	Angled hoods
0	Rigid metal	64 ft. (20 m)	58 ft. (17.7 m)
1	Rigid metal	54 ft. (16.5 m)	48 ft. (14.6 m)
2	Rigid metal	44 ft. (13.4 m)	38 ft. (11.6 m)
3	Rigid metal	35 ft. (10.7 m)	29 ft. (8.8 m)
4	Rigid metal	27 ft. (8.2 m)	21 ft. (6.4 m)

NOTE: Side and bottom exhaust installations have a 90° turn inside the dryer. To determine maximum exhaust length, add one 90° turn to the chart.

Install Vent System

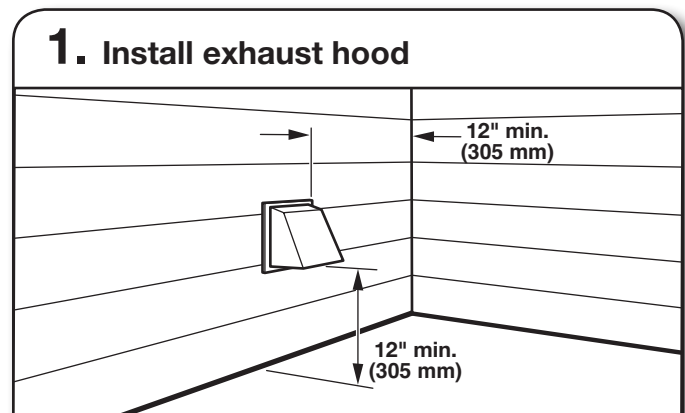

Install exhaust hood and use caulking compound to seal exterior wall opening around exhaust hood.

2. Connect vent to exhaust hood

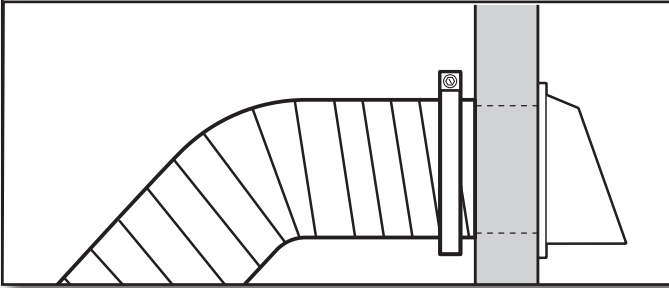

Vent must fit over the exhaust hood. Secure vent to exhaust hood with 4" (102 mm) clamp. Run vent to dryer location using straightest path possible. Avoid 90° turns. Use clamps to seal all joints. Do not use duct tape, screws, or other fastening devices that extend into interior of vent to secure vent, because they can catch lint.

Connect Vent

1. Connect vent to exhaust outlet

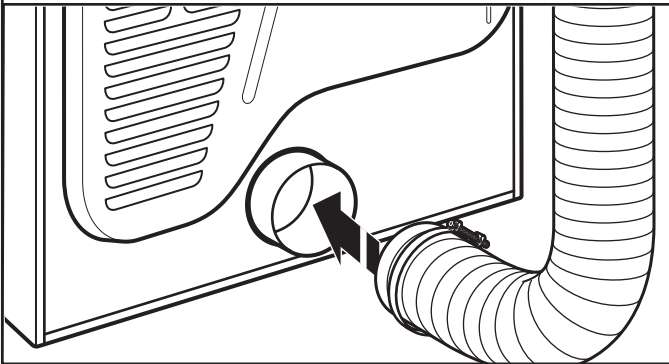

Using a 4" (102 mm) clamp, connect vent to exhaust outlet in dryer. If connecting to existing vent, make sure vent is clean. Dryer vent must fit over dryer exhaust outlet and inside exhaust hood. Check that vent is secured to exhaust hood with a 4" (102 mm) clamp.

2. Move dryer to final location

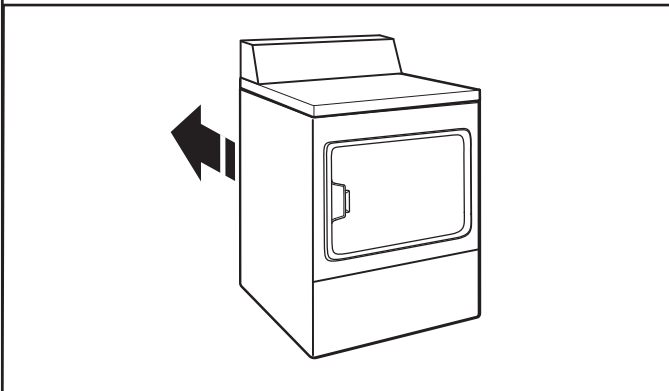

Move dryer to final location. Avoid crushing or kinking vent. After dryer is in place, remove corner posts and cardboard from under the dryer.

LEVEL DRYER

1. Level dryer

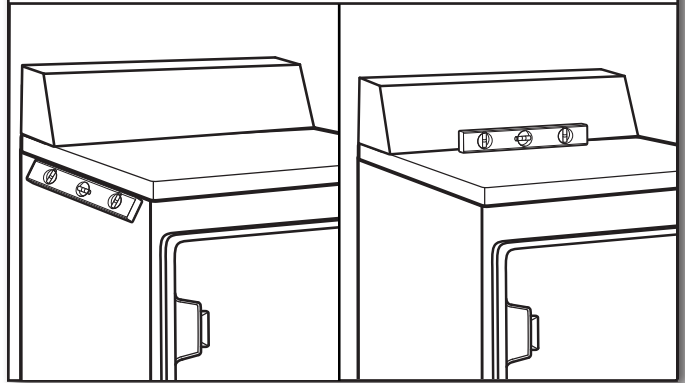

Check levelness of dryer from side to side. Repeat from front to back.

NOTE: The dryer must be level for the moisture sensing system to operate correctly.

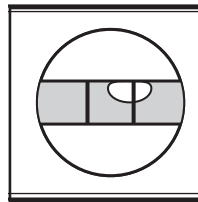

Not Level

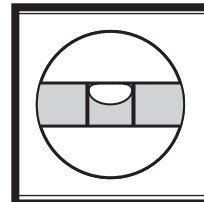

LEVEL

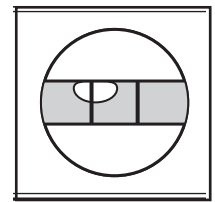

Not Level

2. Tighten and adjust leveling legs

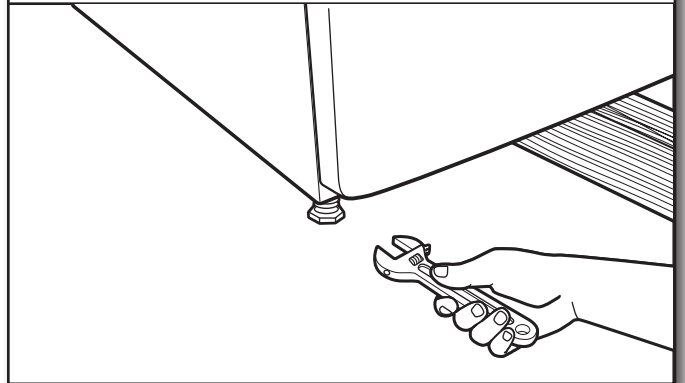

If dryer is not level or the same height as the washer, prop up using a wood block. Use wrench to adjust legs up or down, and check again for levelness. Once dryer is level, make sure all four legs are snug against the floor before tightening them.

COMPLETE INSTALLATION CHECKLIST

- Check that all parts are now installed. If there is an extra part, go back through steps to see what was skipped.
- Check that you have all of your tools.
- Dispose of/recycle all packaging materials.
- Check dryer's final location. Be sure vent is not crushed or kinked.
- Check that dryer is level. See "Level Dryer."
- Remove film on console and any tape remaining on dryer.
- Wipe dryer drum interior thoroughly with a damp cloth to remove any dust.
- Read "Dryer Use" in your Use and Care Guide.
- Set the dryer on a full heat cycle (not an air cycle) for 20 minutes and start the dryer.

If the dryer will not start, check the following:

- Controls are set in a running or On position.
 - Start button has been pushed firmly.
 - Dryer is plugged into an outlet and/or electrical supply is on.
 - Household fuse is intact and tight, or circuit breaker has not tripped.
 - Dryer door is closed.
- When the dryer has been running for 5 minutes, open the dryer door and feel for heat. If you feel heat, cancel cycle and close the door.

If you do not feel heat, turn the dryer off and check the following:

- There may be two household fuses or circuit breakers for the dryer. Check that both fuses are intact and tight, or that both circuit breakers have not tripped. If there is still no heat, contact a qualified technician.

NOTE: You may notice an odor when the dryer is first heated. This odor is common when the heating element is first used. The odor will go away.

REVERSE DOOR SWING (OPTIONAL)

NOTE: Magnetized screwdriver is helpful.

27" Wide Model Side-Swing Door

1. Place towel on dryer

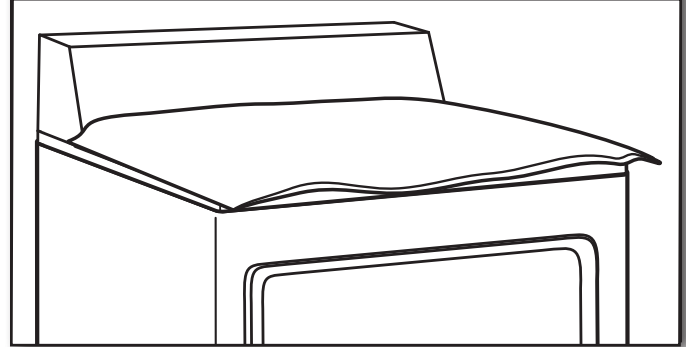

Place towel on top of dryer to avoid damaging the surface.

2. Remove bottom screws

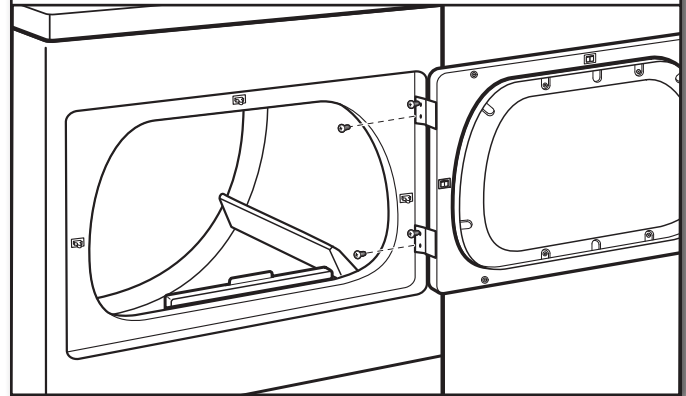

Open dryer door. Remove bottom screws from dryer cabinet side of hinges. Loosen (do not remove) top screws from dryer cabinet side of hinges.

3. Lift door off top screws

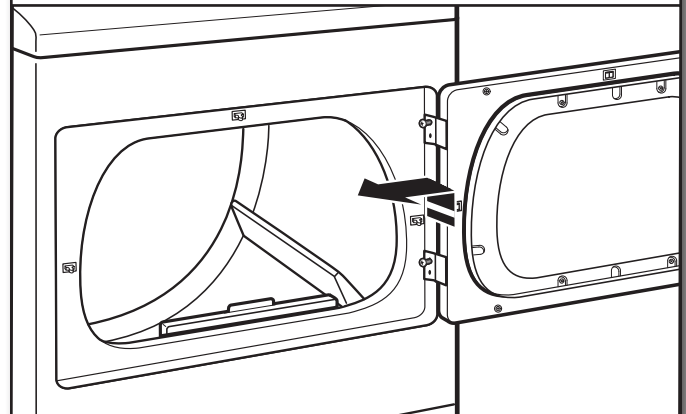

Lift door until top screws in dryer cabinet are in large part of hinge slot. Pull door forward off screws. Set door (handle side up) on top of dryer. Remove top screws from dryer cabinet.

4. Remove screws from hinges

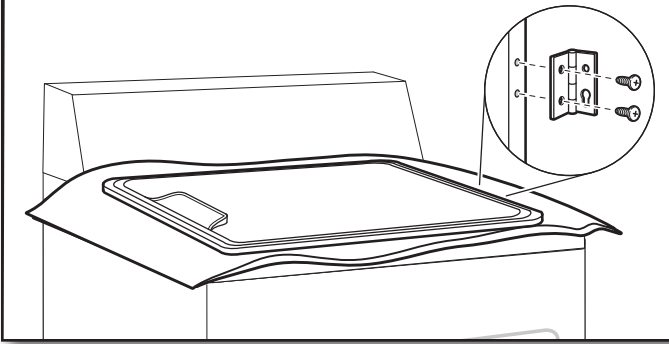

Remove screws attaching hinges to door.

5. Remove screws from door

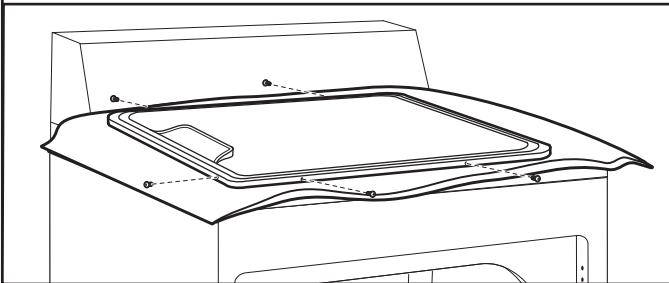

Remove screws at top, bottom, and side of door (five screws). Keep door screws separate from hinge screws as they are different sizes. Holding door over towel on dryer, grasp sides of outer door and lift to separate it from inner door.

NOTE: Do not pry apart with putty knife or screwdriver. Do not pull on door seal or plastic door catches.

6. Rotate outer door

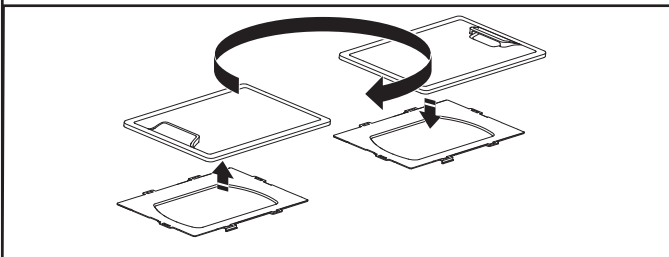

Rotate outer door 180° and set it back down on inner door. Be certain to keep cardboard spacer centered between doors. Reattach outer door panel to inner door panel so handle is on the side where hinges were just removed. Insert five door screws.

7. Flip door over

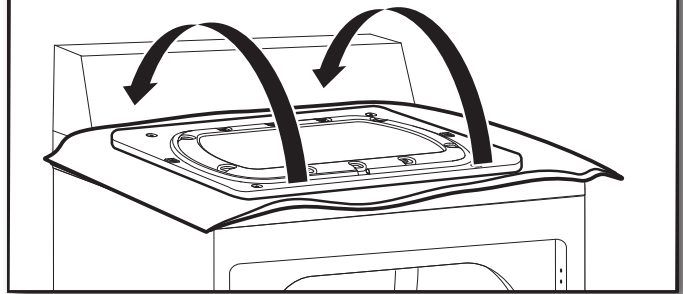

Flip door over so handle side is down.

8. Attach door hinges

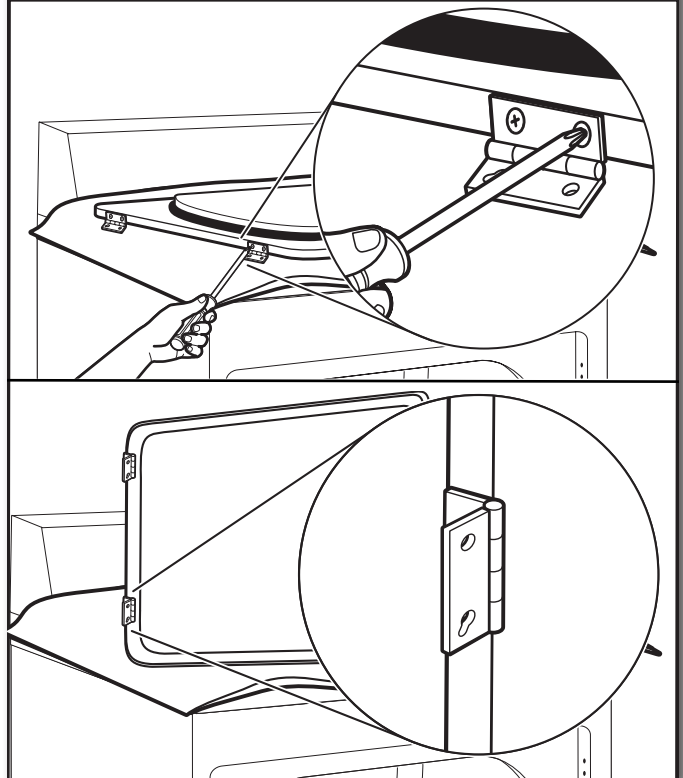

Reattach door hinges to dryer door so that the larger hole is at the bottom of the hinge.

9. Remove and transfer plugs

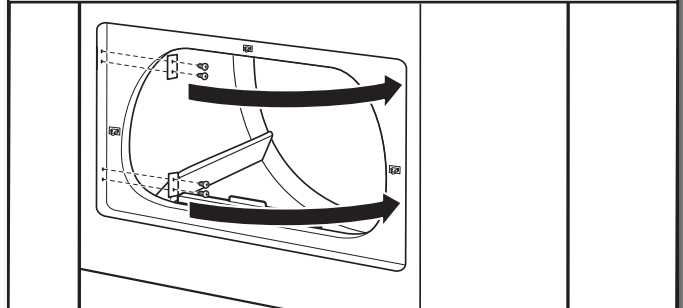

Remove the four screws that attach two plugs on the left side. Transfer plugs to opposite side using the same four screws.

10. Insert screws in hinge holes on dryer cabinet

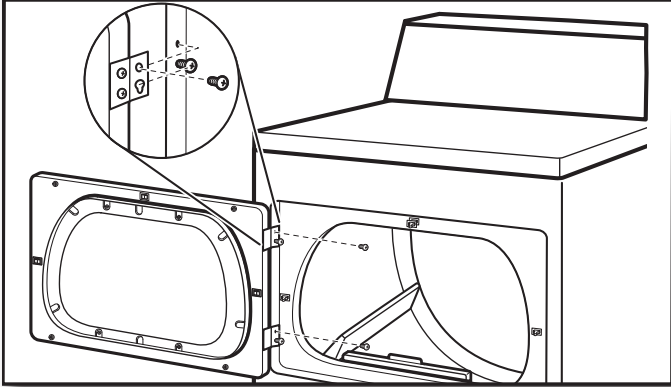

NOTE: Two people may be needed to reinstall door.

Insert screws into the bottom holes on left side of dryer cabinet. Tighten screws halfway. Position door so large end of door hinge slot is over screws. Slide door up so screws are in bottom of slots. Tighten screws. Insert and tighten top screws in hinges.

11. Check door strike alignment

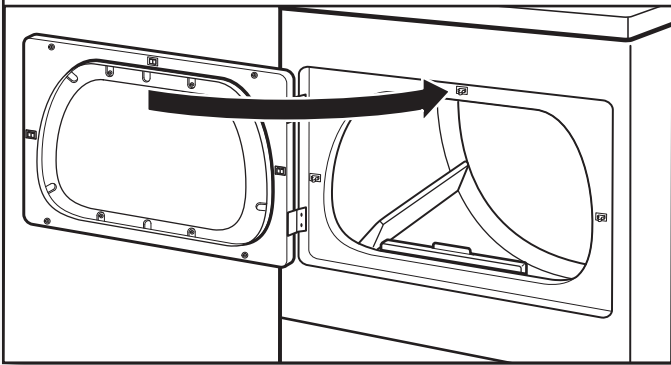

Close door and check that door strike aligns with door catch. If it is needed, slide door catch left or right within slot to adjust alignment.

TROUBLESHOOTING

See the Use and Care Guide or visit our website and reference "Frequently Asked Questions" to possibly avoid the cost of a service call.

