

# FRIGIDAIRE

All about the

# Use & Care

of your Electric Range

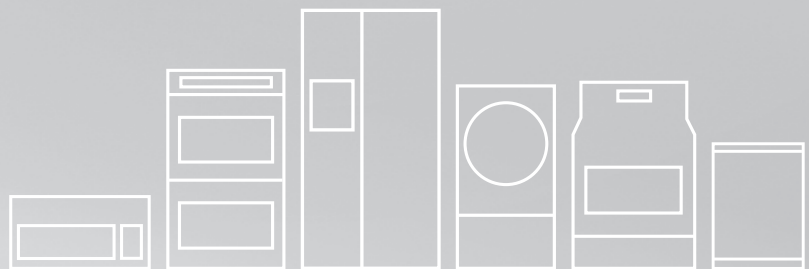

## TABLE OF CONTENTS

Product Record and Registration .....	2	Setting Oven Controls .....	20
Important Safety Instructions .....	3	Care and Cleaning .....	38
Cooking Recommendations .....	9	Before You Call .....	44
Before Setting Surface Controls .....	12	Warranty .....	48
Setting Surface Controls .....	15		
Before Setting Oven Controls .....	19		

A13080701 Rev D (September 2019)

# PRODUCT RECORD AND REGISTRATION

Product Registration . . . . .	2
<b>Product Record and Registration</b> . . . . .	<b>2</b>
Need Help? . . . . .	2
<b>Important Safety Instructions</b> . . . . .	<b>3</b>
<b>Cooking Recommendations</b> . . . . .	<b>9</b>
<b>Before Setting Surface Controls</b> . . . . .	<b>12</b>
<b>Setting Surface Controls</b> . . . . .	<b>15</b>
<b>Before Setting Oven Controls</b> . . . . .	<b>19</b>
<b>Setting Oven Controls</b> . . . . .	<b>20</b>
<b>Care and Cleaning</b> . . . . .	<b>38</b>
Oven Baking . . . . .	44
<b>Before You Call</b> . . . . .	<b>44</b>
<b>Warranty</b> . . . . .	<b>48</b>

## Questions?

For toll-free telephone support in the U.S. and Canada call **1-800-944-9044**

For online support and Internet production information visit <http://www.frigidaire.com>.

## Product Registration

Registering your product with Frigidaire enhances our ability to serve you. You can register online at <http://www.frigidaire.com> or by dropping your Product Registration Card in the mail.

### Record model & serial numbers here

---

**Purchase Date**

---

**Frigidaire model number**

---

**Frigidaire serial number**

### Serial Plate Location

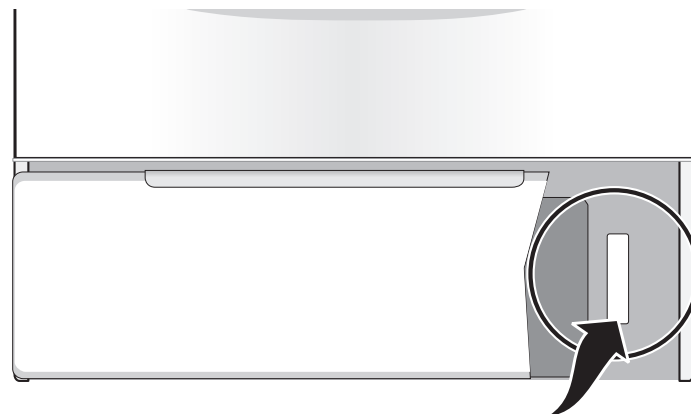

Serial plate location: open lower oven drawer (some models) or storage drawer (some models).

## Thank you for choosing Frigidaire.

**Important:** This Use and Care Guide is part of our commitment to customer satisfaction and product quality throughout the service life of your new appliance. We view your purchase as the beginning of a relationship. To ensure our ability to continue serving you, please use this page to record important product information.

## Need Help?

### Visit the Frigidaire web site at [www.frigidaire.com](http://www.frigidaire.com)

Before you call for service, there are a few things you can do to help us serve you better.

### Read this Use & Care Manual

This manual contains instructions to help you use and maintain your range properly.

### If You Received a Damaged Range...

Immediately contact the dealer (or builder) that sold you the range.

### Save Time and Money

Check the section title "Before You Call". This section helps step you through some common problems that might occur.

If you do need service, help is only a phone call away. Call Frigidaire Customer Services at **1-800-944-9044**.

## IMPORTANT SAFETY INSTRUCTIONS

Read all instructions before using this appliance.

This manual contains important safety symbols and instructions. Please pay attention to these symbols and follow all instructions given.

Do not attempt to install or operate your appliance until you have read the safety precautions in this manual. Safety items throughout this manual are labeled with a **WARNING** or **CAUTION** statement based on the risk type.

Warnings and important instructions appearing in this guide are not meant to cover all possible conditions and situations that may occur. Common sense, caution, and care must be exercised with installing, maintaining, or operating your appliance.

### DEFINITIONS

 This is the safety alert symbol. It is used to alert you to potential personal injury hazards. Obey all safety messages that follow this symbol to avoid possible injury or death.

#### **WARNING**

Indicates a potentially hazardous situation which, if not avoided, may result in death or serious injury.

#### **CAUTION**

Indicates a potentially hazardous situation which, if not avoided, may result in minor or moderate injury.

#### **IMPORTANT**

Indicates installation, operation, maintenance, or valuable information that is not hazard related.

#### **NOTE**

Indicates a short, informal reference – something written down to assist the memory or for future reference.

#### **WARNING**

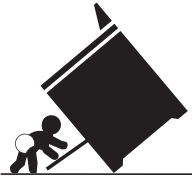

#### Tip Over Hazard

- **A child or adult can tip the range and be killed.**
- **Verify the anti-tip device has been installed to floor or wall.**
- **Ensure the anti-tip device is re-engaged to floor or wall when the range is moved.**
- **Do not operate the range without the anti-tip device in place and engaged.**
- **Failure to follow these instructions can result in death or serious burns to children and adults.**

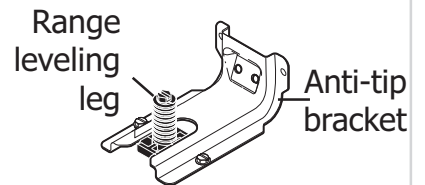

To check if the anti-tip bracket is installed properly, use both arms to grasp the rear edge of the range back. Carefully attempt to tilt range forward. When properly installed, the range should not tilt forward.

Refer to the anti-tip bracket installation instructions supplied with your range for proper installation.

#### **IMPORTANT**

Save these instructions for future reference.

## IMPORTANT SAFETY INSTRUCTIONS

### IMPORTANT INSTRUCTIONS FOR UNPACKING AND INSTALLATION

**IMPORTANT** - Read and follow the below instructions and precautions for unpacking, installing, and servicing your appliance:

Remove all tape and packaging before using the appliance. Destroy the carton and plastic bags after unpacking the appliance. Never allow children to play with packaging material. Do not remove the wiring label and other literature attached to the appliance. Do not remove model/serial number plate.

Cold temperatures can damage the electronic control. When using this appliance for the first time, or when the appliance has not been used for an extended period of time, be sure the appliance has been in temperatures above 32°F (0°C) for at least 3 hours before turning on the power to the appliance.

Never modify or alter the construction of the appliance by removing the leveling legs, panels, wire covers, anti-tip brackets/screws, or any other part of the appliance.

Be sure to have an appropriate foam-type fire extinguisher available, visible, and easily accessible located near the appliance.

### GROUNDING INSTRUCTIONS

#### **WARNING**

Avoid fire hazard or electrical shock. Failure to follow this warning may cause serious injury, fire, or death.

Avoid fire hazard or electrical shock. Do not use an adapter plug, use an extension cord, or remove grounding prong from the power cord. Failure to follow this warning may cause serious injury, fire, or death.

**Proper Installation**—Be sure your appliance is properly installed and grounded by a qualified technician. In the United States, install in accordance with the National Fuel Gas Code ANSI Z223.1/NPFA No. 54, latest edition and National Electrical Code NFPA No. 70 latest edition, and local electrical code requirements. In Canada, install in accordance with CAN/CGA B149.1 and CAN/CGA B149.2 and CSA Standard C22.1, Canadian Electrical code, Part 1-latest editions and local electrical code requirements. Install only per installation instructions provided in the literature package for this appliance.

For personal safety, this appliance must be properly grounded. For maximum safety, the power cord must be securely connected to an electrical outlet or junction box that is the correct voltage, is correctly polarized and properly grounded, and protected by a circuit breaker in accordance with local codes.

It is the personal responsibility of the consumer to have the appropriate outlet or junction box with the correct, properly grounded wall receptacle installed by a qualified electrician. It is the responsibility and obligation of the consumer to contact a qualified installer to assure that the electrical installation is adequate and is in conformance with all local codes and ordinances.

See the installation instructions packaged with this appliance for complete installation and grounding instructions.

Save these instructions for future reference



## IMPORTANT SAFETY INSTRUCTIONS

### IMPORTANT INSTRUCTIONS FOR USING THE APPLIANCE

#### WARNING

**Storage In or On Appliance**—Flammable materials should not be stored in an oven or microwave, near surface burners or elements, or in the storage or warmer drawer (if equipped). This includes paper, plastic, and cloth items, such as cookbooks, plastic ware, and towels, as well as flammable liquids. Do not store explosives, such as aerosol cans, on or near the appliance.

**Do not leave children alone** - Children should not be left alone or unattended in the area where appliance is in use. They should never be allowed to sit or stand on any part of the appliance, including the storage drawer, lower broiler drawer, warmer drawer, or lower double oven.

Do not store items of interest to children in the cabinets above the appliance or on the back-guards of ranges. Children climbing on or near the appliance to reach items could be seriously injured.

Do not allow children to climb or play around the appliance. The weight of a child on an open over door may cause the appliance to tip, resulting in serious burns or other injury. An open drawer when hot may cause burns.

Stepping, leaning, or sitting on the door or drawers of this appliance can result in serious injuries and also cause damage to the appliance.

#### WARNING

Never cover any slots, holes, or passages in the oven bottom or cover an entire oven rack with any materials, such as aluminum foil or after-market oven liners. Doing so blocks air flow through the oven and may result in carbon monoxide poisoning. Aluminum foil and other liners may trap heat, causing a fire hazard.

Do not use oven or warmer drawer (if equipped) for storage.

Never use your appliance as a space heater to heat or warm the room. Doing so may result in carbon monoxide poisoning and overheating of the appliance.

#### CAUTION

When heating fat or grease, watch it closely. Grease may catch fire if it becomes too hot.

Do not use water or flour on grease fires. Smother fire or flame or use dry chemical or foam-type extinguisher. Cover the fire with a pan lid or use baking soda.

Use dry potholders. Moist or damp potholders on hot surfaces may result in burns from steam. Do not let potholders touch hot cooking areas. Do not use towels or other bulky cloths.

Do not heat unopened food containers - Build-up of pressure may cause container to burst and result in injury.

## IMPORTANT SAFETY INSTRUCTIONS

### CAUTION

Wear proper apparel - Loose-fitting or hanging garments should never be worn while using the appliance. Do not let clothing or other flammable materials contact hot surfaces.

Do not touch surface burners or elements, areas near these burners or elements, interior surfaces of the oven, or the warmer drawer (if equipped). Surface burners and elements may be hot even though they appear cool. Areas near surface burners and elements may become hot enough to cause burns. During and after use, do not touch, or let clothing or other flammable materials touch these areas until they are cool. These areas may include the cooktop, surfaces facing the cooktop, oven vent areas, oven door, and oven window.

Do not attempt to operate the appliance during a power failure. If the power fails, always turn off the appliance. If the appliance is not turned off and the power resumes, electric surface elements may resume operation when power is restored. Once the power resumes, reset the clock and the oven function.

### IMPORTANT INSTRUCTIONS FOR USING YOUR RADIANT COOKTOP

Know which knob or key controls each surface heating area. Place cookware with food on the cooking area before turning it on. Turn the cooking area off before removing the cookware.

Cookware handles should be turned inward and not extend over adjacent surface elements — To reduce the risk of burns, ignition of flammable materials, and spillage due to unintentional contact with the utensil, the handle of the cookware should be positioned so that it is turned inward, and does not extend over other cooking areas.

Use proper pan size - This appliance is equipped with one or more surface units of different sizes. Select cookware with flat bottoms that match the surface unit size. Using the proper cookware on the cooking area will improve efficiency.

Glazed cooking utensils— Only certain types of glass, glass/ceramic, ceramic, earthenware, or other glazed utensils are suitable for cooktop service without breaking due to the sudden change in temperature. Check the manufacturer's recommendations for cooktop use.

Improper cookware may break due to sudden changes in temperature. Check the cookware manufacturer's recommendations for cooktop use.

Never leave surface elements unattended. Boil-overs may cause smoking and greasy spills that may ignite. A pan that has boiled dry could be damaged and may damage the cooktop.

Do not use a searing grill meant for use with a broiler pan on the cooktop. The searing grill is not designed for use on the cooktop. Doing so may result in a fire.

When you are flaming foods under a ventilating hood, turn on the fan.

Save these instructions for future reference

## IMPORTANT SAFETY INSTRUCTIONS

### IMPORTANT INSTRUCTIONS FOR GLASS AND CERAMIC COOKTOPS

Do Not Clean or Operate a Broken Cooktop. If cooktop should break, cleaning solutions and spillovers may penetrate the broken cooktop and create a risk of electric shock. Contact a qualified technician immediately.

Clean cooktop glass with caution. If a wet sponge or cloth is used to wipe spills on a hot cooking area, be careful to avoid a steam burn. Some cleaners can produce harmful fumes if applied to a hot surface.

Avoid scratching the cooktop glass with sharp objects.

### IMPORTANT INSTRUCTIONS FOR USING YOUR OVEN

Protective liners—Do not use aluminum foil, aftermarket oven liners, or any other materials or devices to line oven bottom, oven racks, or any other part of the appliance. Only use aluminum as recommended for baking, such as lining cookware or as a cover placed on food. Any other use of protective liners or aluminum foil may result in a risk of electric shock or fire or a short circuit.

Use care when opening oven door, lower oven door, or warmer drawer (some models). Stand to the side of the appliance when opening the door of a hot oven. Let hot air or steam escape before you remove or replace food in the oven.

Keep oven vent ducts unobstructed. Touching surfaces in this area when the oven is on may cause severe burns. Do not place plastic or heat-sensitive items on or near the oven vent. These items can melt or ignite.

Placement of oven racks - Always place oven racks in desired location while oven is cool. If rack must be moved while oven is hot, do not let potholder contact hot burner or element in oven. Use potholders and grasp the rack with both hands to reposition. Remove all cookware and utensils before moving the rack.

Do not use a broiler pan without its insert. Broiler pans and inserts allow dripping fat to drain away from the high heat of the broiler. Do not cover the broiler insert with aluminum foil; exposed fat and grease could ignite.

Do not cook food on the oven bottom. Always cook in proper cookware and always use the oven racks.

### IMPORTANT INSTRUCTIONS FOR CLEANING YOUR APPLIANCE

#### CAUTION

Before manually cleaning any part of the appliance, be sure all controls are turned off and the appliance is cool. Cleaning a hot appliance can cause burns.

Clean the appliance regularly to keep all parts free of grease that could catch fire. Do not allow grease to accumulate. Greasy deposits in the fan could catch fire.

Always follow the manufacturer's recommended directions for use of kitchen cleaners and aerosols. Be aware that excess residue from cleaners and aerosols may ignite causing damage and injury.

Clean ventilating hoods frequently - Grease should not be allowed to accumulate on hood or filter. Follow the manufacturer's instructions for cleaning vent hoods.

## IMPORTANT SAFETY INSTRUCTIONS

### IMPORTANT INSTRUCTIONS FOR SELF CLEANING OVENS

Do not clean the oven door gasket. The door gasket is essential for a good seal. Care should be taken not to rub, damage, or move the gasket.

Do not use oven cleaners. No commercial oven cleaner or oven liner protective coating of any kind should be used in or around any part of the appliance.

Use the self clean cycle to clean only the parts listed in this manual.

Before using self clean, remove the broiler pan, any food, utensils, and cookware from the oven, storage drawer or warming drawer (if equipped). Remove oven racks unless otherwise instructed.

Some birds are extremely sensitive to the fumes given off during the self clean cycle of any oven. Move birds to another well-ventilated room.

### IMPORTANT INSTRUCTIONS FOR SERVICE AND MAINTENANCE

Do not repair or replace any part of the appliance unless specifically recommended in the manuals. All other servicing should be done only by a qualified technician. This reduces the risk of personal injury and damage to the appliance.

Always contact your dealer, distributor, service agent, or manufacturer about problems or conditions you do not understand.

Ask your dealer to recommend a qualified technician and an authorized repair service. Know how to disconnect the power to the appliance at the circuit breaker or fuse box in case of an emergency.

Remove the oven door from any unused oven if it is to be stored or discarded.

Do not touch a hot oven light bulb with a damp cloth. Doing so could cause the bulb to break. Handle halogen lights (if equipped) with paper towels or soft gloves. Disconnect the appliance or shut off the power to the appliance before removing and replacing the bulb.

### WARNING



California Residents: for cancer and reproductive harm information, visit [www.P65Warnings.ca.gov](http://www.P65Warnings.ca.gov)

Save these instructions for future reference

## COOKING RECOMMENDATIONS

### Bakeware

The material of bakeware affects how evenly and quickly it transfers heat from the pan to the food.

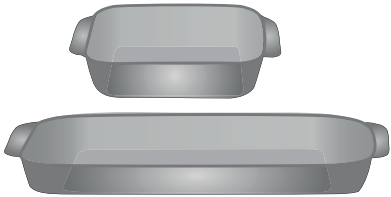
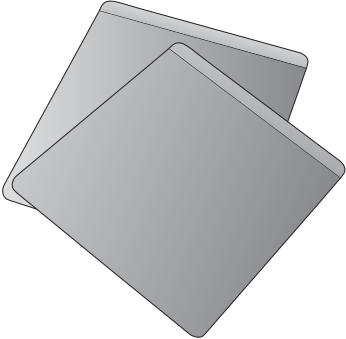
Material	Attributes	Recommendation
Shiny metal bakeware 	Shiny, aluminum, and non-coated bakeware is the best for even heating. It is suitable for all baked goods.	Recommended cooking temperatures and times are based on shiny metal bakeware.
Dark metal bakeware 	Dark bakeware cooks hotter than shiny bakeware.	Reduce the cooking temperature by 25° F (13-14° C) when using dark bakeware.
Glass bakeware 	Glass bakeware cooks hotter than shiny bakeware.  Glass is convenient, as the same piece of bakeware can be used for cooking, serving, and storing food.	Reduce the cooking temperature by 25° F (13-14° C) when using glass bakeware.
Insulated bakeware 	Insulated bakeware cooks cooler than shiny bakeware.  Insulated bakeware is designed for baking in gas ovens.	Increase the cooking temperature by 25° F (13-14° C) when using insulated bakeware.

# COOKING RECOMMENDATIONS

## Cooking Conditions

Conditions in your kitchen can affect the performance of your appliance when cooking food.

Condition	Attributes	Recommendation
Aging cookware	As pans age and become discolored, cooking times may need to be reduced slightly.	If food is too dark or overcooked, use the minimum cook time in the recipe or packaging. If food is too light or undercooked, use the middle to maximum cook time in the recipe or packaging.
High altitude	Air is drier and air pressure is lower.  Water boils at a lower temperature, and liquids evaporate faster.  Foods may take longer to bake.  Doughs may rise faster.	Adjust cooking temperature, cooking time, or recipes as needed.  Increase amount of liquid in baking recipes. Increase cook time on cooktop. Cover dishes to reduce evaporation.  Increase bake time or oven temperature.  Reduce amount of baking soda or baking powder in recipe. Reduce rising time or punch down dough and allow it to rise twice.

## Cooking Results

Small adjustments may fix a problem with food not being as done as you like or more done than you like.

Result	Recommendation
Food too light	Use the middle to maximum cook time recommended on packaging or recipe.
Food too dark	Use the minimum cook time recommended on packaging or recipe.

## Cooking Tips

Use these additional tips to get the best results from your appliance.

Cooking	Tips
<b>Baking</b>	
Rack placement	Follow the instructions in <a href="#">“Oven Control Features”</a> on starting on <a href="#">page 20</a> . When using only one rack, place the rack so the food is in the center of the oven.
Preheat	Fully preheat the oven before baking items like cookies, cakes, biscuits and breads. Insert food immediately after the beep.
Checking food	Use the window and oven light when checking food. Opening the door may reduce baking performance.
Bake	Bake is the best function to use for baking on multiple racks.



## COOKING RECOMMENDATIONS

Cooking	Tips
Food placement	Allow at least 2 inches (5 cm) of space between bakeware for proper air circulation.
<b>Broiling / Roasting</b>	
Broiling pan	<p>For best results when broiling, use a broil pan with a broil pan insert designed to drain the fat from the food, help avoid spatter, and reduce smoking. The broiler pan will catch grease spills, and the insert helps prevent grease splatters.</p> <p>If a broiler pan and insert are not supplied, they may be purchased from <a href="http://www.frigidaire.com">www.frigidaire.com</a>.</p>
<b>Convection Cooking</b>	
Convection attributes	<p>Convection cooking uses a fan to circulate hot air around the oven and food. It browns food more evenly and reduces hot spots in the oven.</p> <p>Convection saves time when using multiple racks or cooking several food items at once.</p>
Convection bake	<p>Reduce cooking temperature by 25° F (13-14° C) from the recipe unless the recipe is written for convection baking.</p> <p>Preheat the oven for best results.</p>
Convection roast	<p>Convection roast is best for meats and does not require preheating for most meats and poultry.</p> <p>Reducing the cooking temperature for convection roast is not recommended. Carefully follow your recipe's temperature and time recommendations, adjusting the cooking time if the recipe does not specify convection roasting time.</p> <p>Since convection roast cooks faster, cook time may be reduced by 25% to 40% depending on food type. You can reduce cook times by 25% from the recommended time of your recipe, and check the food at this time. If needed, continue cooking until the desired doneness is obtained.</p> <p>Use a meat probe if available with your appliance. Meat probes are also available from most grocery and home goods stores.</p> <p>Arrange oven racks so large cuts of meat and poultry are on the lowest rack of the oven.</p> <p>Do not cover foods when dry roasting - covering will prevent the meat from browning properly.</p> <p>When cooking meats, use the broiler pan and insert or a roasting rack. The broiler pan will catch grease spills and the insert helps prevent grease splatters. If you do not have one of these accessories, they may be purchased from <a href="http://www.frigidaire.com">www.frigidaire.com</a>.</p>

# BEFORE SETTING SURFACE CONTROLS

## Using Proper Cookware

The size and type of cookware used will influence the heat setting needed for best cooking results. Be sure to follow the recommendations for using proper cookware as illustrated in Figure 1 and Figure 2.



Check for flatness by rotating a ruler across the bottom of the cookware (see Figure 1). Cookware should have flat bottoms that make good contact with the entire surface heating element (see Figure 2).

Figure 1: Testing cookware

## Cookware Material Types

The cookware material determines how evenly and quickly heat is transferred from the surface element to the pan bottom. The most popular materials available are:

- **Aluminum** - Excellent heat conductor. Some types of food will cause it to darken (Anodized aluminum cookware resists staining and pitting). If aluminum pans slide across the ceramic cooktop, they may leave metal marks which will resemble scratches. Remove these marks immediately.
- **Copper** - Excellent heat conductor but discolors easily (see Aluminum).
- **Stainless** - Slow heat conductor with uneven cooking results. Is durable, easy to clean and resists staining.
- **Cast Iron** - A slow heat conductor that will retain heat very well. Cooks evenly once cooking temperature is reached. If cast iron pans slide across the ceramic cooktop, they may leave metal marks which will resemble scratches. Remove these marks immediately.
- **Porcelain-enamel on metal** - Heating characteristics will vary depending on base material. Porcelain-enamel coating must be smooth to avoid scratching ceramic cooktops.
- **Glass** - Slow heat conductor. Not recommended for ceramic cooktop surfaces because it may scratch the glass.

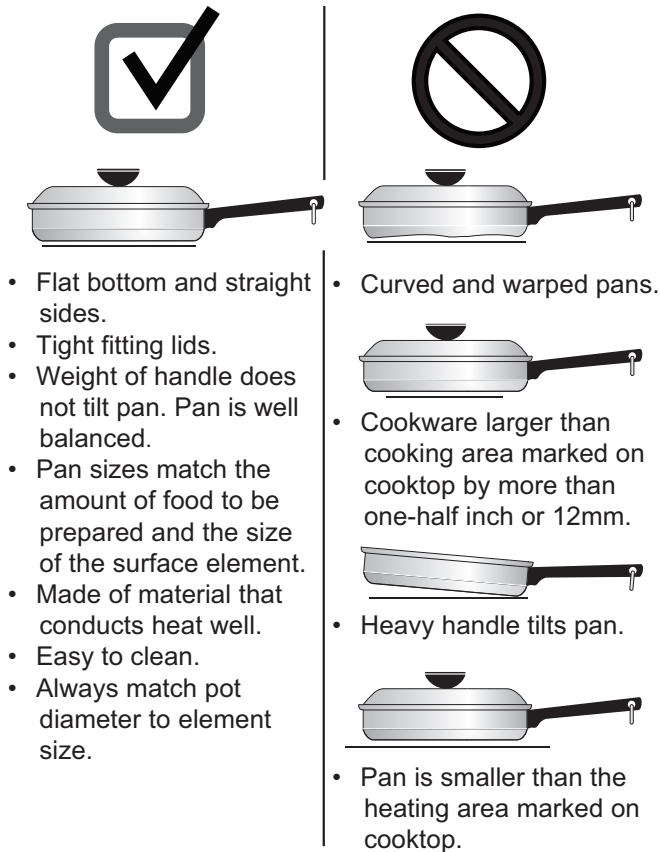

Figure 2: Proper cookware

## IMPORTANT

Do not place empty aluminum, glass, or porcelain-enamel coated cookware on the ceramic cooktop. The melting point of cookware made with these materials may be reached quickly, especially if left empty, and they may bond to the ceramic cooktop. If the cookware melts it will damage the cooktop. Follow all the cookware manufacturer's recommendations for use and care of cookware.

## BEFORE SETTING SURFACE CONTROLS

### About the Ceramic Glass Cooktop

The ceramic glass cooktop has heating elements below a smooth glass surface. The designs on the ceramic cooktop outline the areas of the surface elements underneath. Always match the pan size with the diameter of the element outline on the cooktop. Only flat-bottomed cookware should be used.

Prior to using your cooktop for the first time, apply a ceramic cooktop cleaning cream (available in most hardware, grocery and department stores) to the ceramic surface. Clean and buff with a clean paper towel. This will make cleaning easier when soiled from cooking. Cooktop cleaning creams leave a protective finish on the glass to help prevent scratches and abrasions.

The type and size of cookware, the number of surface elements in use, and their settings will all affect the amount of heat that will spread to areas beyond the surface elements. **The areas surrounding the elements may become hot enough to cause burns.**

### ➔ IMPORTANT

- The cooktop should not be used as a cutting board or work surface.
- Dropping heavy or hard objects on the cooktop may crack it.
- Placing food directly on the smoothtop surface (without a cooking utensil) is not recommended, as difficult cleaning will result, and foods may smoke and cause potential fire hazard.
- Always lift cookware before moving on the ceramic glass cooktop. Any cookware that has a rough or dirty bottom can scratch the ceramic cooktop. Always start with clean cookware.

### 📌 NOTE

White glass cooktops only - Due to the high intensity of heat generated by the surface elements, the glass surface may discolor when the element is turned off. This is normal and the glass will return to its original white color after it has completely cooled down.

### About the Radiant Surface Elements

The element temperature rises gradually and evenly. As the temperature rises, the element will glow red. To maintain the selected setting the element will cycle on and off. The heating element retains enough heat to provide a uniform and consistent heat during the off cycle.

For efficient cooking, turn the element off several minutes before cooking is complete. This will allow residual heat to complete the cooking process.

### ⚠ CAUTION

- Surface elements may appear to have cooled after they have been turned off. **The element surface may still be hot**, and burns may occur if the element or surrounding area is touched before it has cooled to a safe temperature.
- **Do not** place flammable items such as plastic salt and pepper shakers, spoon holders, or plastic wrapping on top of the range when it is in use. These items could melt or ignite. Potholders, towels, or wooden spoons could catch fire if placed too close to the surface elements.
- **Do not** allow aluminum foil, or any material that can melt, to make contact with the ceramic glass cooktop. If these items melt on the cooktop, they will damage the ceramic cooktop.

### 📌 NOTE

Radiant elements have a limiter that allows the element to cycle on and off, even at the HI setting. This helps to prevent damage to the ceramic smooth top. Cycling at the HI setting is normal and can occur if the cookware is too small for the radiant element or if the cookware bottom is not flat.

Be sure to read detailed instructions for ceramic glass cooktop cleaning in the Care and Cleaning section and Before You Call checklist section of this *Use and Care Guide*.

# BEFORE SETTING SURFACE CONTROLS

## Element On and Hot Surface Indicator Lights

The ELEMENT ON indicator light will turn on when one or more elements are turned on.

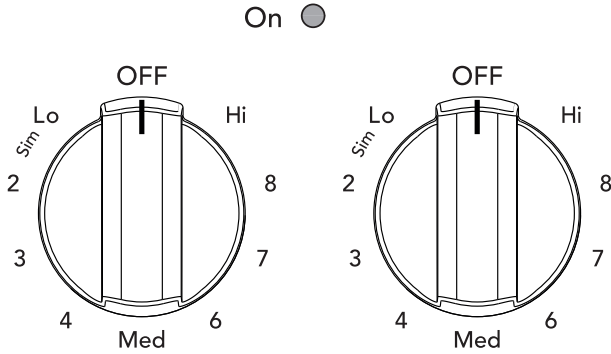

**Figure 3: On indicator light**

A quick glance at this indicator light when cooking is finished is an easy check to be sure all surface elements are turned off.

The HOT SURFACE indicator light will turn on when the burner is hot enough to cause burns and will remain on after the burner is turned off until the surface has cooled to a safe temperature.

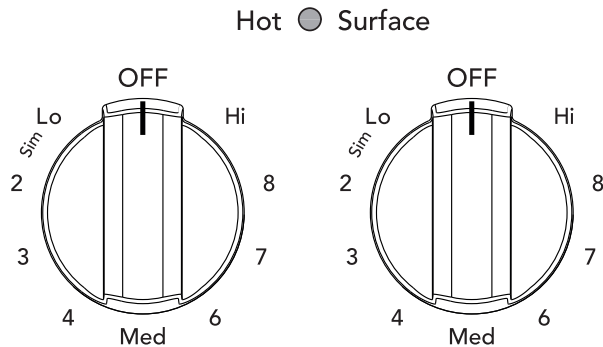
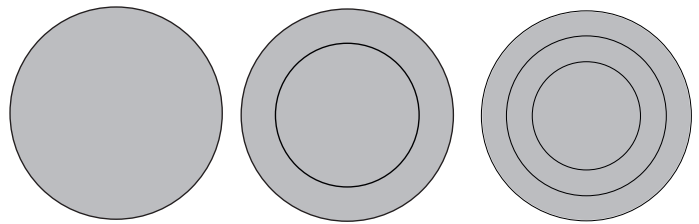

**Figure 4: Hot surface indicator light**

## Types of ceramic cooktop elements

The circles on the ceramic glass cooktop outline the size and type of element underneath. The elements on your cooktop depend on the model.

- A single radiant element has one circle.
- A dual radiant element (some models) has two circles. The dual radiant element may be set using only the smaller inner element or both inner and outer elements may be set to heat together for a larger surface.
- A triple radiant element (some models) has three circles. The element may be set using only the inner element, the inner and middle elements, or all three elements together.
- Dual and triple elements allow more flexibility with the size of cookware.



**Figure 5: Single, double, and triple elements**

- A warm zone element (some models) has one small circle. It is used to keep food warm after cooking. The keep warm element is not designed to cook food.

## SETTING SURFACE CONTROLS

### Single radiant surface elements

To operate the single radiant element:

1. Place correctly sized cookware on surface element.
2. Push in and turn the surface control knob in either direction (Figure 6) to the desired setting (refer to the “Suggested radiant surface element settings” in Table 1).
3. When cooking is complete, turn the radiant surface element OFF before removing the cookware.

Start most cooking operations on a higher setting and then turn to a lower setting to finish cooking. The surface control knobs do not have to be set exactly on a particular spot. Use the graphics provided as a guide and adjust the control knob as needed (see Figure 6).

A glowing red surface heating area extending beyond the bottom edge of the cookware indicates the cookware is too small for the surface heating area.

### Suggested radiant surface element settings

The suggested settings found in Table 1 below are based on cooking with medium-weight aluminum pans with lids. Settings may vary when using other types of pans.

Settings	Type of Cooktop
High (HI - 9)	Start most foods, bring water to a boil, pan broiling
Medium High (7 - 8)	Continue a rapid boil, fry, deep fat fry
Medium (5 - 6)	Maintain a slow boil, thicken sauces and gravies or steam vegetables
Medium Low (2 - 4)	Keep foods cooking, poach, stew
Low (1)	Low temperature cooking
Low (LO)	Keep warm, melt

Table 1: Suggested radiant surface element settings

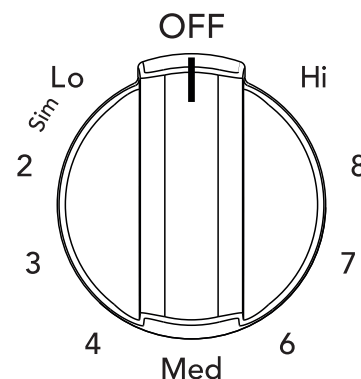

Figure 6: Single element knob

### CAUTION

- Radiant surface elements may appear to have cooled after they have been turned off. **The glass surface may still be hot** and burns may occur if the glass surface is touched before it has cooled sufficiently.
- **Do not** place flammable items such as plastic salt and pepper shakers, spoon holders, or plastic wrappings on top of the range when it is in use. These items could melt or ignite. Potholders, towels, or wooden spoons could catch fire if placed too close to the surface elements.

### NOTE

- The size and type of utensil used, and the amount and type of food being cooked will influence the setting needed for best cooking results.
- The Element ON indicator lights will turn on when one or more elements are turned ON. A quick glance at these indicator lights when finished cooking is an easy check to be sure all control knobs are turned OFF. The Hot Surface indicator light will remain on AFTER the control knob is turned to the “OFF” position and will stay on until the heating surface area has cooled sufficiently.

### IMPORTANT

Do not allow aluminum foil or ANY material that can melt to make contact with the ceramic glass cooktop. If these items melt on the cooktop, they will damage the ceramic cooktop.

## SETTING SURFACE CONTROLS

### Dual radiant surface elements

Symbols on the backguard will help choose which portion of the dual radiant element to set. The ○ symbol indicates a setting for the inner element only. The ⊙ symbol indicates a setting for both inner and outer elements.

#### To operate a dual radiant element:

1. Place correctly sized cookware on the surface element.
2. Push in and turn the surface control knob clockwise to begin heating both the inner and outer elements. If only the inner element is needed for smaller cookware, push in and turn the knob counter-clockwise (see Figure 7).
3. When cooking is complete, turn the knob to OFF before removing the cookware.

Start most cooking operations on a higher setting and then turn to a lower setting to finish cooking. The surface control knobs do not have to be set exactly on a particular mark. Use the marks as a guide and adjust the control knob as needed.

A glowing red surface heating area extending beyond the bottom edge of the cookware indicates the cookware is too small for the surface heating area.

You may switch from either single or dual element setting at any time during cooking. See “Suggested radiant surface element settings” on page 15.

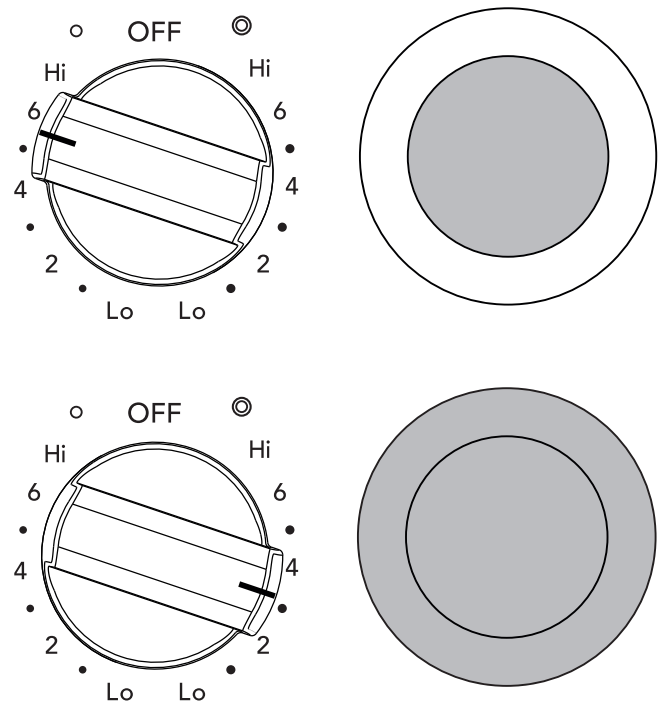

Figure 7: Dual element knob settings

### CAUTION

- Radiant surface elements may appear to have cooled after they have been turned off. **The glass surface may still be hot** and burns may occur if the glass surface is touched before it has cooled sufficiently.
- **Do not** place flammable items such as plastic salt and pepper shakers, spoon holders or plastic wrappings on top of the range when it is in use. These items could melt or ignite. Potholders, towels or wooden spoons could catch fire if placed too close to the surface elements.

### IMPORTANT

Do not allow aluminum foil or ANY material that can melt to make contact with the ceramic glass cooktop. If these items melt on the cooktop, they will damage the ceramic cooktop.

### NOTE

- The size and type of utensil used and the amount and type of food being cooked will influence the setting needed for best cooking results.
- The Element ON indicator lights will turn on when one or more elements are turned ON. A quick glance at these indicator lights when finished cooking is an easy check to be sure all control knobs are turned OFF. The Hot Surface indicator light will remain on AFTER the control knob is turned to the “OFF” position and will stay on until the heating surface area has cooled sufficiently.



## SETTING SURFACE CONTROLS

### Triple Surface Radiant Element

Symbols around the knob are used to indicate which element of the triple radiant element will heat. The ○ symbol indicates that only the inner element will heat. The ◎ symbol indicates that the inner and middle elements will heat. The ⊙ symbol indicates that the inner, middle and outer elements will heat (Figure 8). You may switch the element setting at any time during cooking.

#### To Operate the Triple Surface Element

1. Place correctly sized cookware on the triple surface element.
2. Push in and turn the control knob to the inner element symbol for smaller cookware or to the inner and middle element symbol for average cookware or to the inner, middle, and outer element symbol for large cookware (Figure 8). Turn the knob to adjust the setting if needed.
3. When cooking has completed, turn the surface control knob to OFF before removing the cookware.

Start most cooking operations on a higher setting and then turn to a lower setting to finish cooking.

A glowing red surface heating area extending beyond the bottom edge of the cookware indicates the cookware is too small for the surface heating area.

You may switch to the single, dual, or triple element setting at any time during cooking. See “Suggested radiant surface element settings” on page 15.

#### CAUTION

- Radiant surface elements may appear to have cooled after they have been turned off. **The glass surface may still be hot** and burns may occur if the glass surface is touched before it has cooled sufficiently.
- **Do not** place flammable items such as plastic salt and pepper shakers, spoon holders, or plastic wrappings on top of the range when it is in use. These items could melt or ignite. Potholders, towels, or wooden spoons could catch fire if placed too close to the surface elements.

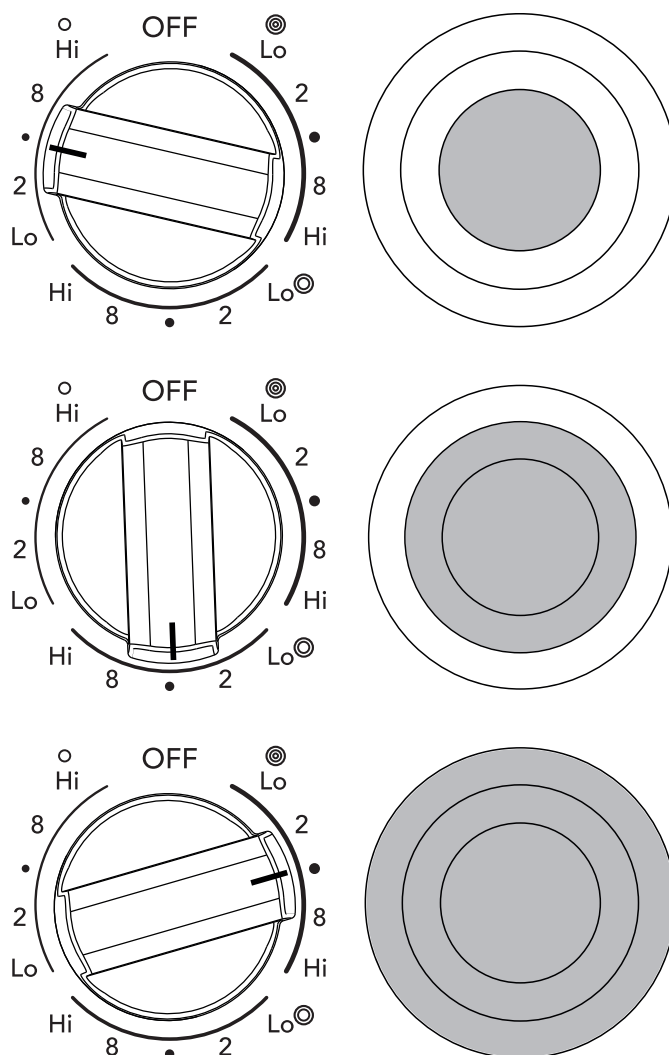

Figure 8: Triple element knob settings

#### IMPORTANT

Do not allow aluminum foil or ANY material that can melt to make contact with the ceramic glass cooktop. If these items melt on the cooktop, they will damage the ceramic cooktop.

## SETTING SURFACE CONTROLS

### Warm Zone

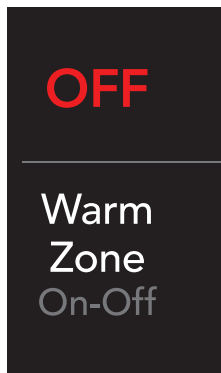

Use the Warm Zone feature to keep cooked foods hot. The Warm Zone key is located on the oven control panel just below the **OFF** key. It controls the Warm Zone (the middle element on the back row of the radiant cooktop).

**Always start with hot food.** It is not recommended to heat cold food on the warm zone. All food placed on the warm zone should be covered with a lid to maintain quality. For best results, when warming pastries or breads, the cover should have an opening to allow moisture to escape.

**Do not use plastic wrap to cover food. Plastic may melt onto the surface and be very difficult to clean.**

Use only dishware, utensils, and cookware recommended for oven and cooktop use on the warm zone.

#### Setting the Warm Zone control:

1. Press the **Warm Zone** key. **WARM ZONE** will appear in the display. The temperature is preset to the optimal heating level for keeping cooked foods ready for serving.
2. When ready to serve, press the **Warm Zone** key again. **WARM ZONE** will disappear from the display

### CAUTION

- Unlike the surface elements, the warm zone will not glow red when it is hot. To avoid burns always use potholders or oven mitts when removing food from the cooktop, including the warm zone, as cookware and plates will be hot.
- Radiant surface elements may appear to have cooled after they have been turned off. The glass surface may still be hot and burns may occur if the glass surface is touched before it has cooled sufficiently.
- **Do not** place flammable items such as plastic salt and pepper shakers, spoon holders, or plastic wrappings on the cooktop when it is in use. These items could melt or ignite. Potholders, towels, or wooden spoons could catch fire if placed too close to the surface elements.

### WARNING

Food poisoning hazard. Do not let food sit for more than one hour before or after cooking. Doing so can result in food poisoning or sickness.

### IMPORTANT

Do not allow aluminum foil or ANY material that can melt to make contact with the ceramic glass cooktop. If these items melt on the cooktop, they will damage the ceramic cooktop.

### Home Canning

Be sure to read and observe all the following points when home canning with your appliance. Check with the USDA (United States Department of Agriculture) Web site and be sure to read all the information they have available as well as follow their recommendations for home canning procedures.

- Use only a completely flat bottom canner with no ridges that radiate from the bottom center when home canning. Heat is spread more evenly when the bottom surface is flat. Use a straight-edge to check canner bottom.
- Make sure the diameter of the canner does not exceed 1 inch beyond the surface element markings or burner.
- It is recommended to use smaller diameter canners on electric coil and ceramic glass cooktops and to center canners on the burner grates.
- Start with hot tap water to bring water to boil more quickly.
- Use the highest heat setting when first bringing the water to a boil. Once boiling is achieved, reduce heat to lowest possible setting to maintain that boil.
- Use tested recipes and follow instructions carefully. Check with your local Cooperative Agricultural Extension Service or a manufacturer of glass jars for the latest canning information.
- It is best to can small amounts and light loads.
- Do not leave water bath or pressure canners on high heat for an extended amount of time.

## BEFORE SETTING OVEN CONTROLS

### Oven Vent Location

The oven is vented as shown below. When the oven is on, warm air is released through the vent. This venting is necessary for proper air circulation in the oven and good baking results. Do not block oven vent. Never close off the openings with aluminium foil or any other material. Steam or moisture may appear near the oven vent. This is normal.

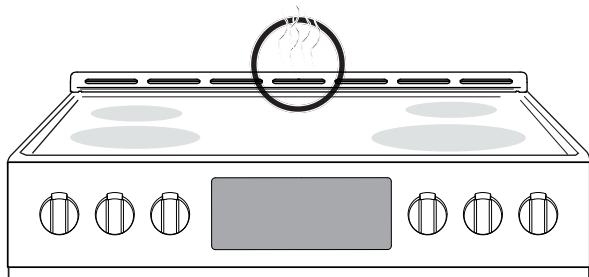

Figure 9: Oven vent

### **!** WARNING

Protective Liners — **Do not** use aluminum foil or any other material or liners to line the oven bottom, walls, racks or any other part of the range. Doing so will alter the heat distribution, produce poor baking results, and possibly cause permanent damage to the oven interior. Improper installation of these liners may result in risk of electric shock or fire. During self clean, temperatures in the oven will be hot enough to melt foil.

### **!** CAUTION

- Always use pot holders or oven mitts when using the oven. When cooking, the oven interior, oven exterior, oven racks, and cooktop will become very hot which can cause burns.
- Remove all oven racks before starting a self clean cycle. If oven racks are left inside the oven during a cleaning cycle, the slide ability of the oven racks may be damaged and all of the oven racks will lose their shiny finish.
- To prevent possible damage to the oven, do not attempt to close the oven door until all the oven racks are fully positioned back inside the oven cavity.

### Type of oven racks

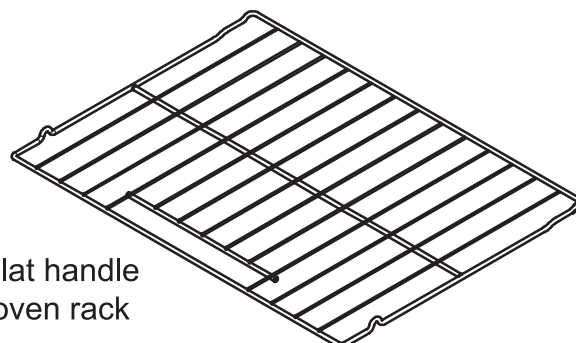

Flat handle  
oven rack

Figure 10: Oven rack types

- **Flat oven racks** are used for most cooking needs and may be placed in most oven rack positions.

### Removing, replacing, and arranging oven racks

Always arrange the oven racks when the oven is cool.

**To remove** - Pull the oven rack straight forward until it reaches the stop position. Lift up front of oven rack slightly and slide out.

**To replace** - Place the oven rack on the rack guides on both sides of oven walls. Tilt the front of oven rack upward slightly and slide the oven rack back into place. Be sure oven racks are level before using.

## SETTING OVEN CONTROLS

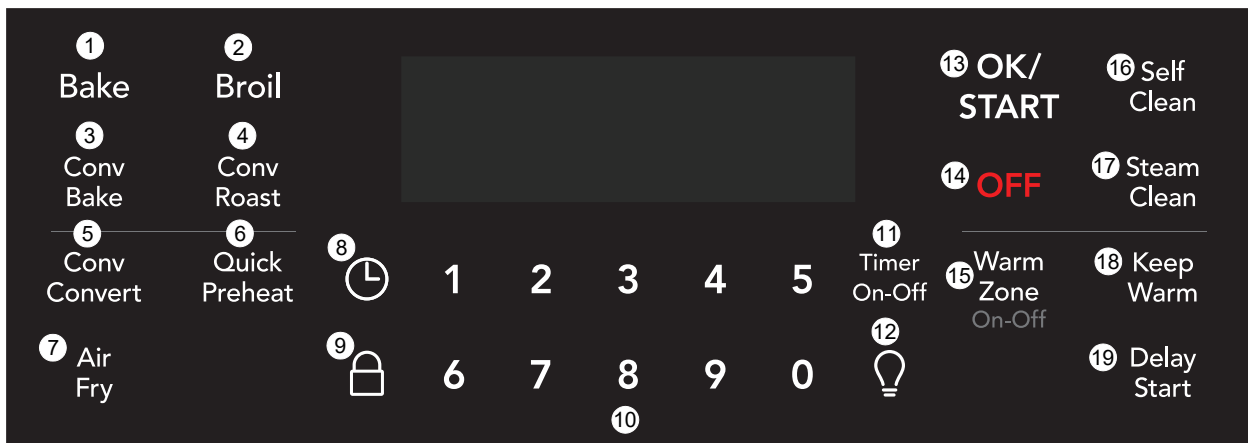

### Oven Control Features

- Bake** - Use to enter normal baking temperatures for recipes that call for regular baking.
- Broil** - Selects normal broil function for direct heat cooking.
- Conv Bake** - Circulates the oven heat evenly and continuously for faster cooking of some foods.
- Conv Roast** - Uses a convection fan to gently brown meats and poultry and seal in the juices.
- Conv Convert** - Converts standard bake temperatures to convection temperature in convection bake.
- Quick Preheat** - Best used for single rack baking with packaged and convenience foods.
- Air Fry** - Uses hot air for crispy great tasting results without all the oil.
- Set Clock** - Use to set the time of day
- Oven Lock** - Use to lock out oven controls and oven door.
- 0 through 9 keys** - Use to set temperature and time
- Timer On-Off** - Use to set or cancel the minute timer. The minute timer does not start or stop any cooking function.
- Oven Light** - Use to turn on internal light. Will turn on when the oven door is opened.
- OK/START** - Use to set cooking functions and when setting the clock.
- OFF** - Use to turn off all cooking functions.
- Warm Zone** - Uses radiant heat to keep cooked foods at serving temperature.

- Self Clean** - Use to set self-clean cycle between 2 and 4hrs.
- Steam Clean** - Use as a time saving method for cleaning light soils.
- Keep Warm** - Use to keep cooked foods at serving temperature.
- Delay Start** - Add to Quick Preheat, Bake, Conv Bake, Conv Roast, and Self Clean to program a Delay Start.

Feature	Mode	Min.Temp. /Time	Max Temp. /Time
Quick Preheat		170°F (77°C)	550°F (288°C)
Bake		170°F (77°C)	550°F (288°C)
Broil		400°F (205°C)	550°F (288°C)
Conv Bake		170°F (77°C)	550°F (288°C)
Conv Roast		170°F (77°C)	550°F (288°C)
Air Fry		170°F (77°C)	550°F (288°C)
Keep Warm		170°F (77°C)	until canceled
Timer		0:01 Min.	11:59 Hr./Min.
Clock Time	12 Hr.	1:00 Hr./Min.	12:59 Hr./Min.
	24 Hr.	0:00 Min	23:59 Hr./Min.
Delay Start	12 Hr.	1:00 Hr./Min.	12:59 Hr./Min.
	24 Hr.	0:00 Min	23:59 Hr./Min
Steam Clean		30 mins	
Self Clean		2 hours	4 hours

**Note:** An entry acceptance tone (1beep) will sound each time a key is touched (the oven lock key is delayed 3 seconds). An entry error tone (3 short beeps) will sound if the entry of the temperature or time is below the minimum or above the maximum settings for the feature.

## SETTING OVEN CONTROLS

### Setting the Clock

When the appliance is first powered up, **12:00** will flash in the display (Figure 11). The time of day must first be set before operating the oven.



Figure 11: 12:00 in display before setting the clock

#### To Set Clock to 1:30:

1. Press .
2. Enter **1 3 0** using numeric keys.
3. Press **OK/START**.

#### Important note:

The clock cannot be changed when a Self Clean, Delay Start, or cooking feature is active.

### Setting Timer

The minute timer allows you to track your cooking times without interfering with the cooking process. The timer may be set from a minimum time of 1 minute to a maximum of 11 hours and 59 minutes.

#### To set timer for 5 minutes:

1. Press **Timer On-Off**.
2. Enter **5** using numeric keypad.
3. Press **Timer On-Off** to start the timer. When set time ends, **END** will show in the display and the control will sound a beep three times every 30 seconds until **Timer On-Off** key is pressed.

To cancel the timer when active, press **Timer On-Off** again.

#### Important note:

- The timer does not start or stop the cooking process. It serves as an extra minute timer that will beep when the set time has run out. The timer may be used alone or while using any of the other oven functions.
- When timer is set for more than 1 hour it will display hours and minutes until 1 hour remains. When less than 1 hour remains, the display counts down in minutes and seconds. With less than 1 minute remaining, only seconds will display.
- If the timer is active during a cooking process, the timer will show in the display. To view the status of any other active oven function, press the key of the cooking function once and it will appear in the display for a few seconds.

### Setting 12 Hour or 24 Hour display mode

The clock display mode allows you to select 12 hr or 24 hr modes. The factory pre-set clock display mode is 12 hours.

#### To set 12 hr or 24 hr display mode:

1. Press and hold  for 6 seconds.
2. Press **Self Clean** to toggle between **12 Hr day** or **24 Hr day** display modes (Figure 12).
3. Press **OK/START** to accept the choice.



Figure 12: 12 Hr dAy and 24 Hr dAy settings

### Changing between continuous bake setting or 12 hour energy saving

The oven control has a factory preset built-in 12 Hour Energy Saving feature that will turn off the oven if the oven is left on for more than 12 hours. The control may be programmed to override this feature to bake continuously.

#### To change between continuous bake or 12 hour energy saving feature:

1. Press and hold **Timer On-Off** for 6 seconds
2. Press **Self Clean** to toggle between **12 Hour OFF** or **Stay On** feature (Figure 13).
3. Press **OK/START** to accept choice.



Figure 13: 12 hr energy saving (L) continuous setting (R)

## SETTING OVEN CONTROLS

### Changing temperature display from Fahrenheit to Celsius

The electronic oven control is set to display °F when shipped from the factory. The display may be changed to show either °F or °C oven temperatures.

#### To change temperature display mode from °F to °C or from °C to °F:

1. Press and hold **Broil** for 6 seconds.
2. Once **F (or C)** appears in the display, press **Self Clean** to toggle between Fahrenheit and Celsius temperature display modes (Figure 14).
3. Press **OK/START** to accept the choice.

#### Important note:

The oven temperature display cannot be changed during the cooking process or if a delay start has been set or self clean is active.



Figure 14: Display showing Fahrenheit and Celsius

### Setting Silent or Audible Control mode

Silent mode allows the oven control to operate without audible tones. The control may be programmed for silent operation and later reset to operate with all the normal audible tones.

#### To set for silent or audible mode:

1. Press and hold **Delay Start** for 6 seconds.
2. Press the **Self Clean** key to toggle between **bEEP On** or **bEEP OFF** (Figure 15).
3. Press **OK/START** to accept the choice.



Figure 15: Display showing audible and silent operation

### Setting Oven Lockout

The control can be programmed to lock the oven door and lockout the oven control keys.

#### To activate the oven lockout features:

1. Be sure oven door is completely closed.
2. Press and hold the lock key for 3 seconds. The motor driven door latch mechanism will begin locking the oven door automatically. Do not open the oven door. Allow about 15 seconds for the oven door to completely lock. Once door is locked, the word **DOOR** with a lock icon will appear in the display.

#### To cancel the oven lockout feature:

1. Press and hold the lock key for 3 seconds. The motor door latch will begin unlocking the oven door automatically. Do not open the oven door. Allow about 15 seconds for the oven door to completely unlock.
2. When the word **DOOR** with a lock icon no longer displays, the oven door may be opened, and the oven control keypad will be available for use.

**Important:** If a control key is pressed when oven lockout is active, the control will triple beep indicating the key action is not available when the oven lockout feature is active.

### Operating Oven Lights



The interior oven lights will automatically turn on when the oven door is opened. Oven lights will not operate during a self clean cycle. For best baking results, do not leave oven light on while cooking.

Press  to turn the interior oven lights on and off whenever the oven door is closed.

The interior oven lights are located on the side wall of the oven interior and are covered with a glass shield. The glass shield protects the bulb from high temperatures and should always be in place whenever the oven is in use.

To replace the interior oven light, see [“Replacing the Oven Light”](#)



## SETTING OVEN CONTROLS

### Quick Preheat

Quick Preheat is available for single rack baking with packaged and convenience foods and can be programmed for temperatures between 170°F and 550°F. Follow the recipe or package directions for food preparation time and temperature. When quick preheat is complete, a reminder tone will sound and food should be placed in the oven.

### CAUTION

Always use pot holders or oven mitts when using the oven. When cooking the oven interior, oven racks, and cooktop will become very hot which can cause burns.

During quick preheat function, the bake burner will cycle on and off. The convection fan will turn on and stay on until quick preheat is canceled and turn on and off as needed during cooking. Depending on your preference for doneness cooking times may vary. Watch food closely.

### Important:

- Always place food in center of the oven on rack position 4 (Figure 17). Place the food as shown in Figure 16.
- For best results when baking batter and dough-based items such as cookies and pastries, use convection bake function and place food in oven when the reminder tone sounds signaling the oven is fully preheated.
- Food may need to be removed early and should be checked at minimum recommended bake time.

### To set the preheat temperature for 350°F:

1. Arrange the interior oven racks.
2. Press **Quick Preheat**. 350 will appear in the display.
3. Press **OK/START**.
4. 350 and PREHEAT will be displayed while the oven is preheating.
5. Press **OFF** when baking is complete or to cancel the preheat feature.

To change preheat temperature while oven is preheating (ex: changing from 350°F to 425°F):

1. Press **Quick Preheat**. 350 will appear in the display.
2. Enter the new preheat temperature. Press **4 2 5**.
3. Press **OK/START**. 425 will show in the display.
4. When baking is complete, press **OFF**.

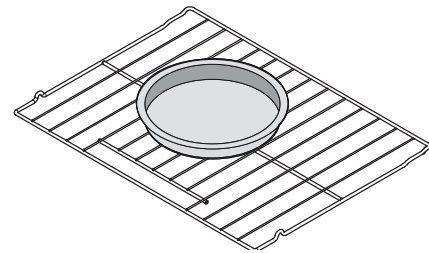

Figure 16: Single rack baking for convenience foods

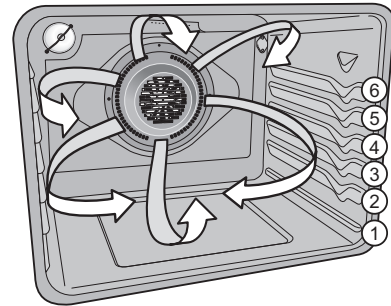

Figure 17: Oven rack positions

**Note:** The oven is equipped with cooling fans that turn on when the oven reaches a high enough temperature and will remain on until the oven cavity has cooled. Cooling fans may remain on for a time after the oven function has been canceled. This is normal.

## SETTING OVEN CONTROLS

### Setting Bake

Bake cooks with heat that rises from the oven bottom. The heat and air circulate naturally in the oven. A reminder tone will sound indicating when the set bake temperature is reached and to place the food in the oven. The convection fans will turn on in preheat and then cycle on and off as needed during baking.

Bake may be set for any oven temperature between 170°F (77°C) to 550°F (288°C).

### CAUTION

Always use pot holders or oven mitts when using the oven. When cooking the oven interior, oven racks, and cooktop will become very hot which can cause burns.

### Baking tips

- Fully preheat the oven before baking items like cookies, cakes, biscuits and breads.
- Use the convection bake function for best results when baking cookies on multiple racks.
- Bake is the best function to use for baking cakes.
- For best results when baking layer cakes using two oven racks, place racks in positions 3 and 5 and place pans as shown in [Figure 19](#).
- When using any single rack for baking cookies, cakes, biscuits, or muffins use rack position 3.
- Allow at least 2 inches (5 cm) of space between bakeware for proper air circulation.
- Dark or dull bakeware absorbs more heat than shiny bakeware, resulting in dark or overbrowned foods. It may be necessary to reduce oven temperature or cook time to prevent overbrowning of some foods.
- Dark pans are recommended for pies; shiny pans are recommended for cakes, cookies, and muffins.
- Do not open oven door often. Opening the door will reduce the temperature in the oven and may increase cook time.

To set Bake for (default) oven temperature of 350°F:

1. Press **Bake**.
2. **350°** will appear in the display.
3. Press **OK/START**.

To cancel Bake at any time, press **OFF**.

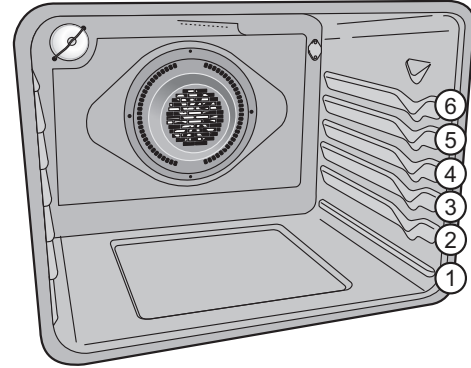

Figure 18: Rack positions

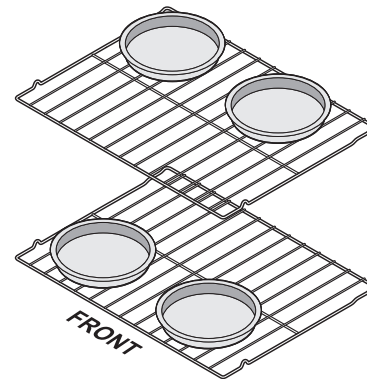

Figure 19: Pan placement

**Important:** The oven will bake no longer than 12 hours. If you wish to bake for a longer period, see [“Changing between continuous bake setting or 12 hour energy saving”](#) on [page 21](#) for detailed information.

## SETTING OVEN CONTROLS

### Convection Bake

Convection Bake uses a fan to circulate the oven's heat uniformly around the oven. This improved heat distribution allows for even cooking and browning results. Heated air flows around the food from all sides.

Convection bake may be set for any oven temperature between 170°F (77°C) and 550°F (288°C).

Benefits of convection cooking include:

- Multiple rack baking.
- Foods may cook faster, saving time and energy.

### Baking tips

- Fully preheat the oven before baking items like cookies, cakes, biscuits and breads.
- When baking cakes using two oven racks place bakeware in positions 3 and 5 and place bakeware as shown in [Figure 21](#).
- Allow at least 2 inches (5 cm) of space between bakeware to allow for proper air circulation.
- When using any single rack for baking cookies, cakes, biscuits or muffins, use rack position 3.
- Cookies and biscuits should be baked on pans with no sides or low sides to allow the heated air to circulate around the food.
- Unless the recipe is written for convection cooking, use **Conv Convert** to reduce oven temperature from the recipe's recommended oven temperature.
- Dark or dull bakeware absorbs more heat than shiny bakeware, resulting in dark or overbrowned foods. It may be necessary to reduce oven temperature or cook time to prevent overbrowning of some foods.
- Dark pans are recommended for pies; shiny pans are recommended for cakes, cookies, and muffins.
- Do not open oven door often. Opening the door will reduce the temperature in the oven and may increase cook time.

To set convection bake with a default oven set temperature of 350°F:

1. Press **Conv Bake**.
2. **Conv Bake** and 350° will appear in the display.
3. Press **OK/START**. The convection fan will turn on and stay on during the cooking process.
4. To cancel convection bake at any time, press **OFF**.

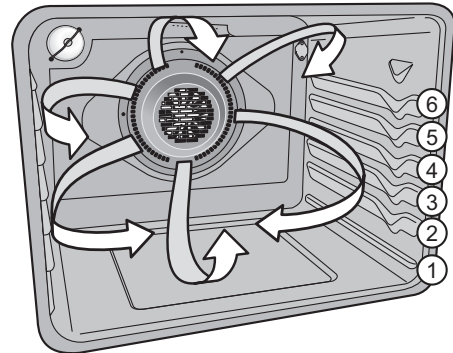

Figure 20: Rack positions

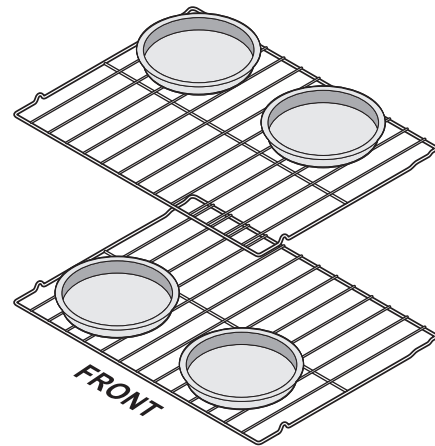

Figure 21: Pan placement for convection baking

### CAUTION

Always use pot holders or oven mitts when using the oven. When cooking the oven interior, oven racks, and cooktop will become very hot which can cause burns.

## SETTING OVEN CONTROLS

### Setting Convection Convert

Pressing the **Convection Convert** key automatically converts the cooking temperature entered for any standard baking recipe to the lower temperature required for convection baking.

**To set the oven for convection bake with a standard baking recipe temperature of 400°F:**

1. Arrange interior oven racks.
2. Press **Conv Bake**.
3. Press **4 0 0**.
4. Press **Conv Convert**.
5. Press **OK/START**.
6. Place food in the oven.

#### Important note:

- Convection convert may only be used with the Convection Bake function.
- When using convection convert, bake time reductions may vary depending on the oven set temperature.
- If the oven door is opened when any convection function is active, the convection fan will stop rotating until the oven door is closed.
- Do not open the oven door often. Opening the door will reduce the temperature in the oven and may increase the cooking time necessary for best results.

### CAUTION

Always use pot holders or oven mitts when using the oven. When cooking the oven interior, oven racks, and cooktop will become very hot which can cause burns.

### Setting Delay Start

Delay Start sets a delayed starting time to oven cooking or cleaning functions. Prior to setting a delay start, be sure the time of day is set correctly. Delay Start must be set before starting the cooking function.

### WARNING

**Food Poisoning Hazard.** Do not let food sit for more than one hour before or after cooking. Doing so can result in food poisoning or sickness. Foods that can easily spoil such as milk, eggs, fish, meat or poultry, should be chilled in the refrigerator first. Even when chilled, they should not stand in the oven for more than 1 hour before cooking begins, and should be removed promptly when finished cooking.

**To program oven for a delay start beginning at 5:30, and for baking at 375°F:**

1. Press **Bake**. Enter **3 7 5** using numeric keypad.
2. Press **Delay Start**.
3. Enter **5 3 0** using numeric keypad.
4. Press **OK/START** to accept.
5. The oven will turn on when the delay start time (5:30) is reached.

#### Important note:

Delay Start may be set using a 24 hr clock. To set clock for 24 Hr operation, See "[Setting 12 Hour or 24 Hour display mode](#)" on [page 21](#) for more information. The Delay Start feature may be used with Convection Bake, Convection Roast, Convection Convert, Bake, Broil and Self Clean functions.

## SETTING OVEN CONTROLS

### Setting Broil

Use the broil function to cook foods that require direct exposure to radiant heat for optimum browning results. Broiling may produce smoke. If smoke is excessive, place food further away from the flames. Broil may be set with Delay Start.

**Broil** is preset to 550°F and may be set to any temperature between 400°F (205°C) and 550°F (288°C).

#### **! WARNING**

Should an oven fire occur, leave the oven door closed and turn off the oven. If the fire continues, use a fire extinguisher. Do not put water or flour on the fire. Flour may be explosive and water can cause a grease fire to spread and cause personal injury.

#### **! CAUTION**

Always use pot holders or oven mitts when using the oven. When cooking, the oven interior, oven racks, and cooktop will become very hot which can cause burns.

**Important:** Broiler pans and inserts allow the grease to drain away from the high heat of the broiler. Do not use the pan without the insert. Do not cover the insert with foil – the exposed grease could ignite.

**Important: OPEN DOOR BROIL SHUTOFF:** If the oven door is left open during Broil for more than 3 minutes an alarm will sound to notify the user to close the oven door. If the door is not closed the oven will turn off within 30 seconds of the open door alarm.

**To set broil with the default broil oven temperature of 550°F:**

1. Arrange the oven racks when cool. For optimum browning results, preheat oven for 2 minutes before adding food.
2. Press **Broil**. Broil with oven door closed.
3. Position bakeware in oven.
4. Press **OK/START**. To adjust the broil temperature, press **Broil** again and then enter the new temperature using the number keys. Press **OK/START**.
5. Broil on one side until food is browned; turn and broil other side until done to your satisfaction.
6. When finished broiling, press **OFF**.

To cancel broil at any time, press **OFF**.

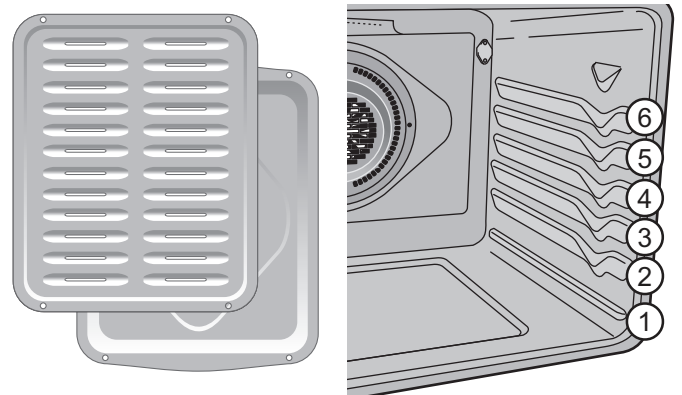

**Figure 22:** Broil pan with insert(L) Rack positions (R)

**Note:** If a broiler pan and insert are not supplied with this appliance they may be purchased from [www.frigidaire.com](http://www.frigidaire.com).

## SETTING OVEN CONTROLS

### Important notes:

- Always arrange oven racks when the oven is cool.
- Broil with oven door closed. If broiling with door open, an alarm will sound alerting you to close the door. If left open, the Broil function will be canceled.
- For best results when broiling, use a broil pan with broil pan insert designed to drain the fat from the food and help avoid spatter and reduce smoking.
- When broiling, always pull the oven rack out to the stop position before turning or removing food.
- If a broiler pan and insert are not supplied with this appliance they may be purchased from [www.frigidaire.com](http://www.frigidaire.com).

**Table 2:** Broil Suggestions

Food	Rack Position	Temperature	Cook time (minutes)		Internal Temperature	Doneness
			1st side	2nd side		
Steak 1" thick	6th**	550°F (288°C)	5	4	140°F (60°C)	Rare*
Steak 1" thick	5th or 6th**	550°F (288°C)	6	5	145°F (63°C)	Medium
Steak 1" thick	5th or 6th**	550°F (288°C)	7	6	170°F (77°C)	Well
Pork Chops 3/4" thick	5th	550°F (288°C)	12	10	170°F (77°C)	Well
Chicken bone-in	4th	450°F (232°C)	20	10	170°F (77°C)	Well
Chicken boneless	5th	450°F (232°C)	8	6	170°F (77°C)	Well
Fish	5th	550°F (288°C)	as directed		170°F (77°C)	Well
Shrimp	4th	550°F (288°C)	as directed		170°F (77°C)	Well
Hamburger 1" thick	4th**	550°F (288°C)	6	5	145°F (63°C)	Medium
Hamburger 1" thick	4th	550°F (288°C)	7	6	170°F (77°C)	Well

\* The U.S. Department of Agriculture states, "Rare fresh beef is popular, but you should know that cooking it to only 140°F (60°C) means some food poisoning organisms may survive." (Source: Safe Food Book, Your Kitchen Guide) The lowest temperature recommended by the USDA is 145°F (63°C) for medium rare fresh beef. For well done 170°F (77°C).

NOTE: Broiling is direct heat cooking and will produce some smoke. If smoke is excessive, place food further away from element. Always watch foods carefully to prevent burning.



## SETTING OVEN CONTROLS

### Convection Roast

Convection roast combines a cook cycle with the convection fan and element to rapidly roast meats and poultry. Heated air circulates around the meat from all sides, sealing in juices and flavors. Meats cooked with this feature are crispy and brown on the outside while staying moist inside.

Convection Roast may be set for any oven temperature between 170°F (77°C) and 550°F (288°C).

#### **! WARNING**

Should an oven fire occur, close the oven door and turn the oven off. If the fire continues, use a fire extinguisher. Do not put water or flour on fire. Flour may be explosive.

#### **! CAUTION**

Always use pot holders or oven mitts when using the oven. When cooking, the oven interior, oven racks, and cooktop will become very hot which can cause burns.

#### Benefits of Convection Roasting:

- Some foods cook up 25 to 30% faster, saving time and energy.
- No special pans or bakeware required.
- Preheating is not necessary for most meats and poultry.
- Be sure to carefully follow your recipe's temperature and time recommendations or refer to the convection roast chart for additional information.

#### To set Convection Roast:

1. Place the insert on broiler pan. Place meat (fat side up) on insert.
2. Make sure the insert is securely seated on top of the broiler pan. Do not use the broiler pan without the insert.
3. Place prepared food on oven rack and slide into oven.
4. Close the oven door.
5. Press **Conv Roast**.
6. Enter desired temperature using numeric keys.
7. Press **OK/START**.
8. When cooking is completed or to cancel convection roast press **OFF**.

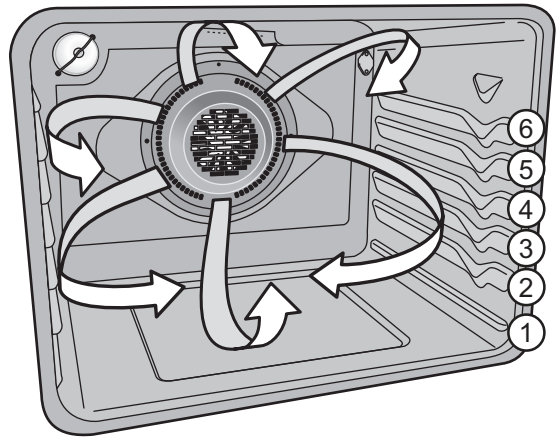

Figure 23: Convection roasting on lower oven racks

## SETTING OVEN CONTROLS

### Convection Roasting tips:

- Preheating for convection roast is not necessary for most meats and poultry.
- Arrange oven racks so large cuts of meat and poultry are on the lowest rack of the oven.
- Smaller roasts and poultry should be cooked using rack position 2 or 3.
- Since convection roast cooks faster, may be able to reduce cook times as much as 25% from the recommended time of your recipe (check the food at this time). Then if needed, increase cook time until the desired doneness is obtained.
- Carefully follow your recipe's temperature and time recommendations or refer to the convection roast recommendations for additional information.
- Do not cover foods when dry roasting - covering will prevent the meat from browning properly.
- When cooking meats use the broiler pan and insert. The broiler pan will catch grease spills and the insert helps prevent grease splatters.

**Table 3: Convection roasting temperature and time recommendations**

Meat		Weight	Oven Temp	Internal Temp	Mins per lb.
Beef	Standing rib roast*	4 to 6 lb.	350°F (177°C)	*160°F (71°C)	25-30
	Rib eye roast*	4 to 6 lb.	350°F (177°C)	*160°F (71°C)	25-30
	Tenderloin roast	2 to 3 lb.	400°F (204°C)	*160°F (71°C)	15-25
Poultry	Turkey whole**	12 to 16 lb.	325°F (163°C)	170°F (77°C)	8-10
	Turkey whole**	16 to 20 lb	325°F (163°C)	170°F (77°C)	10-15
	Turkey whole**	20 to 24 lb.	325°F (163°C)	170°F (77°C)	12-16
	Chicken	3 to 4 lb.	350°F-375°F (177°C-191°C)*	170°F (77°C)	12-16
Pork	Ham roast, fresh	4 to 6 lb.	325°F (163°C)	160°F (71°C)	30-40
	Shoulder blade roast	4 to 6 lb.	325°F (163°C)	160°F (71°C)	20-30
	Loin	3 to 4 lb.	325°F (163°C)	160°F (71°C)	20-25
	Pre-cooked ham	5 to 7 lb.	325°F (163°C)	160°F (71°C)	30-40

\* The U.S. Department of Agriculture states, "Rare fresh beef is popular, but you should know that cooking it to only 140°F (60°C) means some food poisoning organisms may survive." (Source: Safe Food Book, Your Kitchen Guide) The lowest temperature recommended by the USDA is 145°F (63°C) for medium rare fresh beef. For well done 170°F (77°C)\*\* Stuffed turkey requires additional roasting time. Shield legs and breast with foil to prevent over browning and drying of the skin.

## SETTING OVEN CONTROLS

### Air Fry

The Air Fry feature works best for single rack baking with packaged and convenience foods and can be programmed for temperatures between 170°F and 550°F.

Follow the recipe or package directions for food preparation quantity, time, and temperature.

Important:

- Air Fry is designed for baking on a single oven rack. Food should be arranged in single layers on a pan.
- When using Air Fry, use dark bakeware with low or no sides and place food on rack position 4 for best results.
- Leave oven light off when baking.
- Food may need to be removed early and should be checked at minimum recommended bake time. However, frozen dense foods and items with cook times less than 15 minutes may require additional time.

#### To set the Air Fry function:

1. Arrange food on rack as suggested.
2. Press **Air Fry**. Enter the suggested temperature for particular food.
3. Press **OK/START**.
4. When preheat tone sounds place The tray on rack position 4.

**Note:** Set the minute timer for the minimum suggested cook time listed in the table below and check food for desired doneness when timer ends.

5. When cooking is complete press **OFF**.

Frigidaire offers an optional Air Fry Tray specifically designed to deliver superior performance.

#### Some Benefits of the Optional Air Fry Tray:

- Tray optimized for oven space.
- Fits in the dishwasher for easy clean up.
- Higher yield than countertop models.
- Frees up countertop space.
- Compatible with convection ovens.
- The optional Air Fry tray may be purchased from [www.frigidaire.com](http://www.frigidaire.com).

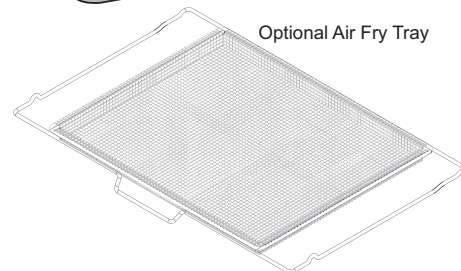
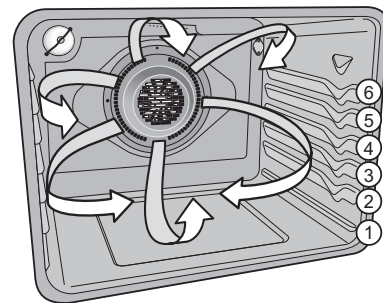

**Figure 24: Optional Frigidaire Air Fry Tray. Use rack position 4 with tray or dark pan with low or no sides for best results.**

**Table 4: Suggested Air Fry Settings**

Food	Quantity (oz.)	Temperature	Cook Time (mins)
Frozen Tater Tots	50 (Full Tray)	450 °F - 232°C	29-33
Frozen Golden Fries	43 (Full Tray)	425°F - 218°C	25-35
Frozen Sweet Potato Fries	43	425°F - 218°C	20-25
Frozen Chicken Nuggets	32	400°F - 205°C	11-13
Frozen Crispy Chicken Strips	25	400°F - 205°C	18-20
Frozen Hot Wings Bone-In	42	450 °F -232°C	18-25
Frozen Chicken Wings	42	375°F -190°C	60-65
Fresh Chicken Wings	42	425°F - 218°C	30-40
Homemade French Fries	24	425°F - 218°C	30-40

## SETTING OVEN CONTROLS

### Setting the Sabbath Feature (for use on the Jewish Sabbath and Holidays)



For further assistance, guidelines for proper usage, and a complete list of models with the Sabbath feature, please visit the web at [www.star-k.org](http://www.star-k.org).

This appliance provides special settings for use when observing the Jewish Sabbath/Holidays. Sabbath mode disables all audible tones or visual display changes on the oven control. **Bake** is the only cooking feature available while in the Sabbath mode. Oven controls are locked during Sabbath mode.

You must first set the Bake feature and temperature(s) needed for the oven and Delay Start options (if needed). Any settings made prior to setting the Sabbath mode will be visible in the displays.

The Sabbath mode will override the factory preset 12 hour energy saving mode, and the appliance will stay on until the cooking features are canceled. If any of the cooking features are canceled when the appliance is in the Sabbath mode, no audible or visual indicators will be available to verify the cancellation.

If the oven interior lights are needed, be sure to activate them prior to setting the Sabbath mode. Once the oven light is turned on and the Sabbath mode is active, the oven light will remain on until the Sabbath mode is turned off and the oven lights are turned off. The oven door will not activate the interior oven lights when the oven door is opened or closed.

It is recommended that any oven temperature modification made within an active Sabbath mode be followed with two presses of the **OK/START** key. This will insure the oven remains on even if an attempt is made to set the oven temperature outside of its temperature range.

If the oven temperature is set outside of the temperature range, the oven will default to the nearest available temperature. Try to set the desired oven temperature again..

### **WARNING**

Food poisoning hazard. Do not let food sit for more than one hour before or after cooking. Doing so can result in food poisoning or sickness. Foods that can easily spoil such as milk, eggs, fish, meat or poultry, should be chilled in the refrigerator first. Even when chilled, they should not stand in the oven for more than 1 hour before cooking begins, and should be removed promptly when finished cooking.

### Important:

- Do not attempt to activate any other oven function except Bake while the Sabbath feature is active. The following keys will function correctly when the Sabbath feature is active: 0-9 number keypad, Bake, OK/START, and OFF. All other keys should not be used once the Sabbath feature is active.
- You may change the oven temperature once baking has started. Press **Bake**, use the numeric keypad to enter the oven temperature change (170°F to 550°F), and press **OK/START** (for Jewish Holidays only).
- Remember that the oven control will no longer provide audible tones or display any further changes when the Sabbath feature is active.
- The oven will remain on until canceled and therefore may only be used once during the Sabbath/Jewish Holidays.
- If a delay start time longer than 11 hours and 59 minutes is desired, set the oven control for the 24 hour day display mode setting. See [“Setting 12 Hour or 24 Hour display mode”](#) on [page 21](#) for more information.

### To program oven to Bake with default oven temperature of 350°F and activate the Sabbath feature:

1. Be sure the clock is set with the correct time of day.
2. Arrange oven racks, place bakeware in oven, and close oven door. Press **Bake**.
3. Note: If Delay Start is desired enter the time at this point. See [“Setting Delay Start”](#) on [page 26](#) for detailed instructions.
4. Press **OK/START**.
5. Press and hold **Self Clean** and **Steam Clean** simultaneously for about 3 seconds to set the Sabbath feature. Once the feature is set, SAb will appear in the display indicating the oven is properly set for the Sabbath feature ([Figure 25](#)).



Figure 25: Oven set for Sabbath baking

## SETTING OVEN CONTROLS

**To turn the oven off and keep the Sabbath feature active:**

1. Press **OFF**.

**To turn off the Sabbath feature:**

Press and hold both **Self Clean** and **Steam Clean** simultaneously for at least 3 seconds to turn the Sabbath feature off. The control will provide an acceptance tone, and **SAb** will disappear from the display. The oven is no longer programmed for the Sabbath feature.

**What to do during a power failure or power interruption after the Sabbath feature was activated:**

Should you experience a power failure or interruption, the oven will shut-off. When power is restored the oven will not turn back on automatically. The oven will remember that it is set for the Sabbath, and the oven display will show the message **SF** for Sabbath failure (Figure 26).



**Figure 26:** Display showing Sabbath failure

The food may be safely removed from the oven while still in the Sabbath feature, however the oven cannot be turned back on until after the Sabbath/Holidays. After the Sabbath observance turn off the Sabbath feature.

Press and hold both **Self Clean** and **Steam Clean** keys for at least 3 seconds simultaneously to turn the Sabbath feature off. **SF** will disappear from the display, and the oven may be used with all normal functions.

### Keep Warm

**Keep Warm** should only be used with foods that are fully cooked and at serving temperatures. Keep Warm will keep foods warm and ready for serving at 170° F (77°C) until canceled.

**To set Keep Warm:**

1. If needed, arrange oven racks and place cooked food in oven.
2. Press **Keep Warm: WARM** will appear in the display. (If no other keys are touched within 25 seconds the request for Warm will clear.)
3. Press **OK/START**. **Warm** will automatically turn on and remain on until cancelled.

**Note:** To turn Warm off at any time, press **OFF**.

### **WARNING**

Food poisoning hazard. Do not let food sit for more than one hour before or after cooking. Doing so can result in food poisoning or sickness.

## SETTING OVEN CONTROLS

### Self Clean

A self cleaning oven cleans itself with high temperatures (well above normal cooking temperatures), which eliminate soils completely or reduces them to a fine powdered ash you can wipe away afterwards with a damp cloth. Self Clean can be programmed for times between 2 and 4 hours.

**Important:** Before starting self clean read all following caution and important statements before starting a self clean cycle.

### ⚠ CAUTION

- Do not leave small children unattended near appliance. During self clean cycle, the outside of the oven can become very hot and cause burns if touched.
- Do not line the oven walls, racks, oven bottom, or any part of the range with aluminum foil. This will cause permanent damage to the oven interior and destroy heat distribution, and will melt to the oven interior.
- Do not force the oven door open. This will damage the automatic door locking system. Use caution when opening the oven door after the self clean cycle ends. The oven may still be very hot and cause burns. To avoid possible burns, stand to side of oven when opening door to allow steam or hot air to escape.
- The health of some birds is extremely sensitive to fumes given off during the self clean cycle of any range. Move birds to a well ventilated room.

### Important notes:

- Completely remove all oven racks and any accessories from oven cavity to avoid damage to oven racks. If the oven racks are not removed they may discolor.
- Remove all items from the oven and cooktop including cookware, utensils, and any aluminum foil. Aluminum foil will not withstand high temperatures from a self clean cycle and will melt.
- Do not spray oven cleaners or oven protective coatings in or around any part of the oven interior. Clean any soil from the oven frame, the door liner outside the oven door gasket, and the small area at the front center of the oven bottom (Figure 27). These areas heat sufficiently to burn soil on. Clean using soap and water prior to starting Self Clean.

- Remove any excessive spills. Any spills on the oven bottom should be wiped up and removed before starting a self clean cycle. To clean use hot, soapy water and a cloth. Large spills can cause heavy smoke or fire when subjected to high temperatures.
- Do not allow food spills with high sugar or acid content (such as milk, tomatoes, sauerkraut, fruit juices, or pie fillings) to remain on the surface as they may leave a dull spot even after cleaning.
- Do not clean the oven door gasket. The woven material in the gasket is essential for a good seal. Care should be taken not to rub, damage, or remove the oven door gasket. Doing so could cause damage to the door gasket and compromise the performance of the oven.

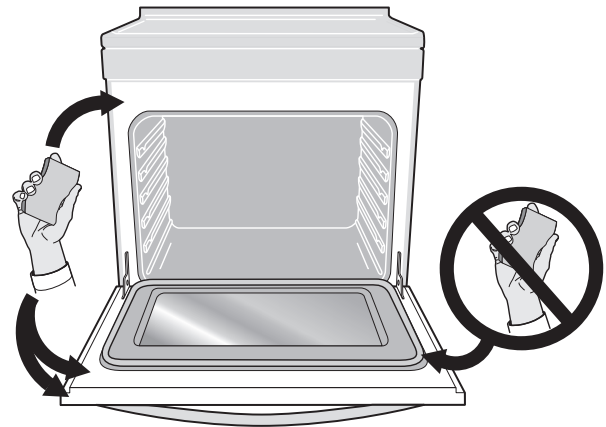

**Figure 27:** Areas to clean and areas to avoid (gasket)

- The kitchen area should be well ventilated using an open window, ventilation fan, or exhaust hood during the first self clean cycle. This will help eliminate the normal odors.
- Do not attempt to open the oven door when the OVEN LOCK indicator light is flashing. Allow about 15 seconds for the motorized door latch mechanism to completely lock or unlock the oven door.
- When the clean time finishes, the oven door will remain locked until the range has cooled sufficiently. In addition to the clean time that was programmed, you must allow about 1 additional hour for the oven to cool before you will be able to open the oven door.

## SETTING OVEN CONTROLS

### Setting Self Clean

#### To set self clean:

1. Be sure the oven is empty and all oven racks are removed. Remove all items from the oven. Be sure oven door is completely closed.
2. Press **Self Clean**. The default 3 hour clean time will appear in the display. You may accept the 3 hour clean time or choose a different clean duration by entering any time between 2 and 4 hours clean time by entering the time using the numeric keys.
3. Press **OK/START**. The warning to **REMOVE RACKS** will flash in the display to remind you that oven racks should be removed before a self clean.
4. Press **OK/START** to activate self clean.
5. The warning will end and the motor door lock will begin locking the oven door and Self Clean will start.

**Important:** Do not open the oven door while the lock motor is running or when any locking indicators or displays are showing. The oven door is completely locked in about 15 seconds. Once the oven door has locked, **CLEAN** will appear in the display indicating self clean has started.

Do not force the oven door open when self-clean is active. This can damage the automatic door-locking system. Use caution when opening the door after self-clean cycle is complete; the oven may still be very hot.

#### When self clean is finished:

1. **CLEAN** message will turn off, and **Hot** will appear in display window.
2. Once the oven has cooled down (about 1 hour) and **Hot** is no longer displayed, the oven door may be opened.
3. When the oven interior has completely cooled, wipe away any residue or powdered ash with a damp cloth or paper towel.

### CAUTION

To avoid possible burns, use care when opening the oven door after the self-cleaning cycle. Stand to the side of the oven when opening the door to allow hot steam and air to escape.

### Setting Delay Start Self Clean

#### To start a delay self clean with default clean time of 3 hours and a start time of 9:00 o'clock:

1. Be sure the clock is set with the correct time of day, the oven is empty, and all oven racks are removed. Be sure oven door is completely closed.
2. Press **Self Clean**
3. Press **Delay Start**.
4. Using numeric keypad, enter **9 0 0**.
5. Press **OK/START** to accept.

#### If it becomes necessary to stop self clean when active:

1. Press **OFF**.

**Important:** If self clean has heated the oven to a high temperature, allow enough time for the oven to cool. Before restarting self clean, be sure to read important notes below.

#### Important note:

- If your clock is set with the (default) 12 hr display mode, the delay start for a self clean can only be programmed to start up to 11 hours and 59 minutes after the time showing in the display (be sure to set the clock to current time before programming a Delay Start). To set a delay start Self Clean to begin 12 or more hours (maximum is 23 hours and 59 minutes) after the time of setting, be sure to first set the control in the 24 Hr display mode.
- If self clean was active and then interrupted by a power failure or canceled before the oven was thoroughly cleaned, it may be necessary to run another self clean cycle.
- If the oven temperature was high enough when self clean was interrupted the oven control may not allow another self clean cycle to be set for up to 4 hours.



## SETTING OVEN CONTROLS

### Steam Clean

The Steam Clean feature offers a chemical free and time saving method to assist in the routine cleaning of small and light soils. For heavier baked on soils use the Self Clean feature.

#### CAUTION

Do not add bleach, ammonia, oven cleaner, or any other abrasive household cleaners to the water used for Steam Clean. Before cleaning any part of the oven, be sure all controls are turned off and the oven is cool. The oven may be hot and can cause burns.

Be sure the oven is level and cool before starting Steam Clean. If the oven temperature is above room temperature a triple beep will be heard and the function will not start. Steam Clean produces best results when started with a cool oven

#### To set a Steam Clean cycle:

1. Remove all racks and oven accessories.
2. Scrape or wipe loose debris and grease from the oven bottom.
3. Pour 1 cup of tap water onto the oven bottom. (Figure 28) Close oven door.

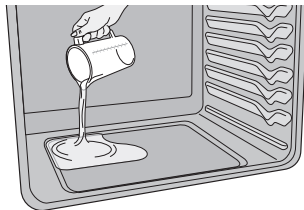

Figure 28: Add 1 cup of tap water

4. Press **Steam Clean**.
5. Press **OK/START**. **St Cn** will appear in the display.
6. To see the time remaining in the Steam Clean cycle press the Steam Clean key once. Do not open the door during this time. If door is open while in Steam Clean for more than 4 minutes an open door alarm will sound.
7. When the steam clean cycle is complete an alert will sound and the **END** message will show in the display. Press **OFF** to return to the clock.
8. Take care opening the door when the steam clean is finished. Stand to the side of the oven out of the way of escaping vapor.

9. Wipe oven cavity and bottom. Do not clean oven door gasket (Figure 29). Avoid leaning or resting on the oven door glass while cleaning cavity.
10. To cancel Steam Clean at any time press **OFF**.

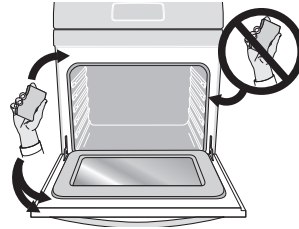

Figure 29: Clean around the oven door gasket

**Important:** Opening oven door during Steam Clean cycle prevents the water from reaching the temperature needed to clean. If the door is left open once Steam Clean starts, an alarm will sound alerting you to close the door.

- For best results, clean oven immediately after the cycle is complete. Steam clean works best for soils on the oven bottom.
- Place a paper towel or cloth in front of the oven to capture any water that may spill while wiping out.
- A non abrasive scouring pad, stainless steel sponge, plastic scraper, or eraser style cleaning pad (without cleaner) can be used for difficult soils. Moisten pads with water before use.
- Do not leave the residual water in the oven for any length of time.
- Some condensation or water vapor may appear close to the oven vent. This is normal. The oven gasket may become damp; do not wipe dry.
- Local water sources often contain minerals (hard water). If hard water deposits occur, wipe cavity with a 50/50 solution of water and vinegar or 50/50 solution of lemon juice and water.
- Steam clean cannot be programmed with a delay start.
- If Steam Clean results are not satisfactory, run a Self Clean. See “Self Clean” on page 34.

## SETTING OVEN CONTROLS

### Restoring Factory Default Settings

Your appliance was set with predetermined (default) oven control settings. Over time, users may have made changes to these settings. The following options may have been modified since the appliance was new:

- 12 or 24 hr display mode
- All Meat Probe settings
- Continuous bake or 12 hour energy savings mode
- Silent or audible control
- Oven temperature display (Fahrenheit or Celsius)
- Oven temperature adjustments (UPO)

### CAUTION

All of the above user settings will be restored to the factory default settings.

### To restore oven control to factory default settings:

1. Press and hold **7** on numeric keypad until acceptance tone sounds (about 6 seconds).
2. Press **OK/START**. The control has been reset with the default settings.

### Adjusting Oven Temperatures

Your appliance has been factory calibrated and tested to ensure accurate baking temperatures. For the first few uses, follow your recipe times and temperature recommendations carefully. If you think the oven is cooking too hot or too cool for your recipe times, you may adjust the control so the oven cooks hotter or cooler than the oven temperature displayed.

**Important:** Do not use oven thermometers such as those found in grocery stores to check the temperature settings inside your oven. These oven thermometers may vary as much as 20 to 40°F degrees from actual temperatures.

The oven temperature may be increased as much as +35°F (+19°C) or decreased -35°F (-19°C) from the factory calibrated settings.

### To increase or decrease the oven temperature by 20°F:

1. Press and hold **Bake** until the control produces an audible tone (about 6 seconds). The factory offset temperature of 0 (zero) should appear in the display.
2. Enter **2 0** using numeric keypad.
3. To offset the oven by -20°F, press **self clean** to toggle between + and -.
4. Press **OK/START** to accept change.

### Important note:

- Oven temperature adjustments will not change the Broil, Self Clean, or Keep Warm temperatures.
- The oven temperature adjustment may be made if your oven control is set to display temperatures in °C (Celsius). Minimum and maximum settings for Celsius range from plus (+)19°C to minus (-) 19°C.

## CARE AND CLEANING

Remove spills and any heavy soiling as soon as possible. Regular cleaning will reduce the difficulty of major cleaning later.

### CAUTION

- Before cleaning any part of the appliance, be sure all controls are turned off and the appliance is cool.
- If ammonia or appliance cleaners are used, they must be removed and the appliance must be thoroughly rinsed before operating. Follow manufacturer's instructions and provide adequate ventilation.

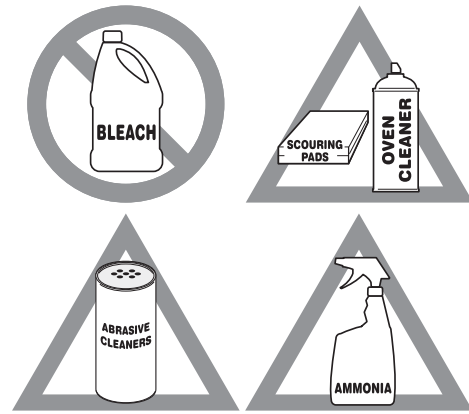

Figure 30: Use cleaners with caution

Surface or Area	Cleaning Recommendation
Aluminum and vinyl	Using a soft cloth, clean with mild dish detergent and water. Rinse with clean water, dry and polish with a soft, clean cloth.
Painted and plastic control knobs Painted body parts Painted decorative trims	Using a soft cloth, clean with mild dish detergent and water or a 50/50 solution of vinegar and water. Rinse with clean water, dry and polish with a soft, clean cloth. Glass cleaners may be used, but do not apply directly to surface; spray onto cloth and wipe.
Control panel	Using a soft cloth, clean with mild dish detergent and water or a 50/50 solution of vinegar and water. Do not spray liquids directly on the oven control and display area. Do not use large amounts of water on the control panel - excess water on the control area may cause damage to the appliance. Do not use other liquid cleaners, abrasive cleaners, scouring pads, or paper towels - they will damage the finish.
Control knobs	Using a soft cloth, clean with mild dish detergent and water or a 50/50 solution of vinegar and water. To remove control knobs: turn to the OFF position, grasp firmly, and pull off the shaft. To replace knobs after cleaning, line up the OFF markings and push the knobs into place.
Stainless Steel	Using a soft cloth, clean with mild dish detergent and water or a 50/50 solution of vinegar and water. Rinse with clean water, dry with a soft clean cloth. Do not use cleaners containing abrasives, chlorides, chlorine, or ammonia.
Smudge Proof™ Stainless Steel Black Stainless Steel	Using a soft cloth, clean with mild dish detergent and water or a 50/50 solution of vinegar and water. Rinse with clean water, dry with a soft clean cloth. Do not use appliance cleaner, stainless steel cleaner, or cleaner containing abrasives, chlorides, chlorine, or ammonia. These cleaners may damage the finish.

## CARE AND CLEANING

Porcelain-enameled broiler pan and insert	Rinse with clean water and a damp cloth. Scrub gently with a soapy, non-abrasive scouring pad to remove most spots. Rinse with a 50/50 solution of clean water and ammonia. If necessary, cover difficult spots with an ammonia-soaked paper towel for 30 to 40 minutes. Rinse and wipe dry with a clean cloth. Remove all cleaners or future heating could damage the porcelain. Do not allow food spills with a high sugar or acid content (milk, tomatoes, sauerkraut, fruit juices or pie filling) to remain on porcelain surfaces. These spills may cause a dull spot even after cleaning.
Porcelain door liner	
Porcelain body parts	
Self-cleaning oven interior	Before setting a self-clean cycle, clean soils from the oven frame, areas outside the oven door gasket, and the small area at the front center of the oven bottom. See <a href="#">“Self Clean”</a> on <a href="#">page 34</a> .
Oven door	Use mild dish detergent and water or a 50/50 solution of vinegar and water to clean the top, sides, and front of the oven door. Rinse well. Glass cleaner may be used on the outside glass of the door. Ceramic smoothtop cleaner or polish may be used on the interior door glass. Do not immerse the door in water. Do not spray or allow water or cleaners to enter the door vents. Do not use oven cleaners, cleaning powders, or any harsh abrasive cleaning materials on the outside of the oven door.  Do not clean the oven door gasket. The oven door gasket is made of a woven material which is essential for a good seal. Do not rub, damage, or remove this gasket.
Ceramic cooktop	See <a href="#">“Cooktop Maintenance”</a> on <a href="#">page 40</a> .

## CARE AND CLEANING

### Cooktop Maintenance

Consistent and proper cleaning is essential to maintaining your ceramic glass cooktop.

Prior to using your cooktop for the first time, apply a ceramic cooktop cleaning cream (available in most hardware, grocery, and department stores) to the ceramic surface. Clean and buff with a clean paper towel. This will make cleaning easier when soiled from cooking. Cooktop cleaning creams leave a protective finish on the glass to help prevent scratches and abrasions.

Sliding aluminum, cast iron, or copper bottomed pans on the cooktop can cause metal markings on the cooktop surface. These marks should be removed immediately after the cooktop has cooled using cooktop cleaning cream. Metal marks can become permanent if not removed prior to future use.

Cookware (cast iron, metal, ceramic, or glass) with rough bottoms can mark or scratch the cooktop surface.

#### Do not:

- Slide anything metal or glass across the cooktop.
- Use cookware with dirt or dirt build up on the bottom; always use clean cookware.
- Use your cooktop as a cutting board or work surface in the kitchen.
- Cook foods directly on the cooktop surface without a pan.
- Drop heavy or hard objects on the ceramic glass cooktop; they may cause it to crack.

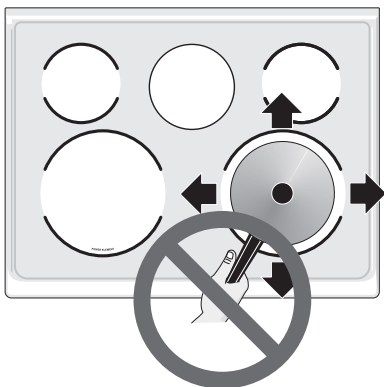

Figure 31: Cooktop care

### Cooktop Cleaning

#### ! WARNING

Do not use a cooktop cleaner on a hot cooktop. The fumes can be hazardous to your health, and can chemically damage the ceramic-glass surface.

#### ! CAUTION

Before cleaning the cooktop, be sure the controls are turned to OFF and the cooktop is cool. The glass surface could be hot and burns may occur if the glass surface is touched before it has cooled sufficiently.

#### For light to moderate soil:

For light to moderate soil: Apply a few drops of cooktop cleaning cream directly to the cooktop. Use a clean paper towel to clean the entire cooktop surface. Make sure the cooktop is cleaned thoroughly, leaving no residue. Do not use the towel you use to clean the cooktop for any other purpose.

#### For heavy, burned on soil:

Apply a few drops of cooktop cleaning cream directly to the soiled area. Rub the soiled area using a non-abrasive cleaning tool, applying pressure as needed. Do not use the pad you use to clean the cooktop for any other purpose.

If soils remain, carefully scrape soils with a metal razor blade scraper, holding scraper at a 30 degree angle to the surface. Remove loosened soils with cooktop cleaning cream and buff the surface clean.

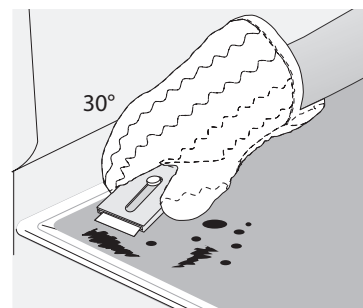

Figure 32: Cooktop cleaning

## CARE AND CLEANING

### Cooktop Maintenance (cont'd)

#### → IMPORTANT

Damage to the ceramic glass cooktop may occur if you use an abrasive type cleaning pad. Only use cleaning products that have been specifically designed for ceramic glass cooktops.

### Aluminum Foil and Utensils

#### ! WARNING

Never cover any slots, holes, or passages in the oven bottom or cover an entire oven rack with materials such as aluminum foil. Aluminum foil linings may trap heat, causing a fire hazard.

#### ! WARNING

Protective Liners — Do not use aluminum foil to line the oven bottom. Improper installation of these liners may result in risk of electric shock or fire.

#### → IMPORTANT

- Aluminum foil - Use of aluminum foil on a hot cooktop can damage the cooktop. Do not use thin aluminum cooking utensils or allow aluminum foil to touch the surface elements under any circumstances.
- Aluminum utensils - The melting point of aluminum is much lower than that of other metals. Care must be taken when aluminum pots or pans are used on the cooktop. If aluminum pans are allowed to boil dry when using the cooktop, not only will the utensil be damaged or destroyed, but it may fuse to, break, or mark the ceramic glass surface, permanently damaging the cooktop surface.

### Remove and replace storage drawer

Use the storage drawer for storing cooking utensils. The drawer can be removed to facilitate cleaning under the range. Use care when handling the drawer.

#### To remove the drawer:

1. Open the drawer to the fully opened position.
2. Locate the latches on both sides of the drawer.
3. Pull up on the left glide latch and push down on the right glide latch.
4. Pull the drawer away from the range.

#### To replace the drawer:

1. Align the glide latches on both sides of the drawer with the slots on the drawer.
2. Push the drawer back into the range.

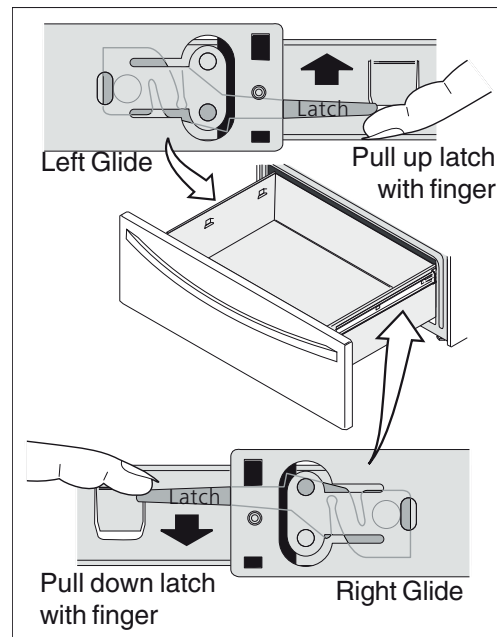

## CARE AND CLEANING

### Removing and Replacing the Oven Door

#### CAUTION

The door is heavy. For safe, temporary storage, lay the door flat with the inside of the door facing down.

#### To remove the oven door:

1. Open oven door completely, horizontal with floor.
2. Pull up the lock located on each hinge support toward front of the oven until the lock stops. You may have to apply a little upward pressure on the lock to pull it up (Figure 34 and Figure 35).
3. Grasp the door by the sides, and close the door until the door frame makes contact with the unlocked hinges.
4. Pull the bottom of the door toward you while rotating the top of the door toward the appliance to completely disengage the hinge levers (Figure 36).

#### To Replace Oven Door:

1. Firmly grasp both sides of oven door along the door sides. Do not use the oven door handle (Figure 36).
2. Hold the oven door at the same angle as the removal position. Carefully insert the hinge levers into the oven frame until you feel the hinge levers are seated into the hinge notches. The hinge arms must be fully seated into the hinge notches before the oven door can be fully opened. (Figure 36).
3. Fully open the oven door, horizontal with floor (Figure 33).
4. Push the door hinge locks up toward and into the oven frame on both left and right oven door hinges to the locked position (Figure 41).
5. Close the oven door.

#### IMPORTANT

Special door care instructions - Most oven doors contain glass that can break. Do not hit the glass with pots, pans, or any other object. Scratching, hitting, jarring, or stressing the glass may weaken its structure, causing an increased risk of breakage at a later time. Do not close the oven door until all of the oven racks are fully in place.

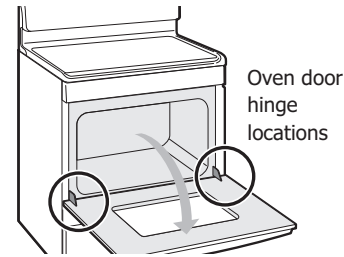

Figure 33: Door hinge location

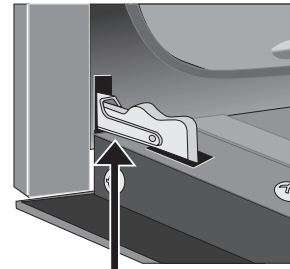

Figure 34: Door hinge locks

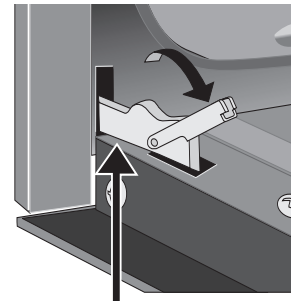

Figure 35: Unlocking door hinge

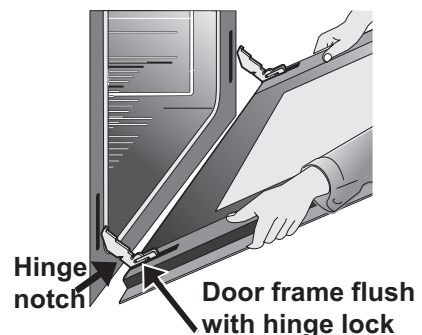

Figure 36: Replacement and location of hinge arm and roller pin



### Replacing the Oven Light

#### CAUTION

Be sure the oven is unplugged and all parts are cool before replacing the oven light.

#### Replacing the oven interior light bulb:

The interior oven light is located at the rear of the oven cavity and covered with a glass shield. The glass shield must be in place whenever the oven is in use (Figure 37).

1. Turn electrical power off at the main source or unplug the appliance.
2. Remove the interior oven light shield after removing the wire holder by carefully moving the wire to the side of the glass shield. The tension from the wire holds the glass shield in place.
3. Pull the shield straight out. Do not twist or turn.
4. Replace the bulb with a new appliance bulb.
5. Replace the glass oven light shield. Replace wire holder.
6. Turn the power back on again at the main source (or plug the appliance back in).
7. Be sure to reset the time of day on the clock.

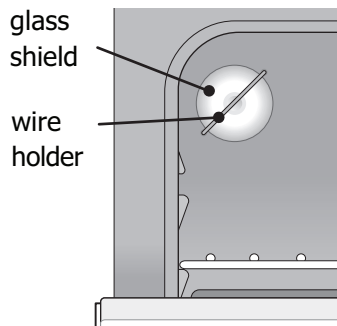







Figure 37: Oven light protected by glass shield

# BEFORE YOU CALL

## Oven Baking

For best cooking results, preheat the oven before baking cookies, breads, cakes, pies, pastries, etc. There is no need to preheat the oven for roasting meat or baking casseroles. The cooking times and temperatures needed to bake a product may vary slightly from your previously owned appliance.

### Baking Problems and Solutions

Baking Problems	Causes	Corrections
<p>Cookies and biscuits burn on the bottom.</p> 	<ul style="list-style-type: none"> <li>• Cookies and biscuits put into oven before oven is preheated.</li> <li>• Oven rack is overcrowded.</li> <li>• Dark pan absorbs heat too fast.</li> </ul>	<ul style="list-style-type: none"> <li>• Allow oven to preheat to desired temperature before placing food in oven.</li> <li>• Choose pan sizes that will permit at least 2" of air space (5.1 cm) on all sides when placed in the oven.</li> <li>• Use a medium weight shiny baking sheet.</li> </ul>
<p>Cakes too dark on top or bottom</p> 	<ul style="list-style-type: none"> <li>• Cakes put in oven before oven is preheated.</li> <li>• Rack position too high or too low.</li> <li>• Oven too hot.</li> </ul>	<ul style="list-style-type: none"> <li>• Allow oven to preheat to the selected temperature before placing food in the oven.</li> <li>• Use proper rack position for baking needs.</li> <li>• Set oven temperature 25°F (13°C) lower than recommended.</li> </ul>
<p>Cakes not done in center</p> 	<ul style="list-style-type: none"> <li>• Oven too hot.</li> <li>• Incorrect pan size.</li> <li>• Pan not centered in oven.</li> <li>• Glass cookware slow heat conductor.</li> </ul>	<ul style="list-style-type: none"> <li>• Set oven temperature 25°F (13°C) lower than recommended.</li> <li>• Use pan size suggested in recipe.</li> <li>• Use proper rack position and place pan so there are at least 2" (5.1 cm) of space on all sides of pan.</li> <li>• Reduce temperature and increase cook time or use shiny bakeware.</li> </ul>
<p>Cakes not level.</p> 	<ul style="list-style-type: none"> <li>• Oven not level.</li> <li>• Pan too close to oven wall or rack overcrowded.</li> <li>• Pan warped.</li> <li>• Oven light left on while baking.</li> </ul>	<ul style="list-style-type: none"> <li>• Place a marked glass measuring cup filled with water on the center of the oven rack. If the water level is uneven, refer to the installation instructions for leveling the oven.</li> <li>• Use proper rack position and place pan so there are at least 2" (5.1 cm) of space on all sides of pan.</li> <li>• Do not use pans that are dented or warped.</li> <li>• Do not leave the oven light on while baking.</li> </ul>
<p>Foods not done when cooking time is over.</p> 	<ul style="list-style-type: none"> <li>• Oven too cool.</li> <li>• Oven overcrowded.</li> <li>• Oven door opened too frequently.</li> </ul>	<ul style="list-style-type: none"> <li>• Set oven temperature 25°F (13°C) higher than suggested and bake for the recommended time.</li> <li>• Be sure to remove all pans from the oven except the ones to be used for baking.</li> <li>• Open oven door only after the shortest recommended baking time.</li> </ul>

## Solutions to Common Problems:

Before you call for service, review the following list. It may save you time and expense. Possible solutions are provided with the problem listed.

Problem	Cause / Solution
Entire appliance does not operate.	Appliance not connected. Make sure power cord is plugged properly into outlet. Check your fuse box or breaker box to make sure the circuit is active.  Electrical power outage. Check house lights to be sure. Call your local electric company for service outage information.
<b>Oven Problems</b>	
Poor baking results.	Many factors affect baking results. Use proper oven rack position. Center food in the oven and space pans to allow air to circulate. Preheat the oven to the set temperature before placing food in the oven. Try adjusting the recipe's recommended temperature or baking time. See <a href="#">"Adjusting Oven Temperatures"</a> on <a href="#">page 37</a> if you feel the oven is too hot or too cool.
Flames inside oven or smoking from oven vent.	Excessive spills in oven. Grease or food spilled onto the oven bottom or oven cavity. Wipe up excessive spills before starting the oven. If flames or excessive smoke are present when using broil, see <a href="#">"Setting Broil"</a> on <a href="#">page 27</a> .
Oven smokes excessively when broiling.	Incorrect setting. Follow the <a href="#">"Setting Broil"</a> instructions on <a href="#">page 27</a> .  Meat too close to the broil element or burner. Reposition the broil pan to provide proper clearance between the meat and broil element or burner. Remove excess fat from meat. Cut remaining fatty edges to prevent curling, but do not cut into lean.  Grease build up on oven surfaces. Regular cleaning is necessary when broiling frequently. Grease or food splatters will cause excessive smoking.
F11 Error	If you get an F11 error, turn the power to the range off and wait 30 second to turn it back on. Make sure the oven control panel is clean. Spills, grease, lots of steam when opening the oven door, and residues from certain cleaners may cause this error. Clean the control with some warm, soapy water and dry with a clean cloth. If the error persists, call our help line.
Oven control panel beeps and displays any F or E code error.	Oven control has detected a fault or error condition. To clear the error, press the <b>OFF</b> key on the control panel. Once the error code is cleared, try the bake or broil function. If the F or E code error repeats, turn off the power to appliance, wait 5 minutes, and then repower the appliance. Set the clock with correct time of day. Try the bake or broil function again. If the fault recurs, press the <b>OFF</b> key to clear.
Oven portion of appliance does not operate.	The time of day is not set. The clock must be set in order to operate the oven. See <a href="#">"Setting the Clock"</a> on <a href="#">page 21</a> .  Be sure the oven controls are set properly for the desired function. See <a href="#">"Oven Control Features"</a> starting on <a href="#">page 20</a> and review instructions for the desired cooking function in this manual or see <a href="#">"Entire appliance does not operate."</a> in this checklist.
Fan noise before cooking, or after cooking is finished and the appliance is off.	Some models are equipped with fans that run during and after normal operation to cool and ventilate the appliance. On some models, the fan will begin to run as soon as a function is activated. It is normal for these fans to continue to run during any kind of operation. They may also run for an extended period of time, even when the oven is off. Loud noises from the fans are not normal and require service.

## BEFORE YOU CALL

Problem	Cause / Solution
<b>Cooktop Problems</b>	
Surface element is too hot or not hot enough.	Incorrect surface control setting. Adjust power level setting.
Surface element does not heat or does not heat evenly.	Be sure the correct surface control knob is turned on for the element needed. Cookware is light weight or warped. Use only flat, evenly balanced, medium or heavy-weight cookware. Flat pans heat better than warped pans. Cookware materials and weight of the material affect heating. Heavy and medium-weight pans heat evenly. Because lightweight pans heat unevenly, foods may burn easily.
The letter E appears in a setting indicator	An error has occurred. This may happen because cookware has boiled dry. Remove cookware and turn off the cooktop. After 30 seconds, turn on the cooktop. If the cookware was the problem, E will no longer display. An error may occur because of water, oil, or food on the controls. Clean the control panel. Disconnect the power to the range for a minute, then reconnect it. If the error still occurs, call an authorized dealer or service technician.
The Hot Cooktop warning did not come on.	The cooktop did not get hot enough to activate the warning. If the cooktop was running long enough for the surface to get hot, call an authorized dealer or service technician.
The control area becomes hot.	The cookware is too large or too close to the controls. Put large cookware on a rear zone if possible.
Areas of discoloration with metallic sheen on cooktop surface.	Mineral deposits from water and food. Remove them using cooktop cleaning creme applied to the ceramic surface. Buff with a non-abrasive cloth or sponge.
Scratches or abrasions on cooktop surface.	Coarse particles such as salt or hardened soils between cooktop and utensils can cause scratches. Be sure the cooktop surface and bottoms of utensils are clean before use. Small scratches do not affect cooking and will become less visible with time. Cleaning materials not recommended for ceramic-glass cooktop have been used. Apply cooktop cleaning creme to the ceramic surface. Buff with a non-abrasive cloth or sponge. Cookware with a rough bottom was used. Use smooth, flat-bottomed cookware.
Metal marks on the cooktop.	Sliding or scraping of metal utensils on cooktop surface. Do not slide metal utensils on the cooktop surface. Apply cooktop cleaning creme to the ceramic surface. Buff with a non-abrasive cloth or sponge. For more information, see <a href="#">“Cooktop Maintenance”</a> on <a href="#">page 40</a> .
Brown streaks or specks on cooktop surface.	Boil overs are cooked onto the surface. When cooktop is cool, use a razor blade scraper to remove soil. For more information see <a href="#">“Cooktop Maintenance”</a> on <a href="#">page 40</a> .
<b>Self Clean Problems</b>	
Self clean does not work.	Oven control not set properly. See <a href="#">“Self Clean”</a> on <a href="#">page 34</a> .

## BEFORE YOU CALL

<b>Problem</b>	<b>Cause / Solution</b>
Oven racks discolored or do not slide easily.	Oven racks left in oven cavity during self clean. Remove oven racks from oven cavity before starting a self-clean cycle. Clean by using a mild abrasive cleaner following manufacturer's instructions. Rinse with clean water, dry, and replace in oven.
Soil not completely removed after self clean.	Self clean was interrupted. Review instructions on <a href="#">"Self Clean"</a> on <a href="#">page 34</a> . Excessive spills on oven bottom. Remove excessive spills before starting self clean. Failure to clean soil from the oven frame, the door liner outside the oven door gasket, and the small area at the front center of the oven bottom. These areas are not in the self-cleaning area, but get hot enough to burn on residue. Clean these areas before starting the self-cleaning cycle. Burned-on residue can be cleaned with a stiff nylon brush and water or a nylon scrubber. Be careful not to damage the oven gasket.
<b>Other Problems</b>	
Appliance is not level.	Be sure the floor is level, strong, and stable enough to adequately support the range. If the floor is sagging or sloping, contact a carpenter to correct the situation. Poor installation. Place the oven rack in the center of the oven. Place a level on the oven rack. Adjust the leveling legs at the base of the appliance until the rack is level. Kitchen cabinet alignment may make range appear not level. Be sure cabinets are square and have sufficient room for appliance clearance.
Cannot move appliance easily. Appliance must be accessible for service.	Cabinets not square or are built in too tightly. Contact the builder or installer to make the appliance accessible. Carpet interferes with appliance. Provide sufficient space so the appliance can be lifted over carpet. Installation over carpet is not advised. See the installation instructions for guidelines specific to your appliance.
Oven light does not work.	Be sure the oven light is secure in the socket. See <a href="#">"Replacing the Oven Light"</a> on <a href="#">page 43</a> .

# WARRANTY

Your appliance is covered by a one year limited warranty. For one year from your original date of purchase, Electrolux will pay all costs for repairing or replacing any parts of this appliance that prove to be defective in materials or workmanship when such appliance is installed, used and maintained in accordance with the provided instructions.

## Exclusions

This warranty does not cover the following:

1. Products with original serial numbers that have been removed, altered or cannot be readily determined.
2. Product that has been transferred from its original owner to another party or removed outside the USA or Canada.
3. Rust on the interior or exterior of the unit.
4. Products purchased "as-is" are not covered by this warranty.
5. Food loss due to any refrigerator or freezer failures.
6. Products used in a commercial setting.
7. Service calls which do not involve malfunction or defects in materials or workmanship, or for appliances not in ordinary household use or used other than in accordance with the provided instructions.
8. Service calls to correct the installation of your appliance or to instruct you how to use your appliance.
9. Expenses for making the appliance accessible for servicing, such as removal of trim, cupboards, shelves, etc., which are not a part of the appliance when it is shipped from the factory.
10. Service calls to repair or replace appliance light bulbs, air filters, water filters, other consumables, or knobs, handles, or other cosmetic parts.
11. Surcharges including, but not limited to, any after hour, weekend, or holiday service calls, tolls, ferry trip charges, or mileage expense for service calls to remote areas, including the state of Alaska.
12. Damages to the finish of appliance or home incurred during installation, including but not limited to floors, cabinets, walls, etc.
13. Damages caused by: services performed by unauthorized service companies; use of parts other than genuine Electrolux parts or parts obtained from persons other than authorized service companies; or external causes such as abuse, misuse, inadequate power supply, accidents, fires, or acts of God.

## DISCLAIMER OF IMPLIED WARRANTIES; LIMITATION OF REMEDIES

CUSTOMER'S SOLE AND EXCLUSIVE REMEDY UNDER THIS LIMITED WARRANTY SHALL BE PRODUCT REPAIR OR REPLACEMENT AS PROVIDED HEREIN. CLAIMS BASED ON IMPLIED WARRANTIES, INCLUDING WARRANTIES OF MERCHANTABILITY OR FITNESS FOR A PARTICULAR PURPOSE, ARE LIMITED TO ONE YEAR OR THE SHORTEST PERIOD ALLOWED BY LAW, BUT NOT LESS THAN ONE YEAR. ELECTROLUX SHALL NOT BE LIABLE FOR CONSEQUENTIAL OR INCIDENTAL DAMAGES SUCH AS PROPERTY DAMAGE AND INCIDENTAL EXPENSES RESULTING FROM ANY BREACH OF THIS WRITTEN LIMITED WARRANTY OR ANY IMPLIED WARRANTY. SOME STATES AND PROVINCES DO NOT ALLOW THE EXCLUSION OR LIMITATION OF INCIDENTAL OR CONSEQUENTIAL DAMAGES, OR LIMITATIONS ON THE DURATION OF IMPLIED WARRANTIES, SO THESE LIMITATIONS OR EXCLUSIONS MAY NOT APPLY TO YOU. THIS WRITTEN WARRANTY GIVES YOU SPECIFIC LEGAL RIGHTS. YOU MAY ALSO HAVE OTHER RIGHTS THAT VARY FROM STATE TO STATE.

## If You Need Service

Keep your receipt, delivery slip, or some other appropriate payment record to establish the warranty period should service be required. If service is performed, it is in your best interest to obtain and keep all receipts. Service under this warranty must be obtained by contacting Electrolux at the addresses or phone numbers below.

This warranty only applies in the USA and Canada. In the USA, your appliance is warranted by Electrolux Major Appliances North America, a division of Electrolux Home Products, Inc. In Canada, your appliance is warranted by Electrolux Canada Corp. Electrolux authorizes no person to change or add to any obligations under this warranty. Obligations for service and parts under this warranty must be performed by Electrolux or an authorized service company. Product features or specifications as described or illustrated are subject to change without notice.

USA  
1.800.944.9044  
Electrolux Home Products, Inc.  
10200 David Taylor Drive  
Charlotte, NC 28262



Canada  
1.800.265.8352  
Electrolux Canada Corp.  
5855 Terry Fox Way  
Mississauga, Ontario, Canada  
L5V 3E4