



ENGLISH

ESPAÑOL

OWNER'S MANUAL

# WASHING MACHINE

**Please read this owner's manual thoroughly before operating and keep it handy for reference at all times. Operating Instructions are available on the LG website at: [https://us.smarthing.com/images/pdfmanual/TL\\_TD\\_EN.pdf](https://us.smarthing.com/images/pdfmanual/TL_TD_EN.pdf)**

WT7060C\*

WT7300C\*

WT7100C\*

WT7800C\*

WT7250C\*

WT7900H\*A



MFL68267065  
Rev.03\_072619



[www.lg.com](http://www.lg.com)

Copyright © 2018-2019 LG Electronics Inc. All Rights Reserved.

# TABLE OF CONTENTS

## **3 SAFETY INSTRUCTIONS**

---

- 3 IMPORTANT SAFETY INSTRUCTIONS

## **7 PRODUCT OVERVIEW**

---

- 7 Parts
- 7 Accessories

## **8 INSTALLATION**

---

- 8 Tools Needed
- 8 Product Specifications
- 9 Choosing the Proper Location
- 10 Unpacking and Removing Shipping Material
- 11 Connecting the Water Lines
- 12 Connecting the Drain Hose
- 13 Leveling the Washer
- 14 Connecting to the Power Supply
- 14 Testing the Washer

## **15 OPERATION**

---

- 15 Using the Washer
- 16 Loading the Washer

## **17 SMART FUNCTIONS**

---

- 17 LG SmartThinQ Application  
(For the product that contains the wireless LAN module)
- 20 Smart Diagnosis™ Function

## **21 MAINTENANCE**

---

- 21 Regular Cleaning
- 23 Cleaning the Water Inlet Filters
- 24 Care in Cold Climates

## **25 TROUBLESHOOTING**

---

- 25 Before Calling for Service

## **33 LIMITED WARRANTY**

---

- 33 FOR USA
- 36 Warranty Exceptions (U.S.)

# SAFETY INSTRUCTIONS

## READ ALL INSTRUCTIONS BEFORE USE

### Your safety and the safety of others are very important.

We have provided many important safety messages in this manual and on your appliance. Always read and follow all safety messages.

-  This is the safety alert symbol.  
This symbol alerts you to potential hazards that can kill or injure you and others.  
All safety messages will follow the safety alert symbol and either the word WARNING or CAUTION.

These words mean:

#### **WARNING**

If you do not follow instructions, it could result in death or serious injury.

#### **CAUTION**

If you do not follow instructions, it could result in minor or moderate injury or damage to the product.

All safety messages tell you what the potential hazard is, tell you how to reduce the chance of injury, and tell you what may happen if the instructions are not followed.

## IMPORTANT SAFETY INSTRUCTIONS

### **WARNING**

**To reduce the risk of explosion, fire, death, electric shock, scalding or injury to persons when using this product, follow basic precautions, including the following:**

#### **INSTALLATION**

- Adhere to all industry recommended safety procedures including the use of long-sleeved gloves and safety glasses.
- Never attempt to operate this appliance if it is damaged, malfunctioning, partially disassembled, or has missing or broken parts, including a damaged cord or plug.
- Before use, the appliance must be properly installed as described in this manual.
- To reduce the risk of severe injury or death, follow all installation instructions.
- Refer to the INSTALLATION INSTRUCTIONS for detailed grounding procedures. Installation instructions are packed with the appliance for the installer's reference. If the appliance is moved to a new location, have it checked and reinstalled by qualified service personnel.
- Moving or installation of the appliance requires two or more people.
- Do not install the appliance in humid spaces.
- Store and install the appliance where it will not be exposed to temperatures below freezing or exposed to outdoor weather conditions.
- This appliance is not designed for maritime use or for mobile installations such as in RVs, trailers, or aircraft.

## 4 SAFETY INSTRUCTIONS

- Keep packing materials out of the reach of children. Packaging material can be dangerous for children. There is a risk of suffocation.
- Destroy the carton, plastic bag, and other packing materials after the appliance is unpacked. Children might use them for play. Cartons covered with rugs, bedspreads, or plastic sheets can become airtight chambers.
- The appliance must be installed and electrically grounded by qualified service personnel in accordance with local codes.
- Do not, under any circumstances, cut or remove the third (ground) prong from the power cord.
- When installing or moving the appliance, be careful not to pinch, crush, or damage the power cord.
- Connect to a properly rated, protected, and sized power circuit to avoid electrical overload.
- This appliance must be positioned near to an electrical power supply.
- Disconnect the power cord, house fuse or circuit breaker before installing or servicing the appliance.
- The power cord of this appliance is equipped with a 3-prong (grounding) plug which mates with a standard 3-prong (grounding) wall outlet to minimize the possibility of electric shock from this appliance.
- Use new hoses when connecting the appliance to the water supply. Do not reuse old hoses.

### OPERATION

- Read all instructions before using the appliance and save these instructions.
- Use this appliance only for its intended purpose.
- If the product has been submerged, contact an LG Electronics customer information center for instructions before resuming use.
- If you detect a strange sound, a chemical or burning smell, or smoke coming from the appliance, unplug it immediately, and contact an LG Electronics customer information center.
- Under certain conditions, hydrogen gas may be produced in a hot-water system that has not been used for two weeks or more. **HYDROGEN GAS IS EXPLOSIVE.** If the hot-water system has not been used for such a period, before using the appliance turn on all hot water faucets and let the water flow from each for several minutes. This will release any accumulated hydrogen gas. As the gas is flammable, do not smoke or use an open flame during this time.
- Do not reach into the washer if the tub or drum, agitator, or any interior parts are moving. Before loading, unloading, or adding items, press Start/Pause and allow the tub or drum to coast to a complete stop before reaching inside.
- This appliance is not intended for use by persons (including children) with reduced physical, sensory or mental capabilities, or lack of experience and knowledge, unless they have been given supervision or instruction concerning the use of the appliance by a person responsible for their safety.
- Do not allow children or pets to play on, in or with the appliance. Close supervision is necessary when the appliance is used near children or pets.
- Keep laundry products out of children's reach. To prevent injury to persons, observe all warnings on product labels.
- Repair or immediately replace all power cords that have become frayed or otherwise damaged. Do not use a cord that shows cracks or abrasion damage along its length or at either end.
- Never unplug the appliance by pulling on the power cord. Always grip the plug firmly and pull straight out from the outlet.
- Do not use an extension cord or adapter with this appliance.
- Do not grasp the power cord or touch the appliance controls with wet hands.
- Do not modify or extend the power cord.

- If the electrical supply cord is damaged, it must only be replaced by the manufacturer or its service agent or a similar qualified person in order to avoid a hazard.
- Do not put oily or greasy clothing, candles or flammable materials on top of the appliance.
- Keep the area underneath and around your appliances free of combustible materials (lint, paper, rags, etc.), gasoline, chemicals and other flammable vapors and liquids.
- Do not store or use gasoline or other flammable vapors and liquids in the vicinity of this or any other appliance.
- Do not mix chlorine bleach with ammonia or acids such as vinegar. Follow package directions when using laundry products. Incorrect usage can produce poisonous gas, resulting in serious injury or death.
- Never use harsh chemicals, abrasive cleaners, or solvents to clean the washer. They will damage the finish.
- Do not wash articles that have been previously cleaned in, washed in, soaked in, or spotted with gasoline, dry-cleaning solvents, vegetable or cooking oil, or other flammable or explosive substances, as they give off vapors that could ignite or explode.
- Do not add gasoline, dry cleaning solvents, or other flammable or explosive substances to the wash water. These substances give off vapors that could ignite or explode.
- In the event of a gas leak (propane gas, LP gas, etc.) do not operate this or any other appliance. Open a window or door to ventilate the area immediately.
- Do not tamper with controls.
- Fix the drain hose securely in place to avoid flooding.
- Do not abuse, sit on, or stand on the lid (door) of the appliance.
- Keep hands and foreign objects clear of the lid (door) and latch area when closing the lid (door).
- Always check the inside of the appliance for foreign objects.
- Do not allow water, bleach, or other liquids to sit in the drum for extended periods. Doing so can corrode the drum or cause mildew or odors.

## MAINTENANCE

- Do not repair or replace any part of the appliance. All repairs and servicing must be performed by qualified service personnel unless specifically recommended in this owner's manual. Use only authorized factory parts.
- Disconnect this appliance from the power supply before cleaning and attempting any user maintenance. Turning the controls to the OFF position does not disconnect this appliance from the power supply.
- Remove any dust or foreign matter from the power plug pins.
- Do not disassemble or repair the appliance by yourself.
- Remove the lid (door) before the appliance is removed from service or discarded to avoid the danger of children or small animals getting trapped inside.
- Make sure the dispenser drawer or lid (door) is closed at all times when not being filled with laundry products.

## GROUNDING INSTRUCTIONS

- Improper connection of the equipment-grounding conductor can result in a risk of electric shock. Check with a qualified electrician or service personnel if you are in doubt whether the appliance is properly grounded. Do not modify the plug provided with the appliance; if it will not fit the outlet, have a proper outlet installed by a qualified electrician.
- The appliance must be grounded. In the event of a malfunction or breakdown, grounding will reduce the risk of electric shock by providing a path of least resistance for electric current. The appliance is equipped with a cord having an equipment-grounding conductor and a grounding plug. The plug must be plugged into an appropriate outlet that is installed and grounded in accordance with all local codes and ordinances.

**⚠ CAUTION**

**To reduce the risk of minor or moderate injury to persons, malfunction, or damage to the product or property when using this product, follow basic precautions, including the following:**

**INSTALLATION**

- Install the product on a firm and level floor.

**OPERATION**

- Do not place objects on top of the appliance.
- Turn off the water faucets and unplug the appliance if the appliance is to be left for an extended period of time, such as during vacations.
- ALWAYS follow the fabric care instructions supplied by the garment manufacturer.
- Use fabric softeners or products to eliminate static only as recommended by the manufacturer.
- Do not combine laundry products for use in one load unless specified on the label.
- Do not touch draining water which may be hot.
- If the drain hose and the water supply hose are frozen in winter, defrost before using the appliance.
- Do not store or spill liquid detergents, cleaners, or bleaches (chlorine bleach, oxygen bleach) on the appliance. Doing so may result in corrosion, discoloration or damage to the surface of the appliance.
- Clothing or articles that are waterproof or water resistant must be washed in the Waterproof cycle only. (e.g. water resistant clothing, mattress covers, outdoor clothes, plastic mats, etc.) Otherwise, it may result in personal injury or damage to the washer, clothes, walls, floor, and surrounding objects due to abnormal vibration.

**SAVE THESE INSTRUCTIONS**

# PRODUCT OVERVIEW

## Parts

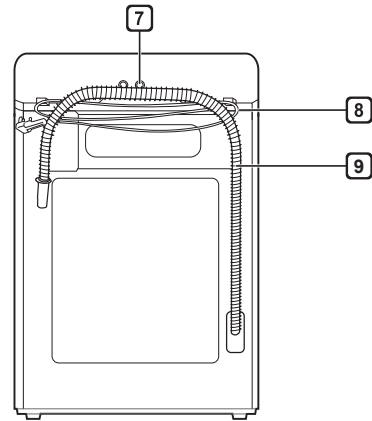
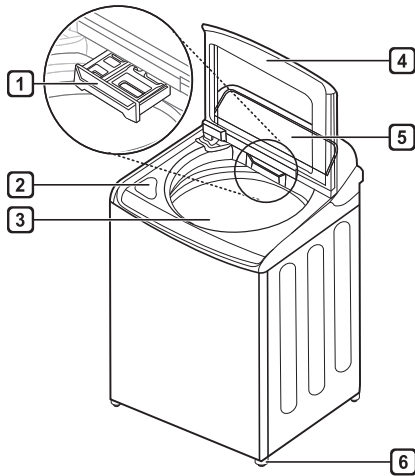

**1** Detergent Dispenser

**3** Tub

**5** Control Panel

**7** Water Inlets

**2** Liquid Bleach Compartment

**4** Lid (Door)

**6** Leveling Feet

**8** Power Cord

**9** Drain Hose

## Accessories

### Included Accessories



Tie Strap

### Required Accessories

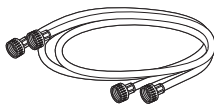

Hot and Cold Water Hoses

### NOTE

- The images in this guide may be different from the actual components and accessories, which are subject to change by the manufacturer without prior notice for product improvement purposes.
- For your safety and for extended product life, use only authorized components. The manufacturer is not responsible for product malfunction or accidents caused by the use of separately purchased unauthorized components or parts.

# INSTALLATION

## Tools Needed

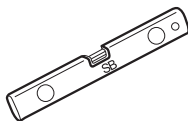

Pliers

Flat-blade  
Screwdriver

Level

## Product Specifications

The appearance and specifications listed in this manual may vary due to constant product improvements.

<b>Model</b>	WT7100C* WT7250C* WT7300C*	WT7800C* WT7900H*A
<b>Electrical requirements</b>	120 VAC @ 60 Hz	
<b>Min. / Max. water pressure</b>	20 - 120 psi (138 - 827 kPa)	
<b>Dimensions</b>	27" (W) X 28 3/8" (D) X 44 1/2" (H), 57 1/4" (H with lid (door) open) 68.6 cm (W) X 72.1 cm (D) X 113 cm (H), 145.3 cm (H with lid (door) open)	
<b>Net weight</b>	127.9 lbs (58.0 kg)	132.3 lbs (60.0 kg)
<b>Max spin speed</b>	950 RPM (±50 rpm)	

### WARNING

- Moving or installation of the appliance requires two or more people. Failure to follow these instructions may result in injury.
- Store and install the appliance where it will not be exposed to temperatures below freezing or exposed to outdoor weather conditions. Failure to follow this warning can cause product or part failure, serious injury, fire, electric shock, or death.
- Properly ground the washer to conform with all governing codes and ordinances. Failure to follow this warning can cause serious injury, fire, electric shock, or death.
- To reduce the risk of electric shock, do not install the appliance in humid spaces. Failure to follow this warning can cause serious injury, fire, electric shock, or death.
- To ensure proper airflow, do not block the large opening on the bottom of the washer with carpeting or other materials.
- Do not remove the ground prong. Do not use an adapter or extension cord. Plug into a grounded 3-prong outlet. Failure to follow this warning can cause serious injury, fire, electric shock, or death.
- Certain internal parts are intentionally not grounded and may present a risk of electric shock only during servicing. Service personnel-do not contact the following parts while the appliance is energized. : pump, motor, noise filter cover, and heater (on applicable models).



## Choosing the Proper Location

Install the washer on a solid floor that is strong and rigid enough to support the weight of the washer, even when fully loaded, without flexing or bouncing. If the floor has too much flex, you may need to reinforce it to make it more rigid. If the floor is not solid, it may cause severe vibration and noise.

### NOTE

- Before installing the washer, make sure the floor is clean, dry and free of dust, dirt, water and oil so the washer feet cannot slide easily. Leveling feet that can move or slide on the floor can contribute to excess vibration and noise due to poor contact with the floor.
- Allow for sufficient space between the walls and the washer for installation.

## Power Outlet

- The power outlet must be within 60 inches (1.5 m) of either side of the washer.
- The appliance and outlet must be positioned so that the plug is easily accessible.
- Do not overload the outlet with more than one appliance.
- The outlet must be grounded in accordance with current electrical wiring codes and regulations.
- Use a time-delay fuse or circuit breaker.

### NOTE

- It is the personal responsibility and obligation of the product owner to have a proper outlet installed by a qualified electrician.

## Flooring

- To minimize noise and vibration, the washer must be installed on a solidly constructed floor.
- Allowable slope under the entire washer is a maximum 1 inch difference from side to side or from front to back.
- Installing on carpeting and soft tile surfaces is not recommended.
- Never install the washer on a platform or weakly supported structure.

### NOTE

- The washer must be installed on firm flooring to minimize vibration during the spin cycle. Concrete flooring is best, but a wood floor is sufficient, provided it is built to FHA standards.

## Floor Installation

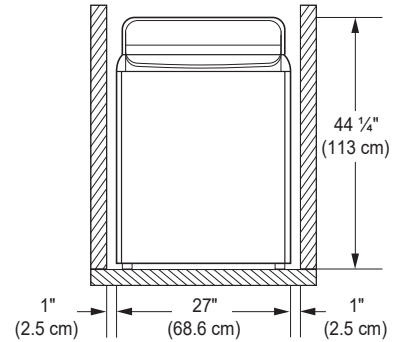

To ensure sufficient clearance for water lines, the drain line and airflow, allow minimum clearances of at least 1 inch (2.5 cm) at the sides and 4 inches (10 cm) behind the unit. Be sure to allow for wall, door, or floor moldings that may increase the required clearances.

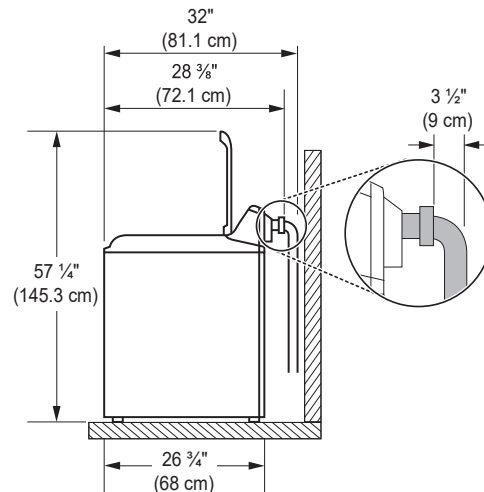

- Minimum vertical space from floor to overhead shelves, cabinets, ceilings, etc., is 58 inches (147 cm).

## Unpacking and Removing Shipping Material

Unpack all shipping materials from the washer for proper operation and inspect it for shipping damage.

### ⚠ CAUTION

- Failure to remove shipping materials can cause excessive noise and vibration.

#### 1 Lift the washer off the foam base.

After removing the carton and shipping material, lift the washer off the foam base. Make sure the plastic tub support comes off with the base and is not stuck to the bottom of the washer.

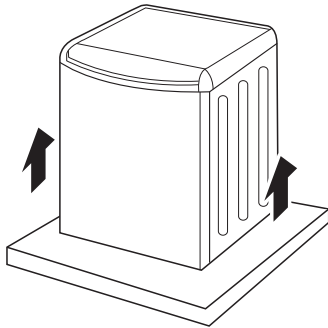

If you must lay the washer down to remove the base packaging materials, always protect the side of the washer and lay it carefully on its side. Do not lay the washer on its front or back.

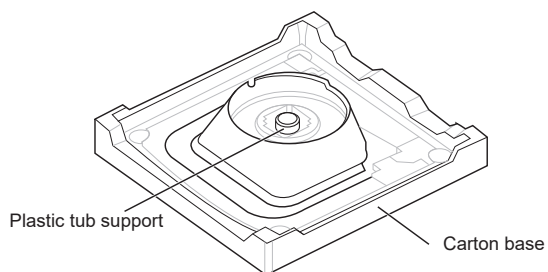

- 2 To prevent damage, do not remove the foam block containing the owner's manual, parts, and laundry product samples from the washer tub until the washer is in the final location.

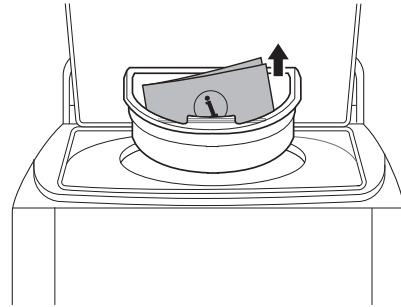

#### NOTE

- Once removed, save the foam block for future use. If the washer needs to be moved, the foam block will help prevent damage during transportation.

- 3 Unfasten the power cord from the back of the washer.

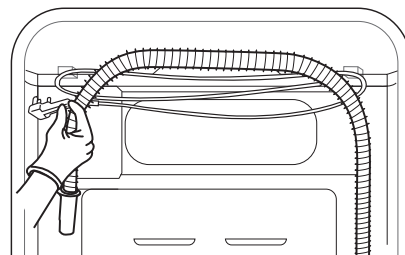

## Connecting the Water Lines

To avoid the risk of costly water damage, purchase and install new inlet hoses when installing the washer.

### 1 Check the fittings and seals.

Inspect the threaded fitting on each hose and make sure there is a rubber seal in place in both ends of each hose to prevent leaking.

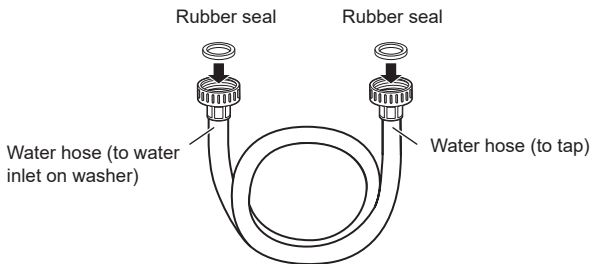

### 2 Connect the water supply hoses.

Connect the water supply hoses to the hot and cold water faucets tightly by hand and then tighten another 2/3 turn with pliers. Connect the blue hose to a cold water faucet and the red hose to a hot water faucet.

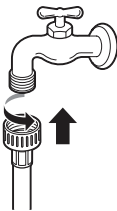

### 3 Flush out the inlet hoses.

After connecting the inlet hoses to the water faucets, turn on the water faucets to flush out foreign substances (dirt, sand or sawdust) in the water lines. Let water drain into a bucket, and check the water temperature to make sure you've connected the hoses to the correct faucets.

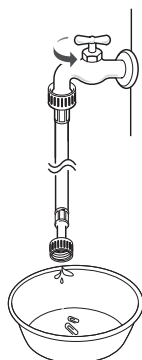

### 4 Attach the water lines to the back of the washer.

Attach the hot water line to the hot water inlet on the back of the washer. Attach the cold water line to the cold water inlet on the back of the washer. Tighten the fittings securely. Turn ON both faucets all the way and check for leaks at both ends of the hoses.

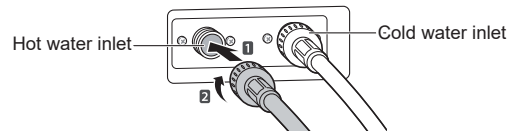

### ! WARNING

- Do not overtighten the hoses or cross-thread the hose fittings. Overtightening or cross-threading can damage the valves or couplings, resulting in leaking and property damage.
- Do not reuse old hoses. Use only new hoses when installing the washer. Old hoses could leak or burst causing flooding and property damage. Contact an LG Customer Information Center for assistance in buying hoses.

### NOTE

- Periodically check the hoses for cracks, leaks, and wear, and replace the hoses every five years. Do not stretch the water hoses intentionally, and make sure that they are not pinched, crushed or kinked by other objects.
- Water supply pressure must be between 20 psi and 120 psi (138 – 827 kPa). If the water supply pressure is more than 120 psi, a pressure reducing valve must be installed.
- To provide optimum washing performance, the hot water temperature should be set at 120 – 135 °F (48 – 57 °C) and the cold at 60 °F (15 °C).
- The washer should never be installed or stored in a location subject to freezing temperatures. Damage to the water lines and internal mechanisms of the washer can result. If the washer was exposed to freezing temperatures prior to installation, allow it to stand at room temperature for several hours before use and check for leaks prior to operation.
- Do not use flood-preventing hoses with auto shutoff devices. The devices can be tripped during fill and prevent the machine from filling properly.

## 12 INSTALLATION

### Connecting the Drain Hose

Connect the drain hose to either a standpipe or laundry tub.

#### NOTE

- The drain hose should always be properly secured. Failure to properly secure the drain hose can result in flooding and property damage.
- The drain must be installed in accordance with any applicable local codes and regulations.
- Make sure that the drain hose is not stretched, pinched, crushed, or kinked.
- Do not install the drain hose with the end lower than 29.5 inches (75 cm) or higher than 96 inches (244 cm) above the bottom of the washer or more than 60 inches (152 cm) away from the washer.
- Never create an airtight seal between the hose and the drain with tape or other means. If no air gap is present, water can be siphoned out of the tub resulting in poor wash/rinse performance or clothing damage.
- Normal height of the end of the hose should be approximately 35 inches (89 cm) to 47 inches (120 cm) from the floor.

- 3 If the water valves and drain are built into the wall, fasten the drain hose to one of the water hoses with the tie strap provided (ribbed side on inside).

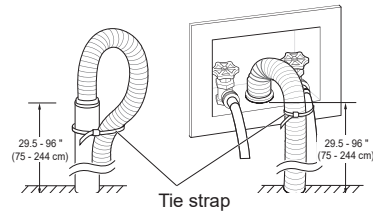

#### CAUTION

- Do not insert the end of the drain hose into the standpipe more than 8 inches (20 cm). Doing so can cause siphoning, odors, or improper draining.

#### NOTE

- If the drain is large enough for the flange on the hose to fit inside, then do not insert the flange more than 1-2 inches into the drain.

#### Option 1: Standpipe

- 1 Insert the end of the drain hose into the standpipe.
- 2 Use the provided tie strap to secure the drain hose in place.

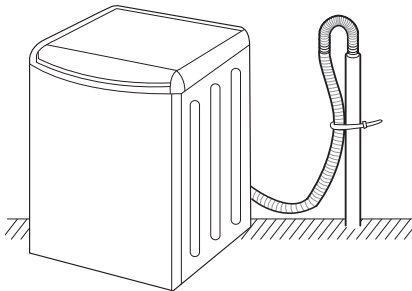

#### Option 2: Laundry Tub

- 1 Hang the end of the drain hose over the side of the laundry tub.
- 2 Use the provided tie strap to secure the drain hose in place.

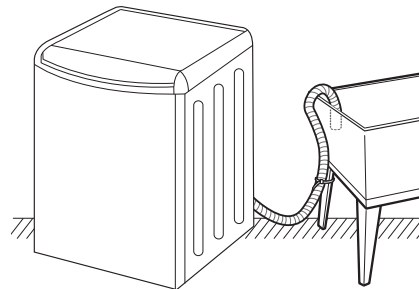

## Leveling the Washer

The tub of the washer spins at very high speeds. To minimize vibration, noise, and unwanted movement, the floor must be a level, solid surface.

### NOTE

- Adjust the leveling feet only as far as necessary to level the washer. Extending the leveling feet more than necessary can cause the washer to vibrate.
- Before installing the washer, make sure that the floor is clean, dry and free of dust, dirt, water and oil so the washer feet cannot slide easily. Feet that move or slide on the floor can contribute to excessive vibration and noise due to poor contact with the floor.

### 1 Position the washer in its final location.

Take special care not to pinch, strain, or crush the water and drain lines. If you have a carpenter's level, you can use it to check that the washer level. The slope beneath the washer should not exceed 1 inch, and all four leveling feet must rest firmly on the floor.

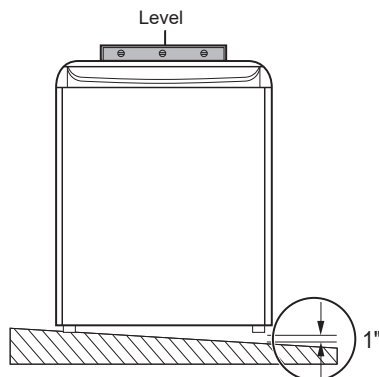

### 2 Open the lid (door) and look from above to see if the tub is centered.

If the tub is NOT centered, readjust the front feet. If you have a level, check the washer with the level.

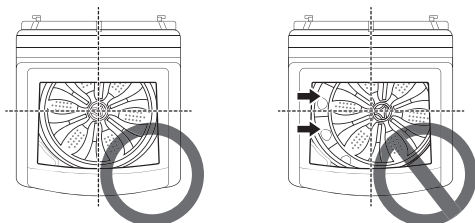

### NOTE

- To check if the washer is level from side to side, place a level on the back edge of the lid (door).
- To check if the washer is level from front to back, place a level at the side of the washer on the edge where the cabinet side meets the top cover. Do not place the level on the top of the lid (door). Using these surfaces will result in the washer being unlevel.

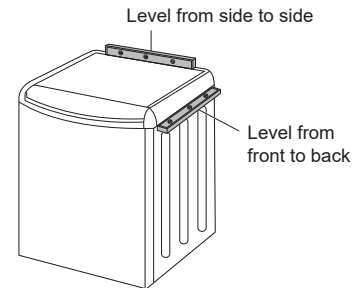

### 3 Adjust the lower leveling feet.

Turn in one direction to raise the washer or the other direction to lower it.

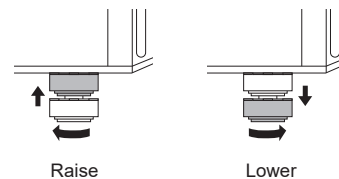

### 4 Recheck the washer's levelness.

Push or rock the top edges of the washer gently to make sure the washer does not rock. If the washer rocks, repeat steps 1-3.

### CAUTION

- Using the washer without leveling it may cause excess vibration and noise, leading to a machine malfunction.
- Extend the leveling feet only to level the washer. If you extend the leveling feet unnecessarily, it may cause abnormal vibration of the washer.

### NOTE

- If the washer is not level, the lid (door) may not stay open properly. If this happens, extend the front leveling legs until the washer is level from front to back.

## Connecting to the Power Supply

The washer should be plugged into a 120-VAC, 60 Hz grounded 3-prong outlet. Plug in the washer.



### WARNING

- Do not use a worn or damaged power cord or power plug. Replace or repair it immediately. Failure to do so may result in death, fire, electric shock, or malfunction.
- Do not modify the power cord and plug provided with the appliance. Do not damage it when installing or moving the washer. Doing so may result in death, fire, electric shock, or malfunction.
- Make sure that the washer is grounded.
- Connect this washer to a grounded outlet conforming to the rating prior to use. Failure to do so may result in fire, electric shock, or malfunction.
- Do not damage or cut off the ground prong of the power cord. Doing so may cause death, fire, electric shock, or product malfunction.
- Improper connection of the equipment-grounding conductor can result in risk of electric shock. Check with a qualified electrician or service technician if you are in doubt as to whether the appliance is properly grounded. If it does not fit the outlet, have a proper outlet installed by a qualified electrician.
- The appliance and outlet must be positioned so that the plug is easily accessible.
- Do not use adapters or extension cords. Doing so may result in serious injury, fire, electric shock, or death.
- For best performance, plug the washer into its own individual outlet. This helps prevent overloading house wiring circuits which could cause a fire hazard from overheated wires.
- If necessary, use a new, UL-listed 3-prong adapter or 3-wire extension cord with a 3-prong (grounding) plug rated at no less than the branch circuit. Do not use an extension cord longer than 3 feet. Failure to follow these warnings may result in serious injury, fire, electric shock, or death.



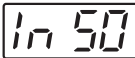

## Testing the Washer

Check if the washer is properly installed and run a test cycle.



- 1 Make sure the tub is empty. Do not load anything in the tub for this test.
- 2 Press the **Power** button then immediately press and hold both the **Spin** and **Soil** buttons until an  code appears in the display. (See below for a key to the codes.)

Display	Information
	Initial test
	Previous test result was good.
	Previous test was ended with an error.

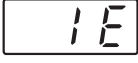

### NOTE

-  is displayed first, and ,  or  is displayed.
- The indication is different for each model.

- 3 Press the **Start/Pause** button.  
The washer will start the test, which will last about 3 minutes. The test automatically checks the water inlet hoses and the drain hose.
- 4 Check the display for results.  
If error code is displayed, refer to the following guide.

Error Code	Solution
	Fully open the water faucets. Straighten out any kinks in the inlet hoses and make sure the hoses are not pinned against the wall or under the washer.
	Straighten out any kinks in the drain hose and make sure the hose is not pinned against the wall or under the washer. Remove and flush out the drain hose to remove clogs. Adjust or repair the drain. Maximum drain height is 96 inches.

- 5 End of cycle.

At the end of the test cycle,  or  will display. The test cycle will end and the washer will shut off automatically after a short delay.

# OPERATION

## Using the Washer

### WARNING

- To reduce the risk of fire, electric shock, or injury to persons, read the **SAFETY INSTRUCTIONS** before operating this appliance.

#### 1 Sort laundry and load the washer.

Sort laundry by fabric type, soil level, color and load size, as needed. Open the lid (door) and load items into the washer.

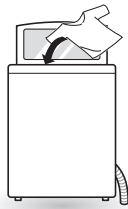

#### 2 Add cleaning products.

Add the proper amount of HE (High-Efficiency) detergent to the detergent dispenser. If desired, add bleach or fabric softener to the appropriate dispensers.

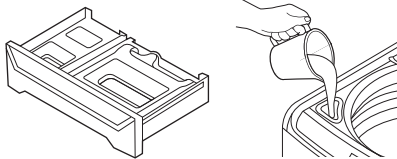

#### 3 Turn on the washer.

Press the **Power** button to turn on the washer. The lights above the cycle buttons will illuminate and a chime will sound.

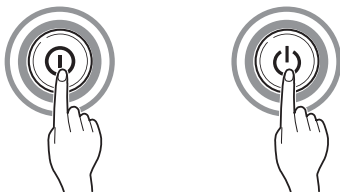

#### 4 Select a cycle.

Turn the cycle selector knob or press the cycle buttons repeatedly until the desired cycle is selected. The preset wash temperature, spin speed, soil level and option settings for that cycle are shown.

- Pressing the **Start/Pause** button without selecting a cycle will cause the Normal cycle to begin immediately.

#### 5 Adjust settings.

Default settings for the selected cycle can now be changed, if desired, using the cycle modifier and option buttons.

#### NOTE

- Not all modifiers and options are available on all cycles. A different chime sounds and the LED does not light up if the selection is not allowed.

#### 6 Begin cycle.

Press the **Start/Pause** button to begin the cycle. The lid (door) locks, and the washer agitates briefly without water to measure the weight of the load.



#### 7 Additional garments can be added to the tub while the Add Garment light is on.

The **Add Garment** light illuminates near the beginning of the wash cycle to indicate when it is safe to add items to the load. Press the **Start/Pause** button to pause the cycle and add garments to the load. Press the **Start/Pause** button to resume the cycle.

#### NOTE

- Adding items after the Add Garment light turns off may result in poor wash performance.

#### 8 End of cycle.

When the cycle is finished, a melody sounds. Immediately remove the clothing from the washer to reduce wrinkling.

- If the washer includes lint filters, remember to check them after every 2 to 3 loads.

## Loading the Washer

### ⚠ CAUTION

- The washer can be fully loaded, but the tub should not be tightly packed with items. The lid (door) of the washer should close easily.
- Use the Bedding cycle for buoyant or nonabsorbent items such as pillows or comforters. Failure to follow this caution can result in leakage.

- Check and empty pockets. Paper clips, coins, matches, etc. can damage clothing and the washer.
- Close zippers and hooks, and tie drawstrings to prevent snagging or tangling of clothes.
- Pretreat heavily stained areas for best results.
- Combine large and small items in a load. Load large items first. Large items should not be more than half of total load.
- Wash thick, bulky items individually. Heavy blankets, comforters, bedspreads, or pet beds can get tangled or cause an unbalanced load if combined with other items.
- The washer can be fully loaded, but the tub should not be tightly packed with items. The lid (door) of the washer must close easily.

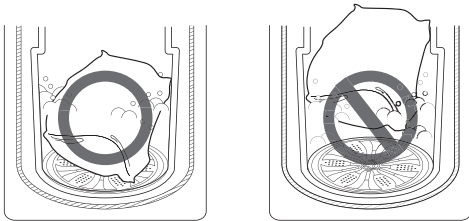

- Do not wash single small items. Add 1-2 similar items to the load to prevent an out-of-balance load.
- Clothing or articles that are waterproof or water resistant must be washed in the Waterproof cycle only. (e.g. water resistant clothing, mattress covers, outdoor clothes, plastic mats, etc.) Otherwise, it may result in personal injury or damage to the washer, clothes, walls, floor, and surrounding objects due to abnormal vibration.
- Wash small, light items in a mesh bag. Small items can get caught in the impeller at the bottom of the tub, and brassiere hooks can damage other items or the tub.
- Brush off heavy soil, dust, and hair from items before washing. Excess dirt or sand can abrade other fabrics and lead to poor wash performance.
- The washer will not fill or operate with the lid (door) open.
- Use the Bedding cycle for large or bulky items such as poly-filled jackets, comforters, pillows, etc. These items may not be as absorbent as other laundry items and should be sorted into a separate wash load for optimal results.

- Bulky items should be placed as far down in the tub as possible for optimal results. Always place buoyant items at the bottom of the tub. The washer will automatically detect the load size. Because of the high efficiency wash system, the water level may not completely cover the load.
- Do not overload the tub. Clothes should fit loosely in the tub under the maximum fill line. Loading clothes over the fill line may result in damage to clothing and the washer.
  - Load clothes loosely, and do not overfill the tub. Clothes need room to circulate in order to get clean.
  - Do not press down on items while stacking them in the tub.

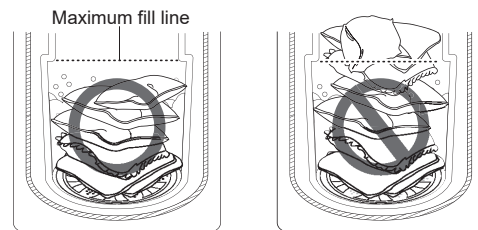

- For best performance, load clothes as shown.

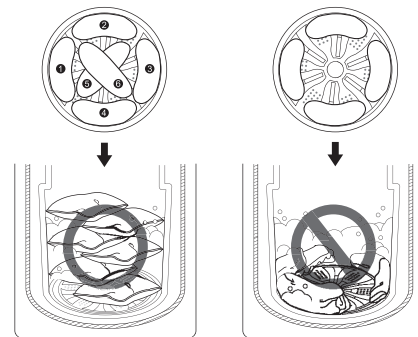

This manual contains an abbreviated Operation section. For the complete Operation section, scan the QR code below or visit: [https://us.smarthinq.com/images/pdfmanual/TL\\_TD\\_EN.pdf](https://us.smarthinq.com/images/pdfmanual/TL_TD_EN.pdf)



- Sorting Laundry
- Adding Cleaning Products
- Control Panel
- Wash Cycles
- Cycle Guide
- Cycle Modifier Buttons
- Option Buttons





# SMART FUNCTIONS

## LG SmartThinQ Application (For the product that contains the wireless LAN module)

The LG SmartThinQ application allows you to communicate with the appliance using a smartphone.

### Before Using LG SmartThinQ

- For appliances with the  or  logo
- 1 Use a smartphone to check the strength of the wireless router (Wi-Fi network) near the appliance.
    - If the distance between the appliance and the wireless router is too far, the signal strength becomes weak. It may take a long time to register or installation may fail.
  - 2 Turn off the **Mobile data** or **Cellular Data** on your smartphone.

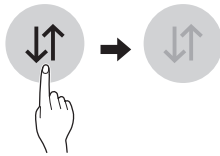

- 3 Connect your smartphone to the wireless router.

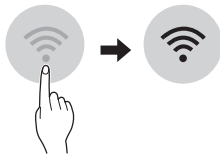

### NOTE

- To verify the Wi-Fi connection, check that **Wi-Fi**  icon on the control panel is lit.
- The appliance supports 2.4 GHz Wi-Fi networks only. To check your network frequency, contact your Internet service provider or refer to your wireless router manual.
- LG SmartThinQ is not responsible for any network connection problems or any faults, malfunctions, or errors caused by network connection.
- The surrounding wireless environment can make the wireless network service run slowly.

- If the appliance is having trouble connecting to the Wi-Fi network, it may be too far from the router. Purchase a Wi-Fi repeater (range extender) to improve the Wi-Fi signal strength.
- The network connection may not work properly depending on the Internet service provider.
- The Wi-Fi connection may not connect or may be interrupted because of the home network environment.
- If the appliance cannot be registered due to problems with the wireless signal transmission, unplug the appliance and wait about a minute before trying again.
- If the firewall on your wireless router is enabled, disable the firewall or add an exception to it.
- The wireless network name (SSID) should be a combination of English letters and numbers. (Do not use special characters.)
- Smartphone user interface (UI) may vary depending on the mobile operating system (OS) and the manufacturer.
- If the security protocol of the router is set to **WEP**, network setup may fail. Change the security protocol (**WPA2** is recommended), and register the product again.

### Installing the LG SmartThinQ Application

Search for the LG SmartThinQ application from the Google Play Store or Apple App Store on a smartphone. Follow instructions to download and install the application.

## LG SmartThinQ Application Features

- For appliances with the  or  logo

### Washer Cycle (Remote Start, Downloaded)

Set or download any preferred cycle and operate by remote control.

### Tub Clean Coach

This function shows how many cycles remain before it is time to run the Tub Clean cycle.

### Smart Diagnosis™

This function provides useful information for diagnosing and solving issues with the appliance based on the pattern of use.

### Energy Monitoring

The washer energy usage is affected by the cycles and options so you may see some changes in energy usage from one cycle to another.

### Push Alerts

When the cycle is complete or the appliance has problems, you have the option of receiving push notifications on a smart phone.

### Settings

Set the product nickname and delete product.

#### NOTE

- If you change your wireless router, Internet service provider, or password, delete the registered appliance from the LG SmartThinQ application and register it again.
- This information is current at the time of publication. The application is subject to change for product improvement purposes without notice to users.

## Using Washer Cycle

### Remote Start

Use a smart phone to control the appliance remotely or check to see how much time is left in the cycle.

#### Using Remote Start

- 1 Press the **Power** button.
- 2 Load the laundry.
- 3 Press and hold **Remote Start** button for 3 seconds to enable the Remote Start function.
- 4 Start a cycle from the LG SmartThinQ application on your smart phone.

#### NOTE

- Once the Remote Start mode is enabled, you can start a cycle from the LG SmartThinQ smartphone application. If the cycle is not started, the machine will wait to start the cycle until it is turned off remotely from the application or the Remote Start mode is disabled.
- When Remote Start is turned on, the door is automatically locked.

### Disabling Remote Start

When the Remote Start is activated, press and hold the **Remote Start** button for 3 seconds.

### Downloaded

Download new and specialized cycles that are not included in the standard cycles on the appliance.

Appliances that have been successfully registered can download a variety of specialty cycles specific to the appliance.

Only one cycle can be stored on the appliance at a time.

Once cycle download is completed in the appliance, the appliance keeps the downloaded cycle until a new cycle is downloaded.

## Wireless LAN Module Specifications

<b>Model</b>	LCW-004
<b>Frequency Range</b>	2412 - 2462 MHz
<b>Output Power (Max)</b>	IEEE 802.11 b : 22.44 dBm
	IEEE 802.11 g : 24.68 dBm
	IEEE 802.11 n : 24.11 dBm

### FCC Notice (For transmitter module contained in this product)

This equipment has been tested and found to comply with the limits for a Class B digital device, pursuant to Part 15 of the FCC Rules. These limits are designed to provide reasonable protection against harmful interference in a residential installation. This equipment generates, uses, and can radiate radio frequency energy and, if not installed and used in accordance with the instructions, may cause harmful interference to radio communications. However, there is no guarantee that interference will not occur in a particular installation. If this equipment does cause harmful interference to radio or television reception, which can be determined by turning the equipment off and on, the user is encouraged to try to correct the interference by one or more of the following measures:

- Reorient or relocate the receiving antenna.
- Increase the separation between the equipment and the receiver.
- Connect the equipment to an outlet on a circuit different from that to which the receiver is connected.
- Consult the dealer or an experienced radio/TV technician for help.

This device complies with part 15 of the FCC Rules. Operation is subject to the following two conditions:

- 1) This device may not cause harmful interference and
- 2) This device must accept any interference received, including interference that may cause undesired operation of the device.

Any changes or modifications in construction of this device which are not expressly approved by the party responsible for compliance could void the user's authority to operate the equipment.

### FCC RF Radiation Exposure Statement

This equipment complies with FCC radiation exposure limits set forth for an uncontrolled environment. This transmitter must not be co-located or operating in conjunction with any other antenna or transmitter.

This equipment should be installed and operated with a minimum distance of 20 cm (7.8 inches) between the antenna and your body. Users must follow the specific operating instructions for satisfying RF exposure compliance.

### Open Source Software Notice Information

To obtain the source code under GPL, LGPL, MPL, and other open source licenses, that is contained in this product, please visit <http://opensource.lge.com>. In addition to the source code, all referred license terms, warranty disclaimers and copyright notices are available for download.



LG Electronics will also provide open source code to you on CD-ROM for a charge covering the cost of performing such distribution (such as the cost of media, shipping, and handling) upon email request to [opensource@lge.com](mailto:opensource@lge.com). This offer is valid for a period of three years after our last shipment of this product. This offer is valid to anyone in receipt of this information.

## Smart Diagnosis™ Function

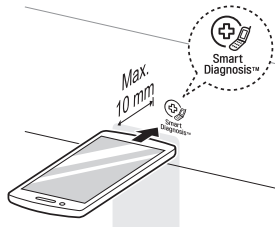
Should you experience any problems with the appliance, it has the capability of transmitting data via your telephone to the LG Customer Information Center. NFC or Wi-Fi equipped models can also transmit data to a smartphone using the LG SmartThinQ application.



### Smart Diagnosis™ through the Customer Information Center

- For appliances with the  or  logo

This method allows you to speak directly to our trained specialists. The specialist records the data transmitted from the appliance and uses it to analyze the issue, providing a fast and effective diagnosis.

- 1 Call the LG Electronics Customer Information Center at:  
(LG U.S.A.) 1-800-243-0000  
(LG Canada) 1-888-542-2623
- 2 When instructed to do so by the call center, place the mouthpiece of the phone close to the Smart Diagnosis™ icon. Do not press any other buttons.
- 3 Press and hold **Temp.** button for three seconds.
- 4 Keep the phone in place until the tone transmission has finished.
  - For best results, do not move the phone while the tones are being transmitted.
  - If the call center agent is not able to get an accurate recording of the data, you may be asked to try again.
- 5 Once the countdown is over and the tones have stopped, resume your conversation with the call center agent, who will then be able to assist you using the information transmitted for analysis.

### NOTE

- Smart Diagnosis™ cannot be activated unless the appliance can be turned on using the **Power** button. If the appliance cannot be turned on, troubleshooting must be done without using Smart Diagnosis™.
- For best results, do not move the phone while the tones are being transmitted.
- If the call center agent is not able to get an accurate recording of the data, you may be asked to try again.
- The Smart Diagnosis™ function depends on the local call quality.
- Bad call quality may result in poor data transmission from your phone to the call center, which could cause Smart Diagnosis™ to malfunction.

### LG SmartThinQ Smart Diagnosis™

- For appliances with the  or  logo

Use the Smart Diagnosis feature in the LG SmartThinQ application for help diagnosing issues with the appliance without the assistance of the LG Customer Information Center.

Follow the instructions in the LG SmartThinQ application to perform a Smart Diagnosis using your smartphone.

### NOTE

- Smart Diagnosis™ cannot be activated unless the appliance can be turned on using the **Power** button. If the appliance cannot be turned on, troubleshooting must be done without using Smart Diagnosis™.

# MAINTENANCE

## WARNING

To reduce the risk of fire, electric shock, or injury to persons, read this entire owner's manual, including the Important Safety Instructions, before operating this washer.

- Unplug the washer before cleaning to avoid the risk of electric shock. Failure to follow this warning can cause serious injury, fire, electric shock, or death.
- Do not use volatile substances (benzene, paint thinner, alcohol, acetone, etc.), abrasive cleaners, or detergents with strong chemical components when cleaning the washer. Doing so may cause discoloration or damage to the machine, or may cause a fire.
- Certain internal parts are intentionally not grounded and may present a risk of electric shock only during servicing. Service personnel-do not contact the following parts while the appliance is energized. : pump, motor, noise filter cover, and heater (on applicable models).

## Regular Cleaning

### Care After Wash

After the cycle is finished, wipe the lid (door) and the inside of the lid (door) seal to remove any moisture.

- Leave the lid (door) open to dry the tub interior.
- Wipe the body of the washer with a dry cloth to remove any moisture.

### Cleaning the Exterior

Proper care of your washer can extend its life.

#### Lid (Door):

Wash with a damp cloth on the outside and inside and then dry with a soft cloth.

#### Exterior:

- Immediately wipe off any spills.
- Wipe with a damp cloth.
- Do not touch the surface or the display with sharp objects.

### Care and Cleaning of the Interior

- Use a towel or soft cloth to wipe around the washer lid (door) opening and lid (door) glass.
- Always remove items from the washer as soon as the cycle is complete. Leaving damp items in the washer can cause wrinkling, color transfer, and odor.
- Run the Tub Clean cycle once a month, or more often if needed, to remove detergent buildup and other residue.

### Cleaning the Tub

Over time, residue may build up in the tub, leading to mildew or a musty odor. Run the Tub Clean cycle monthly to remove residue and prevent odor. Run the cycle more often under heavy use conditions or if odor is already present.

- 1 Remove any clothing from the tub.
- 2 Add cleaning agents.

Cleaner	Instructions
Tub cleaner	Follow manufacturer's recommendations.
Lime scale remover	
Liquid chlorine bleach	Add to main wash liquid detergent dispenser.
Powdered cleaner	Follow manufacturer's recommendations.
Cleaning tablets	Place directly into washer tub.

- For other tub cleaning products, follow the cleaner manufacturer's instructions and recommendations.
  - Do not exceed the maximum fill line when adding bleach or powdered cleaners. Powdered cleaners may remain in the tub after cleaning.
- 3 Close the lid (door) and press the **Power** button to turn the washer on.
  - 4 Turn the knob or press the cycle buttons to select the **Tub Clean** cycle then press the **Start/Pause** button to begin the cycle.
  - 5 After the cycle ends, open the lid (door) and allow the tub interior to dry completely.

**NOTE**

- Never load laundry while using Tub Clean. The laundry may be damaged or contaminated with cleaning products. Make sure to run the Tub Clean cycle only when the tub is empty.
- Leave the lid (door) open after finishing the laundry, to keep the tub clean.
- Tub Clean should be repeated monthly.
- If mildew or musty smell already exists, run Tub Clean once a week for three consecutive weeks.
- Do not exceed the manufacturer's recommended amount when adding bleach or powdered cleaners. Powdered cleaner may remain in the tub after cleaning.

**Removing Mineral Buildup**

In areas with hard water, mineral scale can form on internal components of the washer. Periodically clean the mineral buildup on the internal components to extend the lifespan of the washer. Use of a water softener is recommended in areas with hard water.

- Use a descaler to remove visible mineral buildup on the washer tub.
- After descaling, always run the Tub Clean cycle before washing clothing.
- Mineral scale and other spots may be removed from the stainless steel tub using a soft cloth soaked in stainless steel cleaner.
- Do not use steel wool or abrasive cleaners.

**Leaving the Lid (Door) Open**

- If the washer will not be used for several days, leave the lid (door) open overnight to allow the tub to dry.

**Cleaning the Dispenser Drawer**

Detergent and fabric softener may build up in the dispenser drawer. Remove the drawer and inserts and check for buildup once or twice a month.

- 1 Remove the drawer by pulling it straight out until it stops. Lift up on the front of the drawer and pull it completely out.

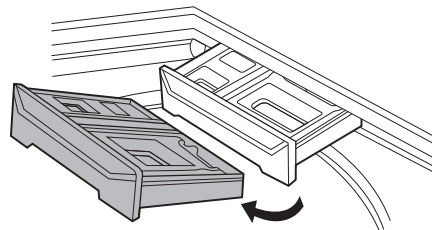

- 2 Remove the inserts from the two compartments.

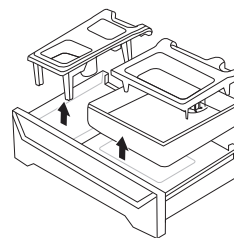

- 3 Clean the inserts and drawer with warm water.
  - Use a soft cloth or brush for cleaning and to remove any residue.

**! WARNING**

- Do not spray water inside the washer. Doing so may cause fire or electric shock.

- 4 Wipe off any moisture with a dry towel or cloth after cleaning.
- 5 To clean the drawer opening, use a small, non-metal brush to clean the recess. Remove all residue from the upper and lower parts of the recess.
- 6 Return the inserts to the proper compartments and replace the drawer.
  - Set the drawer into the opening at an angle, then lower it and slide it into place.

**NOTE**

- If you use a descaler or tub cleaner during the Tub Clean cycle, use the Rinse+Spin option to rinse the washer tub before running your next wash cycle.

## Cleaning the Bleach Dispenser

Bleach may build up on the bleach dispenser cover. Check for buildup and clean the cover once or twice a month.

### Type 1

Remove the cover from the bleach dispenser. Clean the cover and the opening with warm water.

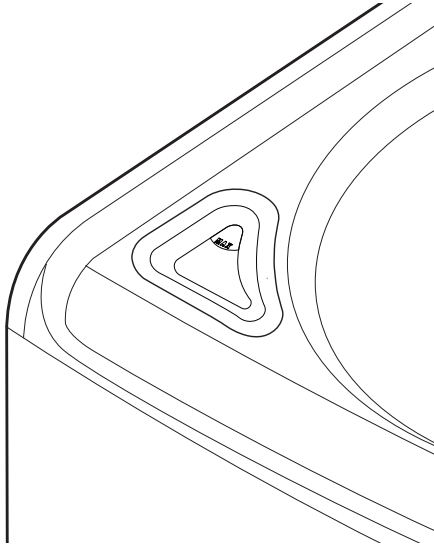

### Type 2

The cover cannot be separated from the dispenser. Clean the cover using a brush and warm water.

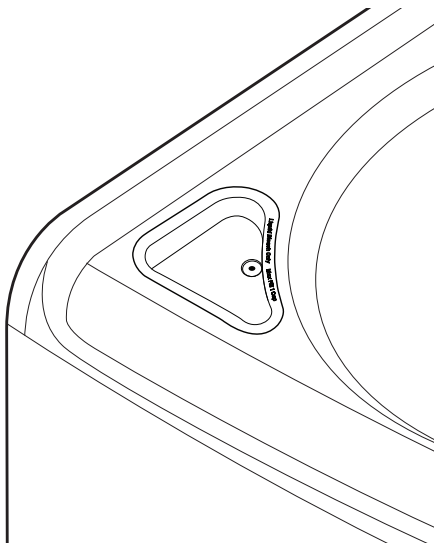

## Cleaning the Water Inlet Filters

If the washer does not fill properly, an error message will show on the display. The inlet valve filter screens could be plugged by hard water scale, sediment in the water supply, or other debris.

### ⚠ CAUTION

- The inlet screens protect the delicate parts of the inlet valve from being damaged by particles that could enter the valves with the water supply. Operating the washer with these filters removed could cause a valve to stick open resulting in flooding and/or property damage.
- Do not use the washer without the inlet filters. If you use the washer without the inlet filters it will cause leaks and malfunction.
- If you use the washer in an area with hard water, the inlet filter may clog due to lime buildup.

- 1 Turn off both water faucets completely.
- 2 Unscrew the hot and cold water hoses from the back of the washer.
- 3 Carefully remove the filters from the water valves.
- 4 Remove foreign objects and soak the filters in white vinegar or a lime scale remover. If using a lime scale remover, follow the manufacturer's instructions. Be careful not to damage the filters while cleaning them.
- 5 Rinse filters thoroughly and press them back into place.
- 6 Flush then reattach the water hoses. Before reattaching the hoses, flush the hoses and water lines by running several gallons of water into a bucket or drain, preferably with the faucets wide open for maximum flow.

### NOTE

- An *!E* message may blink on the display when the water pressure is low or an inlet filter is clogged with dirt. Clean the inlet filter.

## Care in Cold Climates

### Storing the Washer

If the washer will not be used for an extended period of time and is in an area that could be exposed to freezing temperatures, perform the following steps to protect the washer from damage.

Make sure the tub is empty before following these steps.

- 1 Turn off the water supply.
- 2 Disconnect hoses from water supply and drain water from hoses.

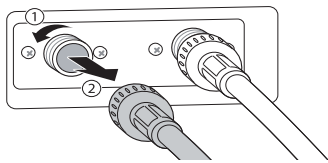

- 3 Plug the power cord into a properly grounded electrical outlet.
- 4 Add 1 gallon of nontoxic recreational vehicle (RV) antifreeze to the empty tub and close the lid (door). Never use automotive antifreeze.
- 5 Press the **Power** button, then select **Spin**.
- 6 Press the **Start/Pause** button to start the drain pump.
- 7 Allow the drain pump to run for one minute, then press the **Power** button to shut off the washer. This will expel some of the antifreeze, leaving enough to protect the washer from damage.
- 8 Unplug the power cord, dry the tub interior with a soft cloth, and close the lid (door).
- 9 Store the washer in an upright position.
- 10 Remove the inserts from the dispenser. Drain any water in the compartments and let them dry.
- 11 To remove the antifreeze from the washer after storage, run a complete Speed Wash cycle using detergent.
  - Do not add laundry to this cycle.

### When the Water Line is Frozen

- 1 Turn off the faucets connected with the water lines.
- 2 Pour hot water on the frozen faucets to thaw the water lines and remove water lines.
- 3 Immerse the water lines in hot water to thaw them.
- 4 Connect the water lines with the water inlets of the washer and with the faucets. See Connecting the Water Lines for details.
- 5 Turn on the faucets.
- 6 Press the **Power** button.
- 7 Press **Special Care** button repeatedly to select the Rinse+Spin cycle.
- 8 Press the **Start/Pause** button. Verify the water fills properly.

### When the Drain Line is Frozen

- 1 Pour hot water in the washer tub and close the lid. Wait for 1-2 hours.
- 2 Press the **Power** button after thawing.
- 3 Press **Special Care** button repeatedly to select the Rinse+Spin cycle.
- 4 Press the **Start/Pause** button. Check to make sure the water drains.



# TROUBLESHOOTING

## Before Calling for Service

The washer is equipped with an automatic error-monitoring system to detect and diagnose problems at an early stage. If the washer does not function properly or does not function at all, check the following before you call for service.

## Noises You Might Hear

Noise	Possible Cause	Solutions
Clicking	Lid (Door) lock relays when the lid (door) locks and unlocks.	• Normal Operation
Spraying or Hissing	Water spraying or circulating during the cycle.	• Normal Operation
Humming or Gurgling	Drain pump is pumping water from the washer at times during a cycle.	• Normal Operation
Water sloshing	A liquid in the balance ring around the wash basket helps the basket spin smoothly.	• Normal Operation
Water being added after the washer has already begun to operate	The washer adapts to the load size and type to add more water to the cycle as needed.	• Normal Operation
	The wash load may be unbalanced. If the washer senses that the load is unbalanced, it will stop and refill to redistribute the load.	
	The washer may be diluting laundry additives to add to the wash load.	
Rattling and clanking noise	Foreign objects, such as keys, coins, or safety pins may be in tub or pump.	• Stop washer, check tub and drain filter for foreign objects. If noise continues after washer is restarted, call for service.
Thumping sound	Heavy wash loads may produce a thumping sound.	• This is normal. If sound continues, washer is probably out of balance. Stop and redistribute wash load.
	Wash load may be out of balance.	• Pause the cycle and redistribute the load after the lid (door) unlocks.
Vibrating noise	Packaging materials were not removed.	• See Unpacking and Removing Shipping Material in the Installation section.
	Wash load may be unevenly distributed in the drum.	• Pause the cycle and redistribute the load after the lid (door) unlocks.
	Not all leveling feet are resting firmly and evenly on the floor.	• See Leveling the Appliance in the Installation section.
	Floor not rigid enough.	• Make sure that the floor is solid and does not flex. See Flooring in the Installation section.
Squeaking noise	Packaging materials were not removed.	• See Unpacking and Removing Shipping Material in the Installation section.
Banging noise when washer is filling with water (Water Hammer)	Plumbing in the home moves or flexes when the water valves in the washer shut off.	• Water hammer is not caused by a defect in the washer. Install water hammer arrestors (purchased separately at hardware or home improvement store) between the fill hose and the washer for best results.
	Household water supply pressure is very high.	• Adjust household water supply regulator to a lower pressure or contact a plumber.

## Operation

Problem	Possible Cause	Solutions
Water leaking	Hoses are not connected correctly.	<ul style="list-style-type: none"> <li>• Check hoses and connectors for leaks, cracks and splits.</li> <li>• Check and tighten hose connections.</li> </ul>
	House drain pipes are clogged.	<ul style="list-style-type: none"> <li>• The washer pumps out water very rapidly. Check for water backing up out of the drain pipe during drain. If water is seen coming out of the drain, check for proper drain hose installation and check for restrictions in the drain. Contact a plumber to repair drain pipe.</li> </ul>
	Drain hose has come out of drain connector or is not inserted far enough.	<ul style="list-style-type: none"> <li>• Tie drain hose to inlet hose or standpipe to prevent it from coming out during drain. For smaller drain pipes, insert the drain hose into the pipe as far as the drain hose flange. For larger drain pipes, insert the drain hose into the pipe 1-2 inches past the flange.</li> </ul>
	A large item such as a pillow or blanket is above the top of the tub.	<ul style="list-style-type: none"> <li>• Use the Bedding cycle for large or bulky items. Use extra care and never wash more than half a load of items that float, such as pillows.</li> <li>• Stop the washer and check the load. Make sure the load does not crest above the top edge of the tub.</li> </ul>
	Oversudsing of detergent.	<ul style="list-style-type: none"> <li>• Oversudsing may create leaks, and may be caused by the type and amount of detergent used. High-Efficiency detergent is the only detergent recommended. The normal amount of detergent to use is 1/4 to 1/2 of the maximum amount recommended by the detergent manufacturer. Always reduce the amount of detergent if the load is small or lightly soiled, or if the water is very soft. Never use more than the maximum amount recommended by the detergent manufacturer.</li> </ul>
Water leaks every load.	Hoses are not installed correctly.	<ul style="list-style-type: none"> <li>• Check all fill and drain hose connections to ensure that they are tight and secure.</li> </ul>
Excessive sudsing	Too much detergent or incorrect detergent.	<ul style="list-style-type: none"> <li>• HE detergents are formulated specifically for High-Efficiency washers and contain suds-reducing agents. Only use detergent with the High-Efficiency (HE) logo.</li> <li>• For detergent quantities refer to the Detergent Use section. If sudsing or detergent residue continue to be an issue, add an extra rinse.</li> </ul>
Washer will not turn on.	Power cord is not properly plugged in.	<ul style="list-style-type: none"> <li>• Make sure that the plug is plugged securely into a grounded, 3-prong, 120-VAC, 60 Hz outlet.</li> </ul>
	House fuse is blown, circuit breaker has tripped, or power outage has occurred.	<ul style="list-style-type: none"> <li>• Reset circuit breaker or replace fuse. Do not increase fuse capacity. If the problem is a circuit overload, have it corrected by a qualified electrician.</li> </ul>

Problem	Possible Cause	Solutions
Wash cycle time is longer than usual.	The washer automatically adjusts the wash time for the amount of laundry, water pressure and other operating conditions.	<ul style="list-style-type: none"> <li>This is normal. The washer adjusts cycle time automatically to provide optimal results for the selected cycle. The time remaining shown in the display is only an estimate. Actual time may vary.</li> </ul>
Incomplete or no dispensing of detergent	Detergent compartments clogged from incorrect filling.	<ul style="list-style-type: none"> <li>Make sure that detergent and additives are put into the correct dispenser compartments. For all detergent types, always make sure that the dispenser drawer is fully closed before the start of the cycle.</li> </ul>
	Too much detergent used.	<ul style="list-style-type: none"> <li>Make sure that the suggested amount of detergent is used per the manufacturer's recommendations. You may also dilute the detergent with water to the maximum fill line on the compartment to avoid clogging. Use only HE (High-Efficiency) detergent. <b>NOTE:</b> Always use as little detergent as possible. High-Efficiency washers need very little detergent to achieve optimum results. Using too much detergent will cause poor wash and rinse performance and may contribute to odors in washer.</li> </ul>
	Insufficient water supply.	<ul style="list-style-type: none"> <li>Make sure that both hot and cold water faucets are turned on all the way.</li> </ul>
	Normal residue.	<ul style="list-style-type: none"> <li>It is normal for a small amount of detergent to remain in the dispenser. If this residue builds up it can interfere with normal dispensing of products. Refer to the cleaning instructions.</li> </ul>
Washer will not operate.	Control panel has powered off due to inactivity.	<ul style="list-style-type: none"> <li>This is normal. Press the <b>Power</b> button to turn the washer on.</li> </ul>
	Washer is unplugged.	<ul style="list-style-type: none"> <li>Make sure cord is plugged securely into a working outlet.</li> </ul>
	Water supply is turned off.	<ul style="list-style-type: none"> <li>Turn both hot and cold faucets fully on.</li> </ul>
	Controls are not set properly.	<ul style="list-style-type: none"> <li>Make sure the cycle was set correctly, close the lid (door) and press the <b>Start/Pause</b> button.</li> </ul>
	Lid (Door) is open.	<ul style="list-style-type: none"> <li>The washer will not operate if the lid (door) is open. Close the lid (door) and make sure that nothing is caught under the lid (door) preventing it from closing completely.</li> </ul>
	Circuit breaker/fuse is tripped/blown.	<ul style="list-style-type: none"> <li>Check house circuit breakers/fuses. Replace fuses or reset breaker. The washer should be on a dedicated branch circuit. The washer will resume the cycle where it stopped once power is restored.</li> </ul>
	Control needs to be reset.	<ul style="list-style-type: none"> <li>Press the <b>Power</b> button, then re-select the desired cycle and press the <b>Start/Pause</b> button.</li> </ul>
	Start/Pause was not pressed after a cycle was set.	<ul style="list-style-type: none"> <li>Press the <b>Power</b> button then re-select the desired cycle and press the <b>Start/Pause</b> button. The washer will shut off if the <b>Start/Pause</b> button is not pressed within 60 minutes.</li> </ul>
	Extremely low water pressure.	<ul style="list-style-type: none"> <li>Check another faucet in the house to make sure that household water pressure is adequate.</li> </ul>
Washer is too cold.	<ul style="list-style-type: none"> <li>If the washer has been exposed to temperatures below freezing for an extended period of time, allow it to warm up before pressing the <b>Power</b> button. Otherwise, the display will not come on.</li> </ul>	

Problem	Possible Cause	Solutions
<b>Washer is not filling properly.</b>	<b>Filter clogged.</b>	<ul style="list-style-type: none"> <li>• Make sure the inlet filters on the fill valves are not clogged. Refer to the filter cleaning instructions.</li> </ul>
	<b>Inlet hoses may be kinked.</b>	<ul style="list-style-type: none"> <li>• Check that inlet hoses are not kinked or clogged.</li> </ul>
	<b>Energy efficiency</b>	<ul style="list-style-type: none"> <li>• This is a High-Efficiency (HE) washer. As a result, the water level settings for this washer may be different than for conventional washers.</li> </ul>
	<b>Insufficient water supply</b>	<ul style="list-style-type: none"> <li>• Make sure that both hot and cold water faucets are turned on all the way.</li> </ul>
	<b>The washer lid (door) is open.</b>	<ul style="list-style-type: none"> <li>• The washer will not operate if the lid (door) is open. Close the lid (door) and make sure that nothing is caught under the lid (door) preventing it from closing completely.</li> </ul>
	<b>Water level is too low.</b>	<ul style="list-style-type: none"> <li>• The water will not normally cover the clothes. The fill level is optimized for the wash motion to achieve the best wash performance.</li> </ul>
<b>Water in the washer does not drain or drains slowly.</b>	<b>Drain hose is kinked, pinched, or clogged.</b>	<ul style="list-style-type: none"> <li>• Make sure the drain hose is free of clogs, kinks, etc., and is not pinched behind or under the washer.</li> </ul>
	<b>Drain discharge is more than 96 inches (2.4 m) above bottom of washer.</b>	<ul style="list-style-type: none"> <li>• Move the end of the drain hose so it's lower than 96 inches (2.4 m) above the bottom of the washer.</li> </ul>
<b>Bleach does not dispense</b>	<b>Bleach dispenser cover is not properly installed.</b>	<ul style="list-style-type: none"> <li>• Make sure that the bleach cover is properly installed and snapped into place before the beginning of the cycle.</li> </ul>
	<b>Bleach dispenser is dirty or clogged.</b>	<ul style="list-style-type: none"> <li>• Lift out the bleach dispenser cover and clean out the reservoir. Lint and other foreign debris that collects in the inside the dispenser may prevent proper dispensing of the bleach.</li> </ul>
<b>Premature dispensing of bleach</b>	<b>Bleach dispenser filled for future load.</b>	<ul style="list-style-type: none"> <li>• You cannot store bleach in the dispenser for future use. The bleach will be dispensed every load.</li> </ul>
	<b>Overfilling the bleach dispenser.</b>	<ul style="list-style-type: none"> <li>• Overfilling the bleach dispenser will cause the bleach to dispense immediately, which will damage the laundry or the washer. Always measure bleach, but never fill above the max line on the dispenser. A half cup of bleach is sufficient for most loads. Never use more than 1 cup of bleach.</li> </ul>





## Performance





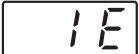

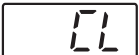

Problem	Possible Cause	Solutions
Wrinkling	Washer not unloaded promptly.	<ul style="list-style-type: none"> <li>Always remove items from the washer as soon as the cycle is complete.</li> </ul>
	Washer overloaded.	<ul style="list-style-type: none"> <li>The washer can be fully loaded, but the tub should not be tightly packed with items. The lid (door) of the washer should close easily.</li> </ul>
	Hot and cold water inlet hoses are reversed.	<ul style="list-style-type: none"> <li>Hot water rinse can set wrinkles in garments. Check the inlet hose connections.</li> </ul>
Staining	Bleach or softener dispensed too soon.	<ul style="list-style-type: none"> <li>Dispenser compartment is overfilled causing bleach or softener to dispense immediately. Always measure bleach to prevent overfilling one cup maximum.</li> <li>Dispenser drawer closed too quickly causing softener to dispense immediately.</li> </ul>
	Bleach or softener was added directly to the wash load in the tub.	<ul style="list-style-type: none"> <li>Always use the dispensers to ensure that laundry products are properly dispensed at the right time in the cycle.</li> </ul>
	Washer was not unloaded promptly.	<ul style="list-style-type: none"> <li>Always remove items from the washer as soon as possible after the cycle is complete.</li> </ul>
	Clothes were not properly sorted.	<ul style="list-style-type: none"> <li>Always wash dark colors separately from light colors and whites to prevent discoloration.</li> <li>Never wash heavily soiled items with lightly soiled items.</li> </ul>
Poor stain removal	Proper options not selected.	<ul style="list-style-type: none"> <li>Heavier soils and tougher stains may require extra cleaning power. Select the <b>Soak</b> or <b>Stain Care</b> feature to boost the cleaning power of the selected cycle.</li> </ul>
	Previously set stains.	<ul style="list-style-type: none"> <li>Articles that have previously been washed may have stains that have been set. These stains may be difficult to remove and may require hand washing or pre-treating to aid in stain removal.</li> </ul>
Musty or mildewy odor in washer	Incorrect or too much detergent has been used.	<ul style="list-style-type: none"> <li>Use only High-Efficiency (HE) detergent in accordance with the manufacturer's instructions.</li> </ul>
	Inside of tub was not cleaned properly.	<ul style="list-style-type: none"> <li>Run the Tub Clean cycle regularly.</li> </ul>

**Wi-Fi (For the product that contains the wireless LAN module)**

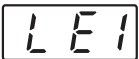
Problem	Possible Cause	Solutions
Trouble connecting appliance and smartphone to Wi-Fi network	The password for the Wi-Fi network was entered incorrectly.	<ul style="list-style-type: none"><li>• Delete your home Wi-Fi network and begin the registration process again.</li></ul>
	Mobile data for your smartphone is turned on.	<ul style="list-style-type: none"><li>• Turn off the <b>Mobile data</b> on your smartphone before registering the appliance.</li></ul>
	The wireless network name (SSID) is set incorrectly.	<ul style="list-style-type: none"><li>• The wireless network name (SSID) should be a combination of English letters and numbers. (Do not use special characters.)</li></ul>
	The router frequency is not 2.4 GHz.	<ul style="list-style-type: none"><li>• Only a 2.4 GHz router frequency is supported. Set the wireless router to 2.4 GHz and connect the appliance to the wireless router. To check the router frequency, check with your Internet service provider or the router manufacturer.</li></ul>
	The distance between the appliance and the router is too far.	<ul style="list-style-type: none"><li>• If the appliance is too far from the router, the signal may be weak and the connection may not be configured correctly. Move the router closer to the appliance or purchase and install a Wi-Fi repeater.</li></ul>

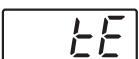
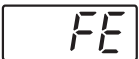
## Error Codes

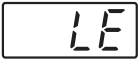
Problem	Possible Cause	Solutions
	If the balance is not successful, this error will be displayed.	<ul style="list-style-type: none"> <li>The automatic attempt to rebalance the load was not successful. The cycle has been paused to allow the load to be manually adjusted.</li> </ul>
	The load is too small.	<ul style="list-style-type: none"> <li>Small loads may need additional items to be added to allow the washer to balance the load.</li> </ul>
	Heavy articles are mixed with lighter items.	<ul style="list-style-type: none"> <li>The load may have heavy items loaded with lighter items. Always try to wash articles of somewhat similar weight to allow the washer to evenly distribute the weight of the load for spinning.</li> </ul>
	The load is out of balance.	<ul style="list-style-type: none"> <li>Manually redistribute the load if articles have become tangled preventing the automatic rebalancing from working properly.</li> </ul>
	Water supply faucets are not fully open.	<ul style="list-style-type: none"> <li>Make sure that the water faucets are fully open.</li> </ul>
	Water line hoses are kinked, pinched, or crushed.	<ul style="list-style-type: none"> <li>Make sure that the hoses are not kinked or pinched. Be careful when moving the washer.</li> </ul>
	Water inlet filters are clogged.	<ul style="list-style-type: none"> <li>Clean the inlet filters. See Maintenance section.</li> </ul>
	Water supply pressure to faucet or house is too low.	<ul style="list-style-type: none"> <li>Check another faucet in the house to make sure that household water pressure is adequate and flow is not restricted. Disconnect the inlet hose from the washer and run a few gallons of water through the hose to flush the water supply lines. If flow is too low, contact a plumber to have the water lines repaired.</li> </ul>
	Water supply connected with leak-limiting hoses.	<ul style="list-style-type: none"> <li>Hoses designed to limit leaks can trip falsely and prevent the washer from filling. The use of leak limiting hoses is not recommended.</li> </ul>
	Drain hose is kinked, pinched, or clogged.	<ul style="list-style-type: none"> <li>Make sure the drain hose is free of clogs or kinks and is not pinched behind or under the washer.</li> </ul>
	Drain discharge is more than 96 inches (2.4 m) above bottom of washer.	<ul style="list-style-type: none"> <li>Move the end of the drain hose so it's lower than 96 inches (2.4 m) above the bottom of the washer.</li> </ul>
	The Control Lock function is on to prevent anyone from changing cycles or operating the appliance.	<ul style="list-style-type: none"> <li>Turn off Control Lock in the control panel. See Control Lock under Option Buttons.</li> </ul>
	Special drain feature	<ul style="list-style-type: none"> <li>If the washer is paused during a cycle for more than 4 minutes, the cycle will be cancelled and any water remaining in the tub will be drained.</li> <li>This is not an error code. It indicates that the drain function is operating.</li> </ul>

Problem	Possible Cause	Solutions
	Lid (Door) is not closed properly.	<ul style="list-style-type: none"> <li>Close the lid (door) and press <b>Start/Pause</b> button. After starting a cycle, it may take a few moments before the tub begins to turn or spin. The washer will not spin unless the lid (door) is locked.</li> <li>If the error persists once the lid (door) is closed and the <b>Start/Pause</b> button is pressed, call for service.</li> </ul>
	Lid (Door) lock switch error.	<ul style="list-style-type: none"> <li>Make sure that the lid (door) is closed properly and press the <b>Start/Pause</b> button. The washer will not operate unless the lid (door) is locked.</li> <li>Make sure that nothing is caught under the lid (door), including shipping material or clothing.</li> <li>Make sure that the latch mechanism is fully retracted.</li> <li>If the lid (door) is closed and the lid (door) lock error message is displayed, call for service.</li> </ul>
	Foreign objects such as coins, pins, clips, etc., caught between the wash plate and the inner basket.	<ul style="list-style-type: none"> <li>Turn the washer off then on again. Press the Spin button without selecting a cycle to drain and spin the load.</li> <li>When the Spin cycle is complete, empty the tub and find and remove any objects caught in the wash plate.</li> <li>Always check pockets, etc., before washing to prevent error codes or damage to the washer or clothing.</li> </ul>
	It is time to run the Tub Clean cycle.	<ul style="list-style-type: none"> <li>Run the Tub Clean cycle.</li> </ul>
	The washer has detected an out of balance load.	<ul style="list-style-type: none"> <li>If the washer detects a load that is too far out of balance to spin, it will display this code while it is attempting to rebalance the load. The washer will add water and try to redistribute the load automatically. This display is for your information only, and no action is required.</li> <li>As a result, the cycle will take longer than initially estimated.</li> </ul>
	Control error.	<ul style="list-style-type: none"> <li>Unplug the washer and wait 60 seconds. Reconnect power and try again. If the error reappears, call for service.</li> </ul>
	Water level is too high due to a faulty water valve.	<ul style="list-style-type: none"> <li>Close the water faucets, unplug the washer, and call for service.</li> </ul>
	The water level sensor is not working correctly.	<ul style="list-style-type: none"> <li>Close the water faucets, unplug the washer, and call for service.</li> </ul>
	A motor error has occurred.	<ul style="list-style-type: none"> <li>Allow the washer to stand for 30 minutes and then restart the cycle. If the LE error code persists, call for service.</li> </ul>
	Clutch error	<ul style="list-style-type: none"> <li>Mechanical failure</li> <li>Unplug the washer and call for service.</li> </ul>



# LIMITED WARRANTY

## FOR USA

ENGLISH

**ARBITRATION NOTICE: THIS LIMITED WARRANTY CONTAINS AN ARBITRATION PROVISION THAT REQUIRES YOU AND LG TO RESOLVE DISPUTES BY BINDING ARBITRATION INSTEAD OF IN COURT, UNLESS YOU CHOOSE TO OPT OUT. IN ARBITRATION, CLASS ACTIONS AND JURY TRIALS ARE NOT PERMITTED. PLEASE SEE THE SECTION TITLED "PROCEDURE FOR RESOLVING DISPUTES" BELOW.**

Should your LG Washer fail due to a defect in materials or workmanship under normal home use, during the warranty period set forth below, LG will at its option repair or replace the product. This limited warranty is valid only to the original retail purchaser of the product and applies only when purchased and used within the United States, including U.S. Territories. Proof of original retail purchase is required to obtain warranty service under this limited warranty.

Warranty Period	Scope of Warranty	Remark
One (1) year from date of original retail purchase	Any internal / functional Parts and Labor	LG will provide parts and labor to repair or replace defective parts.
Three (3) years from date of original retail purchase	Stainless Steel Tub	Parts only. Customer will be responsible for any labor or in-home service to replace defective parts.
Ten (10) years from date of original retail purchase	Tub Motor (Stator, Rotor)	

- Replacement products and parts are warranted for the remaining portion of the original warranty period or ninety (90) days, whichever is greater.
- Replacement products and parts may be new or remanufactured.

**THIS WARRANTY IS IN LIEU OF ANY OTHER WARRANTY, EXPRESS OR IMPLIED, INCLUDING WITHOUT LIMITATION, ANY WARRANTY OF MERCHANTABILITY OR FITNESS FOR A PARTICULAR PURPOSE. TO THE EXTENT ANY IMPLIED WARRANTY IS REQUIRED BY LAW, IT IS LIMITED IN DURATION TO THE EXPRESS WARRANTY PERIOD ABOVE. NEITHER THE MANUFACTURER NOR ITS U.S. DISTRIBUTOR SHALL BE LIABLE FOR ANY INCIDENTAL, CONSEQUENTIAL, INDIRECT, SPECIAL, OR PUNITIVE DAMAGES OF ANY NATURE, INCLUDING WITHOUT LIMITATION, LOST REVENUES OR PROFITS, OR ANY OTHER DAMAGE WHETHER BASED IN CONTRACT, TORT, OR OTHERWISE.**

Some states do not allow the exclusion or limitation of incidental or consequential damages or limitations on how long an implied warranty lasts, so the above exclusion or limitation may not apply to you. This warranty gives you specific legal rights and you may also have other rights that vary from state to state.

### THIS LIMITED WARRANTY DOES NOT COVER:

- Service trips to deliver, pick up, or install or repair the product; instruction to the customer on operation of the product; repair or replacement of fuses or correction of wiring or plumbing, or correction of unauthorized repairs/installation.
- Failure of the product to perform during power failures and interrupted or inadequate electrical service.
- Damage caused by leaky or broken water pipes, frozen water pipes, restricted drain lines, inadequate or interrupted water supply or inadequate supply of air.
- Damage resulting from operating the product in a corrosive atmosphere or contrary to the instructions outlined in the product's owner's manual.
- Damage to the product caused by accidents, pests and vermin, lightning, wind, fire, floods, or acts of God.
- Damage or failure caused by unauthorized modification or alteration, or if it is used for other than the intended purpose, or any water leakage where the unit was not properly installed.

## 34 LIMITED WARRANTY

- Damage or failure caused by incorrect electrical current, voltage, or plumbing codes, commercial or industrial use, or use of accessories, components, or consumable cleaning products that are not approved by LG.
- Damage caused by transportation and handling, including scratches, dents, chips, and/or other damage to the finish of your product, unless such damage results from defects in materials or workmanship and is reported within one (1) week of delivery.
- Damage or missing items to any display, open box, discounted, or refurbished product.
- Products with original serial numbers that have been removed, altered, or cannot be readily determined. Model and serial numbers, along with original retail sales receipts, are required for warranty validation.
- Increases in utility costs and additional utility expenses.
- Repairs when your product is used for other than normal and usual household use (e.g. commercial use, in offices and recreational facilities) or contrary to the instructions outlined in the product's owner's manual.
- Costs associated with removal of your product from your home for repairs.
- The removal and reinstallation of the product if it is installed in an inaccessible location or is not installed in accordance with published installation instructions, including LG's owner's and installation manuals.
- Damage resulting from misuse, abuse, improper installation, repair, or maintenance. Improper repair includes use of parts not approved or specified by LG.

**The cost of repair or replacement under these excluded circumstances shall be borne by the consumer.**

TO OBTAIN WARRANTY SERVICE AND ADDITIONAL INFORMATION

For additional product information, visit the LG website at <http://www.lg.com>

For assistance using this product or to schedule service, contact LG Electronics at 1-800-243-0000.

For further assistance, write: LG Electronics, 201 James Record Road, Huntsville, Alabama 35813

### PROCEDURE FOR RESOLVING DISPUTES:

ALL DISPUTES BETWEEN YOU AND LG ARISING OUT OF OR RELATING IN ANY WAY TO THIS LIMITED WARRANTY OR THE PRODUCT SHALL BE RESOLVED EXCLUSIVELY THROUGH BINDING ARBITRATION, AND NOT IN A COURT OF GENERAL JURISDICTION. BINDING ARBITRATION MEANS THAT YOU AND LG ARE EACH WAIVING THE RIGHT TO A JURY TRIAL AND TO BRING OR PARTICIPATE IN A CLASS ACTION.

**Definitions.** For the purposes of this section, references to "LG" mean LG Electronics U.S.A., Inc., its parents, subsidiaries and affiliates, and each of their officers, directors, employees, agents, beneficiaries, predecessors in interest, successors, assigns and suppliers; references to "dispute" or "claim" shall include any dispute, claim or controversy of any kind whatsoever (whether based in contract, tort, statute, regulation, ordinance, fraud, misrepresentation or any other legal or equitable theory) arising out of or relating in any way to the sale, condition or performance of the product or this Limited Warranty.

**Notice of Dispute.** In the event you intend to commence an arbitration proceeding, you must first notify LG in writing at least 30 days in advance of initiating the arbitration by sending a letter to LG at LG Electronics, USA, Inc. Attn: Legal Department- Arbitration 1000 Sylvan Ave, Englewood Cliffs 07632. You and LG agree to engage in good faith discussions in an attempt to amicably resolve your claim. The notice must provide your name, address, and telephone number; identify the product that is the subject of the claim; and describe the nature of the claim and the relief being sought. If you and LG are unable to resolve the dispute within 30 days, either party may proceed to file a claim for arbitration.

**Agreement to Binding Arbitration and Class Action Waiver.** Upon failure to resolve the dispute during the 30 day period after sending written notice to LG, you and LG agree to resolve any claims between us only by binding arbitration on an individual basis, unless you opt out as provided below. Any dispute between you and LG shall not be combined or consolidated with a dispute involving any other person's or entity's product or claim. More specifically, without limitation of the foregoing, any dispute between you and LG shall not under any circumstances proceed as part of a class or representative action. Instead of arbitration, either party may bring an individual action in small claims court, but that small claims court action may not be brought on a class or representative basis.

**Arbitration Rules and Procedures.** To begin arbitration of a claim, either you or LG must make a written demand for arbitration. The arbitration will be administered by the American Arbitration Association (“AAA”) and will be conducted before a single arbitrator under the AAA’s Consumer Arbitration Rules that are in effect at the time the arbitration is initiated (referred to as the “AAA Rules”) and under the procedures set forth in this section. The AAA Rules are available online at [www.adr.org/consumer](http://www.adr.org/consumer). Send a copy of your written demand for arbitration, as well as a copy of this provision, to the AAA in the manner described in the AAA Rules. You must also send a copy of your written demand to LG at LG Electronics, USA, Inc. Attn: Legal Department- Arbitration 1000 Sylvan Avenue Englewood Cliffs, NJ 07632. If there is a conflict between the AAA Rules and the rules set forth in this section, the rules set forth in this section will govern. This arbitration provision is governed by the Federal Arbitration Act. Judgment may be entered on the arbitrator’s award in any court of competent jurisdiction. All issues are for the arbitrator to decide, except that issues relating to the scope and enforceability of the arbitration provision and to the arbitrability of the dispute are for the court to decide. The arbitrator is bound by the terms of this provision.

**Governing Law.** The law of the state of your residence shall govern this Limited Warranty and any disputes between us except to the extent that such law is preempted by or inconsistent with applicable federal law.

**Fees/Costs.** You do not need to pay any fee to begin an arbitration. Upon receipt of your written demand for arbitration, LG will promptly pay all arbitration filing fees to the AAA unless you seek more than \$25,000 in damages, in which case the payment of these fees will be governed by the AAA Rules. Except as otherwise provided for herein, LG will pay all AAA filing, administration and arbitrator fees for any arbitration initiated in accordance with the AAA Rules and this arbitration provision. If you prevail in the arbitration, LG will pay your attorneys’ fees and expenses as long as they are reasonable, by considering factors including, but not limited to, the purchase amount and claim amount. Notwithstanding the foregoing, if applicable law allows for an award of reasonable attorneys’ fees and expenses, an arbitrator can award them to the same extent that a court would. If the arbitrator finds either the substance of your claim or the relief sought in the demand is frivolous or brought for an improper purpose (as measured by the standards set forth in Federal Rule of Civil Procedure 11(b)), then the payment of all arbitration fees will be governed by the AAA Rules. In such a situation, you agree to reimburse LG for all monies previously disbursed by it that are otherwise your obligation to pay under the AAA Rules. Except as otherwise provided for, LG waives any rights it may have to seek attorneys’ fees and expenses from you if LG prevails in the arbitration.

**Hearings and Location.** If your claim is for \$25,000 or less, you may choose to have the arbitration conducted solely on the basis of (1) documents submitted to the arbitrator, (2) through a telephonic hearing, or (3) by an in-person hearing as established by the AAA Rules. If your claim exceeds \$25,000, the right to a hearing will be determined by the AAA Rules. Any in-person arbitration hearings will be held at a location within the federal judicial district in which you reside unless we both agree to another location or we agree to a telephonic arbitration.

**Opt Out.** You may opt out of this dispute resolution procedure. If you opt out, neither you nor LG can require the other to participate in an arbitration proceeding. To opt out, you must send notice to LG no later than 30 calendar days from the date of the first consumer purchaser’s purchase of the product by either: (i) sending an e-mail to [optout@lge.com](mailto:optout@lge.com), with the subject line: “Arbitration Opt Out” or (ii) calling 1-800-980-2973. You must include in the opt out e-mail or provide by telephone: (a) your name and address; (b) the date on which the product was purchased; (c) the product model name or model number; and (d) the serial number (the serial number can be found (i) on the product; or (ii) online by accessing <https://www.lg.com/us/support/repair-service/schedule-repair-continued> and clicking on “Find My Model & Serial Number”).

You may only opt out of the dispute resolution procedure in the manner described above (that is, by e-mail or telephone); no other form of notice will be effective to opt out of this dispute resolution procedure. Opting out of this dispute resolution procedure will not affect the coverage of the Limited Warranty in any way, and you will continue to enjoy the full benefits of the Limited Warranty. If you keep this product and do not opt out, then you accept all terms and conditions of the arbitration provision described above.

## Warranty Exceptions (U.S.)

### The packing materials are not removed.

Noise, vibration

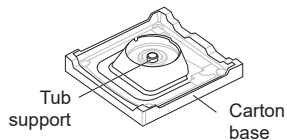

Remove the packing materials.

### A coin or foreign object is stuck in the washer.

E6 error, the tub won't spin, noise



Remove coins or foreign objects from the laundry before loading.

### The drain hose is installed too low.

IE error, failure to fill with water, draining during fill

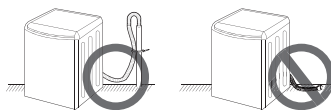

Reinstall the drain hose properly.

### The water inlet valve filters are clogged or the water inlet hoses are kinked.

Water is not coming.

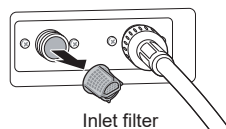

Clean the inlet valve filter or reinstall the water inlet hoses.

### The inlet hoses are installed in reverse.

Laundry is hot, warm or wrinkled after finished washing.

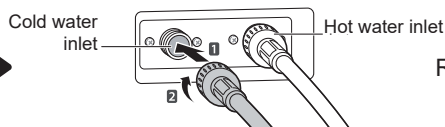

Reinstall the inlet hoses.

### The water tap is not turned on.

Water is not supplied.

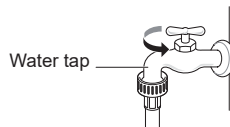

Turn on the water tap.

### Improper installation of water inlet hoses or using third party inlet hoses

Leakage

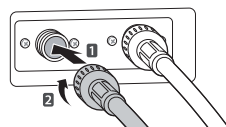

Reinstall the inlet hoses or replace them with approved hoses.

### Loose connection of power cord or electrical outlet problem

No power problem

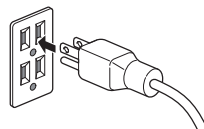

Reconnect the power cord or change the electrical outlet.

### Improper installation or use of product

Service trips to deliver, pick up, install the product or for instruction on product use.

The removal and reinstallation of the product.



The warranty covers manufacturing defects only. Service resulting from improper Installation is not covered.

### Accidents, pests and vermin, lightning, wind, fire, floods, or acts of God

Damage to the product



Service resulting from natural disasters rather than manufacturing defects is not covered by the warranty.



**LG Customer Information Center**

For inquiries or comments,  
visit **www.lg.com** or call:

**1-800-243-0000**<sup>U.S.A.</sup>

**1-888-542-2623**<sup>CANADA</sup>

**Register your product Online!**

**www.lg.com**