

Whirlpool® REFRIGERATOR USER INSTRUCTIONS

THANK YOU for purchasing this high-quality product. Register your new refrigerator at www.whirlpool.com. In Canada, register your refrigerator at www.whirlpool.ca.

For future reference, please make a note of your product model and serial numbers. These can be located on the inside wall of the refrigerator compartment.

Model Number _____

Serial Number _____

Para obtener acceso a "Instrucciones para el usuario del refrigerador" en español, o para obtener información adicional acerca de su producto, visite: www.whirlpool.com.

Necesitará su número de modelo y de serie, ubicado en el interior del compartimiento del refrigerador.

TABLE OF CONTENTS/ TABLE DES MATIÈRES

REFRIGERATOR SAFETY	2	SÉCURITÉ DU RÉFRIGÉRATEUR	20
Proper Disposal of Your Old Refrigerator	3	Mise au rebut du vieux réfrigérateur	22
INSTALLATION INSTRUCTIONS	3	INSTRUCTIONS D'INSTALLATION	22
Unpack the Refrigerator.....	3	Déballage du réfrigérateur.....	22
Location Requirements	4	Exigences d'emplacement.....	23
Electrical Requirements	4	Spécifications électriques	23
Water Supply Requirements	5	Spécifications de l'alimentation en eau	24
Connect the Water Supply.....	5	Raccordement à la canalisation d'eau	24
Refrigerator Doors and Drawer	6	Portes et tiroir du réfrigérateur	25
Adjust the Doors	9	Ajuster les portes	28
REFRIGERATOR USE	9	UTILISATION DU RÉFRIGÉRATEUR	28
Opening and Closing Doors.....	9	Ouverture et fermeture des portes.....	28
Using the Controls	9	Utilisation des commandes	28
Crisper Humidity Control	11	Réglage de l'humidité dans le tiroir à légumes.....	30
Ice Maker and Ice Storage Bin	11	Machine à glaçons et bac d'entreposage à glaçons.....	30
Water and Ice Dispensers.....	11	Distributeurs d'eau et de glaçons.....	31
Water Filtration System.....	12	Système de filtration d'eau	32
REFRIGERATOR CARE	13	ENTRETIEN DU RÉFRIGÉRATEUR	33
Cleaning	13	Nettoyage	33
Changing the Light Bulb(s).....	14	Remplacer l'ampoule d'éclairage	33
TROUBLESHOOTING	14	DÉPANNAGE	34
Refrigerator Operation	14	Fonctionnement du réfrigérateur	34
Temperature and Moisture	15	Température et humidité	35
Ice and Water	15	Glaçons et eau	35
PERFORMANCE DATA SHEETS	17	FEUILLES DE DONNÉES SUR LA PERFORMANCE	37
WARRANTY	19	GARANTIE	39

REFRIGERATOR SAFETY

Your safety and the safety of others are very important.

We have provided many important safety messages in this manual and on your appliance. Always read and obey all safety messages.



This is the safety alert symbol.

This symbol alerts you to potential hazards that can kill or hurt you and others.

All safety messages will follow the safety alert symbol and either the word "DANGER" or "WARNING."

These words mean:

⚠ DANGER

You can be killed or seriously injured if you don't immediately follow instructions.

⚠ WARNING

You can be killed or seriously injured if you don't follow instructions.

All safety messages will tell you what the potential hazard is, tell you how to reduce the chance of injury, and tell you what can happen if the instructions are not followed.

IMPORTANT SAFETY INSTRUCTIONS

WARNING: To reduce the risk of fire, electric shock, or injury when using your refrigerator, follow these basic precautions:

- Plug into a grounded (earthed) outlet.
- Do not remove ground prong.
- Do not use an adapter.
- Do not use an extension cord.
- Disconnect power before servicing.
- Replace all parts and panels before operating.
- Remove doors from your old refrigerator.
- Use nonflammable cleaner.
- Do not store or use petrol, flammable liquids or gas in the vicinity of this or other electrical appliances. The fumes can cause fires or explosions.
- Do not store explosive substances such as aerosol cans with a flammable propellant in this refrigerator.
- Do not use or place electrical devices inside the refrigerator compartments if they are not of the type expressly authorized by the manufacture.
- Use two or more people to move and install refrigerator.
- Disconnect power before installing ice maker (on ice maker kit ready models only).
- A qualified service technician must install the water line and ice maker. See installation instruction supplied with ice maker kit IC13B for complete details.
- Connect to a potable water supply only.
- Use a sturdy glass when dispensing ice (on some models).
- This appliance is not intended for use by persons (including children) with reduced physical, sensory or mental capabilities, or lack of experience and knowledge, unless they have been given supervision or instruction concerning use of the appliance by a person responsible for their safety.
- Children should be supervised to ensure that they do not play with the appliance.
- To avoid the risk of children becoming trapped and suffocating, do not allow them to play or hide inside the refrigerator.
- If the power supply cord is damaged, it must be replaced by the manufacturer or its service agent or a similarly qualified person.

SAVE THESE INSTRUCTIONS

Proper Disposal of Your Old Refrigerator

⚠ WARNING

Suffocation Hazard

**Remove doors from your old refrigerator.
Failure to do so can result in death or brain damage.**

IMPORTANT: Child entrapment and suffocation are not problems of the past. Junked or abandoned refrigerators are still dangerous—even if they will sit for “just a few days.” If you are getting rid of your old refrigerator, please follow these instructions to help prevent accidents.

Before You Throw Away Your Old Refrigerator or Freezer:

- Take off the doors.
- Leave the shelves in place so that children may not easily climb inside.

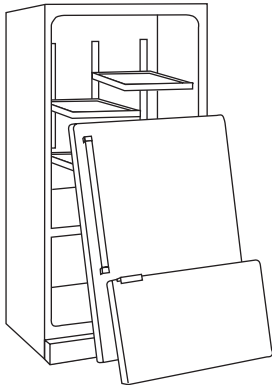

Important information to know about disposal of refrigerants:

Dispose of refrigerator in accordance with Federal and Local regulations. Refrigerants must be evacuated by a licensed, EPA certified refrigerant technician in accordance with established procedures.

INSTALLATION INSTRUCTIONS

Unpack the Refrigerator

⚠ WARNING

Excessive Weight Hazard

Use two or more people to move and install refrigerator.

Failure to do so can result in back or other injury.

Remove the Packaging

- Remove tape and glue residue from surfaces before turning on the refrigerator. Rub a small amount of liquid dish soap over the adhesive with your fingers. Wipe with warm water and dry.
- Do not use sharp instruments, rubbing alcohol, flammable fluids, or abrasive cleaners to remove tape or glue. These products can damage the surface of your refrigerator. For more information, see “Refrigerator Safety.”
- Dispose of/recycle all packaging materials.

When Moving Your Refrigerator:

Your refrigerator is heavy. When moving the refrigerator for cleaning or service, be sure to cover the floor with cardboard or hardboard to avoid floor damage. Always pull the refrigerator straight out when moving it. Do not wiggle or “walk” the refrigerator when trying to move it, as floor damage could occur.

Clean Before Using

After you remove all of the packaging materials, clean the inside of your refrigerator before using it. See the cleaning instructions in “Refrigerator Care.”

Important information to know about glass shelves and covers:

Do not clean glass shelves or covers with warm water when they are cold. Shelves and covers may break if exposed to sudden temperature changes or impact, such as bumping. Tempered glass is designed to shatter into many small, pebble-size pieces. This is normal. Glass shelves and covers are heavy. Use both hands when removing them to avoid dropping.

Location Requirements

⚠ WARNING



Explosion Hazard

Keep flammable materials and vapors, such as gasoline, away from refrigerator.

Failure to do so can result in death, explosion, or fire.

IMPORTANT: This appliances is intended to be used in household and similar applications such as:

- Staff kitchen areas in shops, office and other working environments,
- Farm houses and by clients in hotels, motels and other residential type environments,
- Bed and breakfast type environments,
- Catering and similar non-retail applications.

To ensure proper ventilation for your refrigerator, allow for 1/2" (1.25 cm) of space on each side and at the top. Allow for 1" (2.54 cm) of space behind the refrigerator. If your refrigerator has an ice maker, allow extra space at the back for the water line connections. When installing your refrigerator next to a fixed wall, leave 3 3/4" (9.5 cm) minimum space between the refrigerator and wall to allow the door to swing open.

NOTE: This refrigerator is intended for use in a location where the temperature ranges from a minimum of 55°F (13°C) to a maximum of 110°F (43°C). The preferred room temperature range for optimum performance, which reduces electricity usage and provides superior cooling, is between 60°F (15°C) and 90°F (32°C). It is recommended that you do not install the refrigerator near a heat source, such as an oven or radiator.

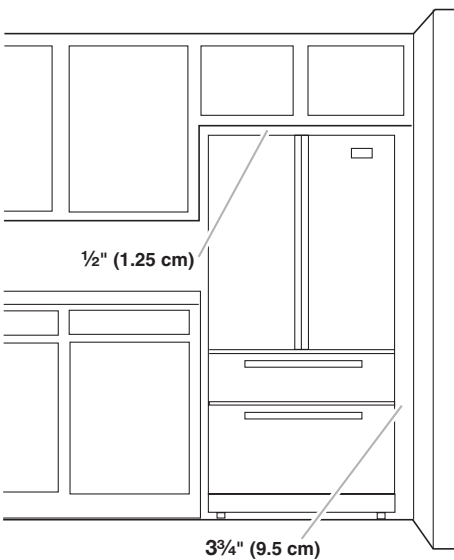

Electrical Requirements

⚠ WARNING



Electrical Shock Hazard

Plug into a grounded 3 prong outlet.

Do not remove ground prong.

Do not use an adapter.

Do not use an extension cord.

Failure to follow these instructions can result in death, fire, or electrical shock.

Before you move your refrigerator into its final location, it is important to make sure you have the proper electrical connection.

If the supply cord is damaged, it must be replaced by the manufacturer or its service agent or a similarly qualified person. Do not use a cord that shows cracks or abrasion damage along its length or at either the plug or connector end.

Recommended Grounding Method

A 115 V, 60 Hz, AC only 15 or 20 A fused, grounded electrical supply is required. It is recommended that a separate circuit serving only your refrigerator and approved accessories be provided. Use an outlet that cannot be turned off by a switch. Do not use an extension cord.

NOTE: Before performing any type of installation, cleaning, or removing a light bulb, turn Cooling OFF, and then disconnect the refrigerator from the electrical source. When you have finished, reconnect the refrigerator to the electrical source and turn Cooling ON. See "Using the Controls."

Water Supply Requirements

Gather the required tools and parts before starting installation. Read and follow the instructions provided with any tools listed here.

TOOLS NEEDED:

- Flat-blade screwdriver
- 1/4" Nut driver
- 7/16" and 1/2" Open-end or two adjustable wrenches
- 1/4" Drill bit
- Cordless drill

IMPORTANT:

- Connect to potable water supply only.

Do not use with water that is microbiologically unsafe or of unknown quality without adequate disinfection before or after the system. Systems certified for cyst reduction may be used on disinfected waters that may contain filterable cysts.

- All installations must meet local plumbing code requirements.
- Do not use a piercing-type or 3/16" (4.76 mm) saddle valve which reduces water flow and clogs more easily.
- Use copper tubing and check for leaks. Install copper tubing only in areas where the household temperatures will remain above freezing.
- For models with water filters, the disposable water filter should be replaced at least every 6 months.

Water Pressure

A cold water supply with water pressure of between 35 and 120 psi (241 and 827 kPa) is required to operate the water dispenser and ice maker. If you have questions about your water pressure, call a licensed, qualified plumber.

Reverse Osmosis Water Supply

IMPORTANT: The pressure of the water supply coming out of a reverse osmosis system going to the water inlet valve of the refrigerator needs to be between 35 and 120 psi (241 and 827 kPa).

If a reverse osmosis water filtration system is connected to your cold water supply, the water pressure to the reverse osmosis system needs to be a minimum of 40 to 60 psi (276 to 414 kPa).

If the water pressure to the reverse osmosis system is less than 40 to 60 psi (276 to 414 kPa):

- Check to see whether the sediment filter in the reverse osmosis system is blocked. Replace the filter if necessary.
- Allow the storage tank on the reverse osmosis system to refill after heavy usage.
- If your refrigerator has a water filter, it may further reduce the water pressure when used in conjunction with a reverse osmosis system. Remove the water filter. See "Water Filtration System."

If you have questions about your water pressure, call a licensed, qualified plumber

Connect the Water Supply

Read all directions before you begin.

IMPORTANT:

- Plumbing shall be installed in accordance with the International Plumbing Code and any local codes and ordinances.
- The gray water tubing on the back of the refrigerator (which is used to connect to the household water line) is a PEX (cross-linked polyethylene) tube. Copper and PEX tubing connections from the household water line to the refrigerator are acceptable and will help avoid off-taste or odor in your ice or water. Check for leaks.

If PEX tubing is used instead of copper, we recommend the following Whirlpool Part Numbers:

W10505928RP (7 ft [2.14 m] jacketed PEX),
8212547RP (5 ft [1.52 m] PEX), or
W10267701RP (25 ft [7.62 m] PEX).

- Install tubing only in areas where temperatures will remain above freezing.
- If you turn on the refrigerator before the water line is connected, turn off the ice maker to avoid excessive noise or damage to the water valve.

Connect to Water Line

1. Unplug refrigerator or disconnect power.
2. Turn OFF main water supply. Turn ON nearest faucet long enough to clear line of water.
3. Find a 1/2" to 1 1/4" (12.7 mm to 31.8 mm) vertical cold water pipe near the refrigerator.

IMPORTANT:

- Make sure it is a cold water pipe.
 - Horizontal pipe will work, but the following procedure must be followed: Drill on the top side of the pipe, not the bottom. This will help keep water away from the drill. This also keeps normal sediment from collecting in the valve.
4. Determine the length of copper tubing you need. Measure from the connection on the lower right rear of the refrigerator to the water pipe. Add 7 ft (2.1 m) to allow for cleaning. Use 1/4" (6.35 mm) O.D. (outside diameter) copper tubing. Be sure both ends of copper tubing are cut square.
 5. Using a cordless drill, drill a 1/4" hole in the cold water pipe you have selected.

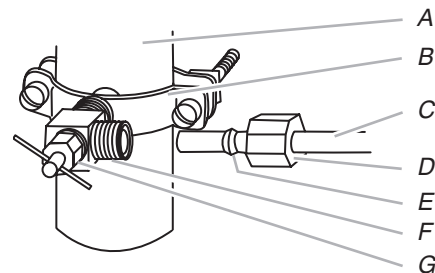

- A. Cold water pipe
- B. Pipe clamp
- C. Copper tubing
- D. Compression nut
- E. Compression sleeve
- F. Shutoff valve
- G. Packing nut

6. Fasten the shutoff valve to the cold water pipe with the pipe clamp. Be sure the outlet end is solidly in the 1/4" drilled hole in the water pipe and that the washer is under the pipe clamp. Tighten the packing nut. Tighten the pipe clamp screws slowly and evenly so the washer makes a watertight seal. Do not overtighten.
7. Slip the compression sleeve and compression nut on the copper tubing as shown. Insert the end of the tubing into the outlet end squarely as far as it will go. Screw compression nut onto outlet end with adjustable wrench. Do not overtighten or you may crush the copper tubing.
8. Place the free end of the tubing in a container or sink, and turn ON the main water supply. Flush the tubing until water is clear. Turn OFF the shutoff valve on the water pipe.

Connect to Refrigerator

1. Remove plastic cap from water valve inlet port. Attach the copper tube to the valve inlet using a compression nut and sleeve as shown. Tighten the compression nut. Do not overtighten. Confirm copper tubing is secure by pulling on the copper tubing.
2. Create a service loop with the copper tubing. Avoid kinks when coiling the copper tubing. Secure copper tubing to the refrigerator cabinet with a "P" clamp.

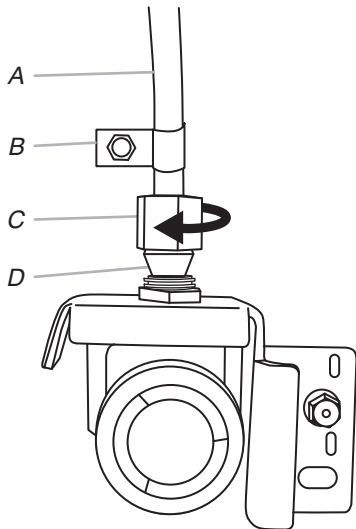

A. Copper tubing
 B. "P" clamp
 C. Compression nut
 D. Compression sleeve

3. Turn on water supply to refrigerator and check for leaks. Correct any leaks.

Complete the Installation

⚠ WARNING



Electrical Shock Hazard

Plug into a grounded 3 prong outlet.

Do not remove ground prong.

Do not use an adapter.

Do not use an extension cord.

Failure to follow these instructions can result in death, fire, or electrical shock.

1. Plug into a grounded 3 prong outlet.

NOTE: Allow 24 hours to produce the first batch of ice. Discard the first three batches of ice produced. Allow 3 days to completely fill the ice container.

Refrigerator Doors and Drawer

All graphics referenced in the following instructions are included later in this section after "Final Steps."

TOOLS NEEDED: 5/16", 3/8", 1/4" hex head socket wrench, #2 Phillips screwdriver, and a flat-blade screwdriver.

IMPORTANT:

- Your refrigerator may have a standard reversible refrigerator door with either a freezer door or freezer drawer or French doors. Follow the instructions specific to the door style of your model.
- All graphics referenced in the following instructions are included later in this section after "Final Steps." The graphics shown for the standard door are for a right-hand swing refrigerator (hinges factory installed on the right).
- If you only want to remove and replace the doors, see "Remove Door(s) and Hinges" and "Replace Door(s) and Hinges."
- Before you begin, turn the refrigerator control off and remove food and adjustable door or utility bins from the doors.

Remove and Replace Handles

- Using a 3/32" or 1/8" hex key, loosen the two setscrews located on the side of each handle. Pull the handle straight out from the door. Make sure you keep the screws for reattaching the handles. See Style 1 Handle, graphic 1.
- To replace the handles, reverse the directions.

Remove Doors and Hinges

IMPORTANT: Remove food and any adjustable door or utility bins from doors.

WARNING



Electrical Shock Hazard

Disconnect power before removing doors.

Failure to do so can result in death or electrical shock.

1. Unplug refrigerator or disconnect power.
2. Keep the refrigerator doors closed until you are ready to lift them free from the cabinet.
NOTE: Provide additional support for the refrigerator door while the hinges are being removed. Do not depend on the door gasket magnets to hold the door in place while you are working.
3. Starting with the right-hand side door, remove the parts for the top hinge as shown in Top Hinges graphic. Lift the refrigerator door from the bottom hinge pin.
4. Remove top hinge cover from left side refrigerator door.
5. Disconnect the wiring plug located on top of the hinge by wedging a flat-blade screwdriver or your fingernail between the two sections. See Connections graphic.
6. Disconnect the water line by pulling back on the locking collar while pulling the water line out of the water line connector. See Connections graphic.
7. Remove the parts for the top hinge as shown in Top Hinges graphic. Lift the left-hand side door from the bottom hinge pin.
8. Remove the base grille. Grasp the grille firmly and pull it toward you.

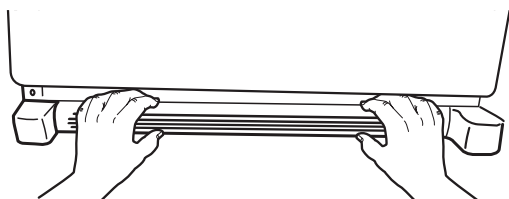

9. Using a 3/8" hex wrench, remove the leveling leg brackets from the bottom of the cabinet. Keep screws for later use.

Replace Doors and Hinges

1. Assemble the parts for the top hinge as shown in Top Hinges graphic. Do not tighten the screws completely.
2. Replace the parts for the bottom hinge as shown in Bottom Hinge graphic. Tighten screws. Replace the refrigerator door.

NOTE: Provide additional support for the refrigerator door while the hinges are being moved. Do not depend on the door gasket magnets to hold the door in place while you are working.

3. Align the door so that the bottom of the refrigerator door aligns evenly with the top of the freezer drawer. Tighten all screws.

4. Reconnect the wiring plug on top of the left-hand side refrigerator door.
5. Reconnect the water line by pulling back the locking collar ring while firmly pushing the water line into the connector.
6. Check for leaks. Replace the top hinge covers.

Remove and Replace Freezer Drawer

IMPORTANT: Two people may be required to remove and replace the freezer drawer. Graphics are included later in this section.

Remove Drawer Front

1. Open the freezer drawer to full extension.
2. Loosen the four screws attaching the drawer glides to the drawer front. See Drawer Front Removal graphic.
NOTE: Loosen screws three to four turns. Keep the screws in the drawer front.
3. Lift drawer front upward and off the screws. See Drawer Front Removal graphic.

Replace Drawer Front

1. Slide the drawer glides out of the freezer compartment. Insert the screws in the top of the drawer front into the slots in the drawer brackets. See Drawer Front Replacement graphic.
2. Pull the drawer brackets toward you to position the two screws in the bottom of the drawer front into the brackets. See Drawer Front Replacement graphic.
3. Completely tighten the four screws.

Final Steps

1. Replace the base grille.

WARNING



Electrical Shock Hazard

Plug into a grounded 3 prong outlet.

Do not remove ground prong.

Do not use an adapter.

Do not use an extension cord.

Failure to follow these instructions can result in death, fire, or electrical shock.

2. Plug into a grounded 3 prong outlet.
3. Return all removable parts to doors and drawer and food to refrigerator and freezer.



WARNING

Electrical Shock Hazard

Disconnect power before removing doors.

Failure to do so can result in death or electrical shock.

Door Removal and Replacement

Top Hinges

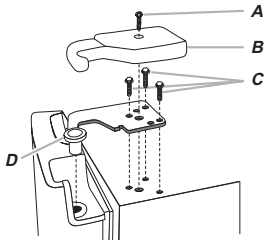

- A. Hinge Cover Screw
- B. Top Hinge Cover
- C. 5/16" Hex Head Hinge Screws
- D. Top Hinge

Bottom Hinges

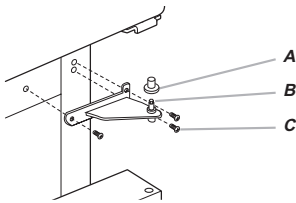

- A. Hinge Pin Cover
- B. Bottom Hinge
- C. Hinge Screws

Connections

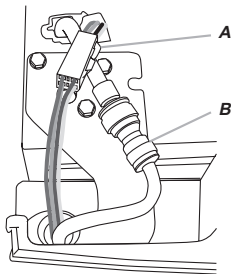

- A. Wiring Plug
- B. Water Line Connection

Handles

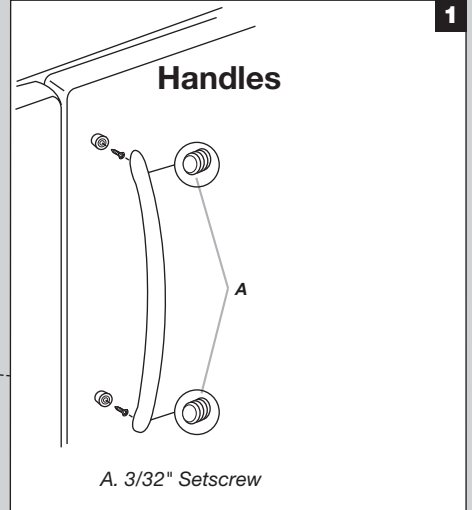

- A. 3/32" Setscrew

Handles

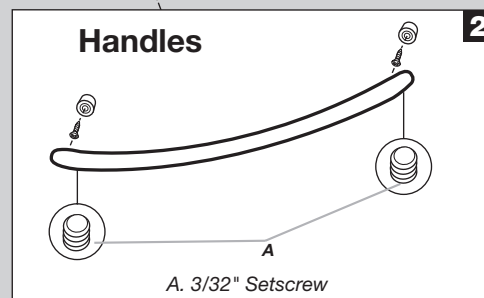

- A. 3/32" Setscrew

Drawer Front Removal

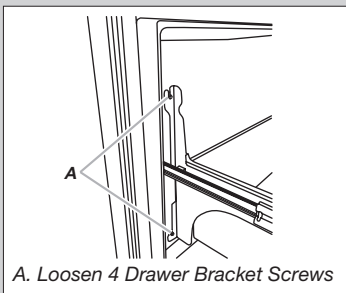

- A. Loosen 4 Drawer Bracket Screws

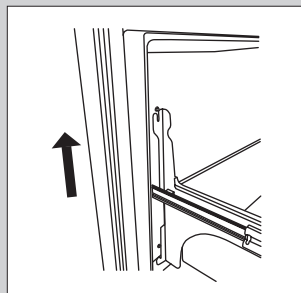

Drawer Front Replacement

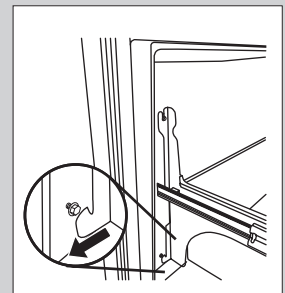
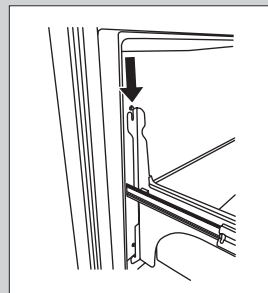

Adjust the Doors

IMPORTANT:

- Your refrigerator has two adjustable, front leveling screws – one on each side of the refrigerator base. If your refrigerator seems unsteady or you want the door to close easier, use the instructions below.
 - Before moving the refrigerator, raise the leveling screws so the front rollers are touching the floor.
1. Remove the two screws fastening the base grille to the cabinet, and set the screws aside. Grasp the grille and pull it toward you.

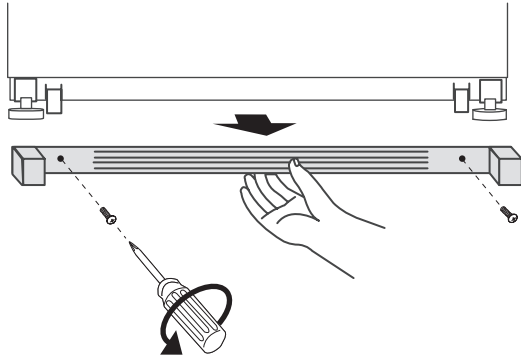

2. Raise or lower the cabinet.

Using a 1/4" hex driver, turn the leveling screw on each side to raise or lower that side of the refrigerator.

NOTE: Having someone push against the top of the refrigerator takes some weight off the leveling screws. This makes it easier to turn the screws. It may take several turns of the leveling screw to adjust the tilt of the refrigerator.

- To raise, turn the leveling screw clockwise.
- To lower, turn the leveling screw counterclockwise.

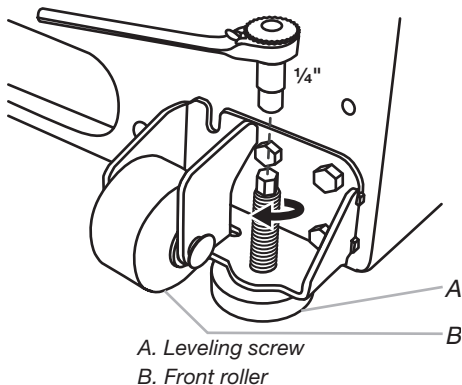

3. Open the door again to make sure that it closes as easily as you like. If not, tilt the refrigerator slightly more to the rear by turning both leveling screws clockwise. It may take several more turns, and you should turn both screws the same amount.
4. Replace the base grille.

REFRIGERATOR USE

Opening and Closing Doors

There are two refrigerator compartment doors. The doors can be opened and closed either separately or together.

There is a vertically-hinged seal on the left refrigerator door.

- When the left-hand refrigerator door is opened, the hinged seal automatically folds inward so that it is out of the way.
- When both doors are closed, the hinged seal automatically forms a seal between the two doors.

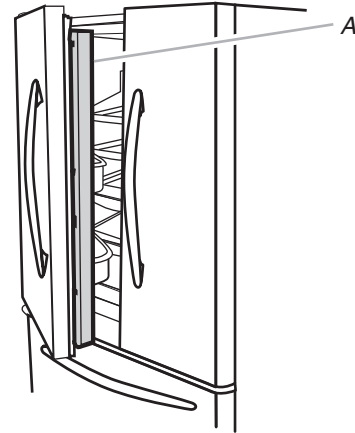

A. Hinged seal

Using the Controls

The refrigerator and freezer controls are located on the dispenser panel.

IMPORTANT: The display screen on the dispenser control panel will turn off automatically and enter "sleep" mode when the control buttons and dispenser levers have not been used for 2 minutes or more. While in "sleep" mode, the first press of a control button will only reactivate the display screen, without changing any settings. After reactivation, changes to any settings can then be made. If no changes are made within 2 minutes, the display will re-enter "sleep" mode.

- Touch any control button on the dispenser panel to activate the display screen. The home screen will appear as shown.

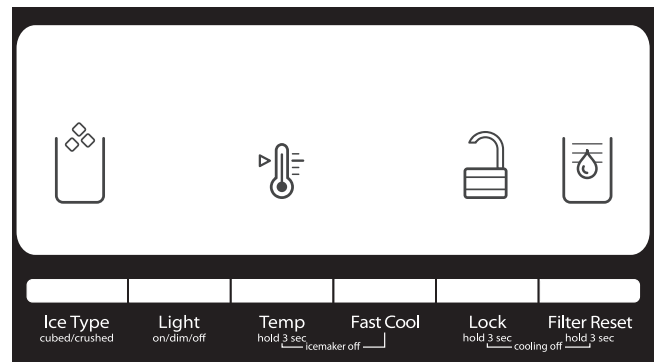

Adjusting the Controls

For your convenience, your refrigerator and freezer controls are preset at the factory. When you first install your refrigerator, make sure that the controls are still set to the “mid-settings.” The factory recommended set points are 38°F (3°C) for the refrigerator and 0°F (-18°C) for the freezer.

IMPORTANT:

- Wait 24 hours before you put food into the refrigerator. If you add food before the refrigerator has cooled completely, your food may spoil.

NOTE: Adjusting the set points to a colder than recommended setting will not cool the compartments any faster.

- If the temperature is too warm or too cold in the refrigerator or freezer, first check the air vents to be sure they are not blocked before adjusting the controls.
- The preset temperatures should be correct for normal household usage. The controls are set correctly when milk or juice is as cold as you like and when ice cream is firm.
- Wait at least 24 hours between adjustments. Recheck the temperatures before other adjustments are made.

To view and adjust the set points, press and hold the TEMP button for 3 seconds. When adjust mode is activated, adjusting information will appear on the display screen.

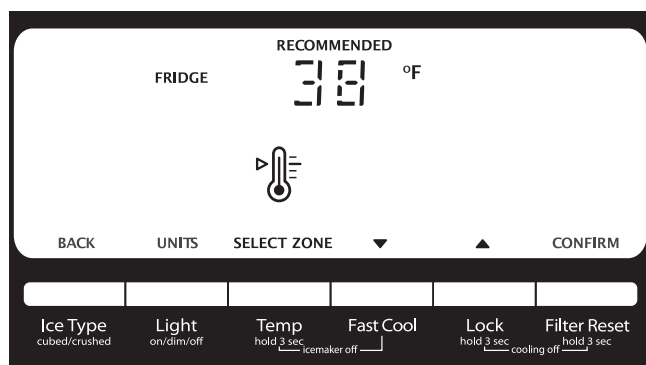

NOTE: To view Celsius temperatures, press the LIGHT button when Adjust mode is activated. To return the display setting to Fahrenheit, press LIGHT again.

- When Adjust mode is activated, the display screen shows the refrigerator set point and “FRIDGE” appears.
- Press LOCK to raise the set point, or press FAST COOL to lower the set point.
- When you have finished viewing (and adjusting if desired) the refrigerator set point, press TEMP to change the display to show the freezer set point. When the zone has been changed, “FREEZER” appears on the display screen.
- Press LOCK to raise the set point, or press FAST COOL to lower the set point.
- When you have finished viewing (and adjusting if desired) both the refrigerator and freezer set points, press FILTER to save the settings.

NOTE: To exit without saving changes, press ICE TYPE at any time while in Adjust mode or allow about 60 seconds of inactivity and adjust mode will turn off automatically.

When adjusting temperature set points, use the following chart as a guide.

CONDITION:	TEMPERATURE ADJUSTMENT:
REFRIGERATOR too cold	REFRIGERATOR Setting 1° higher
REFRIGERATOR too warm	REFRIGERATOR Setting 1° lower
FREEZER too cold	FREEZER Setting 1° higher
FREEZER too warm / Too little ice	FREEZER Setting 1° lower

The set point range for the refrigerator is 33°F to 45°F (0°C to 7°C). The set point range for the freezer is -5°F to 5°F (-21°C to -15°C).

Cooling On/Off

Your refrigerator and freezer will not cool when cooling is turned off.

- To turn cooling off, press and hold the LOCK and FILTER buttons at the same time for 3 seconds. When cooling is off, “COOLING OFF” will appear on the display screen.

IMPORTANT: To avoid unintentionally locking the dispenser or changing other settings, be sure to press both buttons at exactly the same time.

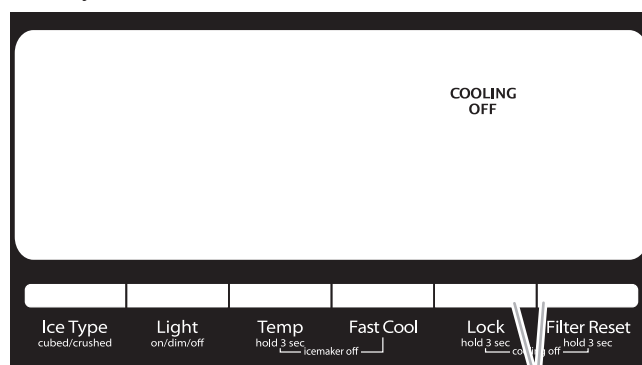

A

A. Press LOCK and FILTER RESET at the same time.

- Press and hold LOCK and FILTER for 3 seconds again to turn cooling back on.

Additional Features

Fast Cool

The Fast Cool feature assists with periods of high refrigerator use, full grocery loads, or temporarily warm room temperatures.

- Press FAST COOL to set the freezer and refrigerator to the lowest temperature setting. When the feature is on, the Fast Cool icon will appear on the dispenser display screen. The Fast Cool feature will remain on for 24 hours unless manually turned off.



- To manually turn off the Fast Cool feature, press FAST COOL again or adjust the refrigerator temperature set point. The Fast Cool icon will disappear when the feature is OFF.

NOTE: Setting the freezer to a colder temperature may make some foods, such as ice cream, harder.

Door Ajar Alarm

The Door Ajar Alarm feature sounds an alarm when the refrigerator or freezer door is open for 5 minutes and the product cooling is turned on. The alarm will repeat every 2 minutes. Close both doors to turn it off. The feature then resets and will reactivate when either door is left open again for 5 minutes.

NOTE: To mute the audible alarm while keeping the doors open, such as while cleaning the inside of the refrigerator, press any button on the control panel. The alarm sound will be temporarily turned off, but the Door Ajar icon will still be displayed on the dispenser control panel.



Water Filter Status Light and Filter Reset

The filter reset control allows you to restart the water filter status tracking feature each time you replace the water filter. See “Water Filtration System.”

- Press and hold FILTER RESET for 3 seconds or until the “Replace Filter” light turns off.

Crisper Humidity Control

You can control the amount of humidity in the moisture-sealed crisper. Depending on your model, adjust the control to any setting between FRUIT and VEGETABLES or LOW and HIGH.

FRUIT/LOW (open) for best storage of fruits and vegetables with skins.

VEGETABLES/HIGH (closed) for best storage of fresh, leafy vegetables.

Ice Maker and Ice Storage Bin

IMPORTANT:

- Flush the water system before turning on the ice maker. See “Water and Ice Dispensers.”
- The ice maker and storage bin are located in the upper left-hand side of the refrigerator compartment.

Turning the Ice Maker On/Off

The ice maker has an automatic shutoff. When the ice maker is ON, sensors will automatically stop ice production when the storage bin is full. The ice maker will remain set to ON, and ice production will resume when the bin is no longer full.

To manually turn off the ice maker, press TEMP and FAST COOL at the same time and hold for 3 seconds until the “Ice Maker Off” icon lights up. When the ice maker is set to OFF, it will stop producing ice.

Pressing and holding TEMP and FAST COOL again for 3 seconds turns on the ice maker and the “Ice Maker Off” icon disappears.

Removing and Replacing Ice Storage Bin

To Remove the Ice Storage Bin:

1. Hold the base of the storage bin and press the release button.
2. Pull out the storage bin.

To Replace the Ice Storage Bin:

IMPORTANT: It may be necessary to turn the auger driver, behind the ice bin, counterclockwise to properly align the ice bin with the auger driver. The ice storage bin must be locked in place for proper ice dispensing.

1. Slide the ice bin into the guide rails located on either side of the enclosure.

2. Push the ice bin in until resistance is felt. Raise the front slightly and push the ice bin in until an audible “click” is heard.

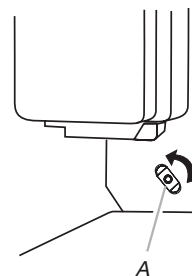

A. Auger driver

Ice Production Rate

- Allow 24 hours to produce the first batch of ice. Discard the first three batches of ice produced.
 - The ice maker should produce approximately 8 to 12 batches of ice in a 24-hour period.
 - To increase ice production, lower the freezer and refrigerator temperature. See “Using the Controls.” Wait 24 hours between adjustments.
- NOTE:** Setting the freezer to a colder temperature may make some foods, such as ice cream, harder.

Remember

- The quality of your ice will be only as good as the quality of the water supplied to your ice maker. Avoid connecting the ice maker to a softened water supply. Water softener chemicals (such as salt) can damage parts of the ice maker and lead to poor quality ice. If a softened water supply cannot be avoided, make sure the water softener is operating properly and is well maintained.
- Do not use anything sharp to break up the ice in the bin. This can cause damage to the ice bin and dispenser mechanism.
- Do not store anything in the ice storage bin.

Water and Ice Dispensers

IMPORTANT: After connecting the refrigerator to a water source or replacing the water filter, flush the water system. Use a sturdy container to depress and hold the water dispenser lever for 5 seconds, then release it for 5 seconds. Repeat until water begins to flow. Once water begins to flow, continue depressing and releasing the dispenser lever (5 seconds on, 5 seconds off) until a total of 4 gal. (15 L) has been dispensed. This will flush air from the filter and water dispensing system, and prepare the water filter for use. Additional flushing may be required in some households. As air is cleared from the system, water may spurt out of the dispenser.

NOTES:

- The dispensing system will not operate when the refrigerator door is open.
- Allow 24 hours for the refrigerator to cool down and chill water.
- Allow 24 hours to produce the first batch of ice. Discard the first three batches of ice produced.
- The display screen on the dispenser control panel will turn off automatically and enter “sleep” mode when the control buttons and dispenser levers have not been used for 2 minutes or more. While in “sleep” mode, the first press of a control button will only reactivate the display screen without changing any settings. After reactivation, changes to any settings can then be made. If no changes are made within 2 minutes, the display will re-enter “sleep” mode.

The Water Dispenser

IMPORTANT: Dispense enough water every week to maintain a fresh supply.

To Dispense Water :

1. Press a sturdy glass against the water dispenser lever.
2. Remove the glass to stop dispensing.

The Ice Dispenser

Ice dispenses from the ice maker storage bin in the freezer when the dispenser lever is pressed. To turn off the ice maker, see “Ice Maker and Storage Bin.”

Your ice maker can produce both crushed and cubed ice. Before dispensing ice, select which type of ice you prefer by pressing the ICE TYPE button.

The display screen indicates which type of ice is selected.

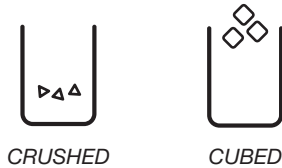

For crushed ice, cubes are crushed before being dispensed. This may cause a slight delay when dispensing crushed ice. Noise from the ice crusher is normal and pieces of ice may vary in size. When changing from crushed to cubed, a few ounces of crushed ice will be dispensed along with the first cubes.

To Dispense Ice:

1. Make sure the desired type of ice is selected. To switch between cubed and crushed, press ICE TYPE.

⚠ WARNING



Cut Hazard

Use a sturdy glass when dispensing ice.

Failure to do so can result in cuts.

2. Press a sturdy glass against the ice dispenser lever. Hold the glass close to the dispenser opening so ice does not fall outside of the glass.

IMPORTANT: You do not need to apply a lot of pressure to the lever in order to activate the ice dispenser. Pressing hard will not make the ice dispense faster or in greater quantities.

3. Remove the glass to stop dispensing.

NOTE: Ice may continue to dispense for up to 10 seconds after removing the glass from the lever. The dispenser may continue to make noise for a few seconds after dispensing.

The Dispenser Light

When you use the dispenser, the light will automatically turn on. If you want the light to be on continuously, you may choose either ON or DIM. The display screen indicates which mode is selected.

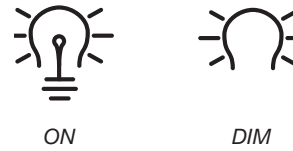

ON: Press LIGHT to turn the dispenser light on.

DIM: Press LIGHT a second time to select DIM mode. The dispenser light will remain ON, but at a lower intensity.

OFF: Press LIGHT a third time to turn the dispenser light off.

The dispenser lights are LEDs that cannot be changed. If it appears that your dispenser lights are not working, see “Troubleshooting” for more information.

The Dispenser Lock

The dispenser can be turned off for easy cleaning or to avoid unintentional dispensing by small children and pets.

NOTE: The lock feature does not shut off power to the refrigerator, to the ice maker, or to the dispenser light. It simply deactivates the controls and dispenser levers. To turn off the ice maker, see “Ice Maker and Storage Bin.”

- Press and hold LOCK for 3 seconds to lock the dispenser.
- Press and hold LOCK for 3 seconds, a second time to unlock the dispenser.

The display screen indicates when the dispenser is locked.

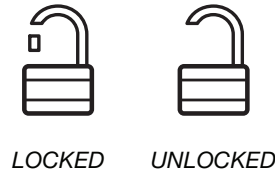

Water Filtration System

The water filter is located in the upper right-hand corner of the refrigerator compartment.

Do not use with water that is microbiologically unsafe or of unknown quality without adequate disinfection before or after the system. Systems certified for cyst reduction may be used on disinfected waters that may contain filterable cysts.

Water Filter Status Light

When a water filter has been installed in the refrigerator, the water filter status lights help you know when to change your water filter.

- The water filter status icon changes will change from Normal (blue water) to Order (red waves) and “Order Filter” (orange) when 90% of the volume of water for which the filter is rated has passed through the filter OR 5 months have passed since the filter was installed.
- The “Replace Filter” (red) icon will illuminate and blink continuously during dispensing when the rated volume of water has passed through the filter OR 6 months have passed since the filter was installed. A new water filter should be installed immediately when the Replace light is illuminated.
- After 14 days at Replace Filter stage, the “Replace Filter” and “water” icons will glow (red) at all times and blink continuously during dispensing. Also, an alert chime will sound three times following dispensing.

The disposable water filter should be replaced at least every 6 months. If the water flow to the water dispenser or ice maker decreases noticeably before 6 months have passed, replace the water filter more often. To change the filter, see “Water Filtration System.”

Reset Water Filter Status

After changing the water filter, reset the water filter status. On the display screen, press and hold FILTER RESET for 3 seconds. The status light will change from Replace Filter (red) to Normal (blue water) when the system is reset.

Replacing the Water Filter

To purchase a replacement water filter, model number UKF8001AXX-200, contact your dealer or call **1-800-422-9991** in the U.S.A. or **1-800-807-6777** in Canada.

IMPORTANT: Air trapped in the water system may cause water and filter to eject. Always dispense water for at least 2 minutes before removing the filter or blue bypass cap.

1. To access the filter, press upward on the ribbed section of the water filter cover.
2. Turn filter counterclockwise to remove.
3. Remove sealing label from replacement filter and insert the filter end into the filter head.
4. Turn the filter clockwise until it stops. Snap the filter cover closed.
5. Flush the water system. See “Water and Ice Dispenser.”

NOTE: The dispenser feature may be used without a water filter installed. Your water will not be filtered. If this option is chosen, replace the filter with the blue bypass cap.

REFRIGERATOR CARE

Cleaning

WARNING



Explosion Hazard

Use nonflammable cleaner.

Failure to do so can result in death, explosion, or fire.

Both the refrigerator and freezer sections defrost automatically. However, clean both sections about once a month to avoid odor buildup. Wipe up spills immediately.

IMPORTANT:

- Because air circulates between all compartments, any odors formed in one compartment will transfer to the other. You must thoroughly clean all compartments to eliminate odors. To avoid odor transfer and drying out of food, wrap or cover foods tightly.
- Do not use abrasive or harsh cleaners such as window sprays, scouring cleansers, flammable fluids, cleaning waxes, concentrated detergents, nail polish remover, bleaches or cleansers containing petroleum products. Do not use paper towels, scouring pads, or other harsh cleaning tools that may scratch or damage the materials.

Clean the Interior

1. Unplug refrigerator or disconnect power.
2. Using a clean sponge or soft cloth and a mild detergent in warm water, hand wash, rinse, and dry removable parts and interior surfaces thoroughly.
3. Plug in refrigerator or reconnect power.

Clean the Touch Screen Display on the Dispenser Panel

1. Make sure the refrigerator is unplugged or the power is disconnected before wiping the screen, to avoid unintentionally changing the settings.
2. Mix a solution of mild detergent in warm water. Dampen a soft, lint-free cloth with the solution and gently wipe the screen.
NOTE: Do not spray or wipe liquids directly onto the screen, or over-saturate the cloth.
3. Plug in refrigerator or reconnect power.

Clean the Exterior Surfaces

1. Unplug refrigerator or disconnect power.
2. Using a clean sponge or soft cloth and a mild detergent in warm water, wash, rinse and thoroughly dry stainless steel and painted metal exteriors.
 - To keep your stainless steel refrigerator looking like new and to remove minor scuffs or marks, it is suggested that you use the manufacturer's approved Stainless Steel Cleaner and Polish, Part Number 4396095. To order the cleaner, call **1-800-422-9991** U.S.A. or **1-800-807-6777** Canada.

IMPORTANT: This cleaner is for stainless steel parts only!

Do not allow the Stainless Steel Cleaner and Polish to come into contact with any plastic parts such as the trim pieces, dispenser covers or door gaskets. If unintentional contact does occur, clean plastic part with a sponge and mild detergent in warm water. Dry thoroughly with a soft cloth.

3. Plug in refrigerator or reconnect power.

Clean the Condenser

There is no need for routine condenser cleaning in normal home operating environments. If the environment is particularly greasy or dusty, or there is significant pet traffic in the home, the condenser should be cleaned every 2 to 3 months to ensure maximum efficiency.

To clean the condenser:

1. Unplug refrigerator or disconnect power.
2. Remove the base grille.
3. Use a vacuum cleaner with a soft brush to clean the grille, the open areas behind the grille and the front surface area of the condenser.
4. Replace the base grille when finished.
5. Plug in refrigerator or reconnect power.

Changing the Light Bulb(s)

IMPORTANT: The lighting system in this appliance may consist of:

- Sealed LED modules
- LED Bulbs
- Incandescent Bulbs
- Or a combination of the above.

If a Sealed LED module(s) do not illuminate when the refrigerator and/or freezer door is opened, call for assistance or service. See “Warranty” for contact information.

If a LED Bulb does not illuminate when the refrigerator and/or freezer door is opened, replace with like bulb following this procedure:

1. Unplug the refrigerator or disconnect power.
2. Remove the light shield (on some models).
 - Remove the hardware holding the light shield in place.
 - Top of the refrigerator compartment - Slide the light shield toward the back of the compartment to release it from the light assembly.

3. Replace the burned-out bulb(s) with a bulb of the same size, shape and wattage.
 - Order Part Number W10565137 (3.6 W).

NOTE: Some LED replacement bulbs are not recommended for wet/damp environments. The refrigerator and freezer compartments are considered to be wet/damp environments.

If using a brand of LED bulb other than the recommended LED bulb, before installation, read and follow all instructions on the LED packaging.

4. Replace the light shield by inserting the tabs on the shield into the liner holes on each side of the light assembly. Slide the shield toward the front until it locks into place.

NOTE: To avoid damaging the light shield, do not force the shield beyond the locking Point.

5. Replace the hardware that holds the shield in place.
6. Plug in the refrigerator or reconnect power.

If an incandescent bulb does not illuminate when the refrigerator and/or freezer door is opened, replace with like bulb using the same procedure outlined above. Replace burned out bulb with only incandescent bulb(s) of the same size, shape and wattage (maximum 40 W) designed for household appliances.

TROUBLESHOOTING

First try the solutions suggested here. If you need further assistance or more recommendations that may help you avoid a service call, refer to the warranty page in this manual and scan the code with your mobile device, or visit www.whirlpool.com/product_help. In Canada, visit www.whirlpool.ca.

Contact us by mail with any questions or concerns at the address below:

In the U.S.A.:

Whirlpool Brand Home Appliances
Customer eXperience Center
553 Benson Road
Benton Harbor, MI 49022-2692

In Canada:

Whirlpool Brand Home Appliances
Customer eXperience Centre
200 – 6750 Century Ave.
Mississauga, Ontario L5N 0B7

Please include a daytime phone number in your correspondence.

Refrigerator Operation

The refrigerator will not operate

⚠ WARNING



Electrical Shock Hazard

Plug into a grounded 3 prong outlet.

Do not remove ground prong.

Do not use an adapter.

Do not use an extension cord.

Failure to follow these instructions can result in death, fire, or electrical shock.

- **Power cord unplugged?** Plug into a grounded 3 prong outlet.

- **Is outlet working?** Plug in a lamp to see if the outlet is working.
- **Household fuse blown or circuit breaker tripped?** Replace the fuse or reset the circuit breaker. If the problem continues, call an electrician.
- **Are controls on?** Make sure the refrigerator controls are on. See “Using the Controls.”
- **New installation?** Allow 24 hours following installation for the refrigerator to cool completely.

NOTE: Adjusting the temperature controls to coldest setting will not cool either compartment more quickly.

The motor seems to run too much

Your new refrigerator may run longer than your old one due to its high-efficiency compressor and fans. The unit may run even longer if the room is warm, a large food load is added, doors are opened often, or if the doors have been left open.

The refrigerator seems noisy

Refrigerator noise has been reduced over the years. Due to this reduction, you may hear intermittent noises from your new refrigerator that you did not notice from your old model. Below are listed some normal sounds with explanations.

- **Buzzing** - heard when the water valve opens to fill the ice maker
- **Pulsating** - fans/compressor adjusting to optimize performance
- **Hissing/Rattling** - flow of refrigerant, movement of water lines, or from items placed on top of the refrigerator
- **Sizzling/Gurgling** - water dripping on the heater during defrost cycle
- **Popping** - contraction/expansion of inside walls, especially during initial cool-down
- **Water running** - may be heard when ice melts during the defrost cycle and water runs into the drain pan
- **Creaking/Cracking** - occurs as ice is being ejected from the ice maker mold.

The doors will not close completely

- **Door blocked open?** Move food packages away from door.
- **Bin or shelf in the way?** Push bin or shelf back in the correct position.

The doors are difficult to open



- **Gaskets dirty or sticky?** Clean gaskets and contact surfaces with mild soap and warm water. Rinse and dry with soft cloth.

Temperature and Moisture

Temperature is too warm

- **New installation?** Allow 24 hours following installation for the refrigerator to cool completely.
- **Door(s) opened often or left open?** Allows warm air to enter refrigerator. Minimize door openings and keep doors fully closed.
- **Large load of food added?** Allow several hours for refrigerator to return to normal temperature.
- **Controls set correctly for the surrounding conditions?** Adjust the controls a setting colder. Check temperature in 24 hours. See “Using the Control(s).”

Temperature is too cold in refrigerator

- **Refrigerator air vent blocked?** If the air vent located in the top, left, rear corner of the refrigerator compartment is blocked by items placed directly in front of it, the refrigerator will get too cold. Move items away from the air vent.
- **Ice storage bin in correct position?** See “Ice Maker and Ice Storage Bin.”

- **Controls set correctly for the surrounding conditions?** Adjust the controls a setting warmer. Check temperature in 24 hours. See “Using the Control(s).”

There is interior moisture buildup

NOTE: Some moisture buildup is normal.

- **Humid room?** Contributes to moisture buildup.
- **Door(s) opened often or left open?** Allows humid air to enter refrigerator. Minimize door openings and keep doors fully closed.

Ice and Water

The ice maker is not producing ice or not enough ice

- **Refrigerator connected to a water supply and the supply shutoff valve turned on?** Connect refrigerator to water supply and turn water shutoff valve fully open.
- **Kink in the water source line?** A kink in the line can reduce water flow. Straighten the water source line.
- **Ice maker turned on?** Make sure ice maker is ON. See “Ice Maker and Ice Storage Bin.”
- **New installation?** Wait 24 hours after ice maker installation for ice production to begin. Wait 72 hours for full ice production.
- **Refrigerator door closed completely?** Close the door firmly. If it does not close completely, see “The doors will not close completely.”
- **Large amount of ice recently removed?** Allow 24 hours for ice maker to produce more ice.
- **Ice cube jammed in the ice maker ejector arm?** Remove ice from the ejector arm with a plastic utensil.
- **Water filter installed on the refrigerator?** Remove filter and operate ice maker. If ice volume improves, then the filter may be clogged or incorrectly installed. Replace filter or reinstall it correctly.
- **Reverse osmosis water filtration system connected to your cold water supply?** This can decrease water pressure. See “Water Supply Requirements.”

The ice cubes are hollow or small

NOTE: This is an indication of low water pressure.

- **Water shutoff valve not fully open?** Turn the water shutoff valve fully open.
- **Kink in the water source line?** A kink in the line can reduce water flow. Straighten the water source line.
- **Water filter installed on the refrigerator?** Remove filter and operate ice maker. If ice quality improves, then the filter may be clogged or incorrectly installed. Replace filter or reinstall it correctly.
- **Reverse osmosis water filtration system connected to your cold water supply?** This can decrease water pressure. See “Water Supply Requirements.”
- **Questions remain regarding water pressure?** Call a licensed, qualified plumber.

Off-taste, odor, or gray color in the ice

- **New plumbing connections?** New plumbing connections can cause discolored or off-flavored ice.
- **Ice stored too long?** Discard ice. Wash ice bin. Allow 24 hours for ice maker to make new ice.

- **Odor transfer from food?** Use airtight, moisture proof packaging to store food.
- **Are there minerals (such as sulfur) in the water?** A water filter may need to be installed to remove the minerals.
- **Water filter installed on the refrigerator?** Gray or dark discoloration in ice indicates that the water filtration system needs additional flushing. Flush the water system before using a new water filter. Replace water filter when indicated. See “Water Filtration System.”

The water and ice dispenser will not operate properly

- **Refrigerator connected to a water supply and the supply shutoff valve turned on?** Connect refrigerator to water supply and turn water shutoff valve fully open.
- **Kink in the water source line?** Straighten the water source line.
- **New installation?** Flush and fill the water system. See “Water Dispenser.”
- **Is the water pressure at least 35 psi (241 kPa)?** The water pressure to the home determines the flow from the dispenser. See “Water Supply Requirements.”
- **Water filter installed on the refrigerator?** Remove filter and operate dispenser. If water flow increases, the filter may be clogged or incorrectly installed. Replace filter or reinstall it correctly.
- **Water dispenser measured fill feature is not dispensing an accurate amount of water?** Calibrate the water dispenser. See “Water and Ice Dispensers.”
- **Refrigerator door closed completely?** Close the door firmly. If it does not close completely, see “The doors will not close completely,” earlier in this section.

- **Recently removed the doors?** Make sure the water dispenser wire/tube assembly has been properly reconnected. See “Refrigerator Door(s) and Drawer.”
- **Reverse osmosis water filtration system connected to your cold water supply?** This can decrease water pressure. See “Water Supply Requirements.”
- **Water is leaking from the dispenser system**

NOTE: One or two drops of water after dispensing is normal.

- **Glass not being held under the dispenser long enough?** Hold the glass under the dispenser 2 to 3 seconds after releasing the dispenser lever.
- **New installation?** Flush the water system. See “Water and Ice Dispenser.”
- **Recently changed water filter?** Flush the water system. See “Water and Ice Dispenser.”

Water from the dispenser is warm

NOTE: Water from the dispenser is only chilled to 50°F (10°C).

- **New installation?** Allow 24 hours after installation for the water supply to cool completely.
- **Recently dispensed large amount of water?** Allow 24 hours for water supply to cool completely.
- **Water not been recently dispensed?** The first glass of water may not be cool. Discard the first glass of water.
- **Refrigerator connected to a cold water pipe?** Make sure the refrigerator is connected to a cold water pipe. See “Water Supply Requirements.”

PERFORMANCE DATA SHEETS

Water Filtration System Model UKF8001AXX-200/UKF8001 Capacity 200 Gallons (757 Liters)



System tested and certified by NSF International against NSF/ANSI Standard 42, 53, 401 and CSA B483.1 for the reduction of contaminants specified on the Performance Data Sheet.

This system has been tested according to NSF/ANSI Standards 42, 53, 401 and CSA B483.1 for the reduction of the substances listed below. The concentration of the indicated substances in water entering the system was reduced to a concentration less than or equal to the permissible limit for water leaving the system, as specified in NSF/ANSI Standards 42, 53, 401 and CSA B483.1.

Substance Reduction Aesthetic Effects	Influent Challenge Concentration	Maximum Permissible Product Water Concentration	Average% Reduction
Chlorine Taste/Odor	2.0 mg/L ± 10%	50% reduction	97.6%
Particulate Class I*	At least 10,000 particles/mL	85% reduction	98.8%
Contaminant Reduction	Influent Challenge Concentration	Maximum Permissible Product Water Concentration	Average% Reduction
Lead***: @ pH 6.5 / @ pH 8.5	0.150 mg/L ± 10%	0.010 mg/L	99.3% / 99.3%
Mercury: @ pH 6.5 / @ pH 8.5	0.006 mg/L ± 10%	0.002 mg/L	95.1% / 95.0%
Asbestos	10 ⁷ to 10 ⁸ fibers/L ^{††}	>99%	>99%
Cysts [†]	50,000/L min.	>99.95%	99.99%
Turbidity	11 NTU ± 10%	0.5 NTU	98.1%
Atrazine	0.009 mg/L ± 10%	0.003 mg/L	94.4%
Benzene	0.015 mg/L ± 10%	0.005 mg/L	96.6%
Carbofuran	0.080 mg/L ± 10%	0.040 mg/L	86.8%
Lindane	0.002 mg/L ± 10%	0.0002 mg/L	98.8%
P-Dichlorobenzene	0.225 mg/L ± 10%	0.075 mg/L	99.7%
Tetrachloroethylene	0.015 mg/L ± 10%	0.005 mg/L	96.0%
Toxaphene	0.015 mg/L ± 10%	0.003 mg/L	93.8%
Atenolol	200 ± 20%	30 ng/L	>95.9%
Endrin	0.006 mg/L ± 10%	0.002 mg/L	96.7%
Ethylbenzene	2.1 mg/L ± 10%	0.7 mg/L	99.9%
o-Dichlorobenzene	1.8 mg/L ± 10%	0.6 mg/L	99.9%
2,4 - D	0.210 mg/L ± 10%	0.07 mg/L	97%
Carbamazepine	1400 ± 20%	200 ng/L	>98.6%
DEET	1400 ± 20%	200 ng/L	>98.5%
Linuron	140 ± 20%	20 ng/L	>96.8%
Meprobamate	400 ± 20%	60 ng/L	94.6%
Metolachor	1400 ± 20%	200 ng/L	98.3%
Trimethoprim	140 ± 20%	20 ng/L	>96.4%
Bisphenol A	2000 ± 20%	300 ng/L	99.4%
Estrone	140 ± 20%	20 ng/L	>96.7%
Nonylphenol	1400 ± 20%	200 ng/L	>98.9%
Ibuprofen	400 ± 20%	60 ng/L	92.9%
Naproxen	140 ± 20%	20 ng/L	>96.3%
Phenytoin	200 ± 20%	30 ng/L	>94.8%

Test Parameters: pH = 7.5 ± 0.5 unless otherwise noted. Flow = 0.78 gpm (2.95 Lpm). Pressure = 60 psig (413.7 kPa).

Temp. = 68°F to 71.6°F (20°C to 22°C). Rated service capacity = 200 gallons (757 liters).

The compounds certified under NSF 401 have been deemed as "emerging compounds/incidental contaminants." Emerging compounds/incidental contaminants are those compounds that have been detected in drinking water supplies at trace levels. While occurring at only trace levels, these compounds can affect the public acceptance/perception of drinking water quality.

- It is important that operational, maintenance, and filter replacement requirements be carried out for the product to perform as advertised. Property damage can occur if all instructions are not followed.
- The disposable cartridge must be changed at least every 6 months.
- Use replacement filter UKF8001, Part #EDR4RX D1/EDR4RXD1B. 2015 suggested retail price of \$49.99 U.S.A./\$49.95 Canada. Prices are subject to change without notice.
- The filter monitor system measures the amount of water that passes through the filter and alerts you when it is time to replace the filter. To learn how to check the water filter status, see "Using the Controls" or "Water Filtration System" in the User Instructions or User Guide.
- After changing the water filter, flush the water system. See "Water and Ice Dispensers" or "Water Dispenser" in the User Instructions or User Guide.
- These contaminants are not necessarily in your water supply. While testing was performed under standard laboratory conditions, actual performance may vary.

- The product is for cold water use only.
- The water system must be installed in compliance with state and local laws and regulations.
- Do not use with water that is microbiologically unsafe or of unknown quality without adequate disinfection before or after the system. Systems certified for cyst reduction may be used on disinfected waters that may contain filterable cysts. EPA Est. No. 10350-MN-005.
- Refer to the “Warranty” section (in the User Instructions or User Guide) for the Manufacturer’s limited warranty, name and telephone number.

Application Guidelines/Water Supply Parameters	
Water Supply	Potable City or Well
Water Pressure	35 - 120 psi (241 - 827 kPa)
Water Temperature	33° - 100°F (1° - 38°C)
Service Flow Rate	0.78 gpm (2.95 L/min.) @ 60 psi

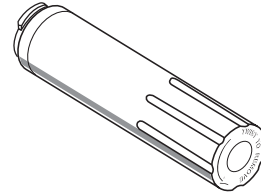

*Class I particle size: >0.5 to <1 um

***Compliant for Lead reduction requirements under NSF/ANSI Standard 53 as tested by Pace Analytical Services, Inc.

†Based on the use of Cryptosporidium parvum oocysts

††Fibers greater than 10 um in length

® NSF is a registered trademark of NSF International.

WHIRLPOOL® REFRIGERATION LIMITED WARRANTY

ATTACH YOUR RECEIPT HERE. PROOF OF PURCHASE IS REQUIRED TO OBTAIN WARRANTY SERVICE.

Please have the following information available when you call the Customer eXperience Center:

- Name, address, and telephone number
- Model number and serial number
- A clear, detailed description of the problem
- Proof of purchase, including dealer or retailer name and address

IF YOU NEED SERVICE:

1. Before contacting us to arrange service, please determine whether your product requires repair. Some questions can be addressed without service. Please take a few minutes to review the Troubleshooting section of the Use and Care Guide or visit producthelp.whirlpool.com.
2. All warranty service is provided exclusively by our authorized Whirlpool Service Providers. In the U.S. and Canada, direct all requests for warranty service to:

Whirlpool Customer eXperience Center

In the U.S.A., call 1-800-253-1301. In Canada, call 1-800-807-6777.

If outside the 50 United States or Canada, contact your authorized Whirlpool dealer to determine whether another warranty applies.

FIVE YEAR LIMITED WARRANTY

WHAT IS COVERED

ONE YEAR LIMITED WARRANTY

For one year from the date of purchase, when this major appliance is installed, operated, and maintained according to instructions attached to or furnished with the product, Whirlpool Corporation or Whirlpool Canada LP (hereafter "Whirlpool") will pay for factory specified replacement parts and repair labor to correct defects in materials or workmanship that existed when this major appliance was purchased or, at its sole discretion, replace the product. In the event of product replacement, your appliance will be warranted for the remaining term of the original unit's warranty period.

SECOND THROUGH FIFTH YEAR LIMITED WARRANTY ON CAVITY LINER AND SEALED REFRIGERATION SYSTEM

In the second through fifth years from the date of purchase, when this major appliance is installed, operated, and maintained according to the instructions attached to or furnished with the product, Whirlpool brand will pay for factory specified replacement parts and repair labor for the following components to correct non-cosmetic defects in materials and workmanship in this part that prevent function of the refrigerator and that existed when this major appliance was purchased:

- Refrigerator/freezer cavity liner if the part cracks due to defective materials or workmanship
- Sealed Refrigeration system (includes compressor, evaporator, condenser, dryer, and connecting tubing)

YOUR SOLE AND EXCLUSIVE REMEDY UNDER THIS LIMITED WARRANTY SHALL BE PRODUCT REPAIR AS PROVIDED HEREIN. Service must be provided by a Whirlpool designated service company. This limited warranty is valid only in the United States or Canada and applies only when the major appliance is used in the country in which it was purchased. This limited warranty is effective from the date of original consumer purchase. Proof of original purchase date is required to obtain service under this limited warranty.

WHAT IS NOT COVERED

1. Commercial, non-residential, or multiple-family use, or use inconsistent with published user, operator, or installation instructions.
2. In-home instruction on how to use your product.
3. Service to correct improper product maintenance or installation, installation not in accordance with electrical or plumbing codes, or correction of household electrical or plumbing (e.g., house wiring, fuses, or water inlet hoses).
4. Consumable parts (e.g., light bulbs, batteries, air or water filters, preservation solutions, etc.).
5. Defects or damage caused by the use of non-genuine Whirlpool parts or accessories.
6. Damage from accident, misuse, abuse, fire, floods, acts of God, or use with products not approved by Whirlpool.
7. Repairs to parts or systems to correct product damage or defects caused by unauthorized service, alteration, or modification of the appliance.
8. Cosmetic damage, including scratches, dents, chips, and other damage to the appliance finishes, unless such damage results from defects in materials and workmanship and is reported to Whirlpool within 30 days.
9. Discoloration, rust, or oxidation of surfaces resulting from caustic or corrosive environments including, but not limited to, high salt concentrations, high moisture or humidity, or exposure to chemicals.
10. Food or medicine loss due to product failure.
11. Pickup or delivery. This product is intended for in-home repair.
12. Travel or transportation expenses for service in remote locations where an authorized Whirlpool servicer is not available.
13. Removal or reinstallation of inaccessible appliances or built-in fixtures (e.g., trim, decorative panels, flooring, cabinetry, islands, countertops, drywall, etc.) that interfere with servicing, removal, or replacement of the product.
14. Service or parts for appliances with original model/serial numbers removed, altered, or not easily determined.

The cost of repair or replacement under these excluded circumstances shall be borne by the customer.

DISCLAIMER OF IMPLIED WARRANTIES

IMPLIED WARRANTIES, INCLUDING ANY IMPLIED WARRANTY OF MERCHANTABILITY OR IMPLIED WARRANTY OF FITNESS FOR A PARTICULAR PURPOSE, ARE LIMITED TO FIVE YEARS OR THE SHORTEST PERIOD ALLOWED BY LAW. Some states and provinces do not allow limitations on the duration of implied warranties of merchantability or fitness, so this limitation may not apply to you. This warranty gives you specific legal rights, and you also may have other rights that vary from state to state or province to province.

DISCLAIMER OF REPRESENTATIONS OUTSIDE OF WARRANTY

Whirlpool makes no representations about the quality, durability, or need for service or repair of this major appliance other than the representations contained in this warranty. If you want a longer or more comprehensive warranty than the limited warranty that comes with this major appliance, you should ask Whirlpool or your retailer about buying an extended warranty.

LIMITATION OF REMEDIES: EXCLUSION OF INCIDENTAL AND CONSEQUENTIAL DAMAGES

YOUR SOLE AND EXCLUSIVE REMEDY UNDER THIS LIMITED WARRANTY SHALL BE PRODUCT REPAIR AS PROVIDED HEREIN. WHIRLPOOL SHALL NOT BE LIABLE FOR INCIDENTAL OR CONSEQUENTIAL DAMAGES. Some states and provinces do not allow the exclusion or limitation of incidental or consequential damages, so these limitations and exclusions may not apply to you. This warranty gives you specific legal rights, and you also may have other rights that vary from state to state or province to province.

02/17