

Dishwasher

User manual

DW60R2014 Series





SAMSUNG

Contents

Safety information	4
Important safety instructions	4
Before using your dishwasher	7
Setting up your dishwasher	8
Unpacking your dishwasher	8
Checking parts	9
Meeting installation requirements	10
Control panel	12
Cycle overview	16
Using your dishwasher	17
Basic guidelines	17
Touch controls (DW60R2014AP)	18
Delay start	18
Adjusting the height of the upper rack	19
Removing the upper rack	20
Loading the lower rack	20
Loading the upper rack	21
Using the cutlery rack	21
Using detergent	23
Using rinse aid	25
Cleaning and care	27
Cleaning the filters	27
Cleaning the spray arms	29
Cleaning the door	29
Caring for the dishwasher	29
Protect against freezing	30
How to maintain your dishwasher	30

Cycles	31
Cycle chart	31
Troubleshooting	32
Check these points if your dishwasher...	32
Information codes	36
Appendix	37
Helping the environment	37
Specifications	37
Warranty	38
Warranty (U.S.A)	38
Warranty (CANADA)	41

Safety information

Throughout this manual, you'll see Warning  and Caution  notes. These important safety instructions do not cover all possible situations that might occur.

Important safety instructions

What the icons and signs in this user manual mean:

 **WARNING**







Hazards or unsafe practices that may result in **severe personal injury or death**.

 **CAUTION**

Hazards or unsafe practices that may result in **personal injury or property damage**.

 **CAUTION**

To reduce the risk of fire, explosion, electric shock, or personal injury when using your dishwasher, follow these basic safety precautions:

-  Do NOT attempt.
-  Do NOT disassemble.
-  Do NOT touch.
-  Follow directions explicitly.
-  Unplug the power plug from the wall socket.
-  Make sure the machine is grounded to prevent electric shock.
-  Call the service center for help.

California Proposition 65 Warning

 **WARNING**

Cancer and Reproductive Harm - www.P65Warnings.ca.gov

SAVE THESE INSTRUCTIONS

 **WARNING**

When using the dishwasher, follow basic precautions, including the following:

-  Read all instructions before using the dishwasher.

As with any equipment using electricity, water, and moving parts, potential hazards exist.

Use the dishwasher only for its intended function.

Use only detergents or wetting agents recommended for use in a dishwasher and keep them out of the reach of children.

When loading items to be washed:

- Locate sharp items so that they are not likely to damage the door seal, and
- Load sharp knives with the handles up to reduce the risk of cut-type injuries.

-  Do not wash plastic items unless they are marked “dishwasher safe” or the equivalent. For plastic items not so marked, check the manufacturer’s recommendations.

-  Do not touch the HEATING ELEMENT during or immediately after use.

1. Do not operate your dishwasher unless all ENCLOSURE panels are properly in place.
2. Do not tamper with the controls.
3. Do not abuse, sit on, or stand on the door or on a dish rack of the dishwasher.
4. To reduce the risk of injury, do not allow children to play in or on the dishwasher.
5. Under certain conditions, hydrogen gas may be produced in a hot-water system that has not been used for two weeks or more. HYDROGEN GAS IS EXPLOSIVE. If the hot-water system has not been used for such a period, before using the dishwasher, turn on all hot-water faucets and let the water flow from each for several minutes. This will release any accumulated hydrogen gas. As the gas is flammable, do not smoke or use an open flame during this time.
6. Remove the door to the washing compartment when removing an old dishwasher from service or discarding it.

After unpacking the dishwasher, keep the packaging out of the reach of children.

The dishwasher is extremely heavy. Do not attempt to move or carry the dishwasher by yourself. Two or more people are needed to move a dishwasher and avoid potential injuries.

Do not install the dishwasher near electrical components. Keep the dishwasher away from open flames.

Install and level your dishwasher on an uncarpeted floor that can support its weight.

Your dishwasher must be properly grounded. Never connect it to an ungrounded outlet. See page 5 for more information on grounding your dishwasher.

Connect the ground wire to the green ground connector in the terminal box.

SAVE THESE INSTRUCTIONS



Safety information

After the dishwasher is installed, check that the drain hose is properly connected and that there is no leakage from the hose connectors. If the drain hose is loose, it may cause property damage.

The water supply line is susceptible to breakage. As time goes by, it becomes less flexible. Check the line periodically. If it is swollen, torn, cut, or there is a water leak, replace it immediately.

To safely operate this appliance, familiarize yourself with its operations and exercise care when using it.

Do not put gasoline, solvents, or other flammable materials inside the dishwasher. Do not wash dishes exposed to these materials.

Keep your dishwasher detergent out of the reach of children. Detergent has an adverse effect on human organs. It contains elements for polishing and is corrosive. Avoid letting the detergent come into contact with your skin and eyes.

Do not push or place pressure on the door when it is open, as this may damage the dishwasher or cause harm.

Do not allow children to play in or on the dishwasher. They may harm themselves or damage the dishwasher.

 Disconnect the power cable (or set the circuit breaker to off) before servicing your dishwasher.

Do not repair, replace, or service any part of your dishwasher yourself. Disassembly, repairs and modifications must be performed by authorized service technicians only. Work done by an unauthorized person may void your warranty.

Before disposing of your dishwasher, remove the door of the washing compartment or the door latch so that children or small animals cannot get trapped inside.

If the dishwasher is left unused for an extended period of time, turn off the water supply.

This dishwasher is intended for residential use only.

SAVE THESE INSTRUCTIONS



Before using your dishwasher

WARNING



Tip-Over Hazard

- Do not use the dishwasher until it is correctly installed.
- Do not push down on the dishwasher door when it is open.
- Do not place excessive weight on the dishwasher door when it is open.



Electric Shock Hazard

Failure to follow these instructions can result in death, fire, or electric shock:

- Electrically ground the dishwasher.
- Connect the ground wire to the green ground connector in the junction box.
- Do not use an extension cord.

SAVE THESE INSTRUCTIONS

Setting up your dishwasher

Be sure to have your installer follow these instructions closely so that your new dishwasher works properly and that you're not at risk of injury when washing dishes.

Unpacking your dishwasher

- Once your new dishwasher has been delivered to you, carefully unpack it and check for any damage. If the dishwasher has been damaged, make note of it on the waybill and keep a copy. Do not install the dishwasher, and contact Samsung Customer Service at 1-800-SAMSUNG (726-7864).
- If there is no damage to the product, you can proceed with the installation. If you are going to install it yourself, make sure to read through the installation guide and follow the directions inside.
- After unpacking your dishwasher, keep the packaging out of the reach of children to ensure their safety.

Checking parts

When your dishwasher has been unpacked, make sure you've received all the parts shown below. If your dishwasher was damaged during shipping, or if you do not have all the parts, contact **Samsung Customer Service at 1-800-SAMSUNG (726-7864)**.

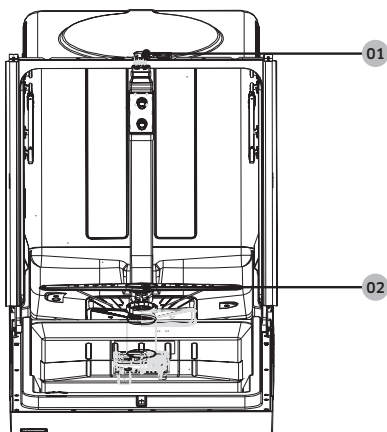

01 Door switch

02 Lower nozzle



Lower rack



Upper rack
* Middle nozzle



Cutlery rack

NOTE

Accessory parts: User/Installation manual, Installation Kit.

Setting up your dishwasher

Meeting installation requirements

Electrical supply and grounding

 To prevent the risk of fire, electric shock, or personal injury, all wiring and grounding must be done in accordance with the National Electrical Code ANSI/FNPA, No. 70 Latest Revision and local codes and ordinances. It is the personal responsibility of the appliance owner to provide adequate electrical service for this appliance.

CAUTION

- Never use an extension cord.
- When preparing for installation, ensure that you provide:
 - An individual branch circuit with a 120 V, 60 Hz, 15 AMP fuse or circuit breaker that serves only your dishwasher .
- Your dishwasher must be grounded. If your dishwasher malfunctions or breaks down, grounding will reduce the risk of electric shock by providing a path of least resistance for the electric current.

WARNING

Never connect the ground wire to plastic plumbing lines, gas lines, or hot water pipes.

GROUNDING INSTRUCTIONS

For a permanently connected appliance:

This appliance must be connected to a grounded metal, permanent wiring system, or an equipment-grounding conductor must be run with the circuit conductors and then connected to the equipment-grounding terminal or lead on the appliance.

Water supply

The hot water supply line pressure must be between 20-120 psi (140-830 kPa).

Adjust your water heater to deliver water between 120 °F (49 °C) and 149 °F (65 °C).

NOTE

- Most plumbing supply stores sell water supply lines of various lengths up to 10 feet (305 cm) long.
- You can reduce the risk of leaks and water damage by:
 - Making water faucets easily accessible.
 - Turning off faucets when the dishwasher is not in use.
 - Periodically checking for leaks at water supply line fittings.

WARNING

Before using your dishwasher for the first time, check all connections at the water supply valve and faucets for leaks.

Flooring

For safety, your dishwasher must be installed on a solidly constructed floor.

Never install your dishwasher on a platform or poorly supported structure.

Your dishwasher must be properly installed in accordance with the Installation Guide before you use it. If you did not receive an Installation Guide with your dishwasher, you can obtain one by visiting our website at www.samsung.com.

Setting up your dishwasher

Control panel

The Control Panel section has instructions for the DW60R2014US and the DW60R2014P. Instructions for the DW60R2014US start below. Instructions for the DW60R2014P start on page 14.

DW60R2014US

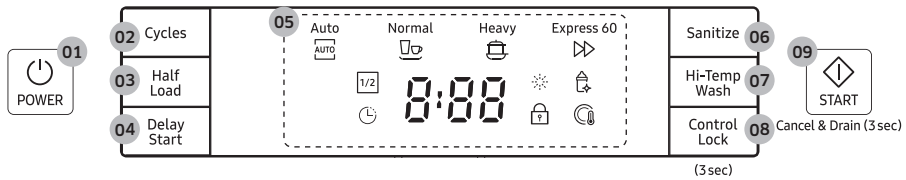

01 POWER	When you press the POWER button, the entire display turns on and off. When the selected cycle is complete, the dishwasher powers off automatically.
02 Cycles	To select a wash cycle, press this button.
03 Half Load	For small loads, use either the upper or lower rack only to save energy. Press the Half Load button to select the upper or lower basket.
04 Delay Start	Delay a cycle for up to 24 hours in one-hour increments. The hour displayed indicates the time at which the wash will be started.
05 Display Window	Displays the running time, Delay start hours, and information codes. If a problem occurs during operation, a check message will be displayed with a warning sound.
06 Sanitize	<p>The temperature rises to 158 °F (70 °C) in the final rinse cycle for high temperature sanitization. If you select the Sanitize option, the "Sanitize" lamp blinks when the water temperature reaches the sanitary temperature [over 156 °F (69 °C)], and then remains illuminated until the Sanitize option ends. When you press the POWER button, the "Sanitize" lamp turns off.</p> <p>NOTE</p> <ul style="list-style-type: none"> The Normal cycle with the Sanitize option selected is NSF certified. The Sanitize feature operates in accordance with NSF/ANSI Standard 184 for residential dishwashers. Certified residential dishwashers are not intended for licensed food establishments.

07 Hi-Temp Wash	<p>Raises the main wash temperature to improve cleaning for loads containing tough, baked-on food.</p> <p> NOTE Hi-Temp Wash is not available for the Express 60 cycle.</p>
08 Control Lock (3 sec)	<p>Control Lock lets you lock the buttons on the control panel so children cannot accidentally start the dishwasher. To activate Control Lock, hold the Control Lock button down for three (3) seconds. To de-activate Control Lock, hold the Control Lock button down for three (3) seconds again.</p>
09 START	<p>To start a cycle, press the START button before closing the door.</p> <p>* Reset: To cancel a currently running cycle and drain the dishwasher, press and hold the START button for three (3) seconds. Once the dishwasher is reset, select a cycle and option, and then press START to restart the dishwasher.</p>

 **NOTE**

- You can select options (**Hi-Temp Wash, Sanitize**) before starting a cycle. If you change the cycle after selecting an option, the original cycle is reset.
- When you pause a cycle by opening the door during operation, press the **START** button before closing the door to continue the cycle.
 - Push the door firmly closed within 3 seconds of pressing the **START** button.
 - If the door is not closed within 3 seconds, the cycle will not start.

 **IMPORTANT**

To get the best performance from your dishwasher, read all the operating instructions before using it for the first time.

Setting up your dishwasher

DW60R2014AP

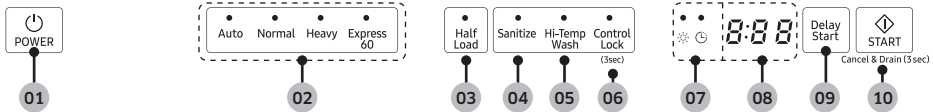

Setting up your dishwasher

01 POWER	When you press the POWER button, the entire display turns on and off. When the selected cycle is complete, the dishwasher powers off automatically.
02 Cycles	Select the appropriate wash cycle depending on the soil level of your dishes.
03 Half Load	For small loads, use either the upper or lower rack only to save energy. Press the Half Load button to select the upper or lower basket.
04 Sanitize	<p>The temperature rises to 158 °F (70 °C) in the final rinse cycle for high temperature sanitization. If you select the Sanitize option, the “Sanitize” lamp blinks when the water temperature reaches the sanitary temperature [over 156 °F (69 °C)], and then remains illuminated until the Sanitize option ends. When you press the POWER button, the “Sanitize” lamp turns off.</p> <p>NOTE</p> <ul style="list-style-type: none"> The Normal cycle with the Sanitize option selected is NSF certified. The Sanitize feature operates in accordance with NSF/ANSI Standard 184 for residential dishwashers. Certified residential dishwashers are not intended for licensed food establishments.
05 Hi-Temp Wash	<p>Raises the main wash temperature to improve cleaning for loads containing tough, baked-on food.</p> <p>NOTE</p> <p>Hi-Temp Wash is not available for the Express 60 cycle.</p>
06 Control Lock (3sec)	Control Lock lets you lock the buttons on the control panel so children cannot accidentally start the dishwasher. To activate Control Lock, hold the Control Lock button down for three (3) seconds. To de-activate Control Lock, hold the Control Lock button down for three (3) seconds again.
07 Indicator	<p>Rinse refill</p> <ul style="list-style-type: none"> If the “Rinse refill” indicator is lit, it means the dishwasher is low on dishwasher rinse aid and requires a refill. <p>Delay start</p> <ul style="list-style-type: none"> If the “Delay start” indicator is lit, it means, you selected the “Delay Start” option.

08 Display Window	Displays the running time, Delay start hours, and information codes. If a problem occurs during operation, a check message will be displayed with a warning sound.
09 Delay Start	Delay a cycle for up to 24 hours in one-hour increments. The hour displayed indicates the time at which the wash will be started.
10 START	To start a cycle, press the START button before closing the door. * Reset: To cancel a currently running cycle and drain the dishwasher, press and hold the START button for three (3) seconds. Once the dishwasher is reset, select a cycle and option, and then press START to restart the dishwasher.

NOTE

- You can select options (**Hi-Temp Wash, Sanitize**) before starting a cycle. If you change the cycle after selecting an option, the original cycle is reset.
- When you pause a cycle by opening the door during operation, press the **START** button before closing the door to continue the cycle.
 - Push the door firmly closed within 3 seconds of pressing the **START** button.
 - If the door is not closed within 3 seconds, the cycle will not start.
- To prevent the touchpad from losing response sensitivity, follow these instructions:
 - Touch the center of each keypad using one finger. Do not push.
 - Clean the touch control's surface regularly with a soft, damp cloth.
 - Be careful not to touch more than one touch key pad at a time, except as directed.

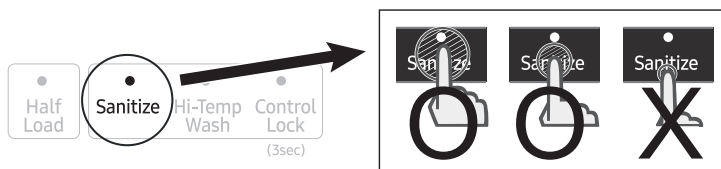

IMPORTANT

To get the best performance from your dishwasher, read all the operating instructions before using it for the first time.

Setting up your dishwasher

Cycle overview

DW60R2014US



DW60R2014AP



01 Auto	This cycle detects the level of soil and automatically initiates the optimal cycle after a few minutes of operation.
02 Normal	Use this cycle for normally soiled dishes.
03 Heavy	Use this cycle for heavily soiled dishes and dishes with heavy soil.
04 Express 60	Use this cycle for lightly soiled dishes.

Using your dishwasher

Basic guidelines

1. Open the door and load your dishes (See pages 20 to 21).
 - Place dishes into the upper and lower racks, unless you have selected **Half Load**.
 - Remove any food remains from the dishes before placing them in the rack(s).
 - After placing the dishes into the racks, rotate the nozzles by hand to check whether any of the dishes will interfere with them.
 - Make sure the dishes will not prevent the detergent dispenser from opening.
2. Add detergent to the dispenser (see page 23).
 - Make sure to use only automatic dishwasher detergent and rinse aid.
 - Refer to “**Using detergent**” on page 23 for instructions explaining how to add detergent and rinse aid.
3. Press the **POWER** button.
 - When you press the **POWER** button, the entire display turns on and off, and then the indicator of the most recently finished cycle lights up.
 - If “Rinse refill” (☼) is illuminated, you should refill the rinse aid dispenser to improve washing and drying performance.
4. Select an appropriate cleaning cycle depending on the soil level of the dishes. (See pages 16 and 31.)
 - Press the appropriate **Cycles** button.
 - When you press a **Cycles** button, the cycle indicator lights up.
5. Press the **START** button, and then close the door within 3 seconds.
 - The dishwasher will start draining after a few seconds, and then start the selected cycle.
 - Make sure to close the door firmly. If the door is not closed properly, the selected cycle will not start automatically.
6. When the wash cycle is completed.
 - The light illuminates and the dishwasher sounds a chime.
 - The dishwasher powers off automatically.

CAUTION

- If you want to load more dishes or pause the dishwasher while it is already running, make sure to open the door slowly and carefully as there is a possibility of injury from the hot steam inside the dishwasher.
- If the door is opened while the dishwasher is running, a safety mechanism is activated and stops the cycle.
- To resume operation, press the **START** button, and then close the door within 3 seconds.
- Adding dishes several minutes after the dishwasher starts operating may affect its performance.
- If you open the door while the dishwasher is running at high temperature, it will drain the hot water automatically to protect you from scalding.

NOTE

- You should use rinse aids for better drying performance. You can further improve drying performance by also selecting the **Sanitize** option.



Using your dishwasher

- After a cycle is complete, the door automatically opens to let steam out. This is normal and not a product malfunction.
- Open the dishwasher's door, and then wait a few minutes before removing the dishes. The dishes will be cooler and drying will be improved.

Touch controls (DW60R2014AP)

Touch controls allow you to operate the dishwasher easily.

- They are convenient to operate, requiring only a soft touch.
- They have a simple and stylish design.
- They are easy to clean.

NOTE

If you have children or you want to clean the control interface, we recommend activating the **Control Lock** feature to lock the control buttons. See page 14.

- Children will not be able to accidentally start the dishwasher by touching the controls with this option selected.
- If a cycle is running, the buttons will not respond. (except the **POWER** button)
- If dishwasher is off, only the **POWER** button responds.

Delay start

When you select the **Delay Start** option, your dishwasher will operate the selected cycle when the delay time expires.

WARNING

- When using the dishwasher, try to arrange the dishes properly as described on pages 20 to 21.
 - You should remove food remains such as bones, fruit seeds, etc. and any other waste such as toothpicks, paper, etc. from the dishes as these may cause damage to the dishes, create noise, or cause the dishwasher to malfunction.
 - Select the appropriate cycle depending on the level of soil and the type of dishes.
 - Use only the proper amount of detergent and rinsing agent.
- **Do not wash the following items:**
 - **Acrylic or aluminum items:** Dishes with printed gold rim decoration may become discolored.
 - **Dishes treated with adhesive:** Treated plastics, wood, ivory, copper, and tin may come loose.
 - **Plastics with a temperature tolerance less than 194 °F (90 °C):** Thin plastics wash and dry poorly, and may be damaged due to elevated wash temperatures.
 - **Tin:** Tin should be washed by hand and dried immediately as it may rust.
 - **Wooden utensils:** Wooden items may crack.



Adjusting the height of the upper rack

You can adjust the height of the upper rack in your Samsung dishwasher so that the lower rack can accommodate larger sized dishes. With the upper rack set at the highest position, the lower rack can accommodate plates up to 12 in. (30 cm) in diameter and the upper rack can accommodate plates up to 8 in. (20 cm) in diameter.

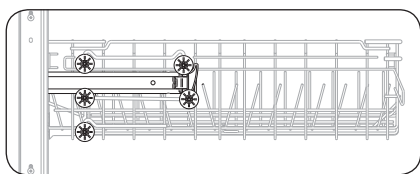

Lower position (A)

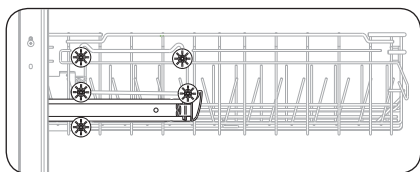

Upper position (B)

1. To lower the upper rack by 2 in. (5 cm), remove the upper rack as shown in **Removing the upper rack** section on page 20. Then, reinsert the rack so that the upper four wheels on each side of the rack are above and below the guide rail.
 - See the **Lower position (A)** illustration to the left.
2. To raise the upper rack, remove the upper rack as shown in **Removing the upper rack** section on page 20. Then, reinsert the rack so that the lower three wheels on each side of the rack are above and below the guide rail.
 - See the **Upper position (B)** illustration to the left.

⚠ CAUTION

We recommend adjusting the height of the upper rack before loading dishes into the rack. If you adjust the rack after loading the dishes, you may damage the dishes.



Using your dishwasher

Removing the upper rack

Pull the upper rack towards the front and then remove it by lifting it up slightly and pulling it towards the front. See the illustrations below.

⚠ CAUTION

While the upper rack is removable, it must be installed for the dishwasher to operate properly. If you attempt to operate the dishwasher without the rack, noise will occur and the dishwasher will perform poorly.

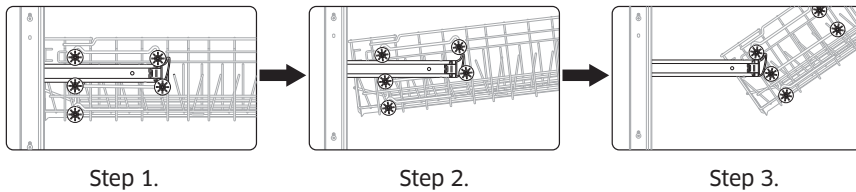

Using your dishwasher

Loading the lower rack

The lower rack has been especially designed for dinner dishes, soup bowls, plates, pots, lids, casserole dishes, and plates.

Load large items such as pans and pots into the dishwasher so their open sides face downwards. We recommend loading cups, stemware, and small plates into the upper rack. See the recommended loading patterns below.

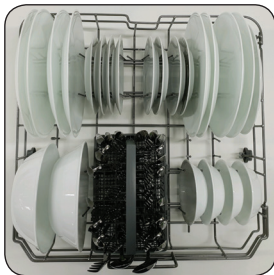

8 place setting

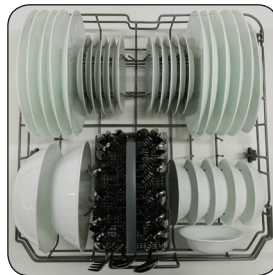

10 place setting

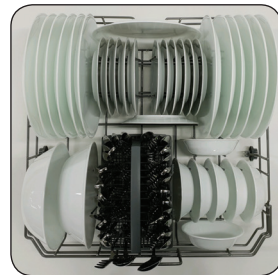

12 place setting





Loading the upper rack

The upper rack has been designed for small plates, mugs, glasses, and plastic items marked "dishwasher safe". Load your plates into the dishwasher in two half rows, so that the front of each plate faces the back of the plate in front of it, and the open sides of the plates at the center of the dishwasher face each other. See the figures below.

Make sure the loaded dishes do not interfere with the rotation of the nozzle which is located at the bottom of the upper rack. (Check this by rotating the nozzle by hand.)

When loading dishes, pull the upper rack out sufficiently so you can load it without striking the counter above.



8 place setting

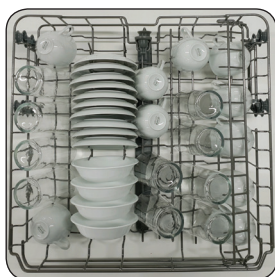

10 place setting

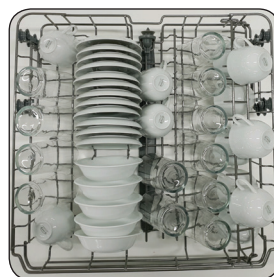

12 place setting

Using the cutlery rack

You can place each knife, spoon, or fork separately into the spoon stands in the basket's covers to prevent chipping and discoloration.

You can use the cutlery rack with the cover open.

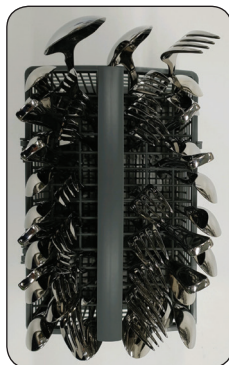

8 place setting

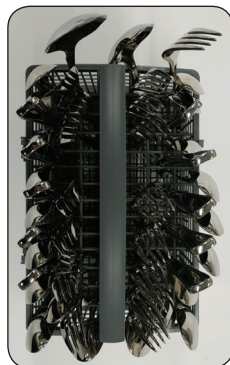

10 place setting



12 place setting



Using your dishwasher

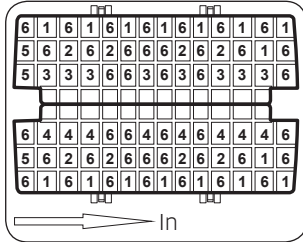

8 place setting

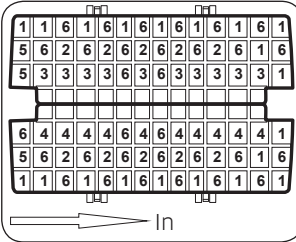

10 place setting

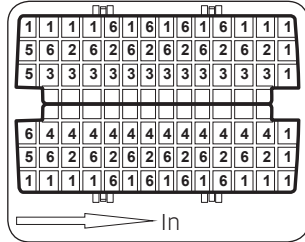

12 place setting

The spoon stands as seen from above with the suggested placement of cutlery items. Match the numbers in the diagram to the numbers in the list of cutlery items below.

NOTE

DO NOT let any item extend through the bottom.

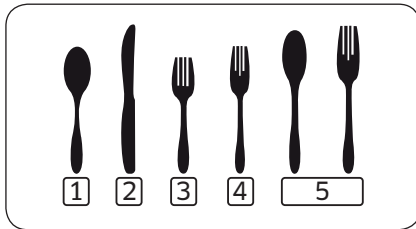

1. Tea spoons
2. Knives
3. Salad forks
4. Dinner forks
5. Serving spoons and Serving forks
6. Remaining items

Using detergent

All dishwasher cycles require detergent in the detergent compartment. Add the correct amount of detergent for the selected cycle to ensure the best performance.

⚠ CAUTION

Use dishwasher detergent only. Regular detergent produces too much foam, which may decrease the dishwasher's performance or cause it to malfunction.

⚠ WARNING

- Do not swallow dishwasher detergent. Avoid breathing in the fumes. Dishwasher detergent contains irritants and caustic chemicals that can induce respiratory conditions. If you have swallowed dishwasher detergent or inhaled the fumes, seek medical attention immediately.
- Keep dishwasher detergent out of the reach of children.

Filling the detergent dispenser

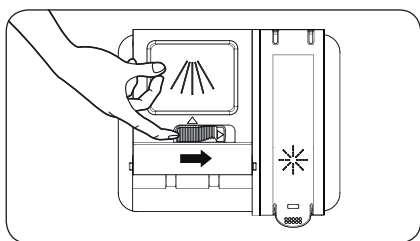

1. Open the detergent dispenser flap by pushing the detergent dispenser release catch.

📖 NOTE

The flap is always open at the end of a dishwashing cycle.

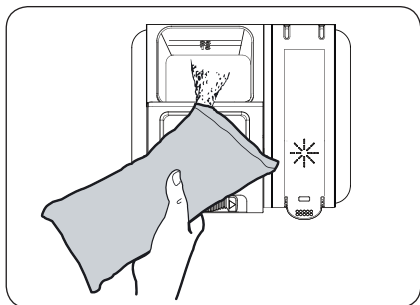

2. Add the recommended amount of detergent to the main wash detergent compartment.

Using your dishwasher

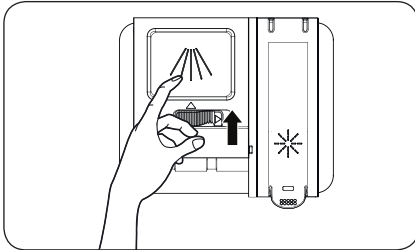

3. Close the flap by sliding it and then pressing it down.

NOTE

- There is no separate button that sets the dispenser for tablet detergents.
- For better cleaning result, especially if you have very dirty items, pour a small amount (about 0.3 oz or 8 g) of detergent on the door before closing it. This will activate during the pre wash phase.

The cover opens automatically to dispense the detergent during the wash.

Cycle	Amount of detergent	
	Main wash dispenser	Onto the door for pre-wash
Auto, Normal	3/4 oz (20 g)	1/3 oz (10 g)
Heavy, Express 60	1 oz (30 g)	1/2 oz (15 g)

NOTE

The numbers inside the dispenser refer to grams.

Using rinse aid

Filling the rinse aid reservoir

When the Rinse refill indicator lights up on the control panel, refill with rinse aid.

Your dishwasher has been designed to use liquid rinse aid only.

Using a powdered rinse aid will clog the reservoir opening and cause the dishwasher to malfunction. Rinse aid improves the drying performance of the dishwasher.

⚠ CAUTION

Do not add regular detergent to the rinse aid reservoir.

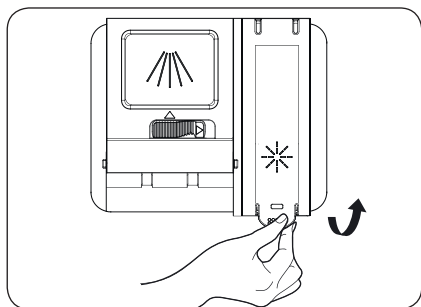

1. Remove the rinse aid reservoir cap by lifting up the handle.

📖 NOTE

Adding rinse aid when you use tablet detergents will improve drying performance.

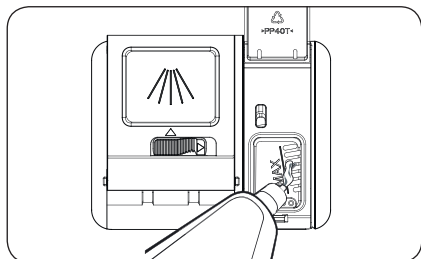

2. Fill the rinse aid reservoir with rinse aid.

📖 NOTE

Use the viewing port when filling the rinse aid reservoir.

⚠ CAUTION

Do not fill the reservoir above the maximum level. Excess rinse aid can overflow during the wash cycle.

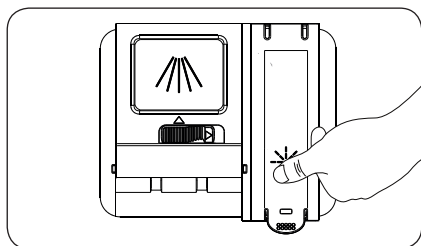

3. Close the cap.



Using your dishwasher

Adjusting the amount of rinse aid

You can adjust the amount of rinse aid used by following the instructions below. Generally, the higher the setting, the better the drying performance.

1. Turn on the dishwasher.
2. Press the **Express 60** (DW60R2014AP) or **Cycles** (DW60R2014US) button for five seconds within 60 seconds of turning on the dishwasher.
3. Press the **Delay Start** button to enter the rinse aid setting mode.
4. The LCD display shows the current rinse level. (between d1-d5)
5. Press the **Express 60** (DW60R2014AP) or **Cycles** (DW60R2014US) button to select the amount of rinse aid you want. Each time you press the button, the setting will change in the following sequence.
 - d1 > d2 > d3 > d4 > d5 > d1. (The default level is d4.)
6. Select the amount of rinse aid, and then wait 5 seconds for the setup to complete.



Cleaning and care

Cleaning the filters

Filtering system

For your convenience, we have placed the drain pump and filtering system within easy reach inside the tub.

- There are three components of the filtering system: the main filter, the coarse filter, and the fine filter.

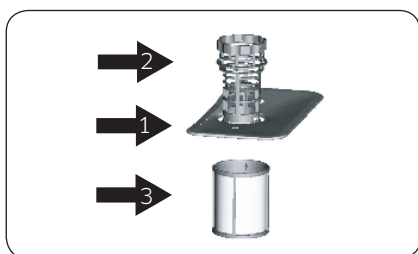

1. **Main filter:** Food and soil particles trapped by this filter are pulverized by a special jet on the lower spray arm and washed down the drain.
2. **Coarse filter:** Larger items, such as pieces of bone or glass, that could clog the drain are trapped in the coarse filter. To remove an item caught in this filter, gently squeeze the tabs on top of this filter and lift it out.
3. **Fine filter:** This filter holds soil and food residue in the sump area and prevents it from being redeposited on the dishes during a cycle.

⚠ CAUTION

Do not put the fine filter in upside down.

Cleaning and care

Filter assembly

For best performance and results, the filter assembly must be cleaned. The filter efficiently removes food particles from the wash water, allowing it to be recirculated during a cycle. For this reason, it is a good idea to remove the larger food particles trapped in the filter after each wash cycle by rinsing the semicircular filter and cup under running water. To remove the filter assembly, turn it counterclockwise, and then lift the filter assembly up. The entire filter assembly should be cleaned regularly.

To clean the coarse filter and the fine filter, use a cleaning brush. Then, reinsert the entire assembly in the dishwasher. Position it in its seat, press downward, and then turn it clockwise.

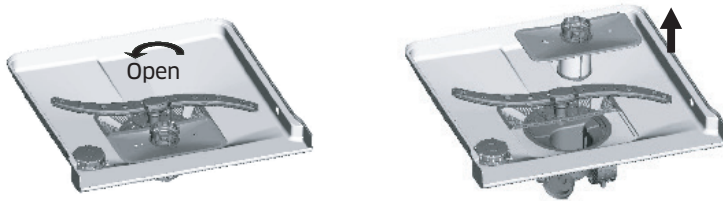

The dishwasher must never be used without the filters. Improper replacement of the filter may reduce the performance level of the dishwasher and damage dishes and utensils.

⚠ WARNING

Never run the dishwasher without the filters in place. When cleaning the filters, do not damage them. Damaged filters may not perform as intended, causing poor wash results or damage to internal parts of the dishwasher.



Cleaning the spray arms

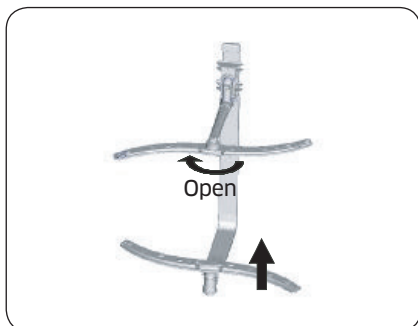

It is necessary to clean the spray arms regularly. To remove the middle spray arm, hold the nut, and then rotate the arm clockwise to remove it. To remove the lower spray arm, pull out the spray arm upward. Wash the arms in warm, soapy water, and then use a soft brush to clean the jets. Rinse the arms thoroughly, and then put them back in place.

Cleaning the door

To clean the edge around the door, you should use only a soft cloth dampened in warm water.

Also, never use abrasive cleaners or scouring pads on the outer surfaces. They will scratch the finish. Some papers towels can also scratch or leave marks on the surface.

⚠ WARNING

Never use a spray cleaner to clean the door panel. The spray can damage the door lock and electrical components. Do not use an abrasive cleaning agent or paper towels to clean the door. They can scratch the door or leave spots on the stainless steel surface.

Caring for the dishwasher

To clean the control panel, use a lightly dampened cloth then dry thoroughly. To clean the exterior, use a good appliance polish wax.

Never use sharp objects, scouring pads or harsh cleaners on any part of the dishwasher.



Cleaning and care

Protect against freezing

If your dishwasher is left in an unheated place during the winter:

1. Cut off electrical power to the dishwasher.
2. Turn off the water supply and disconnect the water inlet pipe from the water valve.
3. Drain water from the inlet pipe and water valve. (Use a pan to catch the water.)
4. Reconnect the water inlet pipe to the water valve.
5. Remove the filter in the tub the bottom and use a sponge sop up any water.

How to maintain your dishwasher

After every wash

- After every wash, turn off the water supply to the appliance and leave the door slightly ajar so that moisture and odors are not trapped inside.

Remove the plug

- Before cleaning or performing maintenance, always remove the plug from the socket.

No solvents or abrasive cleaners

- To clean the exterior and rubber parts of the dishwasher, do not use solvents or abrasive cleaning products. Use only a cloth and warm, soapy water. To remove spots or stains from the surface of the interior, use a cloth dampened with water and a little white vinegar, or a cleaning product made specifically for dishwashers.

When you go on vacation

- When you go on vacation, we recommend that you run a wash cycle with the dishwasher empty and then unplug the power cord, turn off the water supply and leave the door of the appliance slightly ajar. This will help the seals last longer and prevent odors from forming within the appliance.

Moving the appliance

- If the appliance must be moved, try to keep it in the vertical position. If absolutely necessary, it can be positioned on its back.

Seals

- One of the factors that causes odors to form in the dishwasher is food that remains trapped in the seals. Periodic cleaning with a damp sponge will prevent this from occurring.

Cycles

Cycle chart

DW60R2014 Series

Cycle		Auto	Normal	Heavy	Express 60
Cycle sequence		Prewash ▶ Mainwash ▶ Rinse ▶ Hot Rinse ▶ Dry ▶ End	Prewash ▶ Mainwash ▶ Rinse ▶ Hot Rinse ▶ Dry ▶ End	Prewash ▶ Mainwash ▶ Rinse ▶ Hot Rinse ▶ Dry ▶ End	Prewash ▶ Mainwash ▶ Rinse ▶ Hot Rinse ▶ End
Temp [°F (°C)]	Main wash	122-149 (50-65)	113-149 (45-65)	149 (65)	140 (60)
	Hot Rinse *Sanitize 163 °F (73 °C)	154 (68)	149 (65)	154 (68)	136 (58)
Water consumption [gal (ℓ)]		3.8-5.7 (14.5-21.5)	2.9-5.7 (10.8-21.5)	5.7 (21.5)	3.8 (14.5)
Cycle time (min.)		131-148	120-148	162	60
Available Options	Half Load	0	0	0	0
	Delay Start	0	0	0	0
	Sanitize	0	0	0	0
	Hi-Temp Wash	0	0	0	X

- When you select the **Auto** or **Normal** cycle, you can eliminate optional steps depending on the soil level of the dishes.
- The water consumption and wash time varies depending on the steps or options you add, and on the pressure and temperature of the supplied water.
- When you select any options, the cycle time can be changed.
- When the Rinse aid is empty, wash time and Last Rinse temperature will be increased.
- Some cycles will operate the drying fan for 30 minutes after finishing the cycle.
- When you select the **Sanitize** option with **Express 60** cycle, drying will be added before the end of cycle.

Troubleshooting

Check these points if your dishwasher...

Problem	Possible cause	Solution
Will not start.	The door is not closed completely.	<ul style="list-style-type: none"> Check if the door is latched and closed completely.
	No cycle is selected.	<ul style="list-style-type: none"> Select a proper cycle.
	The power cable is not connected.	<ul style="list-style-type: none"> Connect the power cable properly.
	The water supply does not work.	<ul style="list-style-type: none"> Check if the water supply valve is open.
	The Control Panel is locked.	<ul style="list-style-type: none"> Unlock the Control Lock. (See page 14)
	A circuit breaker is open.	<ul style="list-style-type: none"> Reset the circuit breaker.
Is taking too long with an operation or cycle.	Cold water is being supplied.	<ul style="list-style-type: none"> Make sure the water supply line is connected to a hot water supply. (Additional time is required to heat cold water.)
There are food particles remaining on dishes. (Not cleaning properly.)	You selected an inappropriate cycle.	<ul style="list-style-type: none"> Select a cycle according to the number and soil level of the dishes, as directed in this manual.
	The water temperature is low.	<ul style="list-style-type: none"> Connect the water supply line to a hot water supply. For best performance, the temperature of the supplied water should be 120 °F (49 °C).
	Low water pressure.	<ul style="list-style-type: none"> The water pressure should be between 20 and 120 psi (140-830 kPa).
	Dishwasher detergent was not used.	<ul style="list-style-type: none"> Use automatic dishwasher detergent. We recommend a powder or gel type dishwasher detergent.



Problem	Possible cause	Solution
There are food particles remaining on dishes. (Not cleaning properly.)	Detergent remains in the dispenser. 	<ul style="list-style-type: none"> • Make sure large items such as cookie sheets, cutting boards, or containers, etc. are not blocking the detergent dispenser and preventing it from opening properly. • Rearrange the dishes so they do not interfere with detergent dispenser operation.
	There is no rinse aid.	<ul style="list-style-type: none"> • Check the dispenser and add rinse aid. • Use liquid type rinse aid.
	A nozzle is clogged.	<ul style="list-style-type: none"> • Clean the spray arms. See page 29.
	The dishes are improperly loaded. Too many dishes have been loaded.	<ul style="list-style-type: none"> • Rearrange the dishes so they do not interfere with nozzle rotation and detergent dispenser operation. • Load only an appropriate number of dishes. • Load your dishes as recommended. (See pages 20 to 21)
Leaves glasses with a dim polish.	The water supplied is soft and too much detergent was used.	<ul style="list-style-type: none"> • Underload the dishwasher and use a rinse aid to minimize this.
	Aluminum dishes were included in the wash load.	<ul style="list-style-type: none"> • Remove the marks on the dishes using a low sensitivity cleaner.
Leaves a yellow or brown film on the inside of the dishwasher.	This is caused by coffee and tea soils.	<ul style="list-style-type: none"> • Remove the soils using a spot cleaner.



Troubleshooting

Problem	Possible cause	Solution
Does not dry dishes well.	There is no rinse aid in the dispenser.	<ul style="list-style-type: none"> • Check the dispenser and add rinse aid. • Use a liquid type rinse aid.
	The temperature of the water is low when the dishwasher is running.	<ul style="list-style-type: none"> • Make sure that the water supply line is connected to a hot water supply. • Use rinse aid with the Sanitize option.
	Too many dishes have been loaded.	<ul style="list-style-type: none"> • Proper loading of items can affect drying. • Load your dishes as recommended. (See pages 20 to 21)
	Glasses and cups with concave bottoms hold water. This water may spill onto other items when unloading.	<ul style="list-style-type: none"> • After the cycle finishes, empty the lower rack first and then the upper rack. This will prevent water from dripping from the upper rack onto the dishes in the lower rack.
Has a bad odor.	Water was left over from an incomplete cycle.	<ul style="list-style-type: none"> • With the dishwasher empty, add detergent to the dispenser, and then run the Normal cycle to clean the dishwasher.
	The Drain Hose is obstructed.	<ul style="list-style-type: none"> • Contact a qualified service technician to remove any obstruction from the drain hose.
	The dishwasher is not used daily or soiled dishes are left in unit too long.	<ul style="list-style-type: none"> • With the dishwasher empty and no detergent in the dispenser, place a glass with 8 ounces of vinegar upright into the lower rack, and then run a Normal cycle.

Problem	Possible cause	Solution
Is too noisy.	Sound is generated when the dispenser cover is open and the drain pump is operating in an early stage.	<ul style="list-style-type: none"> This is normal operation.
	The dishwasher is not level.	<ul style="list-style-type: none"> Ensure the dishwasher is level.
	Foreign material (a screw, a plastic piece) is in the pump chamber.	<ul style="list-style-type: none"> Contact a qualified service technician to remove foreign material from the pump chamber.
	There is a 'chopping' sound because a nozzle is bumping against the dishes.	<ul style="list-style-type: none"> Rearrange the dishes.
Does not have a smoothly rotating nozzle.	The nozzle holes are clogged with food particles.	<ul style="list-style-type: none"> Clean the nozzle hole. See page 29.
	The nozzle is blocked by a dish or pot and cannot rotate.	<ul style="list-style-type: none"> After placing the dishes into the racks, rotate the nozzles by hand to check whether any of the dishes interfere with them.
Water won't pump out of the dishwasher.	The drain is clogged.	<ul style="list-style-type: none"> Contact a qualified service technician to remove any obstruction from the drain hose and check the drain pump operation.
Has a bent upper rack after loading dishes.	The dishes are not loaded properly.	<ul style="list-style-type: none"> Load your dishes as recommended. (See pages 20 to 21)

Troubleshooting

Information codes

The control panel displays information codes to help you understand what is occurring with your dishwasher.

Code	Action
LC	Leakage check <ul style="list-style-type: none">• If a water supply valve connection leak occurs, close the water supply valve and go to your house circuit breaker panel, set the dishwasher's circuit breaker switch to off, and then contact the installer to fix.• If the problem continues, contact an authorized Samsung service center.
4C	Water supply check <ul style="list-style-type: none">• Check if the water supply valve is closed, the water supply is suspended, or the water inlet valve or line is frozen or clogged by foreign particles.• If the problem continues, close the water supply valve, and then contact an authorized Samsung service center.
tC	Thermistor check <ul style="list-style-type: none">• Temperature sensor is broken (Short or Open circuit). If the problem continues, contact an authorized Samsung service center.
HC	High temperature heating check <ul style="list-style-type: none">• The product ensures that the temperature for hot water line is not too high and adjusts to the appropriate temperature (120 °F (49 °C) to 149 °F (65 °C)) automatically.• If the problem continues, go to your house circuit breaker panel, set the dishwasher's circuit breaker switch to off, and then contact an authorized Samsung service center.
AC	PCB communication check <ul style="list-style-type: none">• Abnormal communication between the main PCB and the sub PCB.• If the problem continues, contact an authorized Samsung service center.

For any codes not listed above, call 1-800-SAMSUNG (726-7864).

Appendix

Helping the environment

- Your dishwasher is manufactured from recyclable materials. If you decide to dispose of it, please observe local waste disposal regulations. Cut off the power cable so that the appliance cannot be connected to a power source.
- Remove the door so that animals and small children cannot get trapped inside the appliance.
- Do not exceed the detergent quantities recommended in the detergent manufacturers' instructions.

Specifications

Model		DW60R2014US / DW60R2014AP
Type		Built-in Dishwasher
Power		120 V / 60 Hz only
Rated power usage	Wash motor	26-50 W
	Heater	1000 W
Wash capacity		12 place setting
Used water pressure		20-120 psi (140-830 kPa)
Dimensions (Width × Depth × Height)	DW60R2014US	23 ³ / ₈ × 22 ⁷ / ₁₆ × 32 ¹ / ₁₆ in. (600 × 570 × 815 mm)
	DW60R2014AP	23 ³ / ₈ × 21 ⁵ / ₈ × 32 ¹ / ₁₆ in. (600 × 550 × 815 mm)
Weight	DW60R2014US	Unpacked 81.6 lb (37 kg)
	DW60R2014AP	Unpacked 79.4 lb (36 kg)

Warranty

Warranty (U.S.A)

SAMSUNG DISHWASHER

LIMITED WARRANTY TO ORIGINAL PURCHASER WITH PROOF OF PURCHASE

This SAMSUNG brand product, as supplied and distributed by SAMSUNG ELECTRONICS AMERICA, INC. (SAMSUNG) and delivered new, in the original carton to the original consumer purchaser, is warranted by SAMSUNG against manufacturing defects in materials or workmanship for the limited warranty period, starting from the date of original purchase, of:

One (1) Year All Parts and Labor,

Five (5) Years Printed Circuit Board, Racking (Labor Charges for in-home service starting from the 2nd year is customer's responsibility), and Lifetime Stainless Door Liner & Tub for leakage. If the unit cannot be repaired, Samsung will replace your unit with same or current model (that is better or equivalent in functionality) (Labor related to replacement is customer's responsibility).

This limited warranty is valid only on products purchased and used in the United States that have been installed, operated, and maintained according to the instructions attached to or furnished with the product. To receive warranty service, the purchaser must contact SAMSUNG at the address or phone number provided below for problem determination and service procedures. Warranty service can only be performed by a SAMSUNG authorized service center. The original dated bill of sale must be presented upon request as proof of purchase to SAMSUNG or SAMSUNG's authorized service center to receive warranty service.

SAMSUNG will provide in-home service within the contiguous United States during the warranty period at no charge, subject to availability of SAMSUNG authorized servicers within the customer's geographic area. If in-home service is not available, SAMSUNG may elect, at its option, to provide transportation of the product to and from an authorized service center. If the product is located in an area where service by a SAMSUNG authorized servicer is not available, you may be responsible for a trip charge or required to bring the product to a SAMSUNG authorized service center for service.

To receive in-home service, product must be unobstructed and accessible to the service agent.

During the applicable warranty period, a product will be repaired, replaced, or the purchase price refunded, at the sole option of SAMSUNG. SAMSUNG may use new or reconditioned parts in repairing a product, or replace the product with a new or reconditioned product. Replacement parts and products are warranted for the remaining portion of the original product's warranty or ninety (90) days, whichever is longer. All replaced parts and products are the property of SAMSUNG and you must return them to SAMSUNG.

This limited warranty covers manufacturing defects in materials or workmanship encountered in normal household, noncommercial use of this product and shall not cover the following: damage that occurs in shipment, delivery, installation, and uses for which this product was not intended; damage caused by unauthorized modification or alteration of the product; product where the original factory serial numbers have been removed, defaced, changed in any way, or cannot be readily determined; cosmetic damage including scratches, dents, chips, and other damage to the product's finishes; damage caused by abuse, misuse, pest infestations, accident, fire, floods, or other acts of nature or God; damage caused by use of equipment, utilities, services, parts, supplies, accessories, applications, installations, repairs, external wiring or connectors not supplied or authorized by SAMSUNG; damage caused by incorrect electrical line current, voltage, fluctuations and surges; damage caused by failure to operate and maintain the product according to instructions; in-home instruction on how to use your product; and service to correct installation not in accordance with electrical or plumbing codes or correction of household electrical or plumbing (i.e., house wiring, fuses, or water inlet hoses).

The cost of repair or replacement under these excluded circumstances shall be the customer's responsibility.

Visits by an authorized servicer to explain product functions, maintenance or installation are not covered by this limited warranty. Please contact SAMSUNG at the number below for assistance with any of these issues.

EXCLUSION OF IMPLIED WARRANTIES

IMPLIED WARRANTIES, INCLUDING THE IMPLIED WARRANTIES OF MERCHANTABILITY OR FITNESS FOR A PARTICULAR PURPOSE, ARE LIMITED TO ONE YEAR OR THE SHORTEST PERIOD ALLOWED BY LAW. Some states do not allow limitations on how long an implied warranty lasts, so the above limitations or exclusions may not apply to you. This warranty gives you specific rights, and you may also have other rights, which vary from state to state.

Warranty

LIMITATION OF REMEDIES

YOUR SOLE AND EXCLUSIVE REMEDY IS PRODUCT REPAIR, PRODUCT REPLACEMENT, OR REFUND OF THE PURCHASE PRICE AT SAMSUNG'S OPTION, AS PROVIDED IN THIS LIMITED WARRANTY. SAMSUNG SHALL NOT BE LIABLE FOR SPECIAL, INCIDENTAL OR CONSEQUENTIAL DAMAGES, INCLUDING BUT NOT LIMITED TO TIME WAY FROM WORK, HOTELS AND/OR RESTAURANT MEALS, REMODELING EXPENSES, LOSS OF REVENUE OR PROFITS, FAILURE TO REALIZE SAVINGS OR OTHER BENEFITS REGARDLESS OF THE LEGAL THEORY ON WHICH THE CLAIM IS BASED, AND EVEN IF SAMSUNG HAS BEEN ADVISED OF THE POSSIBILITY OF SUCH DAMAGES. Some states do not allow exclusion or limitation of incidental or consequential damages, so the above limitations or exclusions may not apply to you. This warranty gives you specific rights, and you may also have other rights, which vary from state to state.

SAMSUNG does not warrant uninterrupted or error-free operation of the product. No warranty or guarantee given by any other person, firm, or corporation with respect to this product shall be binding on SAMSUNG.

To obtain warranty service, please contact SAMSUNG at:

In USA

Samsung Electronics America, Inc.

85 Challenger Road

Ridgefield Park, NJ 07660

1-800-SAMSUNG (726-7864)

www.samsung.com/us/support

Warranty (CANADA)

SAMSUNG DISHWASHER

LIMITED WARRANTY TO ORIGINAL PURCHASER

This SAMSUNG brand product, as supplied and distributed by SAMSUNG ELECTRONICS CANADA, INC. (SAMSUNG) and delivered new, in the original carton to the original consumer purchaser, is warranted by SAMSUNG against manufacturing defects in materials and workmanship for a limited warranty period of:

One (1) Year All Parts and Labor,

Five (5) Years Printed Circuit Board, Racking (Labor Charges for in-home service starting from the 2nd year is customer's responsibility), and Lifetime Stainless Door Liner & Tub for leakage. If the unit cannot be repaired, Samsung will replace your unit with same or current model (that is better or equivalent in functionality) (Labor related to replacement is customer's responsibility).

This limited warranty begins on the original date of purchase, and is valid only on products purchased and used in the Canada. To receive warranty service, the purchaser must contact SAMSUNG for problem determination and service procedures. Warranty service can only be performed by a SAMSUNG authorized service center. The original dated bill of sale must be presented upon request as proof of purchase to SAMSUNG or SAMSUNG's authorized service center. SAMSUNG will provide in-home service during the warranty period at no charge, subject to availability within the contiguous Canada.

In home service is not available in all areas.

To receive in-home service, product must be unobstructed and accessible to the service agent. If service is not available, SAMSUNG may elect to provide transportation of the product to and from an authorized service center.

SAMSUNG will repair, replace, or refund this product at our option and at no charge as stipulated herein, with new or reconditioned parts or products if found to be defective during the limited warranty period specified above. All replaced parts and products become the property of SAMSUNG and must be returned to SAMSUNG. Replacement parts and products assume the remaining original warranty, or ninety (90) days, whichever is longer.

Warranty

This limited warranty covers manufacturing defects in materials and workmanship encountered in normal, noncommercial use of this product and shall not apply to the following: damage that occurs in shipment; delivery and installation; applications and uses for which this product was not intended; altered product or serial numbers; cosmetic damage or exterior finish; accidents, abuse, neglect, fire, water, lightning, or other acts of nature or God; use of products, equipment, systems, utilities, services, parts, supplies, accessories, applications, installations, repairs, external wiring or connectors not supplied or authorized by SAMSUNG that damage this product or result in service problems; incorrect electrical line voltage, fluctuations and surges; customer adjustments and failure to follow operating instructions, maintenance and environmental instructions that are covered and prescribed in the instruction book; product removal and reinstallation; problems caused by pest infestations. This limited warranty does not cover problems resulting from incorrect electric current, voltage or supply, light bulbs, house fuses, house wiring, cost of a service call for instructions, or fixing installation errors. SAMSUNG does not warrant uninterrupted or error-free operation of the product.

EXCEPT AS SET FORTH HEREIN, THERE ARE NO WARRANTIES ON THIS PRODUCT EITHER EXPRESS OR IMPLIED, AND SAMSUNG DISCLAIMS ALL WARRANTIES INCLUDING, BUT NOT LIMITED TO, ANY IMPLIED WARRANTIES OF MERCHANTABILITY, INFRINGEMENT OR FITNESS FOR A PARTICULAR PURPOSE. NO WARRANTY OR GUARANTEE GIVEN BY ANY PERSON, FIRM, OR CORPORATION WITH RESPECT TO THIS PRODUCT SHALL BE BINDING ON SAMSUNG. SAMSUNG SHALL NOT BE LIABLE FOR LOSS OF REVENUE OR PROFITS, FAILURE TO REALIZE SAVINGS OR OTHER BENEFITS, OR ANY OTHER SPECIAL, INCIDENTAL OR CONSEQUENTIAL DAMAGES CAUSED BY THE USE, MISUSE, OR INABILITY TO USE THIS PRODUCT, REGARDLESS OF THE LEGAL THEORY ON WHICH THE CLAIM IS BASED, AND EVEN IF SAMSUNG HAS BEEN ADVISED OF THE POSSIBILITY OF SUCH DAMAGES.

NOR SHALL RECOVERY OF ANY KIND AGAINST SAMSUNG BE GREATER IN AMOUNT THAN THE PURCHASE PRICE OF THE PRODUCT SOLD BY SAMSUNG AND CAUSING THE ALLEGED DAMAGE.

WITHOUT LIMITING THE FOREGOING, PURCHASER ASSUMES ALL RISK AND LIABILITY FOR LOSS, DAMAGE, OR INJURY TO PURCHASER AND PURCHASER'S PROPERTY AND TO OTHERS AND THEIR PROPERTY ARISING OUT OF THE USE, MISUSE, OR INABILITY TO USE THIS PRODUCT. THIS LIMITED WARRANTY SHALL NOT EXTEND TO ANYONE OTHER THAN THE ORIGINAL PURCHASER OF THIS PRODUCT, IS NONTRANSFERABLE AND STATES YOUR EXCLUSIVE REMEDY.

Some states or provinces do not allow limitations on how long an implied warranty lasts, or the exclusion or limitation of incidental or consequential damages, so the above limitations or exclusions may not apply to you. This warranty gives you specific rights, and you may also have other rights, which vary from state to state or province to province.

To obtain warranty service, please contact SAMSUNG at:

In CANADA

Samsung Electronics Canada Inc.

2050 Derry Road West

Mississauga, Ontario L5N 0B9 Canada

1-800-SAMSUNG (726-7864)

www.samsung.com/ca/support (English)

www.samsung.com/ca_fr/support (French)

Warranty

SAMSUNG



Scan the QR code* or visit
www.samsung.com/spsn
to view our helpful
How-to Videos and Live Shows

*Requires reader to be installed on your smartphone

bit.ly/samsungdishwashers

QUESTIONS OR COMMENTS?

COUNTRY	CALL	OR VISIT US ONLINE AT
U.S.A	1-800-SAMSUNG (726-7864) 1-844-SAM-PAYS (726-7297)	www.samsung.com/us/support
CANADA	1-800-SAMSUNG (726-7864) 1-844-SAM-PAYS (726-7297)	www.samsung.com/ca/support (English) www.samsung.com/ca_fr/support (French)
MEXICO	01-800-SAMSUNG (726-7864)	www.samsung.com/mx/support



DD81-02706A-00