

Use & Care Guide
Manual de Uso y Cuidado
English / Español



Model/Modelo: 790.4886*

Kenmore Elite[®]

Electric Built-In Oven

Horno de pared doble

* = color number, número de color

P/N A00538409 Rev. A

Sears Brands Management Corporation
Hoffman Estates, IL 60179 U.S.A.
www.kenmore.com
www.sears.com



Table of Contents

	Before You Call	33
	Oven Baking	33
Cooking Recommendations		9
Oven Controls		13
Care and Cleaning		30

KENMORE LIMITED WARRANTY

WITH PROOF OF SALE the following warranty coverage applies when this appliance is correctly installed, operated and maintained according to all supplied instructions.

One Year on Appliance

FOR ONE YEAR from the date of sale this appliance is warranted against defects in material or workmanship. A defective appliance will receive free repair or replacement at option of seller.

Lifetime on Oven Door Glass

FOR AS LONG AS IT IS USED from the date of sale, free replacement glass will be supplied for defective oven door glass. If the defect appears within the first year, new door glass will be installed at no charge. If the defect appears after the first year, new door glass will be supplied but not installed at no charge. You are responsible for the labor cost of door glass installation after the first year from the date of sale.

For warranty coverage details to obtain free repair or replacement, visit the web page: www.kenmore.com/warranty

All warranty coverage applies for only 90 DAYS from the sale date if this appliance is ever used for other than private household purposes.

This warranty covers ONLY defects in material and workmanship, and will NOT pay for:

1. Expendable items that can wear out from normal use, including but not limited to filters, belts, bags or screw-in base light bulbs.
2. A service technician to clean or maintain this appliance, or to instruct the user in correct appliance installation, operation and maintenance.
3. Service calls to correct appliance installation not performed by Sears authorized service agents, or to repair problems with house fuses, circuit breakers, house wiring, and plumbing or gas supply systems resulting from such installation.
4. Damage to or failure of this appliance resulting from installation not performed by Sears authorized service agents, including installation that was not in accord with electrical, gas or plumbing codes.
5. Damage to or failure of this appliance, including discoloration or surface rust, if it is not correctly operated and maintained according to all supplied instructions.
6. Damage to or failure of this appliance, including discoloration or surface rust, resulting from accident, alteration, abuse, misuse or use for other than its intended purpose.
7. Damage to or failure of this appliance, including discoloration or surface rust, caused by the use of detergents, cleaners, chemicals or utensils other than those recommended in all instructions supplied with the product.
8. Damage to or failure of parts or systems resulting from unauthorized modifications made to this appliance.
9. Service to an appliance if the model and serial plate is missing, altered, or cannot easily be determined to have the appropriate certification logo.

Disclaimer of implied warranties; limitation of remedies

Customer's sole and exclusive remedy under this limited warranty shall be product repair or replacement as provided herein. Implied warranties, including warranties of merchantability or fitness for a particular purpose, are limited to one year on the appliance and for as long used on the oven door glass, or the shortest period allowed by law. Seller shall not be liable for incidental or consequential damages. Some states and provinces do not allow the exclusion or limitation of incidental or consequential damages, or limitation on the duration of implied warranties of merchantability or fitness, so these exclusions or limitations may not apply to you.

This warranty applies only while this appliance is used in the United States.

This warranty gives you specific legal rights, and you may also have other rights which vary from state to state.

Sears Brands Management Corporation, Hoffman Estates, IL 60179

IMPORTANT SAFETY INSTRUCTIONS

Read all instructions before using this appliance.

This manual contains important safety symbols and instructions. Please pay attention to these symbols and follow all instructions given.

Do not attempt to install or operate your appliance until you have read the safety precautions in this manual. Safety items throughout this manual are labeled with a WARNING or CAUTION statement based on the risk type.

Warnings and important instructions appearing in this guide are not meant to cover all possible conditions and situations that may occur. Common sense, caution, and care must be exercised with installing, maintaining, or operating your appliance.

DEFINITIONS

⚠ This is the safety alert symbol. It is used to alert you to potential personal injury hazards. Obey all safety messages that follow this symbol to avoid possible injury or death.

⚠ WARNING - Indicates a potentially hazardous situation which, if not avoided, may result in death or serious injury.

⚠ CAUTION - Indicates a potentially hazardous situation which, if not avoided, may result in minor or moderate injury.

IMPORTANT - Indicates installation, operation, maintenance, or valuable information that is not hazard related.

NOTE - Indicates a short, informal reference – something written down to assist the memory or for future reference.

⚠ WARNING

Tip Over Hazard



- A child or adult can tip the oven and be killed.
- Install the anti-tip device to oven and/or structure per installation instructions.

- Ensure the anti-tip device is re-engaged when the oven is moved.
- Do not operate the oven without the anti-tip device in place and engaged.
- Failure to follow these instructions can result in death or serious burns to children and adults.

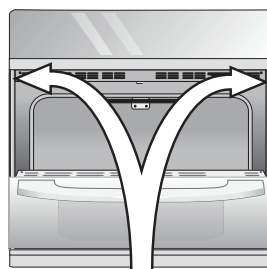

Anti-tip mounting holes

Refer to the installation instructions supplied with your appliance for proper installation.

Check for proper installation with a visual check that the anti-tip screws are present.

Test the installation with light downward pressure on the open oven door. The oven should not tip forward.

IMPORTANT SAFETY INSTRUCTIONS

Read all instructions before using this appliance.

IMPORTANT INSTRUCTIONS FOR UNPACKING AND INSTALLATION

IMPORTANT - Read and follow the below instructions and precautions for unpacking, installing, and servicing your appliance:

Remove all tape and packaging before using the appliance. Destroy the carton and plastic bags after unpacking the appliance. Never allow children to play with packaging material. Do not remove the wiring label and other literature attached to the appliance. Do not remove model/serial number plate.

Cold temperatures can damage the electronic control. When using this appliance for the first time, or when the appliance has not been used for an extended period of time, be sure the appliance has been in temperatures above 32°F (0°C) for at least 3 hours before turning on the power to the appliance.

Never modify or alter the construction of the appliance by removing the leveling legs, panels, wire covers, anti-tip brackets/screws, or any other part of the appliance.

Be sure to have an appropriate foam-type fire extinguisher available, visible, and easily accessible located near the appliance.

GROUNDING INSTRUCTIONS

⚠ WARNING - Avoid fire hazard or electrical shock. Failure to follow this warning may cause serious injury, fire, or death.

⚠ WARNING Avoid fire hazard or electrical shock. Do not use an adapter plug, use an extension cord, or remove grounding prong from the power cord. Failure to follow this warning may cause serious injury, fire, or death.

Proper Installation—Be sure your appliance is properly installed and grounded by a qualified technician. In the United States, install in accordance with the National Fuel Gas Code ANSI Z223.1/NPFA No. 54, latest edition and National Electrical Code NFPA No. 70 latest edition, and local electrical code requirements. In Canada, install in accordance with CAN/CGA B149.1 and CAN/CGA B149.2 and CSA Standard C22.1, Canadian Electrical code, Part 1-latest editions and local electrical code requirements. Install only per installation instructions provided in the literature package for this appliance.

For personal safety, this appliance must be properly grounded. For maximum safety, the power cord must be securely connected to an electrical outlet or junction box that is the correct voltage, is correctly polarized and properly grounded, and protected by a circuit breaker in accordance with local codes.

It is the personal responsibility of the consumer to have the appropriate outlet or junction box with the correct, properly grounded wall receptacle installed by a qualified electrician. It is the responsibility and obligation of the consumer to contact a qualified installer to assure that the electrical installation is adequate and is in conformance with all local codes and ordinances.

See the installation instructions packaged with this appliance for complete installation and grounding instructions.

IMPORTANT SAFETY INSTRUCTIONS

Read all instructions before using this appliance.

IMPORTANT INSTRUCTIONS FOR USING THE APPLIANCE

⚠ WARNING - Storage In or On Appliance—Flammable materials should not be stored in an oven or microwave, near surface burners or elements, or in the storage or warmer drawer (if equipped). This includes paper, plastic, and cloth items, such as cookbooks, plastic ware, and towels, as well as flammable liquids. Do not store explosives, such as aerosol cans, on or near the appliance.

⚠ WARNING - Do not leave children alone - Children should not be left alone or unattended in the area where appliance is in use. They should never be allowed to sit or stand on any part of the appliance, including the storage drawer, lower broiler drawer, warmer drawer, or lower double oven.

⚠ WARNING - Do not store items of interest to children in the cabinets above the appliance or on the backguards of ranges. Children climbing on or near the appliance to reach items could be seriously injured.

⚠ WARNING - Do not allow children to climb or play around the appliance. The weight of a child on an open oven door may cause the appliance to tip, resulting in serious burns or other injury. An open drawer when hot may cause burns.

⚠ WARNING - Stepping, leaning, or sitting on the door or drawers of this appliance can result in serious injuries and also cause damage to the appliance.

⚠ WARNING - Never cover any slots, holes or passages in the oven bottom or cover and entire rack with materials such as aluminum foil. Doing so blocks air flow through the oven and may cause carbon monoxide poisoning. Aluminum foil linings may also trap heat, causing a fire hazard.

⚠ WARNING - Do not use oven or warmer drawer (if equipped) for storage.

⚠ WARNING - Never use your appliance as a space heater to heat or warm the room. Doing so may result in carbon monoxide poisoning and overheating of the appliance.

⚠ CAUTION - When heating fat or grease, watch it closely. Grease may catch fire if it becomes too hot.

⚠ CAUTION - Do not use water or flour on grease fires. Smother fire or flame or use dry chemical or foam-type extinguisher. Cover the fire with a pan lid or use baking soda.

⚠ CAUTION - Use dry potholders. Moist or damp potholders on hot surfaces may result in burns from steam. Do not let potholders touch hot cooking areas. Do not use towels or other bulky cloths.

⚠ CAUTION - Do not heat unopened food containers - Build-up of pressure may cause container to burst and result in injury.

⚠ CAUTION - Wear proper apparel - Loose-fitting or hanging garments should never be worn while using the appliance. Do not let clothing or other flammable materials contact hot surfaces.

⚠ CAUTION - Do not touch surface burners or elements, areas near these burners or elements, interior surfaces of the oven, or the warmer drawer (if equipped). Surface burners and elements may be hot even though they appear cool. Areas near surface burners and elements may become hot enough to cause burns. During and after use, do not touch, or let clothing or other flammable materials touch these areas until they are cool. These areas may include the cooktop, surfaces facing the cooktop, oven vent areas, oven door, and oven window.

Save these instructions for future reference.

IMPORTANT SAFETY INSTRUCTIONS

Read all instructions before using this appliance.

⚠ CAUTION - Do not attempt to operate the appliance during a power failure. If the power fails, always turn off the appliance. If the appliance is not turned off and the power resumes, electric surface elements may resume operation when power is restored. Once the power resumes, reset the clock and the oven function.

IMPORTANT INSTRUCTIONS FOR USING YOUR OVEN

Protective liners—Do not use aluminum foil, aftermarket oven liners, or any other materials or devices to line oven bottom, oven racks, or any other part of the appliance. Only use aluminum as recommended for baking, such as lining cookware or as a cover placed on food. Any other use of protective liners or aluminum foil may result in a risk of electric shock or fire or a short circuit.

Use care when opening oven door, lower oven door, or warmer drawer (some models). Stand to the side of the appliance when opening the door of a hot oven. Let hot air or steam escape before you remove or replace food in the oven.

Keep oven vent ducts unobstructed. Touching surfaces in this area when the oven is on may cause severe burns. Do not place plastic or heat-sensitive items on or near the oven vent. These items can melt or ignite.

Placement of oven racks - Always place oven racks in desired location while oven is cool. If rack must be moved while oven is hot, do not let potholder contact hot burner or element in oven. Use potholders and grasp the rack with both hands to reposition. Remove all cookware and utensils before moving the rack.

Do not use a broiler pan without its insert. Broiler pans and inserts allow dripping fat to drain away from the high heat of the broiler. Do not cover the broiler insert with aluminum foil; exposed fat and grease could ignite.

Do not cook food on the oven bottom. Always cook in proper cookware and always use the oven racks.

IMPORTANT INSTRUCTIONS FOR CLEANING YOUR APPLIANCE

⚠ CAUTION - Before manually cleaning any part of the appliance, be sure all controls are turned off and the appliance is cool. Cleaning a hot appliance can cause burns.

Clean the appliance regularly to keep all parts free of grease that could catch fire. Do not allow grease to accumulate. Greasy deposits in the fan could catch fire.

Always follow the manufacturer's recommended directions for use of kitchen cleaners and aerosols. Be aware that excess residue from cleaners and aerosols may ignite causing damage and injury.

Clean ventilating hoods frequently - Grease should not be allowed to accumulate on hood or filter. Follow the manufacturer's instructions for cleaning vent hoods.

IMPORTANT SAFETY INSTRUCTIONS

Read all instructions before using this appliance.

IMPORTANT INSTRUCTIONS FOR SELF CLEANING OVENS

Do not clean the oven door gasket. The door gasket is essential for a good seal. Care should be taken not to rub, damage, or move the gasket.

Do not use oven cleaners. No commercial oven cleaner or oven liner protective coating of any kind should be used in or around any part of the appliance.

Use the self clean cycle to clean only the parts listed in this manual.

Before using self clean, remove the broiler pan, any food, utensils, and cookware from the oven, storage drawer or warming drawer (if equipped). Remove oven racks unless otherwise instructed.

Some birds are extremely sensitive to the fumes given off during the self clean cycle of any oven. Move birds to another well-ventilated room.

IMPORTANT INSTRUCTIONS FOR SERVICE AND MAINTENANCE

Do not repair or replace any part of the appliance unless specifically recommended in the manuals. All other servicing should be done only by a qualified technician. This reduces the risk of personal injury and damage to the appliance.

Always contact your dealer, distributor, service agent, or manufacturer about problems or conditions you do not understand.

Ask your dealer to recommend a qualified technician and an authorized repair service. Know how to disconnect the power to the appliance at the circuit breaker or fuse box in case of an emergency.

Remove the oven door from any unused oven if it is to be stored or discarded.

Do not touch a hot oven light bulb with a damp cloth. Doing so could cause the bulb to break. Handle halogen lights (if equipped) with paper towels or soft gloves. Disconnect the appliance or shut off the power to the appliance before removing and replacing the bulb.

⚠ WARNING California Residents: for cancer and reproductive harm information, visit www.P65Warnings.ca.gov

Remote Operation – This appliance is configurable to allow remote operation at any time. Do not store any flammable materials or temperature sensitive items inside, on top or near surface units of the appliance.

This device complies with part 15 of FCC Rules, IC RSS 102 Rules, and Canadian ICES-003 Rules. The term “IC” before the radio certification number only signifies that Industry Canada technical specifications were met. Operation is subject to the following two conditions:

1. This device may not cause harmful interference, and
2. This device must accept any interference received including interference that cause undesired operation.

For products sold in the US and Canadian markets, only channels 1~11 are available. You cannot select any other channels.

This equipment has been tested and found to comply within the limits for a Class B digital device, pursuant to part 15 of the FCC Rules. These limits are designed to provide reasonable protection against harmful interference in a residential installation.

IMPORTANT SAFETY INSTRUCTIONS

Read all instructions before using this appliance.

This equipment generates, uses, and can radiate radio frequency energy and, if not installed and used in accordance with the instructions, may cause harmful interference to radio communications. However, there is no guarantee that interference will not occur in a particular installation. If this equipment does cause harmful interference to radio or television reception, which can be determined by turning the equipment off and on, the user is encouraged to try to correct the interference by one or more of the following measures:

- Reorienting or relocating the receiving antenna
- Increasing the separation between the equipment and receiver
- Connecting the equipment to an outlet that is on a different circuit than the radio or TV
- Consulting the dealer or an experienced radio/TV technician for help.

This equipment complies with FCC and IC RSS-102 radiation exposure limits set forth for an uncontrolled environment. This equipment should be installed and operated so there is at least 8 inches (20 cm) between the radiator and your body. This device and its antenna(s) must not be co-located or operated in conjunction with any other antenna or transmitter.

Any changes or modifications not expressly approved by the party responsible for compliance could void the user's authority to operate the equipment.

PRODUCT RECORD

In the space below, record the date of purchase, model and serial number of your product. You will find the model and serial number printed on an identification plate. See [Figure 1](#) for serial plate location.

Model No. _____

Serial No. _____

Date of Purchase _____

Save sales receipt for future reference.

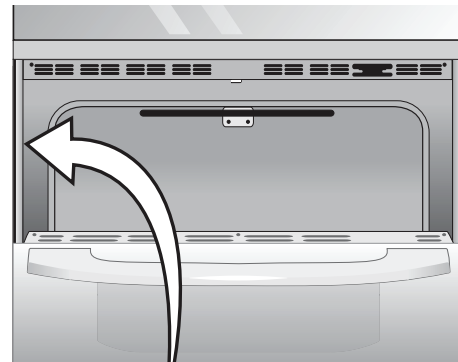



Figure 1: Serial tag location

To locate the serial plate, open the oven door. The serial plate is attached to the left side of the oven frame.

Cooking Recommendations

Bakeware

The material of bakeware affects how evenly and quickly it transfers heat from the pan to the food.

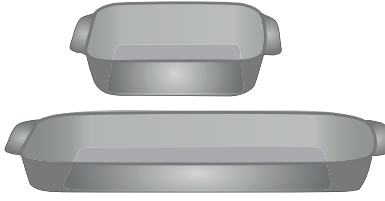
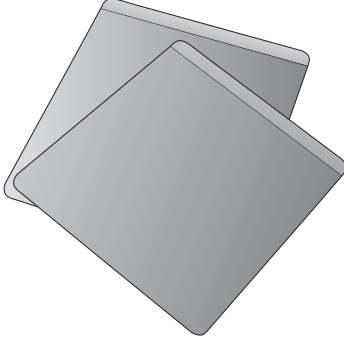
Material	Attributes	Recommendation
<p>Shiny metal bakeware</p> 	<p>Shiny, aluminum, and non-coated bakeware is the best for even heating. It is suitable for all baked goods.</p>	<p>Recommended cooking temperatures and times are based on shiny metal bakeware.</p>
<p>Dark metal bakeware</p> 	<p>Dark bakeware cooks hotter than shiny bakeware.</p>	<p>Reduce the cooking temperature by 25° F (13-14° C) when using dark bakeware.</p>
<p>Glass bakeware</p> 	<p>Glass bakeware cooks hotter than shiny bakeware.</p> <p>Glass is convenient, as the same piece of bakeware can be used for cooking, serving, and storing food.</p>	<p>Reduce the cooking temperature by 25° F (13-14° C) when using glass bakeware.</p>
<p>Insulated bakeware</p> 	<p>Insulated bakeware cooks cooler than shiny bakeware.</p> <p>Insulated bakeware is designed for baking in gas ovens.</p>	<p>Increase the cooking temperature by 25° F (13-14° C) when using insulated bakeware.</p>

Cooking Recommendations

Cooking Conditions

Conditions in your kitchen can affect the performance of your appliance when cooking food.

Condition	Attributes	Recommendation
Aging cookware	As pans age and become discolored, cooking times may need to be reduced slightly.	If food is too dark or overcooked, use the minimum cook time in the recipe or packaging. If food is too light or undercooked, use the middle to maximum cook time in the recipe or packaging.
High altitude	Air is drier and air pressure is lower. Water boils at a lower temperature, and liquids evaporate faster. Foods may take longer to bake. Doughs may rise faster.	Adjust cooking temperature, cooking time, or recipes as needed. Increase amount of liquid in baking recipes. Increase cook time on cooktop. Cover dishes to reduce evaporation. Increase bake time or oven temperature. Reduce amount of baking soda or baking powder in recipe. Reduce rising time or punch down dough and allow it to rise twice.

Cooking Results

Small adjustments may fix a problem with food not being as done as you like or more done than you like.

Result	Recommendation
Food too light	Use the middle to maximum cook time recommended on packaging or recipe.
Food too dark	Use the minimum cook time recommended on packaging or recipe.

Cooking Tips

Use these additional tips to get the best results from your appliance.

Cooking	Tips
	Baking
Rack placement	Follow the instructions in “Oven Control Features” on starting on page 13 . When using only one rack, place the rack so the food is in the center of the oven.
Preheat	Fully preheat the oven before baking items like cookies, cakes, biscuits and breads. Insert food immediately after the beep.
Checking food	Use the window and oven light when checking food. Opening the door may reduce baking performance.
Bake or Convection Bake	Convection bake is the best function to use for baking on multiple racks. For best performance, see “Setting Convection Bake” on page 17 .
Food placement	Allow at least 2 inches (5 cm) of space between bakeware for proper air circulation.

Cooking	Tips
Broiling / Roasting	
<p>Broiling pan</p>	<p>For best results when broiling, use a broil pan with a broil pan insert designed to drain the fat from the food, help avoid spatter, and reduce smoking. The broiler pan will catch grease spills, and the insert helps prevent grease splatters.</p> <p>If a broiler pan and insert are not supplied with this appliance, they may be purchased from Sears. Call 1-844-553-6667 and order broiler pan kit 5304442087.</p>
Convection Cooking	
<p>Convection attributes</p>	<p>Convection cooking uses a fan to circulate hot air around the oven and food. It browns food more evenly and reduces hot spots in the oven.</p> <p>Convection saves time when using multiple racks or cooking several food items at once.</p>
<p>Convection bake</p>	<p>Reduce cooking temperature by 25° F (13-14° C) from the recipe unless the recipe is written for convection baking.</p> <p>Preheat the oven for best results.</p>
<p>Convection roast</p>	<p>Convection roast is best for meats and does not require preheating for most meats and poultry.</p> <p>Reducing the cooking temperature for convection roast is not recommended. Carefully follow your recipe's temperature and time recommendations, adjusting the cooking time if the recipe does not specify convection roasting time.</p> <p>Since convection roast cooks faster, cook time may be reduced by 25% to 40% depending on food type. You can reduce cook times by 25% from the recommended time of your recipe, and check the food at this time. If needed, continue cooking until the desired doneness is obtained.</p> <p>Use a meat probe if available with your appliance. Meat probes are also available from most grocery and home goods stores.</p> <p>Arrange oven racks so large cuts of meat and poultry are on the lowest rack of the oven.</p> <p>Do not cover foods when dry roasting - covering will prevent the meat from browning properly.</p> <p>When cooking meats, use the broiler pan and insert or a roasting rack. The broiler pan will catch grease spills and the insert helps prevent grease splatters. If a broiler pan and insert are not supplied with this appliance, they may be purchased from Sears. Call 1-844-553-6667 and order broiler pan kit 5304442087.</p>

Oven Vent Location

The oven is vented as shown below. When the oven is on, warm air is released through the vent. This venting is necessary for proper air circulation in the oven and good baking results. Do not block oven vent. Never close off the openings with aluminium foil or any other material. Steam or moisture may appear near the oven vent. This is normal.

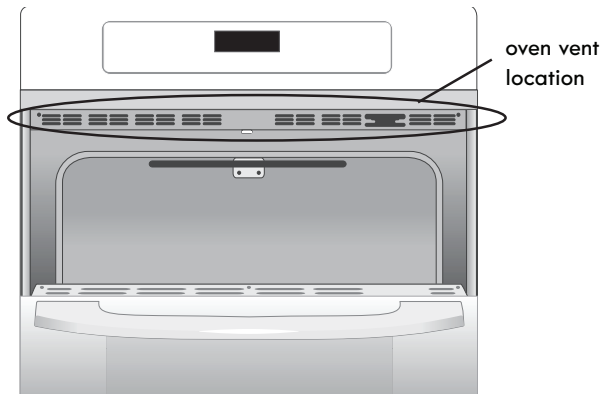

Figure 2: Vent at top of oven doors

CAUTION Always use pot holders or oven mitts when using the oven. When cooking, the oven interior, oven exterior, oven racks, and cooktop will become very hot which can cause burns.

To prevent possible damage to the oven, do not attempt to close the oven door until all the oven racks are fully positioned back inside the oven cavity.

WARNING Protective Liners — **Do not** use aluminum foil or any other material or liners to line the oven bottom, walls, racks or any other part of the range. Doing so will alter the heat distribution, produce poor baking results, and possibly cause permanent damage to the oven interior. Improper installation of these liners may result in risk of electric shock or fire. During self clean, temperatures in the oven will be hot enough to melt foil.

Types of oven racks

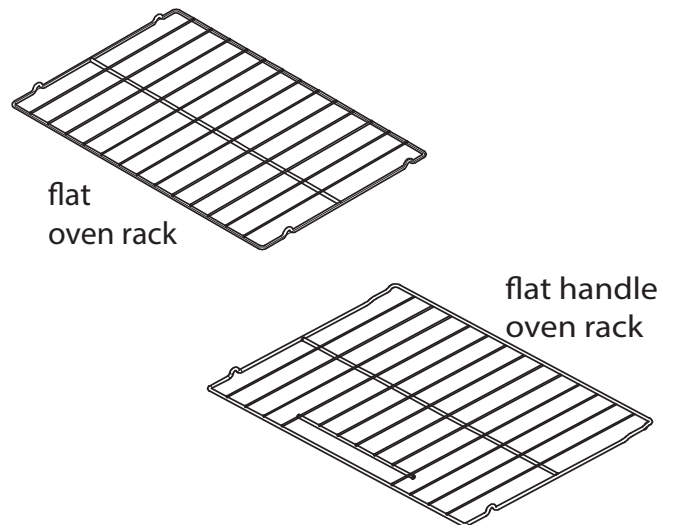

Figure 3: Oven rack types

- **Flat oven racks** may be used for most cooking needs and may be placed in most oven rack positions.

Removing, replacing, and arranging flat or offset oven racks

Always arrange the oven racks when the oven is cool.

To remove - Pull the oven rack straight forward until it reaches the stop position. Lift up front of oven rack slightly and slide out.

To replace - Place the oven rack on the rack guides on both sides of oven walls. Tilt the front of oven rack upward slightly and slide the oven rack back into place. Be sure oven racks are level before using.

Porcelain coated oven racks:

This model comes with lubricated porcelain oven racks, which can remain in the oven during the self-clean cycle. Do not clean this vegetable oil lubrication off the racks. It is important that the sides of the oven racks always have a light coating of vegetable oil.

To maintain optimal rack performance, re-apply a thin layer of vegetable oil to the sides of the rack after every self-clean cycle or when the rack becomes difficult to slide.

Oven Controls

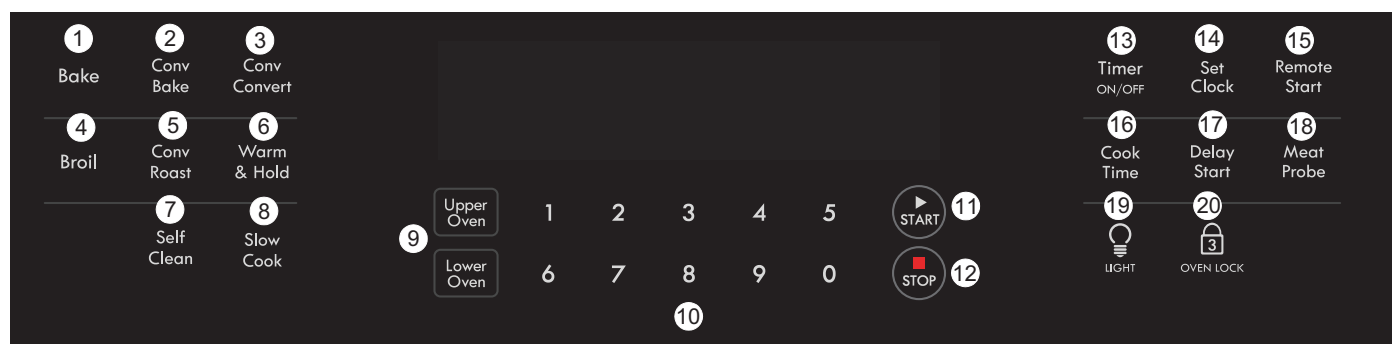

Oven Control Features

1. **Bake** - Use to select the regular bake function.
2. **Conv Bake** - Use to select the convection baking to obtain the best results when baking with multiple pans and racks.
3. **Convection Convert** - Use to change regular recipe convection bake temperatures for convection baking.
4. **Broil** - Use to select the broil function.
5. **Conv Roast** - Use to select the convection roasting for cooking tender cuts of beef, lamb, pork, and poultry. Use this mode when cooking speed is desired.
6. **Warm & Hold** - Use to select Warm & Hold function which keeps cooked food at serving temperature up to 3 hours.
7. **Self Clean** - Use to set a time between 2 and 4 hour self clean cycle. The default time is 3 hours.
8. **Slow Cook** - Use for cooking foods requiring long cooking times at lower temperatures.
9. **Upper and Lower Oven** - Use to select oven for cooking.
10. **0 thru 9 keys** - Use to enter oven temperatures and times.
11. **START** - Use to start all oven functions.
12. **STOP** - Use to stop any cooking function.
13. **Timer ON/OFF** - Use to set or cancel the timer. The minute timers will not start or cancel cooking functions.
14. **Set Clock** - Use to set time of day.
15. **Remote Start** - Uses smartphone app to control certain oven functions remotely.
16. **Cook Time** - Use to enter length of desired cooking time.
17. **Delay Start** - Use to set the desired start time for baking. May be used with Cook Time to program a delayed bake cycle or a delayed clean cycle.
18. **Meat Probe** - Use to check the internal temperature of such meats as roasts, hams, or poultry.
19. **Oven Light** - Use to turn oven lights on and off.

20. **Oven Lock** - Use in conjunction with the lock icon to lock oven functions and door.

Minimum and Maximum Control Settings

All of the features listed have minimum and maximum time and temperature settings that may be entered into the control. An entry acceptance beep will sound each time a key is touched. An entry error tone (three short beeps) will sound if the entry of the temperature or time is below the minimum or above the maximum settings for the feature.

Feature	Min. Temp or Time	Max. Temp or Time
Bake	170°F (77°C)	550°F (288°C)
Broil	400°F (205°C)	550°F (288°C)
Timer	1 minute	11 hrs. 59 mins.
Conv bake	170°F (77°C)	550°F (288°C)
Conv Roast	170°F (77°C)	550°F (288°C)
Warm & Hold	170°F (77°C)	3 hours
Slow Cook	LO 225°F (108°C)	HI 275°F (134°C)
Self Clean	2 Hours	4 Hours
Cook Time (12Hr)	0:01 Min	11:59 Hr./Min
Cook Time (24Hr)	0:01 Min	23:59 Hr./Min
Delay Time (12Hr.)	0:01 Min	12:59 Hr./Min
Delay Time(24Hr.)	0:01 Min	23:59 Hr./Min
Clock 12 Hr.	1:00 Hr./Min	12:59 Hr./Min
Clock 24 Hr.	0:00 Hr./Min	23:59 Hr./Min

Oven Controls

Setting the Clock

When the appliance is first powered on, 12:00 will flash in the display. The time of day must first be set before operating the oven.



To set clock for 1:30:

1. Press .
2. Enter 1 3 0 using number keys.
3. Press .

Important note:

The clock cannot be changed when a Cook Time, Self Clean, Delay Start, or cooking feature is active.

Setting Timer

The minute timer allows you to track your cooking times without interfering with the cooking process. The timer may be set from a minimum time of 1 minute to a maximum of 11 hours and 59 minutes.

To set timer for 5 minutes:

1. Press **Timer ON/OFF**.
2. Enter 5 using number keys.
3. Press **Timer ON/OFF** again.
4. When the time runs out, **END** appears in the display and the control will beep three times every 30 seconds until **Timer ON/OFF** is pressed.

To cancel the timer when active, press **Timer ON/OFF** again.



Important:

- The timer does not start or stop the cooking process. It serves as an extra minute timer that will sound an alert tone when the set time has run out. The timer may be used alone or while using any of the other oven functions.
- When the timer is set for more than 1 hour it will display hours and minutes until 1 hour remains. When less than 1 hour remains, the display counts down in minutes and seconds. With less than 1 minute remaining, only seconds will display.
- If the timer is active during a cooking process, the timer will show in the display. To view the status of any other active oven function, press the key of the cooking function once and it will appear in the display for a few seconds.

Setting 12 or 24 Hour Display Mode

The clock display mode allows you to choose between the 12 or 24 hour modes. The factory pre-set clock mode is 12 hours.

To set 12 or 24 hour display mode:

1. Press and hold  for 6 seconds.
2. Press **Self Clean** to toggle between 12 Hr day or 24 Hr day display modes.
3. Press  to accept choice.



Changing Between Continuous Bake Setting or 12 Hour Energy Saving Feature

The oven control has a factory preset 12 hour energy saving feature that will turn off the oven after 12 hours of continuous cooking. The control may be programmed to bake continuously.

To change between continuous bake or 12 hour energy saving feature:

1. Press and hold **Timer ON/OFF** for 6 seconds until **12 Hour OFF** or **Stay On** appears.
2. Press **Self Clean** to toggle between **12 Hour OFF** or **Stay On** feature.
3. Press  to accept choice.



Changing Oven Temperature Display

The oven control is preset to display temperatures in Fahrenheit (°F). The control can be changed to display either (°F) or Celsius (°C).

To change the temperature to display °C or °F:

1. Press and hold **Broil** for 6 seconds.
2. Once **F** (or **C**) appears in the display, press **Self Clean** to toggle between (°F) and (°C) temperature display modes.
3. Press  to accept choice.

Important note:

The oven temperature display cannot be changed during the cooking process, if a Delay Start has been set, or if Self Clean is active



Setting Silent or Audible Control Mode

Silent mode allows the oven control to operate without audible tones. The control may be programmed for silent operation and later reset to operate with all the normal audible tones.

To set for silent or audible mode:

1. Press and hold **Delay Start** for 6 seconds.
2. Press **Self Clean** key to toggle between **bEEP On** or **bEEP OFF**.
3. Press  to accept choice.



Setting Oven Lock

The control may be programmed to lock the oven door and lock the oven control. The Upper and Lower ovens can be locked separately.

To activate the oven lockout features: Be sure the oven door is completely closed.

1. Select **Upper or Lower Oven**.
1. Press and hold  for 3 seconds. **Loc** will appear in the display. The motor driven door latch mechanism will begin locking the oven door automatically. Do not open the oven door. Allow about 15 seconds for the oven door to completely lock.
2. Once door is locked, **Loc** will appear in the display.

To unlock the oven door:

1. Press and hold  for 3 seconds.
2. The motor driven door latch mechanism will begin unlocking the oven door automatically. Do not try to open the oven door. Allow about 15 seconds for the oven door to completely unlock.



LIGHT

Operating Oven Lights

The interior oven lights will turn on when the oven door is opened. Leave oven light off while baking.

Press **oven light** key to turn oven light on or off whenever the oven door is closed. The interior oven lights are located on the rear wall of the oven interior and are covered with a glass shield. The glass shield protects the bulb from high temperatures and should always be in place whenever the oven is in use.

NOTE: Leave oven light off while baking.

Important: The oven light will not operate during a self clean cycle and will not operate during Sabbath unless turned on before setting controls for Sabbath. To replace the interior oven lights, see [“Replacing the oven light”](#) on [page 31](#).

Oven Controls

Setting Bake

Use the bake feature whenever the recipe calls for baking using normal temperatures. A reminder tone will sound indicating when the set bake temperature is reached and to place the food in the oven. When setting Bake or any cooking feature that preheats the oven, the convection fan will turn on and stay on until the oven reaches set temperature.

Bake may be set for any oven temperature between 170°F (77°C) and 550°F (288°C).

Baking Tips

- Fully preheat the oven before baking items like cookies, biscuits, and breads.
- When using any single rack, position the rack so that the food is in the center of the oven.
- Bake is the recommended mode when baking cakes on multiple racks.
- Convection baking is recommended for multiple racks baking for items such as cookies and biscuits.
- For best results when baking cakes using two oven racks, place racks in positions 2 and 4 (See [Figure 5](#)).
- When baking items such as cookies and biscuits using two oven racks, place racks in positions 1 and 4. Note: For best results use Convection bake for items such as cookies and biscuits.
- When baking using two oven racks, position bakeware as shown in [Figure 4](#). Allow at least 2 inches (5 cm) of space between bakeware for proper air circulation.
- Dark or dull pans absorb more heat than shiny bakeware, resulting in dark or overbrowning of foods. It may be necessary to reduce the oven temperature or cook time to prevent overbrowning of some foods.
- Shiny pans are recommended for cakes, cookies, and muffins.
- Do not open the oven door often. Opening the door will reduce the temperature in the oven and may increase cook time.

⚠ CAUTION Always use pot holders or oven mitts when using the oven. When cooking the oven interior and oven racks will become very hot which can cause burns.

To set Bake with default temperature of 350°F:

1. Place racks in desired positions.
2. Press **Upper Oven** or **Lower Oven** key.
3. Press **Bake**.
4. Press .

To cancel Bake at anytime, press .

To set Bake for oven temperature of 425°F:

1. Place racks in desired positions.
2. Press **Upper Oven** or **Lower Oven** key.
3. Press **Bake**.
4. Enter **4 2 5** using number keys.
5. Press .

To cancel Bake at any time, press .

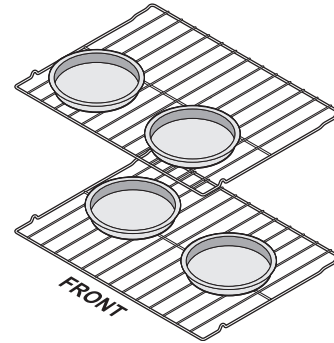

Figure 4: Pan placement

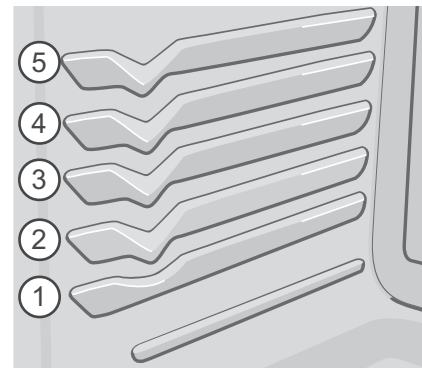

Figure 5: Rack position

Setting Convection Bake

Convection functions use a fan to circulate the oven's heat uniformly and continuously around the oven. This improved heat distribution allows for fast, even baking and browning results. It also gives better baking results when using two oven racks at the same time. Heated air flows around the food from all sides, sealing in juices and flavors.

Convection Bake may be set for any oven temperature between 170°F (77°C) to 550°F (288°C).

Benefits of Convection Bake:

- Multiple oven racks

Important:

- Fully preheat the oven before baking.
- The convection bake feature is best used when the recipe instructions have been written especially for convection baking.
- Convection baking is recommended for multiple racks baking for items such as cookies and biscuits.
- When using convection bake for cakes using two oven racks, place racks in positions 2 and 4 and position bakeware as shown in [Figure 6](#).
- For best results when using two oven racks for baking items like cookies and biscuits place racks in positions 1 and 4.
- Unless the recipe is written for convection cooking, use Conv Convert to reduce oven temperature from the recipe's recommended oven temperature.
- Do not open the oven door often. Opening the door will reduce the temperature in the oven and may increase cook time.

Important note: The convection fan will begin rotating once convection bake or convection roast has been activated. If the oven door is opened when the convection function is active, the convection fan will stop rotating until the oven door is closed.

CAUTION Always use pot holders or oven mitts when using the oven. When cooking the oven interior and oven racks will become very hot which can cause burns.

CAUTION Do not bake foods directly on the oven bottom. To avoid damaging the oven interior and surfaces, always bake foods in the oven using bakeware positioned on an oven rack.

To set Conv Bake with a default oven set temperature of 350°F (177°C):

1. Press **Upper** or **Lower Oven**.
2. Press **Conv Bake**.
3. Press **START**.

To cancel Conv Bake at any time, press **STOP**.

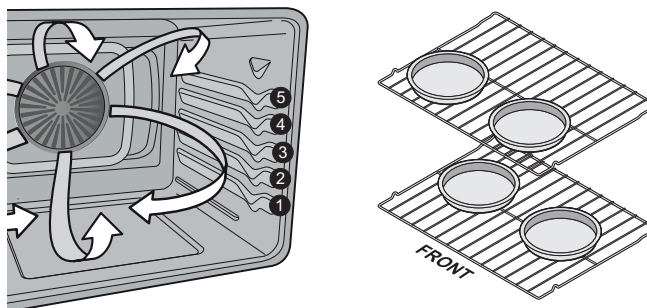

Figure 6: Convection baking on multiple levels/racks

Setting Convection Convert

The **Conv Convert** key is used to automatically convert a standard baking recipe for convection baking. Convection convert must be used with convection bake set for a bake time of more than 20 minutes. A cook time or delay start function may be added.

Using the convection convert feature (during convection bake) to automatically adjust oven temperature:

1. Arrange interior oven racks.
2. Press **Upper** or **Lower Oven**.
3. Press **Conv Bake**. The oven will start baking at the default temperature of 350°.
4. If a cook time or delay start is desired enter times now.
5. Press **Conv Convert**.
6. Press **START**.

The temperature conversion of 325° will appear briefly in the display. A beep will sound once the adjusted temperature is reached.

Note: When used with a cook time or a delay start setting, the convection convert feature will display a **CF** for check food when the bake time is 75% complete. At this time the oven control will sound three beeps at regular intervals until baking has finished.

When the bake time has completely finished the display will show **End** and the control sound three beeps every 30 seconds until **STOP** is pressed.

Oven Controls

Setting Cook Time

Use Cook Time to program the oven control to automatically turn off after a desired length of time.

To program oven to Bake with oven default temperature of 350°F and to shut-off after 30 minutes:

1. Press **Upper Oven** or **Lower Oven** key.
2. Press **Bake**.

Important: The oven will take a few minutes to preheat. If your exact baking time is 30 minutes, put the food in when the preheat tone sounds and then set **Cook Time** (steps 3 and 4)

3. Press **Cook Time**.
4. Enter **3 0** using number keys.
5. Press  to accept.
6. The oven will start Bake immediately.

When the programmed cook time ends, **End** will appear in the display window, and the oven will shut-off automatically. The oven control will beep three times every 30 seconds as a reminder until  key is pressed.

End

Important note:

- The Cook Time feature may be set with Delay Start and most cooking features except Broil. The maximum default Cook Time setting is 11 hours and 59 minutes.
- To check the time remaining during a timed cooking function, press **Cook Time** once and the time remaining will appear in the display momentarily.

Setting Delay Start

The **Delay Start** feature delays starting time to oven cooking or cleaning functions. Prior to setting a delay start, be sure the time of day is set correctly.

⚠ WARNING Food Poisoning Hazard. Do not let food sit for more than one hour before or after cooking. Doing so can result in food poisoning or sickness. Foods that can easily spoil such as milk, eggs, fish, meat, or poultry should be chilled in the refrigerator first. Even when chilled, they should not stand in the oven for more than 1 hour before cooking begins and should be removed promptly when finished cooking.

To program oven for a Delay Start beginning at 5:30, to shut-off automatically after 50 minutes, and for baking at 375°F:

1. Press **Upper Oven** or **Lower Oven** key.
2. Press **Bake**.
3. Enter **3 7 5** using number keys.
4. Press **cook time**.
5. Enter **5 0** using number keys.
6. Press **Delay Start**.
7. Enter **5 3 0** using number keys.
8. Press .

The oven will begin the cooking process at 5:30. When the programmed cook time ends, **End** will appear in the display window, and the oven will shut off automatically. The oven control will beep three times every 30 seconds as a reminder until  is pressed.

Important note:

Delay Start may be set using a 24 hour clock. See [“Setting 12 or 24 Hour Display Mode”](#) on [page 14](#) for more information. The Delay Start feature may be used with most cooking features including Slow Cook and Self Clean.

Smart Features



GETTING CONNECTED

You need the following devices and applications to use the smart features on your appliance.

Required Devices: A wireless router, Kenmore Elite Smart Appliance, and a mobile device.

Required Application: Kenmore Smart App.

You must download the Kenmore Smart app to your mobile device, connect your Kenmore Smart appliance to the internet, and register the appliance to your account in order to use the Remote Start function.

Connecting the Appliance to the Internet

Refer to the Quick Start Guide that came with your smart appliance for detailed instructions on creating a Kenmore account and setting up the appliance for connected operation from your smart phone. For additional assistance, visit <http://www.kenmore.com/smart>.

Remote cooking functions must be set with a Cook Time and/or a Meat Probe temperature set-point to ensure that the function does not run indefinitely.

When the Remote Start key is pressed, the Remote Start indicator light will turn ON if previously OFF and OFF if previously ON. Remote operation of a cooking function is not allowed in the event that Remote Start is not ON.

REMOTE START

Use a smart phone to control your appliance remotely.

NOTE: For better performance and safety this function can only be used with certain cycles and options. You must first close the door and connect to the internet to use this function. The SMART icon LED should be illuminated. Once the Remote Start option is enabled, it will remain ON until either the user deactivates the function, a long power loss occurs or communication is lost between oven control and the smartphone. To program most oven functions the Remote Start key must first be activated manually before using the app.

To use Remote Start:

1. Press **Remote Start**. The Remote Start LED will turn on.
2. Select a function and options.
3. Start the appliance from the application on your smart phone. (For more information, see the booklet shipped with your appliance.) If you do not start the appliance remotely, the control will wait to start the cycle until the START button is pressed.

The following features are allowed to be set remotely whether Remote Start is enabled or not:

- TOD (Time of Day)
- Kitchen Timer
- F/C Temperature Mode
- 12/24 Hour mode
- Silent Mode
- UPO (User Programmable Offset)
- Energy Savings
- Meat Probe Set-Point

The following features are allowed to be set remotely only when Remote Start is enabled:

- Programming of allowed cooking functions
- Cancellation of cooking functions
- Cavity Light

These following features do not allow Remote Start:

- Clean
- Broil
- Convection Broil (Open or Closed Door)
- Remote operation of Door Lock

Important: In the event that a function (not including Clean) is actively running, and the user wants to change to a new function, the active function must first be canceled. After that, a new command for a different cooking function may be set remotely.

Oven Controls

Setting Broil

Use the Broil function to cook meats that require direct exposure to radiant heat for optimum browning results. The Broil feature is factory preset to broil at 550°F. The Broil function temperature may be set at any temperature between 400°F (205°C) and 550°F (288°C). The suggested broil settings are recommendations only (See Table 1). If the food you are broiling is not listed in Table 1, follow the instructions provided in your cookbook and watch the item closely.

⚠ WARNING Should an oven fire occur, close the oven door and turn the oven off. If the fire continues, use a fire extinguisher. Do not put water or flour on the fire. Flour may be explosive.

⚠ CAUTION Always use pot holders or oven mitts when using the oven.

Important:

- **OPEN DOOR BROIL SHUT OFF:** If the oven door is left open during Broil for more than 3 minutes an alarm will sound to notify the user to close the oven door. If the door is not closed the oven will turn off within 30 seconds of the open door alarm.
- When broiling, always pull the oven rack out to the stop position before turning or removing food.
- When cooking, the oven interior, exterior, and oven racks will become very hot which can cause burns. Always arrange oven racks when oven is cool.
- Do not use the broil pan without the insert. Do not cover the insert with foil; the exposed grease could catch fire.

To set Broil with the default broil oven temperature of 550°F:

1. Arrange the oven racks when cool. Position bakeware in oven. Broil may be set with Cook Time and Delay Start.
2. Press **Upper Oven** or **Lower Oven** key.
3. Press **Broil**.
4. Press **START**. Broil with oven door closed.
5. For optimum browning results, preheat oven for 2 minutes before adding food.
6. Position bakeware in oven.
7. Broil one side until food is browned; turn and broil other side until done to your satisfaction.
8. When finished, press **STOP**.
9. To cancel Broil at any time, press **STOP**.

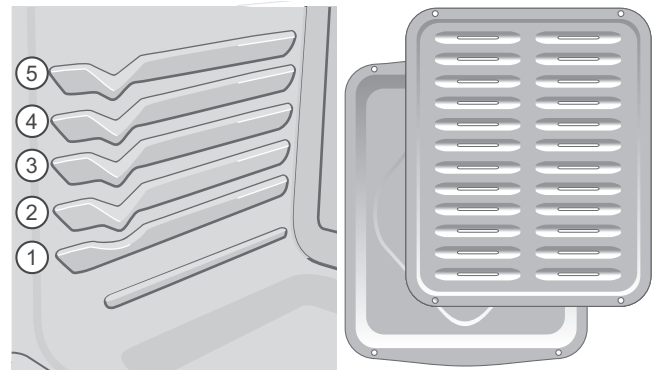

Figure 7: Broil positions and broil pan and insert

For best results when broiling, use broil pan along with pan insert. A broil pan is designed to drain the fat from food, helping to reduce smoking and avoid splatter.

Note: If a broiler pan and insert are not supplied with this appliance, they may be purchased from Sears. Call 1-844-553-6667 and order broiler pan kit 5304442087.

Table 1: Suggested Broil Settings

Food	Rack Position	Setting	Cook time in minutes		Internal Temperature	Doneness
			1st side	2nd side		
Steak, 1 inch thick	5	550F (288°C)	5	4	140°F (60°C)*	Rare*
Steak, 1 inch thick	5	550F (288°C)	7	5	160°F (71°C)	Medium-well
Steak, 1 inch thick	5	550F (288°C)	8	7	170°F (77°C)	Well
Pork Chops, 3/4 inch thick	5	550F (288°C)	9	7	170°F (77°C)	Well
Chicken, bone-in	3	550F (288°C)	20	10	170°F (77°C)	Well
Chicken, boneless	4	550F (288°C)	11	10	170°F (77°C)	Well
Fish	4	550F (288°C)	as directed			Well
Shrimp	3	550F (288°C)	as directed			Well
Hamburger 1" thick	5	550F (288°C)	5	4	140°F (60°C)*	Rare*
Hamburger 1" thick	5	550F (288°C)	9	7	145°F (63°C)	Medium
Hamburger 1" thick	5	550F (288°C)	10	8	170°F (77°C)	Well

* The U.S. Department of Agriculture states, "Rare fresh beef is popular, but you should know that cooking it to only 140°F (60°C) means some food poisoning organisms may survive." (Source: Safe Food Book, Your Kitchen Guide, USDA Rev. August 2017) The lowest temperature recommended by the USDA is 145°F (63°C) for medium rare fresh beef. For well-done 170°F (77°C). All cook times shown are after 2 minutes of preheating. Broiling will produce some smoke. If smoke is excessive, place the food further away from the broil element. Watch food carefully to prevent burning

Oven Controls

Cooking with Meat Probe

Use the meat probe feature for best results when cooking foods such as roasts, hams or poultry. For meats like poultry and roasts, using a probe to check internal temperature is the safest method to ensure properly cooked food.

When set correctly, the probe feature will signal an alert when the internal food temperature reaches the desired set target temperature. When active, the probe displays the internal food temperature which is visible in the display during the cooking process.

⚠ CAUTION

- Do not use kitchen utensils to pull on the probe cable or handles. Always insert and remove the probe using the provided handles, as shown. To avoid damaging the probe, defrost frozen foods completely before inserting.
- To avoid the possibility of burns after cooking with the probe, use care when disconnecting the probe from the receptacle or food. The probe may be hot. Be sure to always use a pot holder to protect your hands.

To properly place the probe:

Insert the probe so that the probe tip rests inside the center of the thickest part of meat or food. For best results, do not allow the probe temperature sensor to contact bone, fat, gristle, or the cookware. For bone-in ham or lamb, insert the probe into the center of lowest large muscle or joint. For meat loaf or casseroles, insert the probe into center of food. When cooking fish, insert meat probe just above the gill. For whole poultry or turkey, fully insert the probe sensor into the thickest part of the breast.

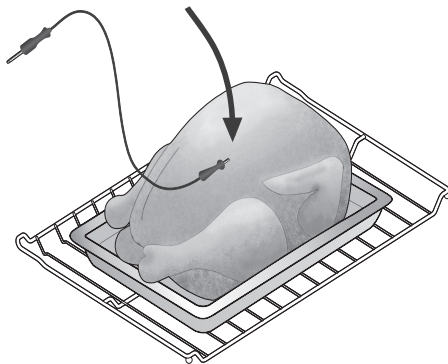

To connect the probe to the oven and start cooking with Meat Probe:

1. Insert the probe into the food and place prepared food on the desired oven rack position and slide into the oven.
2. Plug the connector end of the probe all the way into the probe receptacle while the oven is still cool.
3. Press **Bake** (or Convection Bake or Steam Bake or Roast) and enter cooking temperature.

4. Press **Meat Probe** once. Enter the desired (target) temperature for food type (See [Table 2](#)).

Important note: The minimum setting is 140°F (60°C); the maximum is 210°F (99°C). Default is 170°F (77°C).

5. When the probe is set properly, the actual probe temperature appears in the display. Close the oven door.
6. Press **START** to accept the target temperature and start cooking.
7. To change the target temperature while cooking, press the probe key once. Use the number keys to change the temperature. Press the **start key** to accept any change.
8. When the internal food temperature is reached, the oven will switch to a warm setting (HLd), and the actual probe temperature will alternate in the display. Keep Warm will maintain the oven temperature at 170°F (77°C) for 3 hours unless otherwise cancelled.

To stop cooking at any time, press **STOP**.

Note: During cooking the internal food temperature will display by default. To see the target temperature press the probe key once. After 6 seconds the display will revert to the internal food temperature. Do not remove the probe from the food or receptacle until the desired internal temperature is reached. If the probe is removed from the receptacle only, the probe feature will cancel but the oven will continue to cook. If the probe is removed from the food only, the probe feature will remain active and may eventually generate a probe too hot message.

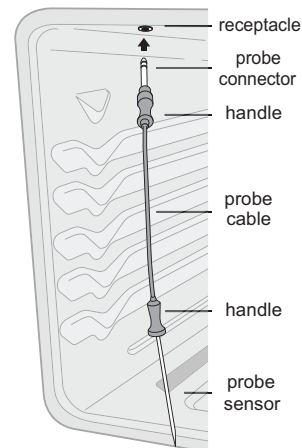

Figure 8: Using the probe

⚠ WARNING Do not store the probe inside the oven. Use only the original probe provided. Before starting self clean, double check that the probe is removed from the oven interior. Use only the original probe provided with this appliance. Connecting any other probe or device into the probe receptacle could result in damage to the oven control, electronics and the receptacle.

Table 2: USDA recommended minimum internal cooking temperatures

Food Type	Doneness	Internal Temperature
Fresh beef, veal, lamb, roasts	Medium rare	145°F (62°C)
	Medium	160°F (71°C)
	Well Done	170°F (77°C)
Chicken and Turkey, whole	Medium-well	165°F (73°C)
Poultry Breasts, thighs, wings, Roasts	Medium-well	165°F (73°C)
Stuffing (cook alone or in bird)	Medium-well	165°F (73°C)
Fresh Pork/Ham	Medium	160°F (71°C)
Fresh (raw)	Medium	160°F (71°C)
Pre-cooked (to reheat)		140°F (60°C)
Eggs dishes		160°F (71°C)
Leftovers and Casseroles		165°F (73°C)

*The U.S. Department of Agriculture states, "Rare fresh beef is popular, but you should know that cooking it to only 140°F (60°C) means some food poisoning organisms may survive." (Source: *Safe Food Book, Your Kitchen Guide*, USDA Rev. August 2017) Visit the USDA Food Safety and Inspection website at www.fsis.usda.gov

To set how the oven will operate once the probe reaches the target temperature:

The oven will automatically stop cooking and start keep warm when probe sensor reaches the target temperature. This may be set to continue cooking if desired. Setting the options once the probe reaches the target temperature must be done when the oven is inactive. The probe does not need to be connected to the receptacle when setting this option.

⚠ CAUTION Always use pot holders or oven mitts when using the oven. When cooking the oven interior and oven racks will become very hot which can cause burns.

To set the oven to continue cooking after reaching the target temperature:

1. Press probe key and hold for 6 seconds.
2. Press self clean key and toggle until Contin appears, as shown below, then press start to accept.

Continu

To set the oven to automatically stop cooking and start warm once reaching target temperature:

1. Press and hold the probe key for 6 seconds.
2. Press the **self clean** key and toggle until **CAnCEL** appears, as shown below, then press **start** to accept.

CAnCEL

PROBE TOO HOT Message:

When the message **PROB... TOO... HOT...** flashes in the display, the probe temperature has exceeded 250°F (121°C). If the probe is not removed, this message may continue until the sensor reaches 300°F (149°C) or higher. At this point the oven will automatically turn off. Be sure the probe sensor is fully covered by the food.

Oven Controls

Setting Convection Roast

The convection roast function combines a cook cycle with the convection fan to roast meats and poultry. Meats cooked using the convection roast function will be juicier and poultry will be crisp on the outside while staying tender and moist on the inside.

Convection roast may be set for any oven temperature between 170°F (77°C) to 550°F (288°C).

Suggestions for Convection Roast:

- Preheating is not necessary when roasting foods using Convection roast. Since convection roast cooks food faster, reduce the cook time up to 25% from the recommended cook time of your recipe. If necessary, increase cooking time until the desired doneness is obtained.
- The broiler pan will catch grease drippings, and the grid will help prevent splatters. The roasting rack will hold the meat. Use the flat rack on rack position 1.
- For small poultry use rack position 2.
- Do not cover foods when dry roasting as this will prevent the meat from browning properly.

To set Convection Roast with a default oven set temperature of 350°F (177°C):

1. Place food on desired rack position and close door.
2. Press **Upper or Lower** oven.

1. Press **Conv Roast**.

2. Press .

To cancel **Conv Roast** at any time, press .

Important note:

- The convection fan will begin rotating once convection roast is activated.
- If the oven door is opened when any convection function is active, the convection fan will stop rotating until the oven door is closed.
- It is not recommended to roast chicken on a roasting rack. Use a deep pan instead and roast on rack position 1.

CAUTION Always use pot holders or oven mitts when using the oven. When cooking the oven interior and oven racks will become very hot which can cause burns.

Table 3: Convection roasting temperature and time recommendations

Meat		Weight	Oven Temp	Internal Temp	Minutes per lb.
Beef	Standing rib roast*	4 to 6 lb.	350°F (177°C)	*160°F (71°C)	25-30
	Rib eye roast*	4 to 6 lb.	350°F (177°C)	*160°F (71°C)	25-30
	Tenderloin roast	2 to 3 lb.	400°F (204°C)	*160°F (71°C)	15-25
Poultry	Turkey whole**	12 to 16 lb.	325°F (163°C)	180°F (82°C)	8-10
	Turkey whole**	16 to 20 lb.	325°F (163°C)	180°F (82°C)	10-15
	Turkey whole**	20 to 24 lb.	325°F (163°C)	180°F (82°C)	12-16
	Chicken	3 to 4 lb.	350°F-375°F (177°C-191°C)	180°F (82°C)	12-16
Pork	Ham roast, fresh	4 to 6 lb.	325°F (163°C)	160°F (71°C)	30-40
	Shoulder blade roast	4 to 6 lb.	325°F (163°C)	160°F (71°C)	20-30
	Loin	3 to 4 lb.	325°F (163°C)	160°F (71°C)	20-25
	Pre-cooked ham	5 to 7 lb.	325°F (163°C)	160°F (71°C)	30-40

The U.S. Department of Agriculture states, "Rare fresh beef is popular, but you should know that cooking it to only 140°F (60°C) means some food poisoning organisms may survive." (Source: Safe Food Book, Your Kitchen Guide, USDA Rev. Aug 2017) The lowest temperature recommended by the USDA is 145°F (63°C) for medium rare fresh beef. For well done 170°F (77°C)

** Stuffed turkey requires additional roasting time. Shield legs and breast with foil to prevent over browning and drying of the skin.

Setting the Slow Cook feature

The Slow Cook feature may be used to cook foods more slowly, at lower oven temperatures and is ideal for roasting beef, pork and poultry. Slow Cooking may result in the exterior of meats becoming dark but not burnt. This is normal. There are 2 Slow Cook settings, high (Hi) or low (Lo). The low setting is best for cooking foods from 8 to 9 hours. The high setting is best for cooking foods from 4 to 5 hours. The maximum cook time for Slow Cook is 12 hours unless the oven control has been changed to the Continuous Bake mode. This feature may be used with the additional settings of a Cook Time or a Delayed Start.

⚠ WARNING Food poisoning hazard. Do not let food sit for more than one hour before or after cooking. Doing so can result in food poisoning or sickness.

To set Slow Cook:

1. Press **Upper Oven** or **Lower Oven** key.
2. Press **Slow Cook** once. If **HI** appears in the display and you want to use **LO**, press **Slow Cook** again to change the setting to **LO**.
3. Once desired setting shows in the display, press .

Cooking and Preparation tips for Slow Cook

- Completely thaw all frozen foods before cooking.
- When using a single rack, place in position 2 or 3.
- Position multiple racks to accommodate size of cooking utensils when cooking multiple food items.
- Do not open the oven door often or leave the door open when checking foods. If the oven heat escapes often, the Slow Cook time may need to be extended.
- Cover the foods to keep them moist or use a loose or vented type cover to allow foods to turn crisp or brown.
- Cook times will vary depending on the weight, fat content, bone and the shape of the food.
- Use the recipe's recommended food temperature and a food thermometer to determine when the food is done.
- Preheating the oven will not be necessary.
- Add any cream or cheese sauces during the last hour of cooking.

⚠ CAUTION Always use pot holders or oven mitts when using the oven. When cooking the oven interior and oven racks will become very hot which can cause burns.

Warm & Hold™

Warm & Hold will keep cooked foods warm and ready for serving for up to 3 hours if set to turn on after cooking has finished. After 3 hours, the Warm & Hold will shut-off automatically. Warm & Hold may be set by itself to run for up to 11:59 before shutting off and should only be used with foods that are already at serving temperatures. Warm & Hold will maintain the oven temperature at 170° F (77°C).

To set Warm & Hold:

1. If needed, arrange oven racks and place cooked food in oven.
2. Press **Upper Oven** or **Lower Oven** key.
3. Press **Warm & Hold**. **Hld** will appear in the display. If no other keys are touched within 25 seconds, the request for Warm & Hold will clear.
4. Press . Warm & Hold will start and automatically turn off after 3 hours.

To turn Warm & Hold off at any time, press .

To add Warm & Hold to automatically turn ON after baking 45 minutes with default oven set temperature of 350°F:

1. Press **Upper Oven** or **Lower Oven** key.
2. Press **BAKE**.
3. Press **Cook Time**.
4. Enter **4 5** using number keys.
5. Press **Warm & Hold**. **Hld** will appear in the display.
6. Press  to accept. When the cook time is over, the Warm & Hold will automatically turn on. The Warm & Hold function will automatically turn off after 3 hours.

To add Warm & Hold to automatically turn ON after baking 45 minutes with default oven set temperature of 450 °F:

1. Press **Upper Oven** or **Lower Oven** key.
2. Press **Bake**.
3. Press **4 5 0** using number keys.
4. Press **Cook Time**.
5. Enter **4 5** using number keys.
6. Press **Warm & Hold**. **Hld** will appear in the display.
7. Press  to accept. When the cook time is over, the Warm & Hold will automatically turn on. The Warm & Hold function will automatically turn off after 3 hours.

Oven Controls

Setting the Sabbath Feature (for use on the Jewish Sabbath and Holidays)





For further assistance, guidelines for proper usage, and a complete list of models with the Sabbath feature, please visit the web at: star-k.org

This appliance provides special settings for use when observing the Jewish Sabbath/Holidays. Sabbath mode disables all audible tones or visual display changes on the oven control. Bake heating is the only cooking feature available while in the Sabbath mode.

You must first set the Bake feature and temperature(s) needed for the oven, the Cook Time and Delay Start options (if needed), before setting the Sabbath mode. Any settings made prior to setting the Sabbath mode will be visible in the displays. The Cook Time option, if set prior to the Sabbath mode, will give one audible alert at the end of Cook Time.

The Sabbath mode will override the factory preset 12 hour energy saving mode, and the appliance will stay on until the cooking features are cancelled. If any of the cooking features are cancelled when the appliance is in the Sabbath mode, no audible or visual indicators will be available to verify the cancellation.

If the oven light is needed during the Sabbath, press  to turn the oven light on before activating the Sabbath feature. Once the oven light is turned on and the Sabbath feature is active, the oven light will remain on until the Sabbath feature is turned off. If the oven light needs to be off, be sure to turn the oven light off before activating the Sabbath feature.

It is recommended that any oven temperature change with the Sabbath feature active be followed with two presses of . This will ensure the oven remains on even if the attempt to set the oven temperature was lower or higher than the oven control can accept. If the oven temperature is set incorrectly, the oven temperature will default to 170°F or 550°F. Try to set the desired oven temperature again.



⚠ WARNING Food Poisoning Hazard. Do not let food sit for more than one hour before or after cooking. Doing so can result in food poisoning or sickness. Foods that can easily spoil such as milk, eggs, fish, meat, or poultry should be chilled in the refrigerator first. Even when chilled, they should not stand in the oven for more than 1 hour before cooking begins and should be removed promptly when finished cooking.

To program oven to Bake with default oven temperature of 350°F and activate the Sabbath feature:

1. Be sure the clock is set with the correct time of day. Arrange oven racks, place bakeware in oven, and close oven door.
2. Press **Upper Oven** or **Lower Oven** key.
3. Press **Bake**.
4. If Cook Time or Delay Start are not needed, skip this step and continue to **Step 6**. If a Cook Time or Delay Start are desired, enter the times at this point. Refer to the “[Setting Cook Time](#)” and “[Setting Delay Start](#)” sections on [page 16](#) for detailed instructions.
5. Press .
6. Press and hold both **Cook Time** and **Delay Start** simultaneously for about 3 seconds to set the Sabbath feature. Once the feature is set, **SAb** will appear in the display indicating the oven is properly set for the Sabbath feature.

SAb

Important note:

- It is not advised to attempt to activate any other oven function except Bake while the Sabbath feature is active. Only the following keys will function correctly when the Sabbath feature is active: 0-9 number keys, Bake, , and . All other keys should not be used once the Sabbath feature is active.
- You may change the oven temperature once baking has started. Press the **Bake** key, use the number keys to enter the oven temperature change (170 to 550°F), and press  (for Jewish Holidays only). Remember that the oven control will no longer provide audible tones or display any further changes when the Sabbath feature is active.
- Remember the oven will shut-off automatically after completing a Cook Time, Delay Start, or Warm & Hold. Therefore, it may only be used once during the Sabbath/Jewish holidays.
- If a Delay Start time longer than the default 11 hours and 59 minutes is desired, set the oven control for the 24 hour day display mode setting. For detailed instructions, see “[Setting 12 or 24 Hour Display Mode](#)” on [page 14](#).

To turn the oven off and keep the Sabbath feature active:

Press .

To turn off the Sabbath feature:

Press and hold both **Cook Time** and **Delay Start** keys simultaneously for at least 3 seconds to turn the Sabbath feature off. The control will provide an acceptance tone, and SAb will disappear from the display. The oven is no longer programmed for the Sabbath feature.

What to do during a power failure or power interruption after the Sabbath feature has been activated:

Should you experience a power failure or interruption, the oven will shut-off. When power is restored the oven will not turn back on automatically. The oven will remember that it is set for the Sabbath, and the oven display will show the message **SF** for Sabbath failure.



The food may be safely removed from the oven while still in the Sabbath feature, however the oven cannot be turned back on until after the Sabbath/holidays. After the Sabbath observance turn off the Sabbath feature. Press and hold both **Cook Time** and **Delay Start** keys for at least 3 seconds simultaneously to turn the Sabbath feature off. **SF** will disappear from the display, and the oven may be used with all normal functions.

Adjusting Oven Temperatures

Your appliance has been factory calibrated and tested to ensure accurate baking temperatures. For the first few uses, follow your recipe times and temperature recommendations carefully. If you think the oven is cooking too hot or too cool for your recipe times, you may adjust the control so the oven cooks hotter or cooler than the oven temperature displayed.

The oven temperature may be increased as much as +35°F (+19°C) or decreased -35°F (-19°C) from the factory calibrated settings.

To increase (+) or decrease (-) the oven temperature by 20°F:

1. Press **Upper Oven** or **Lower Oven** key.
2. Press and hold **Bake** until the control produces an audible tone (about 6 seconds). The factory offset temperature of 0 (zero) should appear in the display.
3. Enter **2 0** using number keys.
4. Press **Self Clean** to toggle between plus (+) if increasing temperature or minus (-) if decreasing the temperature.
5. Press  to accept change.

Important note:

- Oven temperature adjustments made will not change the Broil or Self Clean function temperatures.
- If the temperature shows an adjustment of -20°F, and a +20°F adjustment is needed, you can toggle between the minus (-) or plus (+) in the display when pressing **Self Clean** key (See Step 4).
- Do not use oven thermometers such as those found in grocery stores to check the temperature settings inside your oven. These oven thermometers may vary as much as 20°F to 40°F degrees from actual temperatures.
- The oven temperature adjustment may be made if your oven control has been set to display °C temperatures. Minimum and maximum settings for °C range from plus (+) 19°C to minus (-) 19°C.

Restoring Factory Default Settings

When new, your appliance left the factory with predetermined (default) oven control settings. Over time, users may have made changes to these settings. The following options may have been modified since the appliance was new:

- 12 or 24 hour display mode
- Continuous bake or 12 hour energy savings mode
- Silent or audible control
- Oven temperature display (°F or °C)
- Oven temperature adjustments
- Meat probe Cancel or Continue Cooking

To restore oven control to factory default settings:

 **CAUTION** If you choose to restore factory default setting using this method, all of the above user settings will be restored to the factory default settings. This includes the oven temperature offset that will reset to (0) zero.

1. Press and hold **7** until acceptance tone sounds (about 6 seconds).
2. Press . The control has been reset with the default settings.

Oven Controls

Self Clean

A self cleaning oven cleans with very high temperatures well above normal cooking temperatures. The high temperature eliminates soils completely or reduces them to a fine powdered ash you can wipe away afterwards with a damp cloth.

The Self Clean function allows you to set a cleaning time from 2 hours to 4 hours. A 3 hour cleaning time is recommended for normal cleaning, 2 hours for light cleaning, and 4 hours for heavy cleaning.

Read Before Starting Self Clean:

⚠ CAUTION Do not leave small children unattended near the appliance. During the self cleaning cycle, the outside of the oven can become very hot to touch and can cause burns.

⚠ CAUTION Do not line the oven walls, racks, bottom, or any other part of the oven with aluminum foil. Doing so will destroy heat distribution, produce poor baking results, and cause permanent damage to the oven interior. Aluminum foil will melt to the interior of the oven.

⚠ CAUTION The health of some birds is extremely sensitive to the fumes given off during the self cleaning cycle of any oven. Move birds to another well-ventilated room.

⚠ CAUTION Do not force the door open. This can damage the automatic door locking system. Use caution when opening the oven door after self cleaning. The oven may still be very hot and can cause burns. To avoid possible burns, stand to the side of the oven when opening the oven door to allow hot air or steam to escape.

Important note: This model comes with lubricated porcelain oven racks, which can remain in the oven during the self-clean cycle. Do not clean this vegetable oil lubrication off the racks. It is important that the sides of the oven racks always have a light coating of vegetable oil. To maintain optimal rack performance, re-apply a thin layer of vegetable oil to the sides of the rack after every self-clean cycle or when the rack becomes difficult to slide.

- Remove all items from the oven, including bakeware, utensils, and any aluminum foil. Aluminum foil will not withstand high temperatures from a self clean cycle and will melt.
- Do not use oven cleaners or oven protective coatings in or around any part of the oven interior.
- Clean any soil from the oven frame, the door liner outside the oven door gasket, and the small area at the front center of the oven bottom (See Figure 9). These areas heat sufficiently to burn soil on. Clean using soap and water prior to starting Self Clean.
- Remove any excessive build up caused by spills. Any spill on the oven bottom should be wiped-up and removed before starting a self clean cycle. To clean, use hot, soapy water and a cloth. Large spill residue can cause heavy smoke or fire when subjected to high temperatures. Do not allow food spills with a high sugar or acid content (such as milk, tomatoes, sauerkraut, fruit juices, or pie filling) to remain on the surface because they may leave a dull spot even after cleaning.
- Do not clean the oven door gasket (See Figure 9). The woven material of the oven door gasket is essential for a good seal. Care should be taken not to rub, damage, or remove the gasket. Do not use any cleaning materials on the oven door gasket. Doing so could cause damage to the door gasket.

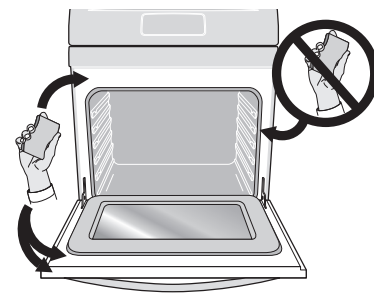

Figure 9: Oven door area to clean and not clean (gasket).

To set Self Clean:

- Be sure the oven is empty and all oven racks are removed. Remove all items from the oven. Be sure oven door is completely closed.
- Press **Upper Oven** or **Lower Oven** key.
- Press **Self Clean**, and the default 3 hour clean time will appear in the display. You may accept the default 3 hour clean time by going to Step 4 or choose a different clean time. Press **Self Clean** and use the number keys to select any time between 2 hours and 4 hours. Once you have the desired clean time selected, proceed to Step 4.
- Press **START** to activate Self Clean. **Remove Racks** reminder will flash on the display. Press **Self Clean** a second time to verify racks have been removed to start cleaning.
- Press **START** again to verify all racks have been removed and Self Clean will start.

As soon as Self Clean becomes active, a motor driven lock mechanism will begin locking the oven door automatically.

DOOR LOCK will appear in the display.

Important: Do not force the oven door open while the door is locking or when **DOOR LOCK** is displayed. This can damage the automatic door-locking system. Allow 15 seconds for the mechanism to lock the oven. Once the oven door has locked, **CLn** will appear in the display, indicating Self Clean has started.

Once the oven door has locked, **CLn** will appear in the display, indicating Self Clean has started.

When Self Clean is Finished

1. The **Cln** message will turn off, and **Hot** will appear in display window.
2. Once the oven has cooled down (about 1 hour) and **Hot** is no longer displayed the oven door may be opened.
3. The oven broil element may appear to have cooled once the oven door is unlocked. The element may still be hot and burns may occur if the element is touched before it has cooled.
4. When the oven interior has completely cooled, wipe away any residue or powdered ash with a damp cloth or paper towel.

Hot

⚠ CAUTION Use caution when opening the oven door after self cleaning. The oven may still be very hot and can cause burns. To avoid possible burns, stand to the side of the oven when opening the oven door to allow hot air or steam to escape.

Important:

The kitchen area should be well ventilated. Use an open window, ventilation fan, or exhaust hood during the first self clean cycle to help eliminate the normal odors associated with the initial self clean cycle.

When the clean time finishes, the oven door will remain locked until the oven has cooled sufficiently. In addition to the clean time that was programmed, allow about 1 additional hour for the oven to cool before opening the oven door. The Self Clean function will not operate when the oven lockout is active.

Setting Delay Start Self Clean

To start a delay Self Clean with default clean time of 3 hours and a start time of 9:00 o'clock:

1. Be sure the clock is set with the correct time of day, the oven is empty, and all of the oven racks are removed. Be sure oven door is completely closed.
2. Press **Upper Oven** or **Lower Oven** key.
3. Press **Self Clean**.
4. Press **Delay Start**.
5. Using number keys, enter **9 0 0** for time to start.

6. Press  .

If it becomes necessary to stop Self Clean when active:

1. Press  .
2. If Self Clean has heated the oven to a high temperature, allow enough time for the oven to cool and the **HOT** message to disappear. When this message turns off, the oven may be opened.

Important:

- When Self Clean is active, you may check the amount of clean time remaining by pressing the **Self Clean** key once.
- If your clock is set with the (default) 12 hr display mode, the Delay Start for a Self Clean can only be programmed to start up to 11 hours and 59 minutes after the time showing in the display (be sure to set the clock to current time before programming a delay start). To set a Delay Start Self Clean to begin 12 or more hours (maximum is 23 hours and 59 minutes) after the time of setting, be sure to first set the control in the 24 Hr display mode.
- If Self Clean was active and then interrupted by a power failure or cancelled before the oven was thoroughly cleaned, it may be necessary to run another Self Clean cycle.
- If the oven temperature was high enough when Self Clean was interrupted, the oven control may not allow another Self Clean cycle to be set for up to 4 hours.

Care and Cleaning

Remove spills and any heavy soiling as soon as possible. Regular cleaning will reduce the difficulty of major cleaning later.

CAUTION

- Before cleaning any part of the appliance, be sure all controls are turned off and the appliance is cool.
- If ammonia or appliance cleaners are used, they must be removed and the appliance must be thoroughly rinsed before operating. Follow manufacturer's instructions and provide adequate ventilation.

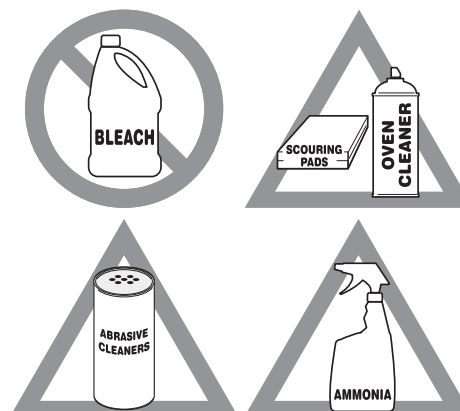

Figure 10: Use cleaners with caution

Surface or Area	Cleaning Recommendation
Aluminum and vinyl	Using a soft cloth, clean with mild dish detergent and water. Rinse with clean water, dry and polish with a soft, clean cloth.
Painted and plastic control knobs Painted body parts Painted decorative trims	Using a soft cloth, clean with mild dish detergent and water or a 50/50 solution of vinegar and water. Rinse with clean water, dry and polish with a soft, clean cloth. Glass cleaners may be used, but do not apply directly to surface; spray onto cloth and wipe.
Control panel	Using a soft cloth, clean with mild dish detergent and water or a 50/50 solution of vinegar and water. Do not spray liquids directly on the oven control and display area. Do not use large amounts of water on the control panel - excess water on the control area may cause damage to the appliance. Do not use other liquid cleaners, abrasive cleaners, scouring pads, or paper towels - they will damage the finish.
Control knobs	Using a soft cloth, clean with mild dish detergent and water or a 50/50 solution of vinegar and water. To remove control knobs: turn to the OFF position, grasp firmly, and pull off the shaft. To replace knobs after cleaning, line up the OFF markings and push the knobs into place.
Stainless Steel	Using a soft cloth, clean with mild dish detergent and water or a 50/50 solution of vinegar and water. Rinse with clean water, dry with a soft clean cloth. Do not use cleaners containing abrasives, chlorides, chlorine, or ammonia.
Easy Clean Stainless Steel Black Stainless Steel	Using a soft cloth, clean with mild dish detergent and water or a 50/50 solution of vinegar and water. Rinse with clean water, dry with a soft clean cloth. Do not use appliance cleaner, stainless steel cleaner, or cleaner containing abrasives, chlorides, chlorine, or ammonia. These cleaners may damage the finish.
Porcelain-enameled broiler pan and insert Porcelain door liner Porcelain body parts	Rinse with clean water and a damp cloth. Scrub gently with a soapy, non-abrasive scouring pad to remove most spots. Rinse with a 50/50 solution of clean water and ammonia. If necessary, cover difficult spots with an ammonia-soaked paper towel for 30 to 40 minutes. Rinse and wipe dry with a clean cloth. Remove all cleaners or future heating could damage the porcelain. Do not allow food spills with a high sugar or acid content (milk, tomatoes, sauerkraut, fruit juices or pie filling) to remain on porcelain surfaces. These spills may cause a dull spot even after cleaning.
Porcelain oven racks	To maintain optimal rack performance, re-apply a thin layer of vegetable oil to the sides of the rack after every self-clean cycle or when the rack becomes difficult to slide.

Surface or Area	Cleaning Recommendation
Self-cleaning oven interior	Before setting a self-clean cycle, clean soils from the oven frame, areas outside the oven door gasket, and the small area at the front center of the oven bottom. See “Self Clean” on page 28.
Oven door	<p>Use mild dish detergent and water or a 50/50 solution of vinegar and water to clean the top, sides, and front of the oven door. Rinse well. Glass cleaner may be used on the outside glass of the door. Ceramic smoothtop cleaner or polish may be used on the interior door glass. Do not immerse the door in water. Do not spray or allow water or cleaners to enter the door vents. Do not use oven cleaners, cleaning powders, or any harsh abrasive cleaning materials on the outside of the oven door.</p> <p>Do not clean the oven door gasket. The oven door gasket is made of a woven material which is essential for a good seal. Do not rub, damage, or remove this gasket.</p>

Aluminum Foil and Utensils

⚠ WARNING Never cover any slots, holes, or passages in the oven bottom or cover an entire oven rack with materials such as aluminum foil. Aluminum foil linings may trap heat, causing a fire hazard.

⚠ WARNING Protective Liners — Do not use aluminum foil to line the oven bottom. Improper installation of these liners may result in risk of electric shock or fire.

Important notes:

- Aluminum foil - Use of aluminum foil on a hot cooktop can damage the cooktop. Do not use thin aluminum cooking utensils or allow aluminum foil to touch the surface elements under any circumstances.
- Aluminum utensils - The melting point of aluminum is much lower than that of other metals. Care must be taken when aluminum pots or pans are used on the cooktop. If aluminum pans are allowed to boil dry when using the cooktop, not only will the utensil be damaged or destroyed, but it may fuse to, break, or mark the ceramic glass surface, permanently damaging the cooktop surface.

Replacing the oven light

⚠ CAUTION Be sure the oven is unplugged and all parts are cool before replacing oven light.

The interior oven lights are located at the rear of the oven cavity and are covered with a glass shield. The glass shield must be in place whenever the oven is in use (See Figure 11).

To replace the oven interior light bulb:

Important note:

Do not allow your fingers to touch the new bulb when replacing. This will shorten the life of the bulb. Use a paper towel or cotton glove while handling the new bulb when installing.

- Turn electrical power off at the main source or unplug the appliance.
- Remove interior oven light shield by turning a quarter turn counter-clockwise.
- Replace bulb with a new T-4 type Halogen 25 watt appliance bulb.
- Replace glass oven light shield by rotating clockwise.
- Turn power back on again at the main source (or plug the appliance back in).
- Be sure to reset the time of day on the clock.

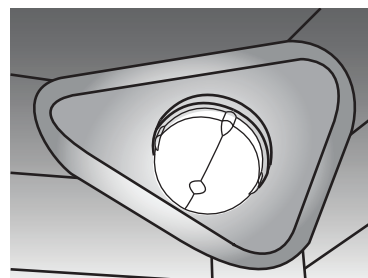

Figure 11: Wall oven Halogen light

Care and Cleaning

Removing and Replacing the Oven Door

To remove oven door:

⚠ CAUTION The door is heavy. For safe, temporary storage, lay the door flat with the inside of the door facing down.

1. Open oven door completely, horizontal with floor (See [Figure 12](#)).
2. Pull the door hinge locks on both left and right door hinges down from the oven frame completely towards the oven door (See [Figure 13](#)). A tool such as a small flat-blade screwdriver may be required.
3. Firmly grasp both sides of oven door along the door sides. Do not use the oven door handle (See [Figure 14](#)).
4. Close the door to approximately 10 degrees from the door frame (See [Figure 14](#)).
5. Lift the oven door hinge arms over the roller pins located on each side of the oven frame (See [Figure 15](#)).

To replace oven door:

1. Firmly grasp both sides of oven door along the door sides. Do not use the oven door handle (See [Figure 14](#)).
2. Holding the oven door at the same angle as the removal position, seat the hook of the hinge arm over the roller pins located on each side of the oven door frame (See [Figure 14](#) and [Figure 15](#)). The hook of the hinge arms must be fully seated onto the roller pins.
3. Fully open the oven door, horizontal with floor (See [Figure 12](#)).
4. Push the door hinge locks up towards and into the oven frame on both left and right oven door hinges to the locked position (See [Figure 13](#)).
5. Close the oven door.

Important note:

Special door care instructions - Most oven doors contain glass that can break. Do not hit the glass with pots, pans, or any other object. Scratching, hitting, jarring, or stressing the glass may weaken its structure, causing an increased risk of breakage at a later time. Do not close the oven door until all of the oven racks are fully in place.

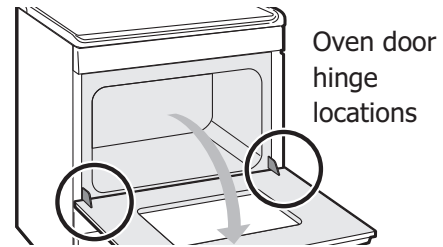

Figure 12: Door hinge location

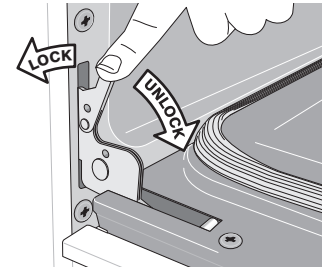

Figure 13: Door hinge locks

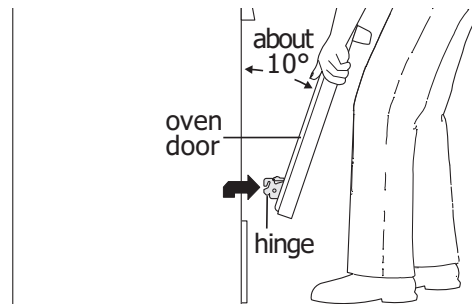

Figure 14: Holding door for removal

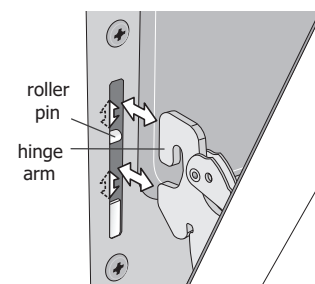

Figure 15: Replacement and location of hinge arm and roller pin





Before You Call

Oven Baking

For best cooking results, heat the oven before baking cookies, breads, cakes, pies, pastries, et cetera. There is no need to preheat the oven for roasting meat or baking casseroles.

The cooking times and temperatures needed to bake a product may vary slightly from your previously owned appliance.

Baking Problems and Solutions

Baking Problems	Causes	Corrections
Cookies and biscuits burn on the bottom. 	<ul style="list-style-type: none"> • Cookies and biscuits put into oven before the preheating time is completed. • Oven rack is overcrowded. • Dark pans absorb heat too fast. 	<ul style="list-style-type: none"> • Allow oven to preheat to desired temperature before placing food in oven. • Choose pan sizes that will permit 2" to 4" of air space (5.1 cm or 10.2 cm) on all sides when placed in the oven. • Use a medium weight baking sheet.
Cakes too dark on top or bottom 	<ul style="list-style-type: none"> • Cakes put in oven before preheating time is completed. • Rack position too high or too low. • Oven too hot. 	<ul style="list-style-type: none"> • Allow oven to preheat to the selected temperature before placing food in the oven. • Use proper rack position for baking needs. • Set oven temperature 25°F (12°C) lower than recommended.
Cakes not done in center 	<ul style="list-style-type: none"> • Oven too hot. • Incorrect pan size. • Pan not centered in oven. • Glass cookware slow heat conductor. 	<ul style="list-style-type: none"> • Set oven temperature 25°F (12°C) lower than recommended. • Use pan size suggested in recipe. • Use proper rack position and place pan so there is 5.1 cm to 10.2 cm (2" to 4") of space on all sides of pan. • Reduce temperature and increase cook time or use shiny bakeware.
Cakes not level. 	<ul style="list-style-type: none"> • Oven not level. • Pan too close to oven wall or rack overcrowded. • Pan warped. 	<ul style="list-style-type: none"> • Place a marked glass measuring cup filled with water on the center of the oven rack. If the water level is uneven, refer to the installation instructions for leveling the oven. • Be sure to allow 5.1 cm to 10.2 cm (2" to 4") of clearance on all sides of each pan in the oven. • Do not use pans that are dented or warped.
Foods not done when cooking time is over. 	<ul style="list-style-type: none"> • Oven too cool. • Oven overcrowded. • Oven door opened too frequently. 	<ul style="list-style-type: none"> • Set oven temperature 25°F (12°C) higher than suggested and bake for the recommended time. • Be sure to remove all pans from the oven except the ones to be used for baking. • Open oven door only after shortest recommended baking time. • Make sure to allow 2" to 4" of clearance between all pans and racks, allowing for even air flow.

Before You Call

Solutions to Common Problems:

Before you call for service, review the following list. It may save you time and expense. Possible solutions are provided with the problem listed.

Problem	Cause / Solution
Entire appliance does not operate.	Appliance not connected. Make sure power cord is plugged properly into outlet. Check your fuse box or breaker box to make sure the circuit is active. Electrical power outage. Check house lights to be sure. Call your local electric company for service outage information.
Oven Problems	
Poor baking results.	Many factors affect baking results. Use proper oven rack position. Center food in the oven and space pans to allow air to circulate. Preheat the oven to the set temperature before placing food in the oven. Try adjusting the recipe's recommended temperature or baking time. See "Adjusting Oven Temperatures" on page 27 if you feel the oven is too hot or too cool.
Flames inside oven or smoking from oven vent.	Excessive spills in oven. Grease or food spilled onto the oven bottom or oven cavity. Wipe up excessive spills before starting the oven. If flames or excessive smoke are present when using broil, see "Setting Broil" on page 20 .
Oven smokes excessively when broiling.	Incorrect setting. Follow the "Setting Broil" instructions on page 20 . Meat too close to the broil element or burner. Reposition the broil pan to provide proper clearance between the meat and broil element or burner. Remove excess fat from meat. Cut remaining fatty edges to prevent curling, but do not cut into lean. Grease build up on oven surfaces. Regular cleaning is necessary when broiling frequently. Grease or food splatters will cause excessive smoking.
Oven control panel beeps and displays any F or E code error.	Oven control has detected a fault or error condition. To clear the error, press the OFF key on the control panel. Once the error code is cleared, try the bake or broil function. If the F or E code error repeats, turn off the power to appliance, wait 5 minutes, and then repower the appliance. Set the clock with correct time of day. Try the bake or broil function again. If the fault recurs, press the OFF key to clear.
Oven portion of appliance does not operate.	Be sure the regulator gas valve is turned to ON. See installation instructions. The time of day is not set. The clock must be set in order to operate the oven. See "Setting the Clock" on page 14 . Be sure the oven controls are set properly for the desired function. See "Oven Control Features" starting on page 13 and review instructions for the desired cooking function in this manual or see "Entire appliance does not operate." in this checklist.
Convection fan does not rotate.	Oven door is open. The convection fan will turn off if the oven door is opened when convection is active. Close the oven door. On gas models, the convection fan will begin to rotate about 6 minutes into the preheating process.
Self Clean Problems	
Self clean does not work.	Oven control not set properly. See "Self Clean" on page 28 .

Problem	Cause / Solution
Porcelain coated oven racks	<p>This model comes with lubricated porcelain oven racks, which can remain in the oven during the self-clean cycle. Do not clean this vegetable oil lubrication off the racks. It is important that the sides of the oven racks always have a light coating of vegetable oil.</p> <p>To maintain optimal rack performance, re-apply a thin layer of vegetable oil to the sides of the rack after every self-clean cycle or when the rack becomes difficult to slide.</p>
Oven racks discolored or do not slide easily.	<p>Oven racks left in oven cavity during self clean. Remove oven racks from oven cavity before starting a self-clean cycle. Clean by using a mild abrasive cleaner following manufacturer's instructions. Rinse with clean water, dry, and replace in oven.</p>
Soil not completely removed after self clean.	<p>Self clean was interrupted. Review instructions on "Self Clean" on page 28.</p> <p>Excessive spills on oven bottom. Remove excessive spills before starting self clean.</p> <p>Failure to clean soil from the oven frame, the door liner outside the oven door gasket, and the small area at the front center of the oven bottom. These areas are not in the self-cleaning area, but get hot enough to burn on residue. Clean these areas before starting the self-cleaning cycle. Burned-on residue can be cleaned with a stiff nylon brush and water or a nylon scrubber. Be careful not to damage the oven gasket.</p>
Other Problems	
Appliance is not level.	<p>Kitchen cabinet alignment may make range appear not level. Be sure cabinets are square and have sufficient room for appliance clearance.</p>
Cannot move appliance easily. Appliance must be accessible for service.	<p>Cabinets not square or are built in too tightly. Contact the builder or installer to make the appliance accessible.</p>
Oven light does not work.	<p>Be sure the oven light is secure in the socket. See "Replacing the oven light" on page 31.</p>

Kenmore®

Customer Care Hotline

To schedule in-home repair service
or order replacement parts

Para pedir servicio de reparación
a domicilio, y ordenar piezas

1-844-553-6667

www.kenmore.com

