

Use & Care Guide
Manual de Uso y Cuidado
English / Español

Model/Modelo: 790.9272*

Kenmore®

Electric Range

Estufa eléctrica

* = color number, número de color

P/N 808529906 Rev. A

Transform SR Brands Management LLC,
Hoffman Estates, IL 60179 U.S.A.
www.kenmore.com
www.sears.com



Table of Contents

Cooking Recommendations.....	8	Before Setting Oven.....	16
Before Setting Surface Controls.....	10	Oven Controls	17
Using Proper Cookware	10	Care and Cleaning	22
Setting Surface Controls.....	12	Before You Call.....	26

KENMORE LIMITED WARRANTY

WITH PROOF OF SALE the following warranty coverage applies when this appliance is correctly installed, operated and maintained according to all supplied instructions.

One Year on Appliance

FOR ONE YEAR from the date of sale this appliance is warranted against defects in material or workmanship. A defective appliance will receive free repair or replacement at option of seller.

Lifetime on Oven Door Glass

FOR AS LONG AS IT IS USED from the date of sale, free replacement glass will be supplied for defective oven door glass*. If the defect appears within the first year, new door glass will be installed at no charge. If the defect appears after the first year, new door glass will be supplied but not installed at no charge. This Lifetime warranty covers only the door glass, and does not apply to any other related component or mechanism. You are responsible for the labor cost of door glass installation after the first year from the date of sale. *Defects must be verified by a Sears authorized service representative.

For warranty coverage details to obtain free repair or replacement, visit the web page: www.kenmore.com/warranty

All warranty coverage applies for only 90 DAYS from the sale date if this appliance is ever used for other than private household purposes.

This warranty covers ONLY defects in material and workmanship, and will NOT pay for:

1. Expendable items that can wear out from normal use, including but not limited to filters, belts, bags or screw-in base light bulbs.
2. A service technician to clean or maintain this appliance, or to instruct the user in correct appliance installation, operation and maintenance.
3. Service calls to correct appliance installation not performed by Sears authorized service agents, or to repair problems with house fuses, circuit breakers, house wiring, and plumbing or gas supply systems resulting from such installation.
4. Damage to or failure of this appliance resulting from installation not performed by Sears authorized service agents, including installation that was not in accord with electrical, gas or plumbing codes.
5. Damage to or failure of this appliance, including discoloration or surface rust, if it is not correctly operated and maintained according to all supplied instructions.
6. Damage to or failure of this appliance, including discoloration or surface rust, resulting from accident, alteration, abuse, misuse or use for other than its intended purpose.
7. Damage to or failure of this appliance, including discoloration or surface rust, caused by the use of detergents, cleaners, chemicals or utensils other than those recommended in all instructions supplied with the product.
8. Damage to or failure of parts or systems resulting from unauthorized modifications made to this appliance.
9. Service to an appliance if the model and serial plate is missing, altered, or cannot easily be determined to have the appropriate certification logo.

Disclaimer of implied warranties; limitation of remedies

Customer's sole and exclusive remedy under this limited warranty shall be product repair or replacement as provided herein. Implied warranties, including warranties of merchantability or fitness for a particular purpose, are limited to one year on the appliance and for as long used on the oven door glass, or the shortest period allowed by law. Seller shall not be liable for incidental or consequential damages. Some states and provinces do not allow the exclusion or limitation of incidental or consequential damages, or limitation on the duration of implied warranties of merchantability or fitness, so these exclusions or limitations may not apply to you.

This warranty applies only while this appliance is used in the United States.

This warranty gives you specific legal rights, and you may also have other rights which vary from state to state.

Transform SR Brands Management LLC, Hoffman Estates, IL 60179

IMPORTANT SAFETY INSTRUCTIONS

Read all instructions before using this appliance.

This manual contains important safety symbols and instructions. Please pay attention to these symbols and follow all instructions given.

Do not attempt to install or operate your appliance until you have read the safety precautions in this manual. Safety items throughout this manual are labeled with a WARNING or CAUTION statement based on the risk type.

Warnings and important instructions appearing in this guide are not meant to cover all possible conditions and situations that may occur. Common sense, caution, and care must be exercised with installing, maintaining, or operating your appliance.

DEFINITIONS

⚠ This is the safety alert symbol. It is used to alert you to potential personal injury hazards. Obey all safety messages that follow this symbol to avoid possible injury or death.

⚠ WARNING - Indicates a potentially hazardous situation which, if not avoided, may result in death or serious injury.

⚠ CAUTION - Indicates a potentially hazardous situation which, if not avoided, may result in minor or moderate injury.

IMPORTANT - Indicates installation, operation, maintenance, or valuable information that is not hazard related.

NOTE - Indicates a short, informal reference – something written down to assist the memory or for future reference.

⚠ WARNING

Tip Over Hazard

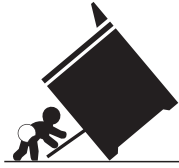

- A child or adult can tip the range and be killed.
- Verify the anti-tip device has been installed to floor or wall.

- Ensure the anti-tip device is re-engaged to floor or wall when the range is moved.
- Do not operate the range without the anti-tip device in place and engaged.
- Failure to follow these instructions can result in death or serious burns to children and adults.



Range

leveling leg

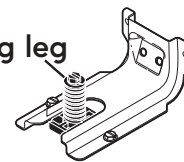

Anti-tip
bracket

To check if the anti-tip bracket is installed properly, use both arms and grasp the rear edge of the range back. Carefully attempt to tilt range forward. When properly installed, the range should not tilt forward.

Refer to the anti-tip bracket installation instructions supplied with your range for proper installation.

IMPORTANT SAFETY INSTRUCTIONS

Read all instructions before using this appliance.

IMPORTANT INSTRUCTIONS FOR UNPACKING AND INSTALLATION

IMPORTANT - Read and follow the below instructions and precautions for unpacking, installing, and servicing your appliance:

Remove all tape and packaging before using the appliance. Destroy the carton and plastic bags after unpacking the appliance. Never allow children to play with packaging material. Do not remove the wiring label and other literature attached to the appliance. Do not remove model/serial number plate.

Cold temperatures can damage the electronic control. When using this appliance for the first time, or when the appliance has not been used for an extended period of time, be sure the appliance has been in temperatures above 32°F (0°C) for at least 3 hours before turning on the power to the appliance.

Never modify or alter the construction of the appliance by removing the leveling legs, panels, wire covers, anti-tip brackets/screws, or any other part of the appliance.

Be sure to have an appropriate foam-type fire extinguisher available, visible, and easily accessible located near the appliance.

GROUNDING INSTRUCTIONS

⚠ WARNING - Avoid fire hazard or electrical shock. Failure to follow this warning may cause serious injury, fire, or death.

⚠ WARNING - Avoid fire hazard or electrical shock. Do not use an adapter plug, use an extension cord, or remove grounding prong from the power cord. Failure to follow this warning may cause serious injury, fire, or death.

Proper Installation—Be sure your appliance is properly installed and grounded by a qualified technician. In the United States, install in accordance with the National Fuel Gas Code ANSI Z223.1/NPFA No. 54, latest edition and National Electrical Code NFPA No. 70 latest edition, and local electrical code requirements. In Canada, install in accordance with CAN/CGA B149.1 and CAN/CGA B149.2 and CSA Standard C22.1, Canadian Electrical code, Part 1-latest editions and local electrical code requirements. Install only per installation instructions provided in the literature package for this appliance.

For personal safety, this appliance must be properly grounded. For maximum safety, the power cord must be securely connected to an electrical outlet or junction box that is the correct voltage, is correctly polarized and properly grounded, and protected by a circuit breaker in accordance with local codes.

It is the personal responsibility of the consumer to have the appropriate outlet or junction box with the correct, properly grounded wall receptacle installed by a qualified electrician. It is the responsibility and obligation of the consumer to contact a qualified installer to assure that the electrical installation is adequate and is in conformance with all local codes and ordinances.

See the installation instructions packaged with this appliance for complete installation and grounding instructions.

IMPORTANT SAFETY INSTRUCTIONS

Read all instructions before using this appliance.

IMPORTANT INSTRUCTIONS FOR USING THE APPLIANCE

⚠ WARNING - Storage In or On Appliance—Flammable materials should not be stored in an oven or microwave, near surface burners or elements, or in the storage or warmer drawer (if equipped). This includes paper, plastic, and cloth items, such as cookbooks, plastic ware, and towels, as well as flammable liquids. Do not store explosives, such as aerosol cans, on or near the appliance.

⚠ WARNING - Do not leave children alone - Children should not be left alone or unattended in the area where appliance is in use. They should never be allowed to sit or stand on any part of the appliance, including the storage drawer, lower broiler drawer, warmer drawer, or lower double oven.

⚠ WARNING - Do not store items of interest to children in the cabinets above the appliance or on the backguards of ranges. Children climbing on or near the appliance to reach items could be seriously injured.

⚠ WARNING - Do not allow children to climb or play around the appliance. The weight of a child on an open oven door may cause the appliance to tip, resulting in serious burns or other injury. An open drawer when hot may cause burns.

⚠ WARNING - Stepping, leaning, or sitting on the door or drawers of this appliance can result in serious injuries and also cause damage to the appliance.

⚠ WARNING Never cover any slots, holes or passages in the oven bottom or cover and entire rack with materials such as aluminum foil. Doing so blocks air flow through the oven and may cause carbon monoxide poisoning. Aluminum foil linings may also trap heat, causing a fire hazard

⚠ WARNING - Do not use oven or warmer drawer (if equipped) for storage.

⚠ WARNING - Never use your appliance as a space heater to heat or warm the room. Doing so may result in carbon monoxide poisoning and overheating of the appliance.

⚠ CAUTION - When heating fat or grease, watch it closely. Grease may catch fire if it becomes too hot.

⚠ CAUTION - Do not use water or flour on grease fires. Smother fire or flame or use dry chemical or foam-type extinguisher. Cover the fire with a pan lid or use baking soda.

⚠ CAUTION - Use dry potholders. Moist or damp potholders on hot surfaces may result in burns from steam. Do not let potholders touch hot cooking areas. Do not use towels or other bulky cloths.

⚠ CAUTION - Do not heat unopened food containers - Build-up of pressure may cause container to burst and result in injury.

⚠ CAUTION - Wear proper apparel - Loose-fitting or hanging garments should never be worn while using the appliance. Do not let clothing or other flammable materials contact hot surfaces.

⚠ CAUTION - Do not touch surface burners or elements, areas near these burners or elements, interior surfaces of the oven, or the warmer drawer (if equipped). Surface burners and elements may be hot even though they appear cool. Areas near surface burners and elements may become hot enough to cause burns. During and after use, do not touch, or let clothing or other flammable materials touch these areas until they are cool. These areas may include the cooktop, surfaces facing the cooktop, oven vent areas, oven door, and oven window.

⚠ CAUTION - Do not attempt to operate the appliance during a power failure. If the power fails, always turn off the appliance. If the appliance is not turned off and the power resumes, electric surface elements may resume operation when power is restored. Once the power resumes, reset the clock and the oven function.

Save these instructions for future reference.

IMPORTANT SAFETY INSTRUCTIONS

Read all instructions before using this appliance.

IMPORTANT INSTRUCTIONS FOR USING YOUR RADIANT COOKTOP

Know which knob or key controls each surface heating area. Place cookware with food on the cooking area before turning it on. Turn the cooking area off before removing the cookware.

Cookware handles should be turned inward and not extend over adjacent surface elements — To reduce the risk of burns, ignition of flammable materials, and spillage due to unintentional contact with the utensil, the handle of the cookware should be positioned so that it is turned inward, and does not extend over other cooking areas.

Use proper pan size - This appliance is equipped with one or more surface units of different sizes. Select cookware with flat bottoms that match the surface unit size. Using the proper cookware on the cooking area will improve efficiency.

Glazed cooking utensils— Only certain types of glass, glass/ceramic, ceramic, earthenware, or other glazed utensils are suitable for cooktop service without breaking due to the sudden change in temperature. Check the manufacturer's recommendations for cooktop use.

Improper cookware may break due to sudden changes in temperature. Check the cookware manufacturer's recommendations for cooktop use.

Never leave surface elements unattended. Boil-overs may cause smoking and greasy spills that may ignite. A pan that has boiled dry could be damaged and may damage the cooktop.

Do not use a searing grill meant for use with a broiler pan on the cooktop. The searing grill is not designed for use on the cooktop. Doing so may result in a fire.

When you are flaming foods under a ventilating hood, turn on the fan.

IMPORTANT INSTRUCTIONS FOR GLASS AND CERAMIC COOKTOPS

Do Not Clean or Operate a Broken Cooktop. If cooktop should break, cleaning solutions and spillovers may penetrate the broken cooktop and create a risk of electric shock. Contact a qualified technician immediately.

Clean cooktop glass with caution. If a wet sponge or cloth is used to wipe spills on a hot cooking area, be careful to avoid a steam burn. Some cleaners can produce harmful fumes if applied to a hot surface.

Avoid scratching the cooktop glass with sharp objects.

IMPORTANT INSTRUCTIONS FOR USING YOUR OVEN

Protective liners—Do not use aluminum foil, aftermarket oven liners, or any other materials or devices to line oven bottom, oven racks, or any other part of the appliance. Only use aluminum as recommended for baking, such as lining cookware or as a cover placed on food. Any other use of protective liners or aluminum foil may result in a risk of electric shock or fire or a short circuit.

Use care when opening oven door, lower oven door, or warmer drawer (some models). Stand to the side of the appliance when opening the door of a hot oven. Let hot air or steam escape before you remove or replace food in the oven.

Keep oven vent ducts unobstructed. Touching surfaces in this area when the oven is on may cause severe burns. Do not place plastic or heat-sensitive items on or near the oven vent. These items can melt or ignite.

Placement of oven racks - Always place oven racks in desired location while oven is cool. If rack must be moved while oven is hot, do not let potholder contact hot burner or element in oven. Use potholders and grasp the rack with both hands to reposition. Remove all cookware and utensils before moving the rack.

Do not use a broiler pan without its insert. Broiler pans and inserts allow dripping fat to drain away from the high heat of the broiler. Do not cover the broiler insert with aluminum foil; exposed fat and grease could ignite.

Save these instructions for future reference.

IMPORTANT SAFETY INSTRUCTIONS

Read all instructions before using this appliance.

Do not cook food on the oven bottom. Always cook in proper cookware and always use the oven racks.

IMPORTANT INSTRUCTIONS FOR CLEANING YOUR APPLIANCE

⚠ CAUTION - Before manually cleaning any part of the appliance, be sure all controls are turned off and the appliance is cool. Cleaning a hot appliance can cause burns.

Clean the appliance regularly to keep all parts free of grease that could catch fire. Do not allow grease to accumulate. Greasy deposits in the fan could catch fire.

Always follow the manufacturer's recommended directions for use of kitchen cleaners and aerosols. Be aware that excess residue from cleaners and aerosols may ignite causing damage and injury.

Clean ventilating hoods frequently - Grease should not be allowed to accumulate on hood or filter. Follow the manufacturer's instructions for cleaning vent hoods.

IMPORTANT INSTRUCTIONS FOR SERVICE AND MAINTENANCE

Do not repair or replace any part of the appliance unless specifically recommended in the manuals. All other servicing should be done only by a qualified technician. This reduces the risk of personal injury and damage to the appliance.

Always contact your dealer, distributor, service agent, or manufacturer about problems or conditions you do not understand.

Ask your dealer to recommend a qualified technician and an authorized repair service. Know how to disconnect the power to the appliance at the circuit breaker or fuse box in case of an emergency.

Remove the oven door from any unused oven if it is to be stored or discarded.

Do not touch a hot oven light bulb with a damp cloth. Doing so could cause the bulb to break. Handle halogen lights (if equipped) with paper towels or soft gloves. Disconnect the appliance or shut off the power to the appliance before removing and replacing the bulb.

⚠ WARNING California Residents: for cancer and reproductive harm information, visit www.P65Warnings.ca.gov

PRODUCT RECORD

In this space below, record the date of purchase, model and serial number of your product. You will find the model and serial number printed on an identification plate. See [Figure 1](#) for serial plate location.

Model No. _____

Serial No. _____

Date of Purchase _____

Save sales receipt for future reference.

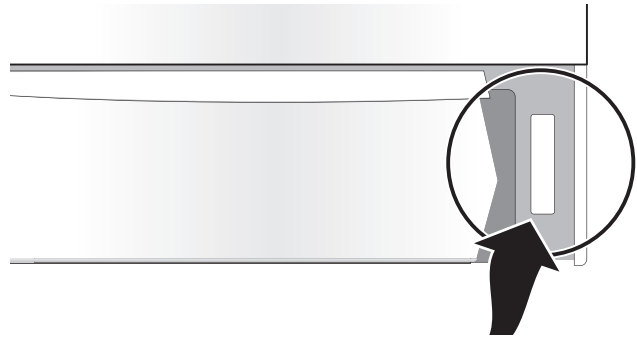



Figure 1: Serial plate location

To locate the serial plate, open storage drawer (some models) or warmer drawer (some models). The serial plate is attached to the lower right oven frame.

Cooking Recommendations

Bakeware

The material of bakeware affects how evenly and quickly it transfers heat from the pan to the food.

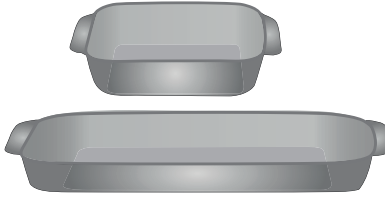
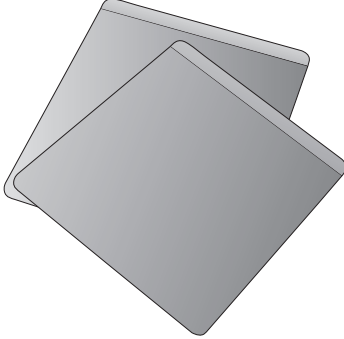
Material	Attributes	Recommendation
<p>Shiny metal bakeware</p> 	<p>Shiny, aluminum, and non-coated bakeware is the best for even heating. It is suitable for all baked goods.</p>	<p>Recommended cooking temperatures and times are based on shiny metal bakeware.</p>
<p>Dark metal bakeware</p> 	<p>Dark bakeware cooks hotter than shiny bakeware.</p>	<p>Reduce the cooking temperature by 25° F (13-14° C) when using dark bakeware.</p>
<p>Glass bakeware</p> 	<p>Glass bakeware cooks hotter than shiny bakeware.</p> <p>Glass is convenient, as the same piece of bakeware can be used for cooking, serving, and storing food.</p>	<p>Reduce the cooking temperature by 25° F (13-14° C) when using glass bakeware.</p>
<p>Insulated bakeware</p> 	<p>Insulated bakeware cooks cooler than shiny bakeware.</p> <p>Insulated bakeware is designed for baking in gas ovens.</p>	<p>Increase the cooking temperature by 25° F (13-14° C) when using insulated bakeware.</p>

Cooking Conditions

Conditions in your kitchen can affect the performance of your appliance when cooking food.

Condition	Attributes	Recommendation
Aging cookware	As pans age and become discolored, cooking times may need to be reduced slightly.	If food is too dark or overcooked, use the minimum cook time in the recipe or packaging. If food is too light or undercooked, use the middle to maximum cook time in the recipe or packaging.
High altitude	Air is drier and air pressure is lower. Water boils at a lower temperature, and liquids evaporate faster. Foods may take longer to bake. Doughs may rise faster.	Adjust cooking temperature, cooking time, or recipes as needed. Increase amount of liquid in baking recipes. Increase cook time on cooktop. Cover dishes to reduce evaporation. Increase bake time or oven temperature. Reduce amount of baking soda or baking powder in recipe. Reduce rising time or punch down dough and allow it to rise twice.

Cooking Results: Small adjustments may fix a problem with food not being as done as you like.

Result	Recommendation
Food too light	Use the middle to maximum cook time recommended on packaging or recipe.
Food too dark	Use the minimum cook time recommended on packaging or recipe.

Cooking Tips: Use these additional tips to get the best results from your appliance.

Cooking	Tips
Baking	
Rack placement	Follow the instructions in "Oven Controls" on starting on page 16 . When using only one rack, place the rack so the food is in the center of the oven.
Preheat	Fully preheat the oven before baking items like cookies, cakes, biscuits and breads. Insert food immediately after the beep.
Checking food	Use the window and oven light when checking food. Opening the door may reduce baking performance.
Food placement	Allow at least 2 inches (5 cm) of space between bakeware for proper air circulation.
Broiling/Roasting	
Broiling pan	For best results when broiling, use a broil pan with a broil pan insert designed to drain the fat from the food, help avoid spatter, and reduce smoking. The broiler pan will catch grease spills, and the insert helps prevent grease splatters. Note: If a broiler pan and insert are not supplied with this appliance, they may be purchased from Sears. Call 1-844-553-6667 and order broiler pan kit 5304442087.

Before Setting Surface Controls

Using Proper Cookware

The size and type of cookware used will influence the heat setting needed for best cooking results. Be sure to follow the recommendations for using proper cookware as illustrated in Figure 2 and Figure 3.

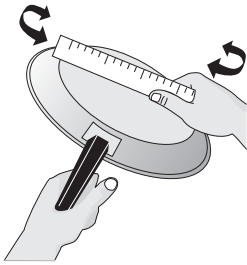

Check for flatness by rotating a ruler across the bottom of the cookware (see Figure 2). Cookware should have flat bottoms that make good contact with the entire surface of the heating element (see Figure 3).

Figure 2: Testing cookware

Cookware Material Types

The cookware material determines how evenly and quickly heat is transferred from the surface element to the pan bottom. The most popular materials available are:

- **Aluminum** - Excellent heat conductor. Some types of food will cause it to darken (Anodized aluminum cookware resists staining and pitting).
- **Copper** - Excellent heat conductor but discolors easily (see Aluminum).
- **Stainless** - Slow heat conductor with uneven cooking results. Durable, easy to clean, and resists staining.
- **Cast Iron** - A slow heat conductor, but will retain heat very well. Cooks evenly once cooking temperature is reached.
- **Porcelain-enamel on metal** - Heating characteristics will vary depending on base material.
- **Glass** - Slow heat conductor.

IMPORTANT: Do not place empty aluminum, glass, or porcelain-enamel coated cookware on the element. The melting point of cookware made with these materials may be reached quickly, especially if left empty. If the cookware melts it will damage the cooktop. Follow all the cookware manufacturer's recommendations for use and care of cookware.

IMPORTANT: NEVER place or straddle a cooking utensil over two different surface cooking areas at the same time. Incorrect use may damage the cooktop.

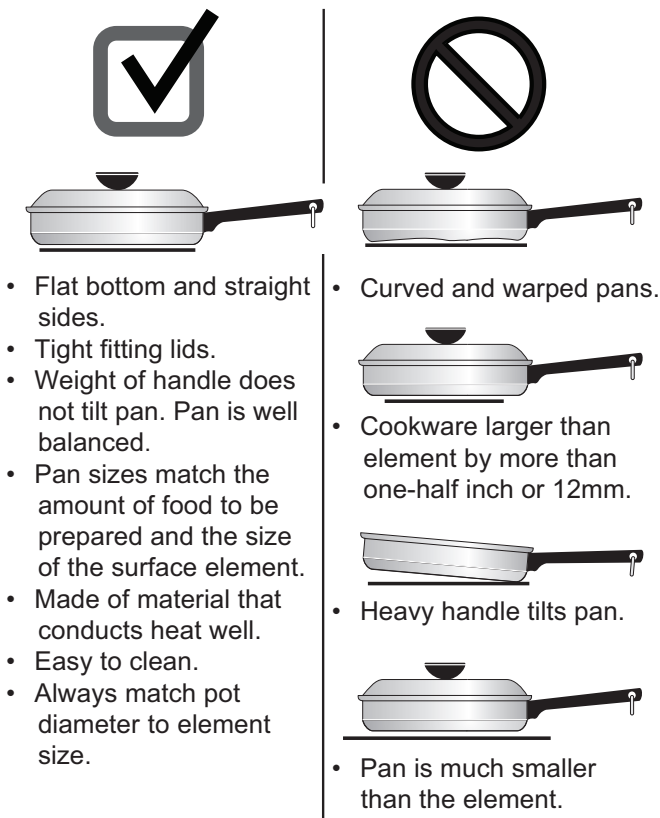

Figure 3: Proper cookware

About the Radiant Surface Cooktop

The ceramic glass cooktop has radiating elements located below the surface of the glass. The design of the ceramic cover marks the edges of the upper element below. Be sure to use utensils of the same size as the edge of the element on the cover and only use flat bottom utensils. The type and size of the utensil, as well as the amount of upper elements that are in use and their respective adjustments, are factors that will affect the amount of heat that will be distributed to areas near the upper elements. The areas surrounding the elements can get hot enough to cause burns.

About the Radiant Surface Elements

The temperature of the element rises gradually and uniformly. As the temperature rises, the element will glow red. To maintain the selected setting, the element will cycle through on and off. The heating element retains sufficient heat to provide uniform and constant heating during the shutdown cycle.

For efficient cooking, turn off the element several minutes before cooking is finished. This will allow residual heat to complete the cooking process.

⚠ CAUTION Surface elements may appear to have cooled after they have been turned off. **The element surface may still be hot**, and burns may occur if the element or surrounding area is touched before it has cooled to a safe temperature.

⚠ CAUTION Do not place flammable items such as plastic salt and pepper shakers, spoon holders, or plastic wrapping on top of the range when it is in use. These items could melt or ignite. Potholders, towels, or wooden spoons could catch fire if placed too close to the surface elements.

⚠ CAUTION Do not allow aluminum foil, or any material that can melt, to make contact with the cooking element. If these items melt on the cooktop, they will damage the cooktop.

Element On Indicator Lights

The ELEMENT ON indicator light will turn on when one or more elements are turned on.

The HOT SURFACE indicator light will come on when the element is too hot to touch and will remain on until the element has cooled to a safe temperature.

A quick glance at this indicator light when cooking is finished is an easy check to be sure all surface elements are turned off.

Important notes:

- Radiant elements have a limiter that allows the element to cycle on and off, even at the HI setting. This cycle in the HI setting is normal and will occur more often if the utensil is too small for the radiating element or if the bottom of the utensil is not flat.
- Be sure to read detailed instructions for coil cooktop cleaning in the [“Care and Cleaning”](#) section and [“Before You Call”](#) checklist section of this Use and Care Guide.

Setting Surface Controls

Radiant surface elements

⚠ CAUTION Radiant surface elements may appear to have cooled after they have been turned off. **The element may still be hot** and burns may occur if the element is touched before it has cooled sufficiently.

⚠ CAUTION Do not place flammable items such as plastic salt and pepper shakers, spoon holders, or plastic wrappings on top of the range when it is in use. These items could melt or ignite. Potholders, towels, or wooden spoons could catch fire if placed too close to the surface elements. To operate the radiant element.

Important: The type and size of utensil you use, as well as the amount and type of food you cook, will influence the power setting necessary to obtain the best results. The suggested adjustments in the table are based on cooking with medium-weight utensils made of aluminum and with lids. The settings may vary when other types of utensils are used.

1. Place correctly sized cookware on the radiant surface element.
2. Push in and turn the surface control knob in either direction (Figure 4) to the desired setting (refer to the “Suggested radiant surface element settings” table, Table 1).
3. When cooking is complete, turn the radiant surface element OFF before removing the cookware.

Start most cooking operations on a higher setting and then turn to a lower setting to finish cooking. The surface control knobs do not have to be set exactly on a particular spot. Use the graphics provided as a guide and adjust the control knob as needed (see Figure 4). A glowing red surface heating area extending beyond the bottom edge of the cookware indicates the cookware is too small for the surface heating area.

Suggested radiant surface element settings

The suggested settings found in below are based on cooking with medium-weight aluminum pans with lids. Settings may vary when using other types of pans.

Settings	Type of Cooktop
High (HI - 9)	Start most foods, bring water to a boil, pan broiling
Medium High (7 - 8)	Continue a rapid boil, fry, deep fat fry
Medium (5 - 6)	Maintain a slow boil, thicken sauces and gravies or steam vegetables
Medium Low (2 - 4)	Keep foods cooking, poach, stew
Low (1)	Low temperature cooking
Low (LO)	Keep warm, melt

Table 1: Suggested settings for radiant elements

Important note: Do not allow aluminum foil or ANY material that can melt to make contact with the radiant surface element. If these items melt on the cooktop, they will damage the cooktop.

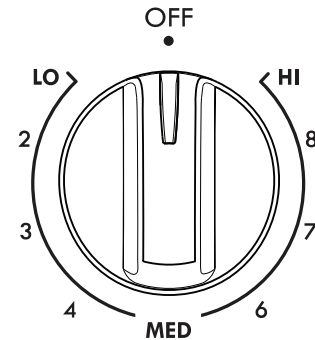

Figure 4: Surface control knob

Important notes:

- The Element ON indicator lights will glow when one or more elements are turned ON. A quick glance at these indicator lights when finished cooking is an easy check to be sure all control knobs are turned OFF.

Dual radiant surface elements

To operate a dual radiant element:

1. Place correctly sized cookware on the surface element.
2. Push in and turn the surface control knob clockwise to begin heating both the inner and outer elements. If only the inner element is needed for smaller cookware, push in and turn the knob counter-clockwise (see [Figure 7](#)).
3. When cooking is complete, turn the knob to OFF before removing the cookware.
4. Start most cooking operations on a higher setting and then turn to a lower setting to finish cooking. The surface control knobs do not have to be set exactly on a particular mark. Use the marks as a guide and adjust the control knob as needed.
5. A glowing red surface heating area extending beyond the bottom edge of the cookware indicates the cookware is too small for the surface heating area.
6. You may switch from either single or dual element setting at any time during cooking. See "[Suggested radiant surface element settings](#)" on [page 13](#).

⚠ CAUTION Radiant surface elements may appear to have cooled after they have been turned off. **The glass surface may still be hot** and burns may occur if the glass surface is touched before it has cooled sufficiently.

⚠ CAUTION Do not place flammable items such as plastic salt and pepper shakers, spoon holders or plastic wrappings on top of the range when it is in use. These items could melt or ignite. Potholders, towels or wooden spoons could catch fire if placed too close to the surface elements.

⚠ CAUTION Do not allow aluminum foil or ANY material that can melt to make contact with the ceramic glass cooktop. If these items melt on the cooktop, they will damage the ceramic cooktop.

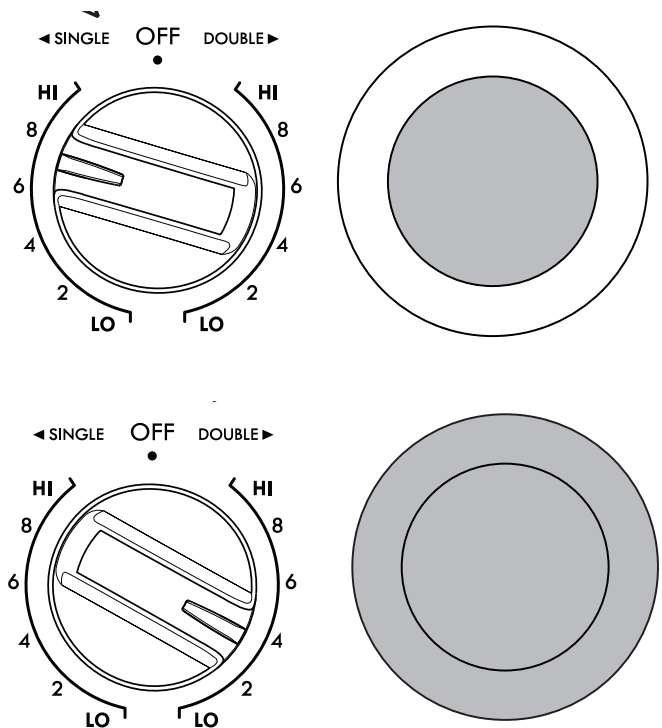

- Start most cooking functions at a higher setting and then at a lower setting to finish cooking.
- The Element ON indicator lights will turn on when one or more elements are turned ON. A quick glance at these indicator lights when finished cooking is an easy check to be sure all control knobs are turned OFF.

Setting Surface Controls

Warm Zone

Use the warm zone feature to keep cooked foods hot.

Always start with hot food. It is not recommended to heat cold food on the warm zone. All food placed on the warm zone should be covered with a lid to maintain quality.

For best results, when warming pastries or breads, the cover should have an opening to allow moisture to escape. Do not use plastic wrap to cover food. Plastic may melt onto the surface and be very difficult to clean. Use only dishware, utensils, and cookware recommended for oven and cooktop use on the warm zone.

Setting the warm zone control:

1. Push in the knob and turn in either direction. The temperatures are designated by hi and lo. However, the control can be set at any position between hi and lo for different levels of warming.
2. When ready to serve, turn the control to OFF. The hot surface indicator light will remain on until the warm zone cools.

⚠ CAUTION Unlike the surface elements, the warm zone will not glow red when it is hot. To avoid burns always use potholders or oven mitts when removing food from the cooktop, including the warm zone, as cookware and plates will be hot.

⚠ CAUTION Radiant surface elements may appear to have cooled after they have been turned off. The glass surface may still be hot and burns may occur if the glass surface is touched before it has cooled sufficiently.

⚠ CAUTION Do not place flammable items such as plastic salt and pepper shakers, spoon holders, or plastic wrappings on the cooktop when it is in use. These items could melt or ignite. Potholders, towels, or wooden spoons could catch fire if placed too close to the surface elements.

⚠ WARNING Food Poisoning Hazard: do not let food sit for more than 1 hour before or after cooking. Doing so may result in food borne illness.

Temperature selection - Refer to the recommended warm zone settings table. If a particular food is not listed, start with the medium level and adjust as needed. Most foods can be kept at serving temperatures by using the medium level.

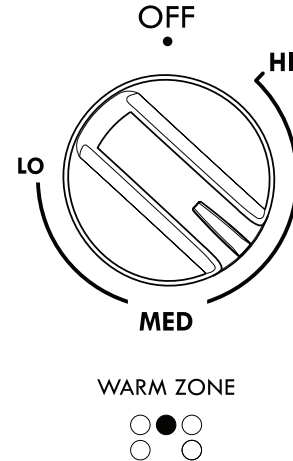

Figure 5: Warm Zone control

Important: Only use plates and utensils recommended for use in ovens and ceramic glass cooktops.

Food Item	Heating Level
Breads/Pastries	LO (Low)
Casseroles	LO (Low)
Dinner Plates with Food	LO (Low)
Eggs	LO (Low)
Gravies	LO (Low)
Meats	MED (Medium)
Sauces	MED (Medium)
Soups (cream)	MED (Medium)
Stews	MED (Medium)
Vegetables	MED (Medium)
Fried Foods	HI (High)
Hot Beverages	HI (High)
Soups (liquid)	HI (High)

Home Canning

Be sure to read and observe all the following points when home canning with your appliance. Check with the USDA (United States Department of Agriculture) Web site and be sure to read all the information they have available as well as follow their recommendations for home canning procedures.

- Use only a completely flat bottom canner with no ridges that radiate from the bottom center when home canning. Heat is spread more evenly when the bottom surface is flat. Use a straight-edge to check canner bottom.
- Make sure the diameter of the canner does not exceed 1 inch beyond the surface element markings or burner.
- It is recommended to use smaller diameter canners on electric coil and ceramic glass cooktops and to center canners on the burner grates.
- Start with hot tap water to bring water to boil more quickly.
- Use the highest heat setting when first bringing the water to a boil. Once boiling is achieved, reduce heat to lowest possible setting to maintain that boil.
- NEVER place or extend a cooking utensil over 2 different cooking areas at the same time. This will cause the heating to be uneven and could break the ceramic cover.
- Do not leave water bath or pressure canners on high heat for an extended amount of time.

Before Setting Oven

Oven Vent Location

The oven is vented as shown below. When the oven is on, warm air is released through the vent. This venting is necessary for proper air circulation in the oven and good baking results. Do not block oven vent. Never close off the openings with aluminium foil or any other material. Steam or moisture may appear near the oven vent. This is normal.

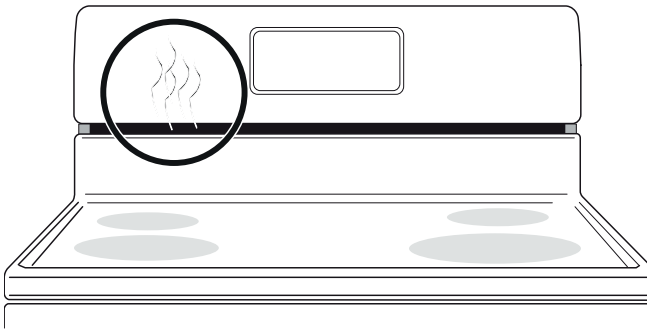

Figure 6: Oven vent

⚠ WARNING -Protective Liners — **Do not** use aluminum foil or any other material or liners to line the oven bottom, walls, racks or any other part of the range. Doing so will alter the heat distribution, produce poor baking results, and possibly cause permanent damage to the oven interior. Improper installation of these liners may result in risk of electric shock or fire.

⚠ CAUTION - Always use pot holders or oven mitts when using the oven. When cooking, the oven interior, oven exterior, oven racks, and cooktop will become very hot which can cause burns.

⚠ CAUTION - To prevent possible damage to the oven, do not attempt to close the oven door until all the oven racks are fully positioned back inside the oven cavity.

Types of oven racks

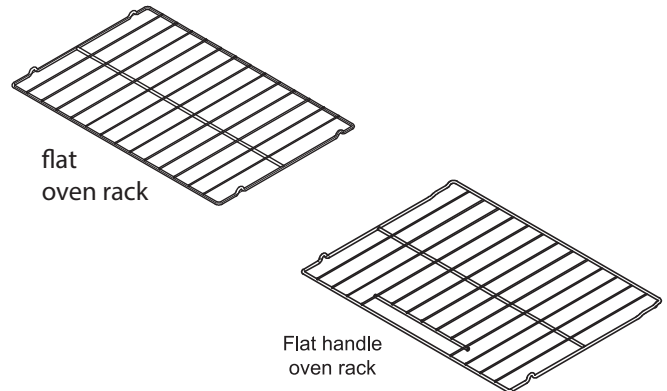

Figure 7: Oven rack types

- **Flat oven racks** may be used for most cooking needs and may be placed in most oven rack positions.

Removing, replacing, and arranging flat or offset oven racks

Always arrange the oven racks when the oven is cool.

To remove - Pull the oven rack straight forward until it reaches the stop position. Lift up front of oven rack slightly and slide out.

To replace - Place the oven rack on the rack guides on both sides of oven walls. Tilt the front of oven rack upward slightly and slide the oven rack back into place. Be sure oven racks are level before using.

Oven Controls

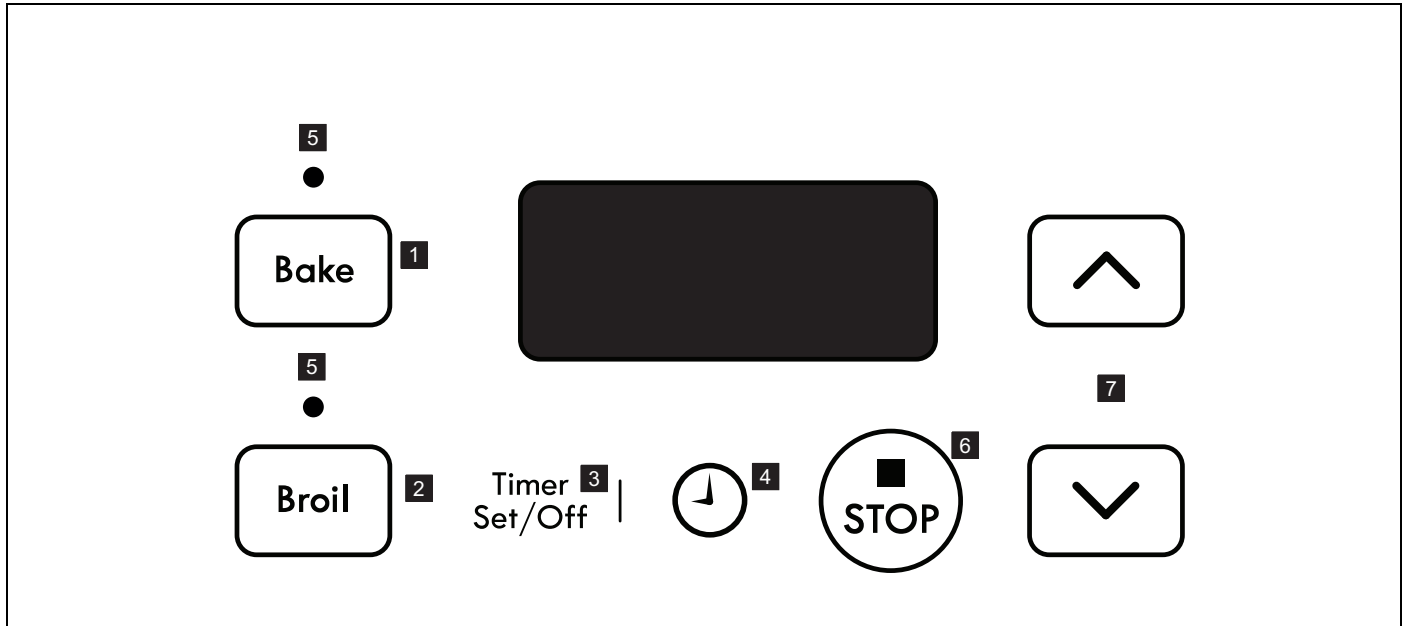

- 1. Bake key**— Use to select the bake feature.
- 2. Broil key**— Use to select the variable broil feature.
- 3. Timer Set/Off** — Use to set or cancel the minute timer. The minute timer does not start or stop cooking.
- 4. Set Clock** — Use to set the time of day.
- 5. Indicator lights** — These indicator lights show if Bake or Broil is active.
- 6. OFF** — Use to clear any feature previously entered except the time of day and minute timer. Press **STOP** to end cooking.
- 7. Up and down arrow pads**— Use with the feature or function pads to set oven temperature or adjusting the clock and minute timer.



Minimum and Maximum Setting

Feature	Mode	Min Temp or Time	Max.Temp or Time
Bake		170°F (77°C)	500°F (260°C)
Broil		LO	HI
Timer	12 Hr. Mode	1 minute	11 hrs 59 mins
Clock Time	12 Hr. Mode	1:00 Hr./Min.	12:59 Hr./Min.

Setting the Clock

When the appliance is first plugged in or when the power supply to the appliance has been interrupted, the display will flash **12:00**. It is recommended to always set the clock for the correct time of day before using the appliance.

To set the clock:

- Press  once (do not hold key down).
- Press and hold  or  until the correct time of day appears in the display and release the key.



Important note: The clock cannot be changed when the oven is set for cooking.



Oven Controls

Setting Timer

The timer may be set from 1 minute to 11 hours and 59 minutes.

To set the timer:

1. Press **Timer Set/Off**.
2. Press and hold  to increase the time. Release  when the desired time appears in the display. The timer will begin to count down.
3. When the set time has run out, the timer will sound with three beeps and will continue to beep three times every 60 seconds until **Timer Set/Off** is pressed.

To change time remaining in timer, press and hold  or  to increase or decrease any time remaining.

To cancel the timer before at any time, press **Timer Set/Off** once.



Important notes:

- The timer does not start or stop the cooking process. It serves as an extra timer in the kitchen that will beep when the set time has run out. The timer may be used alone or when any other oven function is active.
- The indicator light located above **Timer Set/Off** will glow when the timer is active.
- The timer will display hours and minutes until 1 hour remains. When less than 1 hour remains, the display will count down in minutes and seconds. Once the timer has less than 1 minute remaining, only seconds will display.
- If the timer is active when oven cooking, the minute timer will show in the display by default. To view information of any other active oven function, press the key once for the active function to view status.

Changing Temperature Display to Fahrenheit (°F) or Celsius (°C)

The electronic oven control is set to display °F when shipped from the factory. The display may be changed to show either °F or °C oven temperatures.

To change temperature display mode from °F to °C or from °C to °F:

1. Press and hold **Broil** until **F** or **C** appears in the display.
2. Press either  or  to toggle between **F** or **C** mode choices.
3. Release the arrow key and the oven control will accept change. The display will return to the time of day.

Important note:

The temperature display mode cannot be changed when the oven is set for cooking.

Operating Oven Light

The oven light will automatically turn on when the oven door is opened. Press the oven light switch located on the upper left control panel to turn the interior oven light ON and OFF whenever the oven door is closed.

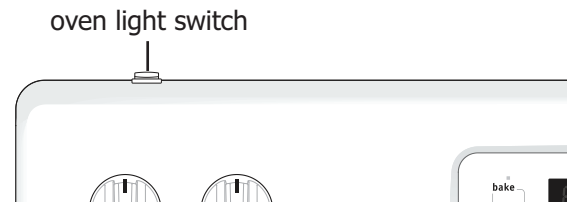

The oven light is located at the upper left rear wall of the oven interior and is covered with a glass shield held in place by a wire holder. The glass shield protects the bulb from high temperatures and should always be in place when the oven is in use.

To replace the interior oven light, see [“Replacing the Oven Light”](#) on page 24.

Setting Bake





Use the bake function whenever the recipe calls for baking using normal temperatures. A reminder tone will sound when the set bake temperature is reached. Bake may be programmed for any temperature from 170°F to 500°F (77°C to 260°C). The factory preset bake temperature is 350°F (177°C).

⚠ CAUTION Always use pot holders or oven mitts when using the oven. When cooking the oven interior, oven racks and cook-top will become very hot which can cause burns.

Baking tips

- Fully preheat the oven before cooking items like cookies, biscuits, and breads.
- When using any single rack, position the rack so that the food is in the center of the oven on rack position 4. Place pans as shown in [Figure 8](#).
- For best results when baking cakes or cookies using two oven racks, place racks in positions 3 and 5.
- Dark or dull bakeware absorbs more heat than shiny bakeware. It may be necessary to reduce oven temperature and cook time to prevent overbrowning of some foods.
- Dark bakeware is recommended for pies. Shiny bakeware is recommended for cakes, cookies, and muffins.
- Do not open the oven door often. Opening the door will reduce the temperature in the oven and may increase the cooking time.
- Do not leave oven light on while baking.

To set Bake

1. Arrange oven racks and close oven door.
2. Press **Bake**. The display will show — —.
3. Press  or . The display will show the default oven temperature of **350°F (177°C)**. By pressing  or , the oven temperature may be adjusted in 5°F increments (1°C). When the desired setting is reached release the up or down key.
4. The oven will begin heating to the selected temperature. When the oven temperature reaches the set temperature.

To cancel bake at anytime, Press  .

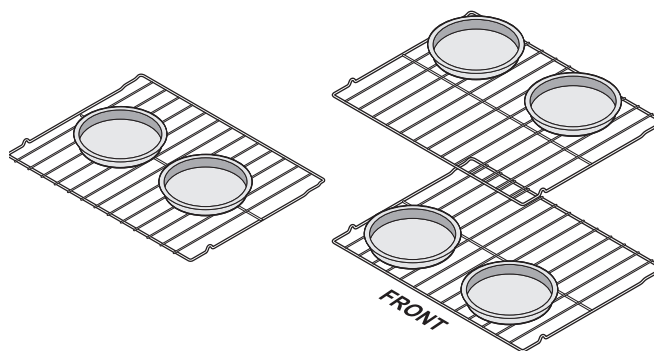

Figure 8: Baking on multiple levels

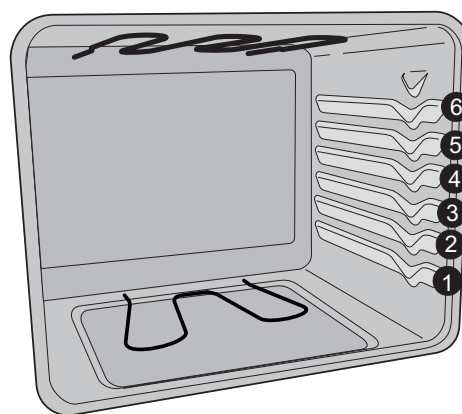

Figure 9: Oven rack positions

Oven Controls

Setting Broil

Broiling is direct heat cooking and will produce some smoke. If smoke is excessive, place food further away from the element. Watch food to prevent burning. When broiling, always remember to arrange the oven racks while oven is still cool. Increase or decrease broiling times or move to a different rack position to suit for doneness.

⚠ WARNING Should an oven fire occur, close the oven door and turn the oven off. If the fire continues, use a fire extinguisher. Do not put water or flour on the fire. Flour may be explosive. Do not use broiler drawer for storage. Items placed in broiler drawer will catch fire.



⚠ CAUTION Always use pot holders or oven mitts when using the oven. When cooking, the oven interior, oven racks, and cooktop will become very hot which can cause burns

Broiling Tips:

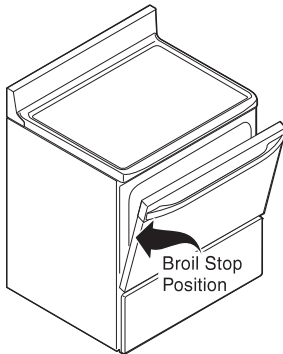
- If using broil pan and insert, place insert on broil pan. Place on oven rack, preheat on broil HI for 5 minutes before placing food on insert. Broil with the oven door open to the stop position.
- When broiling, always pull the oven rack out to the stop position before turning or removing food.
- When cooking, the oven interior, exterior, and oven racks will become very hot which can cause burns. Always arrange oven racks when oven is cool.
- Do not use the broil pan without the insert. Do not cover the insert with foil; the exposed grease could catch fire.



To set broil:

1. Arrange the oven rack while oven is still cool.
2. Press broil. The display will show — —.
3. Press  for HI broil or  for LO broil. Most foods may be broiled at the HI broil setting.
4. For optimum results, preheat pan using Broil HI for 5 minutes before placing food on pan. Boil with the oven door open.
5. Broil on one side until food is browned. Turn and broil food on the other side.
6. When broiling is finished press STOP.

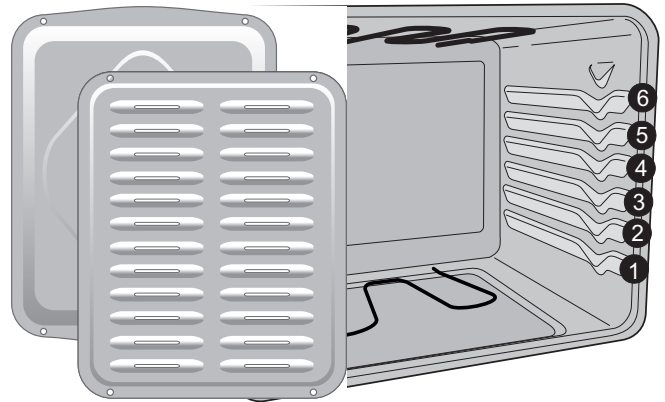

For best results when broiling, use broil pan along with pan insert. A broil pan is designed to drain the fat from food, helping to reduce smoking and avoid splatter.

Note: If a broiler pan and insert are not supplied with this appliance, they may be purchased from Sears. Call 1-844-553-6667 and order broiler pan kit 5304442087.

Table 2: Broil recommendations

Food item	Rack Position	Temperature	Cook time in minutes		Doneness
			1st side	2nd side	
Steak 1" thick	5	HI	6:00	4:00	Rare
Steak 1" thick	5	HI	7:00	5:00	Medium
Pork Chops 3/4 "thick	4	HI	8:00	6:00	Well
Chicken - Bone In	3	HI	20:00	10:00	Well
Chicken Boneless	4	HI	8:00	6:00	Well
Fish	3	HI	as directed		Well
Shrimp	3	HI	as directed		Well
Hamburger 1" thick	5	HI	7:00	5:00	Medium
Hamburger 1" thick	5	HI	8:00	7:00	Well



** The U.S. Department of Agriculture states, "Rare fresh beef is popular, but you should know that cooking it to only 140°F (60°C) means some food poisoning organisms may survive." (Source: Safe Food Book, Your Kitchen Guide, USDA Rev. June 1985.) The lowest temperature recommended by the USDA is 145°F (63°C) for medium rare fresh beef. For well done 170°F (77°C).

Adjusting oven temperature



The appliance has been factory calibrated and tested to ensure an accurate baking temperature, known as the User Preference Offset (UPO). For the first few uses, follow your recipe times and temperature recommendations carefully. If you think the oven is cooking too hot or too cool for your recipe times, you may adjust the control so the oven cooks hotter or cooler than the oven temperature displayed.

The oven temperature may be increased as much as +35°F (+19°C) or decreased -35°F (-19°C) from the factory calibrated settings.

To adjust oven temperature:

1. Press **Bake** and hold for 5 seconds. The UPO value will appear in the display with a degree sign.
2. The display now indicates the amount of degrees offset from the original factory temperature setting. If the control still has the original factory calibration, the display will read **00**.
3. The temperature may be adjusted up or down 35°F (19°C), in 5°F increments by pressing and holding  or . Adjust until the desired amount of temperature offset appears in the display and the oven will save the setting automatically.
4. If the **STOP** key is pressed during the programming mode, the UPO value will remain unchanged.

Important notes:

- Oven temperature adjustments made will not change the Broil temperatures.
- Do not use oven thermometers such as those found in grocery stores to check the temperature settings inside your oven. These oven thermometers may vary as much as 20°F to 40°F degrees from actual temperatures.
- The oven temperature adjustment may be made if your oven control has been set to display °C temperatures. Minimum and maximum settings for °C is plus (+) or minus (-) 19°C.
- If the display mode is set for °C, adjustments made will be in 1°C increments on each press of  or .

Care and Cleaning

Remove spills and any heavy soiling as soon as possible. Regular cleaning will reduce the difficulty of major cleaning later.

⚠ CAUTION Before cleaning any part of the appliance, be sure all controls are turned off and the appliance is cool.

⚠ CAUTION If ammonia or appliance cleaners are used, they must be removed and the appliance must be thoroughly rinsed before operating. Follow manufacturer's instructions and provide adequate ventilation.

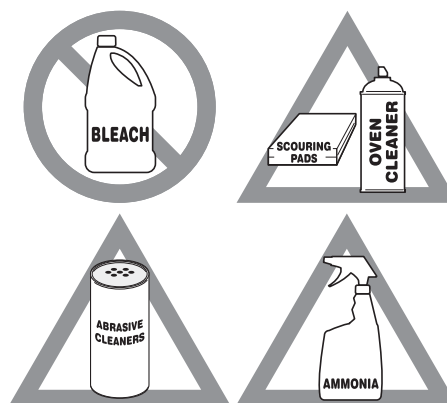

Surface or Area	Cleaning Recommendation
Aluminum and vinyl	Using a soft cloth, clean with mild dish detergent and water. Rinse with clean water, dry and polish with a soft, clean cloth.
Painted and plastic control knobs Painted body parts Painted decorative trims	Using a soft cloth, clean with mild dish detergent and water or a 50/50 solution of vinegar and water. Rinse with clean water, dry and polish with a soft, clean cloth. Glass cleaners may be used, but do not apply directly to surface; spray onto cloth and wipe.
Control panel	Using a soft cloth, clean with mild dish detergent and water or a 50/50 solution of vinegar and water. Do not spray liquids directly on the oven control and display area. Do not use large amounts of water on the control panel - excess water on the control area may cause damage to the appliance. Do not use other liquid cleaners, abrasive cleaners, scouring pads, or paper towels - they will damage the finish.
Control knobs	Using a soft cloth, clean with mild dish detergent and water or a 50/50 solution of vinegar and water. To remove control knobs: turn to the OFF position, grasp firmly, and pull off the shaft. To replace knobs after cleaning, line up the OFF markings and push the knobs into place.
Stainless Steel	Using a soft cloth, clean with mild dish detergent and water or a 50/50 solution of vinegar and water. Rinse with clean water, dry with a soft clean cloth. Do not use cleaners containing abrasives, chlorides, chlorine, or ammonia.
Easy Clean Stainless Steel Black Stainless Steel	Using a soft cloth, clean with mild dish detergent and water or a 50/50 solution of vinegar and water. Rinse with clean water, dry with a soft clean cloth. Do not use appliance cleaner, stainless steel cleaner, or cleaner containing abrasives, chlorides, chlorine, or ammonia. These cleaners may damage the finish.
Porcelain-enameled broiler pan and insert Porcelain door liner Porcelain body parts	Rinse with clean water and a damp cloth. Scrub gently with a soapy, non-abrasive scouring pad to remove most spots. Rinse with a 50/50 solution of clean water and ammonia. If necessary, cover difficult spots with an ammonia-soaked paper towel for 30 to 40 minutes. Rinse and wipe dry with a clean cloth. Remove all cleaners or future heating could damage the porcelain. Do not allow food spills with a high sugar or acid content (milk, tomatoes, sauerkraut, fruit juices or pie filling) to remain on porcelain surfaces. These spills may cause a dull spot even after cleaning.
Oven door	Use mild dish detergent and water or a 50/50 solution of vinegar and water to clean the top, sides, and front of the oven door. Rinse well. Glass cleaner may be used on the outside glass of the door. Ceramic smoothtop cleaner or polish may be used on the interior door glass. Do not immerse the door in water. Do not spray or allow water or cleaners to enter the door vents. Do not use oven cleaners, cleaning powders, or any harsh abrasive cleaning materials on the outside of the oven door. Do not clean the oven door gasket. The oven door gasket is made of a woven material which is essential for a good seal. Do not rub, damage, or remove this gasket.
Manual clean oven interior	The oven interior is porcelain coated and safe to clean using oven cleaners. Always follow manufacturer's instructions for cleaners. After cleaning, remove any oven cleaner or the porcelain may become damaged during future heating. Do not spray oven cleaner on any electrical controls or switches. Do not spray or allow oven cleaner to build up on the oven temperature sensing probe. Do not spray cleaner on oven door trim, door gasket, plastic drawer glides, handles or any exterior surfaces of the appliance.

Cooktop maintenance

Consistent and proper cleaning is essential to maintaining your ceramic glass cooktop.

Before using your cooktop for the first time, apply a ceramic cooktop cleaning cream (available in most hardware, grocery, and department stores) to the ceramic surface.

Buff with a non-abrasive cloth or no-scratch cleaning pad. This will make cleaning easier when soiled from cooking. The special cooktop cleaning cream leaves a protective finish on the glass to help prevent scratches and abrasions.

Sliding aluminum or copper clad bottom pans on the cooktop can cause metal markings on the cooktop surface. These marks should be removed immediately after the cooktop has cooled using the cooktop cleaning cream. Metal marks can become permanent if not removed prior to future use.

Cookware (cast iron, metal, ceramic or glass) with rough bottoms can mark or scratch the cooktop surface.

Do Not:

- Use cookware with dirt or dirt build up on bottom; replace with clean cookware before using.
- Use your cooktop as a cutting board or work surface in the kitchen.
- Cook food directly on the cooktop surface without a pan.
- Drop heavy or hard objects on the ceramic glass cooktop, they make cause it to crack.
- Slide anything metal or glass across the cooktop.

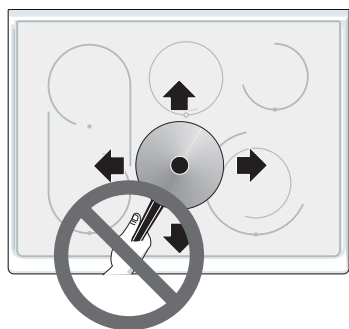

Figure 10: Do not slide pan on cooktop

Do not use the following on the cooktop:

- Do not use abrasive cleaners and scouring pads, such as metal and some nylon pads. They may scratch the cooktop, making it more difficult to clean.
- Do not use harsh cleaners, such as chlorine bleach, ammonia or oven cleaners, as they may etch or discolor the cooktop.
- Do not use dirty sponges, cloths or paper towels, as they can leave soil or lint on the cooktop which can burn and cause discoloration.

Cooktop Cleaning

⚠ WARNING Do not use a cooktop cleaner on a hot cooktop. The fumes can be hazardous to your health, and can chemically damage the ceramic-glass surface.

⚠ CAUTION Before cleaning the cooktop, be sure the controls are turned off and the cooktop is COOL. The glass surface could be hot and burns may occur if the glass surface is touched before it has cooled sufficiently.

For light to moderate soil

Apply a few drops of ceramic cooktop cleaning cream directly to the cooktop. Use a paper towel or use a non-abrasive plastic type no-scratch cleaning pad to clean the entire cooktop surface. Make sure the cooktop is cleaned thoroughly, leaving no residue.

For heavy, burned on soil:

Apply a few drops of ceramic cooktop cleaning cream directly to the soiled area. Rub the soiled area using a non-abrasive plastic type no-scratch cleaning pad, applying pressure as needed. Do not use the pad you use to clean the cooktop for any other purpose.

If soils remain, carefully scrape soils with a metal razor blade scraper, holding scraper at a 30 degree angle to the surface. Remove loosened soils with cooktop cleaning cream and buff surface clean.

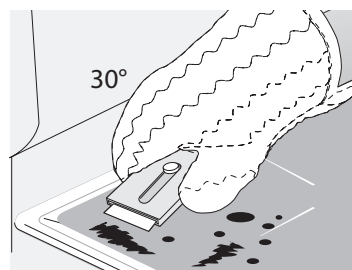

Figure 11: Cleaning with aid of razor blade

Plastic or foods with a high sugar content:

These types of soils need be removed immediately if spilled or melted onto the ceramic cooktop surface. Permanent damage (such as pitting of the cooktop surface) may occur if not removed immediately. After turning the surface elements off, use a razor blade scraper or a metal spatula with a mitt and scrape the soil from the hot surface (as illustrated). Allow the cooktop to cool, and use the same method for heavy or burned on soils.

Care and Cleaning

General Cleaning

⚠ CAUTION Before manually cleaning any part of the range, be sure all controls are turned off and the range is cool. The range may be hot and can cause burns.

⚠ CAUTION Ammonia must be rinsed before operating the oven. Provide adequate ventilation.

Aluminum foil and utensils

⚠ WARNING Never cover any slots, holes, or passages in the oven bottom or cover an entire oven rack with materials such as aluminum foil. Aluminum foil linings may trap heat, causing a fire hazard.

- Protective Liners — Do not use aluminum foil to line the oven bottom. Only use aluminum foil as recommended in this manual. Improper installation of these liners may result in risk of electric shock, or fire.

Replacing the Oven Light

⚠ CAUTION Be sure the oven is unplugged and all parts are cool before replacing the oven light.

Replacing the oven interior light bulb:

The interior oven light is located at the rear of the oven cavity (Figure 10).

1. Turn electrical power off at the main source or unplug the appliance.
2. Replace the bulb with a new appliance bulb.
3. Turn the power back on again at the main source (or plug the appliance back in).
4. Be sure to reset the time of day on the clock.

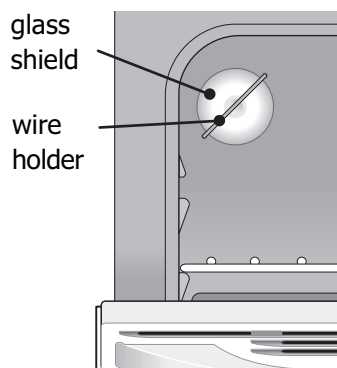

Figure 12: Oven light

To remove and replace storage drawer (some models)

Use the storage drawer for storing cooking utensils. The drawer can be removed to facilitate cleaning under the range. Use care when handling the drawer.

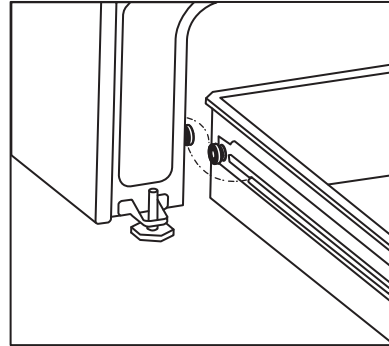

Figure 13: Open storage drawer

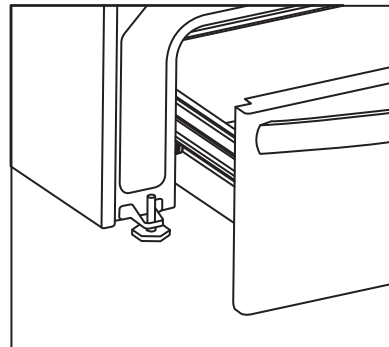

Figure 14: Closed storage drawer

Removing and Replacing the Oven Door:

⚠ CAUTION The door is heavy. For safe, temporary storage, lay the door flat with the inside of the door facing down.

To remove the oven door

1. Open oven door completely, horizontal with floor (See [Figure 15](#)).
2. Pull the door hinge locks on both left and right door hinges down from the oven frame completely towards the oven door (See [Figure 16](#)). A tool such as a small flat-blade screwdriver may be required.
3. Firmly grasp both sides of oven door along the door sides. Do not use the oven door handle (See [Figure 17](#)).
4. Close the door to approximately 10 degrees from the door frame (See [Figure 17](#)).
5. Lift the oven door hinge arms over the roller pins located on each side of the oven frame (See [Figure 18](#)).

To replace the oven door:

1. Firmly grasp both sides of oven door along the door sides. Do not use the oven door handle (See [Figure 17](#)).
2. Holding the oven door at the same angle as the removal position, seat the hook of the hinge arm over the roller pins located on each side of the oven door frame (See [Figure 17](#) and [Figure 18](#)). The hook of the hinge arms must be fully seated onto the roller pins.
3. Fully open the oven door, horizontal with floor (See [Figure 15](#)).
4. Push the door hinge locks up towards and into the oven frame on both left and right oven door hinges to the locked position (See [Figure 16](#)).
5. Close the oven door.

Important note: Special door care instructions - Most oven doors contain glass that can break. Do not hit the glass with pots, pans, or any other object. Scratching, hitting, jarring, or stressing the glass may weaken its structure, causing an increased risk of breakage at a later time. Do not close the oven door until all of the oven racks are fully in place.

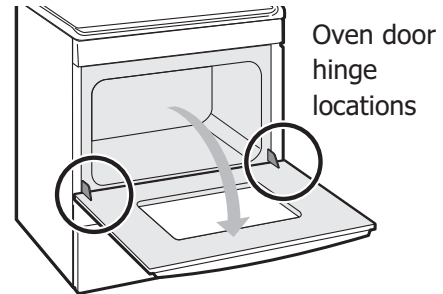

Figure 15: Door hinge location

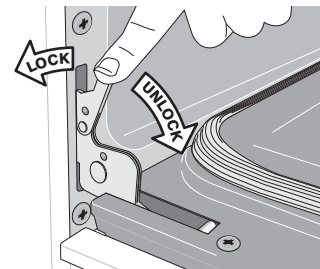

Figure 16: Door hinge locks

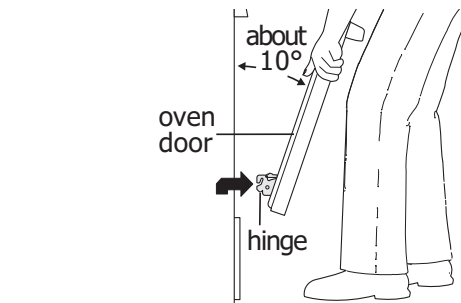

Figure 17: Holding door for removal

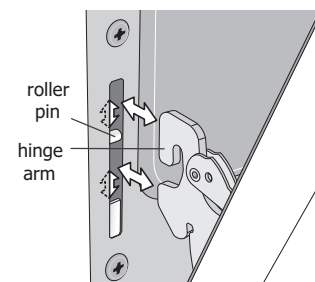

Figure 18: Replacement and location of hinge arm and roller pin





Before You Call

Oven Baking Problems

For best cooking results, heat the oven before baking cookies, breads, cakes, pies, pastries, et cetera. There is no need to preheat the oven for roasting meat or baking casseroles.

The cooking times and temperatures needed to bake a product may vary slightly from your previously owned appliance.

Baking Problems and Solutions

Baking Problems	Causes	Corrections
<p>Cookies and biscuits burn on the bottom.</p> 	<ul style="list-style-type: none"> • Cookies and biscuits put into oven before the preheating time is completed. • Oven rack is overcrowded. • Dark pans absorb heat too fast. 	<ul style="list-style-type: none"> • Allow oven to preheat to desired temperature before placing food in oven. • Choose pan sizes that will permit 2" to 4" of air space (5.1 cm or 10.2 cm) on all sides when placed in the oven. • Use a medium weight baking sheet.
<p>Cakes too dark on top or bottom</p> 	<ul style="list-style-type: none"> • Cakes put in oven before preheating time is completed. • Rack position too high or too low. • Oven too hot. 	<ul style="list-style-type: none"> • Allow oven to preheat to the selected temperature before placing food in the oven. • Use proper rack position for baking needs. • Set oven temperature 25°F (13°C) lower than recommended.
<p>Cakes not done in center</p> 	<ul style="list-style-type: none"> • Oven too hot. • Incorrect pan size. • Pan not centered in oven. • Glass cookware slow heat conductor. 	<ul style="list-style-type: none"> • Set oven temperature 25°F (13°C) lower than recommended. • Use pan size suggested in recipe. • Use proper rack position and place pan so there is 5.1 cm to 10.2 cm (2" to 4") of space on all sides of pan. • Reduce temperature and increase cook time or use shiny bakeware.
<p>Cakes not level.</p> 	<ul style="list-style-type: none"> • Oven not level. • Pan too close to oven wall or rack overcrowded. • Pan warped. 	<ul style="list-style-type: none"> • Place a marked glass measuring cup filled with water on the center of the oven rack. If the water level is uneven, refer to the installation instructions for leveling the oven. • Be sure to allow 5.1 cm to 10.2 cm (2" to 4") of clearance on all sides of each pan in the oven. • Do not use pans that are dented or warped.
<p>Foods not done when cooking time is over.</p> 	<ul style="list-style-type: none"> • Oven too cool. • Oven overcrowded. • Oven door opened too frequently. 	<ul style="list-style-type: none"> • Set oven temperature 25°F (13°C) higher than suggested and bake for the recommended time. • Be sure to remove all pans from the oven except the ones to be used for baking. • Open oven door only after shortest recommended baking time. • Make sure to allow 2" to 4" of clearance between all pans and racks, allowing for even air flow.

Solutions to Common Problems:

Before you call for service, review the following list. It may save you time and expense. Possible solutions are provided with the problem listed.

Problem	Cause / Solution
Entire appliance does not operate.	Appliance not connected. Make sure power cord is plugged properly into outlet. Check your fuse box or breaker box to make sure the circuit is active. Electrical power outage. Check house lights to be sure. Call your local electric company for service outage information.
Oven Problems	
Poor baking results.	Many factors affect baking results. Use proper oven rack position. Center food in the oven and space pans to allow air to circulate. Preheat the oven to the set temperature before placing food in the oven. Try adjusting the recipe's recommended temperature or baking time. See "Adjusting oven temperature" on page 21 if you feel the oven is too hot or too cool.
Flames inside oven or smoking from oven vent.	Excessive spills in oven. Grease or food spilled onto the oven bottom or oven cavity. Wipe up excessive spills before starting the oven. If flames or excessive smoke are present when using broil, see "Setting Broil" on page 20 .
Oven smokes excessively when broiling.	Incorrect setting. Follow the "Setting Broil" instructions on page 20 . Meat too close to the broil element or burner. Reposition the broil pan to provide proper clearance between the meat and broil element or burner. Remove excess fat from meat. Cut remaining fatty edges to prevent curling, but do not cut into lean. Grease build up on oven surfaces. Regular cleaning is necessary when broiling frequently. Grease or food splatters will cause excessive smoking.
Oven control panel beeps and displays any F or E code error.	Oven control has detected a fault or error condition. To clear the error, press the OFF key on the control panel. Once the error code is cleared, try the bake or broil function. If the F or E code error repeats, turn off the power to appliance, wait 5 minutes, and then repower the appliance. Set the clock with correct time of day. Try the bake or broil function again. If the fault recurs, press the OFF key to clear.
Oven portion of appliance does not operate.	The time of day is not set. The clock must be set in order to operate the oven. See "Setting the Clock" on page 17 . Be sure the oven controls are set properly for the desired function. See "Oven Controls" starting on page 17 and review instructions for the desired cooking function in this manual or see "Entire appliance does not operate." in this checklist.
Cooktop Problems	
Surface element is too hot or not hot enough.	Incorrect surface control setting. Adjust power level setting.
Surface element does not heat or does not heat evenly.	Be sure the correct surface control knob is turned on for the element needed. Cookware is light weight or warped. Use only flat, evenly balanced, medium or heavyweight cookware. Flat pans heat better than warped pans. Cookware materials and weight of the material affect heating. Heavy and medium-weight pans heat evenly. Because lightweight pans heat unevenly, foods may burn easily.

Before You Call

Problem	Cause / Solution
Scratches or abrasions on cooktop surface.	<ul style="list-style-type: none">• Coarse particles such as salt or hardened soils between cooktop and utensils can cause scratches. Be sure cooktop surface and bottoms of utensils are clean before using. Small scratches do not affect cooking performance and will become less visible with time.• Cleaning materials not recommended for ceramic-glass cooktop have been used. Apply a ceramic cooktop cleaning cream to the ceramic surface (on the web visit www.sears.com for cooktop cleaner, item number 40079). Buff with a non-abrasive cloth or no-scratch cleaning pad. For more information see "Cooktop maintenance" and "Cooktop cleaning" in the Care and Cleaning section of this Use & Care Guide.• Cookware with rough bottom was used. Use smooth, flat-bottomed cookware.
Metal marks on cooktop.	<ul style="list-style-type: none">• Do not slide metal utensils on cooktop surface. Doing so will leave marks. Apply a ceramic cooktop cleaning cream to the ceramic surface. Buff with non-abrasive cloth or no-scratch cleaning pad. For more information see "Cooktop maintenance" and "Cooktop cleaning" in the Care & Cleaning section of this Use & Care Guide.
Brown streaks or specks on cooktop surface.	<ul style="list-style-type: none">• Food that boils over can cook onto surface. Use razor blade scraper to remove soil. For more information see "Cooktop maintenance" and "Cooktop cleaning" in the Care and Cleaning section of this Use & Care Guide.
Areas of discoloration with metallic sheen on cooktop surface.	<ul style="list-style-type: none">• Mineral deposits from water and food. Remove using a ceramic cooktop cleaning cream to the ceramic surface. Buff with a non-abrasive cloth or no-scratch cleaning pad.
Oven racks discolored or do not slide easily	<ul style="list-style-type: none">• Clean by using a mild abrasive cleaner following manufacturer's instructions. Rinse with clean water, dry, and replace in oven.
Other Problems	
Appliance is not level.	<p>Be sure the floor is level, strong, and stable enough to adequately support the range.</p> <p>If the floor is sagging or sloping, contact a carpenter to correct the situation.</p> <p>Poor installation. Place the oven rack in the center of the oven. Place a level on the oven rack. Adjust the leveling legs at the base of the appliance until the rack is level.</p> <p>Kitchen cabinet alignment may make range appear not level. Be sure cabinets are square and have sufficient room for appliance clearance.</p>
Cannot move appliance easily. Appliance must be accessible for service.	<p>Cabinets not square or are built in too tightly. Contact the builder or installer to make the appliance accessible.</p> <p>Carpet interferes with appliance. Provide sufficient space so the appliance can be lifted over carpet. Installation over carpet is not advised. See the installation instructions for guidelines specific to your appliance.</p>
Oven light does not work.	Be sure the oven light is secure in the socket. See " Replacing the Oven Light " on page 24 .

Kenmore®

Customer Care Hotline

To schedule in-home repair service
or order replacement parts

Para pedir servicio de reparación
a domicilio, y ordenar piezas

1-844-553-6667

www.kenmore.com

