

# FRIGIDAIRE

All about the

# Use & Care

of your Electric Range

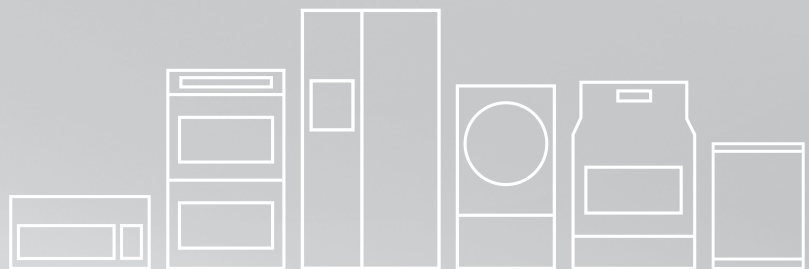

## TABLE OF CONTENTS

Product Record and Registration . . . . .	2	Setting Oven Controls . . . . .	18
Important Safety Instructions . . . . .	3	Care and Cleaning . . . . .	27
Cooking Recommendations . . . . .	9	Before You Call . . . . .	33
Before Setting Surface Controls . . . . .	11	Warranty . . . . .	36
Setting Surface Controls . . . . .	14		
Before Setting Oven Controls . . . . .	17		

A13080603 Rev A (March 2019)

# PRODUCT RECORD AND REGISTRATION

Product Registration .....	2
<b>Product Record and Registration</b> .....	<b>2</b>
Need Help? .....	2
<b>Important Safety Instructions</b> .....	<b>3</b>
<b>Cooking Recommendations</b> .....	<b>9</b>
<b>Before Setting Surface Controls</b> .....	<b>11</b>
<b>Setting Surface Controls</b> .....	<b>14</b>
<b>Before Setting Oven Controls</b> .....	<b>17</b>
<b>Setting Oven Controls</b> .....	<b>18</b>
<b>Care and Cleaning</b> .....	<b>27</b>
Oven Baking .....	33
<b>Before You Call</b> .....	<b>33</b>
<b>Warranty</b> .....	<b>36</b>

## Questions?

For toll-free telephone support in the U.S. and Canada call **1-800-944-9044**

For online support and Internet production information visit <http://www.frigidaire.com>.

## Product Registration

Registering your product with Frigidaire enhances our ability to serve you. You can register online at <http://www.frigidaire.com> or by dropping your Product Registration Card in the mail.

### Record model & serial numbers here

---

Purchase Date

---

Frigidaire model number

---

Frigidaire serial number

### Serial Plate Location

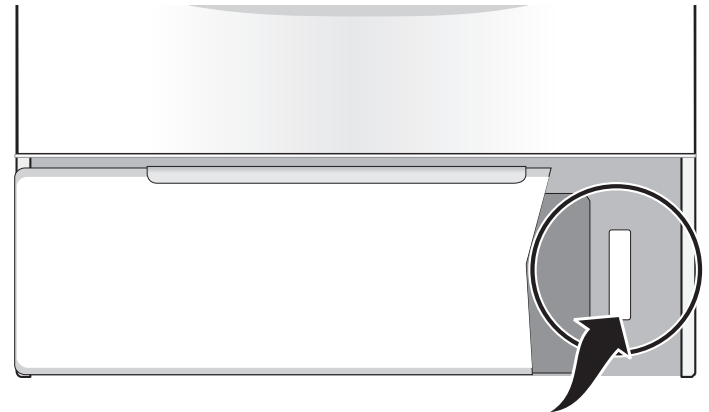

Serial plate location: open lower oven drawer (some models) or storage drawer (some models).

### Thank you for choosing Frigidaire.

**Important:** This Use and Care Guide is part of our commitment to customer satisfaction and product quality throughout the service life of your new appliance. We view your purchase as the beginning of a relationship. To ensure our ability to continue serving you, please use this page to record important product information.

### Need Help?

#### Visit the Frigidaire web site at [www.frigidaire.com](http://www.frigidaire.com)

Before you call for service, there are a few things you can do to help us serve you better.

#### Read this Use & Care Manual

This manual contains instructions to help you use and maintain your range properly.

#### If You Received a Damaged Range...

Immediately contact the dealer (or builder) that sold you the range.

#### Save Time and Money

Check the section title "Before You Call". This section helps step you through some common problems that might occur.

If you do need service, help is only a phone call away. Call Frigidaire Customer Services at **1-800-944-9044**.

## IMPORTANT SAFETY INSTRUCTIONS

Read all instructions before using this appliance.

This manual contains important safety symbols and instructions. Please pay attention to these symbols and follow all instructions given.

Do not attempt to install or operate your appliance until you have read the safety precautions in this manual. Safety items throughout this manual are labeled with a **WARNING** or **CAUTION** statement based on the risk type.

Warnings and important instructions appearing in this guide are not meant to cover all possible conditions and situations that may occur. Common sense, caution, and care must be exercised with installing, maintaining, or operating your appliance.

### DEFINITIONS

 This is the safety alert symbol. It is used to alert you to potential personal injury hazards. Obey all safety messages that follow this symbol to avoid possible injury or death.

### **WARNING**

Indicates a potentially hazardous situation which, if not avoided, may result in death or serious injury.

### **CAUTION**

Indicates a potentially hazardous situation which, if not avoided, may result in minor or moderate injury.

### **IMPORTANT**

Indicates installation, operation, maintenance, or valuable information that is not hazard related.

### **NOTE**

Indicates a short, informal reference – something written down to assist the memory or for future reference.

### **WARNING**

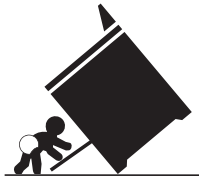

#### Tip Over Hazard

- **A child or adult can tip the range and be killed.**
- **Verify the anti-tip device has been installed to floor or wall.**
- **Ensure the anti-tip device is re-engaged to floor or wall when the range is moved.**
- **Do not operate the range without the anti-tip device in place and engaged.**
- **Failure to follow these instructions can result in death or serious burns to children and adults.**

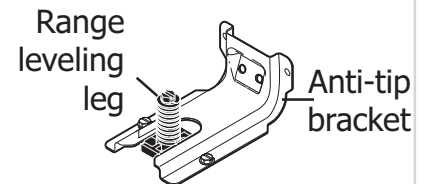

To check if the anti-tip bracket is installed properly, use both arms to grasp the rear edge of the range back. Carefully attempt to tilt range forward. When properly installed, the range should not tilt forward.

Refer to the anti-tip bracket installation instructions supplied with your range for proper installation.

### **IMPORTANT**

Save these instructions for future reference.

## IMPORTANT SAFETY INSTRUCTIONS

### IMPORTANT INSTRUCTIONS FOR UNPACKING AND INSTALLATION

**IMPORTANT** - Read and follow the below instructions and precautions for unpacking, installing, and servicing your appliance:

Remove all tape and packaging before using the appliance. Destroy the carton and plastic bags after unpacking the appliance. Never allow children to play with packaging material. Do not remove the wiring label and other literature attached to the appliance. Do not remove model/serial number plate.

Cold temperatures can damage the electronic control. When using this appliance for the first time, or when the appliance has not been used for an extended period of time, be sure the appliance has been in temperatures above 32°F (0°C) for at least 3 hours before turning on the power to the appliance.

Never modify or alter the construction of the appliance by removing the leveling legs, panels, wire covers, anti-tip brackets/screws, or any other part of the appliance.

Be sure to have an appropriate foam-type fire extinguisher available, visible, and easily accessible located near the appliance.

### GROUNDING INSTRUCTIONS

#### **WARNING**

Avoid fire hazard or electrical shock. Failure to follow this warning may cause serious injury, fire, or death.

Avoid fire hazard or electrical shock. Do not use an adapter plug, use an extension cord, or remove grounding prong from the power cord. Failure to follow this warning may cause serious injury, fire, or death.

**Proper Installation**—Be sure your appliance is properly installed and grounded by a qualified technician. In the United States, install in accordance with the National Fuel Gas Code ANSI Z223.1/NPFA No. 54, latest edition and National Electrical Code NFPA No. 70 latest edition, and local electrical code requirements. In Canada, install in accordance with CAN/CGA B149.1 and CAN/CGA B149.2 and CSA Standard C22.1, Canadian Electrical code, Part 1-latest editions and local electrical code requirements. Install only per installation instructions provided in the literature package for this appliance.

For personal safety, this appliance must be properly grounded. For maximum safety, the power cord must be securely connected to an electrical outlet or junction box that is the correct voltage, is correctly polarized and properly grounded, and protected by a circuit breaker in accordance with local codes.

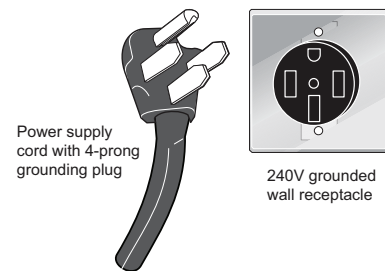

It is the personal responsibility of the consumer to have the appropriate outlet or junction box with the correct, properly grounded wall receptacle installed by a qualified electrician. It is the responsibility and obligation of the consumer to contact a qualified installer to assure that the electrical installation is adequate and is in conformance with all local codes and ordinances.

See the installation instructions packaged with this appliance for complete installation and grounding instructions.

Save these instructions for future use.

## IMPORTANT SAFETY INSTRUCTIONS

### IMPORTANT INSTRUCTIONS FOR USING THE APPLIANCE

#### WARNING

**Storage In or On Appliance**—Flammable materials should not be stored in an oven or microwave, near surface burners or elements, or in the storage or warmer drawer (if equipped). This includes paper, plastic, and cloth items, such as cookbooks, plastic ware, and towels, as well as flammable liquids. Do not store explosives, such as aerosol cans, on or near the appliance.

**Do not leave children alone** - Children should not be left alone or unattended in the area where appliance is in use. They should never be allowed to sit or stand on any part of the appliance, including the storage drawer, lower broiler drawer, warmer drawer, or lower double oven.

Do not store items of interest to children in the cabinets above the appliance or on the backguards of ranges. Children climbing on or near the appliance to reach items could be seriously injured.

Do not allow children to climb or play around the appliance. The weight of a child on an open over door may cause the appliance to tip, resulting in serious burns or other injury. An open drawer when hot may cause burns.

Stepping, leaning, or sitting on the door or drawers of this appliance can result in serious injuries and also cause damage to the appliance.

#### WARNING

Never cover any slots, holes, or passages in the oven bottom or cover an entire oven rack with any materials, such as aluminum foil or after-market oven liners. Doing so blocks air flow through the oven and may result in carbon monoxide poisoning. Aluminum foil and other liners may trap heat, causing a fire hazard.

Do not use oven or warmer drawer (if equipped) for storage.

Never use your appliance as a space heater to heat or warm the room. Doing so may result in carbon monoxide poisoning and overheating of the appliance.

#### CAUTION

When heating fat or grease, watch it closely. Grease may catch fire if it becomes too hot.

Do not use water or flour on grease fires. Smother fire or flame or use dry chemical or foam-type extinguisher. Cover the fire with a pan lid or use baking soda.

Use dry potholders. Moist or damp potholders on hot surfaces may result in burns from steam. Do not let potholders touch hot cooking areas. Do not use towels or other bulky cloths.

Do not heat unopened food containers - Build-up of pressure may cause container to burst and result in injury.

Wear proper apparel - Loose-fitting or hanging garments should never be worn while using the appliance. Do not let clothing or other flammable materials contact hot surfaces.

Save these instructions for future use.

## IMPORTANT SAFETY INSTRUCTIONS

### CAUTION

Do not touch surface burners or elements, areas near these burners or elements, interior surfaces of the oven, or the warmer drawer (if equipped). Surface burners and elements may be hot even though they appear cool. Areas near surface burners and elements may become hot enough to cause burns. During and after use, do not touch, or let clothing or other flammable materials touch these areas until they are cool. These areas may include the cooktop, surfaces facing the cooktop, oven vent areas, oven door, and oven window.

Do not attempt to operate the appliance during a power failure. If the power fails, always turn off the appliance. If the appliance is not turned off and the power resumes, electric surface elements may resume operation when power is restored. Once the power resumes, reset the clock and the oven function.

### IMPORTANT INSTRUCTIONS FOR USING YOUR RADIANT COOKTOP

Know which knob or key controls each surface heating area. Place cookware with food on the cooking area before turning it on. Turn the cooking area off before removing the cookware.

Cookware handles should be turned inward and not extend over adjacent surface elements — To reduce the risk of burns, ignition of flammable materials, and spillage due to unintentional contact with the utensil, the handle of the cookware should be positioned so that it is turned inward, and does not extend over other cooking areas.

Use proper pan size - This appliance is equipped with one or more surface units of different sizes. Select cookware with flat bottoms that match the surface unit size. Using the proper cookware on the cooking area will improve efficiency.

Glazed cooking utensils— Only certain types of glass, glass/ceramic, ceramic, earthenware, or other glazed utensils are suitable for cooktop service without breaking due to the sudden change in temperature. Check the manufacturer's recommendations for cooktop use.

Improper cookware may break due to sudden changes in temperature. Check the cookware manufacturer's recommendations for cooktop use.

Never leave surface elements unattended. Boil-overs may cause smoking and greasy spills that may ignite. A pan that has boiled dry could be damaged and may damage the cooktop.

Do not use a searing grill meant for use with a broiler pan on the cooktop. The searing grill is not designed for use on the cooktop. Doing so may result in a fire.

When you are flaming foods under a ventilating hood, turn on the fan.

Save these instructions for future use.

## IMPORTANT SAFETY INSTRUCTIONS

### IMPORTANT INSTRUCTIONS FOR GLASS AND CERAMIC COOKTOPS

Do Not Clean or Operate a Broken Cooktop. If cooktop should break, cleaning solutions and spillovers may penetrate the broken cooktop and create a risk of electric shock. Contact a qualified technician immediately.

Clean cooktop glass with caution. If a wet sponge or cloth is used to wipe spills on a hot cooking area, be careful to avoid a steam burn. Some cleaners can produce harmful fumes if applied to a hot surface.

Avoid scratching the cooktop glass with sharp objects.

### IMPORTANT INSTRUCTIONS FOR USING YOUR OVEN

Protective liners—Do not use aluminum foil, aftermarket oven liners, or any other materials or devices to line oven bottom, oven racks, or any other part of the appliance. Only use aluminum as recommended for baking, such as lining cookware or as a cover placed on food. Any other use of protective liners or aluminum foil may result in a risk of electric shock or fire or a short circuit.

Use care when opening oven door, lower oven door, or warmer drawer (some models). Stand to the side of the appliance when opening the door of a hot oven. Let hot air or steam escape before you remove or replace food in the oven.

Keep oven vent ducts unobstructed. Touching surfaces in this area when the oven is on may cause severe burns. Do not place plastic or heat-sensitive items on or near the oven vent. These items can melt or ignite.

Placement of oven racks - Always place oven racks in desired location while oven is cool. If rack must be moved while oven is hot, do not let potholder contact hot burner or element in oven. Use potholders and grasp the rack with both hands to reposition. Remove all cookware and utensils before moving the rack.

Do not use a broiler pan without its insert. Broiler pans and inserts allow dripping fat to drain away from the high heat of the broiler. Do not cover the broiler insert with aluminum foil; exposed fat and grease could ignite.

Do not cook food on the oven bottom. Always cook in proper cookware and always use the oven racks.

### IMPORTANT INSTRUCTIONS FOR CLEANING YOUR APPLIANCE

#### CAUTION

Before manually cleaning any part of the appliance, be sure all controls are turned off and the appliance is cool. Cleaning a hot appliance can cause burns.

Clean the appliance regularly to keep all parts free of grease that could catch fire. Do not allow grease to accumulate. Greasy deposits in the fan could catch fire.

Always follow the manufacturer's recommended directions for use of kitchen cleaners and aerosols. Be aware that excess residue from cleaners and aerosols may ignite causing damage and injury.

Clean ventilating hoods frequently - Grease should not be allowed to accumulate on hood or filter. Follow the manufacturer's instructions for cleaning vent hoods.

Save these instructions for future use.

## IMPORTANT SAFETY INSTRUCTIONS

### IMPORTANT INSTRUCTIONS FOR SERVICE AND MAINTENANCE

Do not repair or replace any part of the appliance unless specifically recommended in the manuals. All other servicing should be done only by a qualified technician. This reduces the risk of personal injury and damage to the appliance.

Always contact your dealer, distributor, service agent, or manufacturer about problems or conditions you do not understand.

Ask your dealer to recommend a qualified technician and an authorized repair service. Know how to disconnect the power to the appliance at the circuit breaker or fuse box in case of an emergency.

Remove the oven door from any unused oven if it is to be stored or discarded.

Do not touch a hot oven light bulb with a damp cloth. Doing so could cause the bulb to break. Handle halogen lights (if equipped) with paper towels or soft gloves. Disconnect the appliance or shut off the power to the appliance before removing and replacing the bulb.

#### **WARNING**

California Residents: for cancer and reproductive harm information, visit [www.P65Warnings.ca.gov](http://www.P65Warnings.ca.gov)



Save these instructions for future use.



## COOKING RECOMMENDATIONS

### Bakeware

The material of bakeware affects how evenly and quickly it transfers heat from the pan to the food.

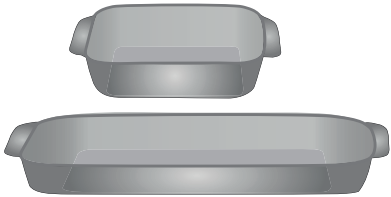
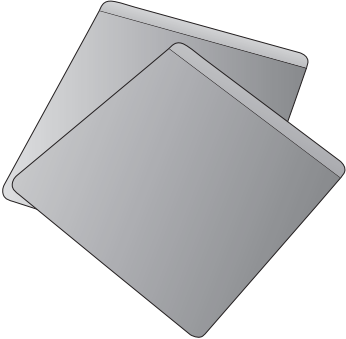
Material	Attributes	Recommendation
<p>Shiny metal bakeware</p> 	<p>Shiny, aluminum, and non-coated bakeware is the best for even heating. It is suitable for all baked goods.</p>	<p>Recommended cooking temperatures and times are based on shiny metal bakeware.</p>
<p>Dark metal bakeware</p> 	<p>Dark bakeware cooks hotter than shiny bakeware.</p>	<p>Reduce the cooking temperature by 25° F (13-14° C) when using dark bakeware.</p>
<p>Glass bakeware</p> 	<p>Glass bakeware cooks hotter than shiny bakeware.</p> <p>Glass is convenient, as the same piece of bakeware can be used for cooking, serving, and storing food.</p>	<p>Reduce the cooking temperature by 25° F (13-14° C) when using glass bakeware.</p>
<p>Insulated bakeware</p> 	<p>Insulated bakeware cooks cooler than shiny bakeware.</p> <p>Insulated bakeware is designed for baking in gas ovens.</p>	<p>Increase the cooking temperature by 25° F (13-14° C) when using insulated bakeware.</p>

## COOKING RECOMMENDATIONS

**Cooking Conditions** Conditions in your kitchen can affect the performance of your appliance when cooking food.

Condition	Attributes	Recommendation
Aging cookware	As pans age and become discolored, cooking times may need to be reduced slightly.	If food is too dark or overcooked, use the minimum cook time in the recipe or packaging. If food is too light or undercooked, use the middle to maximum cook time in the recipe or packaging.
High altitude	Air is drier and air pressure is lower.  Water boils at a lower temperature, and liquids evaporate faster.  Foods may take longer to bake.  Doughs may rise faster.	Adjust cooking temperature, cooking time, or recipes as needed.  Increase amount of liquid in baking recipes. Increase cook time on cooktop. Cover dishes to reduce evaporation.  Increase bake time or oven temperature.  Reduce amount of baking soda or baking powder in recipe. Reduce rising time or punch down dough and allow it to rise twice.

**Cooking Results:** Small adjustments may fix a problem with food not being as done as you like or overdone.

Result	Recommendation
Food too light	Use the middle to maximum cook time recommended on packaging or recipe.
Food too dark	Use the minimum cook time recommended on packaging or recipe.

**Cooking Tips:** Use these additional tips to get the best results from your appliance.

Cooking	Tips
<b>Baking</b>	
Rack placement	Follow the instructions in <a href="#">“Oven Control Features”</a> on starting on <a href="#">page 18</a> . When using only one rack, place the rack so the food is in the center of the oven.
Preheat	Fully preheat the oven before baking items like cookies, cakes, biscuits and breads. Insert food immediately after the beep.
Checking food	Use the window and oven light when checking food. Opening the door may reduce baking performance.
Bake	Bake is the best function to use for baking on multiple racks.
Food placement	Allow at least 2 inches (5 cm) of space between bakeware for proper air circulation.
<b>Broiling / Roasting</b>	
Broiling pan	For best results when broiling, use a broil pan with a broil pan insert designed to drain the fat from the food, help avoid spatter, and reduce smoking. The broiler pan will catch grease spills, and the insert helps prevent grease splatters.  If a broiler pan and insert are not supplied with this appliance, they may be purchased from <a href="http://www.frigidaire.com">www.frigidaire.com</a> .

## BEFORE SETTING SURFACE CONTROLS

### Using Proper Cookware

The size and type of cookware used will influence the heat setting needed for best cooking results. Be sure to follow the recommendations for using proper cookware as illustrated in Figure 1 and Figure 2.

Check for flatness by rotating a ruler across the bottom of the cookware (see Figure 1). Cookware should have flat bottoms that make good contact with the entire surface heating element (see Figure 2).

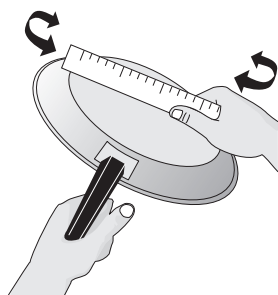

Figure 1: Testing cookware

### Cookware Material Types

The cookware material determines how evenly and quickly heat is transferred from the surface element to the pan bottom. The most popular materials available are:

- **Aluminum** - Excellent heat conductor. Some types of food will cause it to darken (Anodized aluminum cookware resists staining and pitting). If aluminum pans slide across the ceramic cooktop, they may leave metal marks which will resemble scratches. Remove these marks immediately.
- **Copper** - Excellent heat conductor but discolors easily (see Aluminum).
- **Stainless** - Slow heat conductor with uneven cooking results. Is durable, easy to clean and resists staining.
- **Cast Iron** - A slow heat conductor that will retain heat very well. Cooks evenly once cooking temperature is reached. If cast iron pans slide across the ceramic cooktop, they may leave metal marks which will resemble scratches. Remove these marks immediately.
- **Porcelain-enamel on metal** - Heating characteristics will vary depending on base material. Porcelain-enamel coating must be smooth to avoid scratching ceramic cooktops.
- **Glass** - Slow heat conductor. Not recommended for ceramic cooktop surfaces because it may scratch the glass.

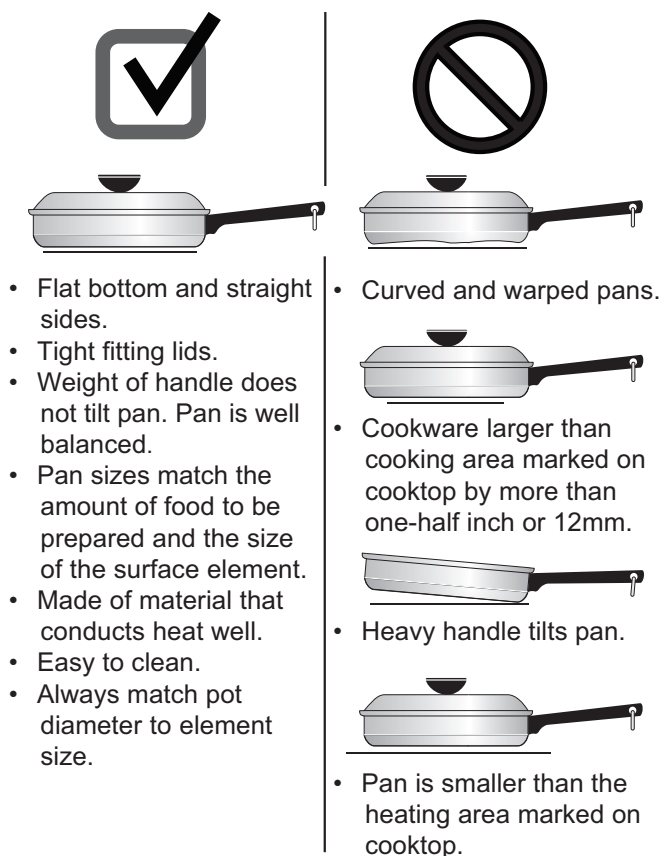

Figure 2: Proper cookware

### IMPORTANT

Do not place empty aluminum, glass, or porcelain-enamel coated cookware on the ceramic cooktop. The melting point of cookware made with these materials may be reached quickly, especially if left empty, and they may bond to the ceramic cooktop. If the cookware melts it will damage the cooktop. Follow all the cookware manufacturer's recommendations for use and care of cookware.

## BEFORE SETTING SURFACE CONTROLS

### About the Ceramic Glass Cooktop

The ceramic glass cooktop has heating elements below a smooth glass surface. The designs on the ceramic cooktop outline the areas of the surface elements underneath. Always match the pan size with the diameter of the element outline on the cooktop. Only flat-bottomed cookware should be used.

Prior to using your cooktop for the first time, apply a ceramic cooktop cleaning cream (available in most hardware, grocery and department stores) to the ceramic surface. Clean and buff with a clean paper towel. This will make cleaning easier when soiled from cooking. Cooktop cleaning creams leave a protective finish on the glass to help prevent scratches and abrasions.

The type and size of cookware, the number of surface elements in use, and their settings will all affect the amount of heat that will spread to areas beyond the surface elements. **The areas surrounding the elements may become hot enough to cause burns.**

### ➔ IMPORTANT

- The cooktop should not be used as a cutting board or work surface.
- Dropping heavy or hard objects on the cooktop may crack it.
- Placing food directly on the smoothtop surface (without a cooking utensil) is not recommended, as difficult cleaning will result, and foods may smoke and cause potential fire hazard.
- Always lift cookware before moving on the ceramic glass cooktop. Any cookware that has a rough or dirty bottom can scratch the ceramic cooktop. Always start with clean cookware.

### 📌 NOTE

White glass cooktops only - Due to the high intensity of heat generated by the surface elements, the glass surface may discolor when the element is turned off. This is normal and the glass will return to its original white color after it has completely cooled down.

### About the Radiant Surface Elements

The element temperature rises gradually and evenly. As the temperature rises, the element will glow red. To maintain the selected setting the element will cycle on and off. The heating element retains enough heat to provide a uniform and consistent heat during the off cycle.

For efficient cooking, turn the element off several minutes before cooking is complete. This will allow residual heat to complete the cooking process.

### ⚠ CAUTION

- Surface elements may appear to have cooled after they have been turned off. **The element surface may still be hot**, and burns may occur if the element or surrounding area is touched before it has cooled to a safe temperature.
- **Do not** place flammable items such as plastic salt and pepper shakers, spoon holders, or plastic wrapping on top of the range when it is in use. These items could melt or ignite. Potholders, towels, or wooden spoons could catch fire if placed too close to the surface elements.
- **Do not** allow aluminum foil, or any material that can melt, to make contact with the ceramic glass cooktop. If these items melt on the cooktop, they will damage the ceramic cooktop.

### 📌 NOTE

Radiant elements have a limiter that allows the element to cycle on and off, even at the HI setting. This helps to prevent damage to the ceramic smooth top. Cycling at the HI setting is normal and can occur if the cookware is too small for the radiant element or if the cookware bottom is not flat.

Be sure to read detailed instructions for ceramic glass cooktop cleaning in the **“Care and Cleaning”** section and **“Before You Call”** checklist section of this *Use and Care Guide*.

## BEFORE SETTING SURFACE CONTROLS

### Element On and Hot Surface Indicator Lights

The **ELEMENT ON** indicator light will turn on when one or more elements are turned on.

Element On 

Hot Surface 

#### Figure 3: Indicator light

A quick glance at this indicator light when cooking is finished is an easy check to be sure all surface elements are turned off.

The **HOT SURFACE** indicator light will turn on when the burner is hot enough to cause burns and will remain on after the burner is turned off until the surface has cooled to a safe temperature.

### Types of ceramic cooktop elements

The circles on the ceramic glass cooktop outline the size and type of element underneath. The elements on your cooktop depend on the model.

- A single radiant element has one circle.
- A dual radiant element has two circles. The dual radiant element may be set using only the smaller inner element or both inner and outer elements may be set to heat together for a larger surface.
- Dual elements allow more flexibility with the size of cookware.

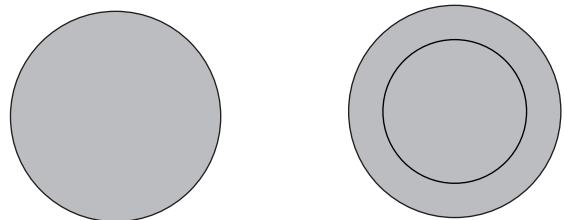

Figure 4: Single and double elements

## SETTING SURFACE CONTROLS

### Single radiant surface elements

To operate the single radiant element:

1. Place correctly sized cookware on surface element.
2. Push in and turn the surface control knob in either direction (Figure 5) to the desired setting (refer to the “Suggested radiant surface element settings” in Table 1).
3. When cooking is complete, turn the radiant surface element OFF before removing the cookware.

Start most cooking operations on a higher setting and then turn to a lower setting to finish cooking. The surface control knobs do not have to be set exactly on a particular spot. Use the graphics provided as a guide and adjust the control knob as needed (see Figure 5).

A glowing red surface heating area extending beyond the bottom edge of the cookware indicates the cookware is too small for the surface heating area.

### Suggested radiant surface element settings

The suggested settings found in Table 1 below are based on cooking with medium-weight aluminum pans with lids. Settings may vary when using other types of pans.

Settings	Type of Cooktop
High (HI - 8)	Start most foods, bring water to a boil, pan broiling
Medium High (6- 8)	Continue a rapid boil, fry, deep fat fry
Medium (5 - 6)	Maintain a slow boil, thicken sauces and gravies or steam vegetables
Medium Low (2 - 4)	Keep foods cooking, poach, stew
Low (LO)	Keep warm, melt

Table 1: Suggested radiant surface element settings

### → IMPORTANT

Do not allow aluminum foil or ANY material that can melt to make contact with the ceramic glass cooktop. If these items melt on the cooktop, they will damage the ceramic cooktop.

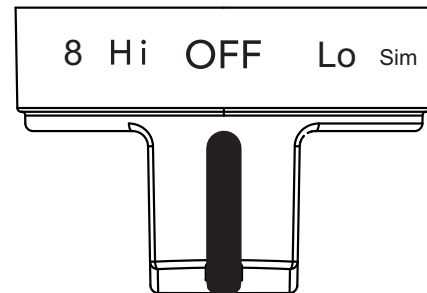

Figure 5: Single element knob

### ⚠ CAUTION

- Radiant surface elements may appear to have cooled after they have been turned off. **The glass surface may still be hot** and burns may occur if the glass surface is touched before it has cooled sufficiently.
- **Do not** place flammable items such as plastic salt and pepper shakers, spoon holders, or plastic wrappings on top of the range when it is in use. These items could melt or ignite. Potholders, towels, or wooden spoons could catch fire if placed too close to the surface elements.

### ↓ NOTE

- The size and type of utensil used, and the amount and type of food being cooked will influence the setting needed for best cooking results.
- The Element ON indicator lights will turn on when one or more elements are turned ON. A quick glance at these indicator lights when finished cooking is an easy check to be sure all control knobs are turned OFF. The Hot Surface indicator light will remain on AFTER the control knob is turned to the “OFF” position and will stay on until the heating surface area has cooled sufficiently.

## SETTING SURFACE CONTROLS

### Dual radiant surface elements

Symbols on the backguard will help choose which portion of the dual radiant element to set. The ○ symbol indicates a setting for the inner element only. The ⊙ symbol indicates a setting for both inner and outer elements.

#### To operate a dual radiant element:

1. Place correctly sized cookware on the surface element.
2. Push in and turn the surface control knob clockwise to begin heating both the inner and outer elements. If only the inner element is needed for smaller cookware, push in and turn the knob counter-clockwise (see Figure 6).
3. When cooking is complete, turn the knob to OFF before removing the cookware.

Start most cooking operations on a higher setting and then turn to a lower setting to finish cooking. The surface control knobs do not have to be set exactly on a particular mark. Use the marks as a guide and adjust the control knob as needed.

A glowing red surface heating area extending beyond the bottom edge of the cookware indicates the cookware is too small for the surface heating area.

You may switch from either single or dual element setting at any time during cooking. See “Suggested radiant surface element settings” on page 14.

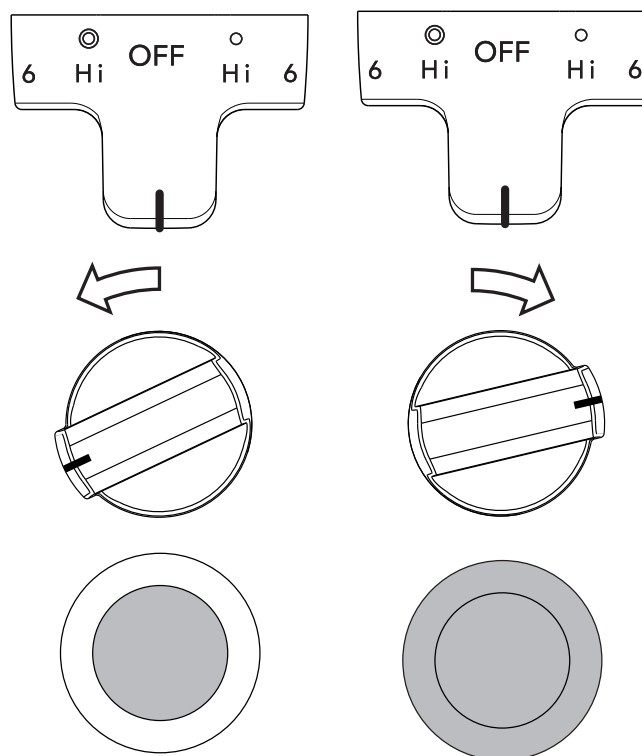

Figure 6: Single/Dual element knob settings

### CAUTION

- Radiant surface elements may appear to have cooled after they have been turned off. **The glass surface may still be hot** and burns may occur if the glass surface is touched before it has cooled sufficiently.
- **Do not** place flammable items such as plastic salt and pepper shakers, spoon holders or plastic wrappings on top of the range when it is in use. These items could melt or ignite. Potholders, towels or wooden spoons could catch fire if placed too close to the surface elements.

### NOTE

- The size and type of utensil used and the amount and type of food being cooked will influence the setting needed for best cooking results.
- The Element ON indicator lights will turn on when one or more elements are turned ON. A quick glance at these indicator lights when finished cooking is an easy check to be sure all control knobs are turned OFF. The Hot Surface indicator light will remain on AFTER the control knob is turned to the “OFF” position and will stay on until the heating surface area has cooled sufficiently.

## SETTING SURFACE CONTROLS

### Home Canning

Be sure to read and observe all the following points when home canning with your appliance. Check with the USDA (United States Department of Agriculture) Web site and be sure to read all the information they have available as well as follow their recommendations for home canning procedures.

- Use only a completely flat bottom canner with no ridges that radiate from the bottom center when home canning. Heat is spread more evenly when the bottom surface is flat. Use a straight-edge to check canner bottom.
- Make sure the diameter of the canner does not exceed 1 inch beyond the surface element markings or burner.
- It is recommended to use smaller diameter canners on electric coil and ceramic glass cooktops and to center canners on the burner grates.
- Start with hot tap water to bring water to boil more quickly.
- Use the highest heat setting when first bringing the water to a boil. Once boiling is achieved, reduce heat to lowest possible setting to maintain that boil.
- Use tested recipes and follow instructions carefully. Check with your local Cooperative Agricultural Extension Service or a manufacturer of glass jars for the latest canning information.
- It is best to can small amounts and light loads.
- Do not leave water bath or pressure canners on high heat for an extended amount of time.



## BEFORE SETTING OVEN CONTROLS

### Oven Vent Location

The oven is vented as shown below. When the oven is on, warm air is released through the vent. This venting is necessary for proper air circulation in the oven and good baking results. Do not block oven vent. Never close off the openings with aluminium foil or any other material. Steam or moisture may appear near the oven vent. This is normal.

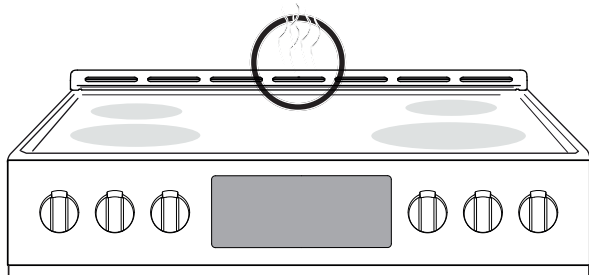

Figure 7: Oven vent

### **!** WARNING

Protective Liners — **Do not** use aluminum foil or any other material or liners to line the oven bottom, walls, racks or any other part of the range. Doing so will alter the heat distribution, produce poor baking results, and possibly cause permanent damage to the oven interior. Improper installation of these liners may result in risk of electric shock or fire.

### **!** CAUTION

- Always use pot holders or oven mitts when using the oven. When cooking, the oven interior, oven exterior, oven racks, and cooktop will become very hot which can cause burns.
- To prevent possible damage to the oven, do not attempt to close the oven door until all the oven racks are fully positioned back inside the oven cavity.

### Type of oven racks

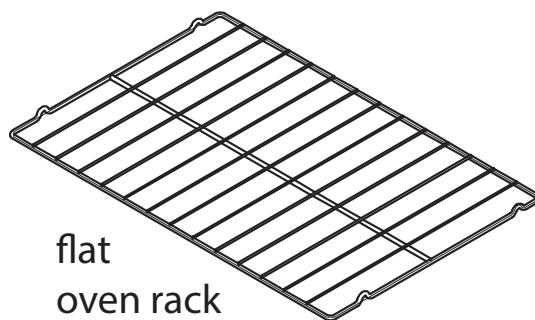

Figure 8: Oven rack types

- **Flat oven racks** are used for most cooking needs and may be placed in most oven rack positions.

### Removing, replacing, and arranging oven racks

Always arrange the oven racks when the oven is cool.

**To remove** - Pull the oven rack straight forward until it reaches the stop position. Lift up front of oven rack slightly and slide out.

**To replace** - Place the oven rack on the rack guides on both sides of oven walls. Tilt the front of oven rack upward slightly and slide the oven rack back into place. Be sure oven racks are level before using.

# SETTING OVEN CONTROLS

## Oven Control Features

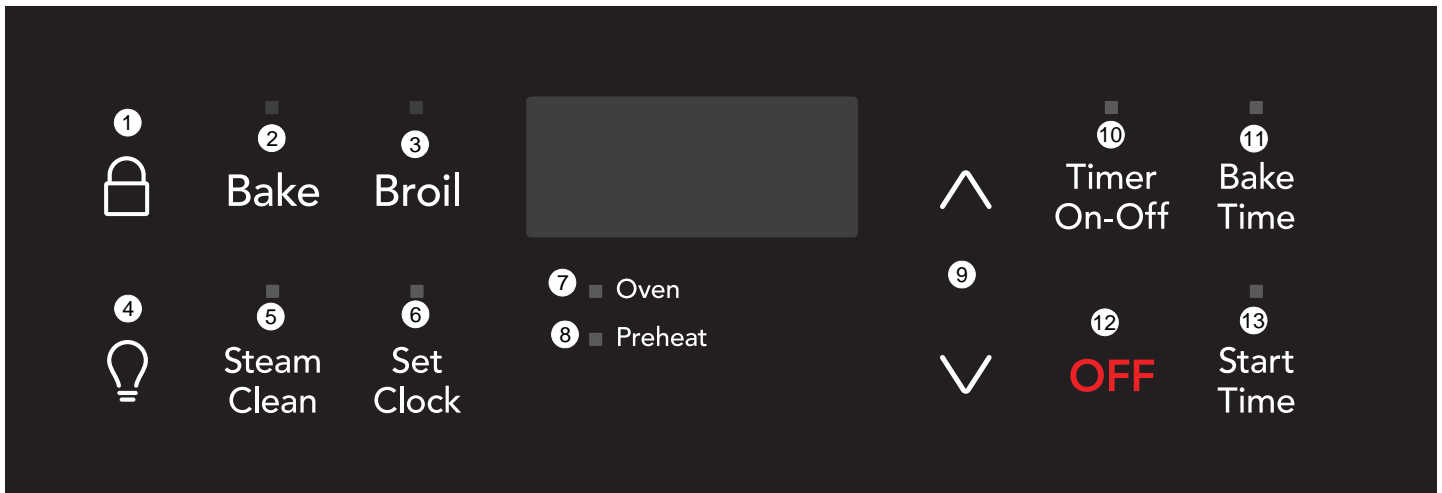

1. **Control Lock** - Use to lock oven controls.
2. **Bake** - Use to select bake feature.
3. **Broil** - Use to set Broil feature.
4. **Oven Light** - Use to turn on oven light when checking on food. Turns on when the oven door is open.
5. **Steam Clean** - Use with arrow keys to set steam clean cycle for cleaning light soils in oven cavity.
6. **Set Clock** - Use with arrow keys to set the time of day.
7. **Oven on indicator light** - Glows each time the oven turns on to maintain the set oven temperature.
8. **Preheat light** - The preheat light will glow when the oven is preheating.
9. **Up and Down arrows** - Use with the control keys to set oven temperature, bake time, start time, clean time, and setting or adjusting the clock and minute timer.
10. **Timer on-off** - Use to set or cancel the minute timer.
11. **Bake Time** - Enters the length of baking time desired.
12. **OFF** - Use to clear any feature except the time of day and minute timer.
13. **Start Time** - Used with Bake to set a delayed starting time.

Feature	Mode	Min Temp/Time	Max Temp/Time
Bake		170°F (77°C)	550°F (287°C)
Broil		LO 400°F (205°C)	HI 550°F (287°C)
Timer	12 Hr.	0:01 Min.	11:59 Hr./Min.
Clock Time	12 Hr.	1:00 Hr./Min.	12:59 Hr./Min.
Bake Time	12 Hr.	0:01 Min	5:59 Hr./Min.
Steam Clean		30 mins	



**Note:** An entry acceptance tone (1beep) will sound each time a key is touched (the oven lock key is delayed 3 seconds). An entry error tone (3 short beeps) will sound if the entry of the temperature or time is below the minimum or above the maximum settings for the feature.

## SETTING OVEN CONTROLS

### Setting the Clock

When the appliance is first plugged in or when the power supply to the appliance has been interrupted, the display will flash **12:00**. It is recommended to always set the clock for the correct time of day before using the appliance.



#### To set the clock:

1. Press **Set Clock** once (do not hold clock key down).
2. Within 5 seconds, press and hold  or  until the correct time of day appears in the display.

### Temperature display (Fahrenheit/Celsius)

The electronic oven control is set to operate in Fahrenheit (°F) at the factory. The oven may be programmed for any temperature from 170°F to 550°F (77°C to 287°C).

#### To change the temperature to Celsius (°C) or from °C to °F:

1. Press **Broil**. — — appears in the display.
2. Press and hold  until **HI** appears in the display.
3. Press and hold **Broil** until °F or °C appears in the display.
4. Press  or  to change °F to °C or °C to °F. To accept the change, wait 6 seconds.

### Setting Oven Lock

The control can be programmed to lockout the oven control keys.

#### To activate the oven lockout features:

1. Press and hold the lock key for 3 seconds. Once the controls are locked the with a lock icon will appear in the display.

#### To cancel the oven lockout feature:

1. Press and hold the lock key for 3 seconds.
1. When the lock icon no longer displays, the oven control keypad will be available for use.

**Important:** If a control key is pressed when oven lockout is active, the control will triple beep indicating the key action is not available when the oven lockout feature is active.

### Changing between continuous bake setting or 12-hour energy saving feature

The oven control has a built-in 12-hour energy saving feature that will shut off the oven if the oven is left on for more than 12 hours. The oven control can be programmed to override this feature for continuous baking.

#### To change the continuous bake setting:

1. Press and hold **Timer on-off** for 6 seconds until a tone sounds. — — **hr** will appear in the display for continuous cooking. The current time of day will return to the display.
2. To cancel the continuous bake setting, press **Timer on-off** and hold for 6 seconds until a tone sounds. **12 hr** will appear in display indicating that the control has returned to the 12-hour energy saving feature.

### IMPORTANT

Changing to continuous bake or 12 hour mode does not change how the cooktop controls operate.

### Setting a silent control panel

When selecting a function, an audible tone is heard each time a key is pressed. If desired, the control can be programmed for silent operation.

#### To set the controls for silent operation:



1. Press and hold **Start Time** for 6 seconds. The control will beep once and release the key.
2. The controls are now set for silent operation.

#### To return to non-silent operation:

1. Press and hold **Start Time** again for 6 seconds until the control beeps once and release the key.
2. The control is now set for audible operation.

## SETTING OVEN CONTROLS



### Setting the minute timer

1. Press **Timer on-off**.
2. Press  to increase time in one-minute increments. Press and hold  to increase time in 10-minute increments. The timer can be set for any amount of time from 1 minute to 11 hours and 59 minutes.
3. When the desired time appears in the display, release the . The timer will begin to countdown in about 5 seconds.
4. To turn the timer off at any time Press **Timer on-off**.
5. When the set time ends, the timer will beep three times and will continue to beep three times every minute until **Timer on-off** is pressed.

### NOTE

The minute timer will not start or stop the cooking process. The minute timer can be used alone or while using any of the other oven features. If another feature is active when the minute timer is active, the minute timer will show in the display. To view information about other active features, press the key for that feature.

### To change the timer while it is in use:

While the timer is active and shows in the display, press and hold  or  to increase or decrease the time remaining.

### To cancel the minute timer before the set time has run out:

- Press **Timer on-off** once.

### Operating oven light



The interior oven light will automatically turn on when the oven door is opened. Press the oven light key  located on the control panel to turn the interior oven light on and off whenever the oven door is closed. For best baking results, do not leave oven light on while baking.

The interior oven light is located at the upper left rear wall of the oven interior. To change the interior oven light, see "Changing the oven light" in the **Care & cleaning** section.

## SETTING OVEN CONTROLS

### Setting Bake



The oven can be programmed to bake at any temperature from 170°F to 550°F (77°C to 287°C). The factory preset automatic bake temperature is 350°F (177°C).

The oven indicator light will turn on when first set to bake while the oven is heating. When the set temperature is reached the oven control will beep once indicating the oven is fully preheated and time to place food in the oven. The indicator light will cycle on and off as the oven maintains the set temperature.



### For best bake results:

- Fully preheat the oven before baking.
- When baking items like cookies, cakes, biscuits, and breads using a single rack place rack in position 4.
- When using any single rack for items like frozen pies, angel food cake, breads, and casseroles, use rack position 4.
- For best results when baking cakes using two oven racks, place racks in positions 3 and 5 (See [Figure 9](#)).
- When baking cakes using two oven racks, position cookware as shown in [Figure 9](#). Allow at least 2 inches (5 cm) of space between cookware for proper air circulation.
- Leave oven light off while baking.
- Dark or dull bakeware absorbs more heat than shiny bakeware, resulting in dark or overbrowned foods. It may be necessary to reduce oven temperature or cook time to prevent overbrowning of some foods.
- Dark pans are recommended for pies; shiny pans are recommended for cakes, cookies, and muffins.
- Do not open oven door often. Opening the door will reduce the temperature in the oven and may increase cook time.

### To set Bake:

1. Press **Bake**. — — — appears in the display.
2. Within 5 seconds, press  or . The display will show **350°F** (177°C). The temperature can then be adjusted in 5°F (1°C) increments.
3. When a key is released, the oven will begin heating to the selected temperature. When the oven reaches the set temperature, the preheat indicator light will turn off and the control will beep three times.
4. To cancel the baking function, press **OFF**.

### To change oven temperature after bake has started:

1. Press **Bake**.
2. Press  or  to increase or decrease to a new temperature. The oven indicator light on the electronic display will turn on and off when using the bake feature and during preheat. This is normal and indicates that the oven is cycling to maintain the selected baking temperature. To cancel baking press **OFF**.

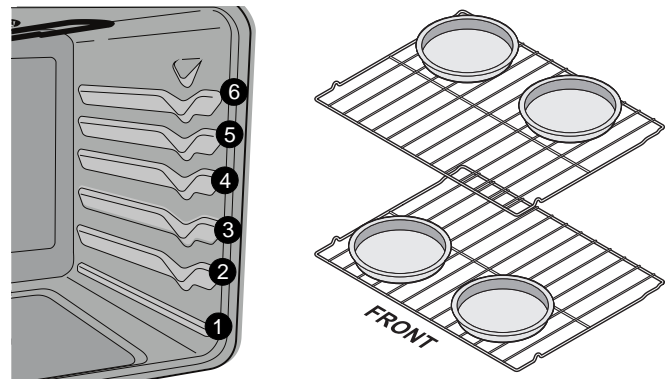





**Figure 9:** Rack positions; Pan positions two rack baking

## SETTING OVEN CONTROLS

### Setting Bake Time

The **Bake Time** key sets the amount of time needed for baking. The oven will turn on immediately and stop automatically after the set bake time ends.

**To program the oven to begin baking immediately and to shut off automatically (timed bake):**

1. Be sure the clock is set to the correct time of day.
2. Place the food in the oven.
3. Press **Bake**. — — — ° appears in the display.
4. Within 5 seconds, press  or . The display will show **350°F (177°C)**. The temperature can then be adjusted in 5°F (1°C) increments,
5. Press **Bake Time.0:00** will appear in the display.
6. Press  or  until the desired baking time appears in the display.
7. The oven will turn on and begin heating.

**When the set bake time runs out:**

1. **End** will appear in the display, and the oven will shut off automatically.
2. The control will beep three times every 60 seconds as a reminder until **OFF** is pressed.

### NOTE

Bake Time will not operate when using the broil feature. Once the controls are set, the oven will come on and begin heating to the selected baking temperature. The oven temperature (or time of day) will show in the display.







### Setting Start Time (delayed start)

Use the **Start Time** key to delay the starting time (delayed timed bake). The oven will turn on at a later time and stop automatically after the set bake time ends.

**To program oven for a delayed start time and to shut-off automatically:**

### CAUTION

Food Poisoning Hazard. Do not let food sit for more than one hour before or after cooking. Doing so can result in food poisoning or sickness.

1. Be sure that the clock displays the correct time of day.
2. Place food in the oven.
3. Press **Bake**. — — — ° appears in the display. Within 5 seconds, press  or . The display will show **350°F (177°C)**. The temperature can then be adjusted in 5°F (1°C) increments.
4. Press **Bake Time. 0:00** will appear in the display.
5. Press  or  until desired baking time appears.
6. Press **Start Time**. The time of day will appear in the display.
7. Press  or  until the desired start time appears in the display.
8. Once the controls are set, the control calculates the time when baking will stop. The oven will turn on at the delayed start time and begin heating.

**To change the oven temperature (or bake time) after baking has started:**

1. Press the function you want to change.
2. Press  or  to adjust the setting.

### NOTE

During a delayed timed bake, the preheat indicator light will not function until the set time to start cooking is reached.

## SETTING OVEN CONTROLS

### Setting Broil

Broiling is direct heat cooking and will produce some smoke. If smoke is excessive, place food further away from the element. Watch food to prevent burning. Broil with oven door closed.

When broiling, always remember to arrange the oven racks while oven is still cool. Position the rack as suggested in [Table 2](#).

#### WARNING

Should an oven fire occur, close the oven door and turn the oven off. If the fire continues, use a fire extinguisher. Do not put water or flour on the fire. Flour may be explosive.

#### CAUTION

Always use oven mitts. Oven racks will become very hot which can cause burns.

#### NOTE



Always pull the oven rack out to the stop position before turning or removing food.

The broiler pan and the insert (some models) allow grease to drain and be kept away from the high heat of the broiler. Do not use the pan without the insert. Do not cover the insert with aluminum foil; the exposed grease could ignite.

#### IMPORTANT

If the oven door is left open during broil the high temperatures can trigger a door open alarm. The control will beep and (dO) will appear in the display. If the oven door is not closed within 30 seconds, the broil element will turn off. If this occurs, close the oven door and check if broil function resumes. If not, reset the function and broil with oven door closed.

### To set Broil

1. Arrange the oven rack while oven is still cool.
2. Press **Broil**. — — will appear in display.
3. Press  for **HI** broil or  for **LO** broil. Most foods may be broiled at the HI broil setting. Select the LO broil setting to avoid excess browning or drying of foods that should be cooked to the well-done stage.
4. For optimum results, preheat broil for 2 minutes before adding food.
5. Place the insert on the broil pan (if equipped), then place the food on the broil pan insert (if using a broiler pan and insert).
6. Place the broiler pan and insert on the oven rack. Broil with the oven door closed.
7. Broil on one side until food is browned. Turn and broil food on other side.
8. When broiling is finished press **OFF**.

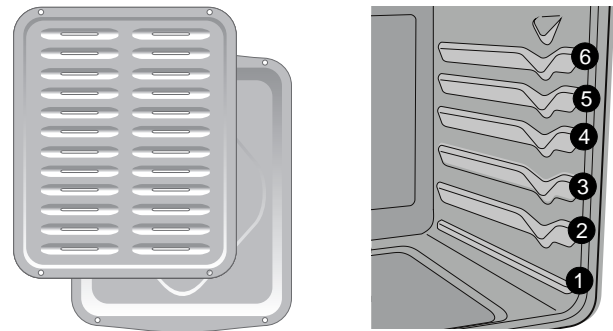

Figure 10: Broil pan and insert; Rack positions

#### NOTE

If a broiling pan and insert are not included with this appliance, go to [www.frigidaire.com](http://www.frigidaire.com)

## SETTING OVEN CONTROLS

**Table 2: Broil recommendations**

Food item	Rack Position	Temp	Cook time in minutes		Internal Temperature	Doneness
			1st side	2nd side		
Steak 1" thick	6	HI(550°F)	5:00	4:00	135°F (57°C)	Rare**
Steak 1" thick	5 or 6	HI(550°F)	7:00	5:00	145°F (63°C)	Medium
Steak 1" thick	5 or 6	HI(550°F)	8:00	7:00	170°F (77°C)	Well
Pork Chops 3/4 "thick	5	HI(550°F)	8:00	6:00	170°F (77°C)	Well
Chicken - Bone In	4	LO(400°F)	20:00	10:00	170°F (77°C)	Well
Chicken Boneless	5	LO(400°F)	8:00	6:00	170°F (77°C)	Well
Fish	5	HI(550°F)	13:00	--	170°F (77°C)	Well
Shrimp	4	HI(550°F)	5:00	--	170°F (77°C)	Well
Hamburger 1" thick	6	HI(550°F)	5:00	4:00	135°F (57°C)	Rare**
Hamburger 1" thick	6	HI(550°F)	7:00	5:00	145°F (63°C)	Medium
Hamburger 1" thick	5	HI(550°F)	8:00	7:00	170°F (77°C)	Well

The U.S. Department of Agriculture states, "\*\*Rare fresh beef is popular, but you should know that cooking it to only 140°F (60°C) means some food poisoning organisms may survive." (Source: Safe Food Book, Your Kitchen Guide, USDA Rev. June 1985.) The lowest temperature recommended by the USDA is 145°F (63°C) for medium rare fresh beef. For well done 170°F (77°C). All cook times shown are after 2 minutes of preheating.



## SETTING OVEN CONTROLS

### Steam Clean

The Steam Clean feature offers a chemical free and time saving method to assist in the routine cleaning of small and light soils.

#### **CAUTION**

Do not add bleach, ammonia, oven cleaner, or any other abrasive household cleaners to the water used for Steam Clean. Before cleaning any part of the oven, be sure all controls are turned off and the oven is cool. The oven may be hot and can cause burns.



Be sure the oven is level and cool before starting Steam Clean. If the oven temperature is above room temperature a triple beep will be heard and the function will not start. Steam Clean produces best results when started with a cool oven.

#### To set a Steam Clean cycle:

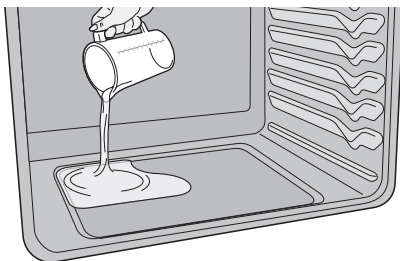
1. Remove all racks and oven accessories.
2. Scrape or wipe loose debris and grease from the oven bottom.
3. Pour 1 cup of tap water onto the oven bottom. (Figure 11) Close oven door.



**Figure 11:** Add 1 cup of tap water

4. Press **Steam Clean**.
5. Press  or  **St Cn** will appear in the display and will start automatically in a few seconds and count down from 30 minutes.
6. Do not open the door during this time. If door is open while in Steam Clean (d-O) will appear in the display.
7. When the steam clean cycle is complete an alert will sound and the END message will show in the display. Press OFF to return to the clock.
8. Take care opening the door when the steam clean is finished. Stand to the side of the oven out of the way of escaping vapor.

9. Wipe oven cavity and bottom. Do not clean oven door gasket (Figure 12). Avoid leaning or resting on the oven door glass while cleaning cavity.
10. To cancel Steam Clean at any time press **OFF**.

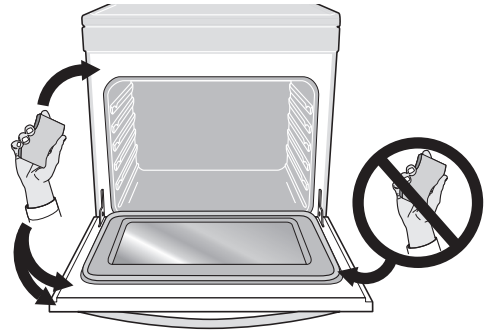

**Figure 12:** Clean around the oven door gasket

**Important:** Opening oven door during Steam Clean cycle prevents the water from reaching the temperature needed to clean. If the door is left open once Steam Clean starts, an alarm will sound alerting you to close the door.

- For best results, clean oven immediately after the cycle is complete. Steam clean works best for soils on the oven bottom.
- Place a paper towel or cloth in front of the oven to capture any water that may spill while wiping out.
- A non abrasive scouring pad, stainless steel sponge, plastic scraper, or eraser style cleaning pad (without cleaner) can be used for difficult soils. Moisten pads with water before use.
- Do not leave the residual water in the oven for any length of time.
- Some condensation or water vapor may appear close to the oven vent. This is normal. The oven gasket may become damp; do not wipe dry.
- Local water sources often contain minerals (hard water). If hard water deposits occur, wipe cavity with a 50/50 solution of water and vinegar or 50/50 solution of lemon juice and water.
- Steam clean cannot be programmed with a delay start.

## SETTING OVEN CONTROLS

### Adjusting the oven temperature

Your appliance has been factory calibrated and tested to ensure an accurate baking temperature. For the first few uses, follow your recipe times and temperature recommendations carefully. If you think the oven is cooking too hot or too cool for your recipe times, you can adjust the control so the oven cooks hotter or cooler than the temperature displayed.



#### NOTE

Do not use oven thermometers such as those found in grocery stores to check the temperature settings inside your oven. These oven thermometers may vary as much as 20 to 40 degrees from actual temperatures.

Oven temperature adjustments do not change the <Broil> function.

If the screen is set to degrees Celsius, adjustments are made in increments of 1 ° C each time the arrow keys are pressed.

### To adjust oven temperature:

1. Press **Bake**.
2. Set the temperature to 550°F (287°C) by pressing and holding .
3. Within 3 seconds, press and hold **Bake** until numeric digit(s) appear. Release **Bake** key. The display now indicates the amount of degrees offset between the original factory temperature setting and the current temperature setting. If the oven control has the original factory calibration, the display will read **00**.
4. The temperature can now be adjusted up or down 35°F (19°C), in 5°F (1°C) increments. Press and hold  to adjust the temperature higher until the desired amount of offset appears in the display. When lowering the oven temperature using , a minus sign (-) will appear before the number to indicate that the oven will be cooler by the displayed amount of degrees.
5. When you have made the desired adjustment, press **OFF** to go back to the time of day display.

## CARE AND CLEANING

Remove spills and any heavy soiling as soon as possible. Regular cleaning will reduce the difficulty of major cleaning later.

### CAUTION

- Before cleaning any part of the appliance, be sure all controls are turned off and the appliance is cool.
- If ammonia or appliance cleaners are used, they must be removed and the appliance must be thoroughly rinsed before operating. Follow manufacturer's instructions and provide adequate ventilation.

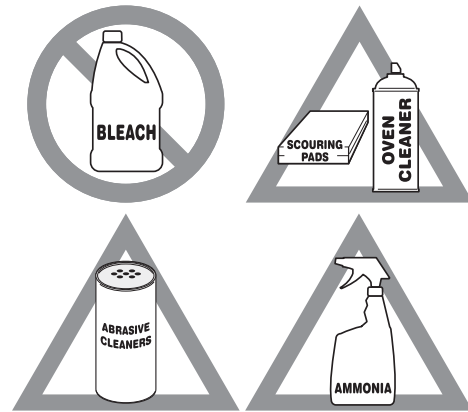

Figure 13: Use cleaners with caution

Surface or Area	Cleaning Recommendation
Aluminum and vinyl	Using a soft cloth, clean with mild dish detergent and water. Rinse with clean water, dry and polish with a soft, clean cloth.
Painted and plastic control knobs Painted body parts Painted decorative trims	Using a soft cloth, clean with mild dish detergent and water or a 50/50 solution of vinegar and water. Rinse with clean water, dry and polish with a soft, clean cloth. Glass cleaners may be used, but do not apply directly to surface; spray onto cloth and wipe.
Control panel	Using a soft cloth, clean with mild dish detergent and water or a 50/50 solution of vinegar and water. Do not spray liquids directly on the oven control and display area. Do not use large amounts of water on the control panel - excess water on the control area may cause damage to the appliance. Do not use other liquid cleaners, abrasive cleaners, scouring pads, or paper towels - they will damage the finish.
Control knobs	Using a soft cloth, clean with mild dish detergent and water or a 50/50 solution of vinegar and water. To remove control knobs: turn to the OFF position, grasp firmly, and pull off the shaft. To replace knobs after cleaning, line up the OFF markings and push the knobs into place.
Stainless Steel	Using a soft cloth, clean with mild dish detergent and water or a 50/50 solution of vinegar and water. Rinse with clean water, dry with a soft clean cloth. Do not use cleaners containing abrasives, chlorides, chlorine, or ammonia.
Smudge Proof™ Stainless Steel Black Stainless Steel	Using a soft cloth, clean with mild dish detergent and water or a 50/50 solution of vinegar and water. Rinse with clean water, dry with a soft clean cloth. Do not use appliance cleaner, stainless steel cleaner, or cleaner containing abrasives, chlorides, chlorine, or ammonia. These cleaners may damage the finish.
Oven Racks	Oven racks must be removed from oven cavity. Clean by using a mild, abrasive cleaner. Rinse with clean water and dry.

## CARE AND CLEANING

Porcelain-enameled broiler pan and insert	Rinse with clean water and a damp cloth. Scrub gently with a soapy, non-abrasive scouring pad to remove most spots. Rinse with a 50/50 solution of clean water and ammonia. If necessary, cover difficult spots with an ammonia-soaked paper towel for 30 to 40 minutes. Rinse and wipe dry with a clean cloth. Remove all cleaners or future heating could damage the porcelain. Do not allow food spills with a high sugar or acid content (milk, tomatoes, sauerkraut, fruit juices or pie filling) to remain on porcelain surfaces. These spills may cause a dull spot even after cleaning.
Porcelain door liner	
Porcelain body parts	
Oven interior	Use Steam Clean for minor soils on oven cavity.  If cleaning oven interior manually, use mild dish detergent and water or a 50/50 solution of vinegar and water to clean.  Ammonia must be rinsed thoroughly before operating the oven. Provide adequate ventilation.
Oven door	Use mild dish detergent and water or a 50/50 solution of vinegar and water to clean the top, sides, and front of the oven door. Rinse well. Glass cleaner may be used on the outside glass of the door. Ceramic smoothtop cleaner or polish may be used on the interior door glass. Do not immerse the door in water. Do not spray or allow water or cleaners to enter the door vents. Do not use oven cleaners, cleaning powders, or any harsh abrasive cleaning materials on the outside of the oven door.  Do not clean the oven door gasket. The oven door gasket is made of a woven material which is essential for a good seal. Do not rub, damage, or remove this gasket.
Ceramic cooktop	See <a href="#">“Cooktop Maintenance”</a> on <a href="#">page 29</a> .

## CARE AND CLEANING

### Cooktop Maintenance

Consistent and proper cleaning is essential to maintaining your ceramic glass cooktop.

Prior to using your cooktop for the first time, apply a ceramic cooktop cleaning cream (available in most hardware, grocery, and department stores) to the ceramic surface. Clean and buff with a clean paper towel. This will make cleaning easier when soiled from cooking. Cooktop cleaning creams leave a protective finish on the glass to help prevent scratches and abrasions.

Sliding aluminum, cast iron, or copper bottomed pans on the cooktop can cause metal markings on the cooktop surface. These marks should be removed immediately after the cooktop has cooled using cooktop cleaning cream. Metal marks can become permanent if not removed prior to future use.

Cookware (cast iron, metal, ceramic, or glass) with rough bottoms can mark or scratch the cooktop surface.

#### Do not:

- Slide anything metal or glass across the cooktop.
- Use cookware with dirt or dirt build up on the bottom; always use clean cookware.
- Use your cooktop as a cutting board or work surface in the kitchen.
- Cook foods directly on the cooktop surface without a pan.
- Drop heavy or hard objects on the ceramic glass cooktop; they may cause it to crack.

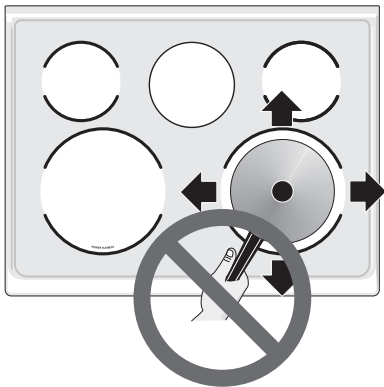

Figure 14: Cooktop care

### Cooktop Cleaning

#### ! WARNING

Do not use a cooktop cleaner on a hot cooktop. The fumes can be hazardous to your health, and can chemically damage the ceramic-glass surface.

#### ! CAUTION

Before cleaning the cooktop, be sure the controls are turned to OFF and the cooktop is cool. The glass surface could be hot and burns may occur if the glass surface is touched before it has cooled sufficiently.

#### For light to moderate soil:

For light to moderate soil: Apply a few drops of cooktop cleaning cream directly to the cooktop. Use a clean paper towel to clean the entire cooktop surface. Make sure the cooktop is cleaned thoroughly, leaving no residue. Do not use the towel you use to clean the cooktop for any other purpose.

#### For heavy, burned on soil:

Apply a few drops of cooktop cleaning cream directly to the soiled area. Rub the soiled area using a non-abrasive cleaning tool, applying pressure as needed. Do not use the pad you use to clean the cooktop for any other purpose.

If soils remain, carefully scrape soils with a metal razor blade scraper, holding scraper at a 30 degree angle to the surface. Remove loosened soils with cooktop cleaning cream and buff the surface clean.

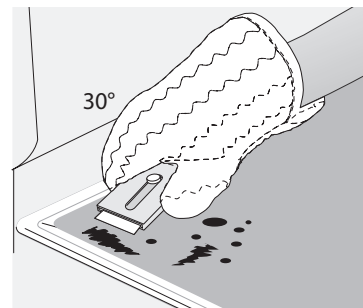

Figure 15: Cooktop cleaning

## CARE AND CLEANING

### Cooktop Maintenance (cont'd)

#### ➔ IMPORTANT

Damage to the ceramic glass cooktop may occur if you use an abrasive type cleaning pad. Only use cleaning products that have been specifically designed for ceramic glass cooktops.

### Aluminum Foil and Utensils

#### ⚠ WARNING

Never cover any slots, holes, or passages in the oven bottom or cover an entire oven rack with materials such as aluminum foil. Aluminum foil linings may trap heat, causing a fire hazard.

#### ⚠ WARNING

Protective Liners — Do not use aluminum foil to line the oven bottom. Improper installation of these liners may result in risk of electric shock or fire.

#### ➔ IMPORTANT

- Aluminum foil - Use of aluminum foil on a hot cooktop can damage the cooktop. Do not use thin aluminum cooking utensils or allow aluminum foil to touch the surface elements under any circumstances.
- Aluminum utensils - The melting point of aluminum is much lower than that of other metals. Care must be taken when aluminum pots or pans are used on the cooktop. If aluminum pans are allowed to boil dry when using the cooktop, not only will the utensil be damaged or destroyed, but it may fuse to, break, or mark the ceramic glass surface, permanently damaging the cooktop surface.

### Remove and replace storage drawer

Use the storage drawer for storing cooking utensils. The drawer can be removed to facilitate cleaning under the range. Use care when handling the drawer

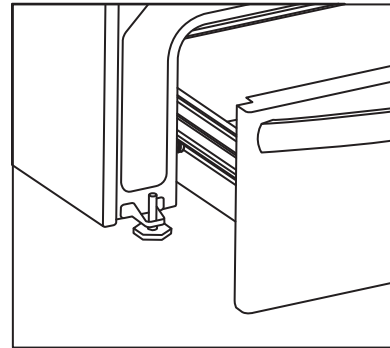
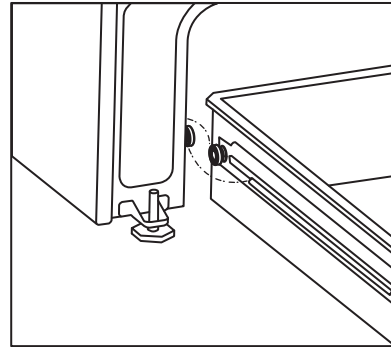

## Removing and Replacing the Oven Door

To remove oven door:

### CAUTION

The door is heavy. For safe, temporary storage, lay the door flat with the inside of the door facing down.

1. Open oven door completely, horizontal with floor (See [Figure 16](#)).
2. Pull the door hinge locks on both left and right door hinges down from the oven frame completely towards the oven door (See [Figure 17](#)). A tool such as a small flat-blade screwdriver may be required.
3. Firmly grasp both sides of oven door along the door sides. Do not use the oven door handle (See [Figure 18](#)).
4. Close the door to approximately 10 degrees from the door frame (See [Figure 18](#)).
5. Lift the oven door hinge arms over the roller pins located on each side of the oven frame (See [Figure 19](#)).

To replace oven door:

1. Firmly grasp both sides of oven door along the door sides. Do not use the oven door handle (See [Figure 18](#)).
2. Holding the oven door at the same angle as the removal position, seat the hook of the hinge arm over the roller pins located on each side of the oven door frame (See [Figure 18](#) and [Figure 19](#)). The hook of the hinge arms must be fully seated onto the roller pins.
3. Fully open the oven door, horizontal with floor (See [Figure 16](#)).
4. Push the door hinge locks up towards and into the oven frame on both left and right oven door hinges to the locked position (See [Figure 17](#)).
5. Close the oven door.

### IMPORTANT

Special door care instructions - Most oven doors contain glass that can break. Do not hit the glass with pots, pans, or any other object. Scratching, hitting, jarring, or stressing the glass may weaken its structure, causing an increased risk of breakage at a later time. Do not close the oven door until all of the oven racks are fully in place.

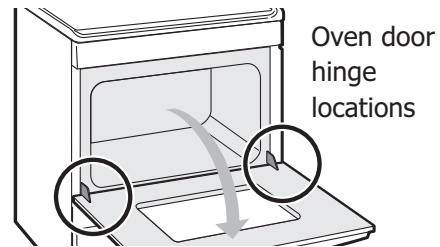

Figure 16: Door hinge location

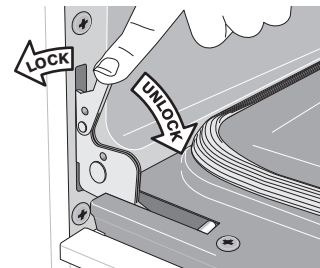

Figure 17: Door hinge locks

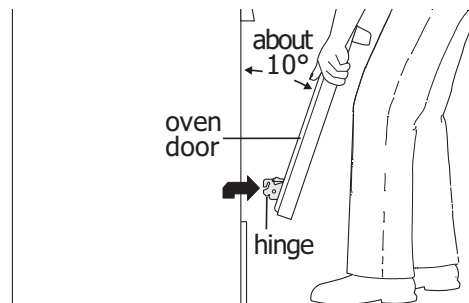

Figure 18: Holding door for removal

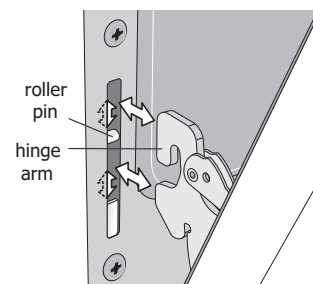

Figure 19: Replacement and location of hinge arm and roller pin

## CARE AND CLEANING

### Replacing the Oven Light

#### CAUTION

Be sure the oven is unplugged and all parts are cool before replacing the oven light.

#### Replacing the oven interior light bulb:

The interior oven light is located at the rear of the oven cavity and covered with a glass shield. The glass shield must be in place whenever the oven is in use (Figure 20).

1. Turn electrical power off at the main source or unplug the appliance.
2. Remove the interior oven light shield after removing the wire holder by carefully moving the wire to the side of the glass shield. The tension from the wire holds the glass shield in place.
3. Pull the shield straight out. Do not twist or turn.
4. Replace the bulb with a new appliance bulb.
5. Replace the glass oven light shield. Replace wire holder.
6. Turn the power back on again at the main source (or plug the appliance back in).
7. Be sure to reset the time of day on the clock.

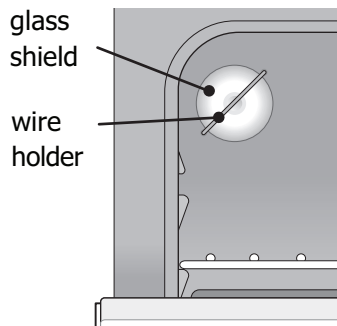







Figure 20: Oven light protected by glass shield



## Oven Baking

For best cooking results, preheat the oven before baking cookies, breads, cakes, pies, pastries, etc. There is no need to preheat the oven for roasting meat or baking casseroles. The cooking times and temperatures needed to bake a product may vary slightly from your previously owned appliance.

### Baking Problems and Solutions

Baking Problems	Causes	Corrections
<p>Cookies and biscuits burn on the bottom.</p> 	<ul style="list-style-type: none"> <li>• Cookies and biscuits put into oven before oven is preheated.</li> <li>• Oven rack is overcrowded.</li> <li>• Dark pan absorbs heat too fast.</li> </ul>	<ul style="list-style-type: none"> <li>• Allow oven to preheat to desired temperature before placing food in oven.</li> <li>• Choose pan sizes that will permit at least 2" of air space (5.1 cm) on all sides when placed in the oven.</li> <li>• Use a medium weight shiny baking sheet.</li> </ul>
<p>Cakes too dark on top or bottom</p> 	<ul style="list-style-type: none"> <li>• Cakes put in oven before oven is preheated.</li> <li>• Rack position too high or too low.</li> <li>• Oven too hot.</li> </ul>	<ul style="list-style-type: none"> <li>• Allow oven to preheat to the selected temperature before placing food in the oven.</li> <li>• Use proper rack position for baking needs.</li> <li>• Set oven temperature 25°F (13°C) lower than recommended.</li> </ul>
<p>Cakes not done in center</p> 	<ul style="list-style-type: none"> <li>• Oven too hot.</li> <li>• Incorrect pan size.</li> <li>• Pan not centered in oven.</li> <li>• Glass cookware slow heat conductor.</li> </ul>	<ul style="list-style-type: none"> <li>• Set oven temperature 25°F (13°C) lower than recommended.</li> <li>• Use pan size suggested in recipe.</li> <li>• Use proper rack position and place pan so there are at least 2" (5.1 cm) of space on all sides of pan.</li> <li>• Reduce temperature and increase cook time or use shiny bakeware.</li> </ul>
<p>Cakes not level.</p> 	<ul style="list-style-type: none"> <li>• Oven not level.</li> <li>• Pan too close to oven wall or rack overcrowded.</li> <li>• Pan warped.</li> <li>• Oven light left on while baking.</li> </ul>	<ul style="list-style-type: none"> <li>• Place a marked glass measuring cup filled with water on the center of the oven rack. If the water level is uneven, refer to the installation instructions for leveling the oven.</li> <li>• Use proper rack position and place pan so there are at least 2" (5.1 cm) of space on all sides of pan.</li> <li>• Do not use pans that are dented or warped.</li> <li>• Do not leave the oven light on while baking.</li> </ul>
<p>Foods not done when cooking time is over.</p> 	<ul style="list-style-type: none"> <li>• Oven too cool.</li> <li>• Oven overcrowded.</li> <li>• Oven door opened too frequently.</li> </ul>	<ul style="list-style-type: none"> <li>• Set oven temperature 25°F (13°C) higher than suggested and bake for the recommended time.</li> <li>• Be sure to remove all pans from the oven except the ones to be used for baking.</li> <li>• Open oven door only after the shortest recommended baking time.</li> </ul>

## BEFORE YOU CALL

### Solutions to Common Problems:

Before you call for service, review the following list. It may save you time and expense. Possible solutions are provided with the problem listed.

Problem	Cause / Solution
Entire appliance does not operate.	Appliance not connected. Make sure power cord is plugged properly into outlet. Check your fuse box or breaker box to make sure the circuit is active.  Electrical power outage. Check house lights to be sure. Call your local electric company for service outage information.
<b>Oven Problems</b>	
Poor baking results.	Many factors affect baking results. Use proper oven rack position. Center food in the oven and space pans to allow air to circulate. Preheat the oven to the set temperature before placing food in the oven. Try adjusting the recipe's recommended temperature or baking time. See <a href="#">"Adjusting the oven temperature"</a> on <a href="#">page 26</a> if you feel the oven is too hot or too cool.
Flames inside oven or smoking from oven vent.	Excessive spills in oven. Grease or food spilled onto the oven bottom or oven cavity. Wipe up excessive spills before starting the oven. If flames or excessive smoke are present when using broil, see <a href="#">"Setting Broil"</a> on <a href="#">page 23</a> .
Oven smokes excessively when broiling.	Incorrect setting. Follow the <a href="#">"Setting Broil"</a> instructions on <a href="#">page 23</a> .  Meat too close to the broil element or burner. Reposition the broil pan to provide proper clearance between the meat and broil element or burner. Remove excess fat from meat. Cut remaining fatty edges to prevent curling, but do not cut into lean.  Grease build up on oven surfaces. Regular cleaning is necessary when broiling frequently. Grease or food splatters will cause excessive smoking.
Oven control panel beeps and displays any F or E code error.	Oven control has detected a fault or error condition. To clear the error, press the <b>OFF</b> key on the control panel. Once the error code is cleared, try the bake or broil function. If the F or E code error repeats, turn off the power to appliance, wait 5 minutes, and then repower the appliance. Set the clock with correct time of day. Try the bake or broil function again. If the fault recurs, press the <b>OFF</b> key to clear.
Oven portion of appliance does not operate.	Be sure the regulator gas valve is turned to ON. See installation instructions.  The time of day is not set. The clock must be set in order to operate the oven. See <a href="#">"Setting the Clock"</a> on <a href="#">page 19</a> .  Be sure the oven controls are set properly for the desired function. See <a href="#">"Oven Control Features"</a> starting on <a href="#">page 18</a> and review instructions for the desired cooking function in this manual or see <a href="#">"Entire appliance does not operate."</a> in this checklist.

## BEFORE YOU CALL

Problem	Cause / Solution
<b>Cooktop Problems</b>	
Surface element is too hot or not hot enough.	Incorrect surface control setting. Adjust power level setting.
Surface element does not heat or does not heat evenly.	Be sure the correct surface control knob is turned on for the element needed. Cookware is light weight or warped. Use only flat, evenly balanced, medium or heavy-weight cookware. Flat pans heat better than warped pans. Cookware materials and weight of the material affect heating. Heavy and medium-weight pans heat evenly. Because lightweight pans heat unevenly, foods may burn easily.
Areas of discoloration with metallic sheen on cooktop surface.	Mineral deposits from water and food. Remove them using cooktop cleaning creme applied to the ceramic surface. Buff with a non-abrasive cloth or sponge.
Scratches or abrasions on cooktop surface.	Coarse particles such as salt or hardened soils between cooktop and utensils can cause scratches. Be sure the cooktop surface and bottoms of utensils are clean before use. Small scratches do not affect cooking and will become less visible with time. Cleaning materials not recommended for ceramic-glass cooktop have been used. Apply cooktop cleaning creme to the ceramic surface. Buff with a non-abrasive cloth or sponge. Cookware with a rough bottom was used. Use smooth, flat-bottomed cookware.
Metal marks on the cooktop.	Sliding or scraping of metal utensils on cooktop surface. Do not slide metal utensils on the cooktop surface. Apply cooktop cleaning creme to the ceramic surface. Buff with a non-abrasive cloth or sponge. For more information, see <a href="#">“Cooktop Maintenance”</a> on <a href="#">page 29</a> .
Brown streaks or specks on cooktop surface.	Boil overs are cooked onto the surface. When cooktop is cool, use a razor blade scraper to remove soil. For more information see <a href="#">“Cooktop Maintenance”</a> on <a href="#">page 29</a> .
<b>Other Problems</b>	
Appliance is not level.	Be sure the floor is level, strong, and stable enough to adequately support the range. If the floor is sagging or sloping, contact a carpenter to correct the situation. Poor installation. Place the oven rack in the center of the oven. Place a level on the oven rack. Adjust the leveling legs at the base of the appliance until the rack is level. Kitchen cabinet alignment may make range appear not level. Be sure cabinets are square and have sufficient room for appliance clearance.
Cannot move appliance easily. Appliance must be accessible for service.	Cabinets not square or are built in too tightly. Contact the builder or installer to make the appliance accessible. Carpet interferes with appliance. Provide sufficient space so the appliance can be lifted over carpet. Installation over carpet is not advised. See the installation instructions for guidelines specific to your appliance.
Oven light does not work.	Be sure the oven light is secure in the socket. See <a href="#">“Replacing the Oven Light”</a> on <a href="#">page 32</a> .

# WARRANTY

Your appliance is covered by a one year limited warranty. For one year from your original date of purchase, Electrolux will pay all costs for repairing or replacing any parts of this appliance that prove to be defective in materials or workmanship when such appliance is installed, used and maintained in accordance with the provided instructions.

## Exclusions

This warranty does not cover the following:

1. Products with original serial numbers that have been removed, altered or cannot be readily determined.
2. Product that has been transferred from its original owner to another party or removed outside the USA or Canada.
3. Rust on the interior or exterior of the unit.
4. Products purchased "as-is" are not covered by this warranty.
5. Food loss due to any refrigerator or freezer failures.
6. Products used in a commercial setting.
7. Service calls which do not involve malfunction or defects in materials or workmanship, or for appliances not in ordinary household use or used other than in accordance with the provided instructions.
8. Service calls to correct the installation of your appliance or to instruct you how to use your appliance.
9. Expenses for making the appliance accessible for servicing, such as removal of trim, cupboards, shelves, etc., which are not a part of the appliance when it is shipped from the factory.
10. Service calls to repair or replace appliance light bulbs, air filters, water filters, other consumables, or knobs, handles, or other cosmetic parts.
11. Surcharges including, but not limited to, any after hour, weekend, or holiday service calls, tolls, ferry trip charges, or mileage expense for service calls to remote areas, including the state of Alaska.
12. Damages to the finish of appliance or home incurred during installation, including but not limited to floors, cabinets, walls, etc.
13. Damages caused by: services performed by unauthorized service companies; use of parts other than genuine Electrolux parts or parts obtained from persons other than authorized service companies; or external causes such as abuse, misuse, inadequate power supply, accidents, fires, or acts of God.

## DISCLAIMER OF IMPLIED WARRANTIES; LIMITATION OF REMEDIES

CUSTOMER'S SOLE AND EXCLUSIVE REMEDY UNDER THIS LIMITED WARRANTY SHALL BE PRODUCT REPAIR OR REPLACEMENT AS PROVIDED HEREIN. CLAIMS BASED ON IMPLIED WARRANTIES, INCLUDING WARRANTIES OF MERCHANTABILITY OR FITNESS FOR A PARTICULAR PURPOSE, ARE LIMITED TO ONE YEAR OR THE SHORTEST PERIOD ALLOWED BY LAW, BUT NOT LESS THAN ONE YEAR. ELECTROLUX SHALL NOT BE LIABLE FOR CONSEQUENTIAL OR INCIDENTAL DAMAGES SUCH AS PROPERTY DAMAGE AND INCIDENTAL EXPENSES RESULTING FROM ANY BREACH OF THIS WRITTEN LIMITED WARRANTY OR ANY IMPLIED WARRANTY. SOME STATES AND PROVINCES DO NOT ALLOW THE EXCLUSION OR LIMITATION OF INCIDENTAL OR CONSEQUENTIAL DAMAGES, OR LIMITATIONS ON THE DURATION OF IMPLIED WARRANTIES, SO THESE LIMITATIONS OR EXCLUSIONS MAY NOT APPLY TO YOU. THIS WRITTEN WARRANTY GIVES YOU SPECIFIC LEGAL RIGHTS. YOU MAY ALSO HAVE OTHER RIGHTS THAT VARY FROM STATE TO STATE.

## If You Need Service

Keep your receipt, delivery slip, or some other appropriate payment record to establish the warranty period should service be required. If service is performed, it is in your best interest to obtain and keep all receipts. Service under this warranty must be obtained by contacting Electrolux at the addresses or phone numbers below.

This warranty only applies in the USA and Canada. In the USA, your appliance is warranted by Electrolux Major Appliances North America, a division of Electrolux Home Products, Inc. In Canada, your appliance is warranted by Electrolux Canada Corp. Electrolux authorizes no person to change or add to any obligations under this warranty. Obligations for service and parts under this warranty must be performed by Electrolux or an authorized service company. Product features or specifications as described or illustrated are subject to change without notice.

USA  
1.800.944.9044  
Electrolux Home Products, Inc.  
10200 David Taylor Drive  
Charlotte, NC 28262



Canada  
1.800.265.8352  
Electrolux Canada Corp.  
5855 Terry Fox Way  
Mississauga, Ontario, Canada  
L5V 3E4