



Contact SAMSUNG WORLDWIDE

If you have any questions or comments relating to Samsung products, please contact the SAMSUNG customer care center.

Country	Customer Care Center ☎	Web Site	Address
CANADA	1-800-SAMSUNG(726-7864)	www.samsung.com/ca	Samsung Electronics Canada Inc., Customer Service 55 Standish Court Mississauga, Ontario L5R 4B2 Canada
U.S.A	1-800-SAMSUNG(726-7864)	www.samsung.com/us	Samsung Electronics America, Inc. 85 Challenger Road Ridgefield Park, NJ 07660-2112

SERIES **4+**
450

Plasma TV user manual

imagine the possibilities

Thank you for purchasing this Samsung product.
To receive more complete service, please register
your product at

www.samsung.com/register

Model _____ Serial No. _____



Figures and illustrations in this User Manual are provided for reference only and may differ from actual product appearance. Product design and specifications may be changed without notice.

Important Warranty Information Regarding Television Format Viewing

 See the warranty card for more information on warranty terms.

Wide screen format PDP Displays (16:9, the aspect ratio of the screen width to height) are primarily designed to view wide screen format full-motion video. The images displayed on them should primarily be in the wide screen 16:9 ratio format, or expanded to fill the screen if your model offers this feature and the images are constantly moving. Displaying stationary graphics and images on screen, such as the dark side bars on no expanded standard format television video and programming, should be limited to no more than 5% of the total television viewing per week.

Additionally, viewing other stationary images and text such as stock market reports, video game displays, station logos, web sites or computer graphics and patterns, should be limited as described above for all televisions. Displaying stationary images that exceed the above guidelines can cause uneven aging of PDP Displays that leave subtle, but permanent burned-in ghost images in the PDP picture. To avoid this, vary the programming and images, and primarily display full screen moving images, not stationary patterns or dark bars.

On PDP models that offer picture sizing features, use these controls to view different formats as a full screen picture.

Be careful in the selection and duration of television formats used for viewing. Uneven PDP aging as a result of format selection and use, as well as burned in images, are not covered by your Samsung limited warranty.

- **SAMSUNG ELECTRONICS NORTH AMERICAN LIMITED WARRANTY STATEMENT**

Subject to the requirements, conditions, exclusions and limitations of the original Limited Warranty supplied with Samsung Electronics (SAMSUNG) products, and the requirements, conditions, exclusions and limitations contained herein, SAMSUNG will additionally provide Warranty Repair Service in the United States on SAMSUNG products purchased in Canada, and in Canada on SAMSUNG products purchased in the United States, for the warranty period originally specified, and to the Original Purchaser only.

The above described warranty repairs must be performed by a SAMSUNG Authorized Service Center. Along with this Statement, the Original Limited Warranty Statement and a dated Bill of Sale as Proof of Purchase must be presented to the Service Center. Transportation to and from the Service Center is the responsibility of the purchaser. Conditions covered are limited only to manufacturing defects in material or workmanship, and only those encountered in normal use of the product.

Excluded, but not limited to, are any originally specified provisions for, in-home or on-site services, minimum or maximum repair times, exchanges or replacements, accessories, options, upgrades, or consumables.

For the location of a SAMSUNG Authorized Service Center, please call toll-free:

- In the United States : 1-800-SAMSUNG (1-800-726-7864)

- In Canada : 1-800-SAMSUNG

User Instructions

- **Screen Image retention**

Do not display a still image (such as on a video game) on the plasma display panel for more than several minutes as it can cause screen image retention. This image retention is also known as 'screen burn'. To avoid such image retention, refer to page 15 of this manual to reduce the degree of brightness and contrast of the screen when displaying a still image.

- **Heat on the top of the Plasma TV**

The top side of the product may be hot after long periods of use as heat dissipates from the panel through the vent hole in the upper part of the product.

This is normal and does not indicate any defect or operation failure of the product.

However, children should be prevented from touching the upper part of the product.

- **The product is making a 'cracking' noise.**

A 'cracking' noise may occur when the product contracts or expands due to a change in the surrounding environment such as temperature or humidity. This is normal and not a defect of the unit.

- **Cell Defects**

The PDP uses a panel consisting of 2,360,000(HD-level) to 6,221,000(FHD-level) pixels which require sophisticated technology to produce. However, there may be a few bright or dark pixels on the screen. These pixels will have no impact on the performance of the product.

- **Avoid operating the TV at temperatures below 41°F (5°C)**

- **A still image displayed too long may cause permanent damage to the PDP Panel.**



Watching the Plasma TV in 4:3 format for a long period of time may leave traces of borders displayed on the left, right and center of the screen caused by the difference of light emission on the screen. Playing a DVD or a game console may cause similar effects to the screen.

Damages caused by the above effect are not covered by the Warranty.

- **After-images on the Screen.**

Displaying still images from Video games and PC for longer than a certain period of time may produce partial after-images.

To prevent this effect, reduce the 'brightness' and 'contrast' when displaying still images for a long time.

- **Warranty**

Warranty does not cover any damage caused by image retention.

Burn-in is not covered by the warranty.

Contents

Getting Started

- List of Features 4
- Accessories 4
- Install the Stand 5
- Viewing the Control Panel 6
- Viewing the Remote Control 7
- Connecting to an Antenna 8
- Plug & Play (Initial Setup) 8

Connections

- Connecting to an AV Device 9
- Connecting to an Audio Device 10
- Connecting to a PC 11
- Changing the Input Source 12

Basic Features

- How to Navigate Menus 12
- Channel Menu 13
 - Seeing Channels 13
 - Using Favorite Channels 13
 - Memorizing Channels 13
 - Editing Channels 14
 - Other Features 14
- Picture Menu 15
 - Changing the Preset Picture Mode 15
 - Adjusting Picture Settings 15
 - Changing the Picture Options 15
 - Setting up the TV with your PC 17
- Sound Menu 17
 - Changing the Preset Sound Mode 17
 - Adjusting Sound Settings 18
 - Sound Settings 18

- Setup Menu 18
 - Setting the Time 18
 - Using the Sleep Timer 19
 - Setting the On / Off Timer 19
 - Locking Programs 19
 - Economical Solutions 21
 - Other Features 21
- Support Menu 22

Advanced Features

- Media Play 23
 - Connecting a USB Device 23
- Anynet+ 26
 - Setting Up Anynet+ 27
 - Switching between Anynet+ Devices 28
 - Recording 28
 - Listening through a Receiver 28
 - Troubleshooting for Anynet+ 29

Other Information

- Installing the Wall Mount 30
- Securing the Installation Space 31
- Securing the TV to the Wall 32
- Troubleshooting 33
 - Storage and Maintenance 35
- License 36
- Specifications 36
- Dimensions 37
- Index 38

Check the Symbol!



This function can be used by pressing the TOOLS button on the remote control.



Note

Indicates additional information.



Step by Step Guide

Check here for instructions on how to open the relevant submenu within the OSD (on screen display).

Getting Started

List of Features

- **Excellent Digital Interface & Networking:** With a built-in HD digital tuner, nonsubscription HD broadcasts can be viewed without a cable box / STB (Set-Top-Box) satellite receiver.
- **SRS TruSurround HD** provides a virtual surround system (p 18).
- **Media Play:** Allows you to play music files, pictures saved on a USB device (p. 23).
- **Self Diagnosis:** You can check to make sure picture and sound operate normally (p. 22).

Accessories

- 📎 Please make sure the following items are included with your PDP TV. If any items are missing, contact your dealer.
- 📎 The items' colors and shapes may vary depending on the models.

- Remote Control (BN59-00997A) & Batteries (AAA x 2)
- Owner's Instructions
- Warranty Card / Safety Guide / Quick Setup Guide
- Cleaning Cloth (BN63-01798B)
- Power Cord

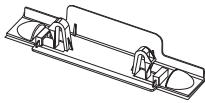

Blanking Bracket (BN63-06456A)



Ferrite Core for Power Cord (1EA)
(3301-002049)

- 📎 **Ferrite Core for Power Cord:** The ferrite cores are used to shield the cables from interference. When connecting a cable, open the ferrite core and clip it around the cable near the plug as shown in the figure.

- **A** Maximum distance between the ferrite core and the end of the cord inserted in the TV: 2 inches

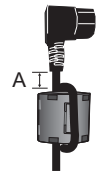

Power Cord

Input Cables (Sold Separately)

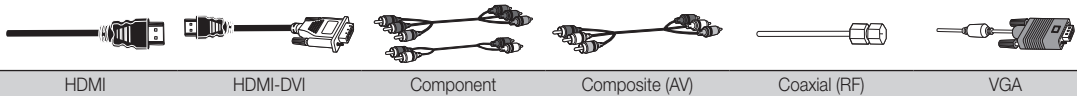

HDMI

HDMI-DVI

Component

Composite (AV)

Coaxial (RF)

VGA

Install the Stand

See separate guide for installing the stand.

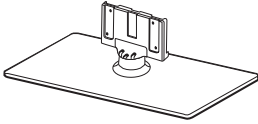

Stand (1EA)



Screws (4EA)

Follow the steps below to connect the TV to the stand.

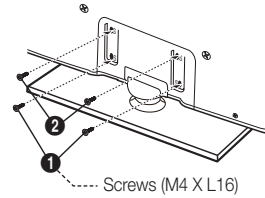
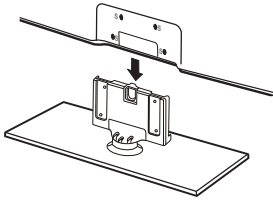

1. With your TV upright, connect the TV to the Stand as shown.
2. Fasten two screws (M4 X L16) at position **1**, and then fasten two screws (M4 X L16) at position **2**.

NOTE

- Make sure to distinguish between the front and back of the Stand and Guide Stand when assembling them.
- Make sure that at least two persons lift and move the PDP TV.
- Stand the product up and fasten the screws. If you fasten the screws with the PDP TV placed down, it may lean to one side.



 **Do not insert your fingers into the stand base slot of the TV when installing the stand base.**

Getting Started

Viewing the Control Panel

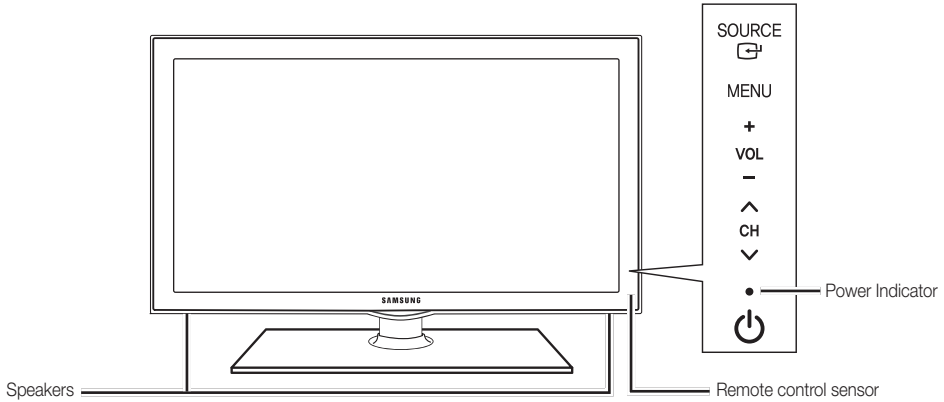
 The product color and shape may vary depending on the model.



SOURCE 	Toggles between all the available input sources. In the on-screen menu, use this button as you would use the ENTER  button on the remote control.
MENU	Displays an on-screen menu, the OSD (on screen display) of your TV's features.
- VOL +	Adjusts the volume. In the OSD, use the - VOL + buttons as you would use the ◀ and ▶ buttons on the remote control.
▼ CH ▲	Changes the channels. In the OSD, use the ▼ CH ▲ buttons as you would use the ▼ and ▲ buttons on the remote control.
Power Indicator	Blinks and turns off when the power is on and lights up in standby mode.
 (Power)	Turns the TV on or off.
Remote control sensor	Aim the remote control towards this spot on the TV.

Standby mode

Do not leave your TV in standby mode for long periods of time (when you are away on a holiday, for example). A small amount of electric power is still consumed even when the power button is turned off. It is best to unplug the power cord.

Viewing the Remote Control

 This is a special remote control for the visually impaired and has Braille points on the Power, Channel and Volume buttons.

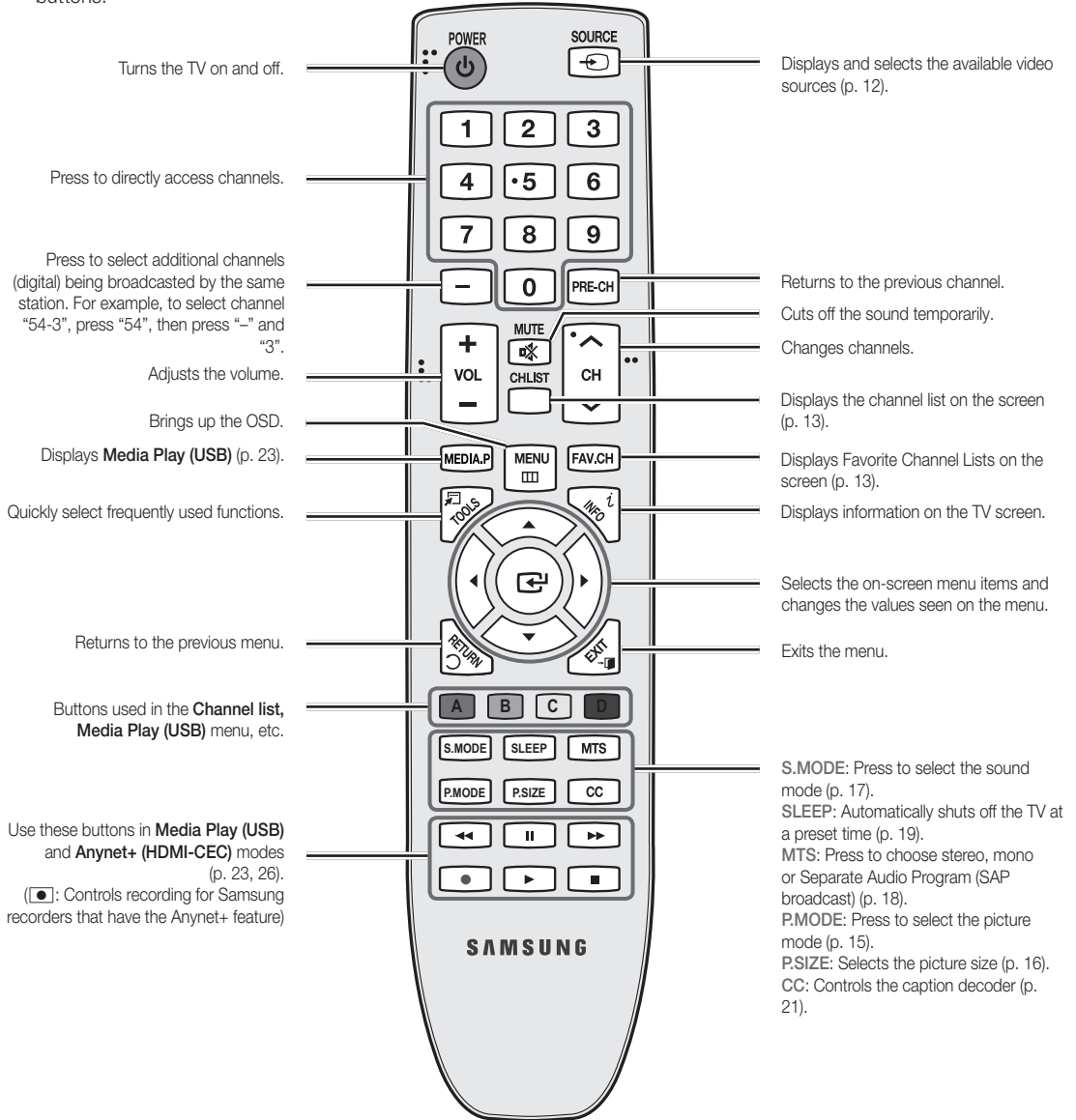

Installing batteries (Battery size: AAA)

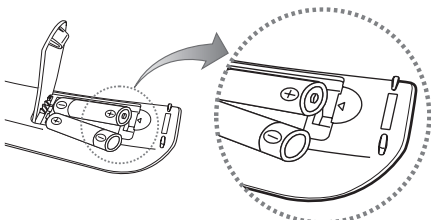



NOTE

- Use the remote control within 23 feet from the TV.
- Bright light may affect the performance of the remote control. Avoid use when nearby fluorescent lights or neon signs.
- The color and shape may vary depending on the model.

Getting Started

Connecting to an Antenna

When the TV is initially powered on, basic settings proceed automatically.

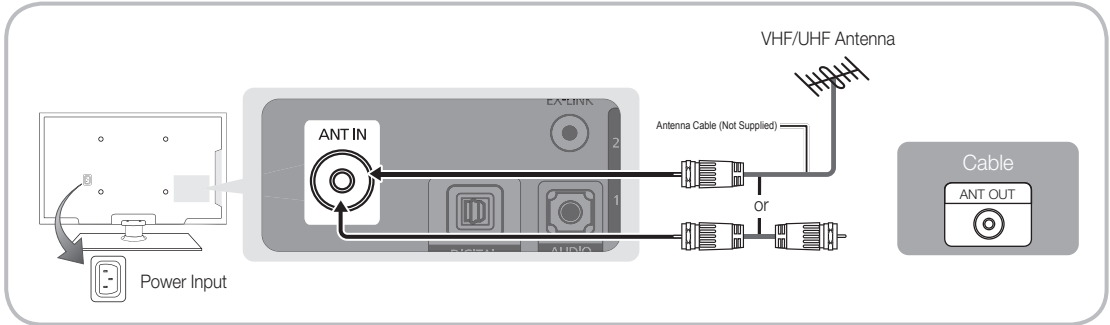

-  Connecting the power cord and antenna.
-  The PDP device may interfere with an amateur radio or AM radio.



Plug & Play (Initial Setup)

When the TV is initially powered on, a sequence of on-screen prompts will assist in configuring basic settings. Press the **POWER** button. **Plug & Play** is available only when the **Input** source is set to TV.

-  To return to the previous step, press the Red button.

1	Selecting a language	Press the ▲ or ▼ button, then press the ENTER button. Select the desired OSD (On Screen Display) language.	
2	Selecting Store Demo or Home Use	Press the ◀ or ▶ button, then press the ENTER button. <ul style="list-style-type: none"> • Select the Home Use mode. Store Demo mode is for retail environments. • To return the unit's settings from Store Demo to Home Use (standard): Press the volume button on the TV. When you see the volume OSD, press and hold MENU for 5 sec. 	
3	Selecting an antenna	Press the ▲ or ▼ button, then press the ENTER button. Select Air , Cable or Auto .	
4	Selecting a channel	Press the ▲ or ▼ button, then press the ENTER button. Select the channel source to memorize. When setting the antenna source to Cable , a step appears allowing you to assign numerical values (channel frequencies) to the channels. For more information, refer to Channel → Auto Program (p. 13).  Press the ENTER button at any time to interrupt the memorization process.	
5	Setting the Clock Mode	Set the Clock Mode automatically or manually. <ul style="list-style-type: none"> • Auto: Allows you to select DST (Daylight Saving Time) mode and time zone. • Manual: Allows you to manually set the current date and time. (p. 19). 	
6	View the HD Connection Guide .	The connection method for the best HD screen quality is displayed.	
7	Enjoy your TV.	Press the ENTER button.	

If You Want to Reset This Feature...

 **MENU** → **Setup** → **Plug & Play** → **ENTER**

Connecting to an AV Device

Using an HDMI or HDMI/DVI cable: HD connection (up to 720p/1080i)

We recommend using the HDMI connection for the best quality HD picture.

Available devices: DVD, Blu-ray player, HD cable box, HD STB (Set-Top-Box) satellite receiver.

HDMI IN 1(DVI), 2, 3, PC/DVI AUDIO IN

- When using an HDMI/DVI cable connection, you must use the **HDMI IN 1(DVI)** jack for video. A DVD, Blu-ray player, HD cable box, or HD STB satellite receiver may require a DVI-HDMI (DVI to HDMI) cable or DVI-HDMI (DVI to HDMI) adapter. The **PC/DVI AUDIO IN** jack is required for audio.
- The picture may not display normally (if at all) or the audio may not work if an external device that uses an older version of HDMI mode is connected to the TV. If such a problem occurs, ask the manufacturer of the external device about the HDMI version and, if out of date, request an upgrade.
- Be sure to purchase a certified HDMI cable. Otherwise, the picture may not display or a connection error may occur.

Using a Component (up to 720p/1080i) or Audio/Video (480i only) Cable

Available devices: DVD, Blu-ray player, cable box, STB satellite receiver, VCR

When connecting to **AV IN**, the color of the **AV IN [Y/VIDEO]** jack (green) will not match the video cable (yellow).

For better picture quality, the Component connection is recommended over the A/V connection.

Connections

Connecting to an Audio Device

Using an Optical (Digital) or Audio (Analog) Cable Connection

Available devices: Digital Audio System, Amplifier, DVD home theater

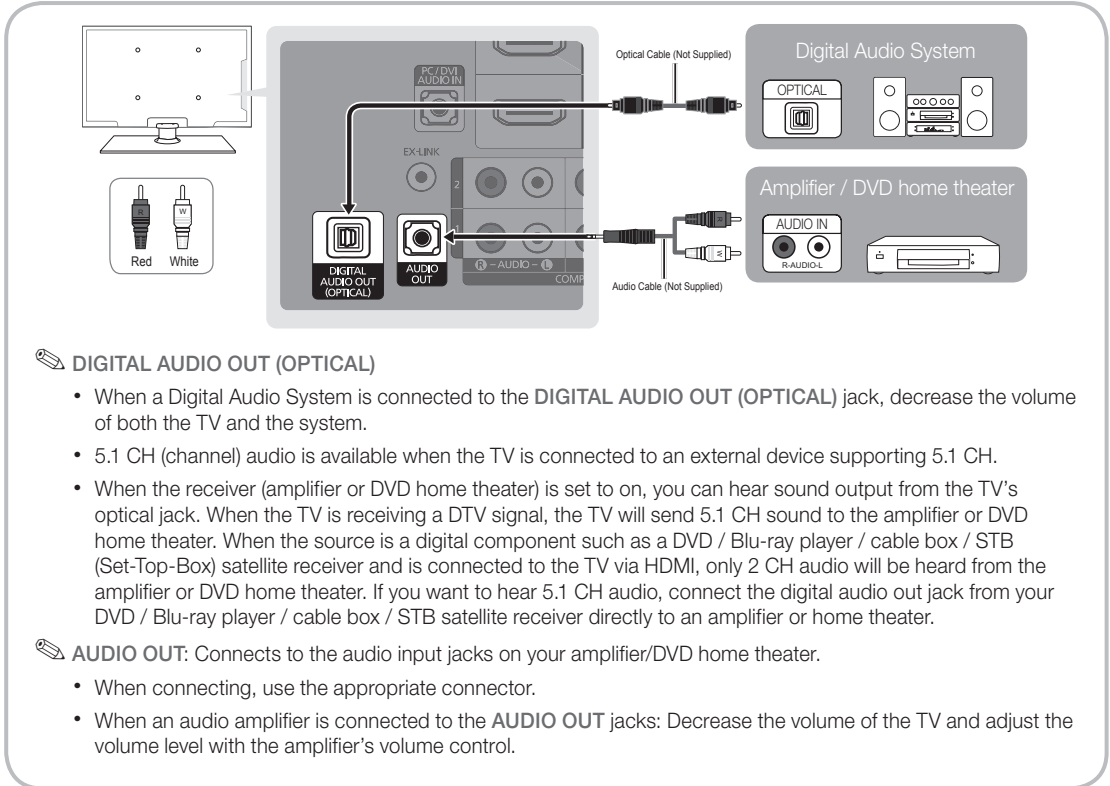

Using an EX-Link Cable Connection

Available Devices: External devices that support EX-Link

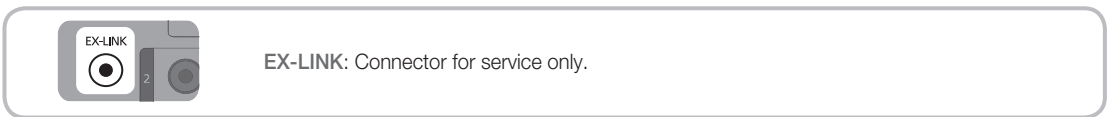

Connecting to a PC

Using an HDMI/DVI Cable or a D-sub Cable

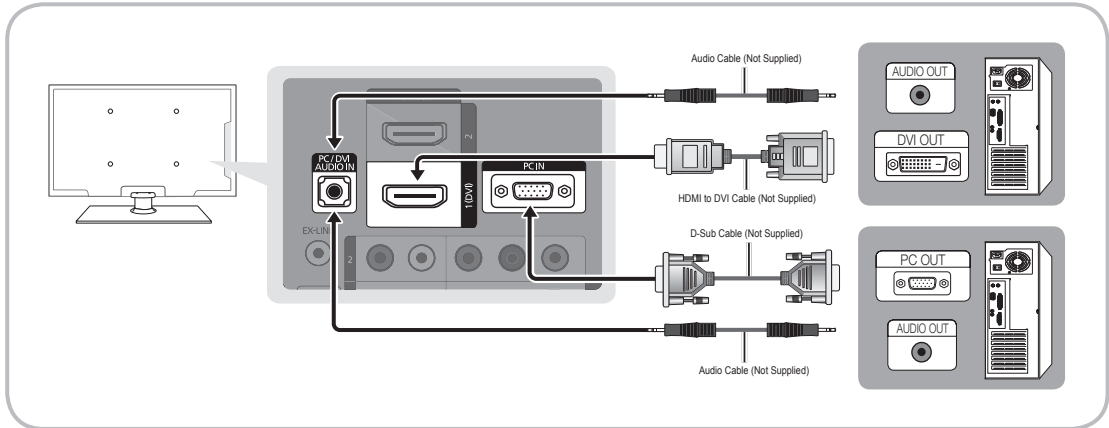

Display Modes (D-Sub and HDMI/DVI Input)

Optimal resolution

- PN42C450: 1024 X 768 @ 60Hz
- PN50C450: 1360 X 768 @ 60Hz

Mode	Resolution	Horizontal Frequency (KHz)	Vertical Frequency (Hz)	Pixel Clock Frequency (MHz)	Sync Polarity (H / V)	PN42C450	PN50C450
IBM	640 x 350	31.469	70.086	25.175	+/-	✓	✓
	720 x 400	31.469	70.087	28.322	-/+	✓	✓
MAC	640 x 480	35.000	66.667	30.240	-/-	✓	✓
	832 x 624	49.726	74.551	57.284	-/-	✓	✓
VESA CVT	720 x 576	35.910	59.950	32.750	-/+	✓	✓
	1280 x 720	56.456	74.777	95.750	-/+	✓	✓
VESA DMT	640 x 480	31.469	59.940	25.175	-/-	✓	✓
	640 x 480	37.500	75.000	31.500	-/-	✓	✓
	640 x 480	37.861	72.809	31.500	-/-	✓	✓
	800 x 600	37.879	60.317	40.000	+/+	✓	✓
	800 x 600	46.875	75.000	49.500	+/+	✓	✓
	800 x 600	48.077	72.188	50.000	+/+	✓	✓
	1024 x 768	48.363	60.004	65.000	-/-	✓	✓
	1024 x 768	56.476	70.069	75.000	-/-	✓	✓
	1024 x 768	60.023	75.029	78.750	+/+	✓	✓
VESA GTF	1280 x 720	45.000	60.000	74.250	+/+	✓	✓
	1360 x 768	47.712	60.015	85.500	+/+	✓	✓
VESA GTF	1280 x 720	52.500	70.000	89.040	-/+	✓	✓



NOTE

- For HDMI/DVI cable connection, you must use the HDMI IN 1(DVI) jack.
- The interlace mode is not supported.
- The set may operate abnormally if a non-standard video format is selected.
- Separate and Composite modes are supported. SOG(Sync On Green) is not supported.

Changing the Input Source

Source List

Use to select TV or an external input sources such as a DVD / Blu-ray player / cable box / STB satellite receiver.

 MENU  → Input → Source List → ENTER 





■ TV / PC / AV / Component1 / Component2 / HDMI1/DVI / HDMI2 / HDMI3 / USB

 You can only choose external devices that are connected to the TV. In the **Source List**, connected inputs will be highlighted.

 In the **Source List**, **PC** is always activated.

Edit Name

 MENU  → Input → Edit Name → ENTER 

- VCR / DVD / Cable STB / Satellite STB / PVR STB / AV Receiver / Game / Camcorder / PC / DVI PC / DVI Devices / TV / IPTV / Blu-ray / HD DVD / DMA:
Name the device connected to the input jacks to make your input source selection easier.

 When connecting an HDMI/DVI cable to the **HDMI IN 1(DVI)** port, you should set the TV to **DVI PC** or **DVI Devices** mode under **Edit Name**.

Basic Features

How to Navigate Menus



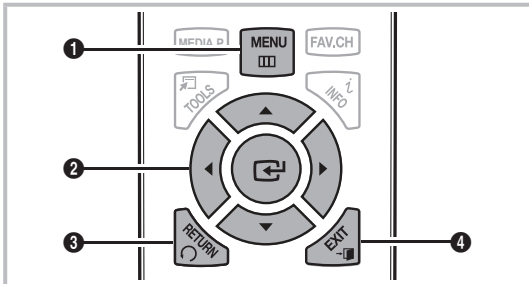



Before using the TV, follow the steps below to learn how to navigate the menu and select and adjust different functions.



- 1 MENU button: Displays the main on-screen menu.
- 2 ENTER  / Direction button: Move the cursor and select an item. Confirm the setting.
- 3 RETURN button: Returns to the previous menu.
- 4 EXIT button: Exits the on-screen menu.

How to Operate the OSD (On Screen Display)

The access step may differ depending on the selected menu.

1	MENU 	The main menu options appear on the screen: Picture, Sound, Channel, Setup, Input, Application, Support.
2	▲ / ▼	Select an icon with the ▲ or ▼ button.
3	ENTER 	Press ENTER  to access the sub-menu.
4	▲ / ▼	Select the desired submenu with the ▲ or ▼ button.
5	◀ / ▶	Adjust the value of an item with the ◀ or ▶ button. The adjustment in the OSD may differ depending on the selected menu.
6	ENTER 	Press ENTER  to confirm the selection.
7	EXIT 	Press EXIT.

Channel Menu

Seeing Channels





Channel List

Add, delete or set Favorite channels and use the program guide for digital broadcasts.

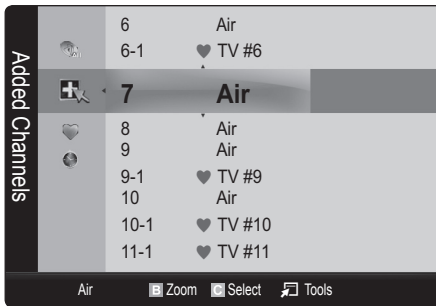

 MENU  → Channel → Channel List → ENTER 

Select a channel in the **All Channels**, **Added Channels**, **Favorite** or **Programmed** screen by pressing the ▲ / ▼ and ENTER  buttons. Then you can watch the selected channel.



-  **All Channels**: Shows all currently available channels.
-  **Added Channels**: Shows all added channels.
-  **Favorite**: Shows all favorite channels.
-  **Programmed**: Shows all currently reserved programs.



 Using the color buttons with the **Channel List**

-  **Green (Zoom)**: Enlarges or shrinks a channel number.
-  **Yellow (Select)**: Selects multiple channel lists. Select desired channels and press the Yellow button to set all the selected channels at the same time. The ✓ mark appears to the left of the selected channels.
-  **(Tools)**: Displays the **Channel List** option menu. (The options menus may differ depending on the situation.)

Channel Status Display Icons

Icons	Operations
✓	A channel selected.
♥	A channel set as a Favorite.
🕒	A reserved Program.

Using Favorite Channels

 MENU  → Channel → Channel List → ENTER 

Add to Favorite / Delete from Favorite

TOOLS 

Set channels you watch frequently as Favorites.

1. Select a channel and press the **TOOLS** button.
2. Add or delete a the channel using the **Add to Favorite** or **Delete from Favorite** menu respectively.

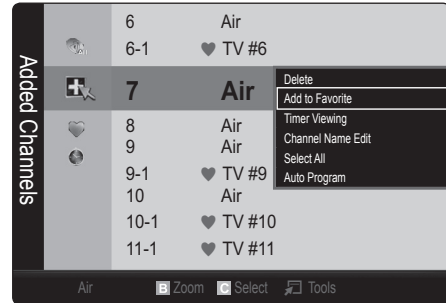

To show all Favorite channels, click on the button shown on the right.



Memorizing Channels

 MENU  → Channel → ENTER 

Antenna (Air / Cable) **TOOLS**

Before your television can begin memorizing the available channels, you must specify the type of signal source that is connected to the TV (i.e. an Air or a Cable system).

Auto Program



- **Air**: Air antenna signal.
- **Cable**: Cable antenna signal.
- **Auto**: Air and Cable antenna.

Basic Features

NOTE

- When selecting the Cable TV system: **STD**, **HRC** and **IRC** identify various types of cable TV systems. Contact your local cable company to identify the type of cable system that exists in your particular area. At this point, the signal source has been selected.
- After all the available channels are stored, it starts to remove scrambled channels. The **Auto Program** menu then reappears.

Editing Channels

 MENU  → Channel → Channel List → ENTER 

Channel Name Edit

1. Select a channel and press the **TOOLS** button.
 2. Edit the channel name using the **Channel Name Edit** menu.
- **Channel Name Edit** (analog channels only): Assign your own channel name.



Other Features

 MENU  → Channel → ENTER 

Clear Scrambled Channel

This function is used to filter out scrambled channels after Auto Program is completed. This process may take up to 20~30 minutes.

How to Stop Searching Scrambled Channels

1. Press the **ENTER**  button to select **Stop**.
2. Press the **◀** button to select **Yes**.
3. Press the **ENTER**  button.

 This function is only available in **Cable** mode.

Channel List

Channel List Option Menu

Set each channel using the **Channel List** menu options (**Add / Delete**, **Timer Viewing**, **Select All / Deselect All**). Option menu items may differ depending on the channel status.



1. Select a channel and press the **TOOLS** button.
 2. Select a function and change its settings.
- **Add / Delete**: Delete or add a channel to display the channels you want.

NOTE

- All deleted channels will be shown on the **All Channels** menu.

- A gray-colored channel indicates the channel has been deleted.
- The **Add** menu only appears for deleted channels.
- Delete a channel from the **Added Channels** or **Favorite** menu in the same manner.

- **Timer Viewing**: You can set a desired channel to be displayed automatically at the reserved time. Set the current time first to use this function.

1. Press the **◀ / ▶ / ▲ / ▼** buttons to select the desired channel in **Channel List**.
 2. Press the **TOOLS** button, then select **Timer Viewing**.
 3. Scroll up or down to adjust the settings in the box, or use the numeric buttons on your remote to enter the date and time.
-  If you selected **Once**, **Every Week** or **Everyday** in **Repeat**, you can enter the date you want.
4. Select **OK**, then press the **ENTER**  button when done.

NOTE

- Only memorized channels can be reserved.
- Reserved programs will be displayed in the **Programmed** menu.
- When a digital channel is selected, press the **▶** button to view the digital program.

- **Select All**: Select all the channels in the channel list.

- **Deselect All**: Deselect all the selected channels.

 You can only select **Deselect All** when one or more channels are selected.

Programmed



(in **Channel List**)

You can view, modify or delete a show you have reserved to watch. **Programmed** timer viewing is displayed here. Highlight a program and press the **TOOLS** button to display options.

- **Change Info**: Change a show you have reserved to watch. Begin with step 3 of “Timer Viewing,” above.
- **Cancel Schedules**: Cancel a show you have reserved to watch.

 This deletes the highlighted or selected program(s).

- **Information**: Display a show you have reserved to watch. (You can also change the reservation Information.)



 Alternatively, you can view Information by highlighting a program and pressing the **ENTER**  button.

- **Select All / Deselect All**: Select or deselect all reserved programs.

Fine Tune

(analog channels only)

If the reception is clear, you do not have to fine tune the channel, as this is done automatically during the search and store operation. If the signal is weak or distorted, fine tune the channel manually. Scroll to the left or right until the image is clear.

-  Settings are applied to the channel you're currently watching.
-  Fine tuned channels that have been saved are marked with an asterisk "*" on the right-hand side of the channel number in the channel banner.
-  To reset the fine-tuning, select **Reset**.

Picture Menu

Changing the Preset Picture Mode

 MENU  → Picture → Mode → ENTER 

Mode

Select your preferred picture type.

- **Dynamic:** Suitable for a bright room.
- **Standard:** Suitable for a normal environment.
- **Movie:** Suitable for watching movies in a dark room.



Adjusting Picture Settings

 MENU  → Picture → ENTER 

Cell Light / Contrast / Brightness / Sharpness / Color / Tint (G/R)



Your television has several setting options for picture quality control.

NOTE

- When you make changes to **Cell Light, Contrast, Brightness, Sharpness, Color** or **Tint (G/R)**, the OSD will be adjusted accordingly.
- In PC mode, you can only make changes to **Cell Light, Contrast** and **Brightness**.
- Settings can be adjusted and stored for each external device connected to the TV.

Changing the Picture Options

Advanced Settings

 MENU  → Picture → Advanced Settings → ENTER 

(Advanced Settings are available in **Standard / Movie** mode)
Compared to previous models, new Samsung TVs have a more precise picture.

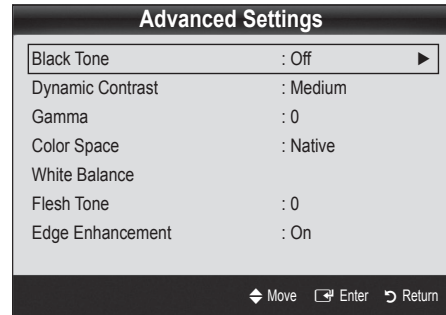

-  In PC mode, you can only make changes to **Gamma** and **White Balance**.



- **Black Tone (Off / Dark / Darker / Darkest):** Select the black level to adjust the screen depth.
- **Dynamic Contrast (Off / Low / Medium / High):** Adjust the screen contrast.
- **Gamma:** Adjust the primary color intensity.
- **Color Space (Auto / Native / Custom):** Adjust the range of colors available to create the image. To adjust **Color, Red, Green, Blue** and **Reset**, set **Color Space** to **Custom**.
- **White Balance:** Adjust the color temperature for a more natural picture.
R-Offset / G-Offset / B-Offset: Adjust each color's (red, green, blue) darkness.
R-Gain / G-Gain / B-Gain: Adjust each color's (red, green, blue) brightness.
Reset: Resets the **White Balance** to its default settings.
- **Flesh Tone:** Emphasize pink "Flesh Tone."
- **Edge Enhancement (Off / On):** Emphasize object boundaries.

Basic Features

Picture Options

 MENU  → Picture → Picture Options → ENTER 

 In PC mode, you can only make changes to the **Color Tone**, **Size** and **Screen Burn Protection**.

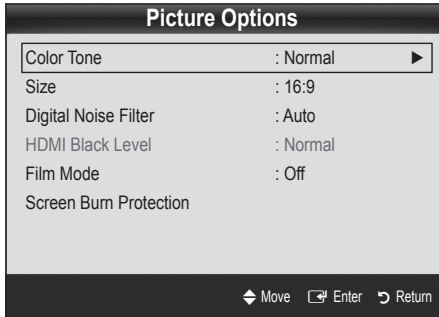

■ Color Tone (Cool / Normal / Warm1 / Warm2)

 **Warm1** or **Warm2** will be deactivated when the picture mode is **Dynamic** or **Standard**.

 Settings can be adjusted and stored for each external device connected to an input on the TV.

■ **Size:** Your cable box/satellite receiver may have its own set of screen sizes as well. However, we highly recommend you use 16:9 mode most of the time.

16:9 : Sets the picture to 16:9 wide mode.

Zoom1 : Use for moderate magnification.

Zoom2 : Use for a stronger magnification.

Wide Fit : Enlarges the aspect ratio of the picture to fit the entire screen.

 Available with HD 1080i / 720p signals in 16:9 mode.

4:3 : Sets the picture to basic (4:3) mode.

 Do not watch in 4:3 format for a long time. Traces of borders displayed on the left, right and center of the screen may cause image retention (screen burn) which are not covered by the warranty.



Screen Fit : Displays the full image without any cut-off when HDMI (720p / 1080i / 1080p) or Component (1080i / 1080p) signals are inputted.

NOTE

• After selecting **Zoom1**, **Zoom2** or **Wide Fit**:

1. Press the ► button to select **Position**.
2. Press the ENTER  button.
3. Press the ▲ or ▼ button to move the picture up or down.



4. Press the ENTER  button.
5. Press the ► button to select **Reset**.
6. Press the ENTER  button to reset the picture to its default position.

• After selecting **Screen Fit** in HDMI (1080i/1080p) or Component (1080i/1080p) mode, you may need to center the picture:

1. Press the ◀ or ▶ button to select **Position**.
2. Press the ENTER  button.
3. Press the ▲, ▼, ◀ or ▶ button to move the picture.
4. Press the ENTER  button.
5. Press the ◀ or ▶ button to select **Reset**.
6. Press the ENTER  button.

• HD (High Definition): 16:9 - 1080i/1080p (1920x1080), 720p (1280x720)

• Settings can be adjusted and stored for each external device you have connected to an input on the TV.

Input Source	Picture Size
ATV, AV, Component (480i, 480p)	16:9, Zoom1, Zoom2, 4:3
DTV(1080i), Component (1080i, 1080p), HDMI (720p, 1080i, 1080p)	16:9, 4:3, Wide Fit, Screen Fit
PC	16:9, 4:3

■ **Digital Noise Filter (Off / Low / Medium / High / Auto / Auto Visualization):** If the broadcast signal received by your TV is weak, you can activate the **Digital Noise Filter** feature to reduce any static and ghosting that may appear on the screen.

 When the signal is weak, try other options until the best picture is displayed.

Auto Visualization: When changing analog channels, displays signal strength.

 Only available for analog channels.

 When bar is green, is that the best possible signal.

■ **HDMI Black Level (Normal / Low):** Selects the black level on the screen to adjust the screen depth.

 Available only in HDMI mode.

■ **Film Mode (Off / Auto):** Sets the TV to automatically sense and process film signals from all sources and adjusts the picture for optimum quality.

 Available in TV, AV, COMPONENT (480i / 1080i) and HDMI (480i / 1080i).

■ **Screen Burn Protection:** To reduce the possibility of screen burn, this unit is equipped with screen burn prevention technology. The Time setting allows you to program the time between movement of the picture in minutes.

Pixel Shift (Off / On): Using this function, you can minutely move pixels on the PDP in horizontal or vertical direction to minimize after images on the screen.

 Optimum condition for pixel shift

	Item	TV/AV/Component/ HDMI/PC
Horizontal	0~4	4
Vertical	0~4	4
Time (minute)	1~4 min	4 min

 The **Pixel Shift** value may differ depending on the TV size (inches) and mode.

 This function is not available in the **Screen Fit** mode.

Auto Protection Time (10 min / 20 min / 40 min / 1 hour / Off): If the screen remains idle with a still image for a certain period of time defined by the user, the screen saver is activated to prevent the formation of ghost images on the screen.

Scrolling: This function removes after-images on the screen by moving all the pixels on the PDP according to a pattern. Use this function when there are remaining after-images or symbols on the screen, especially when you displayed a still image on the screen for a long time.

 The after-image removal function has to be executed for a long time (approximately 1 hour) to effectively remove after-images on the screen. If the after-image is not removed after performing the function, repeat the function again.

 Press any key on the remote control to cancel this feature.

Side Gray (Dark / Light): When you watch TV with the screen ratio set to 4:3, the screen is prevented from any damage by adjusting the white balance on both extreme left and right sides.

Picture Reset (Reset Picture Mode / Cancel)

Resets your current picture mode to its default settings.

Setting up the TV with your PC

Set the input source to PC.

 MENU  → **Picture** → ENTER 

Auto Adjustment

Adjust frequency values/positions and fine tune the settings automatically.

 Not available when connecting with an HDMI/DVI cable.

Screen

■ **Coarse / Fine:** Removes or reduces picture noise. If the noise is not removed by Fine-tuning alone, then adjust the frequency as best as possible (**Coarse**) and Fine-tune again. After the noise has been reduced, readjust the picture so that it is aligned to the center of screen.

■ **Position:** Adjust the PC's screen positioning if it does not fit the TV screen. Press the ▲ or ▼ button to adjust the Vertical-Position. Press the ◀ or ▶ button to adjust the Horizontal-Position.

■ **Image Reset:** Resets the image to default settings.

Using Your TV as a Computer (PC) Display

Setting Up Your PC Software (Based on Windows XP)

Depending on the version of Windows and the video card, the actual screens on your PC will probably look different, but the same basic set-up information will apply in most cases. (If not, contact your computer manufacturer or Samsung Dealer.)

1. Click on "Control Panel" on the Windows start menu.
2. Click on "Appearance and Themes" in the "Control Panel" window and a display dialog-box will appear.
3. Click on "Display" and a display dialog box will appear.
4. Navigate to the "Settings" tab on the display dialog-box.
 - The correct size setting (resolution) [Optimum: PN42C450: 1024 X 768 @ 60Hz, PN50C450: 1360 X 768 @ 60Hz]
 - If a vertical-frequency option exists on your display settings dialog box, the correct value is "60" or "60 Hz". Otherwise, just click "OK" and exit the dialog box.

Sound Menu

Changing the Preset Sound Mode

 MENU  → **Sound** → **Mode** → ENTER 



Mode

- **Standard:** Selects the normal sound mode.
- **Music:** Emphasizes music over voices.
- **Movie:** Provides the best sound for movies.
- **Clear Voice:** Emphasizes voices over other sounds.
- **Custom:** Increase the intensity of high-frequency sound to allow a better listening experience for the hearing impaired.



Basic Features

Adjusting Sound Settings

 MENU  → Sound → Equalizer → ENTER 

Equalizer

Adjusts the sound mode.

- **Balance L/R:** Adjusts the balance between the right and left speaker.
- **100Hz / 300Hz / 1kHz / 3kHz / 10kHz (Bandwidth Adjustment):** Adjusts the level of specific bandwidth frequencies.
- **Reset:** Resets the equalizer to its default settings.

Sound Settings

 MENU  → Sound → ENTER 

SRS TruSurround HD (Off / On)

This function provides a virtual 5.1 channel surround sound experience through a pair of speakers using HRTF (Head Related Transfer Function) technology.

Preferred Language

(digital channels only)

Digital-TV broadcasts are capable of simultaneous transmission of many audio tracks (for example, simultaneous translations of the program into foreign languages).

 You can only select a language among the ones being broadcasted.

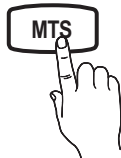

Multi-Track Sound (MTS)

(analog channels only)

- **Mono:** Choose for channels that are broadcasting in mono or if you are having difficulty receiving a stereo signal.
- **Stereo:** Choose for channels that are broadcasting in stereo.
- **SAP:** Choose to listen to the Separate Audio Program, which is usually a foreign-language translation.

 Depending on the particular program being broadcast, you can listen to **Mono**, **Stereo** or **SAP**.

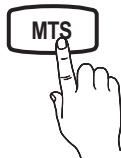



Auto Volume (Off / On)

Because each broadcasting station has its own signal conditions, the volume can vary as you switch between channels. This feature lets you automatically adjust the volume of the desired channel by lowering the sound output when the modulation signal is high or by raising the sound output when the modulation signal is low.

Speaker Select (External Speaker / TV Speaker)

A sound echo may occur due to a difference in decoding speed between the main speaker and the audio receiver. In this case, set the TV to **External Speaker**.

 When **Speaker Select** is set to **External Speaker**, the volume and **MUTE** buttons will not operate and the sound settings will be limited.

 When **Speaker Select** is set to **External Speaker**.

- **TV Speaker: Off, External Speaker: On**

 When **Speaker Select** is set to **TV Speaker**.

- **TV Speaker: On, External Speaker: On**

 If there is no video signal, both speakers will be mute.

Sound Reset (Reset All / Reset Sound Mode / Cancel)

- **Reset All:** Restore all sound settings to the factory defaults.
- **Reset Sound Mode:** Returns all sound values in the currently selected mode to the default settings.

Setup Menu

Setting the Time

 MENU  → Setup → Time → ENTER 

Time

- **Clock:** Setting the clock is for using various timer features of the TV.

 The current time will appear every time you press the **INFO** button.

 If you disconnect the power cord, you have to set the clock again.

Clock Mode (Auto / Manual)

- **Auto:** Set the current time automatically using the time from a digital channel.

 The antenna must be connected in order to set the time automatically.

- **Manual:** Set the current time manually.
 - ✎ Depending on the broadcast station and signal, the auto time set up may not be correct. In this case, set the time manually.

Clock Set: Set the **Month, Day, Year, Hour, Minute** and **am/pm** manually.

✎ Available only when **Clock Mode** is set to **Manual**.

✎ You can set the **Month, Day, Year, Hour** and **Minute** directly by pressing the number buttons on the remote control.

Time Zone: Select your time zone.



✎ This function is only available when the **Clock Mode** is set to **Auto**.

DST (Daylight Saving Time) (Off / On / Auto):

Switches the Daylight Saving Time function on or off.

✎ This function is only available when the **Clock Mode** is set to **Auto**.

Using the Sleep Timer

 MENU  → Setup → Time → Sleep Timer → ENTER 

- **Sleep Timer:** Automatically shuts off the TV after a preset period of time. (30, 60, 90, 120, 150 and 180 minutes).

✎ To cancel the **Sleep Timer**, select **Off**.



Setting the On / Off Timer

 MENU  → Setup → Time → Timer 1 → ENTER 

You can set the TV to turn on automatically at a preset time.

- **Timer 1 / Timer 2 / Timer 3:** Three different on / off timer settings can be made. You must set the clock first.

The screenshot shows the 'Timer 1' settings screen. It has a dark header with 'Timer 1' in white. Below the header, there are two rows for 'On Time' and 'Off Time'. Each row has a digital display showing '00', a '00' field, an 'am' field, and an 'Inactivate' button. Below these are 'Volume' (set to 20) and 'Contents' (set to TV, Cable, 3). At the bottom, there is a 'Repeat' section with 'Once' selected and a row of days (Sun, Mon, Tue, Wed, Thu, Fri, Sat) with checkboxes. At the very bottom, there are navigation buttons: Move, Adjust, Enter, and Return.

On Time / Off Time: Set the hour, minute, and activate / inactivate. (To activate the timer with the setting you've chosen, set to **Activate**.)

Volume: Set the desired volume level.

Contents: Select a folder in the USB device containing music or photo files to be played when the TV is turned on automatically.

✎ **NOTE**

- If there is no music file on the USB device or the folder containing a music file is not selected, the Timer function does not operate correctly.
- When there is only one photo file in the USB, the Slide Show will not play.
- If a folder name is too long, the folder cannot be selected.
- Each USB you use is assigned its own folder. When using more than one of the same type of USB, make sure the folders assigned to each USB have different names.

Repeat: Select **Once, Everyday, Mon~Fri, Mon~Sat, Sat~Sun** or **Manual** to set at your convenience. If you select **Manual**, you can set up the day you want to activate the timer.

✎ The ✓ mark indicates the day is selected.

✎ Auto Power Off (available only when the TV is turned on by the Timer): The TV will be automatically turned off after 3 hours of being left idle to prevent overheating.

Locking Programs

V-Chip

The **V-Chip** feature automatically locks out programs that are deemed inappropriate for children. The user must enter a PIN (personal identification number) before any of the V-Chip restrictions are set up or changed.

✎ **NOTE**

- **V-Chip** is not available in **HDMI, Component** or **PC** mode.
- The default PIN number of a new TV set is "0-0-0-0"
- **Allow All:** Press to unlock all TV ratings.
- **Block All:** Press to lock all TV ratings.
- **V-Chip Lock (Off / On):** You can block rated TV Programs.

TV Parental Guidelines: You can block TV programs depending on their rating. This function allows you to control what your children are watching.

- **TV-Y:** Young children / **TV-Y7:** Children 7 and over / **TV-G:** General audience / **TV-PG:** Parental guidance / **TV-14:** Viewers 14 and over / **TV-MA:** Mature audience
- **ALL:** Lock all TV ratings. / **FV:** Fantasy violence / **V:** Violence / **S:** Sexual situation / **L:** Adult Language / **D:** Sexually Suggestive Dialog

Basic Features

 The **V-Chip** will automatically block certain categories dealing with more sensitive material. For example, if you block the **TV-Y** category, then **TV-Y7** will automatically be blocked. Similarly, if you block the **TV-G** category, then all the categories in the young adult group will be blocked (**TV-G**, **TV-PG**, **TV-14** and **TV-MA**). The sub-ratings (**D**, **L**, **S**, **V**) work similarly. So, if you block the **L** sub-rating in **TV-PG**, then the **L** sub-ratings in **TV-14** and **TV-MA** will automatically be blocked.

MPAA Rating: You can block movies depending on their MPAA rating. The Motion Picture Association of America(MPAA) has implemented a rating system that provides parents or guardians with advanced information on which films are appropriate for children.

– **G:** General audience (no restrictions). / **PG:** Parental guidance suggested. / **PG-13:** Parents strongly cautioned. / **R:** Restricted. Children under 17 should be accompanied by an adult. / **NC-17:** No children under age 17. / **X:** Adults only. / **NR:** Not rated.

 The **V-Chip** will automatically block any category that deals with more sensitive material. For example, if you block the **PG-13** category, then **R**, **NC-17** and **X** will automatically be blocked.

Canadian English: You can block TV programs depending on their Anglophone Canadian ratings.

– **C:** Programming intended for children under age 8. / **C8+:** Programming generally considered acceptable for children 8 years and over to watch on their own. / **G:** General programming, suitable for all audiences. / **PG:** Parental Guidance. / **14+:** Programming contains themes or content which may not be suitable for viewers under the age of 14. / **18+:** Adult programming.

 The **V-Chip** will automatically block any category that deals with more sensitive material. For example, if you block the **G** category, then **PG**, **14+** and **18+** will automatically be blocked.

Canadian French: You can block TV programs depending on their Anglophone Canadian ratings.

– **G:** General / **8 ans+:** Programming generally considered acceptable for children 8 years and over to watch on their own. / **13 ans+:** Programming may not be suitable for children under the age of 13. / **16 ans+:** Programming is not suitable for children under the age of 16. / **18 ans+:** Programming restricted to adults.

 The **V-Chip** will automatically block any category that deals with more sensitive material. For example, if you block the **8 ans+** category, then **13 ans+**, **16 ans+** and **18 ans+** will automatically be blocked also.

Downloadable U.S. Rating: Parental restriction information can be used while watching DTV channels.

NOTE

- If information is not downloaded from the broadcasting station, the **Downloadable U.S. Rating** menu is deactivated.
- Parental restriction information is automatically downloaded while watching DTV channels. It may take several seconds.
- The **Downloadable U.S. Rating** menu is available for use after information is downloaded from the broadcasting station. However, depending on the information from the broadcasting station, it may not be available for use.
- Parental restriction levels differ depending on the broadcasting station. The default menu name and **Downloadable US Rating** change depending on the downloaded information.
- Even if you set the on-screen display to another language, the **Downloadable U.S. Rating** menu will appear in English only.
- The rating will automatically block certain categories that deal with more sensitive material.
- The rating titles (For example: Humor Level..etc) and TV ratings (For example: DH, MH, H..etc) may differ depending on the broadcasting station.

- **Change PIN:** The Change PIN screen will appear. Choose any 4 digits for your PIN and enter them. As soon as the 4 digits are entered, the **Confirm New PIN** screen appears. Re-enter the same 4 digits. When the Confirm screen disappears, your PIN has been memorized.



How to watch a restricted channel

If the TV is tuned to a restricted channel, the V-Chip will block it. The screen will go blank and the following message will appear:

This channel is blocked by V-Chip. Please enter the PIN to unblock.

 If you forget the PIN, press the remote-control buttons in the following sequence, which resets the pin to "0-0-0-0:" **POWER** (off) → **MUTE** → 8 → 2 → 4 → **POWER**(on)

Economical Solutions

 MENU  → Setup → ENTER 



The Eco Function can be used to enhance your power savings.

Energy Saving (Off / Low / Medium / High)

This adjusts the brightness of the TV in order to reduce power consumption. Until the screen turns on again, a distorted picture will be displayed for about 4 seconds.

Eco Sensor (Off / On)

Eco Sensor detects surrounding light intensity using an optical sensor and adjusts the screen's brightness.



- **Eco Sensor (Off / On):** Turns the sensor off or on.
 -  If you adjust the **Cell Light**, the **Eco Sensor** will be set to **Off**.
- **Min Cell Light:** Manually adjust the screen brightness (0~10).
 -  If **Eco Sensor** is **On**, the display brightness may change (become slightly darker or brighter) depending on the surrounding light intensity.

Other Features

 MENU  → Setup → ENTER 

Language

Set the menu language.

1. Select **Language** and press the ENTER  button.
2. Choose desired language and press the ENTER  button.

 Choose between **English**, **Español** and **Français**.

Game Mode (Off / On)

When connecting to a game console such as PlayStation™ or Xbox™, you can enjoy a more realistic gaming experience by selecting the game mode.

NOTE

- Precautions and limitations for game mode.
 - To disconnect the game console and connect another external device, set **Game Mode** to **Off** in the setup menu.
 - If you display the TV menu in **Game Mode**, the screen shakes slightly.
- **Game Mode** is not available when the input source is set to TV or PC.

- After connecting the game console, set **Game Mode** to **On**. Unfortunately, you may notice reduced picture quality.
- If **Game Mode** is **On**:
 - **Picture** mode is set to **Standard** and **Sound** mode is set to **Movie**.
 - **Equalizer** is not available.

Caption

(On-Screen Text Messages)

- **Caption (Off / On):** You can switch the caption function on or off. If captions are not available, they will not be displayed on the screen.



 The Caption feature doesn't work in Component, HDMI or PC modes.

- **Caption Mode:** You can select the desired caption mode.

 The availability of captions depends on the program being broadcast.

Default / CC1~CC4 / Text1~Text4: (analog channels only) The Analog Caption function operates in either analog TV channel mode or when a signal is supplied from an external device to the TV. (Depending on the broadcasting signal, the Analog Caption function may not work with digital channels.)

Default / Service1~Service6 / CC1~CC4 / Text1~Text4: (digital channels only) The Digital Captions function works with digital channels.

 **Service1~6** may not be available in digital caption mode depending on the broadcast.

- **Digital Caption Options:** (digital channels only)

Size: Options include Default, Small, Standard and Large. The default is Standard.

Font Style: Options include Default and Styles 0 to 7. The default is Style 0.

Foreground Color: Options include Default, White, Black, Red, Green, Blue, Yellow, Magenta and Cyan. You can change the color of the letter. The default is White.

Background Color: This adjusts the opacity of text. Options include of Default, White, Black, Red, Green, Blue, Yellow, Magenta and Cyan. You can change the background color of the caption. The default is Black.

Foreground Opacity: Options include Default, Transparent, Translucent, Solid and Flashing.

Background Opacity: This adjusts the opacity of the caption background. Options include Default, Transparent, Translucent, Solid and Flashing.

Return to Default: This option sets each Size, Font Style, Foreground Color, Background Color, Foreground Opacity and Background Opacity to its default.

Basic Features

NOTE

- **Digital Caption Options** are available only when **Default** and **Service1 ~ Service6** can be selected in Caption Mode.
- The availability of captions depends on the program being broadcasted.
- The **Default** setting follows the standards set by the broadcaster.
- The **Foreground** and **Background** cannot be set to have the same color.
- You cannot set both the **Foreground Opacity** and the **Background Opacity** to **Transparent**.

Melody (Off / Low / Medium / High)

Set so that a melody plays when the TV is turned on or off.

The **Melody** does not play.

- When no sound is output from the TV because the **MUTE** button has been pressed.
- When no sound is output from the TV because the volume has been reduced to minimum with the **VOL** – button.
- When the TV is turned off by **Sleep Timer** function.

Support Menu



MENU → **Support** → ENTER

Self Diagnosis

Self Diagnostic might take few seconds, this is part of the normal operation of the TV.

- **Picture Test (Yes / No):** Use to check for picture problems.

Yes: If the test pattern does not appear or there is noise in the test pattern, select Yes. There may be a problem with the TV. Contact Samsung's Call Center for assistance (1-800-SAMSUNG).

No: If the test pattern is properly displayed, select No. There may be a problem with your external equipment. Please check your connections. If the problem persists, refer to the external device's user manual.

- **Sound Test (Yes / No):** Use the built-in melody sound to check for sound problems.

If you hear no sound from the TV's speakers, before performing the sound test, make sure **Speaker Select** is set to **TV Speaker** in the **Sound** menu.

The melody will be heard during the test even if **Speaker Select** is set to **External Speaker** or the sound is muted by pressing the **MUTE** button.

Yes: If you can hear sound only from one speaker or not at all during the sound test, select Yes. There may be a problem with the TV. Contact Samsung's Call Center for assistance (1-800-SAMSUNG).

No: If you can hear sound from the speakers, select No. There may be a problem with your external equipment. Please check your connections. If the problem persists, refer to the external device's user manual.

- **Signal Strength:** (Digital channels only) An HD channel's reception quality is either perfect or the channels are unavailable. Adjust your antenna to increase signal strength.

Software Upgrade

Samsung may offer upgrades for your TV's firmware in the future. Please visit Samsung.com or contact the Samsung call center at 1-800-SAMSUNG (726-7864) to receive information about downloading upgrades and using a USB drive. Upgrades will be possible by connecting a USB drive to the USB port.

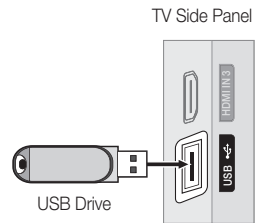

When software is upgraded, video and audio settings you have made will return to their default (factory) settings.

We recommend you write down your settings so that you can easily reset them after the upgrade.

HD Connection Guide

Refer to this information when connecting external devices to the TV.



Contact Samsung

View this information when your TV does not work properly or when you want to upgrade the software. You can find information regarding our call centers and how to download products and software.

Media Play

Enjoy photos and/or music files saved on a USB Mass Storage Class (MSC) device.



MENU  → Application → Media Play (USB) → ENTER 

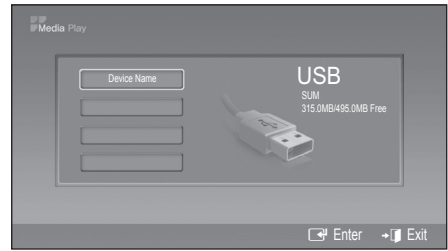





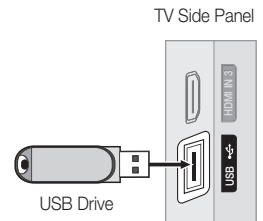

Connecting a USB Device

1. Turn on your TV.
2. Connect a USB device containing photo and/or music files to the **USB** jack on the side of the TV.
3. When the **Input** selection screen is displayed, press the **▶** button to select **Media Play (USB)**, then press the **ENTER**  button.



Using the Media Play Menu

Viewing a Photo (or Slide Show)

1. Press the **MENU** button. Press the **▲** or **▼** button to select **Input**, then press the **ENTER**  button.
2. Press the **▲** or **▼** button to select **Media Play (USB)**, then press the **ENTER**  button.
3. Press the **▲** or **▼** button to select the corresponding USB Memory Device, then press the **ENTER**  button.
 -  The Media Play menu differs depending on the USB Memory Device connected to TV.
 -  Some devices may not be supported due to compatibility problems.
4. Press the **◀** or **▶** button to select an icon (**Photo**, **Music**, **Setup**), then press the **ENTER**  button.

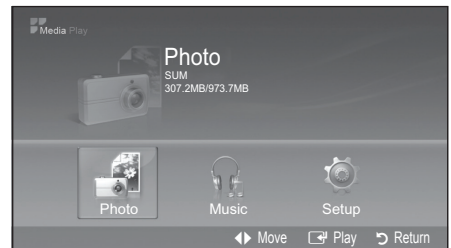

 It might not work properly with unlicensed multimedia files.

Need-to-Know List before using **Media Play (USB)**

- Only alphanumeric characters must be used as a folder name or file name (photo, music).
- The file system only supports FAT16/32 (The NTFS file system is not supported) Certain types of USB Digital camera and audio devices may not be compatible with this TV.
- Media Play (USB) only supports the USB Mass Storage Class device (MSC). MSC is a Mass Storage Class Bulk-Only Transport device. Examples of MSC are Thumb drives and Flash Card Readers (Both USB and HUB are not supported.)
- Before connecting your device to the TV, please back up your files to prevent them from damage or loss of data. SAMSUNG is not responsible for any data file damage or data loss.
- Please connect directly to the **USB** port of your TV. If you are using a separate cable connection, there may be a USB Compatibility problem.

Advanced Features

- Only MP3 and JPEG file formats are supported.
- The Media Play (USB) mp3 format only supports music files with a high sampling frequency (32 kHz, 44.1 kHz, or 48 kHz).
- We recommend the sequential jpeg format.
- Do not disconnect the USB device while it is loading.
- MSC supports MP3 and JPEG files, and the PTP device supports JPEG files only.
- MTP (Media Transfer Protocol) is not supported.
- The playing duration of an mp3 file may be displayed as “00:00:00” if its playing time information is not found at the start of the file.
- The higher the resolution of the image, the longer it takes to display on the screen.
- The Photo or Music List displays up to 300 folders or files.
- Loading may take some time depending on the size of the file.
- MP3 files with DRM that have been downloaded from a non-free site cannot be played.
- Digital Rights Management (DRM) is a technology that supports the creation, distribution and management of the content in an integrated and comprehensive way, including the protection of the rights and interests of the content providers, the prevention of the illegal copying of contents, as well as managing billings and settlements.
- The power-saving mode of some external hard disk drives may be released automatically when connected to the TV.
- If a USB extension cable is used, the USB device may not be recognized or the files on the device may not be read.
- If a USB device connected to the TV is not recognized, the list of files on the device is corrupted or a file in the list is not played, connect the USB device to the PC, format the device and check the connection.
- If a file deleted from the PC is still found when Media Play is run, use the “Empty the Recycle Bin” function on the PC to permanently delete the file.

Photo



Viewing a Photo (or Slide Show)



1. Press the INFO button to display the option **View, Start Slide Show, Delete, Delete All, Deselect All**.

2. Press the ▲ or ▼ button to select **Start Slide Show** then press the ENTER  button.

 During the slide show, files are displayed in order from the currently shown file.

 MP3 files can be automatically played during the Slide Show if the Default **Background Music** is set to **On**. To enable this function, MP3 files and other photo files must be located in the same folder on the USB Memory Device.

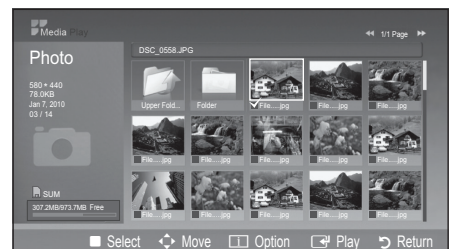

-  Press the INFO button during the slide show to set the following options **Slide Show Speed, Background Music, Background Music Setting, List**. Press the ▲ or ▼ button to select the option, then press the ENTER  button.
- After setting the option press the ENTER  button to make a change.

-  Press the INFO button during the photo view to set the following options **Start Slide Show, Zoom, Rotate, List**. Press the ▲ or ▼ button to select the option, then press the ENTER  button.
- After setting the option press the ENTER  button to make a change.



Music

Using the MP3 List



	Folder icon
	Music list icon
	Move to the previous folder stage icon

 Press the  (REW) or  (FF) buttons to change pages.

 The selected file is displayed on the top with its playing time.

1. To select all files or a file, press the **INFO** button to display the **Music** menus.

Press the **ENTER**  button to select **Play** (or **Play the Selected Files**), **Repeat Music**, **Delete** (or **Delete Selected File**), **Delete All** or **Deselect All**.

2. Press the  or  button to move to an icon, then press the **ENTER**  button.

Pressing the **ENTER**  button over a musical note icon immediately plays the music file.

Pressing the **ENTER**  button over a folder icon shows the music files included in the folder.

- **Play:** Select to play MP3 files.







 This menu only shows files with the MP3 extension. Files with other file extensions are not displayed, even if they are saved on the same USB device.

 To adjust the music volume, press the **-VOL+** button on the remote control. To mute the sound, press the **MUTE** button on the remote control.

- **Repeat Music (On / Off):** Select to repeatedly play MP3 files in the current folder.

Playing Music

- Only displays files with the MP3 file extension. Other file extensions are not displayed, even if they are saved on the same USB device.
- If the sound is strange when playing MP3 files, adjust the **Equalizer** and **SRS TruSurround HD** in the **Sound** menu. (An over-modulated MP3 file may cause a sound problem.)
- Music function information icons

	Repeat Music is On.
	Repeat Music is Off.
	When pressing the  (Play) /  (Pause) button on the remote control while music is playing.
	When pressing the  (Stop) button on the remote control, the music stops.

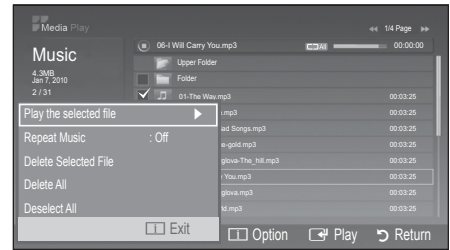
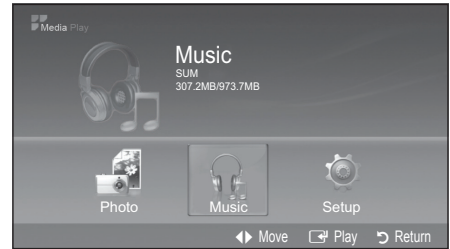

Advanced Features

Setup

Using the Setup Menu

- **Slide Show speed:** Select to control the slide show speed. You can select **Fast**, **Normal** or **Slow**.
- **Background Music:** Select to determine whether to play an MP3 file during a slide show. You can select **Music On** or **Music Off**.
- **Background Music Setting:** While a slide show is in progress, use the **Background Music Setting** to select a music file to listen to. Select an MP3 file as the background music.
- **Repeat Music:** Select to determine whether to repeat playing the music when all MP3 files in the current folder have been played.
- **Screen Saver:** Select to set the waiting time before the screen saver appears. The screensaver will appear when no button is pressed for **10 min**, **20 min**, **40 min**, **1 hour** or **Off**.
- **Safe Remove:** You can remove the device safely from the TV.



Playing the selected photos / music files

1. Press the Yellow button.
2. Repeat the above operation to select desired photos / music files.
Selected photos or files are marked with the symbol ✓. To cancel a selection, press the Yellow button again.
3. Press the (Play) / ENTER button to play the selected photos or files.

Anynet+

What is Anynet+?

Anynet+ is a function that enables you to control all connected Samsung devices that support Anynet+ with your Samsung TV's remote. The Anynet+ system can be used only with Samsung devices that have the Anynet+ feature. To be sure your Samsung device has this feature, check if there is an Anynet+ logo on it.

To connect to a Samsung Home Theater

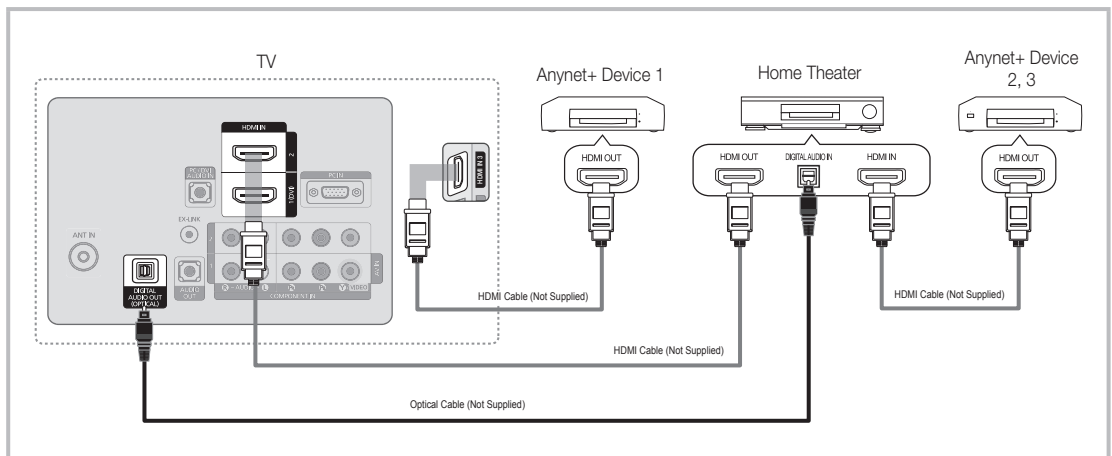

1. Connect the **HDMI IN (1(DVI), 2, 3)** jack on the TV and the **HDMI OUT** jack of the corresponding Anynet+ device using an HDMI cable.
2. Connect the **HDMI IN** jack of the home theater and the **HDMI OUT** jack of the corresponding Anynet+ device using an HDMI cable.

 **NOTE**

- Connect the Optical cable between the **DIGITAL AUDIO OUT (OPTICAL)** jack on your TV and the Digital Audio Input on the Home Theater.
- When following the connection above, the Optical jack only outputs 2 channel audio. You will only hear sound from the Home Theater's Front, Left and Right speakers and the subwoofer. If you want to hear 5.1 channel audio, connect the **DIGITAL AUDIO OUT (OPTICAL)** jack on the DVD / Satellite Box (i.e. Anynet+ Device 1 or 2) directly to the Amplifier or Home Theater, not the TV.
- You can connect only one Home Theater.
- You can connect an Anynet+ device using the HDMI cable. Some HDMI cables may not support Anynet+ functions.
- Anynet+ works when the AV device supporting Anynet+ is in the standby or on status.
- Anynet+ supports up to 12 AV devices in total. Note that you can connect up to 3 devices of the same type.

Anynet+ Menu

The Anynet+ menu changes depending on the type and status of the Anynet+ devices connected to the TV.

Anynet+ Menu	Description
View TV	Changes Anynet+ mode to TV broadcast mode.
Device List	Shows the Anynet+ device list.
(device_name) MENU	Shows the connected device menus. E.g. If a DVD recorder is connected, the disc menu of the DVD recorder will appear.
(device_name) INFO	Shows the play menu of the connected device. E.g. If a DVD recorder is connected, the play menu of the DVD recorder will appear.
Recording: (*recorder)	Starts recording immediately using the recorder. (This is only available for devices that support the recording function.)
Stop Recording: (*recorder)	Stops recording.
Receiver	Sound is played through the receiver.

If more than one recording device is connected, they are displayed as (*recorder) and if only one recording device is connected, it will be represented as (*device_name).

Setting Up Anynet+

MENU  → Application → Anynet+ (HDMI-CEC) → ENTER 

Setup

Anynet+ (HDMI-CEC) (Off / On): To use the Anynet+ Function, **Anynet+ (HDMI-CEC)** must be set to **On**.

 When the **Anynet+ (HDMI-CEC)** function is disabled, all the Anynet+ related operations are deactivated.



Auto Turn Off (No / Yes): Setting an Anynet+ Device to turn off automatically when the TV is turned off.

 If **Auto Turn Off** is set to **Yes**, running external devices will turn off at the same time as the TV powers off. However, a device may not turn off if recording is in progress.

 May not be enabled depending on the device.







Advanced Features

Switching between Anynet+ Devices

1. Anynet+ devices connected to the TV are listed.
 -  If you cannot find a device you want, press the Red button to refresh the list.
2. Select a device and press the **ENTER**  button. You can switch to the selected device.
 -  The **Device List** menu will only appear when you set **Anynet+ (HDMI-CEC)** to **On** in the **Application** menu.
 - Switching to the selected device may take up to 2 minutes. You cannot cancel the operation during the switching operation.
 - If you have selected external input mode by pressing the **SOURCE** button, you cannot use the Anynet+ function. Make sure to switch to an Anynet+ device by using the **Device List**.



Recording

You can make a recording of a TV Program using a Samsung recorder.

1. Select **Recording**.
 -  When there are more than two recording devices
 - When multiple recording devices are connected, the recording devices are listed. Select one recording device in the **Device List**.
 -  When the recording device is not displayed, select **Device List** and press the Red button to search devices.
2. Press the **EXIT** button to exit.
 -  You can record the source streams by selecting **Recording**: (device_name).
 -  Pressing the  (REC) button will record whatever you are currently watching. If you are watching video from another device, the video from the device is recorded.
 -  Before recording, check whether the antenna jack is properly connected to the recording device. To properly connect an antenna to a recording device, refer to the recording device's users manual.

Listening through a Receiver

You can listen to sound through a receiver (i.e Home Theater) instead of the **TV Speaker**.

1. Select **Receiver** and set to **On**.
2. Press the **EXIT** button to exit.
 -  If your receiver supports audio only, it may not appear in the device list.
 -  The receiver will work when you have properly connected the optical in jack of the receiver to the **DIGITAL AUDIO OUT (OPTICAL)** jack of the TV.
 -  When the receiver (i.e Home Theater) is set to On, you can hear sound output from the TV's Optical jack. When the TV is displaying a DTV (air) signal, the TV will send out 5.1 channel sound to the receiver. When the source is a digital component such as a DVD and is connected to the TV via HDMI, only 2 channel sound will be heard from the receiver.

NOTE

- You can only control Anynet+ devices using the TV remote control, not the buttons on the TV.
- The TV remote control may not work under certain conditions. If this occurs, reselect the Anynet+ device.
- The Anynet+ functions do not operate with other manufacturers' products.

Troubleshooting for Anynet+

Problem	Possible Solution
Anynet+ does not work.	<ul style="list-style-type: none"> • Check if the device is an Anynet+ device. The Anynet+ system supports Anynet+ devices only. • Only one receiver (home theater) can be connected. • Check if the Anynet+ device power cord is properly connected. • Check the Anynet+ device's Video/Audio/HDMI cable connections. • Check whether Anynet+ (HDMI-CEC) is set to On in the Anynet+ setup menu. • Check whether the TV remote control is in TV mode. • Check whether the remote control is Anynet+ compatible. • Anynet+ doesn't work in certain situations. (Searching channels, operating Media Play (USB) or Plug & Play (initial setup), etc.) • When connecting or removing the HDMI cable, please make sure to search devices again or turn your TV off and on again. • Check if the Anynet+ Function of Anynet+ device is set on.
I want to start Anynet+.	<ul style="list-style-type: none"> • Check if the Anynet+ device is properly connected to the TV and check if the Anynet+ (HDMI-CEC) is set to On in the Anynet+ Setup menu. • Press the TOOLS button to display the Anynet+ menu and select a menu you want.
I want to exit Anynet+.	<ul style="list-style-type: none"> • Select View TV in the Anynet+ menu. • Press the SOURCE button on the TV remote control and select a non- Anynet+ device. • Press ▼ CH ▲, PRE-CH, and FAV.CH to change the TV mode. (Note that the channel button operates only when a tuner-embedded Anynet+ device is not connected.)
The message "Connecting to Anynet+ device..." appears on the screen.	<ul style="list-style-type: none"> • You cannot use the remote control when you are configuring Anynet+ or switching to a view mode. • Use the remote control when the Anynet+ setting or switching to view mode is complete.
The Anynet+ device does not play.	<ul style="list-style-type: none"> • You cannot use the play function when Plug & Play (initial setup) is in progress.
The connected device is not displayed.	<ul style="list-style-type: none"> • Check whether or not the device supports Anynet+ functions. • Check whether or not the HDMI cable is properly connected. • Check whether Anynet+ (HDMI-CEC) is set to On in the Anynet+ setup menu. • Search Anynet+ devices again. • You can connect an Anynet+ device using the HDMI cable only. Some HDMI cables may not support Anynet+ functions. • If connection is terminated because there has been a power interruption or the HDMI cable has been disconnected, please repeat the device scan.
The TV Program cannot be recorded.	<ul style="list-style-type: none"> • Check whether the antenna jack on the recording device is properly connected.
The TV sound is not output through the receiver.	<ul style="list-style-type: none"> • Connect the optical cable between TV and the receiver.

Other Information

Installing the Wall Mount

Attaching the Blanking Bracket

When installing the TV onto a wall, attach the Blanking Bracket as shown.

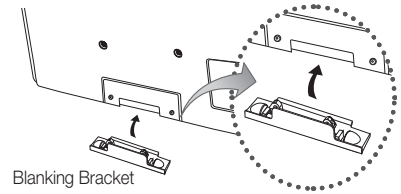

Installing the Wall Mount Kit

The wall mount kit (sold separately) allows you to mount the TV on the wall.

For detailed information on installing the wall mount, see the instructions provided with the wall mount. Contact a technician for assistance when installing the wall mount bracket.

Samsung Electronics is not responsible for any damage to the product or injury to yourself or others if you elect to install the TV on your own.

Wall Mount Kit Specifications (VESA)

 The wall mount kit is not supplied, but sold separately.

Install your wall mount on a solid wall perpendicular to the floor. When attaching to other building materials, please contact your nearest dealer. If installed on a ceiling or slanted wall, it may fall and result in severe personal injury.

NOTE

- Standard dimensions for wall mount kits are shown in the table below.
- When purchasing our wall mount kit, a detailed installation manual and all parts necessary for assembly are provided.
- Do not use screws that do not comply with the VESA standard screw specifications.
- Do not use screws that are longer than the standard dimension or do not comply with the VESA standard screw specifications. Screws that are too long may cause damage to the inside of the TV set.
- For wall mounts that do not comply with the VESA standard screw specifications, the length of the screws may differ depending on the wall mount specifications.
- Do not fasten the screws too strongly; this may damage the product or cause the product to fall, leading to personal injury. Samsung is not liable for these kinds of accidents.
- Samsung is not liable for product damage or personal injury when a non-VESA or non-specified wall mount is used or the consumer fails to follow the product installation instructions.
- Do not mount the TV at more than a 15 degree tilt.
- Always use two people to mount the TV to a wall.

Product Family	inches	VESA Spec. (A * B)	Standard Screw	Quantity
PDP TV	42~50	400 X 400	M8	4
	58~63	600 X 400		
	70~79	800 X 400		
	80~	1400 X 800		

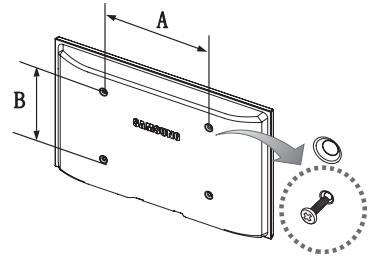

Unscrew the hole around before installing Wall-Mount on the wall.

Do not install your Wall Mount Kit while your TV is turned on. It may result in personal injury due to electric shock.

Securing the Installation Space

Keep the required distances between the product and other objects (e.g. walls) to ensure proper ventilation. Failing to do so may result in fire or a problem with the product due to an increase in the internal temperature of the product.

- When using a stand or wall-mount, use parts provided by Samsung Electronics only.
 - If you use parts provided by another manufacturer, it may result in a problem with the product or an injury due to the product falling.
- The appearance may differ depending on the product.
- Be careful when you contact the TV because some parts can be somewhat hot.

Installation with a stand.
Installation with a wall-mount.

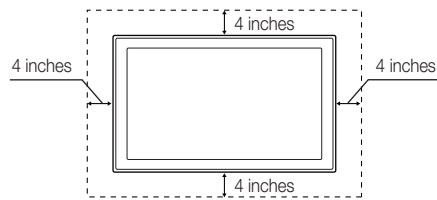
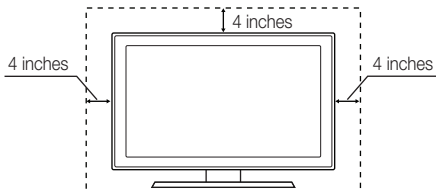

Other Information

Securing the TV to the Wall



Caution: Pulling, pushing, or climbing on the TV may cause the TV to fall. In particular, ensure your children do not hang over or destabilize the TV. Doing so may cause the TV to tip over, causing serious injuries or death. Follow all safety precautions provided in the included Safety Flyer with your TV. For added stability and safety, you can purchase and install the anti fall device as described below.

The TV-Holder Kit (Sold Separately):

The parts below are included in the TV Holder kit. In addition, you need to provide a wood screw, screw and molly, or other screw appropriate for the wall or cabinet you intend to secure the TV-Holder string to. We recommend a size M4xL20 wood screw.



TV-Holder (BN96-15753A)







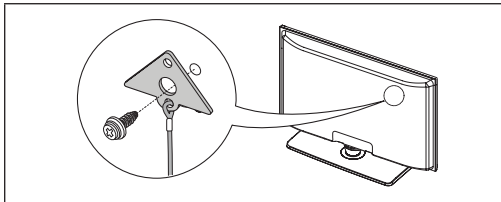

Screw (M8 x L19)

Installing the TV-Holder

1. Remove the screw attached to the back of your TV, and then connect the TV-Holder to the TV with the screw included in the TV-Holder Kit that is designated for your TV.

 Make sure to use only the appropriate supplied screw. If you use a different screw, you can damage your TV.



2. Firmly fasten the screw you provided (size M4xL20 or similar) to the wall or cabinet where the TV is to be installed.
 If you fasten the screw to the wall, we recommend you drive the screw into a stud. If that is not possible, use a molly to anchor the screw.
3. Tie the TV-Holder cord to the screw fastened on the wall or cabinet so that the TV is fixed. See the illustrations below.
 Install the TV close to the wall so that it does not fall.
 When attaching the TV-Holder cord to the wall, tie the cord level with the ground or slanted downwards for safety purposes.
 Check the cord occasionally to make sure it is secure.
 Before moving the TV, separate the connected cord first.

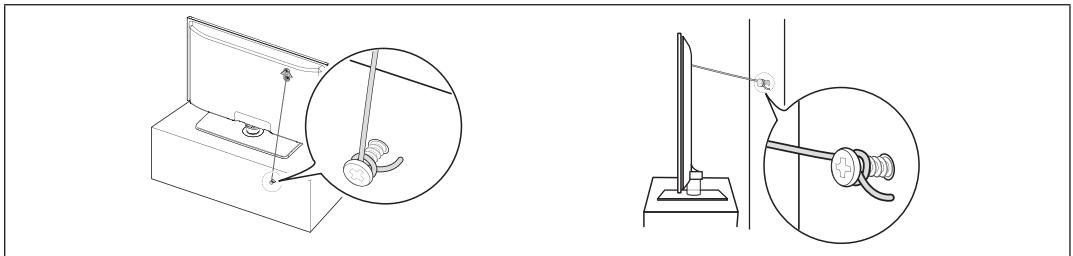

4. Verify all connections are properly secured. Periodically check the connections for any sign of fatigue or failure. If you have any doubt about the security of your connections, contact a professional installer.

To purchase the TV-Holder Kit, contact Samsung Customer Care

- In the United States: 1-800-SAMSUNG (1-800-726-7864)
- In Canada: 1-800-SAMSUNG (1-800-726-7864)

Troubleshooting

If the TV seems to have a problem, first try this list of possible problems and solutions. If none of these troubleshooting tips apply, visit “www.samsung.com,” then click on Support, or call Samsung customer service at 1-800-SAMSUNG.

Issues	Solutions and Explanations
Poor picture	First of all, please perform the Picture Test and confirm that your TV is properly displaying the test image. (go to MENU - Support - Self Diagnosis - Picture Test) (p. 22) If the test image is properly displayed, the poor picture may be caused by the source or signal.
The TV image does not look as good as it did in the store.	<ul style="list-style-type: none"> • If you have an analog cable/satellite box, upgrade to an HD digital set top box. Use HDMI or Component cables to deliver HD (high definition) picture quality. • Cable/Satellite subscribers: Try HD stations from the channel line up. • Antenna connection: Try HD stations after performing Auto program. <ul style="list-style-type: none"> 🔧 Many HD channels are up scaled from SD (Standard Definition) contents. • Adjust the Cable/Sat box video output resolution to 1080i or 720p.
The picture is distorted: macro block error, small block, dots, pixelization.	<ul style="list-style-type: none"> • Compression of video contents may cause picture distortion, especially in fast moving pictures such as sports and action movies. • Low signal level can cause picture distortion. This is not a TV problem. • Mobile phones used close to the TV (up to 3.3 ft) may cause noise in picture on analog and digital TV.
Color is wrong or missing.	<ul style="list-style-type: none"> • If you're using Component connection, make sure the component cables are connected to the correct jacks. Incorrect or loose connections may cause color problems or a blank screen.
There is poor color or brightness.	<ul style="list-style-type: none"> • Adjust the Picture options in the TV menu. (go to Picture mode / Color / Brightness / Sharpness) (p. 15) • Adjust Energy Saving option in the Setup menu (p. 21) • Try resetting the picture to view the default picture settings. (go to MENU - Picture - Picture Reset) (p. 17)
There is a dotted line on the edge of the screen.	<ul style="list-style-type: none"> • If the picture size is set to Screen Fit, change it to 16:9 (p. 16). • Change cable/satellite box resolution.
The picture is black and white.	<ul style="list-style-type: none"> • If you are using an AV composite input, connect the video cable (yellow) to the Green jack of component input 1 on the TV.
When changing channels, the picture freezes or is distorted or delayed.	<ul style="list-style-type: none"> • If connected to a cable box, please try to reset it. (reconnect the AC cord and wait until the cable box reboots. It may take up to 20 minutes) • Set the output resolution of the cable box to 1080i or 720p.
Sound Problem	First of all, please perform the Sound Test to confirm that your TV audio is properly operating. (go to MENU - Support - Self Diagnosis - Sound Test) (p. 22) If the audio is OK, the sound problem may be caused by the source or signal.
There is no sound or the sound is too low at maximum volume.	<ul style="list-style-type: none"> • Please check the volume of the device (Cable/Sat Box, DVD, Blu-ray etc) connected to your TV.
The picture is good but there is no sound.	<ul style="list-style-type: none"> • Set the Speaker Select option to TV Speaker in the Sound menu (p. 18). • If you are using an external device, make sure the audio cables are connected to the correct audio input jacks on the TV. • If you are using an external device, check the device's audio output option (ex. you may need to change your cable box's audio option to HDMI when you have a HDMI connected to your TV). • If you are using a DVI to HDMI cable, a separate audio cable is required. • If your TV has a headphone jack, make sure there is nothing plugged into it. • Reboot the connected device by reconnecting the device's power cable.
The speakers are making an inappropriate noise.	<ul style="list-style-type: none"> • Check cable connections. Make sure a video cable is not connected to an audio input. • For antenna or Cable connections, check the signal strength. Low signal level may cause sound distortion. • Perform the Sound Test as explained above.

Other Information

Issues	Solutions and Explanations
No Picture, No Video	
The TV won't turn on.	<ul style="list-style-type: none"> • Make sure the AC power cord is securely plugged in to the wall outlet and the TV. • Make sure the wall outlet is working. • Try pressing the POWER button on the TV to make sure the problem is not the remote. If the TV turns on, refer to "Remote control does not work" below.
The TV turns off automatically.	<ul style="list-style-type: none"> • Ensure the Sleep Timer is set to Off in the Setup menu (p. 19). • If your PC is connected to the TV, check your PC power settings. • Make sure the AC power cord is plugged in securely to the wall outlet and the TV. • When watching TV from an antenna or cable connection, the TV will turn off after 10 - 15 minutes if there is no signal.
There is no picture/video.	<ul style="list-style-type: none"> • Check cable connections (remove and reconnect all cables connected to the TV and external devices). • Set your external device's (Cable/Sat Box, DVD, Blu-ray etc) video outputs to match the connections to the TV input. For example, if an external device's output is HDMI, it should be connected to an HDMI input on the TV. • Make sure your connected devices are powered on. • Be sure to select the TV's correct source by pressing the SOURCE button on the remote control. • Reboot the connected device by reconnecting the device's power cable.
RF(Cable/Antenna) Connection	
The TV is not receiving all channels.	<ul style="list-style-type: none"> • Make sure the coaxial cable is connected securely. • Please try Auto Program to add available channels to the channel list. Go to MENU - Channel - Auto Program then select Auto and make sure the correct Cable TV signal type is set in the menu. There are 3 options (STD, HRC and IRC) (p. 13). • Verify the Antenna is positioned correctly.
No Caption on digital channels.	<ul style="list-style-type: none"> • Check Caption Setup menu. Try changing Caption Mode Service1 to CC1 (p. 21). • Some channels may not have caption data.
The picture is distorted: macro block error, small block, dots, pixelization.	<ul style="list-style-type: none"> • Compression of video contents may cause picture distortion, especially with fast moving pictures such as sports and action movies. • A low signal can cause picture distortion. This is not a TV problem.
PC Connection	
A "Mode Not Supported" message appears.	<ul style="list-style-type: none"> • Set your PC's output resolution so it match the resolutions supported by the TV (p. 11).
"PC" is always shown on the source list, even if a PC is not connected.	<ul style="list-style-type: none"> • This is normal; "PC" is always shown on the source list, regardless of whether a PC is connected.
The video is OK but there is no audio.	<ul style="list-style-type: none"> • If you are using an HDMI connection, check the audio output setting on your PC.
Others	
Purple/green rolling horizontal bars and buzzing noise from the TV speakers with Component cable connection.	<ul style="list-style-type: none"> • Remove the left and right audio connections from the set-top-box. If the buzzing stops, this indicates that the set-top-box has a grounding issue. Replace the Component video cables with an HDMI connection.
The picture won't display in full screen.	<ul style="list-style-type: none"> • HD channels will have black bars on either side of the screen when displaying up scaled SD (4:3) contents. • Black bars on the Top & Bottom will be shown on movies that have aspect ratios different from your TV. • Adjust the picture size options on your external device or TV to full screen.
The remote control does not work.	<ul style="list-style-type: none"> • Replace the remote control batteries with the poles (+/-) in the right direction. • Clean the sensor's transmission window on the remote. • Try pointing the remote directly at the TV from 5-6 feet away.
The TV is making a humming noise.	<ul style="list-style-type: none"> • Plasma TVs typically make a soft humming sound. This is normal. It's caused by the electrical charges that are used to create the images on the screen. • If the humming sound is loud, you may have set the brightness on the TV too high. Try setting the brightness lower. • You can also have loud humming if the back of your Plasma TV is too close to a wall or other hard surface. Also try rerouting your connection cables. • Improper installation of wall mount can create excessive noise.

Issues	Solutions and Explanations
Image Retention (Burn In) Issue.	<ul style="list-style-type: none"> To minimize the possibility of screen burn, this unit is equipped with screen burn reduction technology. Pixel Shift technology enables you to set picture movement up/down (Vertical Line) and side to side (Horizontal Dot).
The cable/set top box remote control doesn't turn the TV on or off, or adjust the volume.	<ul style="list-style-type: none"> Program the Cable/Set remote control to operate the TV. Refer to the Cable/Set user manual for the SAMSUNG TV code.
A "Mode Not Supported" message appears.	<ul style="list-style-type: none"> Check the supported resolution of the TV, and adjust the external device's output resolution accordingly. Refer to the resolution settings on page 11 of this manual.
Caption on TV menu is greyed out.	<ul style="list-style-type: none"> Caption can not be selected in the TV menu when connected via HDMI or Component (p. 21). Caption must be activated on the external device (p. 21).
There is a plastic smell from the TV.	<ul style="list-style-type: none"> This smell is normal and will dissipate over time.
The TV Signal Strength is unavailable in the Self Diagnostic Test menu.	<ul style="list-style-type: none"> This function is only available with digital channels from an Antenna / RF/Coax connection (p. 22).
The TV is tilted to the side.	<ul style="list-style-type: none"> Remove the base stand from the TV and reassemble it.
The channel menu is greyed out (unavailable).	<ul style="list-style-type: none"> The Channel menu is only available when the TV source is selected.
Your settings are lost after 30 minutes or every time the TV is turned off.	<ul style="list-style-type: none"> If the TV is in the Store Demo mode, it will reset audio and picture settings every 30 minutes. Change the settings from Store Demo mode to Home Use mode in the Plug & Play procedure. Press the SOURCE button to select TV mode, and go to MENU → Setup → Plug & Play → ENTER  (p. 8).
You have intermittent loss of audio or video.	<ul style="list-style-type: none"> Check the cable connections and reconnect them. Loss of audio or video can be caused by using overly rigid or thick cables. Make sure the cables are flexible enough for long term use. If mounting the TV to a wall, we recommend using cables with 90 degree connectors.
You see small particles when you look closely at the edge of the frame of the TV.	<ul style="list-style-type: none"> This is part of the product's design and is not a defect.
POP (TV's internal banner ad) appears on the screen.	<ul style="list-style-type: none"> Select Home Use under Plug & Play mode. For details, refer to Plug & Play Feature (p. 8).

 Some of above pictures and functions are available at specific models only.

Storage and Maintenance

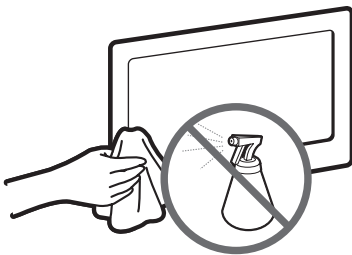

Do not spray water or a cleaning agent directly onto the product. Any liquid that goes into the product may cause a failure, fire, or electric shock.

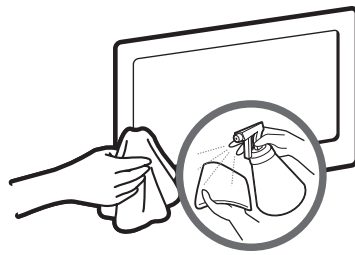

Clean the product with a soft cloth dipped in a small amount of water.

Other Information

License



TruSurround HD, SRS and  symbol are trademarks of SRS Labs, Inc.
TruSurround HD technology is incorporated under license from SRS Labs, Inc.



Manufactured under license from Dolby Laboratories. Dolby and the double-D symbol are trademarks of Dolby Laboratories.

Open Source License Notice

In the case of using open source software, Open Source Licenses are available on the product menu.
Open Source License Notice is written only English.

Specifications

Environmental Considerations		
Operating Temperature	50°F to 104°F (10°C to 40°C)	
Operating Humidity	10% to 80%, non-condensing	
Storage Temperature	-4°F to 113°F (-20°C to 45°C)	
Storage Humidity	5% to 95%, non-condensing	
Stand Swivel (Left / Right)	0°	
Model Name	PN42C450	PN50C450
Screen Size (Diagonal)	42 inches (42.3 inches measured diagonally)	50 inches (49.9 inches measured diagonally)
Sound (Output)	10 W X 2	10 W X 2
Dimensions (WxDxH)		
Body	40.6 x 2.8 x 24.8 inches (1031 x 70.9 x 631.0 mm)	47.3 x 2.7 x 28.4 inches (1202.6 x 69.5 x 720.5 mm)
With stand	40.6 x 11.2 x 27.4 inches (1031 x 284.5 x 695.5 mm)	47.3 x 11.2 x 31.0 inches (1202.6 x 284.3 x 786.3 mm)
Weight		
Without Stand	38.6 lbs (17.5 kg)	50.7 lbs (23 kg)
With Stand	43.0 lbs (19.5 kg)	55.1 lbs (25 kg)
Display Resolution	1024 X 768	1360 X 768

 Design and specifications are subject to change without prior notice.

 This device is a Class B digital apparatus.

 For information about power supply, and more about power consumption, refer to the label attached to the product.

Dimensions

■ Front view / Side view

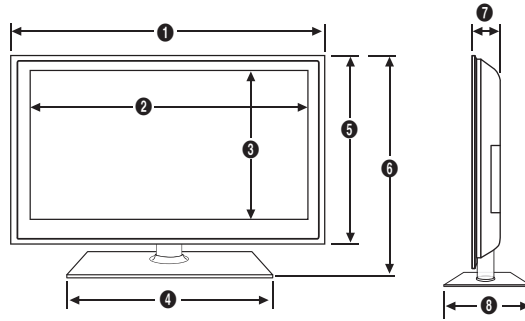

(Unit: inches)

Model name	1	2	3	4	5	6	7	8
PN42C450	40.6	37.0	21.1	23.3	24.8	27.4	2.8	11.2
PN50C450	47.3	43.7	24.6	23.3	28.4	31.0	2.7	11.2

■ Jack panel detail / Rear view

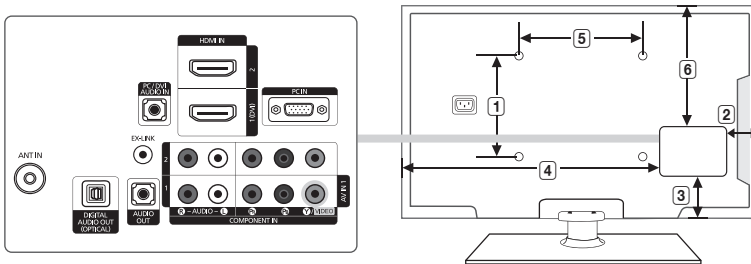

(Unit: inches)

Model name	1	2	3	4	5	6
PN42C450	15.2	3.4	3.2	29.2	15.7	15.7
PN50C450	19.4	3.7	2.5	35.7	15.7	15.7

NOTE: All drawings are not necessarily to scale. Some dimensions are subject to change without prior notice. Refer to the dimensions prior to performing installation of your TV. Not responsible for typographical or printed errors.

© 2010 Samsung Electronics America, Inc

Other Information

Index

A

Antenna	13
Anynet+	26
AUDIO OUT	10
Auto Adjustment	17
Auto Volume	18

B

Background Music	26
Balance L/R	18
Batteries	7
Black Tone	15
Blanking Bracket	30
Brightness	15

C

Change PIN	20
Channel Menu	13
Clock	18
Color Tone	16
Component	9
Connecting to a PC	11
Connecting to an Audio Device	10

D

DIGITAL AUDIO OUT	10, 26
D-sub	11
Dynamic	15
Dynamic Contrast	15

E

Eco Sensor	21
Edit Name	12
Editing Channels	14
Energy Saving	21
Equalizer	18
External Speaker	18

F

FAV.CH button	7, 13
Film Mode	16
Fine Tune	15
Flesh Tone	15
Frequency	11

H

HDMI	9, 26
Home Theater	10, 26

I

Installation Space	31
--------------------	----

L

Language	21
License	36

M

Media Play	23
Melody	22
Mono	18
Music	25

N

Navigate	12
----------	----

O

Optimal resolution	11
--------------------	----

P

Photo	24
Picture Size	16
Plug & Play	8
Power Indicator	6

R

Receiver	28
Recording	28
Remote Control	7
Repeat Music	25

S

Select All	14
Self Diagnosis	22
Sharpness	15
Sleep Timer	19
Slide Show	24
Software Upgrade	22
Source List	12
Speaker Select	18
Specifications	36
Standby mode	6
Symbol	3

T

Timer	19
Tools	3
Troubleshooting	33
TV Speaker	18

U

USB Drive	22, 23
-----------	--------

V

Volume	6
--------	---

W

Wall Mount	30
Warm	16
White Balance	15