

Use & Care Guide
Guía de uso y cuidada
English / Español

Model/Modelos: 790.7533*,7534,*

Kenmore Elite®

Gas Range

Estufa de gas

* = color number, código de color

PN 808530505 Rev A

Sears Brands Management Corporation
Hoffman Estates, IL 60179 U.S.A.

www.kenmore.com
www.sears.com

Sears Canada Inc.,
Toronto, Ontario, Canada, M5B 2C3
www.sears.ca



Table of Contents

Kenmore Elite Limited Warranty	2	Cleaning Various Parts of Your Oven	35
Before Setting Surface Controls	8	Replacing the oven light	37
Setting Surface Burners	11	Removing and Replacing the Oven Door	38
Before Setting Oven Controls	13	Before You Call	39
Setting Oven Controls	14	Oven Baking	39
Care and Cleaning	35	Solutions to Common Problems	40

Kenmore Elite Limited Warranty

When installed, operated and maintained according to all instructions supplied with the product, if this appliance fails due to a defect in material and workmanship within one year from the date of purchase, call 1-800-4-MY-HOME® to arrange for free repair. This warranty applies for only 90 days from the date of purchase if this appliance is ever used for other than private family purposes.

This warranty covers only defects in material and workmanship. Sears will NOT pay for:

1. Cracks in a ceramic glass cooktop that are not a result of thermal shock.
2. Stains and scratches on a ceramic glass cooktop resulting from failure to maintain it properly according to all instructions supplied with the product.
3. Expendable items that can wear out from normal use, including but not limited to filters, belts, light bulbs, and bags.
4. A service technician to instruct the user in correct product installation, operation or maintenance.
5. A service technician to clean or maintain this product.
6. Damage to or failure of this product if it is not installed, operated or maintained according to all instructions supplied with the product.
7. Damage to or failure of this product resulting from accident, abuse, misuse or use for other than its intended purpose.
8. Damage to or failure of this product caused by the use of detergents, cleaners, chemicals or utensils other than those recommended in all instructions supplied with the product.
9. Damage to or failure of parts or systems resulting from unauthorized modifications made to this product.

Disclaimer of implied warranties; limitation of remedies

Customer's sole and exclusive remedy under this limited warranty shall be product repair as provided herein. Implied warranties, including warranties of merchantability or fitness for a particular purpose, are limited to one year or the shortest period allowed by law. Sears shall not be liable for incidental or consequential damages. Some states and provinces do not allow the exclusion or limitation of incidental or consequential damages, or limitation on the duration of implied warranties of merchantability or fitness, so these exclusions or limitations may not apply to you.

This warranty applies only while this appliance is used in the United States or Canada.*

This warranty gives you specific legal rights, and you may also have other rights which vary from state to state.

* In Canada, in-home repair service is not available in all areas, nor will this warranty cover user or servicer travel and transportation expenses if this product is located in a remote area (as defined by Sears Canada Inc.) where an authorized servicer is not available.

Sears Canada Inc. warranty coverage for Kenmore Elite products may differ depending on model number. Call 1-800-4-MY-HOME® for exact warranty details.

Sears Brands Management Corporation, Hoffman Estates, IL 60179 U.S.A.
Sears Canada Inc., Toronto, Ontario, Canada M5B 2B8

Important Safety Instructions

Read all instructions before using this appliance.

This manual contains important safety symbols and instructions. Please pay attention to these symbols and follow all instructions given. Do not attempt to install or operate your appliance until you have read the safety precautions in this manual. Safety items throughout this manual are labeled with a WARNING or CAUTION statement based on the risk type.

DEFINITIONS

⚠ This is the safety alert symbol. It is used to alert you to potential personal injury hazards. Obey all safety message that follow this symbol to avoid possible injury or death.

⚠ WARNING - Indicates a potentially hazardous situation which, if not avoided, may result in death or serious injury.

⚠ CAUTION - Indicates a potentially hazardous situation which, if not avoided, may result in minor or moderate injury.

Important: indicates installation, operation, maintenance, or valuable information that is not hazard related.

⚠ WARNING DO NOT LEAVE CHILDREN ALONE - children should not be left alone or unattended in the area where appliance is in use. They should never be allowed to sit or stand on any part of the appliance, including the storage drawer, lower broiler drawer, warmer drawer, or lower double oven.

⚠ WARNING Stepping, leaning or sitting on the door or drawers of a range can result in serious injuries and also cause damage to the appliance. DO NOT allow children to climb or play around the range. The weight of a child on an open oven door, may cause the range to tip, resulting in serious burns or other injury.

⚠ WARNING NEVER cover any slots, holes, or passages in the oven bottom or cover an entire oven rack with materials such as aluminum foil. Aluminum foil linings may trap heat, causing a fire hazard.

⚠ WARNING If the information in this manual is not followed exactly, a fire or explosion may result causing property damage, personal injury or death.

FOR YOUR SAFETY:

- Do not store or use gasoline or other flammable vapors and liquids in the vicinity of this or any other appliance.

WHAT TO DO IF YOU SMELL GAS:

- Do not try to light any appliance.
- Do not touch any electrical switch; do not use any phone in your building.
- Immediately call your gas supplier from a neighbor's phone. Follow the gas supplier's instructions.
- If you cannot reach your gas supplier, call the fire department.
- Installation and service must be performed by a qualified installer, service technician or the gas supplier.

⚠ WARNING Storage in or on appliance—flammable materials should not be stored in an over, near surface units, or in the storage drawer, warmer drawer or lower oven. This includes paper, plastic and cloth items, such as cookbooks, plastic ware and towels, as well as flammable liquids. Do not store explosives, such as aerosol cans, on or near the range.

⚠ WARNING Air curtain or other overhead range hoods which operate that operate by blowing a downward air flow onto a range, shall not be used in conjunction with gas ranges other than when the range and hood have been designed, tested, and listed by an independent test laboratory for use in combination with each other.

⚠ WARNING Never use this appliance as space heater to heat or warm room. Doing so may result in carbon monoxide poisoning.

⚠ WARNING Do not use the oven or warming drawer for storage.

IMPORTANT SAFETY INSTRUCTIONS

Read all instructions before using this appliance.

⚠ WARNING

Tip Over Hazard



- A child or adult can tip the range and be killed.
- Verify the anti-tip device has been installed to floor or wall.

- Ensure the anti-tip device is re-engaged to floor or wall when the range is moved.
- Do not operate the range without the anti-tip device in place and engaged.
- Failure to follow these instructions can result in death or serious burns to children and adults.



Range

leveling leg

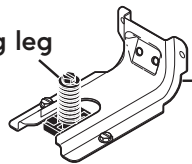

Anti-tip
bracket

To check if the anti-tip bracket is installed properly, use both arms and grasp the rear edge of the range back. Carefully attempt to tilt range forward. When properly installed, the range should not tilt forward.

Refer to the anti-tip bracket installation instructions supplied with your range for proper installation.

⚠ CAUTION Do not store items of interest to children in the cabinets above a range on the backguard of the ranges. Children climbing on the range to reach items could be seriously injured.

⚠ CAUTION Do not touch surface heating units or surface cooking elements, areas near these units or elements, or interior surface of the oven. Surface heating areas and oven heating elements may be hot even though they appear cool. Areas near surface cooking units may become hot enough to cause burns. During and after use, do not touch, or let clothing or other flammable materials touch these areas until they are cool. These areas may include the cooktop, surfaces facing the cooktop, oven vent areas, oven door, and oven window.

⚠ CAUTION Do not heat unopened food containers. Build-up of pressure may cause container to burst and result in injury.

⚠ CAUTION Wear proper apparel. Loose-fitting or hanging garments should never be worn while using this appliance. Do not let clothing or other flammable materials come into contact with hot surfaces.

⚠ CAUTION When heating fat or grease, watch it closely. Fat or grease may catch fire if it becomes too hot.

⚠ CAUTION Do not use water or flour on grease fires. Cover the fire with a pan lid, use baking soda, or use a dry chemical or foam type extinguisher.

⚠ CAUTION Use dry potholders. Moist or damp potholders on hot surfaces may result in burns from steam. Do not let potholders touch hot cooking areas. Do not use towels or other bulky cloths.

Important: Read and follow these instructions and precautions for unpacking, installing, and servicing your appliance:

- Remove all tape and packaging before using the range. Destroy the carton and plastic bags after unpacking the range. Never allow children to play with packaging material.
- **Proper Installation—Be sure your appliance is properly installed and grounded by a qualified technician in accordance with the National Fuel Gas Code ANSI Z223.- latest edition, or in Canada CAN/CGA B149.1, and CAN/CGA B149.2, and the National Electrical Code ANSI/NFPA No.70-latest edition, or in Canada CSA Standard C22.1, Canadian Electrical Code, Part 1, and local code requirements.** Install only per installation instructions provided in the literature package for this range. Ask your dealer to recommend a qualified technician and an authorized repair service. Know how to disconnect the power to the range at the circuit breaker or fuse box in case of an emergency.

Save these instructions for future reference.

IMPORTANT SAFETY INSTRUCTIONS

Read all instructions before using this appliance.

- User servicing—Do not repair or replace any part of the appliance unless specifically recommended in the manuals. All other servicing should be done only by a qualified technician. This reduces the risk of personal injury and damage to the range. Ask your dealer to recommend a qualified technician and an authorized repair service. Know how to disconnect the power to the range at the circuit breaker or fuse box in case of an emergency.
- Remove the oven door from any unused range if it is to be stored or discarded.
- **Never modify or alter the construction of a range by removing the leveling legs, panels, wire covers, anti-tip brackets/screws, or any other part of the range.**

Important

- Do not operate range during a power failure. If power fails, turn off range. If range is not turned off and power resumes, the range may begin to operate again. Once the power resumes, reset the clock and over function.
- Cold temperatures can damage the electronic control. When using this appliance for the first time, or when the appliance has not been used for an extended period of time, be sure the appliance has been in temperatures above 32°F (0°C) for at least 3 hours before turning on the power to the appliance.
- Remove the oven door from any unused range if it is to be stored or discarded.
- Be sure to have an appropriate foam-type fire extinguisher available, visible, and easily accessible located near the appliance.

Important: Important Safety Notice - The California Safe Drinking Water and Toxic Enforcement Act requires the Governor of California to publish a list of substances known to cause cancer, birth defects or other

reproductive harms, and requires businesses to warn customers of potential exposures to such substances.

Important Instructions for Using your Cooktop

⚠ WARNING Use Proper Flame Size — Adjust flame size so it does not extend beyond the edge of the utensil. The use of undersized utensils will expose a portion of the burner flame to direct contact and may result in ignition of clothing. Proper relationship of utensil to flame will also improve efficiency.

- **Know which knob controls each surface burner.** Place a pan of food on the burner before turning it on, and turn the burner off before removing the pan.
- **Always turn knob to the full Lite position when igniting top burners.** Visually check that burner has lit. Then adjust the flame so it does not extend beyond the edge of the utensil.
- **Utensil handles should be turned inward and not extend over adjacent surface burners** — To reduce the risk of burns, ignition of flammable materials, and spillage due to unintentional contact with the utensil, the handle of the utensil should be positioned so that it is turned inward, and does not extend over adjacent surface burners.
- **Never leave surface burners unattended at high heat settings** — Boil overs cause smoking and greasy spills that may ignite, or a pan that has boiled dry may melt.
- **Glazed cooking utensils** — Only certain types of glass, glass/ceramic, ceramic, earthenware, or other glazed utensils are suitable for cook top service without breaking due to the sudden change in temperature. Check the manufacturer's recommendations for cook top use.
- When you are flaming foods under a ventilating hood, turn the fan on.

IMPORTANT SAFETY INSTRUCTIONS

Read all instructions before using this appliance.

Important Instructions for Using Your Oven

- Never use your appliance for warming or heating the room. **Doing so may result in CARBON MONOXIDE poisoning.**
- Use care when opening oven door, lower oven door, or warmer drawer (some models). Stand to the side of the range when opening the door of a hot oven. Let hot air or steam escape before you remove or replace food in the oven.
- Keep oven vent ducts clear. Touching surfaces in this area when the oven is on may cause severe burns. Do not place plastic or heat-sensitive items on or near the oven vent. These items can melt or ignite.
- Always handle oven racks when the oven is cool. Place oven racks in desired positions while the oven is cool. If a rack must be moved while the oven is hot, use extreme caution. Use potholders and grasp the rack with both hands to reposition. Do not let potholders contact the hot heating elements in the oven. Remove all cookware and utensils before moving the rack.
- Do not use a broiler pan without its insert. Broiler pans and inserts allow dripping fat to drain away from the high heat of the broiler. Do not cover the broiler insert with aluminum foil; exposed fat and grease could ignite.
- Do not use aluminum foil or other protective liners to line the oven bottom. Only use aluminum foil as recommended in this manual. Improper installation of these liners may result in risk of electric shock or fire.
- Do not cook food on the oven bottom. Always cook in proper cookware and always use the oven racks.

Important Instructions for Cleaning Your Range

CAUTION Before manually cleaning any part of the range, be sure all controls are turned OFF and the range is cool. Cleaning a hot range can cause burns

- Clean the range regularly to keep all parts free of grease that could catch fire. Pay particular attention to the area around each burner element. Do not allow grease to accumulate.
- On models with stainless steel cooktops, clean with warm soapy water using a clean sponge or cloth. Rinse with clean water and dry with a soft clean cloth. Do not use any store bought cleaners like stainless steel cleaners or any other types of cleaners containing any abrasive, chlorides, chlorine, or ammonia. It is recommended to use mild dish soap and water or a 50/50 solution of water and vinegar.
- Always follow the manufacturer's recommended directions for use of kitchen cleaners and aerosols. Be aware that excess residue from cleaners and aerosols may ignite causing damage and injury.
- Clean ventilating hoods frequently. Grease should not be allowed to accumulate on the hood or filter. Follow the manufacturer's instructions for cleaning hoods.

Self-Cleaning Ovens

- Use the self-clean cycle to clean only the parts listed in this manual. Before using self-clean, remove the broiler pan, any food, utensils, and cookware from the oven. Remove oven racks unless otherwise instructed.
- Do not use oven cleaners, oven liner, or protective coating of any kind should be used in or around any part of the oven.
- Do not clean the oven door gasket. The door gasket is essential for a good seal. Do not rub, damage, or move the gasket.
- Some birds are extremely sensitive to the fumes given off during the self-clean cycle of any range. Move birds to another well-ventilated room.

Save these instructions for future reference.

IMPORTANT SAFETY INSTRUCTIONS

Read all instructions before using this appliance.

Grounding Instructions

For models factory-equipped with a power cord:

For personal safety, this appliance must be properly grounded. For maximum safety, the power cord must be plugged into an electrical outlet that is correctly polarized and properly grounded. If a two-prong wall receptacle is the only available outlet, it is the personal responsibility of the consumer to have it replaced with a properly grounded three-prong wall receptacle installed by a qualified electrician.

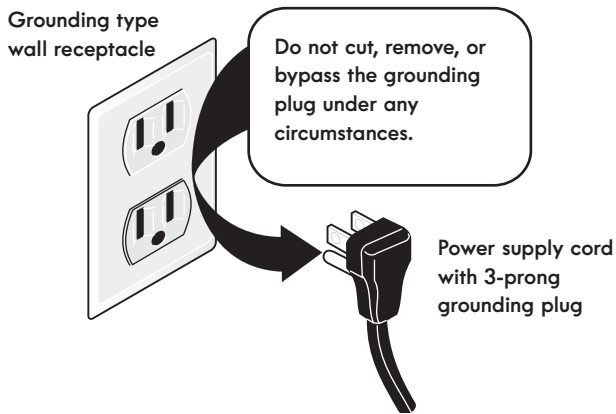

⚠ WARNING Avoid fire hazard or electrical shock. Do not use an adapter plug, and extension cord, or remove grounding prong from the power cord. Failure to follow this warning may cause serious injury, fire, or death.

⚠ WARNING This appliance is equipped with a three-prong grounding plug. For your protection against shock hazard, it should be plugged directly into a properly grounded receptacle. Do not cut or remove the grounding prong from this plug.

See the installation instructions packaged with this appliance for complete installation and grounding instructions.

Important note:

This appliance allows for conversion to Liquefied Petroleum (L.P.) Gas.

Conversion to L.P. Gas

⚠ WARNING Personal injury or death from electrical shock may occur if the conversion to L.P. gas is not made by a qualified installer or electrician.

⚠ WARNING Any additions, changes or conversions required in order for this appliance to satisfactorily meet the application needs must be made by a qualified technician.

If L.P. conversion is needed, contact your local L.P. Gas provider for assistance. The L.P. conversion kit is provided with this appliance and is located on the lower REAR (back side) panel of the range. Before installing the kit be sure to read the L.P. Installation Instructions and follow them carefully when making the installation. Product Record

You may find the model and serial number printed on an identification label. The label is located on the lower right of the oven frame. Open the drawer to see the serial label.

Serial Plate Location

To locate the serial plate open storage drawer (some models) or warmer drawer (some models). The serial plate is attached to the lower right oven frame.



Record the date of purchase, model and serial number of your product in the corresponding space below..

Model Number: _____

Serial Number: _____

Date of Purchase: _____

Save your sales receipt for future reference.

Save these instructions for future reference.

Before Setting Surface Controls

Check burner cap placement before operating the surface burners

⚠ WARNING To prevent flare-ups and avoid creation of harmful by-products, do not use the cooktop without all burner caps properly installed to insure proper ignition and gas flame size.

It is very important to be sure that all surface burner caps and burner grates are properly installed and in the correct locations BEFORE operating the cooktop burners.

Important:

- Always keep surface burner caps in place whenever using a surface burner.
- When placing the burner caps, be sure that all burner caps are seated firmly and rest level on top of burner heads.
- For proper flow of gas and ignition of burners DO NOT allow spills, food, cleaning agents or any other material to enter the gas orifice port opening.
- On round style burners, the burner cap lip (Figure 1) should fit snug into the center of burner head and rest level. Refer to Figure 2 for correct and incorrect burner cap placement.
- Once in place, you may check the fit by gently sliding the burner cap from side to side (Figure 3) to be sure it is centered and firmly seated. When the burner cap lip makes contact inside the center of the burner head you will be able to hear the burner cap click.
- Please note that the burner cap should NOT move off the center of the burner head when sliding from side to side. Check and be sure that all oval style (some models) burner caps are correctly in place on oval burner heads.

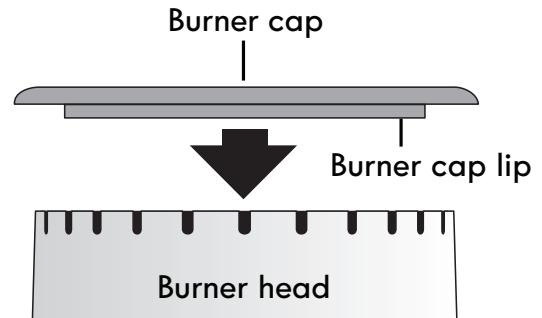

Figure 1: Burner cap on burner head

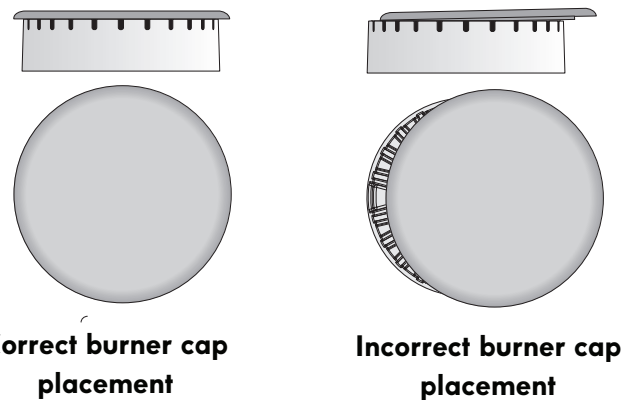

Figure 2: Correct placement (L) Incorrect placement (R)

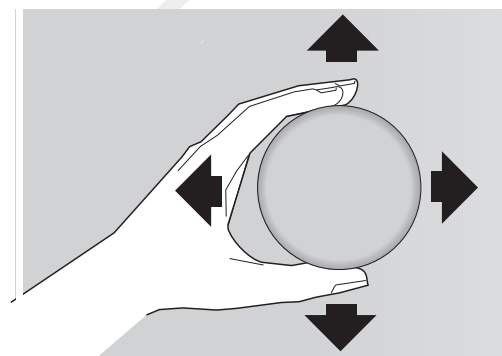

Figure 3: Moving cap gently until seated properly

Double Ring style burners (some models)

The Double Ring burner only operates properly with two burner caps in place. Be sure the burner cap lips are positioned facing down towards the burner head and into the recessed areas (Figure 4) on each side of the burner head. Be sure both burner caps are seated firmly and rest level on the burner head before operating.

Check the fit for each cap using the same method for the round burner caps by gently sliding each cap from side to side. Please note that the burner cap lips should NOT move out of recessed areas of the burner head.

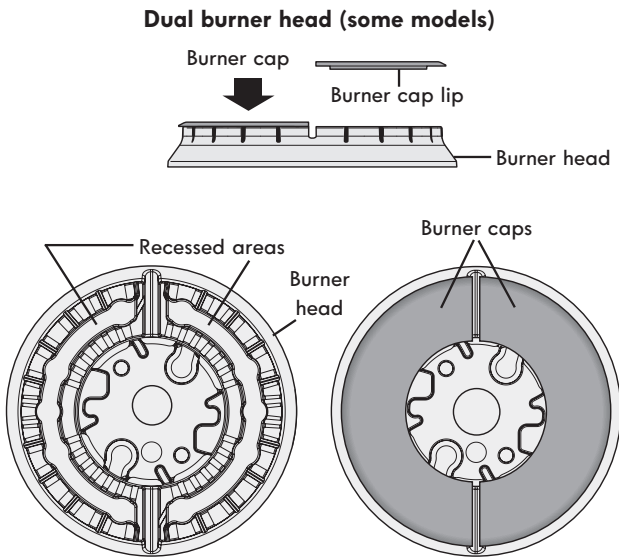

Figure 4: Dual burner head using two burner caps

Installing burner grates

CAUTION Do not use the surface burners without the burner caps and burner grates properly installed. Missing pieces or improper installation may lead to spills, burns, or damage to your range and cookware.

Make sure the burner grates are properly placed on the cooktop before using the surface burners. The grates are designed to rest inside the recess on the cooktop.

To install burner grates, place grates flat-side down and align into the cooktop recess. Grates should rest flush against each other and against the sides of the recess.

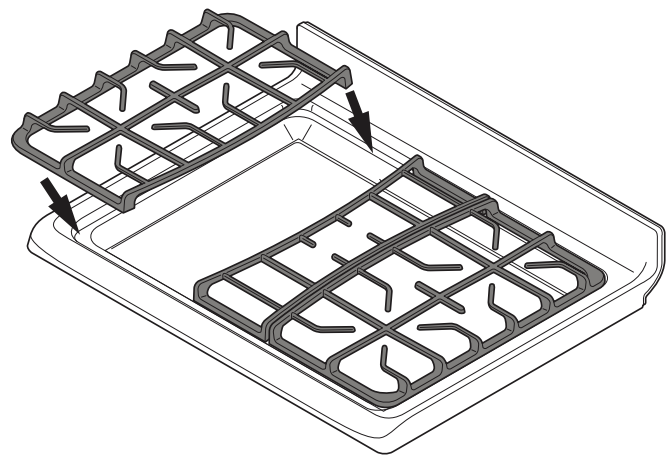

Figure 5: Proper grate installation

Before Setting Surface Controls

Using proper cookware

⚠ CAUTION DO NOT place flammable items such as plastic salt and pepper shakers, spoon holders or plastic wrappings on the cooktop when it is in use. These items could melt or ignite. Potholders, towels or wooden spoons could catch fire if placed too close to the range cooktop.

Important: DO NOT place aluminum foil, or ANY material that can melt on the range cooktop. If these items melt they **may damage the cooktop.**

For best cooking results, cookware should have flat bottoms that rest level on the burner grate. Before using cookware, check for flatness by rotating a ruler across the bottom of the cookware (Figure 6).



Figure 6: Check for flat bottom cookware

Please note: The size and type of utensil used, and the amount and type of food being cooked will influence the burner flame setting needed for best cooking results.

Cookware material types

The most popular materials available are:

- **Aluminum** - Excellent heat conductor. Some types of food will cause it to darken (Anodized aluminum cookware resists staining & pitting).
- **Copper** - Excellent heat conductor but discolors easily.
- **Stainless** - Slow heat conductor with uneven cooking results. Is durable, easy to clean and resists staining.
- **Cast Iron** - A slow heat conductor however will retain heat very well. Cooks evenly once cooking temperature is reached.
- **Porcelain-enamel on metal** - Heating characteristics will vary depending on base material.
- **Glass** - Slow heat conductor.

Setting proper burner flame size

⚠ CAUTION Never extend the flame beyond the outer edge of the cooking utensil. A higher flame wastes energy, and increases your risk of being burned by the flame.

*These settings are based for medium-weight metal or aluminum pans with lids. Settings may vary when using other types of pans.

The color of the flame is the key to proper burner adjustment. A good flame is clear, blue and hardly visible in a well-lighted room. Each cone of flame should be steady and sharp. Adjust or clean burner if flame is yellow-orange.

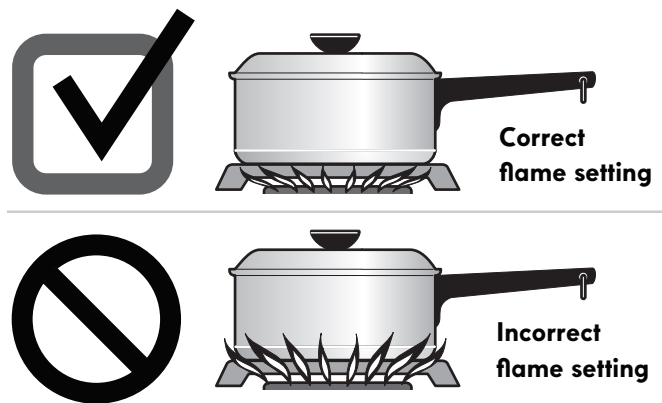

Figure 7: Proper flame size for efficient cooking

For most cooking; start on the highest setting and then turn to a lower setting to complete the process. Use the recommendations below as a guide for determining proper flame size for various types of cooking.

For deep fat frying; use a thermometer and adjust the surface knob accordingly. If the fat is too cool, the food will absorb the fat and be greasy. If the fat is too hot, the food will brown so quickly that the center will be under cooked. Do not attempt to deep fat fry too much food at once as the food will neither brown or cook properly. .

Flame size	Type of cooking
High flame	Start most foods, bring water to a boil, pan broiling.
Medium flame	Maintain a slow boil, thicken sauces, gravies, steaming.
Low flame	Keep foods cooking, poaching, and stewing.

Setting Surface Burners

Your gas appliance may be equipped with different sized surface burners. The ability to heat food quicker and in larger volumes increases as the burner size increases. It is important to select cookware that is suitable for the amount and type of food being prepared.

- The smaller SIMMER burner (on some models) is best suited for simmering delicate sauces, etc.
- The standard size burners may be used for most surface cooking needs. Some models are equipped with a center burner.
- The larger POWER burners (on some models) or TURBO BOIL burner (on some models) are recommended for bringing large quantities of liquid to temperature and when preparing larger quantities of food.

To set surface burners:

1. Place cooking utensil on center of surface burner grate. Be sure the cooking utensil sets stable on the burner grate.
2. Push the desired surface control knob in and turn counterclockwise out of the OFF position.
3. Release the surface control knob and rotate to the **Lite** position. Visually check that the burner is lit.
4. Once the burner has a flame, push the control knob in and turn counterclockwise to the desired flame size. Use the control knob markings and adjust the flame as needed.

Important notes:

- DO NOT cook with the surface control knob left in the **Lite** position. The electronic ignitor will continue to spark if the control knob setting remains in the **Lite** position.
- When setting any surface control knob to the **Lite** position, all electronic surface ignitors will spark at the same time. However, only the surface burner you are setting will ignite.
- NEVER place or straddle a cooking utensil over 2 different surface cooking areas at the same time. This can cause uneven heating results.
- In the event of an electrical power outage, the surface burners can be lit manually. Use caution when lighting surface burners manually. To light a surface burner, hold a lit match to the burner head, then slowly turn the surface control knob to **Lite**. After burner lights push in and turn knob to desired setting.
- When operating the oven, it is possible for residual heat from the oven to build-up and over time to eventually transfer to the surface control knobs located directly above the oven door.
- The cooktop should not be used during a self-clean cycle. On some models, turning on any cooktop surface burner will cause the clean cycle to cancel. If the clean cycle is

anceled, the oven control display will show "SPr" for 5 seconds. The oven door will remain locked until the oven has cooled down below cleaning temperature. If the oven is below cleaning temperature, the user can start another clean cycle immediately. If the oven is in cleaning temperature range, another self-clean cycle can be set once the door unlocks (up to 4 hours).



Figure 8: Proper way to set burners

CAUTION Do not place flammable items such as plastic salt and pepper shakers, spoon holders or plastic wrappings on the cooktop when it is in use. These items could melt or ignite. Potholders, towels or wooden spoons could catch fire if placed too close to the range cooktop.

CAUTION Do not place aluminum foil, or ANY material that can melt on the range cooktop. If these items melt they may permanently damage the cooktop surface.

Home Canning

Be sure to read and observe all the following points when home canning with your appliance. Check with the USDA (United States Department of Agriculture) website and be sure to read all the information they have available as well as follow their recommendations for home canning procedures.

- Use only quality flat bottom canners when home canning. Use a straight-edge to check canner bottom.
- Use only a completely flat bottom canner.
- Make sure the diameter of the canner does not exceed 1 inch beyond the surface element markings or burner.
- Start with hot tap water to bring water to boil more quickly.
- Use the highest heat setting when first bringing the water to a boil. Once boiling is achieved, reduce heat to lowest possible setting to maintain that boil.

Setting Surface Burners

Setting Double Ring Burner (some models)

The versatile Double Ring surface burner offers a complete range of gas surface settings from the same burner position.

At the lowest setting, only the burner's inner ring is active, providing a smaller flame that is perfect for simmering. If needed, the burner's outer ring may be added and when set for HI will provide a gas flame that may be used to bring a large pan of liquid to boil quickly.

Operating the Double Ring Burner:

1. Push right front surface burner control knob in and turn counterclockwise out of the **OFF** position.
2. Release the knob and rotate to the **Lite** position.
3. Visually check that both inner and outer rings for the Double Ring burner are lit (Figure 11). Once lit, push in the control knob and to turn counterclockwise out of the Lite position and adjust to the desired flame size.
4. When adjusting for a low or simmer type flame setting, continue to rotate the control knob counterclockwise from MED setting towards LO (Figure 9). Between the MED and LO setting the flame for the outer ring portion of the burner will turn off leaving only the inner burner with a flame for simmering (Figure 11). Make any further flame adjustments as needed.



Figure 9: Setting the double ring burner

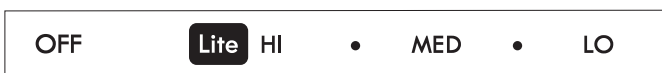

Figure 10: Burner levels

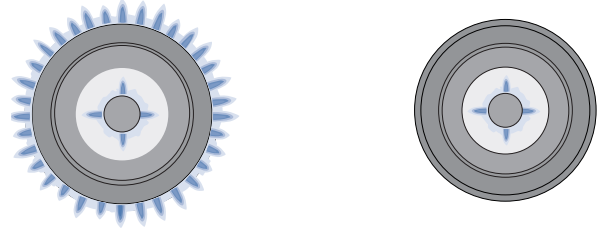

Figure 11: Burner at highest (L) setting and simmer (R)

CAUTION Do not place flammable items such as plastic salt and pepper shakers, spoon holders or plastic wrappings on the cooktop when it is in use. These items could melt or ignite. Potholders, towels or wooden spoons could catch fire if placed too close to the range cooktop.

CAUTION Do not place aluminum foil, or ANY material that can melt on the range cooktop. If these items melt they may permanently damage the cooktop surface.

Important:

- DO NOT cook with the surface control knob left in the **Lite** position. The electronic ignitor will continue to spark if the control knob setting remains in the **Lite** position.
- When setting any surface control knob to the **Lite** position, all electronic surface ignitors will spark at the same time. However, only the surface burner you are setting will ignite.
- NEVER place or straddle a cooking utensil over two different surface cooking areas at the same time. This can cause uneven heating results.
- In the event of an electrical power outage, the surface burners can be lit manually. Use caution when lighting surface burners manually. To light a surface burner, hold a lit match to the burner head, then slowly turn the surface control knob to **Lite**. After burner lights push in and turn knob to desired setting.

Before Setting Oven Controls

Oven vent location

The oven vent is located under the left side of the control panel. When the oven is on, warm air passes through this vent. This venting is necessary for proper air circulation in the oven and good baking results. **Do not block oven vent:**

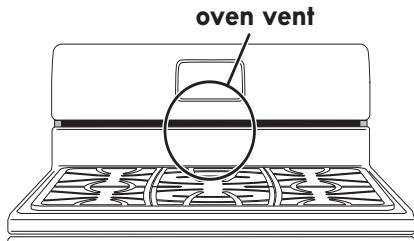

Figure 12: Oven vent in rear of range top

⚠ CAUTION Always use pot holders or oven mitts when using the oven. When cooking, the oven interior and exterior, oven racks and cooktop will become very hot which can cause burns.

⚠ WARNING Protective Liners — **DO NOT USE ALUMINUM FOIL** to line the oven bottom. Only use aluminum foil as recommended in this manual. Improper installation of these liners may result in risk of electric shock, or fire

Air circulation in the oven

For best baking results allow 2-4" (5-10 cm) around the cookware for proper air circulation and be sure pans and cookware do not touch each other, the oven door, sides or back of the oven cavity. Hot air must be able to circulate around the cookware in the oven for even heat to reach around the food.

Types of oven racks

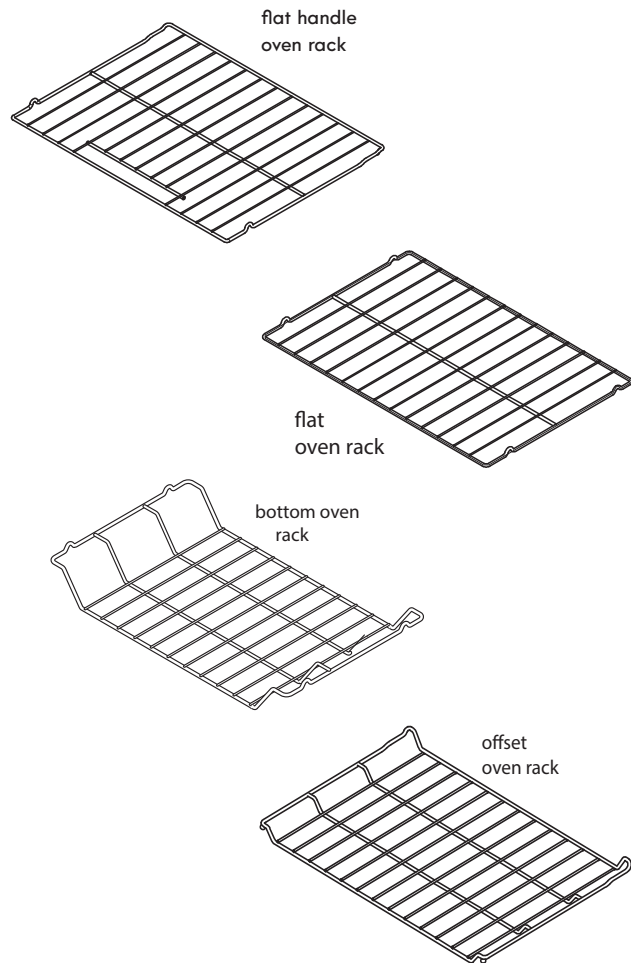

Figure 13: Variety of racks and their uses

The flat oven rack (some models) or flat handle oven rack (some models) may be used for most cooking needs.

The offset oven rack (on some models) is designed to place the base of the rack about 1/2 of a rack position lower than flat oven racks. This design allows several additional positions between the flat rack positions.

To maximize oven cooking space place the **bottom oven rack** (on some models) in the lowest rack position for roasting large cuts of meat.

Setting Oven Controls

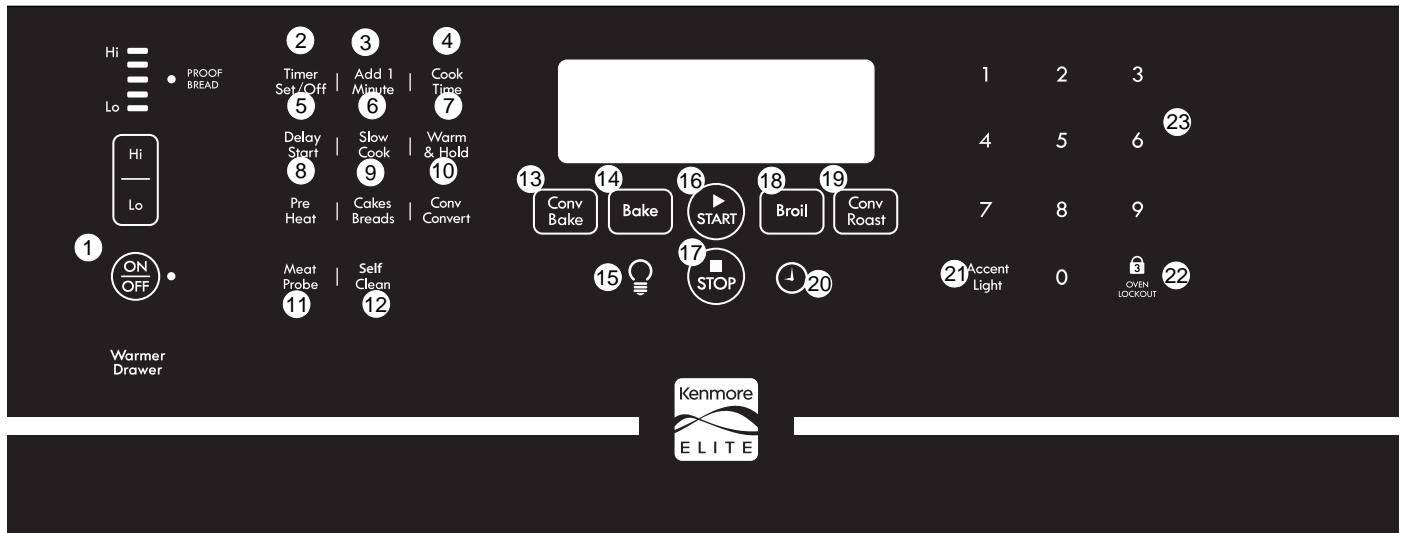

1. **Warmer Drawer** - Use to keep cooked foods warm.
2. **Timer Set/Off** - Use to set or cancel timer.
3. **Add 1 Minute** - Use to add additional minutes to timer.
4. **Cook Time** - Use to enter length of cooking time.
5. **Delay Start** - Use with Bake, Conv bake, Conv Convert and Self Clean functions to program a delay start.
6. **Slow Cook** - Use to set Slow Cook function.
7. **Warm & Hold** - Use to select Warm & Hold.
8. **Pre Heat** - Use to precondition the oven temperature.
9. **Cakes Breads** - Use for baking cakes and breads.
10. **Conv Convert** - Use to select Conv Convert function.
11. **Meat Probe** - Use to set Meat Probe.
12. **Self Clean** - Use to set a 2 to 4 hour self clean cycle.
13. **Conv Bake** - Use to select Conv bake function.
14. **Bake** - Use for normal bake functions.
15. **Light** - Use to turn oven light On and Off.
16. **START** - Use to start all oven functions.
17. **STOP** - Use to cancel any oven function previously entered except Clock and Timer.
18. **Broil** - use to set broil function.
19. **Conv Roast** - Use to select Conv Roast function.
20. **Clock** - Use to set time of day.
21. **Accent Light** - Use to turn on Accent Light feature.
22. **Oven Lockout** - Use to lockout oven functions and door.
23. **Numeric Keypad** - Use to enter temperatures and times.

Minimum & maximum control settings

All of the features listed have minimum and maximum time and temperature settings that may be entered into the control. An ENTRY acceptance beep will sound each time a key is touched (the Oven Lockout key is delayed by 3 seconds).

An ENTRY ERROR tone (3 short beeps) will sound if the entry of the temperature or time is below the minimum or above the maximum settings for the feature

Feature	Min. Temp or Time	Max. temp. or time
PreHeat	170°F / 77° C	550°F / 288°C
Bake	170°F / 77°C	550°F / 288°C
Broil	400°F / 205°C	550°F / 288°C
Timer	1 Min	11 Hrs. 59 Mins.
Self Clean	2 Hours	4 Hours
Conv Bake	300°F / 148° C	550°F / 288°C
Conv Convert	300°F / 148° C	550°F / 288°C
Conv Roast	300°F / 148° C	550°F / 288°C
Slow Cook	Lo (225 °F / 108°C)	Hi (275°F / 134°C)
Cook Time	1 Min.	11:59
Delay Time 12 Hr.	1:00	12:59
Delay Time 24 Hr.	0:00	23:59
Clock 12 Hr.	1:00	12:59
Clock 24 Hr.	0:00	23:59
Warm & Hold	170°F / 77°C	3:00
Warmer Drawer	150°F / 65°C	190°F / 88°C

Setting the Clock

When the appliance is first powered up, **12:00** will flash in the display (Figure 14). The time of day must first be set before operating the oven.

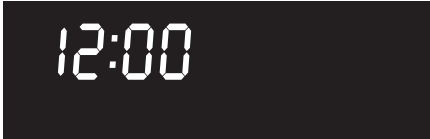

Figure 14: Display showing 12:00 when oven is first powered up

1. Press .
2. Enter **1 3 0** using numeric keys.
3. Press .

Important note:

The clock cannot be changed when a Cook Time, Self Clean, Delay Start or cooking feature is active.

Setting Timer

The minute timer lets you to track your cooking times without interfering with the cooking process. The timer may be set between 1 minute and 11 hours and 59 minutes.

To set timer for 5 minutes:

1. Press **Timer Set/Off**.
2. Enter **5** using numeric keypad
3. Press .

To cancel the timer when active press **Timer Set/Off** again.

Important note:

- The timer does not start or stop the cooking process. It serves as an extra minute timer in the kitchen that will beep when the set time has run out. The timer may be used alone or while using any of the other oven functions.
- The timer will display hours and minutes until 1 hour remains. When less than 1 hour remains, the display will count down in minutes and seconds. Once the timer has less than 1 minute remaining only seconds will display.
- When the timer is active during a cooking process, the minute timer will show in the display. To view the information of any other active oven function, press the key once for the other function to view the status.

Add 1 Minute

Use **Add 1 Minute** to set additional minutes to the timer. Each press of the key will add 1 additional minute. If **Add 1 Minute** is pressed when the timer is not active, the timer will activate and begin counting down from 1 minute.

To add 2 minutes to the timer:

Press **Add 1 Minute** twice.

Setting 12 or 24 hour display mode

The clock display allows a choice between 12 or 24 hr modes. The factory pre-set clock display mode is 12 hours.

To set 12 or 24 hour display mode:



1. Press and hold  for 6 seconds.
2. Press **Self Clean** to toggle between 12 Hr day or 24 Hr day display modes.
3. Press  to accept choice.



Figure 15: Clock set for 12 hour operation



Figure 16: Clock set for 24 hour operation

Changing between continuous bake setting or 12-Hour Energy Saving feature

The oven control has a factory preset built-in 12 Hour Energy Saving feature that will turn off the oven if the oven is left on for more than 12 hours. The control may be programmed to override this feature to continuously bake. To change between continuous bake or 12-Hour Energy Saving feature:

1. Press and hold **Timer Set/Off** for 6 seconds
2. Press **Self Clean** to toggle between **12 Hour OFF** or **Stay On** feature.
3. Press  to accept choice



Figure 17: 12 Hour operation Figure 18: Continuous operation

Setting Oven Controls

Changing oven temperature display

The oven control is preset to display °F (Fahrenheit) when shipped from the factory. The control can be changed to display either Fahrenheit or Celsius.

To change the display to °C (Celsius) or °F (Fahrenheit):

1. Press and hold **Broil** for 6 seconds.
2. Press **Self Clean** to toggle between **Fahrenheit (F)** and **Celsius (C)** temperature display modes.
3. Press  to accept choice.

Important note:

The oven temperature display cannot be changed when cooking or if Self Clean is active.



Figure 19: Fahrenheit setting



Figure 20: Celsius setting

Setting silent or audible control mode

Silent mode allows the oven control to operate without audible tones. The control may be programmed for silent operation and later returned to operating with all the normal audible tones.

To set for silent or audible mode:

1. Press and hold **Delay Start** for 6 seconds.
2. Press **Self Clean** to toggle between **bEEP On** or **bEEP OFF**.
3. Press  to accept choice.



Figure 21: Audible operation



Figure 22: Silent operation

Oven Lockout

The control may be programmed to lock the oven door and lock the oven control keys.



To activate the oven lockout features:

1. Be sure oven door is completely closed.
2. Press and hold  for 3 seconds. **door Loc** will appear in the display (Figure 23). The motor driven door latch mechanism will begin locking the oven door automatically. Do not open the oven door. Allow about 15 seconds for the oven door to completely lock. Once door is locked, the **Loc** will appear in the display. (Figure 24)



Figure 23: Door locking



Figure 24: Door locked

To cancel the oven lockout feature:

1. Press and hold  for 3 seconds. The motor door latch will begin unlocking the oven door automatically. Do not open the oven door. Allow about 15 seconds for the oven door to completely unlock.
2. When the **Loc** message no longer displays, the oven door may be opened and the oven control keys will be available for use.

Important note:

- To avoid possible damage to the oven door latching mechanism, do not attempt to open or close the oven door whenever the **door Loc** message is displayed.
- If a control key is pressed when **OVEN LOCKOUT** is active, the control may triple beep indicating the function is not available when the **OVEN LOCKOUT** feature is active.

Setting Preheat

For best baking performance use the Preheat feature. The Preheat feature will bring the oven up to the set cooking temperature. A reminder tone will sound indicating when the set temperature is reached and to place the food in the oven.

When the oven is finished preheating the preheat feature will perform like the Bake feature and continue to maintain the oven set temperature until cancelled.

Preheat may be set for any oven temperature between 170°F (77°C) to 550°F (288°C).

⚠ CAUTION Always use pot holders or oven mitts when using the oven. When cooking, the oven interior, oven exterior, oven racks and cooktop will become very hot which can cause burns.

To set Preheat with default oven temperature of 350°F:

1. Press **PreHeat**.

2. Press .

To cancel preheating at anytime press .



Figure 25: Oven in preheat mode for baking

1. Press **PreHeat**.

2. Press **4 5 0** using numeric keypad.

3. Press .

To cancel preheating at any time press .

Important note:

- When setting Bake or any cooking feature that preheats the oven (except Broil), the Convection fan will turn on after 6 minutes and stay on until the oven reaches set temperature.
- Preheating is not necessary when roasting or cooking casseroles.

Setting Bake

Use the bake feature whenever the recipe calls for baking using normal temperatures. A reminder tone will sound indicating when the set bake temperature is reached and to place the food in the oven.

Bake may be set for any oven temperature between 170°F (77°C) to 550°F (288°C).

⚠ CAUTION Always use pot holders or oven mitts when using the oven. When cooking, the oven interior, oven exterior, oven racks and cooktop will become very hot which can cause burns.

To set Bake with default temperature of 350°F:

1. Press **Bake**.

2. Press .

To cancel Bake at anytime press .

To set Bake for oven temperature of 425°F:

1. Press **Bake**.

2. Enter **4 2 5** using numeric keypad.

3. Press .

To cancel Bake at any time press .

Baking tips:

- Dark or dull pans and glass absorb more heat than shiny bakeware resulting in dark or over browning of foods. To prevent this it may be necessary to reduce the oven temperature or cook time to prevent over browning of some foods. Dark pans are recommended for pies. Shiny pans are recommended for cakes, cookies and muffins.
- Do not open the oven door too often. Opening the door will reduce the temperature in the oven.

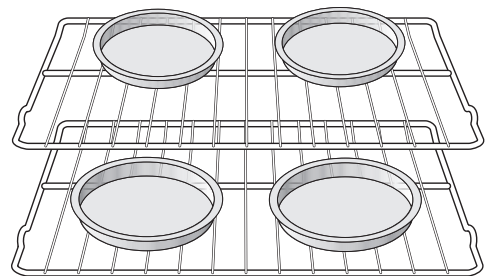



Figure 26: Pans spaced for more even baking

Setting Oven Controls

Setting Cook Time

Use Cook Time to program the oven control to automatically turn the oven function off after a desired length of time.

To program oven to Bake with oven default temperature of 350°F and to shut-off after 30 minutes:

1. Press **Cook Time**.
2. Enter **3 0** using numeric keys.
3. Press  to accept.
4. Press **Bake**.
5. Press .

When the programmed cook time ends:

1. **End** will appear in the display window and the oven will shut-off automatically.
2. The oven control will beep 3 times every 30 seconds as a reminder until  is pressed.



Figure 27: End of baking function

Important note:



- The Cook Time feature may be set with Bake, Conv Bake, Conv Roast, Slow Cook and Preheat. Cook Time or Delay Start will not operate with the Broil function.
- The maximum default Cook Time setting is 11 hours and 59 minutes.
- After the Cook Time feature is activated, press **Cook Time** to display any cook time remaining.
- Dark or dull pans and glass absorb more heat than shiny bakeware resulting in dark or over browning of foods. To prevent this it may be necessary to reduce the oven temperature or cook time to prevent over browning of some foods. Dark pans are recommended for pies. Shiny pans are recommended for cakes, cookies and muffins.
- Do not open the oven door too often. Opening the door will reduce the temperature in the oven.

Setting Delay Start

Delay Start sets a delayed starting time to oven cooking or cleaning functions. Prior to setting a delay start, be sure the time of day is set correctly.

⚠ WARNING FOOD POISONING HAZARD. Do not let food sit for more than one hour before or after cooking. Doing so can result in food poisoning or sickness. Foods that can easily spoil such as milk, eggs, fish, meat or poultry, should be chilled in the refrigerator first. Even when chilled, they should not stand in the oven for more than 1 hour before cooking begins, and should be removed promptly when finished cooking.

To program oven for a Delay Start beginning at 5:30, to shut-off automatically after 50 minutes and for baking at 375°F:

1. Press **Cook Time**.
2. Enter **5 0** using numeric keypad.
3. Press  to accept.
4. Press **Delay Start**.
5. Enter **5 3 0** using numeric keys.
6. Press  to accept.
7. Press **Bake**.
8. Enter **3 7 5** using numeric keys.
9. Press .

When the programmed cook time ends:

1. **End** will appear in the display window and the oven will shut off automatically. (Figure 27)
2. The oven control will beep 3 times every 30 seconds as a reminder until  is pressed.

Important note:

- Delay Start may be set using a 24 hour clock. See [“Setting 12 or 24 hour display mode”](#) for more information.
- The Delay Start feature may be used with the Conv Bake, Conv Roast, Conv Convert, Bake, Slow Cook and Preheat functions and Self Clean. Delay Start or Cook Time will not operate with the Broil function.

Setting Conv Bake

Benefits of the convection bake feature:

- Foods may cook up to 25 to 30% faster, saving time and energy.
- Multiple rack baking.

Convection functions use a fan to circulate the oven heat uniformly and continuously around the oven. This improved heat distribution allows for fast, even cooking and browning results. It also gives better baking results when using two oven racks at the same time.

Heated air flows around the food from all sides, sealing in juices and flavors. Breads and pastry brown more evenly.

Most food items will cook faster and more evenly with the convection feature.

Conv Bake may be set for any oven temperature between 300°F (148°C) to 550°F (288°C).

Suggestions for Convection baking:

- For optimum cooking results it is recommended to preheat the oven when baking foods such as cookies, biscuits and breads.
- Reduce oven temperature 25°F from recipe's recommended oven temperature. Follow the remainder of the recipe's instructions using the minimum recommended cook time.
- For best results when using a single oven rack, place rack in position 3 or 4 (Figure 28). When using 2 oven racks, place in positions 3 & 5. When using 3 oven racks place in positions 2, 4, & 6 (use offset rack only in position 6).

To set Conv Bake with a default oven set temperature of 350°F:

1. Press **Conv Bake**.
2. Press .

To cancel Conv Bake at any time press .

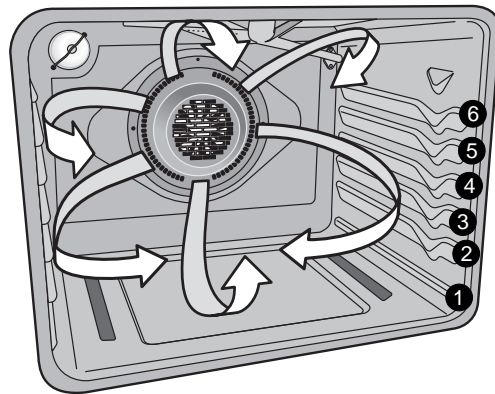

Figure 28: Oven rack positions and air circulation

- The convection fan will begin rotating 6 minutes after Conv Bake, Conv Roast or Conv Convert has been activated.
- If the oven door is opened when any convection function is active, the convection fan will **stop rotating** until the oven door is closed.
- When using Conv Bake cook time reductions may vary depending on the amount and type of food being cooked.
- Dark or dull pans and glass absorb more heat than shiny bakeware resulting in dark or over browning of foods. To prevent this it may be necessary to reduce the oven temperature or cook time to prevent over browning of some foods. Dark pans are recommended for pies. Shiny pans are recommended for cakes, cookies and muffins.
- Do not open the oven door too often. Opening the door will reduce the temperature in the oven.

Setting Oven Controls

Setting Conv Convert

The Conv Convert function makes it easy to convert any baking recipe using the convection feature. The oven control uses the normal recipe settings and **adjusts to a lower temperature** for convection baking.

When Conv Convert is used with a Delay Start setting, the Conv Convert function will display a **CF** message (Figure 29) as a reminder to check food when the bake time is 75% complete. At this time the oven control will sound 1 long beep at regular intervals until the set cook time has finished.





Figure 29: Check food reminder

3. Press **Conv Convert**.

To cancel Conv Convert at any time press  .

To program oven for Conv Convert with oven default temperature of 350°F and to shut-off after 30 minutes:

1. Press **Conv Bake**.
2. Press  to accept.
3. Press **Cook Time**.
4. Enter **3 0** using numeric keys.
5. Press  to accept.
6. Press **Conv Convert**.

To cancel Conv Convert at any time press  .

Important note:

- Conv Convert may only be used with the **Conv Bake** function and with **20 minutes** as the minimum amount of Cook Time for using the Conv Convert function.
- When using Conv Convert function Cook Time reductions may vary depending on the oven set temperature.
- The convection fan will begin rotating once Conv Bake, Conv Roast or Conv Convert has been activated.
- If the oven door is opened when any convection function is active, the convection fan will **stop rotating** until the oven door is closed.

Setting Conv Roast

The Conv Roast function combines a cook cycle with the convection fan to roast meats and poultry. Meats cooked with Conv Roast function will be juicier and poultry will be crisp on the outside while staying tender and moist on the inside.

Conv Roast may be set for any oven temperature between 300°F (148°C) to 550°F (288°C).

Suggestions for Conv Roast:

- Preheating is not necessary when roasting foods using Conv Roast.
- Since Conv Roast cooks food faster, reduce the cook time by 25% from the recommended cook time of your recipe (check the food at this time). If necessary, increase cook time until the desired doneness is obtained.
- Do not cover foods when dry roasting - this will prevent the meat from browning properly.

To set Conv Roast with a default oven set temperature of 350°F:

1. Press **Conv Roast**.
2. Press  .

To cancel Conv Roast at any time press  .

Important note:



- The convection fan will begin rotating 6 minutes after Conv Bake, Conv Roast or Conv Convert has been activated.
- If the oven door is opened when any convection function is active, the convection fan will **stop rotating** until the oven door is closed.

Setting Broil

Use the broil function to cook meats that require direct exposure to radiant heat for optimum browning results. The Broil feature is factory preset to broil at 550°F. The Broil function temperature may be set at any temperature between 400°F (205°C) and 550°F (288°C).

Be aware that the suggested broil settings table (Table 1) provide recommendations only. Increase or decrease broiling times, or move to a different rack position to suit for doneness. If the food you are broiling is not listed in the table, follow the instructions provided in your cookbook and watch the item closely.

To set Broil with the default broil oven temperature of 550°F:

1. Arrange the oven racks when cool. For optimum browning results, preheat oven for 5 minutes before adding food.
2. Position cookware in oven. Close door before broiling.
3. Press **Broil**.
4. Press .
5. Broil on one side until food is browned; turn on broil other side until done to your satisfaction.
6. When finished broiling press .

To cancel Broil at any time press .

⚠ WARNING Should an oven fire occur, close the oven door and turn the oven OFF. If the fire continues, use a fire extinguisher. DO NOT put water or flour on the fire. Flour may be explosive

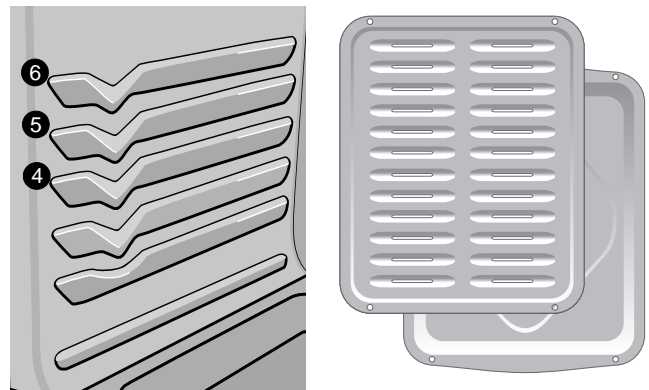

Figure 30: Broil rack positions (L) Broil pan and insert (R)

⚠ CAUTION Always use pot holders or oven mitts when using the oven. When cooking, the oven interior, exterior, oven racks and cooktop will become very hot which can cause burns.

Important note:

- Always arrange oven racks when oven is cool.
- For best results when broiling, use quality broil pan along with a broil pan insert. A broil pan is designed to drain the fat from food, helping to reduce smoking and avoid splatter.
- When broiling, always pull the oven rack out to the stop position before turning or removing food.
- Cook Time or Delay Start will not operate with the Broil function.

Table 1: Suggested broil settings

Food	Rack Position	Setting	Cook Time in minutes		Doneness
			1st side	2nd side	
Steak 1" thick	5th or 6th	550°F	6	4	Medium
Steak 1" thick	5th or 6th	550°F	7	5	Medium-well
Steak 1" thick	5th or 6th	550°F	8	7	Well
Pork chops 3/4" thick	5th	550°F	8	6	Well
Chicken (bone in)	4th	450°F	20	10	Well
Chicken (boneless)	5th	450°F	8	6	Well
Fish	5th	550°F	- as directed -		Well
Shrimp	5th	550°F	- as directed -		Well
Hamburger 1" thick	6th*	550°F	9	7	Medium
Hamburger 1" thick	5th	550°F	10	8	Well

* Use the off-set rack only in rack position 6.

Setting Oven Controls

Cakes Breads

The Cakes Breads functions are designed to give optimum baking performance for Cakes or Breads. These functions work well for baking cakes, brownies, pies (fresh or frozen), baked custards, cheesecakes, breads, rolls, biscuits, muffins and cornbread.

The Cakes function provides a preheat with a gentle cycling of heat giving cakes more volume and allowing delicate foods to cook more evenly.

The Breads function adds a special preheat feature to the bake cycle that thoroughly heats the oven from top to bottom to give more evenly browned foods.

To set the Cakes or Breads features with a default temperature of 350°F:

1. Arrange interior oven racks when cool. Preheat oven as desired and place food in oven.
2. For Cakes, press the **Cakes Breads** until **CAKES** appears in the oven control display.

For Breads, press the **Cakes Breads** until **BREADS** appears in the oven control display

3. Press  .



Figure 31: Oven set for Cake baking



Figure 32: Oven set for Bread baking

Important note:

- Dark or dull pans and glass absorb more heat than shiny bakeware resulting in dark, over browned, or under cooked foods. To prevent this it may be necessary to reduce the oven temperature or cook time of some foods.
- Do not open the oven door too often. Opening the door will reduce the temperature in the oven.
- Breads will have better results baking on a single oven rack.
- Layer cakes will have best results using the Cakes function.

Baking layer cakes with 1 or 2 oven racks

For best results when baking cakes or cookies using 2 oven racks, place cookware on rack in positions 3 and 5 (6 if using the offset oven rack). For best results when baking cakes or cookies using a single oven rack, place offset oven rack in positions 3 or 4.

Meat Probe

When cooking meat such as roasts, hams or poultry, use the meat probe function to check the internal temperature without any guesswork. For some foods, especially poultry and roasts, testing the internal temperature is the best method to insure properly cooked meats.

Important note:

- Use **ONLY** the meat probe supplied with appliance. Using any other probe or device may result in damage to appliance and the meat probe receptacle.
- Never leave or store meat probe inside oven.
- Handle the meat probe carefully when inserting and removing from food or probe receptacle. Do not use tongs to pull on meat probe cable when inserting or removing from food or receptacle.
- Defrost food completely before inserting meat probe to avoid damaging probe.
- To avoid possibility of burns, after cooking carefully unplug meat probe using a pot holder to protect hands.

Proper meat probe placement:

Always insert meat probe so that the probe tip rests in the center of the thickest part of meat. Do not allow meat probe to touch bone, fat, gristle or cookware.

For bone-in ham or lamb, insert meat probe into the center of lowest large muscle or joint. For dishes such as meat loaf or casseroles, insert meat probe into center of food. When cooking fish, insert meat probe just above the gill.

For whole poultry or turkey, insert meat probe into the thickest part of inner thigh, below the leg (Figure 33).

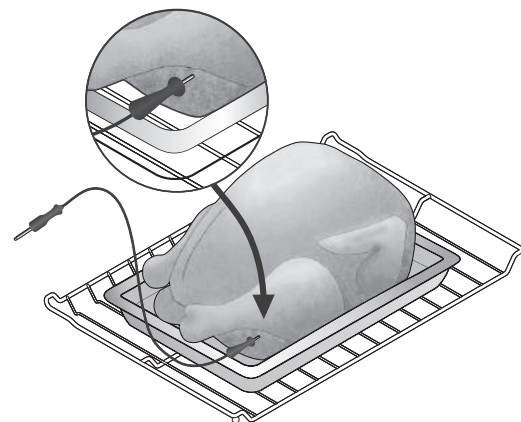

Figure 33: Probe into thickest part of thigh

Meat Probe (cont'd)

Important note:

Changing how the oven reacts after reaching the target temperature must be done before starting the cooking process.

To set meat probe:

1. Prepare the food and properly insert the temperature probe into the food. **DO NOT** preheat or start cooking before properly inserting the meat probe. Probe should be inserted into the food and receptacle while the oven is still cool.
2. Place the prepared food on the desired oven rack position and slide into the oven.

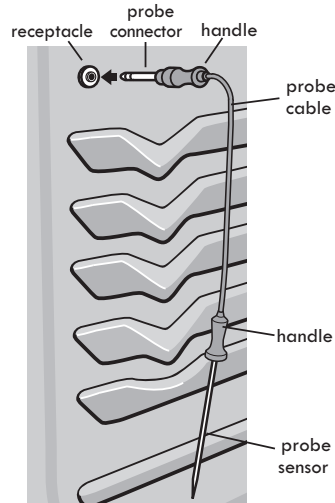

3. Plug the meat probe into the probe receptacle located on the left front oven cavity side.
4. When the meat probe is correctly plugged in to receptacle, the probe icon will illuminate in the oven control display.
5. To set the target temperature press **Meat Probe** once then enter the desired target internal temperature using the numeric key pads (default setting is 170°F/ 77°C). Press to accept the meat probe target temperature. Close the oven door.
6. Set the oven control for Bake, Conv Bake or Conv Roast and the desired oven temperature. The meat probe cannot be set with Broil or Self Clean.
7. During the cooking process the actual meat probe temperature will display by default. To view the target temperature press the Meat Probe once. After 6 seconds the display will show the actual meat probe temperature. If the target temperature needs to be changed during the cooking process, press **Meat Probe** once and use the numeric keys to adjust the target temperature. Press to accept any change.
8. The oven control will provide 3 beeps when the internal target temperature is reached. By default the oven will automatically change to a Warm & Hold setting. The Warm & Hold function will maintain the oven temperature at 170° F (77°C). Instructions for changing how the oven reacts after reaching the internal target temperature may be found later in this section.
9. Press to cancel cooking at any time.

To set the oven to continue cooking after reaching the probe target temperature:

1. Press **Meat Probe** and hold for 6 seconds.
2. Press **Self Clean** and toggle until the **Continu** message appears then press to accept.

To set the oven to cancel cooking and automatically start Warm & Hold after reaching the probe target temperature:

1. Press **Meat Probe** and hold for 6 seconds.
2. Press **Self Clean** and toggle until **CANCEL** message appears then press to accept.



Figure 34: Probe set to continue cooking



Figure 35: Probe set to cancel cooking

Minimal Internal Cooking temperatures

Food type	Internal temperature
Beef, veal, lamb-roasts, steak & chops	
Medium	160°F (71°C)
Well done	170°F (77°C)
Fresh pork-roasts, steaks & chops	
Medium	160°F (71°C)
Well done	170°F (77°C)
Ham	160°F (71°C)
Poultry	
Whole chicken, turkey	165°F (74°C)
Poultry breasts, roasts	165°F (74°C)
Stuffing (cooked alone or in bird)	165°F (74°C)
Leftovers	165°F (74°C)

Information courtesy the U.S. Department of Agriculture Food Safety and Inspection Service.

The U.S. Department of Agriculture states, "Rare fresh beef is popular, but you should know that cooking it to only 140°F/60°C means some food poisoning organisms may survive." (Source: Safe Food Book, Your Kitchen Guide, USDA Rev. June 1985.) The lowest temperature recommended by the USDA is 145°F/ 63°C for medium rare fresh beef.

Setting Oven Controls

Setting Slow Cook

The Slow Cook function may be used to cook foods more slowly and at lower oven temperatures. Slow Cook provides cooking results much the same way as a Slow Cooker or Crock-Pot.

Slow Cook is ideal for roasting beef, pork & poultry. Slow cooking meats may result in the exterior of meats becoming dark but not burnt. This is normal.

For Slow Cook two settings are available, high (Hi) or low (Lo). The high setting is best for cooking foods from a 4 to 5 hour time period. The low setting is best for cooking foods from a 8 to 9 hour time period.

Some tips for best results when using Slow Cook:

- Completely thaw all frozen foods before cooking with the Slow Cook.
- When using a single oven rack, place in oven rack position 2 or 3.
- Position multiple racks to accommodate size of cooking utensils when cooking multiple food items.
- Do not open the oven door often or leave the door open when checking foods. If the oven heat escapes often, the Slow Cook time may need to be extended.
- Cover the foods to keep them moist or use a loose or vented type cover to allow foods to turn crisp or brown.
- Roasts may be left uncovered so browning can occur. Cook times will vary; depending on the weight, fat content, bone & the shape of the roast.
- Use the recipe's recommended food temperature and a food thermometer to determine when the food is done.
- Preheating the oven will not be necessary when using the Slow Cook feature.
- Add any cream or cheese sauces during the last hour of cooking.

⚠ WARNING FOOD POISONING HAZARD. Do not let food sit for more than one hour before or after cooking. Doing so can result in food poisoning or sickness. Foods that can easily spoil such as milk, eggs, fish, meat or poultry, should be chilled in the refrigerator first. Even when chilled, they should not stand in the oven for more than 1 hour before cooking begins, and should be removed promptly when finished cooking.

To set Slow Cook:

1. Position cookware in oven and close oven door.
2. Press **Slow Cook**. **HI** will appear in the display indicating the default temperature setting is for high.
3. If a low setting is needed, press **Slow Cook** again to select the low setting.
4. Press  to activate Slow Cook.

To cancel Slow Cook at any time press .

Important note:

- Slow Cook may be used with additional settings of Cook Time and Delay Start.
- The maximum cook time for Slow Cook function is 11 hours and 59 minutes unless the control has been changed to the continuous Bake mode.

Warm & Hold™

Warm & Hold will keep cooked foods warm for serving up to 3 hours after cooking has finished. After 3 hours the Warm & Hold will shut-off automatically. Warm & Hold should only be used with foods that are already at serving temperatures. Warm & Hold will maintain the oven temperature at 170° F (77°C).



⚠ WARNING FOOD POISONING HAZARD. Do not let food sit for more than one hour before or after cooking. Doing so can result in food poisoning or sickness. Foods that can easily spoil such as milk, eggs, fish, meat or poultry, should be chilled in the refrigerator first. Even when chilled, they should not stand in the oven for more than 1 hour before cooking begins, and should be removed promptly when finished cooking.

To set Warm & Hold:

1. If needed, arrange oven racks and place cooked food in oven.
2. Press **Warm & Hold**. **Hld** will appear in the display. If no other keys are touched within 25 seconds the request for Warm & Hold will clear.
3. Press . Warm & Hold will automatically turn off after 3 hours.

To turn Warm & Hold off at any time press .

To add Warm & Hold to automatically turn ON after baking 45 minutes with default oven set temperature of 350°F:

1. Press **Cook Time**.
2. Enter **4 5** using numeric keypad.
3. Press  to accept.
4. Press **Bake**.
5. Press  to accept.
6. Press **Warm & Hold**. **Hld** will appear in the display.
7. Press  to accept. When the cook time is over, the Warm & Hold will automatically turn ON. The Warm & Hold function will automatically turn OFF after 3 hours.



Important note:

- Warm & Hold will maintain the oven temperature at 170° F (77°C) for 3 hours.
- Warm & Hold may be set when finished cooking or may be added to automatically turn on after cooking using Cook Time. Delay Start may also be added.

Recipe Recall

Use the Recipe Recall feature to record and recall your favorite baking recipe settings. This feature stores and recalls different recipe settings using Bake, Conv Bake, and Conv Roast Recipe Recall may be programmed for any baking temperature between 170° F (77°C) to 550° F (288°C).

To store a Bake recipe. The recipe in this example is for a Bake at 325°F with a cook time of 45 minutes:

1. Press **Bake**.
2. Press **3 2 5** using the numeric keys to enter oven temperature.
3. Press .
4. Press **Cook Time**.
5. Press **4 5** using numeric keys to enter cook time.
6. Press and hold  until a tone sounds (about 3 seconds). The tone indicates that the recipe setting has been recorded for future recall.
7. Press .

Important note: The oven will automatically start heating with the recorded recipe unless  is pressed at this time.

To recall recipe stored in the example shown above. Recipe is for bake at 325°F for 45 minutes:

1. Position cookware in oven and close door.
2. Press **Bake**. (If recipe was stored using another cooking feature press that instead.)
3. Press . The oven will begin to cook with the programmed recipe. If Cook Time was recorded this feature will also recall the cooking time.

To cancel Recipe Recall at anytime press .

To erase a stored recipe:

1. Press the function where the recipe is stored.
2. Press .
3. Press **Cook Time**, enter **0 (zero)** and hold **start key** for 3 seconds until you hear the acceptance tone.

Important note:

- The Recipe Recall stores **Bake, Conv Bake, Conv Roast, Slow Cook, Cakes Breads and Preheat settings**. This feature will not work with **Delay Start** settings.
- If a recalled recipe includes Cook Time the oven will automatically shut-off when the Cook Time is finished.

Accent Light



Figure 36: Accent light feature located beneath oven controls

Your appliance includes a decorative Accent light at the base of the oven controls panel. The Accent light provides a theatre style intensity feature that slowly increases brightness at turn on and slowly fades when turning off.

When the Accent light is off, the light operates in automatic mode. This means the Accent light will turn on automatically when an oven, cooktop function or feature such as the Timer have been activated. The Accent light will turn off automatically when these functions or features are no longer active.

When the Accent light is OFF, it may be manually turned ON by pressing **Accent Light** once. When the Accent light has been manually turned on, it will remain on until manually turned off by pressing **Accent Light** again. The Accent light brightness is adjustable from 0 to 100 percent.

To adjust Accent light brightness:

1. Press and hold **Accent Light** until an acceptance tone sounds (about 6 seconds).
2. The default brightness setting of 100 will appear in the display (Figure 37).
3. Using the numeric keys, enter any digit from 0 to 100 to change the brightness level. Entering 0 (Figure 38) will effectively turn the Accent light OFF until the brightness level is adjusted to a higher level.
4. Press  to save the desired brightness setting.

Note: To check the brightness level after adjusting, press the Accent Light key once. For further adjustment repeat steps 1, 3 and 4 above.



Figure 37: Accent light at highest intensity



Figure 38: Accent light at lowest setting

Operating oven lights

The interior oven lights will automatically turn ON when the oven door is opened.

Press  to turn the interior oven lights ON and OFF whenever the oven door is closed. The oven light will not operate in Self Clean.

The interior oven lights are located on the rear wall of the oven interior and are covered with a glass shield. The glass shield protects the bulb from high temperatures and should always be in place whenever the oven is in use.

To replace the interior oven light, see **Replacing oven lights** in the **Care & Cleaning** section.

Adjusting oven temperatures

Your appliance has been factory calibrated and tested to ensure an accurate baking temperature. For the first few uses, follow your recipe times and temperature recommendations carefully. If you think the oven is cooking too hot or too cool for your recipe times, you may adjust the control so the oven cooks hotter or cooler than the oven temperature displayed.

The oven temperature may be increased as much as +35°F (+19°C) or decreased -35°F (-19°C) from the factory calibrated settings.

To increase (+) or decrease (-) the oven temperature by 20°F:

1. Press and hold **Bake** until the control provides the 2 audible tone (about 6 seconds).
2. Enter **2 0** using numeric keypad.
3. Press **Self Clean** to toggle between plus (+) if increasing temperature or minus (-) if decreasing the temperature.
4. Press  to accept change.

Important note:

- Oven temperature adjustments made will not change the Broil or Self Clean function temperatures.
- If the temperature shows an adjustment of -20°F, and a +20°F adjustment is needed, you can toggle between the minus (-) or plus (+) in the display by pressing **Self Clean**.
- **DO NOT USE** oven thermometers such as those found in grocery stores to check the temperature settings inside your oven. These oven thermometers may vary as much as 20 to 40°F degrees from actual temperatures.
- The oven temperature adjustment may be made if your oven control has been set to display °C (Celsius) temperatures. Minimum and maximum settings for Celsius is plus (+) or minus (-) 19°C.

Restoring factory default settings

When new, your appliance left the factory with predetermined oven control settings. Over time, the user may make changes to these default settings. The following options have user settings that may be modified and may have been set with changes since the appliance was new:

- 12 or 24 hour display mode
- Continuous bake or 12-Hour Energy Savings mode
- Silent or audible control
- Oven temperature display (Fahrenheit or Celsius)
- Oven temperature adjustments
- Stored recipes

⚠ CAUTION If you choose to restore to factory default settings, **ALL** of the above user settings will be restored to factory default settings, the oven temperature offset will reset and any stored recipe information will be cleared.

To restore oven control to factory default settings:

1. Press and hold the **7** key until acceptance tone sounds (about 6 seconds).
2. Press  . The control has been reset with the default settings.

Setting Oven Controls

Setting the Sabbath feature (for use on the Jewish Sabbath and Holidays)



For further assistance, guidelines for proper usage and a complete list of models with the Sabbath feature, please visit the web at www.star-k.org.

The **Cook Time** and **Delay Start** keys are used to set the Sabbath feature. The Sabbath feature may only be used after the **Bake** function is active.

Once the oven is properly set using the **Bake** function and the Sabbath mode is active, the oven will remain continuously ON until the Sabbath feature is cancelled. The Sabbath feature will override the factory preset 12-Hour Energy Saving feature and start the continuous bake mode.

⚠ WARNING FOOD POISONING HAZARD. Do not let food sit for more than one hour before or after cooking. Doing so can result in food poisoning or sickness. Foods that can easily spoil such as milk, eggs, fish, meat or poultry, should be chilled in the refrigerator first. Even when chilled, they should not stand in the oven for more than 1 hour before cooking begins, and should be removed promptly when finished cooking.

To program oven to Bake with default oven temperature of 350°F and activate the Sabbath feature:

1. Be sure the clock is set with the correct time of day.
2. Arrange oven racks, place cookware in oven and close oven door.
3. Press **Bake**.
4. Press .
5. If Cook Time or Delay Start are not needed, **skip this step and continue to step 6**. If a Cook Time or Delay Start are desired enter the times at this point. Refer to the Cook Time and Delay Start sections for detailed instructions.
6. Press and hold both **Cook Time** and **Delay Start** keys simultaneously for about 3 seconds to set the Sabbath feature. Once the feature is set, **SAb** (Figure 39) will appear in the display indicating the oven is properly set for the Sabbath feature.

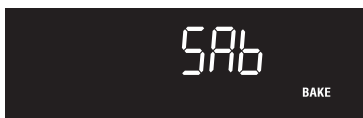







Figure 39: Oven showing Sabbath setting

Important note:

- It is not advised to attempt to activate any other oven function except Bake while the Sabbath feature is active. ONLY the following keys will function correctly when the Sabbath feature is active: 0-9 number keys, Bake,  and . ALL OTHER KEYS should not be used once the Sabbath feature is active.
- You may change the oven temperature once baking has started. Press **Bake**, use the numeric keys to enter the oven temperature change (170 to 550°F) and press  (for Jewish Holidays only). Remember that the oven control will no longer provide audible tones or display any further changes when the Sabbath feature is active.
- It is recommended that any oven temperature change with the Sabbath feature active be followed with two presses of the  key. This will insure the oven remains ON even if the attempt to set the oven temperature was lower or higher than the oven control can accept. If the oven temperature is set incorrectly, the oven temperature will default to 170°F or 550°F. Try to set the desired oven temperature again.
- If the oven light is needed during the Sabbath, press  to turn oven light on before activating the Sabbath feature. Once the oven light is turned ON and the Sabbath feature is active, the oven light will remain on until the Sabbath feature is turned OFF. If the oven light needs to be off, be sure to turn the oven light off before activating the Sabbath feature.
- Remember the oven will shut-off automatically after completing a Cook Time, Delay Start or Warm & Hold and therefore may only be used once during the Sabbath/Jewish Holidays.
- If a Delay Start time longer than the default 11 hours and 59 minutes is desired, set the oven control for the 24 hour day display mode setting. For detailed instructions See “Setting 12 or 24 hour display mode”.

Sabbath Feature (cont'd)

To turn the oven off and keep the Sabbath feature active:

Press .

To turn off the Sabbath feature:

Press and hold both **Cook Time** and **Delay Start** simultaneously for at least 3 seconds to turn the Sabbath feature off. The control will provide an acceptance tone and **SAb** will disappear from the display. The oven is no longer programmed for the Sabbath feature.

What to do during a power failure or power interruption after the Sabbath feature was activated:

Should you experience a power failure or interruption, the oven will shut-off. When power is restored the oven will not turn back on automatically. The oven will remember that it is set for the Sabbath and the oven display will show the message **SF** for Sabbath failure (Figure 40).



Figure 40: Display showing power failure in Sabbath mode

The food may be safely removed from the oven while still in the Sabbath feature, however the oven cannot be turned back on until after the Sabbath/Holidays. After the Sabbath observance turn OFF the Sabbath feature. Press and hold both **Cook Time** and **Delay Start** keys for at least 3 seconds simultaneously to turn the Sabbath feature off. **SF** will disappear from the display and the oven may be used with all normal functions.

Proof Bread (Warmer Drawer)

The warmer drawer has a Proof Bread feature that may be used to prepare bread dough. The recommended length of time to keep fresh or thawed bread dough in the warmer drawer is about 45-60 minutes. Times may vary depending on the dough. Be sure however to follow the recipe's recommended times.

Since the bread dough will nearly double in volume be sure to place the prepared dough in a large bowl. Arrange the warmer drawer rack in the downward position (Figure 41) and place the bowl with dough on the warmer drawer rack.

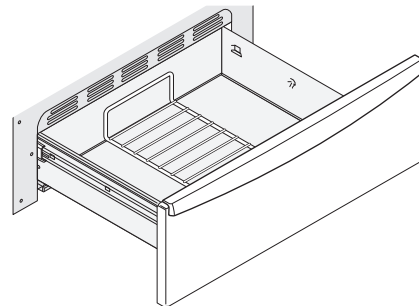

Figure 41: Warmer drawer rack down for proofing bread

To set Proof Bread using warmer drawer:

1. Arrange the warmer drawer rack in warmer drawer and place bread dough in a large bowl on warmer drawer rack. Close warmer drawer.
2. Press **ON-OFF** to turn ON warmer drawer.
3. Press **Lo** once set warmer drawer to Lo power setting.
4. Press **Lo** again to activate Proof Bread feature. The Proof Bread indicator light will glow when the Proof Bread feature is active (Figure 42).
5. When the bread dough is ready, press **ON-OFF** to turn the warmer drawer off and remove bread dough from warmer drawer.

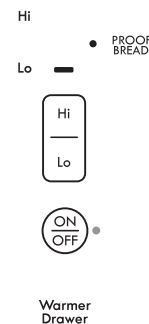

Figure 42: Bread Proof indicator light

Setting Oven Controls

Warmer Drawer

The purpose of the warmer drawer is to keep hot cooked foods at serving temperatures such as vegetables, gravies, meats, casseroles, biscuits, rolls and pastries. It is not recommended to heat cold food in the warmer drawer; always start with hot food.

The warmer drawer may also be used to warm dinner plates. All food placed in the warmer drawer should be covered with a lid or aluminum foil to maintain quality.

⚠ WARNING FOOD POISONING HAZARD. Do not let food sit for more than one hour before or after cooking. Doing so can result in food poisoning or sickness. Foods that can easily spoil such as milk, eggs, fish, meat or poultry, should be chilled in the refrigerator first. Even when chilled, they should not stand in the oven for more than 1 hour before cooking begins, and should be removed promptly when finished cooking.

⚠ WARNING Storage in or on appliance—flammable materials should not be stored in an oven, warmer drawer, near surface units. This includes paper, plastic and cloth items, such as cookbooks, plastic ware and towels, as well as flammable liquids. Do not store explosives, such as aerosol cans, on or near the range.

⚠ WARNING DO NOT LEAVE CHILDREN ALONE — children should not be left alone or unattended in the area where appliance is in use. They should never be allowed to sit or stand on any part of the appliance, including the warmer drawer.

⚠ CAUTION Always use pot holders or oven mitts when removing food from the warmer drawer as cookware and plates will be hot and you can be burned.

Important note:

The warmer drawer is equipped with a catch that may require extra force to open and close the drawer.

Arranging warmer drawer rack positions

The keep warmer drawer rack may be used in 2 ways:

- In the **upright position** (Figure 43) to allow low profile food items to be placed both under and on top of the rack (for example, rolls or biscuits on top of the rack and a casserole dish underneath).
- In the **downward position** (Figure 44) to allow for light weight food items and empty cookware (for example, rolls or pastries and dinner plates) on the rack.

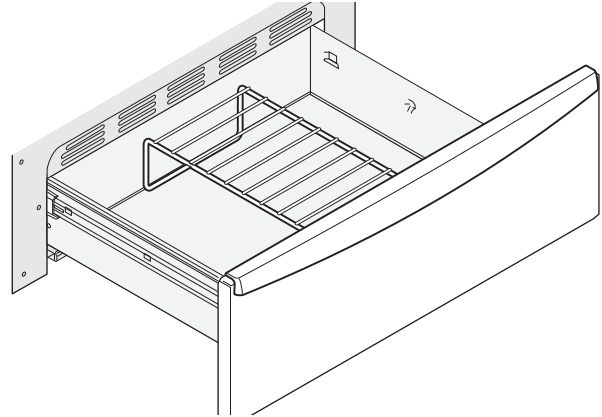

Figure 43: Warmer drawer rack in upright position

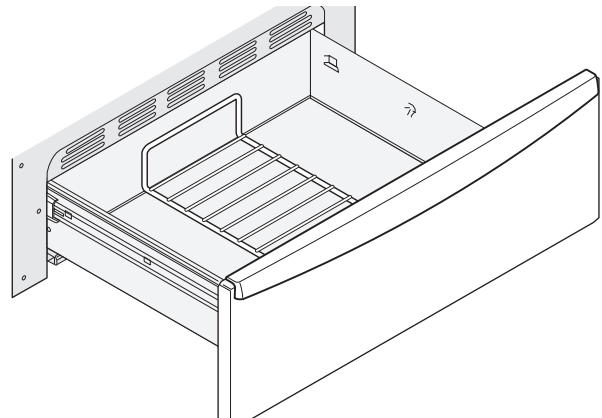

Figure 44: Warmer drawer rack in downward position

Warmer Drawer Controls

The warmer drawer control is located on the left side of the control panel. Use the warmer drawer control key to turn ON and OFF and make temperature adjustments. Available temperature settings are approximate, and are designated by Lo, Med, and Hi (Figure 46). If needed, refer to Warmer drawer recommended food settings provided in this section.

Warmer drawer indicator light

The warmer drawer indicator light is located beside the ON-OFF key (Figure 45). It glows when the warmer drawer is turned ON, and remains on until the warmer drawer is turned OFF

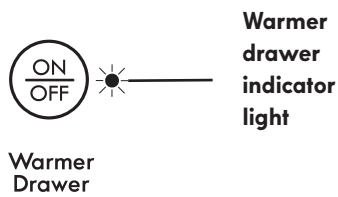



Figure 45: Warmer drawer indicator light

To set warmer drawer:

1. Arrange the warmer drawer rack (if needed) in the warmer drawer and place the cooked food or dishes in the warmer drawer. Close warmer drawer.
2. Press .
3. Press **Hi Lo** key to toggle to the desired temperature setting. Release when the desired temperature setting is displayed by the indicator lights. (Figure 46).
4. Once warming is finished, press  to turn OFF and carefully remove items from warmer drawer.

CAUTION Always use potholders or oven mitts when removing food from the warmer drawer as cookware and plates will be hot and you can be burned.

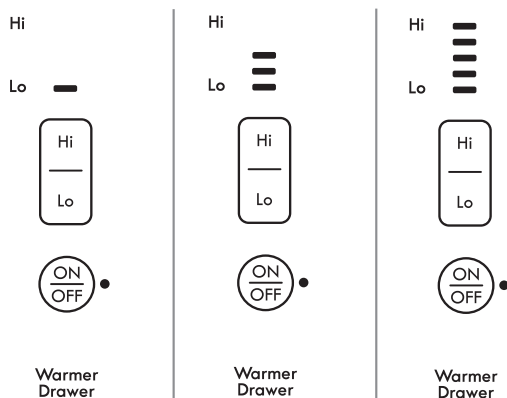

Figure 46: Setting desired temperature in warmer drawer

Warmer Drawer settings

The recommended warmer drawer food settings shown are meant to be used as a recommendation only. If a particular food item is not listed, start with the **Med** setting. If more crispness is desired, remove the lid or aluminum foil from the food.

Most foods may be maintained at serving temperatures on the **Med** setting. When a combination of foods are to be kept warm (for example, a meat with 2 vegetables and rolls) use the **Hi** setting. To minimize heat loss, avoid opening the warmer drawer frequently while in use.

Warmer drawer recommended food settings

Food Item	Setting
Bacon	Hi
Hamburger patties	Hi
Poultry	Hi
Pork chops	Hi
Fried food	Hi
Pizza	Hi
Gravies	Med
Casseroles	Med
Eggs	Med
Roasts (beef, pork, or lamb)	Med
Vegetables	Med
Biscuits	Med
Rolls (hard)	Med
Pastries	Med
Rolls (soft)	Lo
Empty dinner plates	Lo

Important note:

- **Do not use plastic wrap to cover food.** Plastic may melt onto the drawer and be very difficult to clean up. Use only utensils and cookware recommended by the manufacturer for use a warmer drawer.
- Always start with hot food when using the warmer drawer. **DO NOT** heat cold food in the warmer drawer.
- Self Clean can not be set when the warmer drawer is active.

Removing and replacing warmer drawer

⚠ WARNING Electrical shock hazard can occur and result in serious injury or death. Disconnect appliance from electric power before cleaning and servicing the warmer drawer.

To remove the warmer drawer:

1. Turn power OFF to the appliance before removing the warmer drawer.
2. Open the warmer drawer completely.
3. On left warmer drawer rail, locate black release lever and press up with finger while pulling out slightly on the oven drawer handle. On right warmer drawer rail, locate black release lever and press down with finger while pulling out slightly on the warmer drawer handle (Figure 47).
4. The warmer drawer should now be released from the rails. Remove warmer oven drawer (using level & square motion) completely out and away from the appliance.

To replace the warmer drawer:

1. Pull the bearing glides to the front of the outer compartment glide channels until they snap into place (Figure 49).
2. Carefully line up both sides of the warmer drawer glide rails to the outer compartment glide channels located inside the empty warmer drawer compartment (Figure 48).
3. While holding the warmer drawer level and square using the warmer drawer handle, push (do not force) the warmer drawer all the way into the outer compartment glide channels all the way into the range. Open the warmer drawer again to verify the glides have seated.
4. If you do not hear the levers click into place or the bearing glides do not feel seated remove the warmer drawer and repeat steps 1 through 3. This will minimize possible damage to the bearing glides.

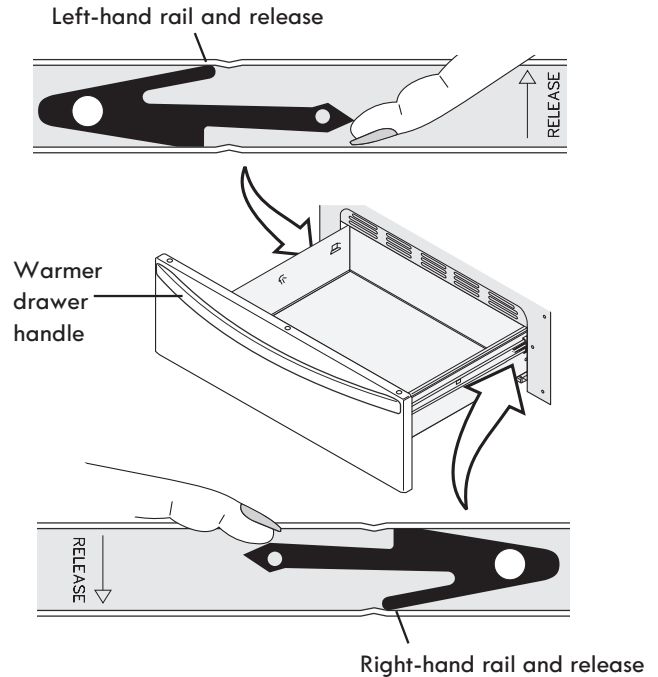

Figure 47: Warmer drawer releases

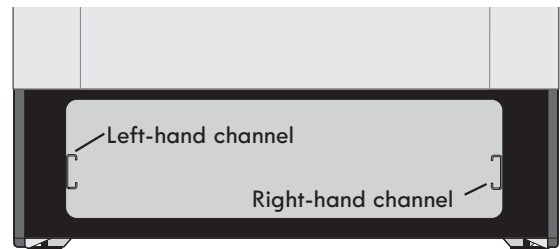

Figure 48: Warmer drawer channels

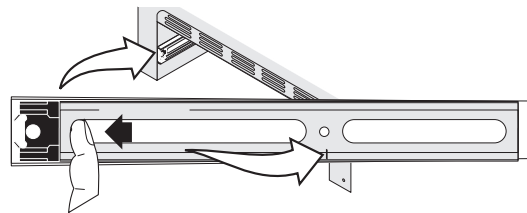

Figure 49: Warmer drawer glides

Self Clean

A self-cleaning oven cleans itself with high temperatures that are well above normal cooking temperatures. The high cleaning temperature eliminates soils completely or reduces them to a fine powdered ash you can wipe away afterwards with a damp cloth.

The Self Clean function allows you to set any amount of cleaning time from 2 hours to 4 hours. A 3-hour cleaning time is best used for normal cleaning; 2-hour time for light soils and a 4-hour clean time for heavier stubborn soils.

Read before starting Self Clean

Be sure to read all the following caution and important statements **BEFORE** starting the self-cleaning cycle:

⚠ CAUTION **DO NOT** leave small children unattended near the appliance. During the self-cleaning cycle, the outside of the range can become very hot to touch and can cause burns.

DO NOT line the oven walls, racks, bottom or any other part of the range with aluminum foil. Doing so will destroy heat distribution, produce poor baking results and cause permanent damage to the oven interior. Aluminum foil will melt to the interior of the oven.

The health of some birds is extremely sensitive to the fumes given off during the self-cleaning cycle of any range. Move birds to another well-ventilated room.

DO NOT force the oven door open. This can damage the automatic door locking system.

Use caution when opening the oven door after self-cleaning. **The oven may still be VERY HOT** and can cause burns. To avoid possible burns stand to the side of the oven when opening the oven door to allow hot air or steam to escape.

Important note:

Completely remove **ALL OVEN RACKS** and **ANY ACCESSORIES FROM OVEN CAVITY** to avoid damage to oven racks. If the oven racks are not removed they may discolor.

Remove **ALL** items from the oven and cooktop including cookware, utensils and **ANY ALUMINUM FOIL**. Aluminum foil will not withstand high temperatures from a self-clean cycle and will melt.

This model comes with lubricated porcelain oven racks, which can remain in the oven during the self-clean cycle. Do not clean this vegetable oil lubrication off the racks. It is important that the sides of the oven racks always have a light coating of vegetable oil. To maintain optimal rack performance, re-apply a thin layer of vegetable oil to the sides of the rack after every self-clean cycle or when the rack becomes difficult to slide.

DO NOT use oven cleaners or oven protective coatings in or around any part of the oven interior. Clean any soil from the oven frame, the door liner outside the oven door gasket and the

small area at the front center of the oven bottom (Figure 50). These areas heat sufficiently to burn soil on. Clean using soap and water prior to starting Self Clean.

Remove any excessive spill overs. Any spills on the oven bottom should be wiped-up and removed before starting a self-clean cycle. To clean, use hot, soapy water and a cloth. Large spill overs can cause heavy smoke or fire when subjected to high temperatures. **DO NOT** allow food spills with a high sugar or acid content (such as milk, tomatoes, sauerkraut, fruit juices or pie filling) to remain on the surface as they may leave a dull spot even after cleaning.

DO NOT clean the oven door gasket (Figure 50). The woven material of the oven door gasket is essential for a good seal. Care should be taken not to rub, damage or remove the gasket. **DO NOT** use any cleaning materials on the oven door gasket. Doing so could cause damage to the door gasket.

The cooktop should not be used during a self-clean cycle. On some models, turning on any cooktop surface burner will cause the clean cycle to cancel. If the clean cycle is canceled, the oven control display will show "SPr" for 5 seconds. The oven door will remain locked until the oven has cooled down below cleaning temperature. If the oven is below cleaning temperature, the user can start another clean cycle immediately. If the oven is in cleaning temperature range, another self-clean cycle can be set once the door unlocks (up to 4 hours).



Figure 50: Areas to clean and to avoid

1. Be sure the oven is empty and **ALL** oven racks are removed. Remove all items from the cooktop. Be sure oven door is **completely** closed.
2. Press **Self Clean** for a default 3-hour clean time. After pressing Self Clean you may accept the default 3-hour clean time by going to step 3. At this time you may choose a different clean time. The amount of clean time must be within 2 to 4 hours and entered using the numeric keys pads. Enter **2 0 0** for a 2-hour time or enter **4 0 0** for a 4-hour self-clean time. You may choose a 2 hour 15 minute clean time by entering **2 1 5** (hours and minutes).
3. Press  to activate Self Clean.

Setting Oven Controls

Setting Self Clean (cont'd.)

As soon as Self Clean becomes active, a motor driven lock mechanism will begin locking the oven door automatically. **door Loc** will appear in the display (Figure 51). **DO NOT** open the oven door when **door Loc** is displayed (allow 15 seconds for the lock mechanism to lock the oven).

Once the oven door has locked, **CLn** will appear in the display indicating Self Clean has started (Figure 52).



Figure 51: Door locking



Figure 52: Oven in clean mode



Figure 53: Oven too hot for door to unlock



Figure 54: Door opens when oven has cooled

When Self Clean is finished

1. **CLn** message will turn off and **Hot** will appear in display window (Figure 53).
2. Once the oven has cooled down (about 1 hour) and **Hot** is no longer displayed, the **door OPn** message will appear (Figure 54). When this message turns off the oven door may be opened.

CAUTION Use caution when opening the oven door after self-cleaning. The oven may still be **VERY HOT and can cause burns**. To avoid possible burns stand to the side of the oven when opening the oven door to allow hot air or steam to escape.



3. When the oven interior has completely cooled, wipe away any residue or powdered ash with a damp cloth or paper towel.

Important note:

- The kitchen area should be well ventilated using an open window, ventilation fan or exhaust hood during the 1st self-clean cycle to help eliminate the normal odors associated with the 1st self-clean cycle.
- When the clean time finishes the oven door will remain locked until the range has cooled sufficiently. In addition to the clean time that was programmed, you must allow about 1 additional hour for the oven to cool before you will be able to open the oven door.
- The Self Clean function will not operate whenever a radiant surface element is ON or the oven lockout is active.

Setting Delay Start Self Clean

To start a delay Self Clean with default clean time of 3 hours and a start time of 9:00 o'clock:

1. Be sure the clock is set with the correct time of day, the oven is empty and ALL oven racks are removed. Be sure oven door is completely closed.
2. Press **Delay Start**.
3. Using numeric keypad enter **9 0 0**.
4. Press  to accept.
5. Press **Self Clean**.
6. Press .

If it becomes necessary to stop Self Clean when active:

1. Press .
2. If Self Clean has heated the oven to a high temperature, allow enough time for the oven to cool and the **door OPn** message to appear (Figure 54). When this message turns OFF the oven may be opened.
3. Before restarting Self Clean, be sure to read important notes below.

Important note:

- When Self Clean function is active you may check the amount of clean time remaining by pressing **Self Clean** once.
- If your control is set with the default 12 hour display mode, the Delay Self Clean can only be set to start up to 11 hours and 59 minutes in advance. To set a Delay Start Self Clean to begin 12 or more hours (maximum is 23 hours and 59 minutes) in advance, be sure to set the control for 24 hour display mode.
- If Self Clean was active and then interrupted by a power failure or cancelled before the oven was thoroughly cleaned, it may be necessary to run another self-clean cycle again. If the oven temperature was high enough when interrupted your oven control may not allow another self-clean cycle to be set for up to 4 hours after the interruption.

Care and Cleaning

Cleaning Various Parts of Your Oven

Before cleaning any part of the oven, be sure all controls are turned off and the oven is cool. Remove spills and any heavy soiling as soon as possible. Regular cleaning will reduce the difficulty of major cleaning later.

Surface Type	Recommendation
Aluminum and Vinyl	<ul style="list-style-type: none">Use hot, soapy water and a cloth. Dry with a clean cloth.
Painted body parts Painted decorative trims	<ul style="list-style-type: none">Use a soft cloth and clean with mild dish detergent and water or a 50/50 solution of vinegar and water. Follow by rinsing the area with clean water; dry and polish with a soft cloth. Glass cleaners may be used if sprayed on a soft cloth first.Do not spray liquids directly on the oven control and display area. Do not use large amounts of water on the control panel. Excess water on the control area may cause damage to the appliance. Do not use other liquid cleaners, abrasive cleaners, scouring pads, or paper towels. They will damage the finish.
Easy Clean™ Stainless Steel	<ul style="list-style-type: none">Your oven finish may be Easy Clean™ Stainless Steel (some models). Clean the stainless with warm soapy water using a clean sponge or cloth. Rinse with clean water and dry with a soft clean cloth. Do not use any store bought cleaners like stainless steel cleaners or any other types of cleaners containing any abrasive, chlorides, chlorine, or ammonia. It is recommended to use mild dish soap and water or a 50/50 solution of water and vinegar.
Porcelain coated oven racks	<ul style="list-style-type: none">This model comes with lubricated porcelain oven racks, which can remain in the oven during the self-clean cycle. Do not clean this vegetable oil lubrication off the racks. It is important that the sides of the oven racks always have a light coating of vegetable oil. To maintain optimal rack performance, re-apply a thin layer of vegetable oil to the sides of the rack after every self-clean cycle or when the rack becomes difficult to slide.
Porcelain enamel broiler pan and insert (available by mail order) Door liner and body parts	<ul style="list-style-type: none">Gentle scouring with a soapy scouring pad will remove most spots. Rinse with a 1:1 solution of clear water and ammonia. If necessary, cover difficult spots with an ammonia-soaked paper towel for 30 to 40 minutes. Rinse with clean water and a damp cloth, and then scrub with a soap-filled scouring pad. Rinse and wipe dry with a clean cloth. Remove all cleaners or the porcelain may become damaged during future heating.
Oven racks	<ul style="list-style-type: none">Oven racks must be removed from oven cavity. Clean by using a mild, abrasive cleaner following manufacturer's instructions. Rinse with clean water and dry.
Oven door	<ul style="list-style-type: none">Use soap and water to thoroughly clean the top, sides, and front of the oven door. Rinse well. You may use a glass cleaner on the outside glass of the door. Do not immerse the door in water. Do not spray or allow water or the glass cleaner to enter the door vents. Do not use oven cleaners, cleaning powders, or any harsh abrasive cleaning materials on the outside of the oven door.Do not clean the oven door gasket. On self-clean models, the oven door gasket is made of a woven material which is essential for a good seal. Care should be taken not to rub, damage, or remove this gasket.

Care and Cleaning

Cleaning the cooktop and surface burners

⚠ CAUTION To avoid possible burns DO NOT attempt any of the cleaning instructions provided below before turning OFF all of the surface burners and allow them to cool.

⚠ CAUTION Any additions, changes or conversions required in order for this appliance to satisfactorily meet the application needs must be made by an authorized qualified Agency.

Routinely clean the cooktop. Wipe with a clean, damp cloth and wipe dry to avoid scratches. Keeping the surface burner head ports and slots clean will prevent improper ignition and an uneven flame. See the following sections for more instructions.

To clean recessed and contoured areas of cooktop

If a spill occurs on or in the recessed or contoured areas, blot up spill with an absorbent cloth. Rinse with a clean, damp cloth and wipe dry.

To clean burner grates

- Clean when the grates are cool.
- Use nonabrasive plastic scrubbing pad and mild abrasive cleanser.
- Food soils containing acids may affect the finish. Clean immediately after the grates are cool.
- Thoroughly dry grates immediately following cleaning.

To clean burner caps

- Remove caps from burner heads after they have cooled.
- Clean heavy soils with a plastic scrubbing pad and absorbent cloth.
- Thoroughly dry burner caps immediately following cleaning including the bottom and inside of cap.
- Do not use abrasive cleaners. They can scratch porcelain.
- Do not clean burner caps in the dishwasher.
- Do not operate surface burners without burner caps properly in place. See IMPORTANT notes below.

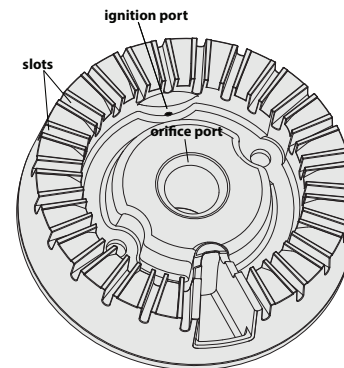

Figure 55: Cooktop burner head

To clean the surface burner heads

For proper gas flow it may be necessary to clean the burner head and slots. To clean, first use a clean DAMP cloth to soak up any spills. Remove any food from between the burner slots using a small nonabrasive brush like a toothbrush and afterwards wipe up using a damp cloth. For stubborn soils located in the slots, use a small-gauge wire or needle to clean.

Any spill on or around the electrode must be carefully cleaned. Take care not to hit the electrode with any thing hard or it could be damaged.

To clean the burner head ignition ports

Each burner head has a small ignition port located as illustrated. Should you experience ignition problems it may be that this port hole is partially blocked with soil. With the burner head in place, use a small wire gauge needle or the end of a paper clip to clear the ignition port (refer to [Figure 55](#); round style shown; oval models on some models not shown).

Important: Always keep the surface burner caps in place whenever a surface burner is in use.

When replacing the burner caps, be sure the burner caps are seated firmly on top of the burner heads.

The surface burner heads are secured to the cooktop and must be cleaned in place on the cooktop. For proper flow of gas and ignition of burners.

DO NOT allow spills, food, cleaning agents or any other material to enter the gas orifice holder opening.

General Cleaning

Refer to the Cleaning recommendation information in the Care and Cleaning section for more details about cleaning specific parts of the range.

⚠ CAUTION Before manually cleaning any part of the range, be sure all controls are turned off and the range is cool. **The range may be hot and could cause burns.**

⚠ CAUTION Ammonia must be rinsed before operating the oven. Provide adequate ventilation.

Aluminum foil and utensils

⚠ WARNING NEVER cover any slots, holes, or passages in the oven bottom and never cover an entire oven rack with materials such as aluminum foil.

Doing so blocks the air flow through the oven and may cause CARBON MONOXIDE poisoning.

Aluminum foil linings may trap heat and cause a fire hazard.

Aluminum foil - Use of aluminum foil on a hot cooktop can damage the cooktop.

- Do not use thin aluminum cooking utensils or allow aluminum foil to touch the surface burners under ANY circumstances.

Aluminum utensils - The melting point of aluminum is much lower than that of other metals. Care must be taken when aluminum pots or pans are used on the cooktop.

- If aluminum pans are allowed to boil dry when using the cooktop, the cookware may be damaged or destroyed.

Replacing the oven light

⚠ CAUTION Be sure the oven is unplugged and all parts are cool before replacing oven light.

The interior oven lights are located at the rear of the oven cavity. (See [Figure 56](#)).

To replace the oven interior light bulbs:

Important note:

Use a paper towel or cotton glove while handling the new bulb when installing.

1. Turn electrical power off at the main source or unplug the appliance.
2. Replace bulb with a new Halogen bulb.
3. Turn power back on again at the main source (or plug the appliance back in).
4. Be sure to reset the time of day on the clock.

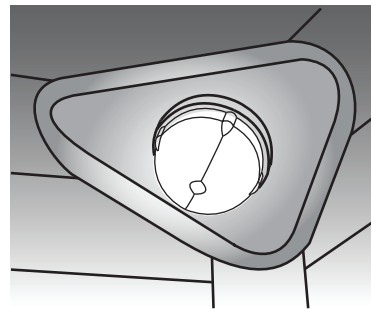

Figure 56: Replacing oven light

Removing and Replacing the Oven Door

⚠ CAUTION The door is heavy. For safe, temporary storage, lay the door flat with the inside of the door facing down.

To remove the oven door:

1. Open oven door completely, horizontal with floor (See [Figure 57](#)).
2. Pull the door hinge locks on both left and right door hinges down from the oven frame completely toward the oven door (See [Figure 58](#)). A tool such as a small flat-blade screwdriver may be required.
3. Firmly grasp both sides of oven door along the door sides. Do not use the oven door handle (See [Figure 59](#)).
4. Close the door to approximately 10 degrees from the oven door frame.
5. Lift the oven door hinge arms over the roller pins located on each side of the oven frame (See [Figure 59](#)).

To replace oven door:

1. Firmly grasp both sides of oven door along the door sides. Do not use the oven door handle (See [Figure 59](#)).
2. Holding the oven door at the same angle as the removal position (See [Figure 59](#)), seat the hook of the hinge arm over the roller pins located on each side of the oven door frame (See [Figure 60](#)). The hook of the hinge arms must be fully seated onto the roller pins.
3. Fully open the oven door, horizontal with floor (See [Figure 57](#)).
4. Push the door hinge locks up toward and into the oven frame on both left and right oven door hinges to the locked position ([Figure 58](#)).
5. Close the oven door.

Important:

Special Door Care Instructions:

- Most oven doors contain glass that can break.
- Do not close the oven door until all the oven racks are fully in place.
- Do not hit the glass with pots, pans, or any other object. Scratching, hitting, jarring, or stressing the glass may weaken its structure causing an increased risk of breakage at a later time.

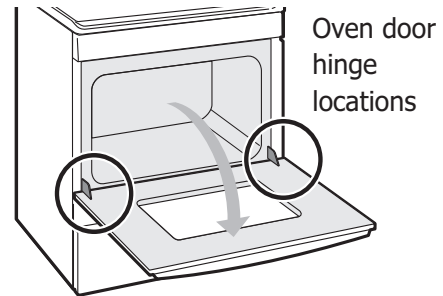

Figure 57: Door hinge location

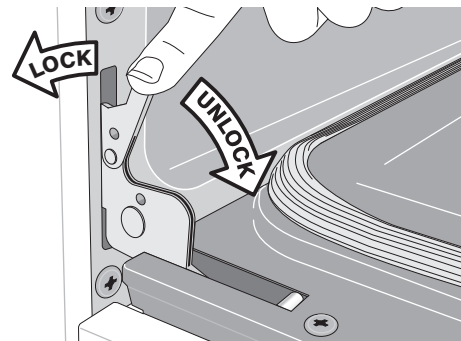

Figure 58: Door hinge locks

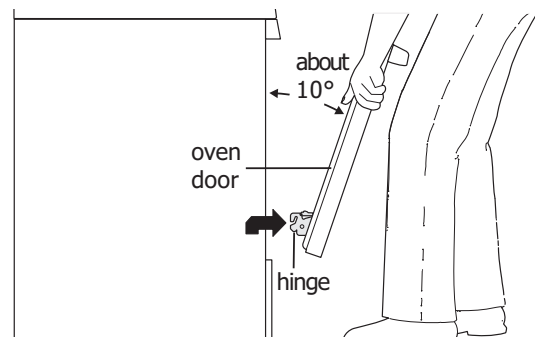

Figure 59: Holding door for removal

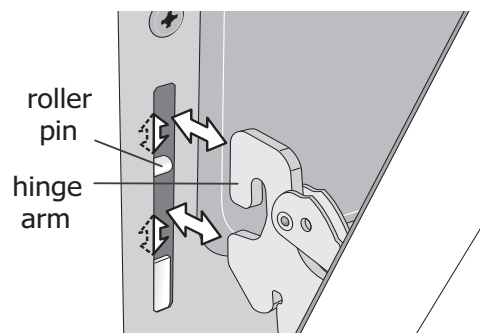

Figure 60: Location of hinge arm and roller pin





Before You Call

Oven Baking

For best cooking results, heat the oven before baking cookies, breads, cakes, pies or pastries, etc. There is no need to preheat the oven for roasting meat or baking casseroles.

The cooking times and temperatures needed to bake a product may vary slightly from your previously owned appliance.

Baking Problems and Solutions

Baking Problems	Causes	Corrections
Cookies and biscuits burn on the bottom. 	<ul style="list-style-type: none"> • Cookies and biscuits put into oven before the preheating time is completed. • Oven rack is overcrowded. • Dark pans absorb heat too fast. 	<ul style="list-style-type: none"> • Allow oven to preheat to desired temperature before placing food in oven. • Choose pan sizes that permit 2" to 4" of air space (5.1 cm to 10.2 cm) on all sides when placed in the oven. • Use a medium weight baking sheet.
Cakes too dark on top or bottom 	<ul style="list-style-type: none"> • Cakes put in oven before preheating time is completed. • Rack position too high or too low. • Oven too hot. 	<ul style="list-style-type: none"> • Allow oven to preheat to the selected temperature before placing food in the oven. • Use proper rack position for baking needs. • Set oven temperature 25°F/13°C lower than recommended.
Cakes not done in center 	<ul style="list-style-type: none"> • Oven too hot. • Incorrect pan size. • Pan not centered in oven. 	<ul style="list-style-type: none"> • Set oven temperature 25°F/13°C lower than recommended. • Use pan size suggested in recipe. • Use proper rack position and place pan so there is 5.1 cm to 10.2 cm (2" to 4") of space on all sides of pan.
Cakes not level. 	<ul style="list-style-type: none"> • Oven not level. • Pan too close to oven wall or rack overcrowded. • Pan warped. 	<ul style="list-style-type: none"> • Place a marked glass measuring cup filled with water on the center of the oven rack. If the water level is uneven, refer to the installation instructions for leveling the oven. • Be sure to allow 5.1 cm to 10.2 cm (2" to 4") of clearance on all sides of each pan in the oven. • Do not use pans that are dented or warped.
Foods not done when cooking time is over. 	<ul style="list-style-type: none"> • Oven too cool. • Oven overcrowded. • Oven door opened too frequently. 	<ul style="list-style-type: none"> • Set oven temperature 25°F/13°C higher than suggested and bake for the recommended time. • Be sure to remove all pans from the oven except the ones to be used for baking. • Open oven door only after shortest recommended baking time.

Before You Call

Solutions to Common Problems

Before you call for service, review the following list. It may save you time and expense. Possible solutions are provided with the problem listed:

Problem	Solution
Poor baking results	<ul style="list-style-type: none">• Many factors effect baking results. Use proper oven rack position. Center food in the oven and space pans to allow air to circulate. Preheat oven to the set temperature before placing food in the oven. Try adjusting the recipe's recommended temperature or baking time. See "Self Clean" on page 33 if you feel the oven is too hot or cold.
Oven does not operate.	<ul style="list-style-type: none">• The time of day is not set. The oven clock must first be set in order to operate the oven.• Be sure oven controls are set properly. See "Setting the Clock" on page 15 and review instructions for the desired cooking function in this manual.• Service wiring is not complete.
Oven light does not work.	<ul style="list-style-type: none">• Be sure the oven light is secure in the socket. See "Replacing the oven light" on page 37.
Flames inside oven or smoking from oven vent.	<ul style="list-style-type: none">• Excessive spills in oven. Grease or food spilled onto oven bottom or oven cavity. Wipe up excessive spills before starting oven. If flames or excessive smoke are present when using broil, see "Setting Broil" on page 21.
Self clean does not work.	<ul style="list-style-type: none">• Oven control not set properly. Review "Self Clean" on page 33.
Oven racks discolored or do not slide easily.	<ul style="list-style-type: none">• Oven racks left in oven cavity during self clean. Always remove oven racks from oven cavity before starting a self-clean cycle. Clean using a mild abrasive cleaner following manufacturer's instructions. Rinse with clean water, dry, and replace in oven.
Oven smokes excessively when broiling.	<ul style="list-style-type: none">• Incorrect setting. Follow broiling instructions in "Setting Broil" on page 21• Meat too close to the broil element. Reposition broil rack to provide proper clearance between the meat and broil element. Remove excess fat from meat. Cut remaining fatty edges to prevent curling.• Grease build up on oven surfaces. Regular cleaning is necessary when broiling frequently. Grease or food splatters will cause excessive smoking.
Oven control panel beeps and displays any F or E code error.	<ul style="list-style-type: none">• Oven control has detected a fault or error condition. Press STOP to clear the error code. Try bake or broil function. If the F or E code error repeats, turn off power to appliance, wait 5 minutes and then repower appliance. Set clock with correct time of day. Try bake or broil function again. If fault recurs, press STOP to clear.
Soil not completely removed after self clean.	<ul style="list-style-type: none">• Self Clean was interrupted. Review instructions in "Self Clean" section on page 33.• Excessive spills on oven bottom. Clean before starting self clean.• Failure to clean soil from the oven frame, the door liner outside the oven door gasket, and the small area at the front center of the oven bottom. These areas are not in the self-cleaning area, but they get hot enough to burn on residue. Clean these areas before starting the self-cleaning cycle. Burned-on residue can be cleaned with a stiff nylon brush and water or a nylon scrubber. Be careful not to damage the oven gasket.
The oven control display shows "SPr" and self-clean is not working.	<ul style="list-style-type: none">• The cooktop should not be used during a self-clean cycle. On some models, turning on any cooktop surface burner will cause the clean cycle to cancel. If the clean cycle is canceled, the oven control display will show "SPr" for 5 seconds. The oven door will remain locked until the oven has cooled down below cleaning temperature. If the oven is below cleaning temperature, the user can start another clean cycle immediately. If the oven is in cleaning temperature range, another self-clean cycle can be set once the door unlocks (up to 4 hours).

Master Protection Agreements

Congratulations on making a smart purchase. Your new Kenmore® product is designed and manufactured for years of dependable operation. But like all products, it may require preventive maintenance or repair from time to time. That's when having a Master Protection Agreement can save you money and aggravation.

The Master Protection Agreement also helps extend the life of your new product. Here's what the Agreement* includes:

- ☑ **Parts and labor** needed to help keep products operating properly **under normal use**, not just defects. Our coverage goes **well beyond the product warranty**. No deductibles, no functional failure excluded from coverage – **real protection**.
- ☑ **Expert service** by a force of more than **10,000 authorized Sears service technicians**, which means someone you can trust will be working on your product.
- ☑ **Unlimited service calls and nationwide service**, as often as you want us, whenever you want us.
- ☑ **"No-lemon" guarantee** – replacement of your covered product if four or more product failures occur within twelve months.
- ☑ **Product replacement** if your covered product can't be fixed.
- ☑ **Annual Preventive Maintenance Check** at your request – no extra charge.
- ☑ **Fast help by phone** – we call it **Rapid Resolution** – phone support from a Sears representative on all products. Think of us as a "talking owner's manual".
- ☑ **Power surge protection** against electrical damage due to power fluctuations.
- ☑ **\$250 Food Loss Protection** annually for any food spoilage that is the result of mechanical failure of any covered refrigerator or freezer.
- ☑ **Rental reimbursement** if repair of your covered product takes longer than promised.
- ☑ **25% discount** off the regular price of any non-covered repair service and related installed parts.

Once you purchase the Agreement, a simple phone call is all that it takes for you to schedule service. You can call anytime day or night, or schedule a service appointment online.

The Master Protection Agreement is a risk free purchase. If you cancel for any reason during the product warranty period, we will provide a full refund. Or, a prorated refund anytime after the product warranty period expires. Purchase your Master Protection Agreement today!

Some limitations and exclusions apply. For prices and additional information in the U.S.A. call 1-800-827-6655.

*** Coverage in Canada varies on some items. For full details call Sears Canada at 1-800-361-6665.**

Sears Installation Service

For Sears professional installation of home appliances, garage door openers, water heaters, and other major home items, in the U.S.A. or Canada call **1-800-4-MY-HOME®**.

Acuerdos maestros de protección

Enhorabuena por haber hecho una compra inteligente. Su nuevo producto Kenmore® está diseñado y fabricado para brindarle años de funcionamiento fiable. Pero, como cualquier producto, puede necesitar mantenimiento preventivo o reparaciones periódicas. Es por eso que tener un Acuerdo maestro de protección podría ahorrarle dinero y molestias.

El Acuerdo maestro de protección también sirve para prolongar la durabilidad de su nuevo producto. El acuerdo* incluye lo siguiente:

- ☑ **Piezas y mano de obra** necesarias para contribuir a mantener el funcionamiento adecuado de los productos **utilizados en condiciones normales de uso**, no sólo en caso de defectos de los productos. Nuestra cobertura va **mucho más allá que la garantía del producto**. No se aplican deducibles ni exclusiones por fallas del funcionamiento: es decir, **verdadera protección**.
- ☑ **Servicio técnico por expertos** (más de **10000 técnicos autorizados de Sears**), lo cual significa que quien repare o realice el mantenimiento de su producto será un profesional de confianza.
- ☑ **Servicio técnico a escala nacional y número ilimitado de llamadas de solicitud de servicio técnico**: se puede poner en contacto con nosotros cuantas veces lo desee y cuando lo desee.
- ☑ **Garantía "sin sorpresas"**: se reemplaza el producto cubierto por el acuerdo si ocurren cuatro o más fallas del producto en un periodo de 12 meses.
- ☑ **Reemplazo del producto**: en caso de que no se pueda reparar el producto cubierto por el acuerdo.
- ☑ **Revisión anual preventiva de mantenimiento del producto**: puede solicitarla en cualquier momento, sin costo alguno.
- ☑ **Rápida asistencia telefónica**, la cual denominamos **Solución rápida**: es decir, asistencia telefónica a través de cualquiera de nuestros representantes de Sears, sobre cualquiera de nuestros productos. Piense en nosotros como en un "manual parlante del usuario".
- ☑ **Protección contra fallas eléctricas**, contra daños debidos a fluctuaciones de la corriente eléctrica.
- ☑ **\$250 al año para cubrir cualquier posible deterioro de alimentos** que haya tenido que desechar debido a una falla mecánica de cualquiera de nuestros refrigeradores o congeladores cubiertos por este acuerdo.
- ☑ **Devolución de gastos de alquiler de electrodomésticos** si la reparación de su producto asegurado toma más que el tiempo prometido.
- ☑ **25% de descuento** aplicable tanto a los costos del servicio de reparación, como de las piezas instaladas relacionadas que no hayan quedado cubiertos por este acuerdo.

Una vez que haya realizado el pago de este acuerdo, bastará una simple llamada telefónica para concertar una visita de servicio. Puede llamar a cualquier hora del día o de la noche, o bien concertar una visita de servicio por Internet.

La adquisición del Acuerdo maestro de protección es una inversión exenta de riesgos. Si por cualquier motivo decide cancelar dicho acuerdo durante el periodo de garantía del producto, le haremos un reintegro total del valor. O bien un importe proporcional si cancela el acuerdo en cualquier otro momento posterior al vencimiento del periodo de garantía del producto. ¡Adquiera hoy mismo su Acuerdo maestro de protección!

Algunas limitaciones y exclusiones podrían aplicarse. Para solicitar precios e información adicional, llame al 1-800-827-6655 (en los EE.UU.).

*** La cobertura en Canadá varía en el caso de algunos artículos. Para obtener detalles completos al respecto, llame al 1-800-361-6665 de Sears de Canadá.**

Servicio de instalación de Sears

Para solicitar la instalación por profesionales de Sears de electrodomésticos, abridores de puertas de garaje, calentadores de agua y otros artículos de uso prioritario en el hogar, **llame al 1-800-4-MY-HOME** en los EE.UU. o Canadá.

Kenmore®

Customer Care Hotline

To schedule repair service or order parts

Para pedir servicio o ordenar piezas

1-844-553-6667

www.kenmore.com

For service in Canada Au Canada pour service

1-800-469-4663

www.sears.ca

