



LEARN MORE

In an effort to conserve natural resources, this dishwasher includes a condensed User Guide. A complete User Instructions manual can be downloaded at www.whirlpool.com/manuals.

For future reference, please make a note of your product model and serial numbers. You can find them on the label located near the door on the right-hand or left-hand side of the dishwasher interior.

Model Number _____ Serial Number _____

Register your dishwasher at www.whirlpool.com. In Canada, register your dishwasher at www.whirlpool.ca.

Para una version de estas instrucciones en español, visite www.whirlpool.com.

Your safety and the safety of others are very important.

We have provided many important safety messages in this manual and on your appliance. Always read and obey all safety messages.



This is the safety alert symbol.

This symbol alerts you to potential hazards that can kill or hurt you and others.

All safety messages will follow the safety alert symbol and either the word “DANGER” or “WARNING.”

These words mean:

DANGER

You can be killed or seriously injured if you don't immediately follow instructions.

WARNING

You can be killed or seriously injured if you don't follow instructions.

All safety messages will tell you what the potential hazard is, tell you how to reduce the chance of injury, and tell you what can happen if the instructions are not followed.

IMPORTANT SAFETY INSTRUCTIONS

WARNING: When using the dishwasher, follow basic precautions, including the following:

- Read all instructions before using the dishwasher.
- Use the dishwasher only for its intended function.
- Use only detergents or rinse agents recommended for use in a dishwasher, and keep them out of the reach of children.
- When loading items to be washed:
 - 1) Locate sharp items so that they are not likely to damage the door seal; and
 - 2) Load sharp knives with the handles up to reduce the risk of cut-type injuries.
- Do not wash plastic items unless they are marked “dishwasher safe” or the equivalent. For plastic items not so marked, check the manufacturer's recommendations.
- Do not touch the heating element during or immediately after use.
- Do not operate the dishwasher unless all enclosure panels are properly in place.
- Do not tamper with controls.
- Do not abuse, sit on, or stand on the door, lid, or dish racks of the dishwasher.
- To reduce the risk of injury, do not allow children to play in or on the dishwasher.
- Under certain conditions, hydrogen gas may be produced in a hot water system that has not been used for two weeks or more. HYDROGEN GAS IS EXPLOSIVE. If the hot water system has not been used for such a period, before using the dishwasher turn on all hot water faucets and let the water flow from each for several minutes. This will release any accumulated hydrogen gas. As the gas is flammable, do not smoke or use an open flame during this time.
- Remove the door or lid to the washing compartment when removing an old dishwasher from service or discarding it.

SAVE THESE INSTRUCTIONS

State of California Proposition 65 Warnings:

WARNING: This product contains one or more chemicals known to the State of California to cause cancer.

WARNING: This product contains one or more chemicals known to the State of California to cause birth defects or other reproductive harm.

⚠ WARNING



Tip Over Hazard

- Do not use dishwasher until completely installed.
- Do not push down on open door.
- Doing so can result in serious injury or cuts.

GROUNDING INSTRUCTIONS

■ For a grounded, cord-connected dishwasher:

The dishwasher must be grounded. In the event of a malfunction or breakdown, grounding will reduce the risk of electric shock by providing a path of least resistance for electric current. The dishwasher is equipped with a cord having an equipment-grounding conductor and a grounding plug. The plug must be plugged into an appropriate outlet that is installed and grounded in accordance with all local codes and ordinances.

WARNING: Improper connection of the equipment-grounding conductor can result in a risk of electric shock.

Check with a qualified electrician or service representative if you are in doubt whether the dishwasher is properly grounded. Do not modify the plug provided with the dishwasher; if it will not fit the outlet, have a proper outlet installed by a qualified electrician.

■ For a permanently connected dishwasher:

The dishwasher must be connected to a grounded metal, permanent wiring system, or an equipment-grounding conductor must be run with the circuit conductors and connected to the equipment-grounding terminal or lead on the dishwasher.

SAVE THESE INSTRUCTIONS

KEY USAGE TIPS

Filtration System and Maintenance

Your dishwasher has a filtration system that efficiently removes food particles from the wash water.

The filter system consists of three parts: a fine filter plate, a coarse filter, and a lower filter.

IMPORTANT: To avoid damage to dishwasher, do not operate your dishwasher without filters properly installed. Be sure lower filter is securely in place and upper filter assembly is locked into place. If the coarse filter turns freely, it is not locked into place.

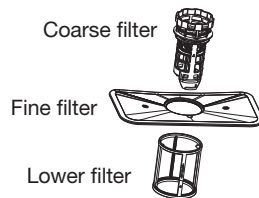

The filters may need to be cleaned when:

- Visible objects or soils are on fine filter plate.
- Dishes feel gritty to the touch.

See the "Filtration System" section in the full User Instructions for complete removal and maintenance schedule.

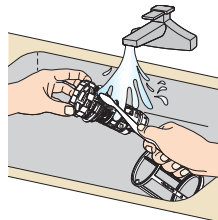

IMPORTANT: Do not use a wire brush or a scouring pad, etc., as they may damage the filters.

Rinse filter under running water until soils are removed. If you have hard-to-remove soils or calcium deposits because of hard water, a soft brush may be required.

Drying – Rinse aid is essential

You must use a drying agent such as a rinse aid for good drying performance. Rinse aid along with the Heated Dry option will provide improved drying and avoid excessive moisture on the dishwasher interior.

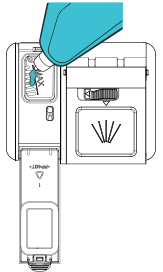

Touch START/Pause every time you add a dish

If anyone opens the door after the dishwasher has started (such as for adding a dish, even during the delay time), the Start/Pause button must be touched again to resume the cycle.



Push door firmly closed and touch START/Pause.

Adjust Upper Rack

You can raise or lower the upper rack to fit all items in either the upper or lower rack.

To raise or lower the rack:

Empty the rack. Pull the rack out halfway and take notice of the position of the carriage wheel assembly and side rail on each side of the rack. Lift up on the front of the rack while pulling the rack out all the way. The rack will then be completely free of the side rails. Reverse this action to re-engage the rack's carriage wheels onto the rails in the higher or lower position desired.

NOTE: The upper rack must be level.

OPERATING YOUR DISHWASHER

1. Prepare and load the dishwasher

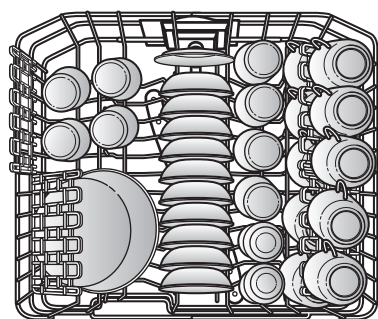

10-place load – upper rack

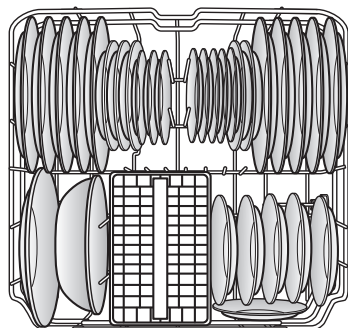

10-place load – lower rack

IMPORTANT: Remove leftover food, bones, toothpicks, and other hard items from dishes. Remove labels from containers before washing.

- Make sure when dishwasher door is closed, no items are blocking detergent dispenser.
- Items should be loaded with soiled surfaces facing down and inward to the spray as shown in the graphics above. This will improve cleaning and drying results. Angle dirtiest dish surface downward, allowing space for water to flow up through rack and between dishes.
- Avoid overlapping items, like bowls or plates, that may trap food.
- Place plastics, small plates, and glasses in upper rack.
- Wash only items marked “dishwasher safe.”
- To avoid thumping/clattering noises during operation, load dishes so they do not touch one another. Make sure lightweight load items are secured in racks.
- Use slots in the covers and suggested loading patterns to keep your silverware separated for optimum wash.

1. Spoons
2. Knives
3. Salad forks
4. Forks
5. Large spoons
6. Large forks

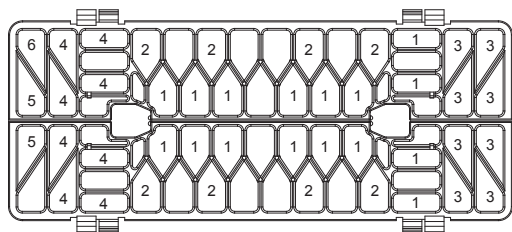
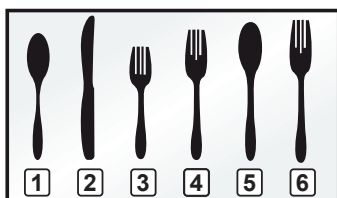

- If your silverware does not fit into the designated slots, lift and slide covers off to remove them and mix silverware types to keep them separated.
- When loading silverware, always place sharp items pointing down and avoid “nesting” as shown.



2. Check that all arms spin freely

Items in the rack can block the spray arms.

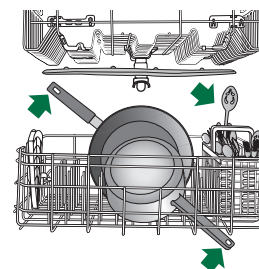

3. Add detergent

Premeasured Detergents

High-quality premeasured tablets and packs are recommended for improved performance.

Quality tablets and packs have been proven better than powder, liquid, or gel detergents at reducing filming on dishes. Using tablets and packs over time will start to reduce or eliminate white film. They are suitable for all water hardness and soil levels. Also, by using a rinse aid, you can minimize repeat buildup of white film (not all packs and tablets contain rinse aid). Always place premeasured detergents in main compartment and close lid.

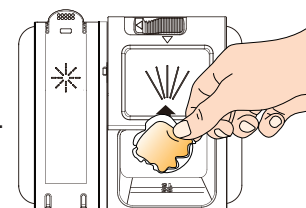

NOTE: Follow instructions on the package when using other dishwasher detergent types. See the complete User Instructions for more details about powders, liquids, and gels.

- Use automatic dishwasher detergent only. Add detergent just before starting a cycle.
- Fresh automatic dishwasher detergent results in better cleaning. Store tightly closed detergent container in a cool, dry place.

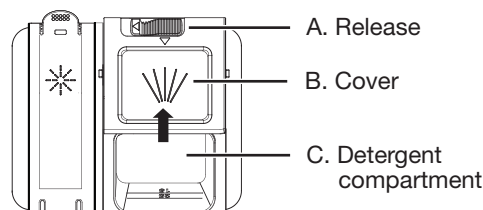

Close the detergent dispenser by sliding cover (B) over detergent compartment (C).

Open the detergent dispenser by sliding release (A) to the left and the cover (B) will automatically slide open.

4. Add rinse aid

- Your dishwasher is designed to use rinse aid for good drying performance. Without rinse aid, your dishes and dishwasher interior will have excessive moisture. The heating and drying options will not perform as well without rinse aid.
- Rinse aid keeps water from forming droplets that can dry as spots or streaks. It also improves drying by allowing water to drain off of dishes after final rinse. Rinse aid does not adhere to dishware, and when used, it is dispensed during each cycle.

- To add rinse aid, open the dispenser lid by gently pushing in the center of the lid with your thumb while lifting up on the edge.
- Pour rinse aid into the opening until the indicator level shows that it is full. Do not fill the reservoir above the full level indicator. Excess rinse aid can cause suds and water to overflow during the wash cycle.
- Close dispenser by pushing down gently on the lid until it clicks into place.

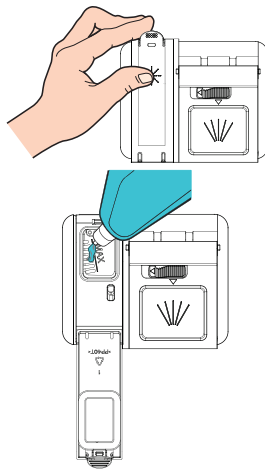

5. Select a cycle

NOTE: Heavier cycles and options lengthen cycle times. Choose a cycle appropriate for the food soils and dishes that you load. See the cycle descriptions in the Cycle Guide section.

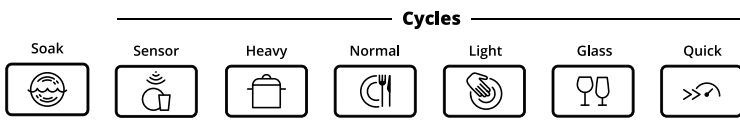

6. Select options

You can customize your cycles by selecting the options desired (see the Cycle Guide). If you change your mind, touch the option again to turn off the option. If an invalid option is selected for a given cycle, the lights will flash. Adding options may increase the cycle time.

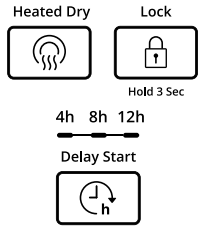

7. Start or resume a cycle

NOTE: If needed, run hot water at the sink nearest your dishwasher until the water is hot. Turn off water. With door firmly closed touch the START/Pause button.



IMPORTANT: If the door is opened for any reason after the cycle is started (even during the delay time), the Start/Pause button must be touched again after the door is closed. If Start/Pause button is not touched, the cycle will not resume.

8. Follow the progress of your dishwasher







When the cycle is complete, the Complete light will remain on until the door is opened and closed or the Start/Pause button is touched.

Washing > Rinsing > Complete
Add Rinse Aid

CYCLE GUIDE



IMPORTANT: The sensor in your dishwasher monitors the soil level. Cycle time and/or water usage can vary as the sensor adjusts the cycle for the best wash performance. If the incoming water is less than the recommended temperature or food soils are heavy, the cycle will automatically compensate by adding time, heat, and water as needed.



The dishwasher remembers the cycle and options selections from the most recently completed cycle. To run the same cycle and options as the last time, touch the START/Pause button twice—once to wake up the controls, and again to start the dishwasher.

CYCLES		ESTIMATED WASH TIME W/O OPTIONS HH:MM	WATER USAGE GALLONS (LITERS)
 Soak	Use for rinsing dishes, glasses, and silverware that will not be washed right away. Do not use detergent.	0:10	2.1 G (8.0 L)
 Sensor	This cycle senses the soil amount, to adjust amount of water and time needed.	1:45 - 3:18	2.9 - 5.8 G (11.1 - 21.8 L)
 Heavy	Use for hard-to-clean, heavily soiled pots, pans, casseroles, and regular tableware. Includes Heated Dry option.	2:30 - 2:50	5.8 G (22.1 L)
 Normal	This cycle is recommended for daily, regular, or typical use to completely wash and dry a full load of normally soiled dishes. This dishwasher's government energy certifications were based on the Normal cycle with only the Heated Dry option selected.*	1:30 - 2:10	2.9 - 5.6 G (11.1 - 21.2 L)
 Light	For lightly soiled loads. Includes Heated Dry option.	1:45	5.0 G (19.0 L)
 Glass	For lightly soiled glassware. Includes Heated Dry option.	1:45	4.9 G (18.4 L)
 Quick	For fast results, the Quick cycle will clean lightly soiled loads that do not need drying. Includes Heated Dry option.	0:55	4.0 G (15.0 L)

NOTE: Some detergents are not recommended for short wash cycles; please refer to your detergent packaging for more information.

*No other washing and drying temperature options were selected, and the dishwasher was not subjected to truncated testing. Rinse aid was not used, and there was no detergent used in the prewash.

OPTIONS	CAN BE SELECTED WITH	WHAT IT DOES	ADDED TIME TO CYCLE	ADDED WATER GALLONS (LITERS)
Heated Dry  <p>Dries dishes with heat. This option, with the use of rinse aid, will provide the best drying results. Plastic items are less likely to deform when loaded in the upper rack. Use Heated Dry for optimum drying performance. For air dry, turn off Heated Dry.</p>	Available with any cycle	Uses a heating element to speed drying times. Heated Dry option defaults to On when any cycle is selected, except for Rinse.	0 - 0:05	NA
Lock  Hold 3 Sec	Available with any cycle	When the Lock indicator is lit, all buttons are disabled. Eliminates unintended use of dishwasher between cycles, or cycle and option changes during a cycle.	NA	NA
4h 8h 12h Delay Start  <p>To delay the start:</p> <ol style="list-style-type: none"> Select a wash cycle and options. Touch DELAY START for each hour of delay time. Touch START/Pause to begin the delay countdown. <p>NOTE: If the door is opened, such as to add a dish, the Start/Pause button must be touched to resume the delay countdown.</p>	Available with any cycle	Delays start of a cycle up to 24 hours.	4:00 - 12:00	NA

Control	Purpose	Comments
On/Off 	Touch to turn the dishwasher on or off.	Touch and hold for 1 second to turn the dishwasher on before making any selections. To turn the dishwasher off, touch and hold for 2 seconds. This will stop the operation of the dishwasher and deactivate any cycles and options selected. The dishwasher will start a 60-second drain. Let dishwasher drain completely.
Cancel 	Touch to cancel wash cycle.	With the door closed and the cycle or delay running, touch the Cancel button. The dishwasher starts a 60-second drain. Let dishwasher drain completely.
Start / Pause 	Touch to start or resume a wash cycle. Touch once to temporarily interrupt the cycle without canceling.	If the door is opened during a cycle or the power is interrupted, the cycle will not resume until the Start/Pause button is touched again. With a cycle running, touch START/Pause button once. This will interrupt the cycle without canceling. Opening the door will also interrupt the cycle in the same way. Close the door and touch START/Pause again to resume the cycle.

DISHWASHER CARE

Cleaning the Exterior

Clean the exterior of the dishwasher with only a soft, damp cloth and mild detergent. Avoid using abrasive cleaning products on the exterior of the dishwasher.

Cleaning and Maintaining the Interior

Many detergents may leave white spots or a white residue on dishware and on the interior of the dishwasher. Over time this residue can become unsightly and could affect dishwasher performance. Use of a dishwasher cleaning product such as affresh® Dishwasher Cleaner can help to remove the residue. Monthly use of affresh® Dishwasher Cleaner is recommended to help maintain the dishwasher. Follow package directions.

NOTE: Whirlpool recommends the use of high-quality premeasured detergent tablets or packs and the use of rinse aid for dishwasher cleaning and daily care.

If you have a drain air gap, check and clean it if the dishwasher isn't draining well.

To Reduce Risk of Property Damage During Vacation or Extended Time Without Use:

- When you will not be using the dishwasher during the summer months, turn off the water and power supply to the dishwasher.
- Make sure the water supply lines are protected against freezing conditions. Ice formations in the supply lines can increase water pressure and cause damage to your dishwasher or home. Damage from freezing is not covered by the warranty.
- When storing your dishwasher in the winter, avoid water damage by having your dishwasher winterized by authorized service personnel.

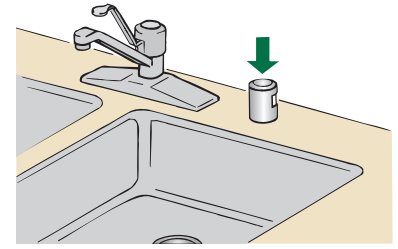

TROUBLESHOOTING

First try the solutions suggested here. If you need further assistance or more recommendations that may help you to avoid a service call, visit producthelp.whirlpool.com.

Contact us by mail with any questions or concerns at the address below:

In the U.S.A.:

Whirlpool Brand Home Appliances
Customer eXperience Center
553 Benson Road
Benton Harbor, MI 49022-2692

In Canada:

Whirlpool Brand Home Appliances
Customer eXperience Centre
200 - 6750 Century Ave.
Mississauga, Ontario L5N 0B7

Please include a daytime phone number in your correspondence.

If you experience	Recommended solutions
Dishwasher does not run or stops during a cycle	It is normal for certain cycles to repeatedly pause for several seconds during the main wash. Is the door closed tightly and latched? Is the right cycle selected? Is there power to the dishwasher? Has a household fuse blown or has a circuit breaker tripped? Replace the fuse or reset the circuit breaker. If the problem continues, call an electrician. Is the water shut-off valve (if installed) turned on?
Dishes do not dry completely	NOTE: Plastic and items with nonstick surfaces are difficult to dry because they have a porous surface which tends to collect water droplets. Towel drying may be necessary. Use of rinse aid along with the Heated Dry option is needed for proper drying. Proper loading of items can affect drying. Glasses and cups with concave bottoms hold water. This water may spill onto other items when you are unloading the dishwasher. For improved results, place these items on the more slanted side of the rack. <ul style="list-style-type: none"> ■ Unload the lower rack first.

If you experience	Recommended solutions
Noise	<p>NOTE: Common noises:</p> <ul style="list-style-type: none"> ■ Surging sounds can occur periodically throughout the cycle while the dishwasher is draining. ■ Normal water valve hissing may be heard periodically. ■ A normal snap sound may be heard when the detergent dispenser opens during the cycle or when the door is opened at the end of the cycle. ■ Improper installation will affect noise levels. <p>Be sure the filters are properly installed. A thumping sound may be heard if items interfere with the wash arms. Readjust the dishware and resume the cycle.</p>
Spotting/Filming	<p>Liquid rinse aid is necessary for drying and to reduce spotting. Use the correct amount of detergent. Confirm that the cloudiness is removable by soaking the item in white vinegar for 5 minutes and dry the item. If the cloudiness disappears, it is due to hard water. Adjust the amount of detergent and rinse aid. See the “Dishwasher Care” section. If cloudiness on glass does not come clear, it is due to etching. Be sure the incoming water temperature is set at 120°F (49°C). To remove spotting, run a vinegar rinse through the dishwasher.</p> <ul style="list-style-type: none"> ■ Wash and rinse the affected dishware and load into dishwasher. Remove all silverware and metal items. Put 2 cups (500 mL) of white vinegar in a 2-cup capacity measuring cup and place upright in the lower rack. Run a Normal cycle with the Heated Dry option turned off and no detergent. See the “Dishwasher Care” section in full User Instructions.
Dishwasher does not clean completely	<p>Be sure the dishwasher is loaded correctly. Improper loading can greatly decrease the washing performance. See the “Operating Your Dishwasher” section. Check filter to ensure it is properly installed. Clean it if needed. See the “Filtration System” section in the full User Instructions for details. Select the proper cycle for the type of soils. The Heavy wash cycle can be used for tougher loads. Be sure the incoming water temperature is 120°F (49°C). Use the proper amount of fresh detergent. More detergent is needed for heavier-soiled loads and hard water conditions. Scrape food from dishes prior to loading (do not prerinse). Suds can come from:</p> <ul style="list-style-type: none"> ■ Using the incorrect type of detergent, such laundry detergent, hand soap, or dish detergent for hand-washing dishes. ■ Not replacing the rinse aid dispenser cap after filling (or refilling) the rinse aid dispenser. ■ Using an excessive amount of dishwasher detergent.
Dishwasher does not drain	<p>Be sure the cycle has been completed (the Complete light is on). If it has not, you will need to resume the cycle by closing the door and touching Start/Pause. If dishwasher is connected to a food waste disposer, be sure the knockout plug has been removed from the disposer inlet. Check for kinks in the drain hose. Check for food obstructions in the drain or disposer. Check your house fuse or circuit breaker.</p>

ACCESSORIES

Whirlpool Corporation also offers a variety of accessories for your dishwasher. In the U.S.A., visit www.whirlpool.com/accessories to order. In Canada, visit www.whirlpoolparts.ca to order.

WHIRLPOOL® MAJOR APPLIANCE LIMITED WARRANTY

ATTACH YOUR RECEIPT HERE. PROOF OF PURCHASE IS REQUIRED TO OBTAIN WARRANTY SERVICE.

Please have the following information available when you call the Customer eXperience Center:

- Name, address, and telephone number
- Model number and serial number
- A clear, detailed description of the problem
- Proof of purchase, including dealer or retailer name and address

IF YOU NEED SERVICE:

1. Before contacting us to arrange service, please determine whether your product requires repair. Some questions can be addressed without service. Please take a few minutes to review the Troubleshooting section of the Use and Care Guide or visit producthelp.whirlpool.com.
2. All warranty service is provided exclusively by our authorized Whirlpool Service Providers. In the U.S. and Canada, direct all requests for warranty service to:

Whirlpool Customer eXperience Center

In the U.S.A., call 1-800-253-1301. In Canada, call 1-800-807-6777.

If outside the 50 United States or Canada, contact your authorized Whirlpool dealer to determine whether another warranty applies.

ONE YEAR LIMITED WARRANTY

WHAT IS COVERED

For one year from the date of purchase, when this major appliance is installed, operated, and maintained according to instructions attached to or furnished with the product, Whirlpool Corporation or Whirlpool Canada LP (hereafter "Whirlpool") will pay for factory specified replacement parts and repair labor to correct defects in materials or workmanship that existed when this major appliance was purchased or, at its sole discretion, replace the product. In the event of product replacement, your appliance will be warranted for the remaining term of the original unit's warranty period.

YOUR SOLE AND EXCLUSIVE REMEDY UNDER THIS LIMITED WARRANTY SHALL BE PRODUCT REPAIR AS PROVIDED HEREIN. Service must be provided by a Whirlpool designated service company. This limited warranty is valid only in the United States or Canada and applies only when the major appliance is used in the country in which it was purchased. This limited warranty is effective from the date of original consumer purchase. Proof of original purchase date is required to obtain service under this limited warranty.

WHAT IS NOT COVERED

1. Commercial, non-residential, multiple-family use, or use inconsistent with published user, operator, or installation instructions.
2. In-home instruction on how to use your product.
3. Service to correct improper product maintenance or installation, installation not in accordance with electrical or plumbing codes, or correction of household electrical or plumbing (e.g., house wiring, fuses, or water inlet hoses).
4. Consumable parts (e.g., light bulbs, batteries, air or water filters, preservation solutions, etc.).
5. Defects or damage caused by the use of non-genuine Whirlpool parts or accessories.
6. Conversion of products from natural gas or propane gas.
7. Damage from accident, misuse, abuse, fire, floods, acts of God, or use with products not approved by Whirlpool.
8. Repairs to parts or systems to correct product damage or defects caused by unauthorized service, alteration, or modification of the appliance.
9. Cosmetic damage including scratches, dents, chips, and other damage to the appliance finishes, unless such damage results from defects in materials and workmanship and is reported to Whirlpool within 30 days.
10. Discoloration, rust, or oxidation of surfaces resulting from caustic or corrosive environments including, but not limited to, high salt concentrations, high moisture or humidity, or exposure to chemicals.
11. Food or medicine loss due to product failure.
12. Pickup or delivery. This product is intended for in-home repair.
13. Travel or transportation expenses for service in remote locations where an authorized Whirlpool servicer is not available.
14. Removal or reinstallation of inaccessible appliances or built-in fixtures (e.g., trim, decorative panels, flooring, cabinetry, islands, countertops, drywall, etc.) that interfere with servicing, removal, or replacement of the product.
15. Service or parts for appliances with original model/serial numbers removed, altered, or not easily determined.

The cost of repair or replacement under these excluded circumstances shall be borne by the customer.

DISCLAIMER OF IMPLIED WARRANTIES

IMPLIED WARRANTIES, INCLUDING ANY IMPLIED WARRANTY OF MERCHANTABILITY OR IMPLIED WARRANTY OF FITNESS FOR A PARTICULAR PURPOSE, ARE LIMITED TO ONE YEAR OR THE SHORTEST PERIOD ALLOWED BY LAW. Some states and provinces do not allow limitations on the duration of implied warranties of merchantability or fitness, so this limitation may not apply to you. This warranty gives you specific legal rights, and you also may have other rights that vary from state to state or province to province.

DISCLAIMER OF REPRESENTATIONS OUTSIDE OF WARRANTY

Whirlpool makes no representations about the quality, durability, or need for service or repair of this major appliance other than the representations contained in this warranty. If you want a longer or more comprehensive warranty than the limited warranty that comes with this major appliance, you should ask Whirlpool or your retailer about buying an extended warranty.

LIMITATION OF REMEDIES: EXCLUSION OF INCIDENTAL AND CONSEQUENTIAL DAMAGES

YOUR SOLE AND EXCLUSIVE REMEDY UNDER THIS LIMITED WARRANTY SHALL BE PRODUCT REPAIR AS PROVIDED HEREIN. WHIRLPOOL SHALL NOT BE LIABLE FOR INCIDENTAL OR CONSEQUENTIAL DAMAGES. Some states and provinces do not allow the exclusion or limitation of incidental or consequential damages, so these limitations and exclusions may not apply to you. This warranty gives you specific legal rights, and you also may have other rights that vary from state to state or province to province.

03/17