

EN ELECTRIC RANGE

USE AND CARE GUIDE



Electrolux

Table of contents

Finding information	2
Important Safety Instructions	3-7
Features	8
Oven Cooking	9-10
Surface Cooking	11-12
Setting Surface Controls	13-15
Getting Started	16
Setting Oven Controls	17-31
• Preheat	17
• Bake	18
• Cook time.....	19
• Delay start	20
• Convection bake	21
• Convection convert	22
• Convection roast	23
• Broil.....	24-25
• Keep warm.....	26
• Cakes breads.....	26
• Probe	27-28
• Slow cook.....	29
• My favorite	30
• Sabbath mode.....	31
Setting the Warmer Drawer	32-33
Setting Your Preferences	34-35
• Setting clock.....	34
• Setting 12 or 24 hour mode	34
• Changing between °F or °C	34
• User preference offset.....	34
• Setting 12hr energy saving mode	35
• Setting audio mode	35
• Factory default reset	35
Setting Self-Clean Cycle	36-37
Care & Cleaning	38-43
• Cleaning recommendations	38
• Special door care instructions.....	39
• Changing oven lights	39
• Removing and replacing the oven door	40
• Cooktop cleaning and maintenance.....	41
• Recommendations for ceramic glass.....	41-42
• Removing and replacing the drawer	43
Solutions to Common Problems	44-46
Warranty	47

Please read & save this guide

Thank you for choosing Electrolux, the new premium brand in home appliances. This *Use & Care Guide* is part of our commitment to customer satisfaction and product quality throughout the service life of your new appliance.

We view your purchase as the beginning of a relationship. To ensure our ability to continue serving you, please use this page to record important product information.

Keep a record for quick reference

Purchase date

Electrolux model number

Electrolux serial number

Serial plate location

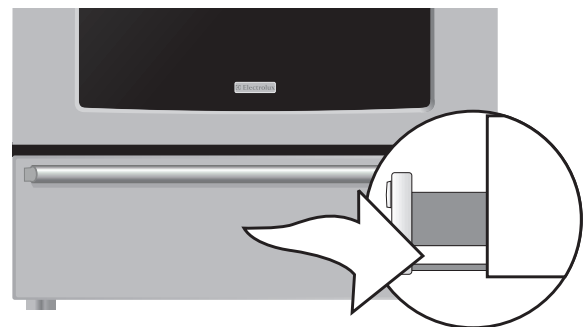

NOTE

Registering your product with Electrolux enhances our ability to serve you. You can register online at www.electroluxappliances.com or by dropping your Product Registration Card in the mail.

Questions?

For toll-free telephone support in the U.S. and Canada:

1-877-4ELECTROLUX (1-877-435-3287)

For online support and Internet production information visit <http://www.electroluxappliances.com>

READ ALL INSTRUCTIONS BEFORE USING THIS APPLIANCE.

This manual contains important safety symbols and instructions. Please pay attention to these symbols and follow all instructions given.

Do not attempt to install or operate your appliance until you have read the safety precautions in this manual. Safety items throughout this manual are labeled with a WARNING or CAUTION statement based on the risk type.

Warnings and important instructions appearing in this guide are not meant to cover all possible conditions and situations that may occur. Common sense, caution, and care must be exercised with installing, maintaining, or operating your appliance.

DEFINITIONS



This is the safety alert symbol. It is used to alert you to potential personal injury hazards. Obey all safety messages that follow this symbol to avoid possible injury or death.

WARNING

Indicates a potentially hazardous situation which, if not avoided, may result in death or serious injury.

CAUTION

Indicates a potentially hazardous situation which, if not avoided, may result in minor or moderate injury.

IMPORTANT

Indicates installation, operation, maintenance, or valuable information that is not hazard related.

NOTE

Indicates a short, informal reference – something written down to assist the memory or for future reference.



WARNING

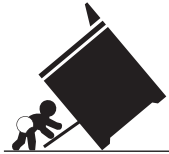

Tip Over Hazard

- A child or adult can tip the range and be killed.
- Verify the anti-tip device has been installed to floor or wall.
- Ensure the anti-tip device is re-engaged to floor or wall when the range is moved.
- Do not operate the range without the anti-tip device in place and engaged.
- Failure to follow these instructions can result in death or serious burns to children and adults.

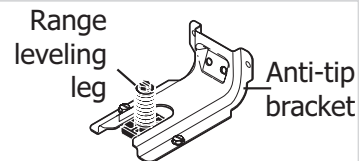

To check if the anti-tip bracket is installed properly, use both arms to grasp the rear edge of the range back. Carefully attempt to tilt range forward. When properly installed, the range should not tilt forward.

Refer to the anti-tip bracket installation instructions supplied with your range for proper installation.

IMPORTANT INSTRUCTIONS FOR UNPACKING AND INSTALLATION

IMPORTANT - Read and follow the below instructions and precautions for unpacking, installing, and servicing your appliance:

Remove all tape and packaging before using the appliance. Destroy the carton and plastic bags after unpacking the appliance. Never allow children to play with packaging material. Do not remove the wiring label and other literature attached to the appliance. Do not remove model/serial number plate.

4 Important Safety Instructions

Cold temperatures can damage the electronic control. When using this appliance for the first time, or when the appliance has not been used for an extended period of time, be sure the appliance has been in temperatures above 32°F (0°C) for at least 3 hours before turning on the power to the appliance.

Never modify or alter the construction of the appliance by removing the leveling legs, panels, wire covers, anti-tip brackets/screws, or any other part of the appliance.

Be sure to have an appropriate foam-type fire extinguisher available, visible, and easily accessible located near the appliance.

GROUNDING INSTRUCTIONS

WARNING

Avoid fire hazard or electrical shock. Failure to follow this warning may cause serious injury, fire, or death.

Do not use an adapter plug, use an extension cord, or remove grounding prong from the power cord. Failure to follow this warning may cause serious injury, fire, or death.

Proper Installation—Be sure your appliance is properly installed and grounded by a qualified technician. In the United States, install in accordance with the National Fuel Gas Code ANSI Z223.1/ NFPA No. 54, latest edition and National Electrical Code NFPA No. 70 latest edition, and local electrical code requirements. In Canada, install in accordance with CAN/CGA B149.1 and CAN/CGA B149.2 and CSA Standard C22.1, Canadian Electrical code, Part 1-latest editions and local electrical code requirements. Install only per installation instructions provided in the literature package for this appliance.

For personal safety, this appliance must be properly grounded. For maximum safety, the power cord must be securely connec-

ted to an electrical outlet or junction box that is the correct voltage, is correctly polarized and properly grounded, and protected by a circuit breaker in accordance with local codes.

It is the personal responsibility of the consumer to have the appropriate outlet or junction box with the correct, properly grounded wall receptacle installed by a qualified electrician. It is the responsibility and obligation of the consumer to contact a qualified installer to assure that the electrical installation is adequate and is in conformance with all local codes and ordinances.

See the installation instructions packaged with this appliance for complete installation and grounding instructions.

IMPORTANT INSTRUCTIONS FOR USING THE APPLIANCE

WARNING

Storage In or On Appliance—Flammable materials should not be stored in an oven or microwave, near surface burners or elements, or in the storage or warmer drawer (if equipped). This includes paper, plastic, and cloth items, such as cookbooks, plastic ware, and towels, as well as flammable liquids. Do not store explosives, such as aerosol cans, on or near the appliance.

Do not leave children alone - Children should not be left alone or unattended in the area where appliance is in use. They should never be allowed to sit or stand on any part of the appliance, including the storage drawer, lower broiler drawer, warmer drawer, or lower double oven.

Do not store items of interest to children in the cabinets above the appliance or on the backguards of ranges. Children climbing on or near the appliance to reach items could be seriously injured.

WARNING

Do not allow children to climb or play around the appliance. The weight of a child on an open oven door may cause the appliance to tip, resulting in serious burns or other injury. An open drawer when hot may cause burns.

Stepping, leaning, or sitting on the door or drawers of this appliance can result in serious injuries and also cause damage to the appliance.

Never cover any slots, holes or passages in the oven bottom or cover and entire rack with materials such as aluminum foil. Doing so blocks air flow through the oven and may cause carbon monoxide poisoning. Aluminum foil linings may also trap heat, causing a fire hazard.

Do not use oven or warmer drawer (if equipped) for storage.

Never use your appliance as a space heater to heat or warm the room. Doing so may result in carbon monoxide poisoning and overheating of the appliance.

CAUTION

When heating fat or grease, watch it closely. Grease may catch fire if it becomes too hot.

Do not use water or flour on grease fires. Smother fire or flame or use dry chemical or foam-type extinguisher. Cover the fire with a pan lid or use baking soda.

Use dry potholders. Moist or damp potholders on hot surfaces may result in burns from steam. Do not let potholders touch hot cooking areas. Do not use towels or other bulky cloths.

Do not heat unopened food containers - Build-up of pressure may cause container to burst and result in injury.

CAUTION

Wear proper apparel - Loose-fitting or hanging garments should never be worn while using the appliance. Do not let clothing or other flammable materials contact hot surfaces.

Do not touch surface burners or elements, areas near these burners or elements, interior surfaces of the oven, or the warmer drawer (if equipped). Surface burners and elements may be hot even though they appear cool. Areas near surface burners and elements may become hot enough to cause burns. During and after use, do not touch, or let clothing or other flammable materials touch these areas until they are cool. These areas may include the cooktop, surfaces facing the cooktop, oven vent areas, oven door, and oven window.

Do not attempt to operate the appliance during a power failure. If the power fails, always turn off the appliance. If the appliance is not turned off and the power resumes, electric surface elements may resume operation when power is restored. Once the power resumes, reset the clock and the oven function.

IMPORTANT INSTRUCTIONS FOR USING YOUR RADIANT COOKTOP

Know which knob or key controls each surface heating area. Place cookware with food on the cooking area before turning it on. Turn the cooking area off before removing the cookware.

Cookware handles should be turned inward and not extend over adjacent surface elements — To reduce the risk of burns, ignition of flammable materials, and spillage due to unintentional contact with the utensil, the handle of the cookware should be positioned so that it is turned inward, and does not extend over other cooking areas.

6 Important Safety Instructions

Use proper pan size - This appliance is equipped with one or more surface units of different sizes. Select cookware with flat bottoms that match the surface unit size. Using the proper cookware on the cooking area will improve efficiency.

Glazed cooking utensils— Only certain types of glass, glass/ceramic, ceramic, earthenware, or other glazed utensils are suitable for cooktop service without breaking due to the sudden change in temperature. Check the manufacturer's recommendations for cooktop use.

Improper cookware may break due to sudden changes in temperature. Check the cookware manufacturer's recommendations for cooktop use.

Never leave surface elements unattended. Boil-overs may cause smoking and greasy spills that may ignite. A pan that has boiled dry could be damaged and may damage the cooktop.

Do not use a searing grill meant for use with a broiler pan on the cooktop. The searing grill is not designed for use on the cooktop. Doing so may result in a fire.

When you are flaming foods under a ventilating hood, turn on the fan.

IMPORTANT INSTRUCTIONS FOR GLASS AND CERAMIC COOKTOPS

Do Not Clean or Operate a Broken Cooktop. If cooktop should break, cleaning solutions and spillovers may penetrate the broken cooktop and create a risk of electric shock. Contact a qualified technician immediately.

Clean cooktop glass with caution. If a wet sponge or cloth is used to wipe spills on a hot cooking area, be careful to avoid a steam burn. Some cleaners can produce harmful fumes if applied to a hot surface.

Avoid scratching the cooktop glass with sharp objects.

IMPORTANT INSTRUCTIONS FOR USING YOUR OVEN

Protective liners—Do not use aluminum foil, aftermarket oven liners, or any other materials or devices to line oven bottom, oven racks, or any other part of the appliance. Only use aluminum as recommended for baking, such as lining cookware or as a cover placed on food. Any other use of protective liners or aluminum foil may result in a risk of electric shock or fire or a short circuit.

Use care when opening oven door, lower oven door, or warmer drawer (some models). Stand to the side of the appliance when opening the door of a hot oven. Let hot air or steam escape before you remove or replace food in the oven.

Keep oven vent ducts unobstructed. Touching surfaces in this area when the oven is on may cause severe burns. Do not place plastic or heat-sensitive items on or near the oven vent. These items can melt or ignite.

Placement of oven racks - Always place oven racks in desired location while oven is cool. If rack must be moved while oven is hot, do not let potholder contact hot burner or element in oven. Use potholders and grasp the rack with both hands to reposition. Remove all cookware and utensils before moving the rack.

Do not use a broiler pan without its insert. Broiler pans and inserts allow dripping fat to drain away from the high heat of the broiler. Do not cover the broiler insert with aluminum foil; exposed fat and grease could ignite.

Do not cook food on the oven bottom. Always cook in proper cookware and always use the oven racks.

IMPORTANT INSTRUCTIONS FOR CLEANING YOUR APPLIANCE

CAUTION

Before manually cleaning any part of the appliance, be sure all controls are turned off and the appliance is cool. Cleaning a hot appliance can cause burns.

Clean the appliance regularly to keep all parts free of grease that could catch fire. Do not allow grease to accumulate. Greasy deposits in the fan could catch fire.

Always follow the manufacturer's recommended directions for use of kitchen cleaners and aerosols. Be aware that excess residue from cleaners and aerosols may ignite causing damage and injury.

Clean ventilating hoods frequently - Grease should not be allowed to accumulate on hood or filter. Follow the manufacturer's instructions for cleaning vent hoods.

IMPORTANT INSTRUCTIONS FOR SELF CLEANING OVENS

Do not clean the oven door gasket. The door gasket is essential for a good seal. Care should be taken not to rub, damage, or move the gasket.

Do not use oven cleaners. No commercial oven cleaner or oven liner protective coating of any kind should be used in or around any part of the appliance.

Use the self clean cycle to clean only the parts listed in this manual.

Before using self clean, remove the broiler pan, any food, utensils, and cookware from the oven, storage drawer or warming drawer (if equipped). Remove oven racks unless otherwise instructed.

Some birds are extremely sensitive to the fumes given off during the self clean cycle of any oven. Move birds to another well-ventilated room.

IMPORTANT INSTRUCTIONS FOR SERVICE AND MAINTENANCE

Do not repair or replace any part of the appliance unless specifically recommended in the manuals. All other servicing should be done only by a qualified technician. This reduces the risk of personal injury and damage to the appliance.

Always contact your dealer, distributor, service agent, or manufacturer about problems or conditions you do not understand.

Ask your dealer to recommend a qualified technician and an authorized repair service. Know how to disconnect the power to the appliance at the circuit breaker or fuse box in case of an emergency.

Remove the oven door from any unused oven if it is to be stored or discarded.

Do not touch a hot oven light bulb with a damp cloth. Doing so could cause the bulb to break. Handle halogen lights (if equipped) with paper towels or soft gloves. Disconnect the appliance or shut off the power to the appliance before removing and replacing the bulb.

Important Safety Notice - The California Safe Drinking Water and Toxic Enforcement Act requires the governor of California to publish a list of substances known to cause cancer, birth defects, or other reproductive harms, and requires businesses to warn customers of potential exposures to such substances.

Oven control features & options

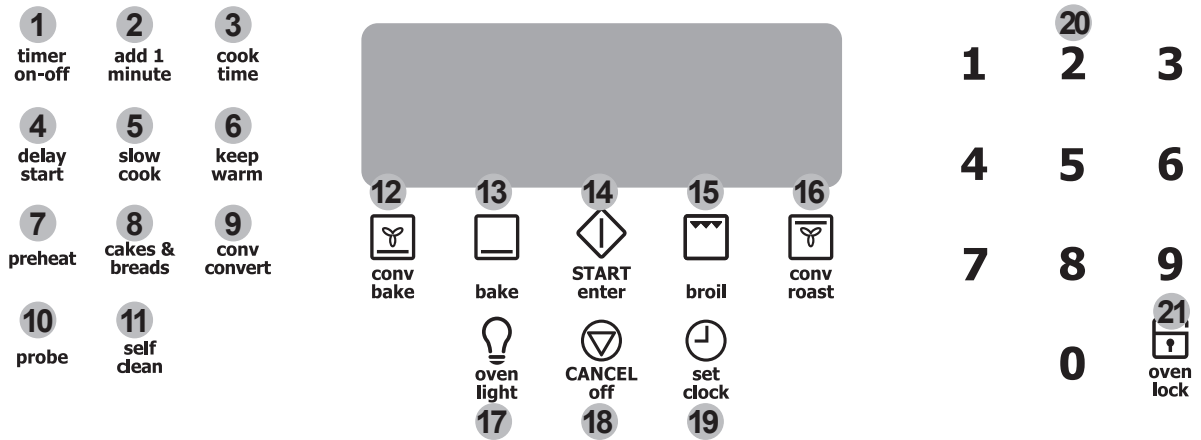

1. Timer
2. Add 1 minute
3. Cook time
4. Delay start
5. Slow cook
6. Keep warm
7. Preheat
8. Cakes & breads
9. Convection convert
10. Probe
11. Self clean
12. Convection bake
13. Bake
14. Start
15. Broil
16. Convection roast
17. Oven light
18. Cancel
19. Set clock
20. Numeric key pads
21. Oven door lock

Minimum & maximum control settings

Feature	Min. temp	Max. temp
Bake	170°F / 77°C	550°F / 288°C
Broil	400°F / 204°C	550°F / 288°C
Conv Bake	170°F / 77°C	550°F / 288°C
Conv Roast	170°F / 77°C	550°F / 288°C
Keep Warm	170°F / 77°C	170°F / 77°C
Slow Cook	Lo (225°F / 108°C)	Hi (275°F / 135°C)

Minimum & maximum time settings

Feature	Min. time	Max. time
Timer	1 min	11 hr 59 min
Clock 12 hr	1:00 hr	12 hr 59 min
Clock 24 hr	0:00 hr	23 hr 59 min
Cook time 12 hr	1 min	11 hr 59 min
Cook time 24 hr	1 min	11 hr 59 min
Delay start 12 hr	1:00 hr	12 hr 59 min
Delay start 24 hr	0:00 hr	23 hr 59 min
Clean duration	2:00 hr	4:00 hr

Oven vents location

The oven is vented through its **upper front frame**. When the oven is on, warm air is released through the vent. This venting is necessary for proper air circulation in the oven and good baking results. **Do not block oven vent.**

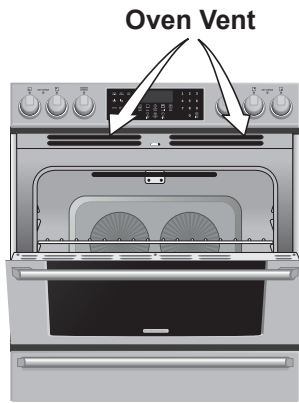

CAUTION

Some models are equipped with a cooling fan that runs in the bake and self-clean modes to keep internal components at a cool temperature. The fan may keep running after the oven has been turned off until the components have cooled down.

Air circulation in the oven

If using 1 rack, place in center of oven. If using multiple racks, stagger cookware as shown.

For best air circulation and baking results allow 2-4" (5-10 cm) around the cookware for proper air circulation and be sure pans and cookware do not touch each other, the oven door, sides or back of the oven cavity. The hot air must circulate around the pans and cookware in the oven for even heat to reach around the food.

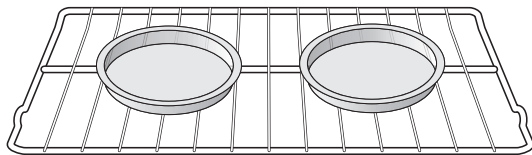

1 Oven Rack

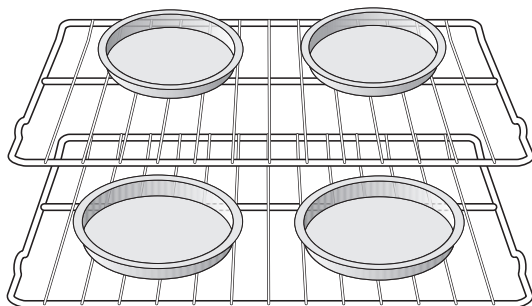

Multiple Oven Racks

Types of oven racks

CAUTION

Always use pot holders or oven mitts when adjusting the oven racks. Wait until the oven has completely cooled if possible. Oven racks may be HOT and cause burns.

Your appliance may be equipped with one or more of the oven rack types shown; Flat Handle Oven Rack, Fully Extendable Luxury-Glide™ Oven Rack and Offset Oven Rack.

Flat oven racks may be used for most cooking needs and may be placed in most oven rack positions.

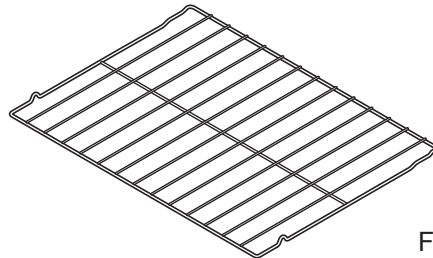

Flat oven rack

The fully extendable Luxury-Glide™ oven rack allows you to effortlessly extend your food away from the oven.

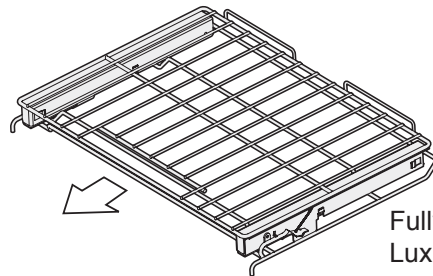

Fully extendable Luxury-Glide™ oven rack

To maximize cooking space the Offset Oven Rack can be used in the lowest rack position to roast large cuts of meat and poultry.

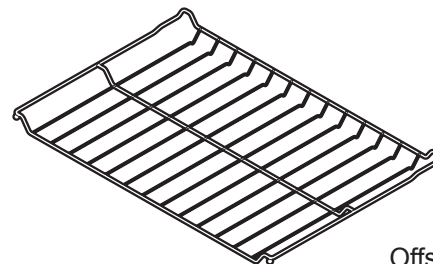

Offset oven rack

Luxury Glide™ oven racks

➔ IMPORTANT

Remove **ALL oven racks** before starting a fresh clean cycle. If oven racks are left inside the oven during a cleaning cycle, the slide ability of the **Luxury-Glide™** oven racks may be damaged and all of the oven racks will lose their shiny finish. Clean oven racks according to the instructions provided in the **Care & Cleaning** section.

The fully extendable **Luxury-Glide™** rack makes food preparation easier. This oven rack has glide tracks that allow the rack to be pulled away from the oven without rubbing the sides of the oven wall.

Removing and replacing the Luxury-Glide™ oven racks

To remove - Make sure the baking rack is in the closed position. Using one hand, reach through handle opening and grasp both the upper and lower portions of the glide rack as shown in Figure 1.

Using both hands, lift up the front of the rack slightly and continue to pull the rack away from the oven (Figure 2). Be sure to grasp both upper and lower rack portions together when removing or handling the glide rack

The rack portions move independently and should be held together when removing and replacing.

To replace - Make sure the baking rack is in the closed position. Grasp both upper and lower portions of glide rack. Lift and hold the rack level between the oven cavity walls. Tilt the front of the rack upward slightly and slide the rack completely into position.

➔ IMPORTANT

To prevent possible damage to the oven, **DO NOT** attempt to close the oven door until all the oven racks are fully positioned back inside the oven cavity.

Arranging Regular Racks

To remove an oven rack, pull the rack forward until it stops. Lift up front of rack and slide out (fig. 4).

To replace an oven rack, fit the rack onto the guides on the oven walls. Tilt the front of the rack upward and slide the rack back into place.

Luxury-Glide™ extendable oven rack

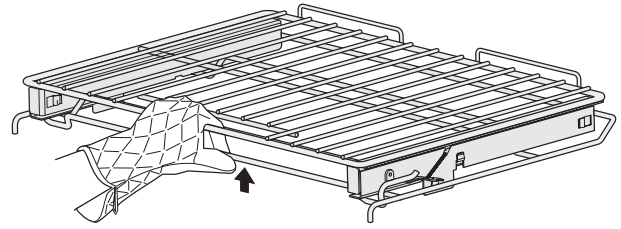

Fig. 1: Grasp both rack sections

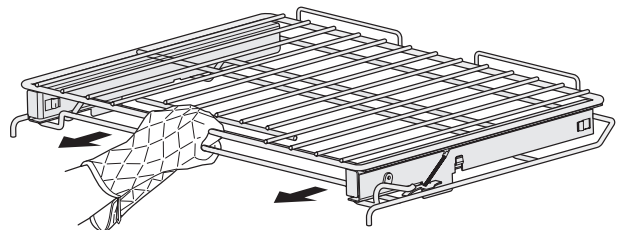

Fig. 2: Remove and replace using both hands

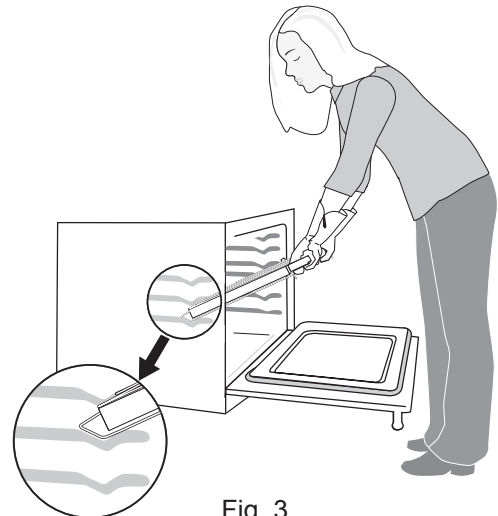

Fig. 3

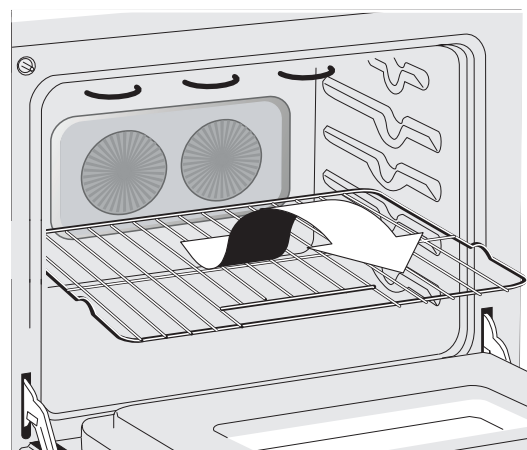

Fig. 4

About the ceramic glass cooktop

The ceramic cooktop has radiant surface elements located below the surface of the glass. The design of the ceramic cooktop outlines the area of the surface element underneath. **Make sure** the diameter of the pan matches the diameter of the element outline on the cooktop. Heat is transferred up through the surface of the cooktop to the cookware. Only flat-bottom cookware should be used. The type and size of cookware, the number of surface elements in use and the settings, are all factors that will affect the amount of heat that will spread to areas beyond the surface elements. The areas surrounding the elements may become **hot enough to cause burns**.

About the radiant surface elements

The element temperature rises gradually and evenly. As the temperature rises, the element will glow red. To maintain the selected setting, the element will cycle on and off. The heating element retains enough heat to provide a uniform and consistent heat during the off cycle. For efficient cooking, turn off the element several minutes before cooking is complete. This will allow residual heat to complete the cooking process.

Your range is equipped with radiant surface burners with different wattage ratings. The ability to heat food quicker and in larger volumes increases as the element wattage increases.

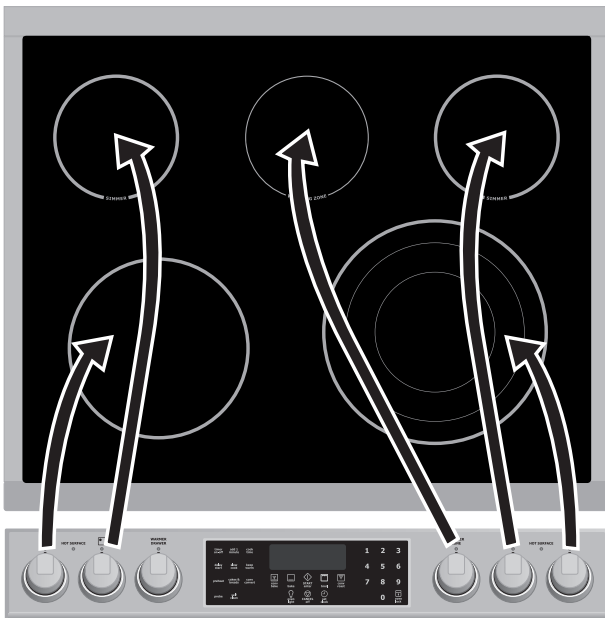

NOTE

Radiant elements have a limiter that allows the element to cycle ON and OFF, even at the HI setting. This helps to prevent damage to the ceramic glass cooktop. Cycling at the HI setting is normal and can also occur if the cookware is too small for the radiant element or if the cookware bottom is not flat.

Please read detailed instructions for ceramic glass cooktop cleaning in the **Care & Cleaning** section and **Solutions to Common Problems** section of this Use and Care Guide.

Surface cooking utensils

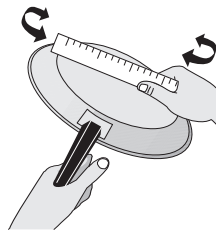

Pans should have flat bottoms. Check for flatness by rotating a ruler across the bottom. There should be no gaps between the pan and ruler.

* Specialty pans such as lobster pots, griddles and pressure cookers may be used but must conform to the above recommended cookware requirements.

*GOOD

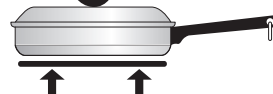

- Flat bottom and straight sides.
- Tight fitting lids.
- Weight of handle does not tilt pan. Pan is well balanced.
- Pan sizes match the amount of food to be prepared and the size of the surface element.
- Made of material that conducts heat well.
- Easy to clean.
- Always match pot diameter to element surface diameter.

POOR

- Curved and warped pan bottoms.



- Pan overhangs unit by more than 2.5 cm (1").



- Heavy handle tilts pan.



- Pan is smaller than element.



Note: Always use a utensil for its intended purpose. Follow manufacturer's instructions. Some utensils were not made to be used in the oven or on the cooktop.

Cookware material types

The cookware material determines how evenly and quickly heat is transferred from the surface element to the pan bottom. The most popular materials available are:

ALUMINUM - Excellent heat conductor. Some types of food will cause it to darken (Anodized aluminum cookware resists staining & pitting). If aluminum pans slide across the ceramic glass cooktop, they may leave metal marks which will resemble scratches. Remove these marks immediately.

COPPER - Excellent heat conductor but discolors easily. May leave metal marks on ceramic glass (see Aluminum above).

STAINLESS STEEL - Slow heat conductor with uneven cooking results. Is durable, easy to clean and resists staining.

CAST IRON - A poor heat conductor however will retain heat very well. Cooks evenly once cooking temperature is reached. Not recommended for use on ceramic cooktops.

PORCELAIN-ENAMEL on METAL - Heating characteristics will vary depending on base material. Porcelain-enamel coating must be smooth to avoid scratching ceramic cooktops.

GLASS - Slow heat conductor. Not recommended for ceramic cooktop surfaces because it may scratch the glass.

Element On & Hot Surface indicator lights

Your appliance is equipped with two different types of surface control indicator lights that will glow on the control panel — the **ELEMENT ON** indicator light and the **Hot Surface** indicator lights (see Fig. 1).

The **ELEMENT ON** indicator light is marked on the control panel and will glow when a surface element is turned ON. A quick glance at this indicator light after cooking is an easy check to be sure ALL surface controls are turned OFF.

The **Hot Surface** indicator lights are located on the control panel just above each surface control knob. They will glow when any surface cooking area heats up and will remain on until the cooktop has cooled to a MODERATE level.

Suggested cooktop power settings

Use the chart below to determine the suggested setting for the type of food you are preparing when using the cooktop.

Recommended surface setting chart	
Setting	Type of Cooking
High (Hi)	Start most foods; bring water to a boil and pan broiling.
Medium high (8 - 9.5)	Continue a rapid boil; frying, deep fat frying.
Medium (6)	Maintain a slow boil; thicken sauces and gravies; steaming vegetables.
Medium Low (4 - 5)	Keep foods cooking; poaching and stewing.
Low (Lo - 3)	Keep warm, melting and simmering.

CAUTION

Radiant surface elements may appear to have cooled after they have been turned off. The Hot Element Message Light will turn on and will continue to glow until the glass cooktop has cooled down to a moderate level. The glass surface may still be hot and burns may occur if the glass surface is touched before the indicator light has turned OFF.

Do not place plastic items such as salt and pepper shakers, spoon holders or plastic wrappings on top of the range when it is in use. These items could melt or ignite. Potholders, towels or wooden spoons could catch fire if placed too close to the surface elements.

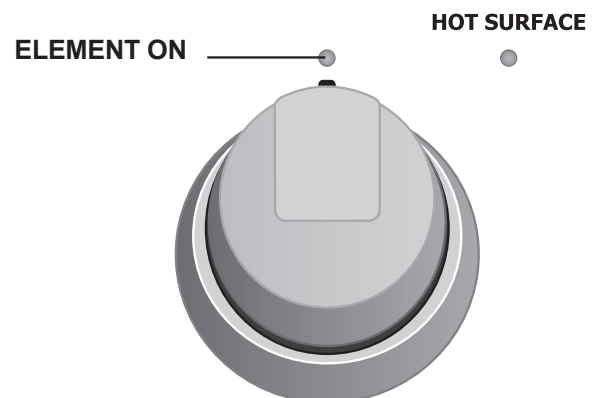

Figure 1

Operating Single Radiant Surface Elements

1. Place correctly sized cookware on the radiant surface element.
2. Push in and turn the surface control knob in either direction to the desired setting. Turn the knob to adjust the setting if desired.
3. When cooking has completed, turn the surface control knob to OFF before removing the cookware.

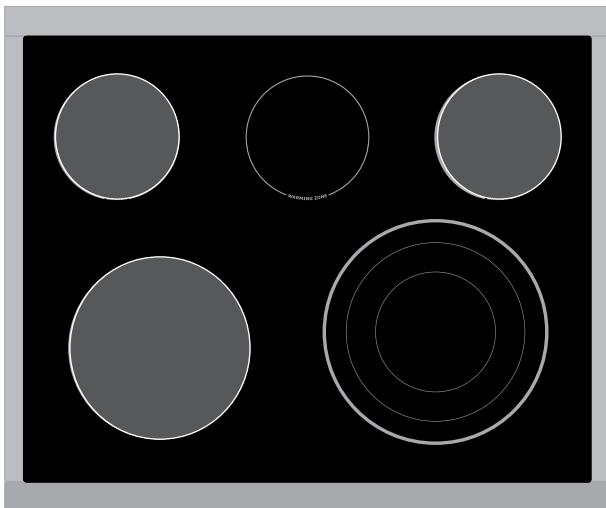
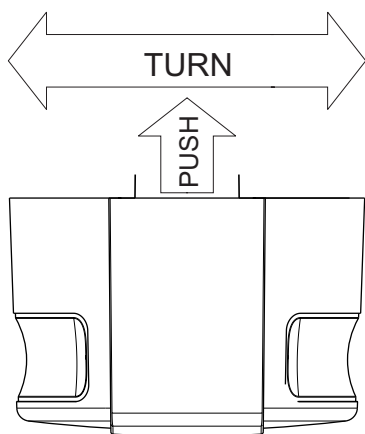

Figure 1 - Location of Single Elements



▶ IMPORTANT

- For efficient cooking, turn off the element several minutes before cooking is complete. This will allow residual heat to complete the cooking process.
- The surface control knobs do not have to be set exactly on a particular spot. Use the graphics provided as a guide and adjust the control knob as needed. Each surface element provides a constant amount of heat at each setting. Refer to chart above for suggested power level settings.
- Start most cooking operations on a higher setting and then turn to a lower setting to finish cooking.
- Radiant elements have a limiter that allows the radiant heating element to cycle on and off, even at the HI setting. This helps prevent damage to the ceramic smooth top. Cycling at the HI setting is normal and will occur more often if cookware is too small for the radiant element or if the cookware bottom is not flat.
- A glowing red surface heating area extending beyond the bottom edge of the cookware indicates the cookware is too small for the surface heating area.

⚠ CAUTION

Radiant surface elements may appear to have cooled after they have been turned off. The glass surface may still be hot and burns may occur if the glass surface is touched before it has cooled sufficiently.

Do not place plastic items such as salt and pepper shakers, spoon holders or plastic wrappings on top of the range when it is in use. These items could melt or ignite. Potholders, towels or wooden spoons could catch fire if placed too close to the surface elements.

Do not allow aluminum foil, empty glass/porcelain cookware or any material that can melt to make contact with the ceramic cooktop. If these items melt on the cooktop they may damage the ceramic cooktop.

14 Setting Surface Controls

Operating Triple Radiant Surface Elements

1. Place correctly sized cookware on the radiant surface element.
2. Push in and turn the surface control knob clockwise to begin heating all, the inner, middle and outer portions of the element (Marked triple - see figure 1). If the two inner heating portions are needed turn the knob at position marked dual (Marked dual - see figure 2). If only inner heating portion is needed for smaller cookware, push in and turn the knob counterclockwise (Marked inner - see figure 3).
Note: You may switch from the single, double or triple settings at any time during cooking. Please note that all three portions will adjust to the same power level.
3. When cooking has completed, turn the surface control knob to OFF before removing the cookware.

➔ IMPORTANT

- For efficient cooking, turn off the element several minutes before cooking is complete. This will allow residual heat to complete the cooking process.
- The surface control knobs do not have to be set exactly on a particular spot. Use the graphics provided as a guide and adjust the control knob as needed. Each surface element provides a constant amount of heat at each setting. Refer to chart above for suggested power level settings.
- Start most cooking operations on a higher setting and then turn to a lower setting to finish cooking.
- Radiant elements have a limiter that allows the radiant heating element to cycle on and off, even at the HI setting. This helps prevent damage to the ceramic smooth top. Cycling at the HI setting is normal and will occur more often if cookware is too small for the radiant element or if the cookware bottom is not flat.
- A glowing red surface heating area extending beyond the bottom edge of the cookware indicates the cookware is too small for the surface heating area.

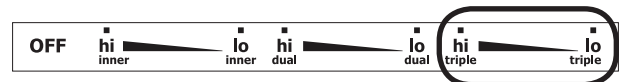
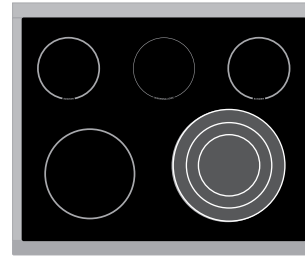

Figure 1 - Heating with all portions*

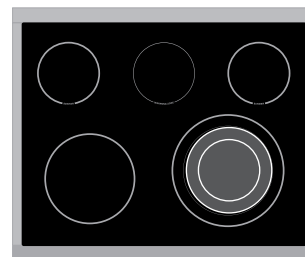

Figure 2 - Heating with the two inner portions*

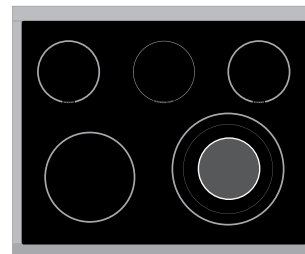

Figure 3 - Heating with inner portion only*

*Areas that heat are shown darkened.

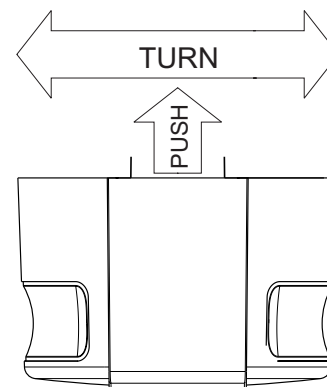

Figure 4 - Triple Surface Element Control Knob

Operating the Warmer Zone

The purpose of the warmer zone is to keep hot cooked foods at serving temperature. Use the warmer zone feature to keep cooked foods hot such as; vegetables, gravies, casseroles, soups, stews, breads, pastries and oven-safe dinner plates.

Always start with hot food. Do not heat cold food with the warmer zone. All food placed on the warmer zone should be covered with a lid to maintain quality.

For best results, when warming pastries or breads, the cover should have an opening to allow moisture to escape. Use only dishware, utensils and cookware recommended for oven and cooktop use on the warmer zone.

CAUTION

Unlike other radiant surface element, the warm zone will not glow red when it is hot. The glass surface may be still hot and burns can occur if the glass surface is touched before it has cooled sufficiently.

Always use potholders or oven mitts when removing food from the warm zone as cookware and plates will not be hot.

Do not place flammable items such as plastic salt and pepper shakers, spoon holders or plastic wrappings on top of the range when it is in use. These items could melt or ignite. Potholders, towels or wooden spoons could catch fire if placed too close to the warm zone.

Do not allow aluminum foil, empty glass/porcelain cookware or any material that can melt to make contact with the ceramic cooktop. If these items melt on the cooktop they may damage the ceramic cooktop.

IMPORTANT

- Use only plates, utensils and cookware recommended for oven and ceramic cooktop use. Do not use plastic wrap or aluminum foil to cover food. Plastic or aluminum foil can melt onto the cooktop.

- Place correctly sized cookware on the warmer zone.
- Push in and turn the surface control knob in either direction to the desired setting. Turn the knob to adjust the setting if desired.
- When it is time to serve food, turn the surface control knob to OFF before removing the cookware.

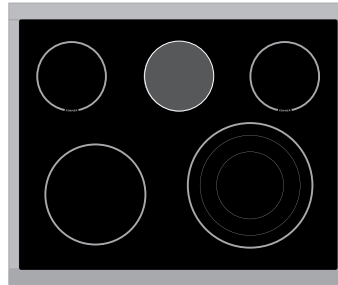

Figure 1 - Location of the Warmer Zone

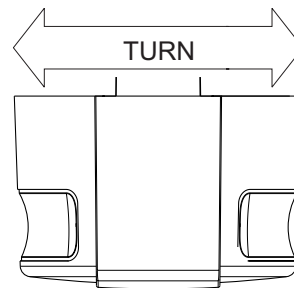

Figure 2 - Warmer Zone Control Knob

Temperature selection - Refer to the warm zone recommended food settings (See Figure 3). If a particular food is not listed, start with the medium level, and adjust as needed. Most foods can be kept at serving temperatures using the medium setting.

Food Item	Heating Level
Breads/Pastries	LO (Low)
Casseroles	LO (Low)
Dinner Plates with Food	LO (Low)
Eggs	LO (Low)
Gravies	LO (Low)
Meats	MED (Medium)
Sauces	MED (Medium)
Soups (cream)	MED (Medium)
Stews	MED (Medium)
Vegetables	MED (Medium)
Fried Foods	HI (High)
Hot Beverages	HI (High)
Soups (liquid)	HI (High)

Figure 3 - Warm zone recommended food settings

Setting Clock at Power Up

You will be prompted to enter the time of day in the event of a power failure or when you first provide electric power to your appliance.

- When your appliance is first powered up, 12:00 will flash in the display.
- Press **CLOCK** . Enter the time of day using the numeric key pads and press **START** to set.

If an invalid time of day is entered, the control will triple beep. Re-enter a valid time of day and press **START**. If **CANCEL** is pressed your clock will start with the time set for **12:00**.

Setting Timer

The timer provided with the oven control serve as extra reminders in the kitchen. When the time runs out the active timer will beep, and “End” will be displayed.

The following time settings apply to the timers:

- Min. time: 1 minute
- Max. time: 11 hours 59 minutes

See example below to set the timer for 5 minutes:

Example	
Step	Press
1. Press TIMER on-off	timer on-off
2. Enter 5 minutes	5
3. Press START	

To cancel after setting the timer, press the **TIMER on-off** key again.

NOTE

The timer(s) will not affect the cooking process.

Preheat Temperature Display

Once a cooking feature has been started, the control will display the actual oven temperature while preheating. Once the oven reaches the oven set temperature, only the oven set temperature will be displayed.

The preheat temperature display is available with the following cooking modes:

- Bake
- Convection Bake
- Cakes & Breads

The minimum temperature displayed is 100°F/38°C.



To Set Add 1 Minute Feature

The ADD 1 MINUTE pad is used to set the Add 1 Minute feature. When the pad is pressed, 1 minute is added to the Timer feature if this feature is already active. If the Timer feature is not active and the pad is pressed, the Timer feature will become active and will begin counting down from 1 minute. For further information on how to set the Timer feature see Timer instructions above.

Setting Oven Lockout

The Oven Lockout feature automatically locks the oven door and prevents the oven from being turned on. It does not disable the clock, Timer or the interior oven lights.

See example below to lock the ovens.

Example	
Step	Press
To lock, press and hold OVEN LOCK for 3 seconds.	 3sec
To unlock, press and hold OVEN LOCK for 3 seconds.	 3sec

DOOR LOCKED will flash in the display until the door has finished locking. Once the door has been locked the door lock indicator will turn on. **DOOR LOCKED** will then stay displayed.

Do not attempt to open the oven door while the door lock indicator is flashing.

Preheat

The Preheat feature will bring the oven up to the set cooking temperature. A reminder tone will sound indicating when the set temperature is reached and to place the food in the oven. Preheating is not necessary when roasting or cooking casseroles.

The following temperature settings apply to the preheat feature:

- Auto-suggest (default) setting: **350°F/177°C**
- Min. preheat setting: **170°F / 77°C**
- Max. preheat setting: **550°F / 288°C**

Setting preheat

See example below to set a preheat to start immediately at the default temperature.

Example	
Step	Press
1. Press PREHEAT	preheat

If needed, use numeric keypads to enter a different oven temperature.

2. Press **START** 

“**PRE**” and the actual oven temperature shown in the display will alternate as the oven heats and reaches set temperature.

When the oven is finished preheating, the controls will beep to remind you to place food in the oven. The preheat feature will perform like the Bake feature and continue to maintain the oven set temperature until cancelled.

NOTE

- To cancel the function, you may press **CANCEL** at any time when setting the control or during the cooking process.
- To change the set temperature while the oven is already heating, follow the same procedure described above.
- During the preheating, the convection fan will be activated to allow the oven to reach its target temperature faster. The convection fan will pulse on and off for better heat distribution. The Bake, Broil and Convection elements will also cycle for a better heat distribution.



For best results

- **Single oven rack cooking ONLY.**
- Use in oven rack positions 2 or 3.

18 Setting Oven Controls

Bake



Use the bake feature to cook most food items that require normal cooking temperatures.

The following temperature settings apply to the bake feature:

- Auto-suggest (default) setting: **350°F/177°C**
- Min. bake setting: **170°F / 77°C**
- Max. bake setting: **550°F / 288°C**

Setting bake

See example below to set a bake to start immediately using the default temperature.

Example	
Step	Press
1. Press BAKE	
If needed, use numeric keypads to enter a different oven temperature.	
2. Press START	

Once **START** is pressed the oven will begin heating. The oven display shows the temperature rising.

After the oven reaches set temperature a beep will indicate the oven is ready. The oven will continue to maintain this temperature until the cooking feature is canceled.

NOTE

To cancel the function, you may press **CANCEL** at any time when setting the control or during the cooking process.

To change the set temperature while the oven is already heating, just enter the temperature using the numeric pads.

During the preheating, the convection fan will be activated to allow the oven to reach its target temperature faster. The convection fan will pulse on and off for better heat distribution. The Bake, Broil and Convection elements will also cycle for a better heat distribution.



For best results

- As much as possible, use only one rack on position 2 or 3 and center the pans. If using two racks, place the oven racks in position 1 and 4.
- When placing multiple food items in the oven allow 2-4" (5-10cm) of space between the food items for proper air circulation.
- Dark or dull pans absorb more heat than shiny bakeware resulting in dark or overbrowning of foods. It may be necessary to reduce the oven temperature or cook time to prevent overbrowning of some foods. Dark pans are recommended for pies. Shiny pans are recommended for cakes, cookies and muffins.

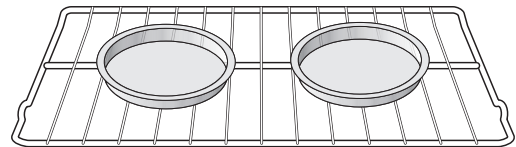

Pan position for one rack baking.

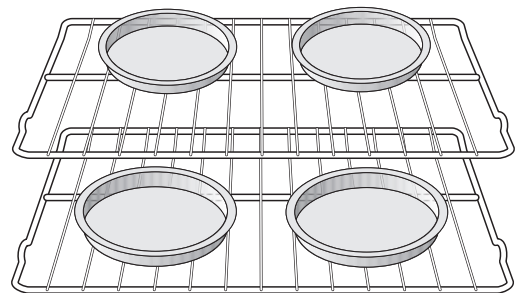

Pan position for two rack baking.



Cook Time

Adding a cook duration when baking is beneficial when a recipe requires a specific temperature and period of time to cook. Following the recipe cook time helps insure the best possible results.

Cook time may be set with the following features:

- Preheat
- Bake
- Broil
- Conv Bake
- Conv Roast
- Slow Cook
- Keep Warm
- Cake & Breads

See example below to set the oven for bake, starting immediately with preheating to the auto-suggest (default) setting of 350°F (177°C) and then to automatically turn off after 30 minutes:

Example	
Step	Press
Preheat the oven if necessary	
1. Press BAKE	
2. Press COOK TIME	cook time
3. Enter 30 minutes	30
4. Press START	

Once **START** is pressed the oven will cook and after 30 minutes automatically shut-off.

When the Cook Time finishes:

1. “**End**” will show in display. The oven will shut off automatically.
2. The control will beep 3 times. The control will continue to beep 3 times every 30 seconds until **CANCEL** is pressed.

NOTE

- To cancel the function, you may press **CANCEL** at any time when setting the control or during the cooking process.
- The maximum Cook Time setting is 11 hours and 59 minutes.
- After the Cook Time feature has been activated, the display will go back to showing the hour of day. Press the **COOK TIME** keypad to display any remaining cook time.
- Dark or dull pans absorb more heat than shiny bakeware resulting in dark or overbrowning of foods. It may be necessary to reduce the oven temperature or cook time to prevent overbrowning of some foods. Dark pans are recommended for pies. Shiny pans are recommended for cakes, cookies or muffins.



Delay Start (with cook time)

Adding a cook duration along with a specific start time gives the same benefits as the cook time option in addition to controlling exactly when the cooking process will begin and end.

Delay start may be set with the following features:

- Bake
- Broil
- Conv Bake
- Conv Roast
- Slow Cook
- Self Clean
- Cake & Breads

See example below to set the oven with preheating for bake at 375°F (191°C) for 50 minutes and to automatically start at 5:30:

Example	
Step	Press
1. Press BAKE	
2. Enter 375°F	375
3. Press COOK TIME	cook time
4. Enter 50 minutes	50
5. Press DELAY START	delay start
6. Enter 5:30	530
7. Press START	

Once **START** is pressed, the oven will calculate the start time at which the oven will begin heating.

The oven will continue to maintain this temperature for the selected time or until the cooking feature is canceled.

NOTE

- When setting the **DELAY START** option be sure the correct time of day is set.
- You may press **CANCEL** any time when setting the control or during the cooking process.
- You may also choose to use **DELAY START** with no **COOK TIME**.
- Delay Start may be set using a 24 hour clock. See Setting 12 or 24 hour display modes for more information.

WARNING

FOOD POISONING HAZARD. Do not let food sit for more than one hour before or after cooking. Doing so can result in food poisoning or sickness. Foods that can easily spoil such as milk, eggs, fish, meat or poultry, should be chilled in the refrigerator first. Even when chilled, they should not stand in the oven for more than 1 hour before cooking begins, and should be removed promptly when finished cooking.

Convection Bake

Convection Bake uses a fan to circulate the oven heat evenly and continuously. The improved heat distribution allows for even cooking with excellent results. Multiple rack cooking may slightly increase cook times for some foods, but the overall result is time saved.

The Conv Bake feature is recommended when baking on multiple racks.

If your recipe instructions are for normal baking and you wish to use convection bake, follow the **Convection Convert** option instructions. The convection convert option will automatically adjust the oven temperature so that convection baking may provide the best possible result

Conv bake may be set with the following options:

- Conv Convert
- Cook Time and/or Delay Start

Benefits of convection bake:

- Superior multiple oven rack performance.
- Some foods cook up 25 to 30% faster, saving time and energy.
- No special pans or bakeware required.



For best results

- When baking with a single rack use rack positions 2 or 3. When using 2 racks use rack positions 1 (offset rack) & 3. When using 3 racks use rack positions 1, 3 & 4.
- When baking cookies and biscuits on multiple racks, use positions 1 and 4. When baking cakes on multiple racks, use positions 1 (offset rack) and 3.
- Cookies and biscuits should be baked on pans with no sides or very low side to allow heated air to circulate around the food.
- Food baked on pans with a dark finish will cook faster.
- When placing multiple food items in the oven allow 2-4" (5-10cm) of space between the food items for proper air circulation.

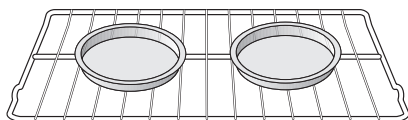

Pan position for one rack baking.

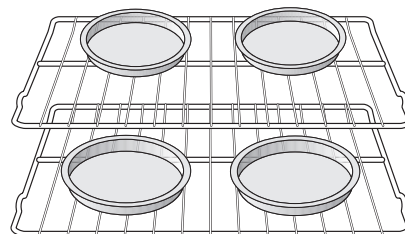

Pan position for two rack baking.

The following temperature settings apply to the conv bake feature:

- Auto-suggest (default) setting: **350°F/177°C**
- Min. bake setting : **170°F / 77°C**
- Max. bake setting: **550°F / 288°C**

See the example below to set conv bake, starting immediately with the auto-suggest (default) setting of 350°F (176°C):

Example

Step	Press
------	-------

1. Press CONV BAKE	
---------------------------	--

If needed, use numeric keypads to enter a different oven temperature.

2. Press START	
-----------------------	--

After the oven reaches set temperature, a beep will indicate the oven is ready. The oven will continue to maintain this temperature until the cooking feature is canceled.

NOTE

You may press **CANCEL** at any time when setting the control or during the cooking process.

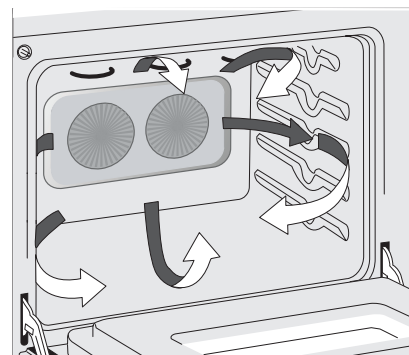

Convection air flow

Convection Convert

The conv convert option allows you to convert any normal baking recipe using the convection bake feature. The control uses the normal recipe settings and adjusts to a lower temperature for convection baking. Conv convert must be used with Conv Bake feature.

Benefits of conv bake using conv convert option:



- Superior multiple oven rack performance.
- Some foods cook up 25 to 30% faster, saving time and energy.
- No special pans or bakeware required.



For best results

- Place food items using the recommended rack positions. When baking with a single rack use rack positions 2 or 3. When using 2 racks use rack positions 1 (offset rack) & 3. When using 3 racks use rack positions 1, 3 & 4.
- Cookies and biscuits should be baked on pans with no sides or very low side to allow heated air to circulate around the food.
- Food baked on pans with a dark finish will cook faster.
- When placing multiple food items in the oven allow 2-4" (5-10cm) of space between the food items for proper air circulation.

See the example below to set conv bake, starting immediately with the auto-suggest (default) setting of 350°F (177°C) and adding the conv convert option.

Example	
Step	Press
1. Press CONV BAKE	
If needed, use numeric keypads to enter a different oven temperature.	
2. Press CONV CONVERT	conv convert
3. Press START	

After the oven reaches the converted set temperature, a beep will indicate the oven is ready.

The added conv convert option will automatically lower the set temperature you set from the bake recipe to an adjusted conv bake temperature.

When conv convert is used with cook time "CF" (Check Food) will be displayed when the cook time is 75% complete. The control will also beep at regular intervals until baking has finished. For the Check Food function to operate, the minimum cook time must be above 20 minutes.

NOTE

You may press **CANCEL** at any time when setting the control or during the cooking process.

Convection Roast

Convection roast combines a cook cycle with the convection fan and element to rapidly roast meats and poultry. Heated air circulates around the meat from all sides, sealing in juices and flavors. Meats cooked with this feature are crispy brown on the outside while staying moist on the inside. In addition, there is no need to reduce the oven temperature when using convection roast.

Convection roast may be set with the following options:

- Cook time or cook time with delay start



The following temperature settings apply to convection roast:

- Factory auto-start default: **350°F / 177°C**
- Minimum: **170°F / 77°C**
- Maximum: **550°F / 288°C**

Benefits of convection roast:

- Superior multiple oven rack performance.
- Some foods cook up 25 to 30% faster, saving time and energy.
- No special pans or bakeware required.

See example below to set convection roast to start immediately with the auto-suggest (default) setting:

Example	
Step	Press
1. Press CONV ROAST	
If needed, use numeric keypads to enter a different oven temperature.	
2. Press START	

Once START is pressed the oven will begin heating.

NOTE

You may press **CANCEL** at any time when setting the control or during the cooking process.



For best results

- Preheating is not necessary for most meats and poultry.
- Be sure to carefully follow your recipe's temperature and time recommendations or refer to the convection roast chart for additional information.
- Do not cover foods when dry roasting - this will prevent the meat from browning properly.
- Since Conv Roast cooks food faster, reduce the cook time by 25% from the recommended cook time of your recipe (check the food at this time). If necessary, increase cook time until the desired doneness is obtained.

Convection Roasting Chart					
Meat		Weight	Oven temp	Internal temp	Minute per lb.
Beef	Standing rib roast	4 to 6 lbs.	350°F	*	25-30
	Rib eye roast	4 to 6 lbs.	350°F	*	25-30
	Tenderloin roast	2 to 3 lbs.	400°F	*	15-25
Poultry	Turkey, whole**	12 to 16 lbs.	325°F	180°F	8-10
	Turkey, whole**	16 to 20 lbs.	325°F	180°F	10-15
	Turkey, whole**	20 to 24 lbs.	325°F	180°F	12-16
	Chicken	3 to 4 lbs.	350°F - 375°F	180°F	12-16
Pork	Ham roast, fresh	4 to 6 lbs.	325°F	160°F	30-40
	Shoulder blade roast	4 to 6 lbs.	325°F	160°F	20-30
	Loin	3 to 4 lbs.	325°F	160°F	20-25
	Pre-cooked ham	5 to 7 lbs.	325°F	160°F	30-40

* For beef: med rare 145°F, med 160°F, well done 170°F

** Stuffed turkey requires additional roasting time. Shield legs and breast with foil to prevent overbrowning and drying of the skin.

24 Setting Oven Controls

Broil

Use the **broil** feature to cook meats that require direct exposure to radiant heat for optimum browning results.

The following temperature settings apply to the broil feature:

- Auto-suggest (default) setting: **550°F / 288°C**
- Min. broil setting: **400°F / 204°C**
- Max. broil setting: **550°F / 288°C**

WARNING

Should an oven fire occur, close the oven door. If the fire continues, throw baking soda on the fire or use a fire extinguisher. **Do not** put water or flour on the fire. Flour may be explosive and water can cause a grease fire to spread and cause personal injury.



CAUTION

- **Do not** use the broiler pan without the insert.
- **Do not** cover the broil pan/insert with aluminum foil; the exposed grease could ignite.
- To prevent food from contacting the broil element and to prevent grease splattering, **do not** use the roasting rack when broiling.

For best results

- Use the recommended pans and oven rack positions for the type of meat being prepared.
- For optimum browning results, allow the oven to preheat **5-6 minutes** before placing the food in the oven.

See example below to set broil starting immediately with the auto-suggest (default) setting:

Example	
Step	Press
1. Place the broiler insert on the broiler pan (if equipped), then place the meat on the insert. Remember to follow all warnings and cautions.	
2. Arrange the interior oven rack to rack position recommendations. Be sure to place the prepared food and pan directly under broil element. Close the oven door.	
3. Press BROIL	
If needed, use numeric keypads to enter a different oven temperature.	
4. Press START	

NOTE

You may press **CANCEL** at any time when setting the control or during the cooking process.

IMPORTANT

The door must be closed for this function to operate. If the door is left open for 30 seconds, the display will show “**d-O**”. Simply close the door for the function to resume.

Broil

The broil pan insert (if equipped) contains slots that allows grease from the meat to drain into the broil pan. Place prepared meat on broil pan insert and then place onto broiler pan as shown -Fig. 1-.

Recommended broiling times

Use the broiling table -Fig. 3- for approximate recommended broiling times for the types of meats listed. Increase or decrease broiling times, or move the broiling pan to a different rack position to suit for doneness.

If the food you are broiling is not listed in the table, follow the instructions provided in your recipe and watch the item closely.

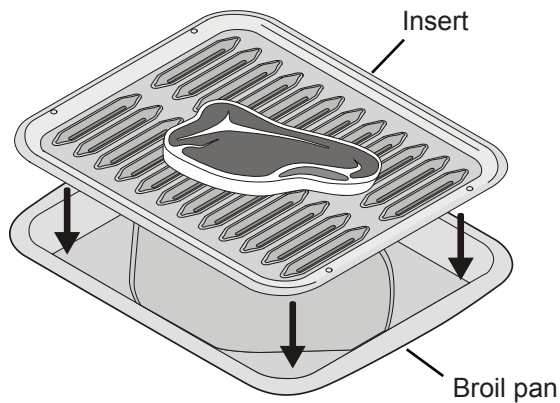
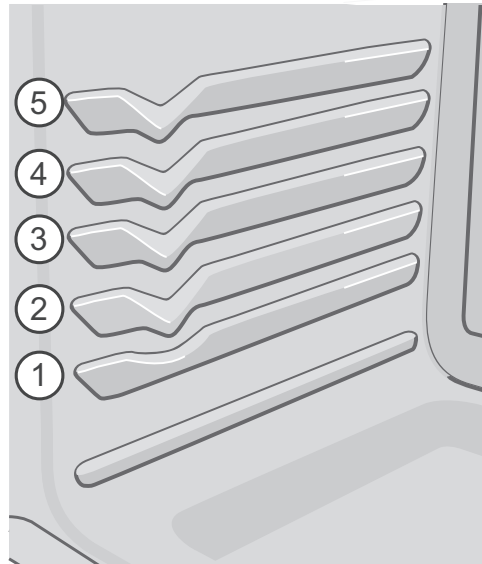

Fig. 1



Rack positions

Fig. 2

Broiling Table					
Food	Rack position	Temp	Cook time in minutes		Doneness
			1st side	2nd side	
Steak 1" thick	3rd or 4th	550°F	6	4	Rare
	3rd or 4th	550°F	7	5	Medium
	3rd or 4th	550°F	8	7	Well
Pork chops 3/4" thick	3rd or 4th	550°F	8	6	Well
Chicken-bone in	3rd	450°F	20	10	Well
Chicken-boneless	3rd or 4th	450°F	8	6	Well
Fish	3rd	500°F	13	0	Well
Shrimp	3rd	550°F	5	0	Well
Hamburger 1" thick	3rd or 4th	550°F	9	7	Medium
	3rd or 4th	550°F	10	8	Well

Fig. 3

Keep Warm



The Keep Warm feature will keep oven baked foods warm for serving up to 3 hours after cooking has finished. After 3 hours the Keep Warm feature will shut-off automatically. The Keep Warm should only be used with foods that are already at serving temperature. The Keep Warm feature will maintain an oven temperature of 170°F (77°C).

The Keep Warm feature may be used without any other cooking operations or may be used after cooking has finished using Cook Time or Cook Time with Delay Start.

See example below to set Keep Warm for the oven to start immediately.

Example	
Step	Press
1. Press KEEP WARM	keep warm
2. Press START	

See example below to set Keep Warm to start after a Cook Time or Delay Start.

Example	
Step	Press
1. Press BAKE or any other cooking function. If needed, enter a different temperature.	
2. Press COOK TIME	cook time
3. Enter time. If needed, set a DELAY START feature.	
4. Press KEEP WARM	keep warm
5. Press START	

WARNING

FOOD POISONING HAZARD. Do not let food sit for more than one hour before or after cooking. Doing so can result in food poisoning or sickness. Foods that can easily spoil such as milk, eggs, fish, meat or poultry, should be chilled in the refrigerator first. Even when chilled, they should not stand in the oven for more than 1 hour before cooking begins, and should be removed promptly when finished cooking.

Cakes Breads

The Cakes Breads functions are designed to give optimum baking performance for Cakes or Breads. These functions work well for baking cakes, brownies, pies (fresh or frozen), baked custards, cheesecakes, breads, rolls, biscuits, muffins and cornbread.

The Cakes function provides a preheat with a gentle cycling of heat giving cakes more volume and allowing delicate foods to cook more evenly.

The Breads function adds a special preheat feature to the bake cycle that thoroughly heats the oven from top to bottom to give more evenly browned foods.

See the example below to set Cakes or Breads.

Example	
Step	Press
1. Arrange oven racks when cool.	
2. For Cakes, press the CAKES BREADS keypad until CAKES appears in the oven display.	cakes & breads
For Breads, press the CAKES BREADS keypad until BREADS appears in the oven display.	cakes & breads
If needed, use numeric keypads to enter a different oven temperature.	
3. Press START	



For best results

- Dark or dull pans absorb more heat than shiny bakeware resulting in dark or overbrowning of foods. It may be necessary to reduce the oven temperature or cook time to prevent overbrowning of some foods. Dark pans are recommended for pies. Shiny pans are recommended for cakes, cookies or muffins.
- Breads will have better results baking on a single oven rack.
- When baking layer cakes or cookies using 2 oven racks, place cookware on rack in position 1 and 4. For best results when baking cakes or cookies using a single oven rack, place rack in position 2 or 3.

Probe

When cooking meat such as roasts, hams or poultry you can use the probe to check the internal temperature without any guesswork. For some foods, especially poultry and roasts, testing the internal temperature is the most effective way of insuring that your food has been properly cooked.

Your oven will automatically change from cooking to keep warm once the probe has reached the set temperature.

The following temperature settings apply to the probe function:

- Default: **170°F / 77°C**
- Minimum: **140°F / 60°C**
- Maximum: **210°F / 99°C**

Proper probe placement

- Always insert the probe so that the tip rests in the center of the thickest part of the meat. Do not allow the probe to touch bone, fat, gristle or the pan.
- For bone-in ham or lamb, insert the probe into the center of the lowest large muscle or joint. For dishes such as meat loaf or casseroles, insert the probe into the center of the food. To find the center of the food visually measure with the probe -Fig. 3-. When cooking fish, insert the probe just above the gill.
- For whole poultry or turkey, insert the probe into the thickest part of the inner thigh, below the leg -Fig. 1-.

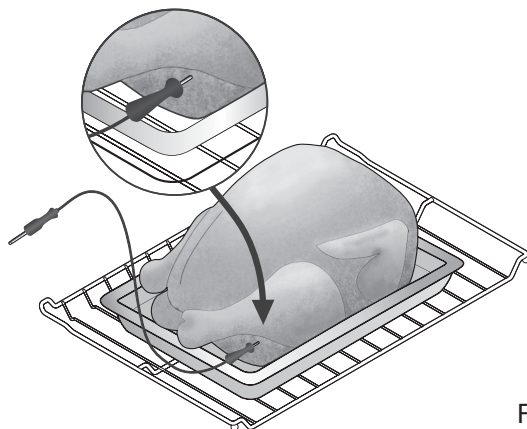

Fig. 1

→ IMPORTANT

- Use only the probe supplied with your appliance; any other may result in damage to the probe or the appliance.
- Be sure the probe is **fully** inserted into the probe receptacle. The probe will not work properly until correctly connected - Fig. 2.
- Handle the probe carefully when inserting and removing it from the food and the receptacle.
- Do not use tongs to pull the cable when inserting or removing it from the food or the receptacle.
- Defrost your food completely before inserting the probe to avoid damaging probe.
- **Never leave or store the probe inside the oven when not in use.**
- To prevent the possibility of burns, carefully unplug the probe using a pot holder.

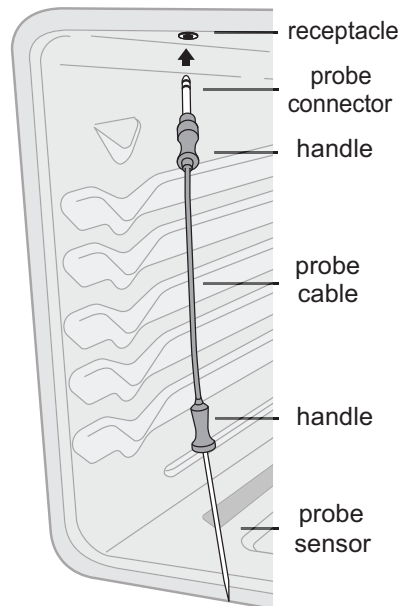

Fig. 2

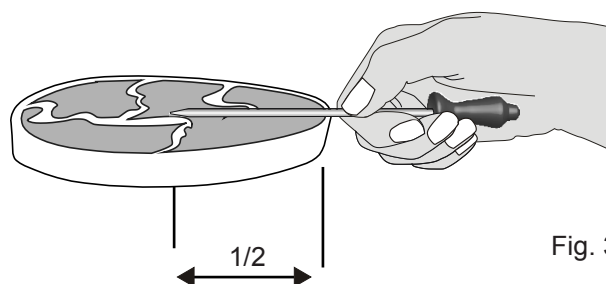

Fig. 3

Probe

See the example below to set the probe.

Example	
Step	Press
1. Prepare the food and properly insert the temperature probe into the food. DO NOT preheat or start cooking before properly inserting the meat probe. The probe should be inserted into the food and receptacle while the oven is still cool.	
2. Place the prepared food on the desired oven rack position and slide into the oven.	
3. Plug the meat probe into the probe receptacle located on the left front oven cavity top (See Fig. 2 on previous page for location of probe receptacle).	
4. The oven control detects if the meat probe is correctly plugged in to receptacle and when recognized will illuminate the probe icon in the oven control display.	
5. Set the oven control for Bake, Conv Bake or Conv Roast and the desired oven temperature. You may use the meat probe with some other baking features, but the meat probe cannot be set with Broil or Self Clean.	
6. To set the target temperature press PROBE keypad once then enter the desired target internal temperature using the numeric keypad (default setting is 170°F/77°C)†. Press START to accept the meat probe target temperature. Close the oven door.	
7. During the cooking process the actual meat probe temperature will display by default. To view the target temperature press the PROBE keypad once. After 25 seconds the display will show the actual meat probe temperature. If the target temperature needs to be changed during the cooking process, press the PROBE keypad once and use the numeric keypads to adjust the target temperature. Press the START key to accept any change.	
8. The oven control will provide 3 beeps when the internal target temperature is reached. By default the oven will automatically change to a Keep Warm setting. The Keep Warm function will maintain the oven temperature at 170°F (77°C). Instructions for changing how the oven reacts after reaching the internal target temperature may be found later in this section. Press CANCEL to cancel cooking at any time.	

→ IMPORTANT

Changing how the oven reacts after reaching the target temperature must be done before starting the cooking process.

See the following instructions for changing how the oven reacts after reaching the internal target temperature.

To set the oven to continue cooking after reaching the probe target temperature:

1. Press **PROBE** keypad and hold for 3 seconds.
2. Press **SELF CLEAN** keypad and toggle until the “Continu” message appears (Fig. 1) then press **START** to accept.

To set the oven to cancel cooking and automatically start Keep Warm after reaching the probe target temperature:

1. Press **PROBE** keypad and hold for 3 seconds.
2. Press **SELF CLEAN** keypad and toggle until the “CAnCEL” message appears (Fig. 2) then press **START** to accept.



Fig. 1



Fig. 2

† The U.S. Department of Agriculture states, “Rare fresh beef is popular, but you should know that cooking it to only 140°F/60°C means some food poisoning organisms may survive.” (Source: Safe Food Book, Your Kitchen Guide, USDA Rev. June 1958.)

The lowest temperature recommended by the USDA is 145°F/63°C for medium rare fresh beef.

Slow Cook

The slow cook feature may be used to cook foods more slowly at lower oven temperatures. The cooking results will be like that of a Slow Cooker or Crock-Pot. This feature is ideal for roasting beef, pork & poultry. Slow cooking meats may result in the exterior of meats becoming dark but not burnt; this is normal.

Slow cook may be set with the following options:

- Cook time
- Cook time with delay start



For Slow Cook two settings are available, high (**Hi**) or low (**Lo**). The high setting is best for cooking foods from a 4 to 5 hour time period. The low setting is best for cooking foods from a 8 to 9 hour time period.



For best results

- Completely thaw all frozen foods before cooking.
- Position multiple racks to accommodate size of cooking utensils when cooking multiple food item.
- Add any cream or cheese sauces during the last hour of cooking.
- Do not open the oven door often or leave the door open when checking foods. The more heat that is lost, the longer the food will need to cook.
- Cover the foods to keep them moist or use a loose or vented type cover to allow foods to turn crisp or brown.
- Roasts may be left uncovered so browning can occur. Cook times will vary depending on the weight, fat content, bone & the shape of the roast.
- Preheating the oven will not be necessary.
- Use the recipe's recommended food temperature and a food thermometer to determine when the food is done.

See the example below to set a slow cook.

Example	
Step	Press
1. Press SLOW COOK to choose the Hi option -Fig. 1-	slow cook
2. Press SLOW COOK again to choose the Lo option -Fig. 2-	slow cook
3. Press START	
	
Fig.1	Fig. 2

NOTE



You may press **CANCEL** at any time when setting the control or during the cooking process.

30 Setting Oven Controls

My Favorite

The My Favorite feature may be used to record and recall your favorite recipe settings. This feature may store 1 setting for each of the basic cooking pads. The keypads that a recipe may be stored with are Bake, Conv Bake, Conv Roast, Cakes Breads, Preheat, Broil and Slow Cook. This feature will also store and recall Cook Time or Keep Warm added settings.

See example below to store a typical cookie recipe (example for baking at 375°F for 7 minutes and to shut-off automatically).

Example	
Step	Press
Preheat* the oven to the desired temperature.	
1. Press BAKE	
2. Enter 375°F	375
3. Press COOK TIME	cook time
4. Enter the desired baking time. Press 7 .	7
5. Press and hold START until acceptance tone sounds (about 3 seconds).	



NOTE

Pressing the **START** pad after entering cooking temperatures and times will start the oven. If you wish to store the recipes but not start the oven press **CANCEL** after pressing the **START** pad.

* The **COOK TIME** you enter does NOT include additional time required to Preheat the oven. The oven will begin to count down the cooking time as soon as the feature is activated.

This recipe is now stored with the Bake key pad.

See example below to recall a previously stored recipe under BAKE pad.

Example	
Step	Press
1. Press BAKE . The stored recipe is recalled.	
2. Press START	

NOTE

- Once a recipe has been stored with a keypad, the recipe information will be recalled when pressing the corresponding keypad in the future.
- If a recalled recipe includes Cook Time, the oven will automatically shut-off when the Cook Time is finished.
- To erase all recipes stored, see section for Restoring factory default settings.
- To overwrite a recipe, simply store a new recipe. Cook Time can be cleared by selecting a cook time of 0 minute.

Sabbath mode

This appliance provides special settings for use when observing the Jewish Sabbath/Holidays. This mode will turn off all audible tones or visual display changes normally provided by the oven control. **BAKE** is the only cooking features available while in the Sabbath mode.

You must first set the **BAKE** feature and the temperature needed, the **COOK TIME** option if needed before setting the Sabbath mode. Any settings made prior to setting the Sabbath mode will be visible in the displays.

The Sabbath mode will override the factory preset 12 Hour Energy Saving mode and the appliance will stay on until the cooking features are cancelled.

If the oven interior lights are needed, be sure to activate them prior to setting the Sabbath mode. Once the oven light is turned ON and the Sabbath mode is active, the oven light will remain on until the Sabbath mode is turned off and the oven lights are turned off. The oven door will not activate the oven interior lights when the oven door is opened or closed.

Should a power failure or interruption occur during the Sabbath/Holidays, the appliance will shut OFF. When power is restored the appliance will not turn back on automatically to the original BAKE feature settings. **SF** will appear in all the control display panels indicating a Sabbath mode failure. After a power failure, the food may be safely removed from the oven while still in the Sabbath mode.



For further assistance, guidelines for proper usage and a complete list of models with the Sabbath feature, please visit the web at <http://www.star-k.org>.

NOTE

- The only keys available once the appliance is set for the Sabbath mode are BAKE, START, STOP and the numeric pads.
- You may change the oven temperature once baking has started (Jewish holidays only). Press BAKE, enter the oven temperature using the numeric keys and press START twice. Remember that the oven control will no longer beep or display any further changes once the oven is set in the Sabbath mode.

The example below shows setting the oven to observe the Sabbath (and Jewish holidays).

Example	
Step	Press
1. Press BAKE	
2. Press START	
3. To enter Sabbath mode, press and hold simultaneously both the COOK TIME and DELAY START keys together for 3 seconds (a beep will sound) and release.	cook time delay start 3 sec

Be sure to make any additional oven setting changes (Oven Light, Cook Time and/or Delay Start, Keep Warm) before going to step 3.

Once properly set in Sabbath mode, SAb will show in the oven display until the Sabbath mode is cancelled.

NOTE

You may press **CANCEL** at any time when setting the control or during the cooking process.

Cancelling Sabbath mode

The example below shows how to cancel the Sabbath mode.

Example	
Step	Press
1. Press and hold simultaneously both the COOK TIME and DELAY START keys together for 3 seconds (a beep will sound) and release.	cook time delay start 3 sec
2. All cooking features previously set will automatically cancel once Sabbath mode has ended.	

Warmer Drawer

The purpose of the warmer drawer is to keep hot cooked foods at serving temperatures. Examples are vegetables, gravies, meats, casseroles, biscuits, rolls and pastries. It is not recommended to heat cold food in the warmer drawer; always start with hot food.

The warmer drawer may also be used to warm dinner plates. All food items placed in the warmer drawer should be covered with a lid or aluminum foil to maintain quality.

CAUTION

Always use potholders or oven mitts when removing food from the warmer drawer as cookware and plates will be hot and you can be burned.

WARNING

- **FOOD POISONING HAZARD.** Do not let food sit for more than one hour before or after cooking. Doing so can result in food poisoning or sickness. Foods that can easily spoil such as milk, eggs, fish, meat or poultry, should be chilled in the refrigerator first. Even when chilled, they should not stand in the oven for more than 1 hour before cooking begins, and should be removed promptly when finished cooking.
- **Storage in or on appliance—flammable materials should not be stored in an oven, warmer drawer, near surface units.** This includes paper, plastic and cloth items, such as cookbooks, plasticware and towels, as well as flammable liquids. Do not store explosives, such as aerosol cans, on or near the range.
- **DO NOT LEAVE CHILDREN ALONE** — Children should not be left alone or unattended in the area where appliance is in use. They should never be allowed to sit or stand on any part of the appliance, including the warmer drawer.

Arranging warmer drawer rack positions

The keep warmer drawer rack may be used in 2 ways:

- In the upright position (See Fig. 1) to allow low profile food items to be placed both under and on top of the rack (for example, rolls or biscuits on top of the rack and a casserole dish underneath).
- In the downward position (See Fig. 2) to allow for light weight food items and empty cookware (for example, rolls or pastries and dinner plates) on the rack.

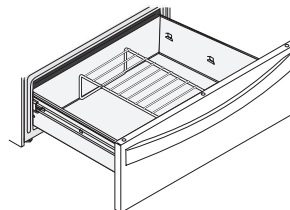

Fig. 1

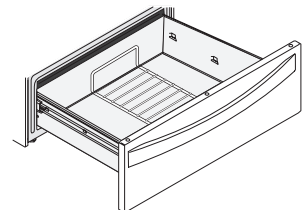

Fig. 2

Warmer Drawer Controls

The warmer drawer control knob is located on the control panel (see Fig. 3). Use the warmer drawer control knob to turn the warmer drawer ON and OFF and make temperature adjustments. Three available heat settings are provided from low to high (See Fig. 4).



Fig. 3

Warmer drawer indicator light

The warmer drawer indicator light is located above the warmer drawer control knob. It glows when the warmer drawer is turned ON, and remains on until the warmer drawer is turned OFF.

Warmer Drawer (con't)

To Operate the Warmer Drawer:

1. Arrange the warmer drawer rack (if needed) in warmer drawer and place the cooked food or dishes in the warmer drawer. Close warmer drawer.
2. Push in and turn the surface control knob in either direction to the desired setting. Turn the knob to adjust the setting if desired.
3. Once warming is finished, turn the surface control knob to OFF before removing the items.

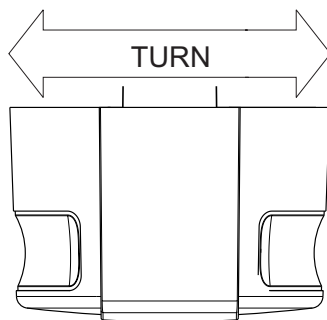

Fig. 4

→ IMPORTANT

Do not use the warmer drawer while a self-cleaning cycle is operating. The temperature in the drawer will be higher than what was set.

Warmer Drawer Settings

The recommended warmer drawer food settings are shown in Fig. 5. The settings provided are meant to be used as a recommendation only. If a particular food item is not listed, start with a medium setting. If more crispness is desired, remove the lid or aluminum foil from the food.

Most foods may be maintained at serving temperatures using a medium heat setting. When a combination of foods are to be kept warm (for example, a meat with 2 vegetables and rolls) use a high setting.

Warmer drawer recommended food settings

Food	Item Setting
Bacon	Hi
Hamburger patties	Hi
Poultry	Hi
Pork chops	Hi
Fried foods	Hi
Pizza	Hi
Gravies	Med
Casseroles	Med
Eggs	Med
Roasts (beef, pork or lamb)	Med
Vegetables	Med
Biscuits	Med
Rolls (hard)	Med
Pastries	Med
Rolls (soft)	Lo
Empty dinner plates	Lo



Fig. 5

→ IMPORTANT

- Do not use plastic wrap to cover food. Plastic may melt on the warmer drawer and be very difficult to clean up. Only use utensils and cookware recommended by the manufacturer for use in the warmer drawer.
- Always start with hot food when using the warmer drawer. DO NOT heat cold food in the warmer drawer.
- To minimize heat loss, avoid opening warmer drawer frequently while in use.

Setting clock



See the example below to set the clock to 1:30.

Example	
Step	Press
1. Press SET CLOCK .	
2. Enter 1:30 to advance to 1:30.	130
3. Press START to accept or press CANCEL to reject.	

Setting 12 or 24 hour mode

The clock display mode allows you to choose between 12 and 24 hour mode. The factory preset clock display mode is 12 hour.



See the example below to change the default mode to 24 hour.

Example	
Step	Press
1. Press and hold SET CLOCK for 3 seconds until "12Hr dAy" or "24Hr dAy" appear in the display.	 3 sec
2. Press SELF CLEAN to switch between the 12 and 24 hour mode.	self clean
3. Press START to accept or press CANCEL to reject.	

Changing between °F or °C

Your control has the ability to display and set Fahrenheit or Celsius temperatures. The factory preset temperature display is Fahrenheit.

See the example below to change the default temperature display to Celsius.



Example	
Step	Press
1. Press and hold BROIL for 3 seconds until F or C appear in the display.	 3 sec
2. Press SELF CLEAN to switch between the F and C mode.	self clean
3. Press START to accept or press CANCEL to reject.	

Adjusting oven temperature User preference offset

Your appliance has been factory calibrated and tested to ensure an accurate baking temperature. For the first few uses, follow your recipe times and temperature recommendations carefully.

If you feel your oven is too hot or too cool from your baking experience, the oven temperature may be adjusted to your liking. The temperature may be increased up to +35°F (+19°C) or decreased down to -35°F (-19°C) from normal.

See the example below to increase the temperature.

Example	
Step	Press
1. Press and hold BAKE for 3 seconds until UPO appear in the display.	 3 sec
2. Enter the desired temperature change using the number pads. SELF CLEAN can be pressed to lower the temperature.	
3. Press START to accept or press CANCEL to reject.	

Setting 12hr energy saving mode

The oven control has a factory preset built-in 12 hour energy saving feature that will shut off the appliance if the oven has been heating for more than 11 hours and 59 minutes. The oven can be programmed to override this feature for continuous baking.

See the example below to turn off 12 hour energy saving mode.

Example	
Step	Press
1. Press and hold TIMER for 3 seconds until "12Hr OFF" or "StAy On" appear in the display.	timer on-off
2. Press SELF CLEAN to switch between the "12Hr OFF" or "StAy On" mode.	self clean
3. Press START to accept or press CANCEL to reject.	

Setting audio mode

The audio mode allows you to control the audio for the oven control. You may turn the audio off and later return to operating with all the normal audible sounds and alerts.

See the example below when changing the audible settings.

Example	
Step	Press
1. Press and hold DELAY START for 3 seconds until BEEP appears in the display.	delay start
2. Press SELF CLEAN to switch between the On and Off mode.	self clean
3. Press START to accept or press CANCEL to reject.	

Factory default reset

You may choose to restore your factory settings. **This will erase all settings or favorites that you have saved.**

See the example below reset your control.

Example	
Step	Press
1. Press and hold the 7 numeric keypad until acceptance tone sounds (about 3 seconds).	7
2. Press START . The control will reset all user preference settings back to factory default settings.	

Before starting self-clean

A self-cleaning oven automatically cleans with high temperatures that are well above those used for normal cooking. The self-clean feature eliminates soils completely or reduces them to a fine powdered ash that you can later easily wipe away with a damp cloth.

Adhere to the following precautions when running the self-clean cycle:

- Allow the oven to cool before cleaning.
- Wear rubber gloves when cleaning any exterior parts of the oven manually.
- **Do not** use oven cleaners or protective coatings in or around the oven interior.
- **Do not** clean the oven door gasket. The woven material of the oven door gasket is essential for a good seal. Care should be taken not to rub, damage or remove the gasket. -Fig. 1-
- **Do not** use any cleaning materials on the door gasket. Leaving chemical residue can damage the door gasket.
- **DO NOT** force the oven door open. The automatic door locking system can be damaged.
- **Remove** the broiler pan, insert, all utensils and any **aluminum foil**. These items cannot withstand high cleaning temperatures.
- All oven racks and supports **MUST** be removed.
- **Remove any excessive spillovers** in the oven cavity **before** starting a self-clean cycle. To clean, use hot, soapy water and a cloth. Large spillovers can cause heavy smoke or fire when subjected to high temperatures.
- Clean any soil from the oven frame, the door liner outside the oven door gasket and the small area at the front center of the oven bottom with soap and water. These areas heat sufficiently to burn soil on.
- **Do not** allow food spills with a high sugar or acid content (such as milk, tomatoes, sauerkraut, fruit juices or pie filling) to remain on the porcelain surface, they may leave a dull spot even after cleaning.

⚠ WARNING

During the self-clean cycle, the outside of the appliance can become very hot to the touch. **DO NOT** leave small children unattended near the appliance.

⚠ CAUTION

- **DO NOT** line the oven walls, oven racks, bottom or any other part of the range with aluminum foil. Doing so will stop heat distribution, produce poor baking results and cause permanent damage to the oven interior (aluminum foil will melt to the interior surface of the oven).
- Use caution when opening the door after the self-clean cycle is finished. The oven may still be **VERY HOT**.
- The health of some birds is extremely sensitive to the fumes given off during the self-cleaning cycle of any range. Move birds to another well-ventilated room.

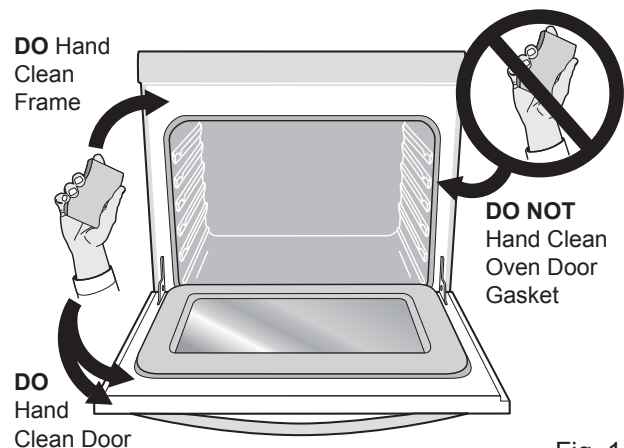

Fig. 1

What to Expect during Cleaning

While the oven is in operation, the oven heats to temperatures much higher than those used in normal cooking. Sounds of metal expansion and contraction are normal. Odor is also normal as the food soil is being removed. Smoke may appear through the oven vent.

If heavy spillovers are not wiped up before cleaning, they may flame and cause more smoke and odor than usual. This is normal and safe and should not cause alarm. If available, use an exhaust fan during the self-cleaning cycle.

Setting self-clean

The **SELF CLEAN** pad controls the Self-Cleaning feature. When used with a the Delay Start pad, a delayed Self-Cleaning cycle may also be programmed. The Self Clean feature allows for any Self-Cleaning cycle time from 2 (2:00) to 4 hours (4:00). You may also choose the clean time in 1 minute increments (for example 2 hours and 50 minutes) by pressing the corresponding number keypads.

If you are planning to use the oven directly after a self-clean cycle remember to allow time for the oven to cool down and the oven door to unlock. This normally takes about one hour. So a 3 hour self-clean cycle will actually take about 4 hours to complete.

*It is recommend to use a 2 hour self-clean cycle for light soils, a 3 hour cycle for average soils, and a 4 hour cycle for heavy soils (to assure satisfactory results).

NOTE

The kitchen area should be well ventilated using an open window, ventilation fan or exhaust hood during the Self-Clean cycle. This will help eliminate the normal odors associated with the Self-Clean cycle.

CAUTION

- To avoid possible burns use care when opening the oven door after the Self-Cleaning cycle. Stand to the side of the oven when opening the door to allow hot air or steam to escape.
- **DO NOT** force the oven door open. This can damage the automatic door locking system. Use caution and avoid possible burns when opening the door after the Self-Cleaning cycle has completed. The oven may still be **VERY HOT**.

When the Self-Clean Cycle is Completed

Once the oven has cooled down for approximately 1 HOUR, and the "DOOR LOCKED" icon is no longer displayed, the oven door can then be opened.

NOTE

You may press **CANCEL** any time during the cleaning process. After cancelling the self-clean cycle, do not attempt to open the oven door until the DOOR lock icon turns off.

See example below to start an immediate Self-Cleaning cycle or to set a Delay Start time of 8:00 o'clock and shut-off automatically (example provided is a default 3 hour Self-Clean cycle)

Example	
Step	Press
1. Be sure the clock is set with the correct time of day, the oven is EMPTY and the oven door is closed.	
2. Press SELF CLEAN	self clean
The control will automatically clean for a 3 hour period (default self-cleaning cycle time). Note: If a 2 or 4 hour clean time is desired, press 2 0 0 for 2 hour or press 4 0 0 for a 4 hour clean time. Set the cleaning time based on the amount of soil: light, medium or heavy (*See above).	
Note: If the optional delay Self-Clean feature is needed, finish steps 3-4.	
3. Press DELAY START	delay start
4. Enter the desired Self-Clean starting time using the number pads 8 0 0.	800
5. Press START	

NOTE

Allow about 15 seconds for the oven door lock to close.

As soon as the control is set, the motor driven oven door lock will begin to close automatically. Once the door has been locked the "DOOR LOCKED" indicator light will stop flashing and remain on.

The control will calculate forward from the set start time to determine when the Self-Cleaning cycle should end. The Self-Cleaning cycle will turn on automatically at the set time.

IMPORTANT

- If a self-clean cycle was started but did not finish due to a power failure, your oven may not be completely cleaned. After power has been restored and the oven door has unlocked, set for another self-clean if needed.
- The oven will need to cool down before starting another self-clean cycle. The oven controls will force a delay of 4 hours between cycles.

Cleaning Recommendations

Surface Type	Cleaning Recommendation
<ul style="list-style-type: none"> • Aluminum (trim pieces) & vinyl (some models) 	Use hot, soapy water and a cloth. Dry with a clean cloth.
<ul style="list-style-type: none"> • Painted and plastic control knobs • Body parts • Painted decorative trim 	<p><i>For general cleaning</i>, use hot, soapy water and a cloth. <i>For more difficult soils and built-up grease</i>, apply a liquid detergent directly onto the soil. Leave on soil for 30 to 60 minutes. Rinse with a damp cloth and dry. Do not use abrasive cleaners on any of these materials; they can scratch. To remove control knobs, turn to the OFF position; grasp firmly and pull straight off the shaft. To replace knobs after cleaning, line up the flat sides of both the knob and the shaft; then push the knob into place.</p>
<ul style="list-style-type: none"> • Control panel (some models) • Decorative trim (some models) • Stainless steel (some models) 	<p><i>Before cleaning the control panel</i>, turn all controls to OFF and remove the control knobs. To remove, pull each knob straight off the shaft. Clean using hot, soapy water and a dishcloth. Rinse with a clean water using a dishcloth. Be sure to squeeze excess water from the cloth before wiping the panel; especially when wiping around the controls. Excess water in or around the controls may cause damage to the appliance. To replace knobs after cleaning, line up the flat sides of both the knob and the shaft; then push the knob into place.</p> <p>Stainless Steel (some models). Clean the stainless with warm soapy water using a clean sponge or cloth. Rinse with clean water and dry with a soft clean cloth. Do not use harsh scrubbing cleaners. Only use kitchen cleaners that are especially made for cleaning Stainless Steel. Always be sure to rinse the cleaners from the surface as bluish stains may occur during heating that cannot be removed.</p>
<ul style="list-style-type: none"> • Porcelain enamel broiler pan and insert (if equipped) • Door liner & body parts 	Gentle scouring with a soapy scouring pad will remove most spots. Rinse with a 1:1 solution of clear water and ammonia. <i>If necessary</i> , cover difficult spots with an ammonia-soaked paper towel for 30 to 40 minutes. Rinse with clean water and a damp cloth, and then scrub with a soap-filled scouring pad. Rinse and wipe dry with a clean cloth. Remove all cleaners or the porcelain may become damaged during future heating. Do not use spray oven cleaners on the cooktop.
<ul style="list-style-type: none"> • Oven racks 	Oven racks must be removed. Clean by using a mild, abrasive cleaner following manufacturer's instructions. Rinse with clean water and dry.
<ul style="list-style-type: none"> • Oven door 	<p>Use soap & water to thoroughly clean the top, sides and front of the oven door. Rinse well. You may use a glass cleaner on the outside glass of the oven door. Do not immerse the door in water. Do not spray or allow water or the glass cleaner to enter the door vents. Do not use oven cleaners, cleaning powders or any harsh abrasive cleaning materials on the outside of the oven door.</p> <p>Do not clean the oven door gasket. The oven door gasket is made of a woven material, on Self-Cleaning models, which is essential for a good seal. Care should be taken not to rub, damage or remove this gasket.</p>

Special door care instructions

→ IMPORTANT

Most oven doors contain glass that can break.
Read the following recommendations:

- **Do not** close the oven door until all the interior oven racks are fully inserted and retracted to the back of the oven.
- Do not hit the glass with pots, pans, or any other object. The oven door glass may break or even break at a later time unexpectedly.
- Scratching, hitting, jarring or stressing the oven door glass may weaken its structure causing an increased risk of breakage at a later time.
- You may use a glass cleaner on the outside of the oven door glass. **Do not spray** or allow water or the cleaner to enter or drip down into the oven door vents. Spray cleaner on cloth first and then wipe the oven door clean.
- **Do not** use strong oven cleaners, powders or any harsh abrasive cleaning materials on the outside of the oven door or glass.
- **Never clean** the oven door gasket. The oven door gasket should always clean during the Self-clean cycle.

Changing oven lights

⚠ CAUTION

Be sure the range is unplugged and all parts are COOL before replacing oven light. Wear a leather-faced glove for protection against possible broken glass or burns.

The oven lights will automatically turn ON when the oven door is opened. The oven lights may also be manually operated by pressing the  pad.

The oven light bulb is covered with a glass shield. The glass shield can be removed to be cleaned manually or to change oven light. **THIS GLASS SHIELD MUST BE IN PLACE WHENEVER THE OVEN IS IN USE.**

To replace the light bulb:

Replacing the Round Halogen Oven Light:

1. Turn the power off at the main source or unplug the appliance.
2. The bulb is covered with a glass shield screwed in place (fig. 1). Replace bulb with 25-watt halogen appliance bulb only (fig. 2). **Please note: do not allow your fingers to touch the new bulb when replacing. This will shorten the life of the new bulb. Use a paper towel to cover the new bulb when installing.**
3. Replace the glass shield (fig.1). **The glass shield must be in place whenever the oven is in use.**
4. Turn power back on again at the main source (or plug the appliance back in).
5. The clock will then need to be reset.

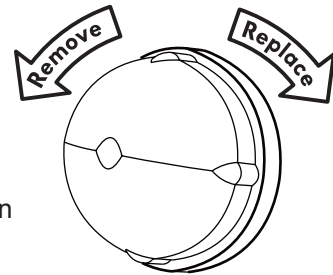

Figure 1 - Glass shield removal

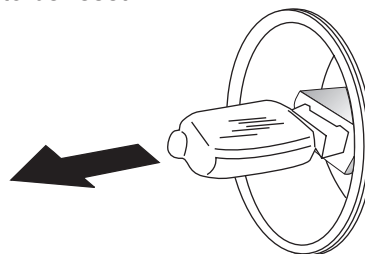

Figure 2 - Pull bulb out.

Removing and Replacing the Oven Door

CAUTION

The oven door is heavy. Be careful when removing and lifting the door. Do not lift the oven door by the handle.

IMPORTANT

Most oven doors contain glass that can break.

Read the following recommendations:

- Do not close the oven door until all the interior oven racks are fully inserted and retracted to the back of the oven.
- Do not hit the glass with pots, pans, or any other object. The oven door glass may break or even break at a later time unexpectedly.
- Scratching, hitting, jarring or stressing the oven door glass may weaken its structure causing an increased risk of breakage at a later time.
- You may use a glass cleaner on the outside of the oven door glass. Do not spray or allow water or the cleaner to enter or drip down into the oven door vents. Spray cleaner on cloth first and then wipe the oven door clean.
- Do not use strong oven cleaners, powders or any harsh abrasive cleaning materials on the outside of the oven door or glass.
- **Never clean** the oven door gasket. The oven door gasket should always clean during the Self-clean cycle.

To Remove Oven Door:

1. Open oven door completely (horizontal with floor - See Figure 1).
2. Pull the door hinge locks on both left and right door hinges down from the oven frame completely towards the oven door (See Figure 2). A tool such as a small flat-blade screwdriver may be required.
3. Firmly grasp both sides of oven door along the door sides (Do not use the oven door handle - See Figure 3).
4. Close the door to the broil stop position (the oven door will stop into this position just before fully closing).
5. With the oven door in the broil stop position, lift the oven door hinge arms over the roller pins located on each side of the oven frame (See Figure 4).

To Replace Oven Door:

1. Firmly grasp both sides of oven door along the door sides (Do not use the oven door handle - See Figure 3).
2. Holding the oven door at the same angle as the removal position, seat the hook of the hinge arm onto the roller pins located on each side of the oven door frame (See Fig. 4). Also, seat the notch of the hinge arm onto the bottom of the slot at the same time you seat the hook. The hook and notch of the hinge arms must be fully seated onto the roller pins and bottom of the slot.
3. Fully open the oven door (horizontal with floor - See Figure 1).
4. Push the door hinge locks up towards and into the oven frame on both left and right oven door hinges (See Figure 2) to the locked position.
5. Close the oven door.

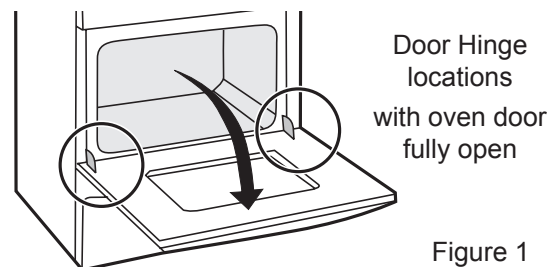

Figure 1

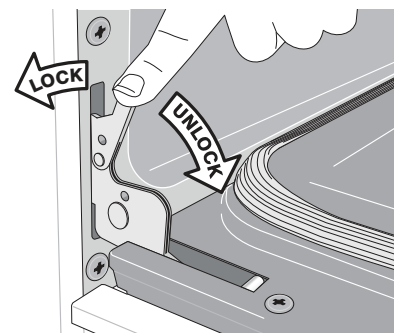

Figure 2

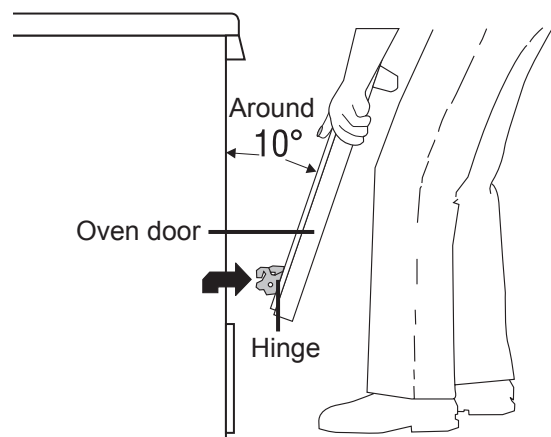

Figure 3

Removing and Replacing the Oven Door (con't)

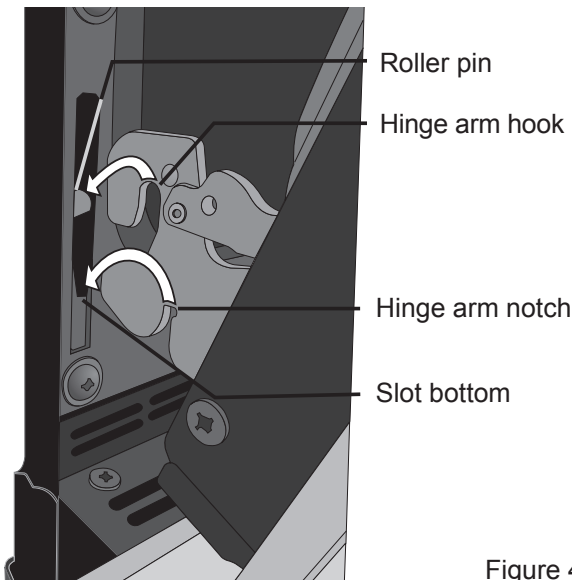

Figure 4

Cooktop cleaning and maintenance

Consistent and proper cleaning is essential to maintaining your ceramic glass cooktop

Prior to using your cooktop for the first time, apply the recommended Cleaning Creme to the ceramic surface. A sample of that cleaning creme is supplied with your cooktop and it is available in most hardware stores. Clean and buff with a paper towel. This will make cleaning easier when soiled from cooking. The special cooktop cleaning cream leaves a protective finish on the glass to help prevent scratches and abrasions.

Sliding aluminum or copper clad bottom pans on the cooktop can cause metal markings on the cooktop surface. These marks should be removed **immediately**

after the cooktop has cooled using the cooktop cleaning cream. Metal marks can become permanent if not removed prior to future use.

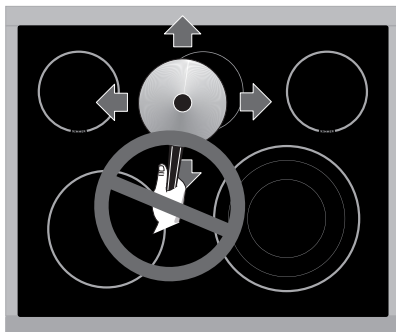

Cookware (cast iron, metal, ceramic or glass) with rough bottoms can mark or scratch the cooktop surface. **Do not slide anything metal or glass** across the cooktop. **Do not** use your cooktop as a cutting board or work surface in the kitchen. **Do not** cook foods directly on the cooktop surface without a pan. **Do not** drop heavy or hard objects on the glass cooktop, they may cause it to crack or break.

Cleaning recommendations for the ceramic glass cooktop

CAUTION

Before cleaning the cooktop, be sure the controls are turned to OFF and the cooktop is COOL.

WARNING

DO NOT use a cooktop cleaner on a hot cooktop. The fumes can be hazardous to your health, and can chemically damage the ceramic-glass surface.

For light to moderate soil:

Apply a few drops of CookTop® Cleaning Creme directly to the cooktop. Use a paper towel to clean the entire cooktop surface. Make sure the cooktop is cleaned thoroughly, leaving no residue. Do not use the towel you use to clean the cooktop for any other purpose.

For heavy, burned on soil:

First, clean the surface as described above. Then, if soils remain, carefully scrape soils with a metal razor blade scraper, holding scraper at a 30 degree angle to the surface. Remove loosened soils with cooktop cleaning cream and buff surface clean.

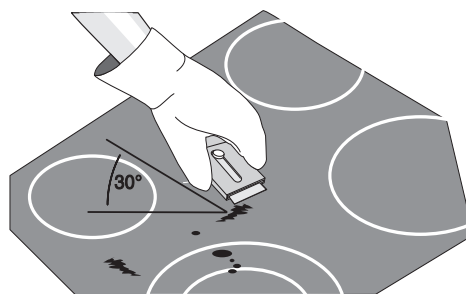

Cleaning recommendations for the ceramic glass cooktop (continued)

CAUTION

Damage to the ceramic glass cooktop may occur if you use scrub pad.

Plastic or foods with a high sugar content:

These types of soils must be removed immediately if spilled or melted onto the ceramic cooktop surface. Permanent damage (such as pitting of the cooktop surface) may occur if not removed **immediately**. After turning the surface elements OFF, use a razor blade scraper or a metal spatula with a mitt and scrape the soil from the hot surface (as illustrated on previous page). Allow the cooktop to cool, and use the same method for heavy or burned on soils.

Special Caution for Aluminum Foil and Aluminum Cooking Utensils

- **Aluminum foil** - Use of aluminum foil will damage the cooktop. Do not use thin aluminum cooking utensils or allow foil to touch the ceramic cooktop under ANY circumstances.
- **Aluminum utensils** - The melting point of aluminum is much lower than that of other metals. Care must be taken when aluminum pots or pans are used on the cooktop. If allowed to boil dry, not only will the utensil be destroyed, but it may fuse to, break or mark the ceramic glass surface, permanently damaging the cooktop surface.

Do not use the following on the ceramic glass cooktop:



- Do not use abrasive cleaners and scouring pads, such as metal and some nylon pads. They may scratch the cooktop, making it more difficult to clean.
- Do not use harsh cleaners, such as chlorine bleach, ammonia or oven cleaners, as they may etch or discolor the cooktop.
- Do not use dirty sponges, cloths or paper towels, as they can leave soil or lint on the cooktop which can burn and cause discoloration.

Glide Rack Care

CAUTION

Handle oven racks only when they are cool. After cooking or after the fresh-clean cycle, racks will be very hot and can cause burns

IMPORTANT

- Remove all oven racks before starting a fresh-clean cycle.
- Do not use cooking oil, cooking spray, or other oil-based lubrication products on the glide rack extension tracks. Use only the graphite lubrication in this area. To order graphite lubrication, contact your installer, servicer or dealer.
- It is important that the parts of the rack that contact the oven sides always have a light coating of vegetable oil. Apply a thin layer of vegetable oil to the sides of the rack after every fresh-clean cycle and when the rack becomes difficult to reposition in the oven.

To lubricate the glide rack:

1. Remove the rack from the oven and place the rack on a large flat surface covered with newspaper or scrap cloth. Fully extend the rack.
2. Wipe away debris and crumbs from the glide track using a cloth or sponge.

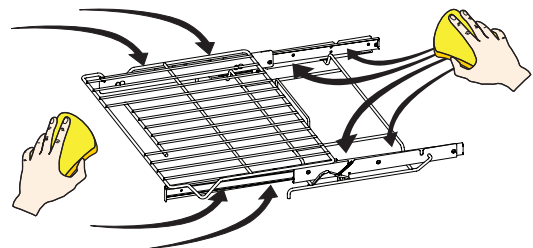

3. Shake graphite lubrication very well before applying. Apply to loading guides, and rotation pin. Repeat on both sides of the glide rack.

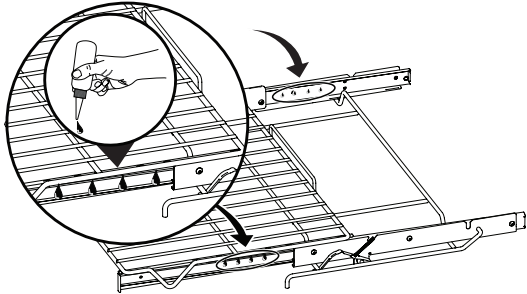

4. Extend and return the glide rack several times along the tracks to distribute the lubrication.

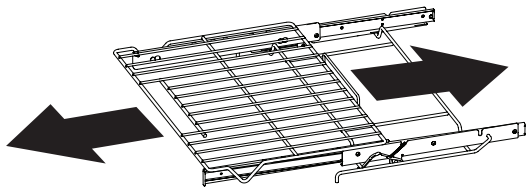

5. Turn the rack upside down and apply graphite lubrication to the insides of the loading guides.

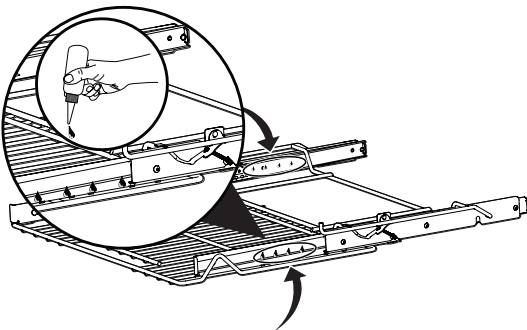

6. Extend and return the glide rack several times along the tracks to distribute the lubrication.
7. Apply a thin layer of cooking oil to the bottom of the "V" and the glide channels. Keeping the frame sides lightly lubricated allows the entire rack to slide easily when changing rack positions.

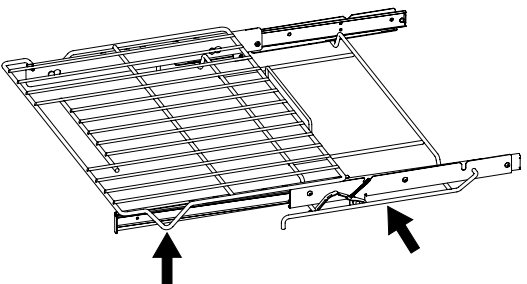

8. Replace rack in oven right-side up.

Removing and Replacing the Drawer

To Remove the Drawer:

1. Open the drawer to the fully opened position.
2. Locate glide lever on each side of drawer, pull up on the left glide lever and push down on the right glide lever (See Figure 1).
3. Pull the drawer away from the range.

To Replace the Drawer:

1. Pull the plastic slider to the front of the glide slots on each side of the drawer cavity (See Figure 2).
2. Align the glide on each side of the drawer with the drawer cavity glide slot.
3. Push the drawer into the drawer cavity until glide levers "click" (approximately 2"). If you do not hear the glide levers "click" or the drawer does not feel seated remove the drawer and repeat steps 1 thru 3.

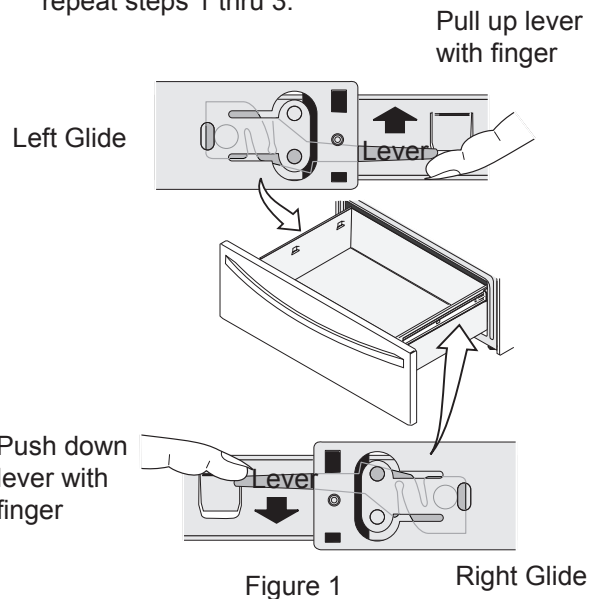

Figure 1

Right Glide

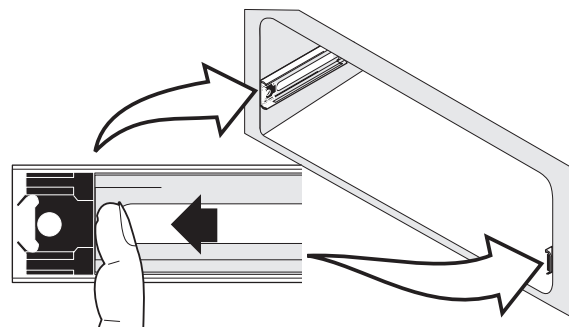

Figure 2

Before you call for service, review the following list. It may save you time & expense. The list includes common occurrences that are not the result of defective workmanship or materials in this appliance.

Before you call	
Problem	Solution
Oven control beeps and displays an F error code.	<ul style="list-style-type: none"> Electronic control has detected a fault condition. Push CANCEL pad to clear the display and stop the display from beeping. Reprogram the oven. If a fault reoccurs, record the fault number, push the CANCEL pad and contact an authorized servicer.
Installation	<ul style="list-style-type: none"> Place oven rack in center of oven. Place a level on the oven rack. Contact installing agent if rack and cabinet cutout flooring are not level. Kitchen cabinet misalignment may make range appear to be not level. Be sure cabinets are square and level. Contact cabinet maker to correct problem.
Entire range does not operate	<ul style="list-style-type: none"> When the range is first plugged in, or when the power supply to the oven has been interrupted, the display will flash. The range cannot be programmed until the clock is set. Be sure electrical cord is securely connected into the electrical junction box. Cord/plug is not installed and/or connected. Cord is not supplied with range. Contact your dealer, installing agent or authorized servicer. Service wiring not complete. Contact your dealer, installing agent or authorized servicer. Power outage. Check house lights to be sure. Call your local electric company. Short in cord/plug. Replace cord/plug. Controls are not set properly. See instructions to set the controls. House fuse has blown or circuit breaker has tripped immediately following installation. House fuse may not be fully engaged. Check fuse and screw or engage circuit breaker securely.
Oven light does not work	<ul style="list-style-type: none"> Burned-out or loose bulb. Follow the instructions under Oven Light to replace or tighten the bulb.
Self-cleaning cycle does not work	<ul style="list-style-type: none"> Make sure the oven door is closed. Make sure you have removed the oven racks and the oven rack supports from the oven. Controls not set properly. Follow instructions under "Setting Self-Clean".
Poor cooking results	<ul style="list-style-type: none"> Many factors affect baking results. See baking for hints, cause and corrections. See Adjusting Oven Temperature. Adjust the recipe's recommended power levels or cooking times. Cookware is too lightweight or warped. Use heavier quality cookware so foods being prepared may cook more evenly.
Fan noise when appliance is off	<ul style="list-style-type: none"> Some models are equipped with a cooling fan that runs during the cooking process to cool internal electronic components. It is normal for this fan to continue to run for an extended period of time, even when the oven is off.
Flames inside oven or smoking from oven vent	<ul style="list-style-type: none"> Excessive spillovers in oven. For example this will happen for pie spillovers or large amounts of grease left on the oven bottom. Wipe up excessive spillovers before starting oven. If flames or excessive smoke are present see "About broiling" in the Setting Oven Controls section.





Before you call

Problem	Solution
Oven smoke excessively during broiling	<ul style="list-style-type: none"> • Meat too close to the broiler element. Reposition the rack to provide more clearance between the meat and the broiler. Preheat broil element for quick searing operation. • Meat not properly prepared. Remove excess fat from meat. Cut remaining fatty edges to prevent curling, but do not cut into the lean. • Grid on broiler pan wrong side-up. Grease does not drain into broiler pan. Always place the grid on the broiler pan with the ribs up and the slots down to allow grease to drip into the pan. • Broiler pan used without grid or grid cover with aluminum foil. DO NOT use the broiler pan without the grid or cover the grid with aluminum foil. • Oven needs to be cleaned. Grease has built up on oven surfaces. Regular cleaning is necessary when broiling frequently. Grease or food spatters cause excessive smoking.
Soil not completely removed after self-cleaning cycle is completed	<ul style="list-style-type: none"> • Failure to clean bottom, from top of oven, frame of oven or door area outside oven seal. These areas are not in the self-cleaning area, but get hot enough to burn on residue. Clean these areas before the self-cleaning cycle is started. Burned on residue can be cleaned with a stiff nylon brush and water or a nylon scrubber. Be careful not to damage the oven gasket. • Excessive spillovers in oven. Set the self-clean cycle for longer cleaning time.
Surface element does not heat	<ul style="list-style-type: none"> • No power to appliance. Check/reset breaker or replace fuse. If the problem is a circuit overload, or improper connection of the armored cable supplied with the appliance, have this situation corrected by a qualified electrician. • Too low heat setting. Turn control to a slightly higher setting until element comes on. • Incorrect control is on. Be sure to use correct control for the element needed.
Surface element too hot or not hot enough	<ul style="list-style-type: none"> • Incorrect control setting. Raise or lower setting until proper amount of heat is obtained. Dial markings are an indicator of relative heat settings and will vary slightly. • Lightweight or warped pans being used. Use only flat, evenly balanced, medium or heavyweight cookware. • Voltage is incorrect. Be sure appliance is properly connected to the specified power source. • Use only flat bottom, evenly balanced, medium or heavyweight cookware. Pans having a flat bottom heat better than warped pans. Cookware material affects heating. Heavy and medium weight pans heat evenly. Because lightweight pans heat unevenly, foods may burn easily.
Food not heating evenly	<ul style="list-style-type: none"> • Improper cookware. Select flat-bottomed cookware of a proper size to fit element. • Incorrect control setting. Raise or lower setting until proper amount of heat is obtained.
Scratches or abrasions on ceramic glass cooktop surface	<ul style="list-style-type: none"> • Coarse particles (such as salt or sand) are between cooktop and utensil. Be sure cooktop surface and bottom of utensils are clean before use. Small scratches do not affect cooking and will become less visible with use. • Cleaning materials not recommended for glass ceramic cooktop have been used. See Ceramic-Glass Cooktop section in this Owner's Guide. • Cookware with rough bottom has been used. Use flat-bottomed, smooth utensils. See Selecting Surface Cooking Utensils in this Owner's Guide.

Baking problems

For best cooking results pre-heat the oven when baking cookies, breads, cakes, pies or pastries, etc. There is no need to preheat the oven for roasting meats or baking casseroles. The cooking times and temperatures needed to bake a product may vary slightly from your previous appliance.

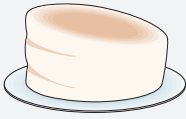
Baking Problems and Solutions Chart

BAKING PROBLEMS	CAUSES	CORRECTIONS
Cookies and biscuits burn on the bottom. 	<ul style="list-style-type: none"> • Cookies and biscuits put into the oven before the preheating time is completed. • Oven rack overcrowded. • Dark pan absorbs heat too fast. 	<ul style="list-style-type: none"> • Allow oven to preheat to the selected temperature before placing food in oven. • Choose pan sizes that will permit 5.1cm to 10.2cm (2" to 4") of air space on all sides when placed in the oven. • Use a medium-weight aluminum baking sheet.
Cakes too dark on top or bottom. 	<ul style="list-style-type: none"> • Cakes put into the oven before preheating time is completed. • Rack position too high or low. • Oven too hot. 	<ul style="list-style-type: none"> • Allow oven to preheat to the selected temperature before placing food in the oven. • Use proper rack position for baking needs. • Set oven temperature 25°F/12°C lower than recommended.
Cakes not done in the center. 	<ul style="list-style-type: none"> • Oven too hot. • Incorrect pan size. • Pan not centered in oven. 	<ul style="list-style-type: none"> • Set oven temperature 25°F/12°C lower than recommended. • Use pan size suggested in recipe. • Use proper rack position and place pan so there is 5.1cm to 10.2cm (2" to 4") of space on all sides of pan.
Cakes not level. 	<ul style="list-style-type: none"> • Range not level. • Pan too close to oven wall or rack overcrowded. • Pan warped. 	<ul style="list-style-type: none"> • Place a marked glass measuring cup filled with water on the center of the oven rack. If the water level is uneven, refer to the installation instructions for leveling the range. • Be sure to allow 5.1cm to 10.2cm (2" to 4") of clearance on all sides of each pan in the oven. • Do not use pans that are dented or warped.
Foods not done when cooking time is up. 	<ul style="list-style-type: none"> • Oven too cool. • Oven overcrowded. • Oven door opened too frequently. 	<ul style="list-style-type: none"> • Set oven temperature 25°F/12°C higher than suggested and bake for the recommended time. • Be sure to remove all pans from the oven except the ones to be used for baking. • Open oven door only after shortest recommended baking time.

Your appliance is covered by a one year limited warranty. For one year from your original date of purchase, Electrolux will repair or replace any parts of this appliance that prove to be defective in materials or workmanship when such appliance is installed, used, and maintained in accordance with the provided instructions. In addition, the glass cooktop or radiant surface element of your appliance (excluding built-in and free-standing range appliances) is covered by a two through five year limited warranty. During the 2nd through 5th years from your original date of purchase, Electrolux will provide a replacement glass cooktop or radiant surface element for your appliance which has proven to be defective in materials or workmanship when such appliance is installed, used, and maintained in accordance with the provided instructions.

Exclusions

This warranty does not cover the following:

1. Products with original serial numbers that have been removed, altered or cannot be readily determined.
2. Product that has been transferred from its original owner to another party or removed outside the USA or Canada.
3. Rust on the interior or exterior of the unit.
4. Products purchased "as-is" are not covered by this warranty.
5. Products used in a commercial setting.
6. Service calls which do not involve malfunction or defects in materials or workmanship, or for appliances not in ordinary household use or used other than in accordance with the provided instructions.
7. Service calls to correct the installation of your appliance or to instruct you how to use your appliance.
8. Expenses for making the appliance accessible for servicing, such as removal of trim, cupboards, shelves, etc., which are not a part of the appliance when it is shipped from the factory.
9. Service calls to repair or replace appliance light bulbs, air filters, water filters, other consumables, or knobs, handles, or other cosmetic parts.
10. Labor or in-home service costs during the additional limited warranty periods beyond the first year from your original date of purchase.
11. Pickup and delivery costs; your appliance is designed to be repaired in the home.
12. Surcharges including, but not limited to, any after hour, weekend, or holiday service calls, tolls, ferry trip charges, or mileage expense for service calls to remote areas, including the state of Alaska.
13. Damages to the finish of appliance or home incurred during transportation or installation, including but not limited to floors, cabinets, walls, etc.
14. Damages caused by: services performed by unauthorized service companies; use of parts other than genuine Electrolux parts or parts obtained from persons other than authorized service companies; or external causes such as abuse, misuse, inadequate power supply, accidents, fires, or acts of God.

DISCLAIMER OF IMPLIED WARRANTIES; LIMITATION OF REMEDIES

CUSTOMER'S SOLE AND EXCLUSIVE REMEDY UNDER THIS LIMITED WARRANTY SHALL BE REPAIR OR REPLACEMENT AS PROVIDED HEREIN. CLAIMS BASED ON IMPLIED WARRANTIES, INCLUDING WARRANTIES OF MERCHANTABILITY OR FITNESS FOR A PARTICULAR PURPOSE, ARE LIMITED TO ONE YEAR OR THE SHORTEST PERIOD ALLOWED BY LAW, BUT NOT LESS THAN ONE YEAR. ELECTROLUX SHALL NOT BE LIABLE FOR CONSEQUENTIAL OR INCIDENTAL DAMAGES SUCH AS PROPERTY DAMAGE AND INCIDENTAL EXPENSES RESULTING FROM ANY BREACH OF THIS WRITTEN LIMITED WARRANTY OR ANY IMPLIED WARRANTY. SOME STATES AND PROVINCES DO NOT ALLOW THE EXCLUSION OR LIMITATION OF INCIDENTAL OR CONSEQUENTIAL DAMAGES, OR LIMITATIONS ON THE DURATION OF IMPLIED WARRANTIES, SO THESE LIMITATIONS OR EXCLUSIONS MAY NOT APPLY TO YOU. THIS WRITTEN WARRANTY GIVES YOU SPECIFIC LEGAL RIGHTS. YOU MAY ALSO HAVE OTHER RIGHTS THAT VARY FROM STATE TO STATE.

If You Need Service

Keep your receipt, delivery slip, or some other appropriate payment record to establish the warranty period should service be required. If service is performed, it is in your best interest to obtain and keep all receipts. Service under this warranty must be obtained by contacting Electrolux at the addresses or phone numbers below.

This warranty only applies in the USA, Puerto Rico and Canada. In the USA and Puerto Rico, your appliance is warranted by Electrolux Major Appliances North America, a division of Electrolux Home Products, Inc. In Canada, your appliance is warranted by Electrolux Canada Corp. Electrolux authorizes no person to change or add to any obligations under this warranty. Obligations for service and parts under this warranty must be performed by Electrolux or an authorized service company. Product features or specifications as described or illustrated are subject to change without notice.

USA

1.800.944.9044

Electrolux Home Products, Inc.,
10200 David Taylor Drive
Charlotte, NC 28262

Canada

1-800-265-8352

Electrolux Canada Corp.

5855 Terry Fox Way

Mississauga, Ontario, Canada L5V 3E4

electrolux.com/shop



CE

