



GE Appliances

Top-mount no-frost  
**Refrigerators**



**Owner's Manual**

*Models 18-25*



GE Answer Center® 800.626.2000

Part No. 162D3948P006 Pub. No. 49-60004 6-98 CG

# ***Congratulations!*** ***You Are Now Part of the GE Family.***

---

Welcome to the GE family. We're proud of our quality products and we are committed to providing dependable service. You'll see it in this easy-to-use Owner's Manual and you'll hear it in the friendly voices of our customer service department.

Best of all, you'll experience these values each time you use your refrigerator. That's important, because your new refrigerator will be part of your family for many years. And we hope you will be part of ours for a long time to come.

We thank you for buying GE. We appreciate your purchase, and hope you will continue to rely on us whenever you need quality appliances for your home.

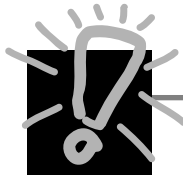

---

## ***Important!***

***Staple sales slip or cancelled check here.***

*Proof of the original purchase date is needed to obtain service under the warranty.*



---

***Write the model and serial numbers here.***

# \_\_\_\_\_

# \_\_\_\_\_

*You can find them on a label on the left side, near the top of the fresh food compartment.*

# GE & You, A Service Partnership.

Ask any GE appliance owner and they will tell you we stand behind our products with unmatched quality service. However, did you know that most questions result from simple problems that you can easily fix yourself in just a few minutes? This Owner's Manual can tell you how.

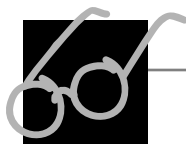

## Read this Manual

Inside you will find many helpful hints on how to use and maintain your refrigerator properly. Just a little preventive care on your part can save you a great deal of time and money over the life of your refrigerator.



## Review the Section on Troubleshooting Tips

You'll find many answers to common problems here. If you review our chart of Troubleshooting Tips first, you may not need to call for service at all.



## If You Need Service

If you do need service, you can relax knowing help is only a phone call away. A list of toll-free customer service numbers is included in the back section. Or, **in the U.S.**, you can always call the GE Answer Center<sup>®</sup> at 800.626.2000, 24 hours a day, 7 days a week. **In Canada**, call 1-800-361-3400.

### Safety Information

Safety Precautions . . . . .	4
How to Connect Electricity . . . . .	6
Use of Adapter Plugs . . . . .	6, 7
Use of Extension Cords . . . . .	7

Safety Information

### Operating Instructions

Temperature Controls . . . . .	8–10
Features . . . . .	11–16
Automatic Icemaker . . . . .	17
Ice and Water Dispenser . . . . .	18, 19
Care and Cleaning . . . . .	20–22

Operating Instructions

### Installation Instructions

Preparing to Install the Refrigerator . . . . .	23, 24
Water Line Installation . . . . .	25–29
Reversing the Door Swing/ Removing the Doors . . . . .	30–37

Installation Instructions

### Troubleshooting Tips

Normal Operating Sounds . . . . .	38
Before You Call For Service . . . . .	39–42

Troubleshooting Tips

### Customer Service

Warranty for Canadian Customers . . . . .	46
Warranty for U.S. Customers . . . . .	47
Service Telephone Numbers . . . . .	Back Cover

Customer Service

# IMPORTANT SAFETY INFORMATION. READ ALL INSTRUCTIONS BEFORE USING.

## ⚠ **WARNING!**

Use this appliance only for its intended purpose as described in this Owner's Manual.

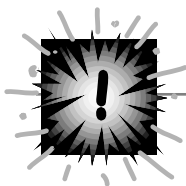

## SAFETY PRECAUTIONS

When using electrical appliances, basic safety precautions should be followed, including the following:

- This refrigerator must be properly installed and located in accordance with the Installation Instructions before it is used.
  - Do not allow children to climb, stand or hang on the shelves in the refrigerator. They could damage the refrigerator and seriously injure themselves.
  - Do not touch the cold surfaces in the freezer compartment when hands are damp or wet. Skin may stick to these extremely cold surfaces.
  - Do not store or use gasoline or other flammable vapors and liquids in the vicinity of this or any other appliance.
  - In refrigerators with automatic icemakers, avoid contact with the moving parts of the ejector mechanism, or with the heating element that releases the cubes. Do not place fingers or hands on the automatic icemaking mechanism while the refrigerator is plugged in.
  - Keep fingers out of the “pinch point” areas; clearances between the doors and between the doors and cabinet are necessarily small. Be careful closing doors when children are in the area.
  - Unplug the refrigerator before cleaning and making repairs.
- NOTE:** We strongly recommend that any servicing be performed by a qualified individual.
- Turning the control to the **OFF** position does not remove power to the light circuit.
  - Do not refreeze frozen foods which have thawed completely.

## **IMPORTANT:** *PROPER DISPOSAL OF THE REFRIGERATOR*

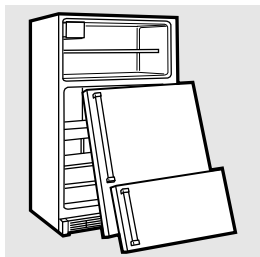

Child entrapment and suffocation are not problems of the past. Junked or abandoned refrigerators are still dangerous...even if they will sit for “just a few days.” If you are getting rid of your old refrigerator, please follow the instructions below to help prevent accidents.

### ***Before You Throw Away Your Old Refrigerator or Freezer:***

- Take off the doors.
- Leave the shelves in place so that children may not easily climb inside.

### ***CFC Disposal***

Your old refrigerator has a cooling system that used CFCs (chlorofluorocarbons). CFCs are believed to harm stratospheric ozone.

If you are throwing away your old refrigerator, make sure the CFC refrigerant is removed for proper disposal by a qualified servicer. If you intentionally release this CFC refrigerant you can be subject to fines and imprisonment under provisions of environmental legislation.

# IMPORTANT SAFETY INFORMATION. READ ALL INSTRUCTIONS BEFORE USING.

## ⚠ WARNING!



### HOW TO CONNECT ELECTRICITY

*Do not, under any circumstances, cut or remove the third (ground) prong from the power cord. For personal safety, this appliance must be properly grounded.*

The power cord of this appliance is equipped with a 3-prong (grounding) plug which mates with a standard 3-prong (grounding) wall outlet to minimize the possibility of electric shock hazard from this appliance.

Have the wall outlet and circuit checked by a qualified electrician to make sure the outlet is properly grounded.

Where a standard 2-prong wall outlet is encountered, it is your personal responsibility and obligation to have it replaced with a properly grounded 3-prong wall outlet.

The refrigerator should always be plugged into its own individual electrical outlet which has a voltage rating that matches the rating plate.

This provides the best performance and also prevents overloading house wiring circuits which could cause a fire hazard from overheated wires.

Never unplug your refrigerator by pulling on the power cord. Always grip plug firmly and pull straight out from the outlet.

Repair or replace immediately all power cords that have become frayed or otherwise damaged. Do not use a cord that shows cracks or abrasion damage along its length or at either end.

When moving the refrigerator away from the wall, be careful not to roll over or damage the power cord.



### USE OF ADAPTER PLUGS

*(Adapter plugs not permitted in Canada)*

*Because of potential safety hazards under certain conditions, we strongly recommend against the use of an adapter plug.*

However, if you must use an adapter, where local codes permit, a **temporary connection** may be made to a properly grounded 2-prong wall outlet by use of a UL-listed adapter available at most local hardware stores.

The larger slot in the adapter must be aligned with the larger slot in the wall outlet to provide proper polarity in the connection of the power cord.

When disconnecting the power cord from the adapter, always hold the adapter in place with one hand while pulling the power cord plug with the other hand. If this is not done, the adapter ground terminal is very likely to break with repeated use.

If the adapter ground terminal breaks, **DO NOT USE** the refrigerator until a proper ground has been established.

*Attaching the adapter ground terminal to a wall outlet cover screw does not ground the appliance unless the cover screw is metal, and not insulated, and the wall outlet is grounded through the house wiring. You should have the circuit checked by a qualified electrician to make sure the outlet is properly grounded.*



---

## USE OF EXTENSION CORDS

*Because of potential safety hazards under certain conditions, we strongly recommend against the use of an extension cord.*

However, if you must use an extension cord, it is absolutely necessary that it be a UL-listed (in the United States) or a CSA-listed (in Canada), 3-wire grounding type appliance extension cord having a grounding type plug and outlet and that the electrical rating of the cord be 15 amperes (minimum) and 120 volts.



---

## REMEMBER...

*Your continued health and safety are important to us.*

*Please read and follow this Safety Information carefully.*

*We want you to remain a happy and healthy part of our GE family.*

## SAVE THESE INSTRUCTIONS

## About the controls on the refrigerator.

The temperature controls on your refrigerator have letters and numbers. Initially set the fresh food control at **5** and the freezer control at **C**.

If you want colder or warmer temperatures, adjust the fresh food temperature first. When satisfied with that setting, adjust the freezer temperature.

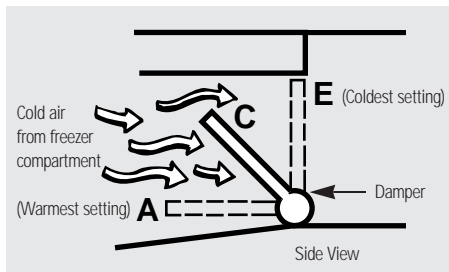
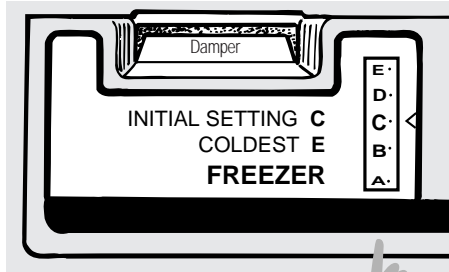





## Control Settings



### **Fresh Food Control**

The fresh food control maintains the temperatures throughout the refrigerator.

Moving the fresh food control to **OFF** stops cooling in both areas—fresh food and freezer—but does not shut off power to the refrigerator.



### **Freezer Control**

The freezer control moves a damper to change the amount of cold air that moves from the freezer to the fresh food compartment.

### **Power Saver Switch**

Push switch to the **POWER SAVER** setting to reduce the amount of electricity required to operate your refrigerator.

With this switch turned to the **POWER SAVER** setting, moisture may form on the outside of the refrigerator, especially when the weather is humid.

Over time, moisture that forms on the surface may cause rust.

To prevent moisture on the outside, move the power saver switch from the **POWER SAVER** setting.

**Cost?** About the same as it costs to use 2 night lights.

## About the controls on the refrigerator.

---

### How To Test Temperatures

Use the milk test for the fresh food compartment. Place a container of milk on the top shelf and check it a day later. If the milk is too warm or too cold, adjust the temperature controls.

Use the ice cream test for the freezer compartment. Place a container of ice cream in the center of the freezer and check it after a day. If it's too hard or too soft, adjust the temperature controls.

*After changing the controls, allow 24 hours for the refrigerator to reach the temperature you have set.*

---

### Food Storage

The type of packaging used and the storage temperatures will affect how long food will keep in the refrigerator.

New food storage guidelines are constantly being developed.

*Consult the County Extension Service for the latest information on freezing and storing foods.*

## About the refrigerator shelves and dishes.

Not all features are on all models.

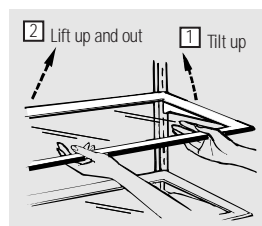

To Remove

### Rearranging the Shelves

Shelves in the fresh food and freezer compartments are adjustable.

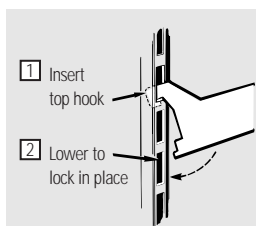

To Replace

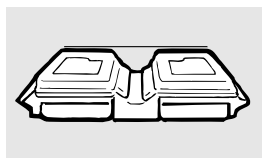

### Quick Serve™ System

**CAUTION:** Dishes and lids are not designed for use on the range top, broiler or in the regular oven. Such use can be hazardous.

Quick Serve™ dishes fit into a rack that hangs on the fresh food or freezer door. The rack can be moved in the same manner as the door bins.

Dishes and lids are safe for use in microwave ovens, refrigerators and freezers.



*Do not use when cooking high-fat foods, such as bacon, and high-sugar foods, such as candy and syrup. The high temperatures of the fat and sugar can cause bubbles to form on the inside of the dish.*

## About the refrigerator bins.

Not all features are on all models.

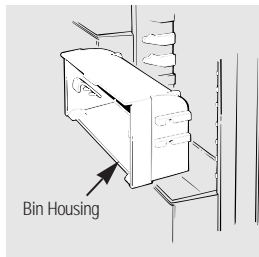
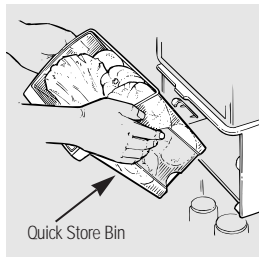
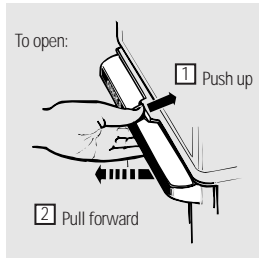

### Quick Store Bin

To avoid damaging the refrigerator, make sure the bin is closed and latched before closing the refrigerator door.

This bin can be placed on the fresh food or freezer doors.

*To remove the bin*, lift up and out of the bin housing.

*To move*, lift the bin housing up and out of the supports on the door. You do not have to remove the bin from the housing when moving it.

## About the storage drawers.

---

Not all features are on all models.

---

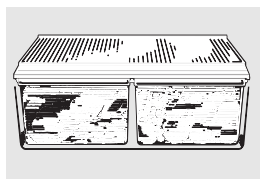

### Fruit and Vegetable Drawers

Excess water that may accumulate in the bottom of the drawers should be emptied and the drawers wiped dry.

---

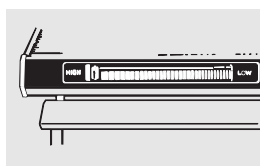

### Adjustable Humidity Drawers

Slide the control all the way to the **HIGH** setting to provide high humidity recommended for most vegetables.

Slide the control all the way to the **LOW** setting to provide lower humidity levels recommended for most fruits.

---

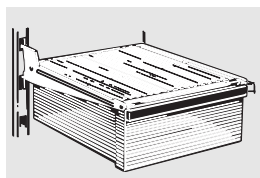

### Snacks Drawer

The snacks drawer can be moved to the most useful location for your family's needs.

---



### Adjustable Temperature Meat Drawer

When the drawer is placed in the top 6 slots on the left side and the lever is set at **COLDEST**, air from the freezer is forced around the drawer to keep it very cold.

You can move the drawer to any location if you don't want the extra cold storage.

The settings can be adjusted anywhere between **COLD** and **COLDEST**.

When set at **COLD**, the drawer will stay at the normal refrigerator temperature.

The **COLDEST** setting provides the coldest storage area.

## About storage drawer and cover removal.

Not all features are on all models.

### Storage Drawers

#### To Remove:

These drawers can be removed easily by lifting up slightly while pulling the drawers past the **stop** location.

When the door cannot be opened enough to pull the drawer straight out, slide the drawer toward the middle and remove it.

Remove the glass, then the frame. When replacing the glass, push the rear edge firmly into the frame.

Step 1

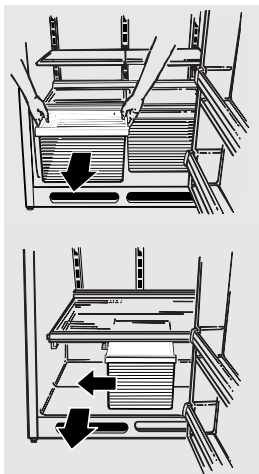

Step 2

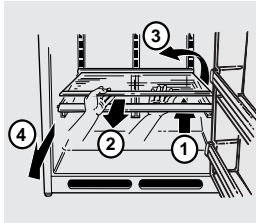

Step 3

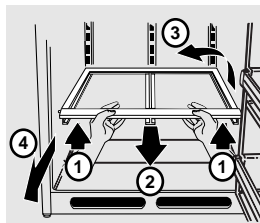

## About the additional features.

Not all features are on all models.

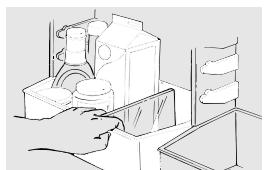

### Sniggers

Place a finger on either side of the snigger near the front to move the snigger back and forth to fit your needs.

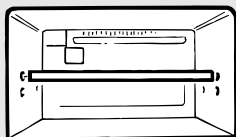

### ***Two-Position Freezer Shelf***

For models without an icemaker, the shelf can be placed in either position.

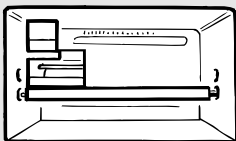

For models with an icemaker, the shelf must be placed in the lower position.

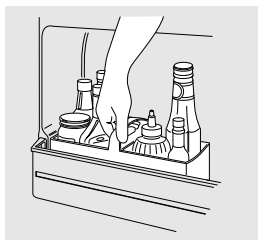

### ***Condiment Caddy***

The condiment caddy keeps frequently used condiments together. It fits in your refrigerator door shelf. A convenient handle allows condiments to be easily carried to the table.

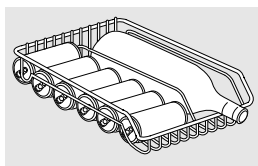

### ***Beverage Rack***

Slide-out beverage rack holds twelve cans of soda or two wine/water bottles (lengthwise). Can be removed for cleaning.

## About the additional features.

Not all features are on all models.

**Extra Freezer Shelf**

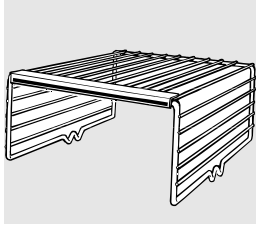

**Bins on the Doors**

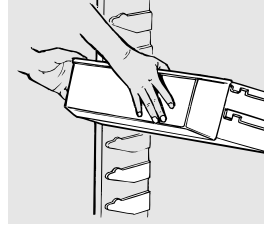

**Baking Soda Holder**

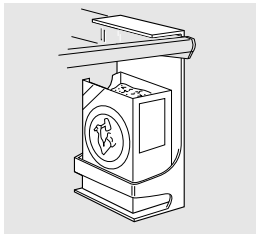

**Can Dispenser**

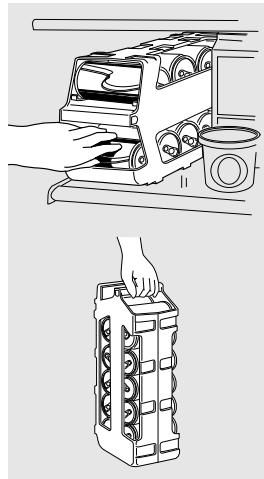



## About the automatic icemaker.

A newly-installed refrigerator may take 8 to 12 hours to begin making ice.

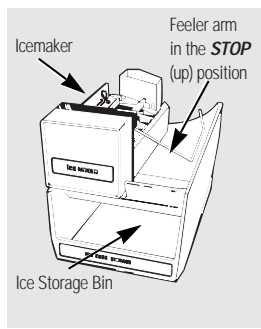

### Automatic Icemaker (on some models)

The icemaker will produce eight cubes per cycle—approximately 100 cubes in a 24-hour period, depending on freezer compartment temperature, room temperature, number of door openings and other use conditions.

If the refrigerator is operated before the water connection is made to the icemaker, keep the feeler arm in the **STOP** (up) position.

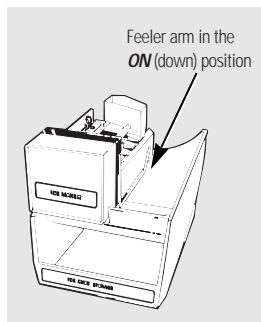

When the refrigerator has been connected to the water supply, move the feeler arm to the **ON** (down) position.

The icemaker will fill with water when it cools to freezing. A newly-installed refrigerator may take 8 to 12 hours to begin making ice cubes.

Throw away the first few batches of ice to allow the water line to clear.

Be sure nothing interferes with the swing of the feeler arm.

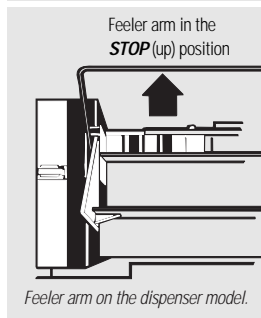

It is normal for several cubes to be joined together.

If ice is not used frequently, old ice cubes will become cloudy and taste stale.

### Icemaker Accessory Kit

If your refrigerator did not already come equipped with an automatic icemaker, an icemaker accessory kit is available at extra cost. Check the back of the refrigerator for the specific icemaker kit needed for your model.

## About the ice and water dispenser.

On some models

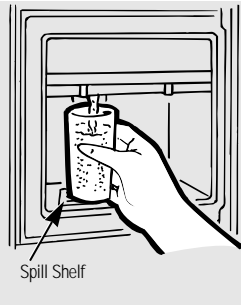

### To Use the Dispenser

Press the rim of the glass gently against the dispenser pad.

Set the selector switch to **ICE CUBES**, **CRUSHED ICE** or **WATER** (on some models).

The spill shelf is not self-draining. To reduce water spotting, the shelf and its grille should be cleaned regularly.

If no water is dispensed when the refrigerator is first installed, there may be air in the water line system. Press the dispenser pad for at least two minutes to remove trapped air from the water line and to fill the water system. To flush out impurities in the water line, throw away the first six glassfuls of water.

**CAUTION:** Never put fingers or any other objects into the ice crusher discharge opening.

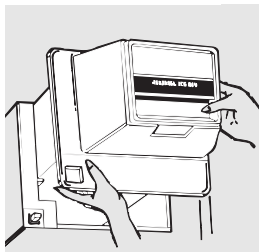

### Ice Storage Bin

**To remove:**

Lift the front of the bin and pull the bin straight out while supporting it at front and rear.

**To replace:**

Slide it back on the ice bin shelf. If the bin does not go all the way back, remove it and rotate the drive mechanism 1/4 turn. Then push the bin back again.

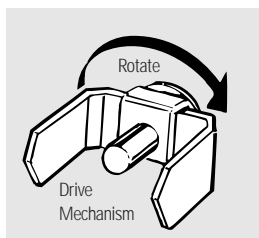



### **Water Filter Accessory**

The water filter is an option at extra cost and is available from your dealer. Specify WR97X0214. It has complete installation instructions and installs on 1/4" O.D. copper water line.

### **Important Facts About Your Dispenser**

- Add ice before filling the glass with a beverage. This will prevent splashing, which could cause the ice selector switch to stick or bind.
- Do not add ice from trays or bags to the storage bin. It may not crush or dispense well.
- Avoid overfilling glass with ice and use of narrow or extra-tall glasses. Backed-up ice can jam the chute or cause the door in the chute to freeze shut. If ice is blocking the chute, poke it through with a wooden spoon.
- Beverages and foods should not be quick-chilled in the ice storage bin. Cans, bottles or food packages in the storage bin may cause the icemaker or auger to jam.
- Some crushed ice may be dispensed even though you selected **ICE CUBES**. This happens occasionally when a few cubes accidentally get directed to the crusher.
- After crushed ice is dispensed, some water may drip from the chute.
- Sometimes a mound of snow will form on the door in the ice chute. This condition is normal and usually occurs when you have dispensed crushed ice repeatedly. The snow will eventually evaporate.
- Dispensed water is not ice cold. For colder water, add crushed ice or cubes before dispensing water.

## Care and cleaning of the refrigerator.

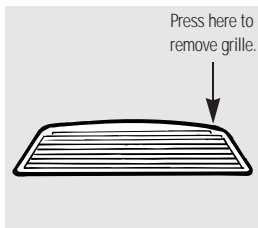

### Cleaning the Outside

**The dispenser well**, beneath the grille, should be wiped dry. Water left in the well may leave deposits. Remove the deposits by adding undiluted vinegar to the well. Soak until the deposits disappear or become loose enough to rinse away.

**The dispenser pad** (on some models). Clean with a warm water and baking soda solution—about a tablespoon (15 ml) of baking soda to a quart (1 l) of water. Rinse thoroughly and wipe dry.

**HINT:** Open the freezer door part way to prevent dispensing of ice or water when cleaning.

**The door handles and trim** (on some models). Clean with a cloth dampened with soapy water. Dry with a soft cloth.

**The soft door handles** (on some models) are easy to keep clean if they are waxed every few months. Use a household wax such as Pledge brand or Jubilee brand to coat the handles. Clean with soapy water or a non-abrasive, all-purpose cleaner.

**Keep the outside clean.** Wipe with a clean cloth lightly dampened with kitchen appliance wax or mild liquid dish detergent. Dry and polish with a clean, soft cloth.



*Do not wipe the refrigerator with a soiled dish cloth or wet towel. These may leave a residue that can erode the paint. Do not use scouring pads, powdered cleaners, bleach or cleaners containing bleach because these products can scratch and weaken the paint finish.*

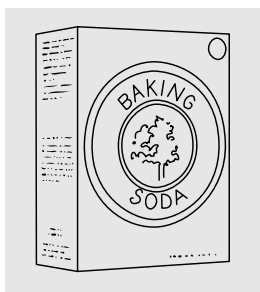

### ***Cleaning the Inside***

***To help prevent odors***, leave an open box of baking soda in the fresh food and freezer compartments.

***Unplug the refrigerator before cleaning.*** If this is not practical, wring excess moisture out of sponge or cloth when cleaning around switches, lights or controls.

Use an appliance wax polish on the inside surface between the doors.

Use a warm water and baking soda solution—about a tablespoon (15 ml) of baking soda to a quart (1 l) of water. This both cleans and neutralizes odors. Rinse and wipe dry.

After cleaning the door gaskets, apply a thin layer of petroleum jelly to the door gaskets at the hinge side. This helps keep the gaskets from sticking and bending out of shape.



***Avoid cleaning cold glass shelves (on some models) with hot water because the extreme temperature difference may cause them to break. Handle glass shelves carefully. Bumping tempered glass can cause it to shatter.***

***Do not wash any plastic refrigerator parts in the dishwasher except Quick Serve dishes and lids.***



***Clean the condenser coils at least once a year.***

### ***Under the Refrigerator***

For most efficient operation, keep the area under the refrigerator clean. Remove the base grille and sweep away or vacuum up dust.

For best results, use a brush specially designed for this purpose. It is available at most appliance parts stores.

## Care and cleaning of the refrigerator.

---

### Behind the Refrigerator

Be careful when moving the refrigerator away from the wall. All types of floor coverings can be damaged, particularly cushioned coverings and those with embossed surfaces.

Pull the refrigerator straight out and return it to position by pushing it straight in. Moving the refrigerator in a side direction may result in damage to the floor covering or refrigerator.

*When pushing the refrigerator back, make sure you don't roll over the power cord or icemaker supply line (on some models).*

---

### Light Bulb Replacement

To replace a burned-out bulb, unplug the refrigerator from its electrical outlet, remove the light shield, unscrew the bulb when cool and replace it with an appliance bulb of the same or lower wattage.

*Turning the control to the **OFF** position does not remove power to the light circuit.*

---

### Preparing for Vacation

For long vacations or absences, remove food and unplug the refrigerator. Move the fresh food control to the **OFF** position, and clean the interior with a baking soda solution of one tablespoon (15 ml) of baking soda to one quart (1 l) of water. Leave the doors open.

Move the icemaker feeler arm to **STOP** (up) position and shut off the water supply to the refrigerator.

If the temperature can drop below freezing, have a qualified servicer drain the water supply system (on some models) to prevent serious property damage due to flooding.

---

### Preparing to Move

If the doors need to be removed, see the *Removing the doors* section. On dispenser models, the water line to the dispenser must be disconnected before the doors are removed.

Secure all loose items such as grille, shelves and drawers by taping them securely in place to prevent damage.

*Be sure the refrigerator stays in an upright position during moving.*

## Preparing to install the refrigerator.

---

*Read these instructions completely and carefully.*



### Water Supply to the Icemaker *(on some models)*

---

If the refrigerator has an icemaker, it will have to be connected to a cold water line.

A water supply kit (containing copper tubing, shutoff valve, fittings and instructions) is available at extra cost from your dealer or from Parts and Accessories, 800-626-2002.



### Refrigerator Location

---

Do not install the refrigerator where the temperature will go below 60°F (16°C) because it will not run often enough to maintain proper temperatures.

Install it on a floor strong enough to support it fully loaded.

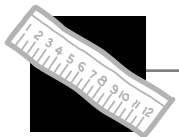

### Clearances

---

Allow the following clearances for ease of installation, proper air circulation and plumbing and electrical connections:

Sides	3/4" (19 mm)
Top	1" (25 mm)
Back	1" (25 mm)

If a 19', 22' or 25' model is to be installed next to a wall on the hinge side, allow 1½" (38 mm) for door clearance.

## Preparing to install the refrigerator.

*Read these instructions completely and carefully.*

**Rollers** (on some models)

*The rollers have 3 purposes:*

- 1 Rollers adjust so the door closes easily when opened about halfway.  
[Raise the front about 3/4" (19 mm) from the floor.]
- 2 Rollers adjust so the refrigerator is firmly positioned on the floor and does not wobble.
- 3 Rollers allow you to move the refrigerator away from the wall for cleaning.

*To adjust the rollers:*

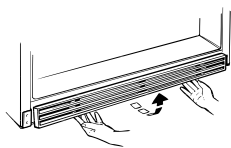

Remove the base grille by pulling out at the bottom.

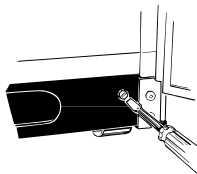

Turn the two front roller adjusting screws clockwise to raise the refrigerator, counter-clockwise to lower it.

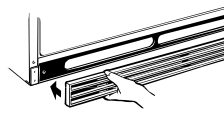

Replace the base grille by pushing forward until it snaps into place.



# Installing the water line.

---

*Read these instructions completely and carefully.*



## Before You Begin

---

*This water line installation is not warranted by the refrigerator or icemaker manufacturer. Follow these instructions carefully to minimize the risk of expensive water damage.*

*Water hammer (water banging in the pipes) in house plumbing can cause damage to refrigerator parts and lead to water leakage or flooding. Call a qualified plumber to correct water hammer before installing the water supply line to the refrigerator.*

*To prevent burns and product damage, do not hook up the water line to the hot water line.*

*If you use your refrigerator before connecting the water line, make sure the icemaker feeler arm is kept in the **STOP** (up) position.*

*Do not install the icemaker tubing in areas where temperatures fall below freezing.*

*When using any electrical device (such as a power drill) during installation, be sure the device is insulated or wired in a manner to prevent the hazard of electric shock.*

*All installations must be in accordance with local plumbing code requirements.*

## Installing the water line.

Read these instructions completely and carefully.



### What You Will Need

To determine how much copper tubing you need:

Measure the distance from the water valve on the back of the refrigerator to the water supply pipe. Then add 8 feet (244 cm). Be sure there is sufficient extra tubing [about 8 feet (244 cm) coiled into 3 turns of about 10 inches (25 cm) diameter] to allow the refrigerator to move out from the wall after installation.

- **A water supply kit** (containing copper tubing, shutoff valve and fittings listed below) is available at extra cost from your dealer or from Parts and Accessories, 800-626-2002.
- **A cold water supply.** The water pressure must be between 20 and 120 p.s.i.
- **Power drill.**
- **Copper tubing**, 1/4" outer diameter to connect the refrigerator to the water supply. Be sure both ends of the tubing are cut square.

*Do not use plastic tubing or plastic fittings because the water supply line is under pressure at all times. Certain types of plastic tubing may become brittle with age and crack, resulting in water leakage.*

- **Two 1/4" outer diameter compression nuts and 2 ferrules (sleeves)**—to connect the copper tubing to the shutoff valve and the refrigerator water valve.
- If your existing water line has a flared fitting at the end, you will need an **adapter** (available at plumbing supply stores) to connect the water line to the refrigerator **OR** you can cut off the flared fitting with a **tube cutter** and then use a compression fitting.
- **Shutoff valve** to connect to the cold water line. The shutoff valve should have a water inlet with a minimum inside diameter of 5/32" at the point of connection to the **COLD WATER LINE**. Saddle-type shutoff valves are included in many water supply kits. Before purchasing, make sure a saddle-type valve complies with your local plumbing codes.



## Shut Off the Main Water Supply

Turn on the nearest faucet long enough to clear the line of water.

### Install the Shutoff Valve

- 1 Install the shutoff valve on the nearest frequently used drinking water line.
- 2 Choose a location for the valve that is easily accessible. It is best to connect into the side of a vertical water pipe. When it is necessary to connect into a horizontal water pipe, make the connection to the top or side, rather than at the bottom, to avoid drawing off any sediment from the water pipe.
- 3 Drill a 1/4" hole in the water pipe, using a sharp bit. Remove any burrs resulting from drilling the hole in the pipe.
- 4 Fasten the shutoff valve to the cold water pipe with the pipe clamp.
- 5 Tighten the clamp screws until the sealing washer begins to swell.

*Do not overtighten or you may crush the copper tubing.*

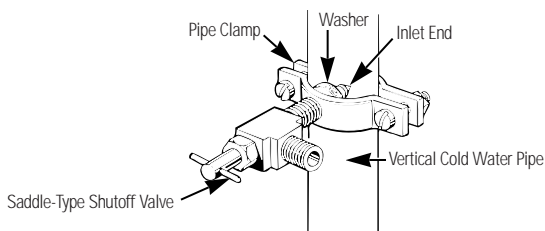

## Installing the water line.

*Read these instructions completely and carefully.*

### **Route the Copper Tubing and Connect It to the Shutoff Valve**

Route the copper tubing between the cold water line and the refrigerator.

Route the tubing through a hole drilled in the wall or floor (behind the refrigerator or adjacent base cabinet) as close to the wall as possible.

*Be sure there is sufficient extra tubing [about 8 feet (244 cm) coiled into 3 turns of about 10" (25 cm) diameter] to allow the refrigerator to move out from the wall after installation.*

Place the compression nut and ferrule (sleeve) onto the end of the tubing and connect it to the shutoff valve.

Make sure the tubing is fully inserted into the valve. Tighten the compression nut securely.

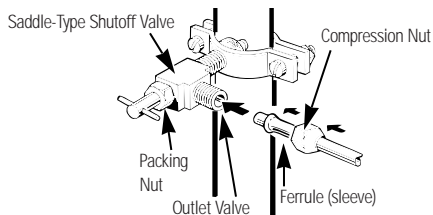

### **Turn On the Water and Flush Out the Tubing**

- 1 Turn the main water supply on and flush out the tubing until the water is clear.
- 2 Shut the water off at the water valve after about one quart (1 l) of water has been flushed through the tubing.

## Connect the Tubing to the Refrigerator

Before making the connection to the refrigerator, be sure the refrigerator power cord is not plugged into the wall outlet.

We recommend installing a water filter if your water supply has sand or particles that could clog the screen of the refrigerator's water valve. Install it in the water line near the refrigerator.

- 1 Remove the plastic flexible cap from the water valve.
- 2 Place the compression nut and ferrule (sleeve) onto the end of the tubing as shown.
- 3 Insert the end of the copper tubing into the water valve connection as far as possible. While holding the tubing, tighten the fitting.
- 4 Fasten the copper tubing into the clamp provided to hold it in a vertical position. You may need to pry open the clamp.

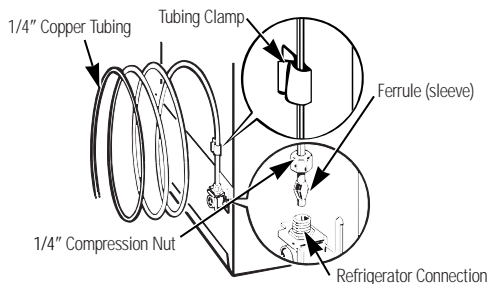

## Turn the Water On at the Shutoff Valve

Tighten any connections that leak.

## Plug In the Refrigerator

Arrange the coil of copper tubing so that it does not vibrate against the back of the refrigerator or against the wall. Push the refrigerator back to the wall.

## Start the Icemaker

Set the icemaker feeler arm to the **ON** (down) position. The icemaker will not begin to operate until it reaches its operating temperature of 15°F (-9°C) or below. It will then begin operation automatically if the icemaker feeler arm is in the **ON** (down) position.

**NOTE:** The icemaker may double-cycle when it first starts, causing some water spillage from the icemaker into the ice bucket. This is normal and should not happen again.

## Reversing the door swing/Removing the doors.

Read these instructions completely and carefully.



### Important Notes

**NOTE:** Doors on dispenser models do not reverse. However, if you need to remove the doors on a dispenser model, first disconnect the water line to the dispenser. See the Removing the doors section. To rehang the doors, see the Rehang the doors section.

**When reversing the door swing (on non-dispenser models):**

- Read the instructions all the way through before starting.
- Handle parts carefully to avoid scratching paint.
- Set screws down by their related parts to avoid using them in the wrong places.
- Provide a non-scratching work surface for the doors.

**IMPORTANT:** Once you begin, do not move the cabinet until door-swing reversal is completed.

These instructions are for changing the hinges from the right side to the left side—if you ever want to change the hinges back to the right side, follow these same instructions and reverse all references to left and right.



### Tools Required

- Phillips screwdriver
- Masking tape
- T20 or T25 Torxdriver, whichever your model requires
- Putty knife or thin-blade screwdriver
- 3/8" socket and ratchet (a 6-point socket is recommended)

## Before Removing the Doors

- 1 Unplug the refrigerator from its electrical outlet.
- 2 Empty all door shelves, including the dairy compartment.

**CAUTION:** Do not let either door drop to the floor. To do so could damage the door stop.

## Remove the Freezer Door on Non-Dispenser Models

- 1 Tape the door shut with masking tape.
- 2 With a Phillips screwdriver, remove the hinge cover on top of the freezer door (on some models).
- 3 Lift the hinge straight up to free the hinge pin from the socket in the top of the door.
- 4 Remove the tape and tilt the door away from the cabinet. Lift it off the bottom socket.
- 5 Set the door on a non-scratching surface with the outside up.

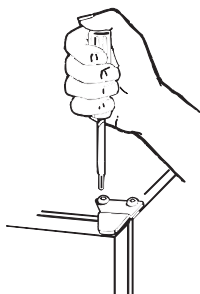

## Removing the doors.

Read these instructions completely and carefully.

### Remove the Freezer Door on Dispenser Models

- 1 Tape the door shut with masking tape. There is a water line that runs from the dispenser to the hinge area and to the water valve at the back of the refrigerator. This line needs to be disconnected at the valve before you remove the door hinge.

To disconnect this line, first remove or bend back the compressor compartment cover.

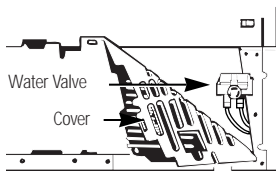

Use a wrench to loosen the plastic nut (counterclockwise) and pull out the water line. This may require some effort. Drain the water line into a cup.

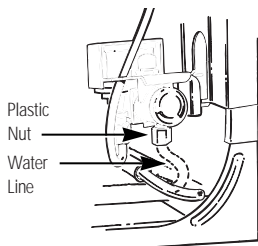

At the front of the refrigerator, unsnap the hinge cover at the bottom of the fresh food door. Remove the base grille and unclip the water line from the hinge area and from behind the base channel. Pull the tubing through to the front of the refrigerator.

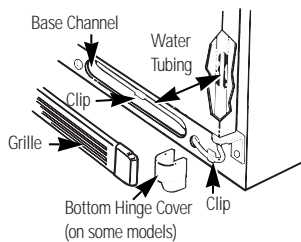

- 2 With a Phillips screwdriver, remove the hinge cover on top of the freezer door (on some models).

There will be 2 wire connectors under the hinge cover. Pull them apart.

With a T-20 Torxdriver, remove the 2 Torx screws that hold the top hinge to the cabinet.

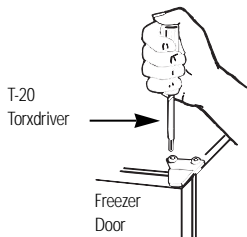



### ***Remove the Freezer Door on Dispenser Models***

- 3** Lift the hinge straight up to free the hinge pin from the socket in the top of the door.
- 4** Remove the tape and tilt the door away from the cabinet. Lift it off the bottom socket.

Pull out the water line until the line comes all the way out. This may require 2 people, one to hold the door and another to pull out the water line.
- 5** Set the door on a non-scratching surface with the outside up.

### ***Remove the Fresh Food Door***

- 1** Tape the door shut with masking tape.
- 2** Remove the hinge pin with a 3/8" socket.
- 3** Remove the tape and tilt the door away from the cabinet. Remove and save the washer on the hinge pin.
- 4** Lift the door straight off the bottom hinge bracket.
- 5** Set the door on a non-scratching surface with the outside up.

## Reversing the hardware.

Read these instructions completely and carefully.

### Transfer Bottom Hinge Bracket to the Left

- 1 Remove the base grille by pulling it straight out.
- 2 Using a Torxdriver, move the bottom hinge bracket and plastic washer from the right side to the left side.

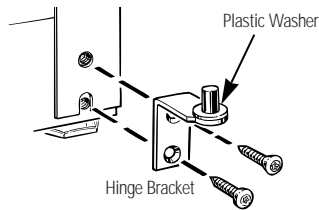

### Transfer Center Hinge Bracket to the Left

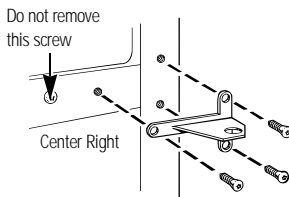

- 1 Remove the center hinge bracket by removing the three Torx screws.

**NOTE:** Keep these screws with the hinge bracket. They are long screws and will be used when installing the hinge on the other side.

- 2 Remove the three Torx screws from the center left side of the cabinet. Screw them into the holes on the right side.

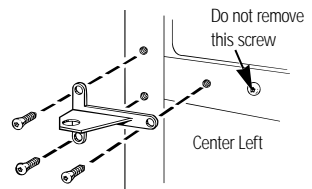

Place the center hinge bracket over the holes at the center left side of the cabinet. Insert and tighten the three long screws.

### Transfer Top Hinge to the Left

Interchange hinge and screws at top right with screws at top left of cabinet.

*Do not tighten screws on hinge side at this time.*

### Transfer Door Stops

- 1 On each door, move the metal door stop from the right to the left.
- 2 Move any screws from the left to the right.

## Reversing the door handles.

### Transfer Fresh Food Door Handle



- Remove the handle plug using a putty knife under the edge. Remove the screw underneath.
- Remove the two screws holding the handle to the top of the door.

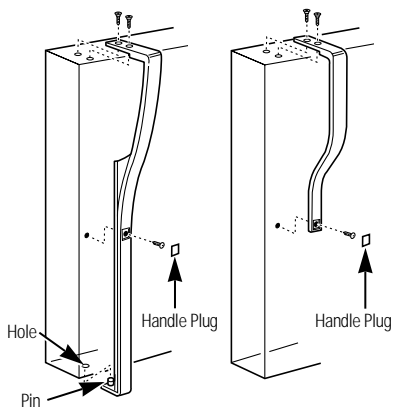

*Models with long handles have a pin that fits into a hole at the bottom of the door.*

- Move the large plug button from the left edge of the door and insert it into the hole on the opposite side.
- Move the small plug buttons from the right side of the door and insert them into the holes on the opposite side.
- Move the door medallion.

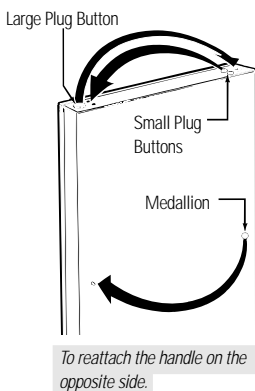

### Transfer Freezer Door Handle

- Remove the screws holding the handle to the top and bottom of the door.
- Move the plug button on the right side of the door to the handle screw hole on the left side.
- Reattach the handle on the opposite side using the holes closest to the edge of the door.

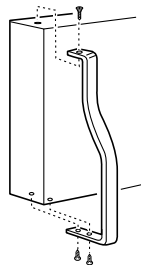

## Rehanging the doors.

Read these instructions completely and carefully.

### Rehanging the Fresh Food Door

- 1 Lower the fresh food door onto the bottom hinge pin.  
*Be sure the washer is in place.*
- 2 Straighten the door and line it up with the center hinge bracket.
- 3 Reinstall the hinge pin with a 3/8" socket. Turn it until it extends through the hinge bracket and into the door.

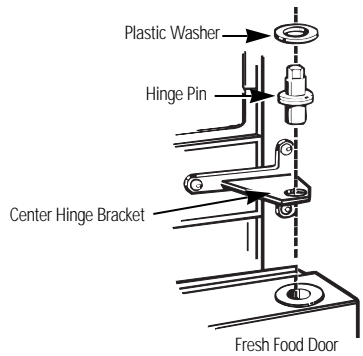
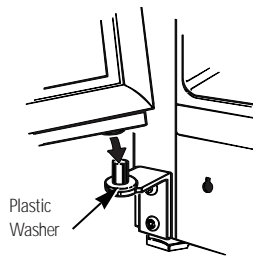

### Rehang the Freezer Door on Non-Dispenser Models

- 1 Lower the freezer door onto the center hinge pin.  
*Be sure the washer is in place.*
- 2 Lift the top hinge so the pin fits into the door socket.
- 3 Make sure the door is straight and the gap between the doors is even across the front. Tighten the top hinge screws.

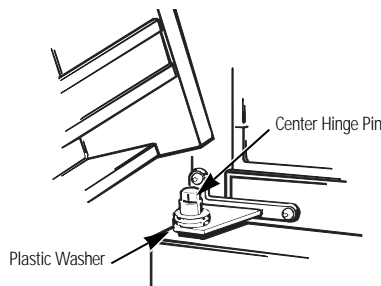

# Reversing the doors.

## Rehang the Freezer Door on Dispenser Models

- 1 One person will need to hold the door as the other person routes the water line through the conduit.

The conduit goes down into the fresh food door hinge. Insert the water line into the conduit and push it through until it goes down to the bottom of the refrigerator.

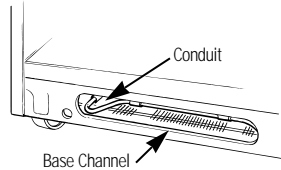

- 2 Lower the bottom socket of the freezer door onto the center hinge pin. Be sure the washer is in place.

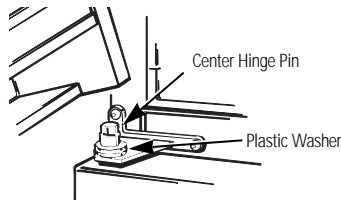

- 3 Tilt the door toward the cabinet, lifting the top hinge so the pin fits into the socket on top of the door.
- 4 Tighten the top hinge screws after making sure the gap between the doors is even all across the front.

Reconnect the 2 wire connectors.

- 5 Replace the 2 Torx screws to hold the top hinge to the cabinet. Replace the hinge cover (on some models).

If the door swing is on the right side you will need to route the water line across the front to the conduit on the bottom left side of the refrigerator.

Secure the water line in the clip behind the base channel. Feed the water line through the conduit on the bottom until it comes out at the back of the refrigerator near the water valve. Tighten the plastic nut firmly. Replace the compressor compartment cover.

Replace the base grille and bottom hinge cover. Push the hinge cover on completely.

Press the dispenser pad for at least 2 minutes. This will remove trapped air, flush out the water line and fill the water system.

## Normal operating sounds.



Depending on the placement of the refrigerator in your kitchen, you may want to place a piece of rubber backed carpet under the refrigerator to reduce noise.

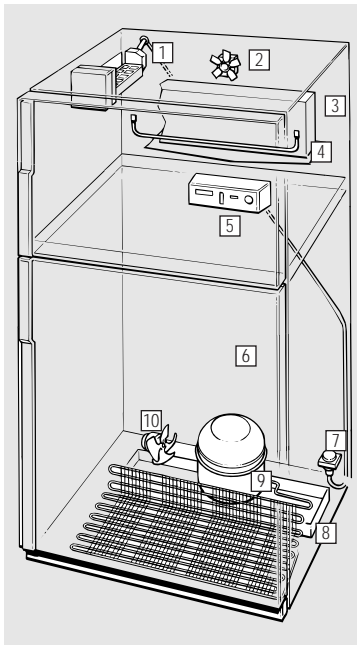

These sounds are normal and are due mostly to highly efficient operation.

- 1 Icemaker (on some models).** Occasionally you will hear ice cubes dropping into the ice bin. If this is your first icemaker, you'll hear occasional sounds that may be unfamiliar. They are normal icemaking sounds and are not a cause for concern.
- 2 Evaporator Fan.** You may hear air being forced through the cabinet by the fan.
- 3 Evaporator.** The flow of refrigerant through the evaporator may create a boiling or gurgling sound.
- 4 Defrost Heater.** During defrost cycles, water dripping onto the heater may cause a hissing or sizzling sound. After defrosting, a popping sound may occur and the evaporator may create a boiling or gurgling sound.
- 5 Cold Control & Defrost Timer.** These parts can produce a snapping sound when turning the refrigerator on or off. The timer also produces a sound similar to an electric clock.
- 6 Plastic Liner.** Cracking or popping sounds due to expansion of the plastic liner.
- 7 Water Valve (on models equipped with an automatic icemaker).** When the icemaker fills with water, a buzzing sound and running water will be heard.
- 8 Water Pan.** Water may be heard running into the drain pan during the defrost cycle.
- 9 Compressor.** Modern, high efficiency compressors operate much faster than older models. The compressor may have a high pitched hum or pulsating sound.
- 10 Condenser Fan.** You may hear air being forced over the condenser by the fan.

## Before you call for service...



### Troubleshooting Tips

Save time and money! Review the charts on the following pages first and you may not need to call for service.

<b>Problem</b>	<b>Possible Causes</b>	<b>What To Do</b>
<b>Refrigerator does not operate</b>	<b>Refrigerator in defrost cycle.</b>	• Wait about 30 minutes for defrost cycle to end.
	<b>Fresh food control in OFF position.</b>	• Move the fresh food control to a temperature setting.
	<b>Refrigerator is unplugged.</b>	• Push the plug completely into the outlet.
	<b>The fuse is blown/circuit breaker is tripped.</b>	• Replace fuse or reset the breaker.
<b>Motor operates for long periods or cycles on and off frequently. (Modern refrigerators with more storage space and a larger freezer require more operating time. They start and stop often to maintain even temperatures.)</b>	<b>Normal when refrigerator is first plugged in.</b>	• Wait 24 hours for the refrigerator to completely cool down.
	<b>Often occurs when large amounts of food are placed in refrigerator.</b>	• This is normal.
	<b>Door left open or door is not sealing when closed because refrigerator is not level.</b>	• See <i>Rollers</i> .
	<b>Hot weather or frequent door openings.</b>	• This is normal.
	<b>Temperature controls set at the coldest setting.</b>	• See <i>About the controls</i> .
	<b>Grille and condenser need cleaning.</b>	• See <i>Care and cleaning</i> .
	<b>Vibration or rattling (slight vibration is normal)</b>	<b>Rollers need adjusting.</b>

## Before you call for service...

<b>Problem</b>	<b>Possible Causes</b>	<b>What To Do</b>
<i>Fresh food or freezer compartment too warm</i>	Temperature control not set cold enough.	• See <i>About the controls</i> .
	Warm weather or frequent door openings.	• Set the temperature control one step colder. See <i>About the controls</i> .
	Door left open.	• Check to see if package is holding door open.
<i>Frost or ice crystals on frozen food (frost within package is normal)</i>	Package blocking air duct in freezer compartment.	• Check to see if package is blocking air duct in freezer compartment.
	Door left open.	• Check to see if package is holding door open.
<i>Automatic icemaker does not work (on some models)</i>	Too frequent or too long door openings.	
	Icemaker feeler arm in <b>STOP</b> (up) position.	• Move the feeler arm to the <b>ON</b> (down) position. • Cubes may have fused to the side of the mold. Move the feeler arm to the <b>STOP</b> (up) position then remove these cubes.
	Water supply turned off or not connected.	• See <i>Installing the water line</i> .
	Freezer compartment too warm.	• Wait 24 hours for the refrigerator to completely cool down.
	Piled up cubes in the storage bin cause the icemaker to shut off.	• Level cubes by hand.
<i>Cubes too small (on some models)</i>	Water shutoff valve connecting refrigerator to water line may be clogged.	• Call a plumber to clean the valve.
<i>Slow ice cube freezing</i>	Door left open.	• Check to see if package is holding door open.
	Temperature control not set cold enough.	• See <i>About the controls</i> .



<b>Problem</b>	<b>Possible Causes</b>	<b>What To Do</b>
<i>Ice cubes have odor/taste</i>	<b>Ice storage bin needs cleaning.</b>	<ul style="list-style-type: none"> <li>• Empty and wash bin. Discard old cubes.</li> </ul>
	<b>Food transmitting odor/ taste to ice cubes.</b>	<ul style="list-style-type: none"> <li>• Wrap foods well.</li> </ul>
	<b>Interior of refrigerator needs cleaning.</b>	<ul style="list-style-type: none"> <li>• See <i>Care and cleaning</i>.</li> </ul>
<i>Moisture forms on cabinet surface between the doors</i>	<b>Not unusual during periods of high humidity.</b>	<ul style="list-style-type: none"> <li>• Wipe surface dry and make sure the power saver switch is not set at the <b>POWER SAVER</b> setting.</li> </ul>
<i>Moisture collects inside (in humid weather, air carries moisture into refrigerator when doors are opened)</i>	<b>Too frequent or too long door openings.</b>	
<i>Food freezing in the refrigerator</i>	<b>Food too close to air vent.</b>	<ul style="list-style-type: none"> <li>• Move the food away from the air vent (near controls).</li> </ul>
	<b>Fresh food control is set too cold.</b>	<ul style="list-style-type: none"> <li>• Move the fresh food control to a warmer temperature.</li> </ul>
<i>Cube dispenser does not work (on some models)</i>	<b>Icemaker turned off or water supply turned off.</b>	<ul style="list-style-type: none"> <li>• Turn on icemaker or water supply.</li> </ul>
	<b>Ice cubes are frozen to icemaker feeler arm.</b>	<ul style="list-style-type: none"> <li>• Remove cubes and move the feeler arm to the <b>ON</b> (down) position.</li> </ul>
	<b>Irregular ice clumps in storage container.</b>	<ul style="list-style-type: none"> <li>• Break up with fingertip pressure and discard remaining clumps.</li> <li>• Freezer temperature may be too warm. Adjust the freezer control to a colder setting, one position at a time, until the clumps do not form.</li> </ul>
<i>Refrigerator has odor</i>	<b>Foods transmitting odor to refrigerator.</b>	<ul style="list-style-type: none"> <li>• Foods with strong odors should be tightly wrapped.</li> <li>• Keep an open box of baking soda in the refrigerator; replace every three months.</li> </ul>
	<b>Interior needs cleaning.</b>	<ul style="list-style-type: none"> <li>• See <i>Care and cleaning</i>.</li> </ul>

## Before you call for service...

<i>Problem</i>	<i>Possible Causes</i>	<i>What To Do</i>
<i>Hot air from bottom of refrigerator</i>	<b>Normal air flow cooling motor. In the refrigeration process, it is normal that heat be expelled in the area under the refrigerator. Some floor coverings will discolor at these normal and safe temperatures.</b>	<ul style="list-style-type: none"> <li>• Your floor covering supplier should be consulted if you object to this discoloration.</li> </ul>
<i>Orange glow in the freezer</i>	<b>Defrost heater is on.</b>	<ul style="list-style-type: none"> <li>• This is normal.</li> </ul>
<i>Door does not close by itself</i>	<b>Rollers need adjusting.</b>	<ul style="list-style-type: none"> <li>• See <i>Rollers</i>.</li> </ul>

# Notes

---

*Safety Information*

*Operating Instructions*

*Installation Instructions*

*Troubleshooting Tips*

*Customer Service*

# *Notes*

---

*Safety Information*

*Operating Instructions*

*Installation Instructions*

*Troubleshooting Tips*

*Customer Service*

# Consumer Warranty

*For customers in Canada*

## First Year

**CAMCO** warrants the replacement or repair of all parts of this Refrigerator which prove to be defective in material or workmanship for one year from the date of purchase. Such parts will be repaired or replaced at the option of Camco without charge, subject to the terms and conditions set out below.

The **DEALER** warrants to provide the service labor for the repair or replacement of all parts of this Refrigerator which prove to be defective in material or workmanship for one year from the date of purchase.

## Next Four Years

**CAMCO** warrants the hermetically sealed refrigerator (namely: Evaporator, Condenser, Motor Compressor, Interconnecting Tubing, Drier and Refrigerant Charge) against defects in material or workmanship for an additional four years. These parts will be repaired or replaced at the option of Camco without charge, subject to the terms and conditions set out below.

The **DEALER** warrants for the next four years to provide the service labor necessary to repair or replace the hermetically sealed refrigeration system to the terms and conditions set out below.

## Terms and Conditions

- This warranty applies only to single family domestic use in Canada when the Refrigerator has been properly installed according to the instructions supplied by Camco and is connected to an adequate and proper utility service. Damage due to abuse, accident, commercial use, and alteration or the removal or defacing of the serial plate, cancels all obligations of this warranty. Service during this warranty must be performed by an Authorized Camco Service Agent.
- Neither Camco nor the Dealer is liable for any claims or damages resulting from any failure of the Refrigerator or from service delays beyond their reasonable control.
- To obtain warranty service, purchaser must present the original bill of sale. Components repaired or replaced are warranted through the remainder of the original warranty period only.
- This warranty does not cover expense involved in making this appliance readily accessible for servicing.
- This warranty gives you specific legal rights. Additional warranty rights may be provided by law in some areas.

*Camco Service is available coast-to-coast. See Consumer Services section for service information. If further help is needed concerning this Warranty, contact:*

*Manager, Consumer Relations, Camco Inc., Consumer Service,  
Suite 310, 1 Factory Lane, Moncton, N.B. E1C 9M3*

## Refrigerator Warranty *(For customers in the United States)*



All warranty service provided by our Factory Service Centers, or an authorized Customer Care<sup>®</sup> technician. For service, call 800-GE-CARES.

<b>For The Period Of:</b>	<b>GE Will Replace, At No Charge To You:</b>
<b>One Year</b> From the date of the original purchase	<b>Any part</b> of the refrigerator which fails due to a defect in materials or workmanship. During this <b>full one-year warranty</b> , GE will also provide, <b>free of charge</b> , all labor and in-home service to replace the defective part.
<b>Five Years</b> From the date of the original purchase	<b>Any part of the sealed refrigerating system</b> (the compressor, condenser, evaporator and all connecting tubing) which fails due to a defect in materials or workmanship. During this <b>five-year warranty</b> , GE will also provide, <b>free of charge</b> , all labor and in-home service to replace the defective part.
<b>Lifetime</b> From the date of the original purchase	<b>Any see-through pan or drawer made from Lexan<sup>®</sup> polycarbonate resin</b> furnished with the refrigerator if the pan or drawer breaks during normal household use. Drawer covers are not included.

### What GE Will Not Cover:

- Service trips to your home to teach you how to use the product.
- Improper installation.
- Failure of the product if it is abused, misused, or used for other than the intended purpose or used commercially.
- Loss of food due to spoilage.
- Replacement of house fuses or resetting of circuit breakers.
- Damage to the product caused by accident, fire, floods or acts of God.
- Incidental or consequential damage to personal property caused by possible defects with this appliance.

*This warranty is extended to the original purchaser and any succeeding owner for products purchased for home use within the USA. In Alaska, the warranty excludes the cost of shipping or service calls to your home.*

*Some states do not allow the exclusion or limitation of incidental or consequential damages. This warranty gives you specific legal rights, and you may also have other rights which vary from state to state. To know what your legal rights are, consult your local or state consumer affairs office or your state's Attorney General.*

**Warrantor: General Electric Company, Louisville, KY 40225**

## Service Telephone Numbers.



### GE Answer Center® In the U.S.: 800.626.2000

The GE Answer Center® is open 24 hours a day, 7 days a week. **In Canada**, contact: Manager, Consumer Relations, Camco Inc., Suite 310, 1 Factory Lane, Moncton, N.B. E1C 9M3.



### In-Home Repair Service In the U.S.: 800-432-2737

Expert GE repair service is only a phone call away. **In Canada**, call 1-800-361-3400.



### Special Needs Service In the U.S.: 800.626.2000

GE offers, free of charge, a brochure to assist in planning a barrier-free kitchen for persons with limited mobility. **In the U.S.**, call 800-TDD-GEAC (800-833-4322). **In Canada**, contact: Manager, Consumer Relations, Camco Inc., Suite 310, 1 Factory Lane, Moncton, N.B. E1C 9M3.



### Service Contracts In the U.S.: 800-626-2224

Purchase a GE service contract while your warranty is still in effect and you'll receive a substantial discount. GE Consumer Service will still be there after your warranty expires. **In Canada**, call 1-800-461-3636.

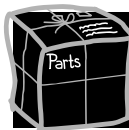

### Parts and Accessories In the U.S.: 800-626-2002

Individuals qualified to service their own appliances can have parts or accessories sent directly to their homes (VISA, MasterCard and Discover cards are accepted). **Instructions contained in this manual cover procedures to be performed by any user. Other servicing generally should be referred to qualified service personnel. Caution must be exercised, since improper servicing may cause unsafe operation.**

Customers **in Canada** should consult the local telephone directory for the nearest Camco service center, or call 1-800-361-3400.



### Service Satisfaction

If you are not satisfied with the service you receive from GE: **First**, contact the people who serviced your appliance. **Next**, if you are still not pleased, **in the U.S.**, write all the details—including your phone number—to: Manager, Consumer Relations, GE Appliances, Appliance Park, Louisville, KY 40225; or, **in Canada**, to Director, Consumer Relations, Camco Inc., Suite 310, 1 Factory Lane, Moncton, N.B. E1C 9M3. **Finally**, if your problem is still not resolved, write Major Appliance Consumer Action Program, 20 North Wacker Drive, Chicago, IL 60606 (U.S. only).