



EN ELECTRIC RANGE WITH INDUCTION COOKTOP

USE AND CARE GUIDE



Electrolux

Table of contents

Finding information	2
Important safety instructions	3-6
Grounding instructions	7
Features	8-11
• Your range features.....	8
• Induction cooktop features	8
• Oven control Pad Functions	9-11
Getting Started	12-13
• Setting clock at power up	12
• Control panel display modes	12
• Temperature visual display.....	12
• Oven light	12
• Control lock	13
• Setting the kitchen timers	13
Surface cooking	14-16
• About the ceramic glass cooktop	14
• Use the correct cookware type.....	14
• Minimum pan size requirements	14
• Cookware recommendations.....	15
• Use quality cookware in good condition	16
Setting Surface Controls	17-18
• Setting the cooktop.....	17
• Available cooktop settings.....	17
• Setting cooktop elements	17
• Hot element (HE) message	17
• Suggested cooktop power settings	18
• Setting power boost feature	18
• Operation noises	18
Setting the Lower Oven	19
Before setting the oven controls	20-21
• Air circulation in the oven	20
• Oven vents location.....	20
• Oven racks position.....	20
• Oven racks	20-21
Regular rack	20
Glide rack.....	21
Setting Oven Controls	22-35
• Baking	22
• Cook time	23
• End time	23
• Convection baking.....	24
• Convection convert.....	25
• Rapid preheat.....	25
• Convection roasting.....	26
• Broiling	27
• Convection broiling.....	28
• Keep warm	29
• Slow cook	29
• Dehydrating.....	30
• Defrosting	30
• Bread proofing.....	31
• Perfect turkey	31
• Temperature probe	32
• Multi stage	33
• My favorite.....	34
• Sabbath feature.....	35
Setting your preferences	36-38
Setting self-clean cycle	39-40
Care & Cleaning	41-46
Solutions to Common Problems	47-50
Baking Problems	47
Solutions	48-50
Warranty Information	51

Please read & save this guide

Thank you for choosing Electrolux, the new premium brand in home appliances. This *Use & Care Guide* is part of our commitment to customer satisfaction and product quality throughout the service life of your new appliance.

We view your purchase as the beginning of a relationship. To ensure our ability to continue serving you, please use this page to record important product information.

Keep a record for quick reference

Purchase date

Electrolux model number

Electrolux serial number

Serial plate location

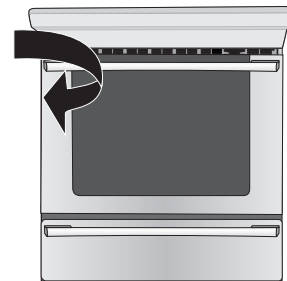

NOTE

Registering your product with Electrolux enhances our ability to serve you. You can register online at www.electroluxappliances.com or by dropping your Product Registration Card in the mail.

Questions?

For toll-free telephone support in the U.S. and Canada:

1-877-4ELECTROLUX (1-877-435-3287)

For online support and Internet production information visit <http://www.electroluxappliances.com>

READ ALL INSTRUCTIONS BEFORE USING THIS APPLIANCE.

This manual contains important safety symbols and instructions. Please pay attention to these symbols and follow all instructions given.

Do not attempt to install or operate your appliance until you have read the safety precautions in this manual. Safety items throughout this manual are labeled with a WARNING or CAUTION statement based on the risk type.

Warnings and important instructions appearing in this guide are not meant to cover all possible conditions and situations that may occur. Common sense, caution, and care must be exercised with installing, maintaining, or operating your appliance.

DEFINITIONS



This is the safety alert symbol. It is used to alert you to potential personal injury hazards. Obey all safety messages that follow this symbol to avoid possible injury or death.

WARNING

Indicates a potentially hazardous situation which, if not avoided, may result in death or serious injury.

CAUTION

Indicates a potentially hazardous situation which, if not avoided, may result in minor or moderate injury.

IMPORTANT

Indicates installation, operation, maintenance, or valuable information that is not hazard related.

NOTE

Indicates a short, informal reference – something written down to assist the memory or for future reference.



WARNING



Tip Over Hazard

- A child or adult can tip the range and be killed.
- Verify the anti-tip device has been installed to floor or wall.
- Ensure the anti-tip device is re-engaged to floor or wall when the range is moved.
- Do not operate the range without the anti-tip device in place and engaged.
- Failure to follow these instructions can result in death or serious burns to children and adults.

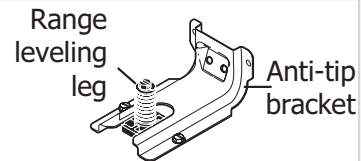

To check if the anti-tip bracket is installed properly, use both arms to grasp the rear edge of the range back. Carefully attempt to tilt range forward. When properly installed, the range should not tilt forward.

Refer to the anti-tip bracket installation instructions supplied with your range for proper installation.

IMPORTANT INSTRUCTIONS FOR UNPACKING AND INSTALLATION

IMPORTANT - Read and follow the below instructions and precautions for unpacking, installing, and servicing your appliance:

Remove all tape and packaging before using the appliance. Destroy the carton and plastic bags after unpacking the appliance. Never allow children to play with packaging material. Do not remove the wiring label and other literature attached to the appliance. Do not remove model/serial number plate.

Cold temperatures can damage the electronic control. When using this appliance for the first time, or when the appliance has not been used for an extended period

4 Important Safety Instructions

Cold temperatures can damage the electronic control. When using this appliance for the first time, or when the appliance has not been used for an extended period of time, be sure the appliance has been in temperatures above 32°F (0°C) for at least 3 hours before turning on the power to the appliance.

Never modify or alter the construction of the appliance by removing the leveling legs, panels, wire covers, anti-tip brackets/screws, or any other part of the appliance.

Be sure to have an appropriate foam-type fire extinguisher available, visible, and easily accessible located near the appliance.

GROUNDING INSTRUCTIONS

WARNING

Avoid fire hazard or electrical shock. Failure to follow this warning may cause serious injury, fire, or death.

Do not use an adapter plug, use an extension cord, or remove grounding prong from the power cord. Failure to follow this warning may cause serious injury, fire, or death.

Proper Installation—Be sure your appliance is properly installed and grounded by a qualified technician. In the United States, install in accordance with the National Fuel Gas Code ANSI Z223.1/ NFPA No. 54, latest edition and National Electrical Code NFPA No. 70 latest edition, and local electrical code requirements. In Canada, install in accordance with CAN/CGA B149.1 and CAN/CGA B149.2 and CSA Standard C22.1, Canadian Electrical code, Part 1-latest editions and local electrical code requirements. Install only per installation instructions provided in the literature package for this appliance.

For personal safety, this appliance must be properly grounded. For maximum safety, the power cord must be securely connected to an electrical outlet or junction box that is the correct voltage, is correctly polarized and properly grounded, and protected by a circuit breaker in accordance with local codes.

It is the personal responsibility of the consumer to have the appropriate outlet or junction box with the correct, properly grounded wall receptacle installed by a qualified electrician. It is the responsibility and obligation of the consumer to contact a qualified installer to assure that the electrical installation is adequate and is in conformance with all local codes and ordinances.

See the installation instructions packaged with this appliance for complete installation and grounding instructions.

IMPORTANT INSTRUCTIONS FOR USING THE APPLIANCE

WARNING

Storage In or On Appliance—Flammable materials should not be stored in an oven or microwave, near surface burners or elements, or in the storage or warmer drawer (if equipped). This includes paper, plastic, and cloth items, such as cookbooks, plastic ware, and towels, as well as flammable liquids. Do not store explosives, such as aerosol cans, on or near the appliance.

Do not leave children alone - Children should not be left alone or unattended in the area where appliance is in use. They should never be allowed to sit or stand on any part of the appliance, including the storage drawer, lower broiler drawer, warmer drawer, or lower double oven.

WARNING

Do not store items of interest to children in the cabinets above the appliance or on the backguards of ranges. Children climbing on or near the appliance to reach items could be seriously injured.

Do not allow children to climb or play around the appliance. The weight of a child on an open oven door may cause the appliance to tip, resulting in serious burns or other injury. An open drawer when hot may cause burns.

Stepping, leaning, or sitting on the door or drawers of this appliance can result in serious injuries and also cause damage to the appliance.

Never cover any slots, holes or passages in the oven bottom or cover and entire rack with materials such as aluminum foil. Doing so blocks air flow through the oven and may cause carbon monoxide poisoning. Aluminum foil linings may also trap heat, causing a fire hazard.

Do not use oven or warmer drawer (if equipped) for storage.

Never use your appliance as a space heater to heat or warm the room. Doing so may result in carbon monoxide poisoning and overheating of the appliance.

CAUTION

When heating fat or grease, watch it closely. Grease may catch fire if it becomes too hot.

Do not use water or flour on grease fires. Smother fire or flame or use dry chemical or foam-type extinguisher. Cover the fire with a pan lid or use baking soda.

CAUTION

Use dry potholders. Moist or damp potholders on hot surfaces may result in burns from steam. Do not let potholders touch hot cooking areas. Do not use towels or other bulky cloths.

Do not heat unopened food containers - Build-up of pressure may cause container to burst and result in injury.

Wear proper apparel - Loose-fitting or hanging garments should never be worn while using the appliance. Do not let clothing or other flammable materials contact hot surfaces.

Do not touch surface burners or elements, areas near these burners or elements, interior surfaces of the oven, or the warmer drawer (if equipped). Surface burners and elements may be hot even though they appear cool. Areas near surface burners and elements may become hot enough to cause burns. During and after use, do not touch, or let clothing or other flammable materials touch these areas until they are cool. These areas may include the cooktop, surfaces facing the cooktop, oven vent areas, oven door, and oven window.

Do not attempt to operate the appliance during a power failure. If the power fails, always turn off the appliance. If the appliance is not turned off and the power resumes, electric surface elements may resume operation when power is restored. Once the power resumes, reset the clock and the oven function.

6 Important Safety Instructions

IMPORTANT INSTRUCTIONS FOR USING YOUR INDUCTION COOKTOP

CAUTION

Persons with a pacemaker or similar medical device should exercise caution using or standing near an induction unit while it is in operation, as the electromagnetic field may affect the working of the pacemaker or similar medical device. It would be advisable to consult your doctor or the pacemaker or similar medical device manufacturer about your particular situation.

Know which knob or key controls each surface heating area. Place cookware with food on the cooking area before turning it on. Turn the cooking area off before removing the cookware.

Cookware handles should be turned inward and not extend over adjacent surface elements. — To reduce the risk of burns, ignition of flammable materials, and spillage due to unintentional contact with the utensil, the handle of the cookware should be positioned so that it is turned inward, and does not extend over other cooking areas.

Glazed cooking utensils — Only certain types of cookware are suitable for cooktop service and must be magnetic to work properly on the induction zones. Check the manufacturer's recommendations for cooktop use to ensure that the cookware is compatible with induction cooking.

Improper cookware may break due to sudden changes in temperature. Check the cookware manufacturer's recommendations for cooktop use.

Use proper pan size - This appliance is equipped with one or more surface units of different sizes. Select cookware with flat bottoms that match the surface unit size.

Using the proper cookware on the cooking area will improve efficiency.

Never leave surface elements unattended. Boil-overs may cause smoking and greasy spills that may ignite. A pan that has boiled dry could be damaged and may damage the cooktop.

When you are flaming foods under a ventilating hood, turn on the fan.

IMPORTANT INSTRUCTIONS FOR GLASS AND CERAMIC COOKTOPS

Do Not Clean or Operate a Broken Cooktop. If cooktop should break, cleaning solutions and spillovers may penetrate the broken cooktop and create a risk of electric shock. Contact a qualified technician immediately.

Clean cooktop glass with caution. If a wet sponge or cloth is used to wipe spills on a hot cooking area, be careful to avoid a steam burn. Some cleaners can produce harmful fumes if applied to a hot surface.

Avoid scratching the cooktop glass with sharp objects.

IMPORTANT INSTRUCTIONS FOR USING YOUR OVEN

Protective liners—Do not use aluminum foil, aftermarket oven liners, or any other materials or devices to line oven bottom, oven racks, or any other part of the appliance. Only use aluminum as recommended for baking, such as lining cookware or as a cover placed on food. Any other use of protective liners or aluminum foil may result in a risk of electric shock or fire or a short circuit.

Use care when opening oven door, lower oven door, or warmer drawer (some models). Stand to the side of the appliance when opening the door of a hot oven. Let hot air or steam escape before you remove or replace food in the oven.

Keep oven vent ducts unobstructed. Touching surfaces in this area when the oven is on may cause severe burns. Do not place plastic or heat-sensitive items on or near the oven vent. These items can melt or ignite.

Placement of oven racks - Always place oven racks in desired location while oven is cool. If rack must be moved while oven is hot, do not let potholder contact hot burner or element in oven. Use potholders and grasp the rack with both hands to reposition. Remove all cookware and utensils before moving the rack.

Do not use a broiler pan without its insert. Broiler pans and inserts allow dripping fat to drain away from the high heat of the broiler. Do not cover the broiler insert with aluminum foil; exposed fat and grease could ignite.

Do not cook food on the oven bottom. Always cook in proper cookware and always use the oven racks.

IMPORTANT INSTRUCTIONS FOR CLEANING YOUR APPLIANCE

CAUTION

Before manually cleaning any part of the appliance, be sure all controls are turned off and the appliance is cool. Cleaning a hot appliance can cause burns.

Clean the appliance regularly to keep all parts free of grease that could catch fire. Do not allow grease to accumulate. Greasy deposits in the fan could catch fire.

Always follow the manufacturer's recommended directions for use of kitchen cleaners and aerosols. Be aware that excess residue from cleaners and aerosols may ignite causing damage and injury.

Clean ventilating hoods frequently - Grease should not be allowed to accumulate on hood or filter. Follow the manufacturer's instructions for cleaning vent hoods

IMPORTANT INSTRUCTIONS FOR SELF CLEANING OVENS

Do not clean the oven door gasket. The door gasket is essential for a good seal. Care should be taken not to rub, damage, or move the gasket.

Do not use oven cleaners. No commercial oven cleaner or oven liner protective coating of any kind should be used in or around any part of the appliance.

Use the self clean cycle to clean only the parts listed in this manual.

Before using self clean, remove the broiler pan, any food, utensils, and cookware from the oven, storage drawer or warming drawer (if equipped). Remove oven racks unless otherwise instructed.

Some birds are extremely sensitive to the fumes given off during the self clean cycle of any oven. Move birds to another well-ventilated room.

8 Important Safety Instructions

IMPORTANT INSTRUCTIONS FOR SERVICE AND MAINTENANCE

Do not repair or replace any part of the appliance unless specifically recommended in the manuals. All other servicing should be done only by a qualified technician. This reduces the risk of personal injury and damage to the appliance.

Always contact your dealer, distributor, service agent, or manufacturer about problems or conditions you do not understand.

Ask your dealer to recommend a qualified technician and an authorized repair service. Know how to disconnect the power to the appliance at the circuit breaker or fuse box in case of an emergency.

Remove the oven door from any unused oven if it is to be stored or discarded.

Do not touch a hot oven light bulb with a damp cloth. Doing so could cause the bulb to break. Handle halogen lights (if equipped) with paper towels or soft gloves. Disconnect the appliance or shut off the power to the appliance before removing and replacing the bulb.

Important Safety Notice - The California Safe Drinking Water and Toxic Enforcement Act requires the governor of California to publish a list of substances known to cause cancer, birth defects, or other reproductive harms, and requires businesses to warn customers of potential exposures to such substances.

Important: This appliance has been tested and found to comply with the limits for a class B digital device, pursuant to Part 18 of the FCC rules (United States) and ICES-001 (Canada). These limits are designed to provide reasonable protection against harmful interference in a residential installation. This unit uses and can radiate radio frequency energy and, if not installed and used in accordance with the instructions, may cause harmful interference to radio communications. However there is no guarantee that interference will not occur in a particular installation. If this unit does cause harmful interference to radio or television reception, which can be determined by turning the unit off and on, the user is encouraged to try to correct the interference by one or more of the following measures:

- Reorient or relocate the receiving antenna.
 - Increase distance between unit and receiver.
 - Connect the unit into an outlet or a circuit different from that to which the receiver is connected.
-

Oven control pad functions

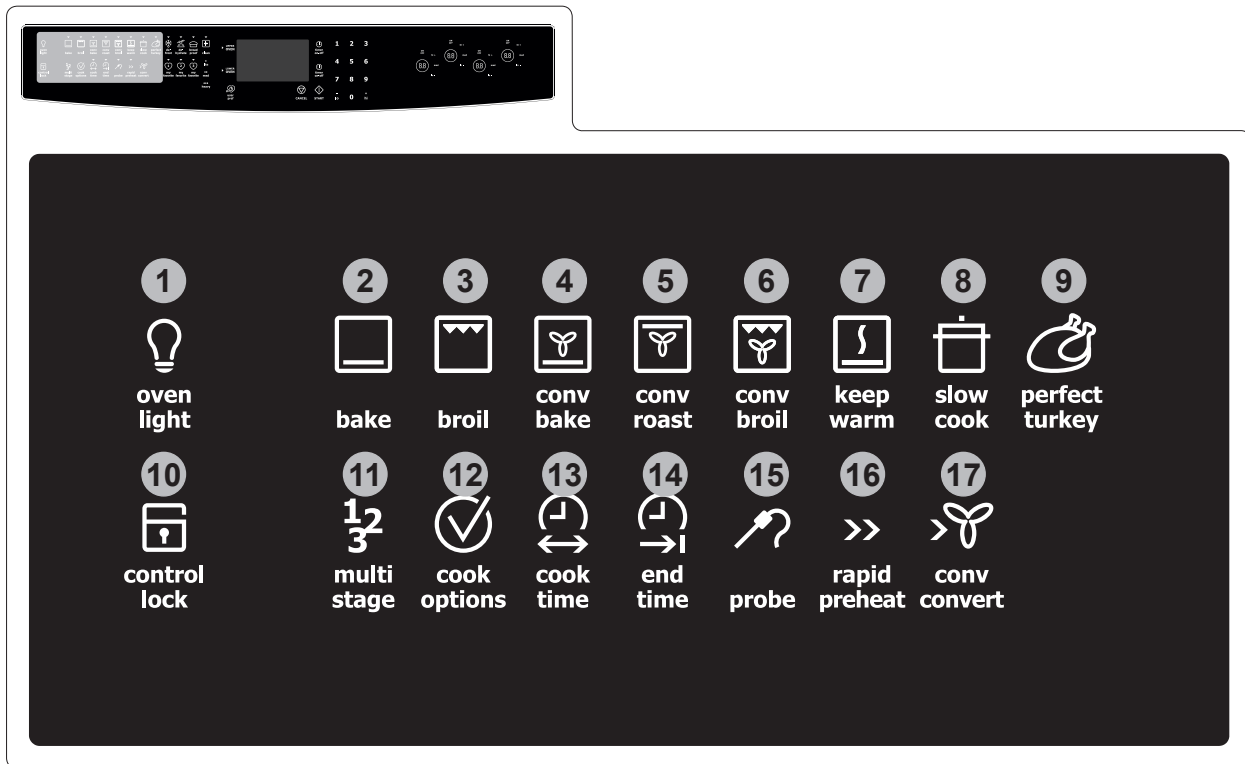

- 1. Light Pad-** Used to turn the oven light on and off.
- 2. Bake Pad-** Used to enter the normal baking mode temperature.
- 3. Broil Pad-** Used to select the variable broil mode.
- 4. Convection Bake Pad-** Used to select the convection baking mode.
- 5. Convection Roast Pad-** Used to select the convection roasting mode.
- 6. Convection Broil Pad-** Used to select the convection broil mode.
- 7. Keep Warm Pad-** Used to select the keep warm mode.
- 8. Slow Cook Pad-** Used to select the slow cook mode.
- 9. Perfect Turkey Pad-** Used to select the perfect turkey cooking mode.
- 10. Control Lock Pad-** Used to disable all oven function.
- 11. Multi Stage Pad-** Used to enter up to three subsequent modes.
- 12. Cook Options Pad-** Used to light up the cooking options pads.
- 13. Cook Time Pad-** Used to set a cooking duration time.
- 14. End Time Pad-** Used to select the time at which the cooking will end.
- 15. Probe Pad-** Used to activate the meat probe mode.
- 16. Rapid Preheat Pad-** Used to preheat the oven to the desired temperature.
- 17. Convection Convert Pad-** Used to convert a standard temperature to a convection temperature.

10 Features

Oven control pad functions

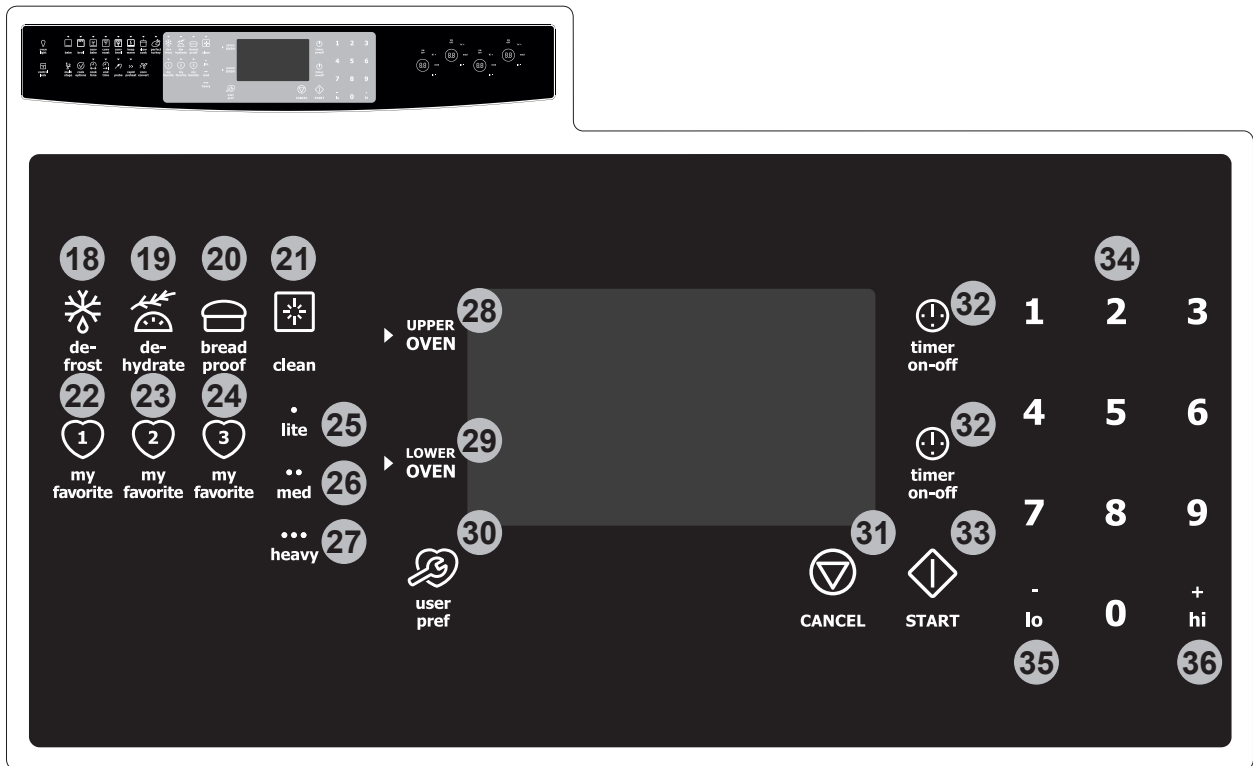

- 18. Defrost Pad-** Used to select the defrost mode.
- 19. Dehydrate Pad-** Used to select the dehydrate mode.
- 20. Bread Proof Pad-** Used to select the bread proof mode.
- 21. Clean Pad-** Used to select the self-cleaning mode.
- 22. My Favorite 1 Pad-** Used to save or recall the favorite 1 cooking mode.
- 23. My Favorite 2 Pad-** Used to save or recall the favorite 2 cooking mode.
- 24. My Favorite 3 Pad-** Used to save or recall the favorite 3 cooking mode.
- 25. Lite Pad-** Used to start a 2 hours self-clean cycle.
- 26. Med Pad-** Used to start a 3 hours self-clean cycle.
- 27. Heavy Pad-** Used to start a 4 hours self-clean cycle.
- 28. Upper Oven Pad-** Used to activate the upper oven for cooking operation.
- 29. Lower Oven Pad-** Used to activate the lower oven for cooking operation.
- 30. User Preference Pad-** Used to bring the user preference menu in the display.
- 31. Cancel Pad-** Used to cancel any function previously entered except the time of day and minute timer. Push **Cancel pad** to stop cooking.
- 32. Timer Pads-** Used to set or cancel the minute timer. The minute timer does not start or stop cooking.
- 33. Start Pad-** Used to start all oven functions.
- 34. 0 Thru 9 Number Pads-** Used to enter temperature and times.
- 35. - lo Pad-** Used to lower the temperature and times.
- 36. + hi Pad-** Used to raise the temperature and times.

Oven control pad functions

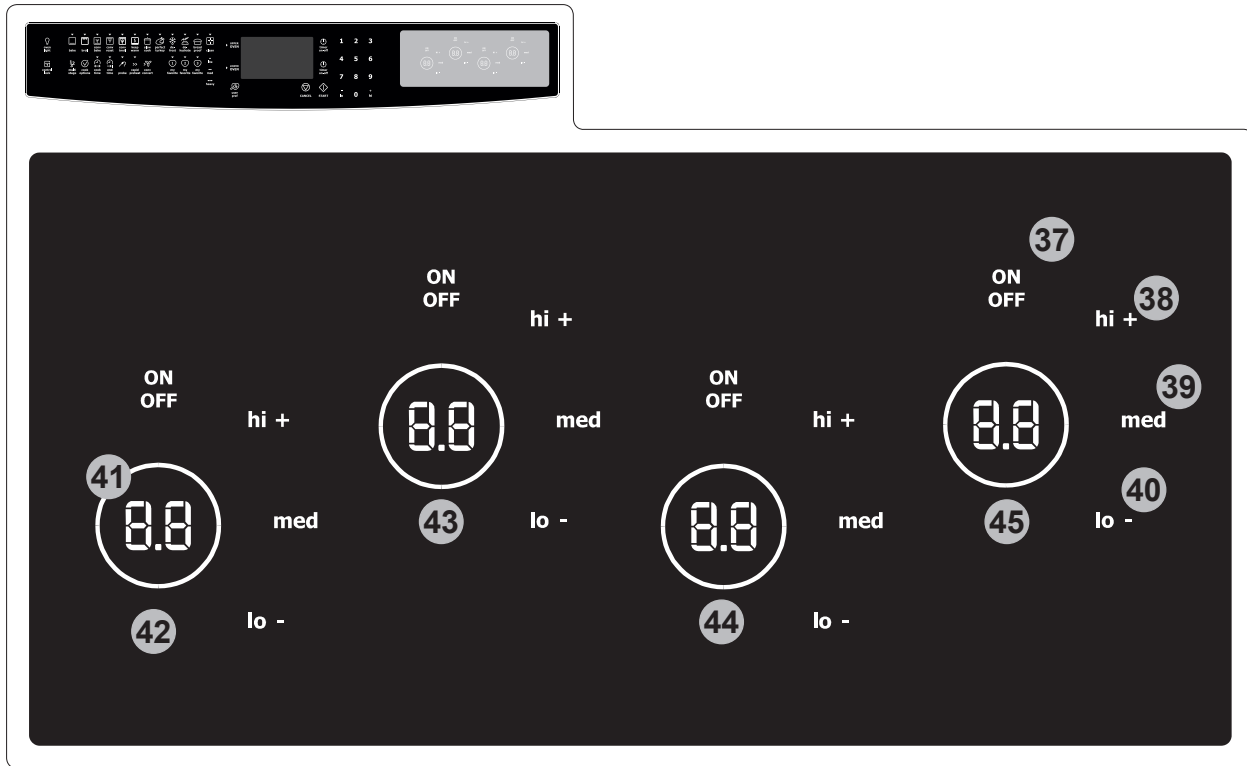

- 37. ON / OFF Pad-** Used to toggle ON and OFF the associated induction element.
- 38. HI + Pad-** Used to select the “Power Boost” temperature or raise the temperature currently displayed.
- 39. MED Pad-** Used to select the medium temperature.
- 40. LO - Pad-** Used to select the lowest temperature or lower the temperature currently displayed.
- 41. Pan Detection Indicator Ring-** Will light up when a pan made of magnetic material is placed in a cooking zone.
- 42. Left Front Zone Controls and Display-** Used to set the left front cooking zone power levels.
- 43. Left Rear Zone Controls and Display-** Used to set the left rear cooking zone power levels.
- 44. Right Front Zone Controls and Display-** Used to set the right front cooking zone power levels.
- 45. Right Rear Zone Controls and Display-** Used to set the right rear cooking zone power levels.

Setting clock at power up

When the unit is first plugged in, or when the power supply to the range has been interrupted, the timer in the display will flash with “12:00”. The clock cannot be set when the oven is on. If an invalid time of day is entered, the control will triple beep to prompt you to re-enter a valid time of day.

To set the clock (example for 1:30):

1. Press **1 3 0** pads to set the time of day to 1:30. The pads **hi** or **lo** can also be pressed to raise or lower the actual time displayed.
2. Press **START** to accept the changes or **CANCEL** to start with a time of 12:00.

Control panel display modes

Sleep Mode:

Your control will remain in a sleep mode when not in use. Only the clock will display during this mode. You will need to wake the control to begin any function.

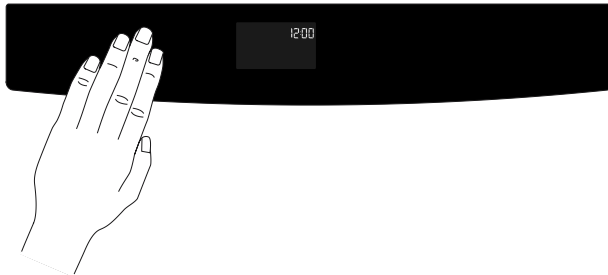

Wake Mode:

To wake the control, touch within the display panel. After 2 minutes without activity the control will chime and go back into sleep mode.

To start a cooking feature you must select either the upper oven or the lower oven. User preferences will be available during this mode as well as timers, oven light and the control lock.

Temperature visual display

Your oven is equipped with a temperature visual display for each oven. When a cooking mode is set, the actual temperature will be shown in the display and will rise as the unit preheats. When the unit has reached its target temperature, a chime will sound to remind you to place the food in the oven. This feature will be active with some cooking modes; bake, convection bake, convection roast and perfect turkey. The cooking modes which does not feature the temperature visual display will be noted in their descriptions.

NOTE: The lowest temperature that can be displayed is 100°F.

Oven light

Your appliance includes a “theater” style oven lighting feature that gradually lights both the upper and lower oven interiors to full brightness. The upper oven is equipped with 2 halogen lights and the lower oven is equipped with 1 halogen light. The oven lights will turn on automatically when the oven door is opened. The oven light may be turned on when the door is closed by using the oven light pad located on the control panel. The oven light key will toggle the lights in both ovens at the same time at full intensity.

NOTE: For best results, keep the oven light turned OFF during baking. Remember to turn the light OFF after checking food.

To toggle the Oven Lights ON and OFF:

1. Press **OVEN LIGHT** .

Control lock

The Control Lock feature automatically locks the upper oven door, control panel and the cooktop. The Control Lock is only allowed when the oven and the cooktop are turned OFF (not active). DOOR LOCK will flash in the display for 20 seconds or until the door has finished locking. Once the door has been locked, **Loc** message will appear in the upper display and “-” will appear in the cooktop displays. Do not attempt to open the oven door while DOOR LOCK is flashing.





To toggle the Control Lock ON and OFF:

1. Keep **CONTROL LOCK**  pressed for 3 seconds.

Setting the kitchen timers

This unit is equipped with 2 Kitchen Timers which serves as extra timers in the kitchen that will chime when the set time has run out. It does not start or stop cooking. The Timer feature can be used during any of the other oven control functions and cooking modes

See example below to set the timer for 5 minutes:

Example	
Step	Press
1. Press TIMER . “00:00” will appear in the display.	
2. Enter 5 minutes. The pads hi or lo can also be pressed to raise or lower the actual time displayed.	5
3. Press TIMER . to accept and start the countdown.	
4. When the set time has run out, “00:00” will be displayed and the TIMER  pad will flash. The clock will sound a chime that will be repeated at regular intervals until the TIMER  pad is pressed.	

To cancel the Timer before the set time has run out:

Press **TIMER** . The display will return to the time of day.

NOTE

The timer(s) will not affect the cooking process.

14 Surface Cooking

About the ceramic glass cooktop

The ceramic cooktop has inductor elements located below the surface of the glass. The design of the ceramic cooktop outlines the area of the inductor element underneath. **Make sure** the diameter of the pan matches the size of the element outline on the cooktop. Only flat-bottom cookware should be used. Heat may be transferred from the cookware to the ceramic glass and the areas surrounding the elements may become **hot enough to cause burns**. The type and size of cookware, the number of inductor elements in use and the settings, are all factors that will affect the amount of heat that will spread to areas beyond the surface elements

Use the correct cookware type

The magnetic Cooking Zone sensors located below the cooktop surface require the use of cookware made with magnetic material in order to start the heating process on any of the Cooking Zones.

When purchasing pans, look for cookware specifically identified by the manufacturer for use with Induction cooktops. If you are not sure, use a magnet to test whether the cookware type will work. If a magnet sticks to the bottom of the cookware, the material type is correct for Induction cooking.

It is recommended to always use heavier high quality stainless steel cookware on your Induction Cooktop surface. This will greatly reduce the possibility of developing scratches on the ceramic surface.

Even quality cookware can scratch the cooktop surface, especially if cookware is slid over the ceramic cooktop surface without being lifted up. Over time sliding **ANY** type of cookware over the ceramic cooktop will likely alter the overall appearance of the cooktop. Eventually the buildup of scratches will make cleaning the surface difficult and degrade the overall appearance of the cooktop.

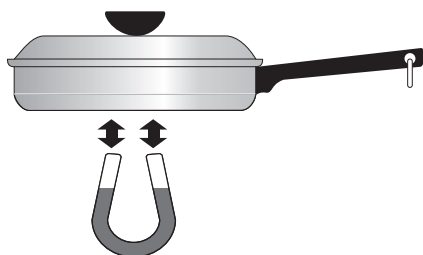

Minimum pan size requirements

USE THE CORRECT SIZE COOKWARE - The Cooking Zones available on the Induction Cooktop require a **MINIMUM** pan size to be used at each location. The shorter marking of each Cooking Zone is your guide to the correct **MINIMUM** pan size. The pan bottom must **FULLY** cover the inner ring for proper cooking to occur.

The longer marking at each Cooking Zone is helpful to determine the pan **MAXIMUM** size. After centering the cookware on the cooktop, make sure the cookware does not extend more than 1/2" beyond the longer marking on the Cooking Zone. The pan must make **FULL** contact on the glass surface without the bottom of the pan touching the metal cooktop trims.

NOTE: If a pan made of the correct material is centered properly on any of the active Cooking Zones but is **TOO SMALL**, the circle around the digital part of the display will stay off and the pan will not heat.

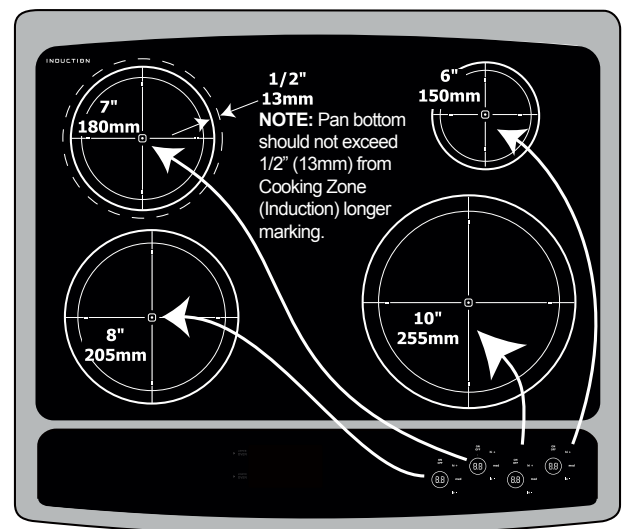

Cookware recommendations

INCORRECT

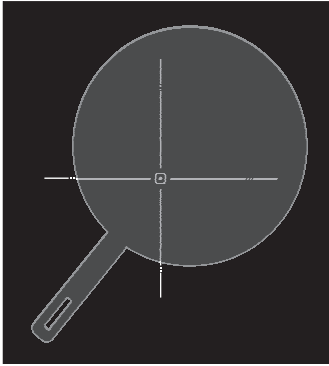

- Cookware not centered on Cooking Zone surface.

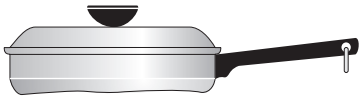

- Curved or warped pan bottoms or sides.

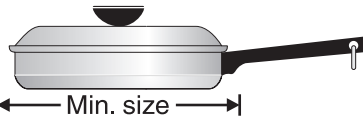

- Pan does not meet the minimum size required for the Cooking Zone used.



- Pan bottom rests on cooktop trim or does not rest completely on the cooktop surface.



- Heavy handle tilts pan.

CORRECT

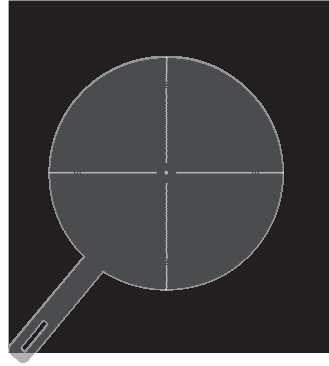

- Cookware centered correctly on Cooking Zone surface.

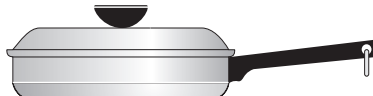

- Flat pan bottom & straight sides.

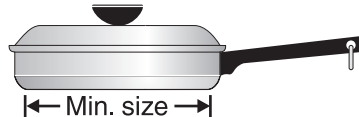

- Pan size meets or exceeds the recommended minimum size for the Cooking Zone.

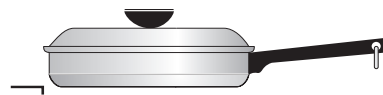

- Pan rests completely on the Cooktop surface.



- Pan is properly balanced.

Fig. 1

PLEASE NOTE- ANY one of the incorrect conditions listed above in Fig. 1 may be detected by the sensors located below the ceramic cooktop surface. If the cookware does not meet any of these conditions, one or more of the Cooking Zones will not heat indicated by the turned off circle surrounding the digital display for that affected zone. Correct the problems before attempting to reactivate the cooktop.

16 Surface Cooking

Use quality cookware in good condition

The cookware used with the Induction Cooktop should have flat bottoms that make good contact with the entire surface of the Cooking Zone. Check for flatness by rotating a ruler across the bottom of the cookware (See Fig. 1). Be sure to follow all the recommendations for using cookware.

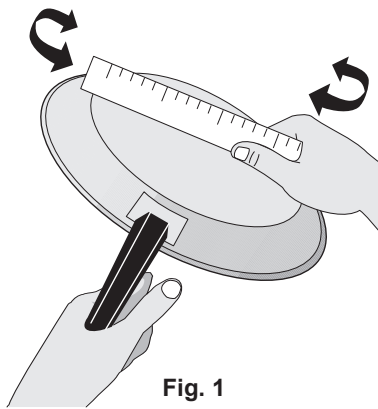

Fig. 1

Also remember to:

- Use cookware made with the correct material type for Induction Cooking.
- Use quality cookware with heavier bottoms for better heat distribution allowing for more even cooking results.
- The pan size should match the amount of food being prepared.
- **Do not let pans boil dry.** This may cause permanent damage in the form of breakage, fusion, or marring that can affect the ceramic cooktop. (This type of damage is not covered by your warranty).
- Do not use dirty pans with grease buildup. Always use pans that are easy to clean after cooking.
- Do not straddle cookware between two cooking zones, unless that cookware is designed for this purpose, such as a griddle.

Prior to using your cooktop for the first time, apply the recommended cooktop cleaning creme to the ceramic surface. Buff with a non-abrasive cloth or pad. This will make cleaning easier when soiled from cooking. The special cooktop cleaning cream leaves a protective finish on the glass to help prevent scratches and abrasions.

CAUTION

The Cooking Zones may appear to be cool while turned ON and after they have been turned OFF. **The glass surface may be HOT** from residual heat transferred from the cookware and burns may occur.

DO NOT TOUCH HOT COOKWARE or PANS directly with hands. Always use oven mitts or pot holders to protect hands from burns.

DO NOT SLIDE Cookware across the cooktop surface. Doing so may permanently damage the appearance of the ceramic cooktop.

Home Canning

Be sure to read and observe all the following points when home canning with your appliance. Check with the United States Department of Agriculture (USDA) website and be sure to read all the information they have available as well as follow their recommendations for home canning procedures.

- Use only quality flat bottom canners when home canning. Use a straight-edge to check canner bottom (see See “Use quality cookware in good condition”).
- Use only a completely flat bottom canner with no ridges that radiate from the bottom center when home canning using a range with a ceramic glass cooktop.
- Make sure the diameter of the canner does not exceed 1 inch beyond the cooking zone markings.
- It is recommended to use smaller diameter canners on ranges with ceramic glass or open coil electric cooktops.
- Start with hot tap water to bring water to boil more quickly.
- Use the highest heat setting when first bringing the water to a boil. Once boiling is achieved, reduce heat to lowest possible setting to maintain that boil.

IMPORTANT! Never place or straddle cookware over two different surface cooking zones heating at the same time. This will cause uneven heating results and could cause the ceramic cooktop to fracture. The only exception is when using large cookware or the griddle with the bridge elements activated.

Setting the cooktop

The cooktop control provides 4 digital display windows to help set power levels for the heating zones located on the cooktop. These settings work the same way as normal knob settings except the settings are displayed in LCD style displays.

Available cooktop settings

Your control provides 23 different settings for each cooking zone. Some of these power levels include **Lo** (1%) *Fig. 1*, **5.0** (medium 50%) *Fig. 2*, **Hi** (100%) *Fig. 3*, **Pb** (Power Boost) *Fig. 4*.

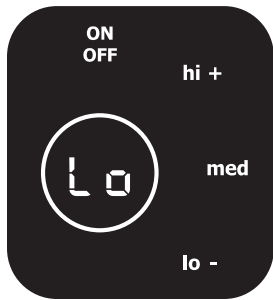

Fig. 1



Fig. 2

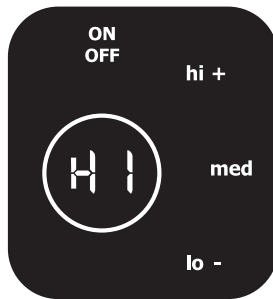

Fig. 3

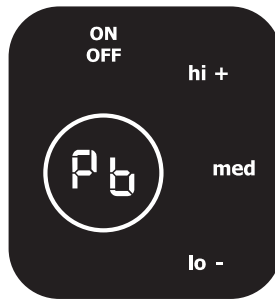

Fig. 4

- The **ON OFF** key pad is used to power-up or power-off the cooking zone.
- The **hi+** key pad is used to set the cooking zone at Power Boost (Fig. 4) when used after the **ON OFF** key is pressed. It can also be used during cooking to raise the power setting.
- The **med** key pad is used to set the cooking zone at 5.0 (Fig. 2).
- The **lo-** key pad is used to set the cooking zone at Lo (Fig. 1) if used after the **ON OFF** key pad. It can also be used at any moment to lower the power setting of the cooking zone.

The **hi+** and **lo-** keys provide incremental adjustments for more precise control when changing settings between the lower heat levels (Lo to 3.0 power levels). Higher heat level setting changes (between 3.0 to Hi) will change much faster.

Display Settings Changes	
Setting / Power	Incremental change
Lo to 3.0 (1-30%)	0.2
3.0 to 7.0 (30-70%)	0.5
7.0 to Hi (70-100%)	1.0

Setting cooktop elements

- If needed, wake the control panel.
- Touch the **ON OFF** key for the desired heating zone.
- Press the desired power level key (**hi+**, **med** or **lo-**) or for more precise level settings use the **hi+** or **lo-** keys to make specific level changes.

Hot element (HE) message

After using any of the induction heating zones, the ceramic cooktop will become very hot from heat transferred by the cookware. Even after turning the control off, the cooktop will remain hot for some time.

The cooktop control monitors the temperature of the cooktop surface and displays a message "HE" (hot element) when the cooktop is still too hot to touch -*Fig. 5*-. If the **HE** message remains displayed in the LCD, the heating zone may be set again and used for cooking.

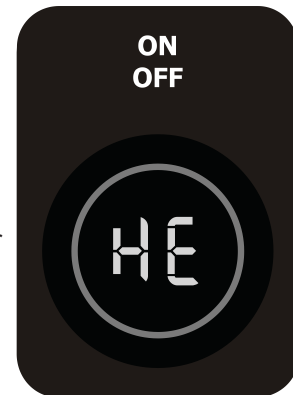

Fig. 5

18 Setting Surface Controls

Suggested cooktop power settings

Use the chart below to determine the suggested setting for the type of food you are preparing when using the cooktop.

Recommended surface setting chart	
Setting	Type of Cooking
POWER BOOST (Pb)	Start most foods; bring water to a boil and pan broiling.
HIGH (8-HI)	Continue a rapid boil; frying, deep fat frying.
MEDIUM (6)	Maintain a slow boil; thicken sauces and gravies; steaming vegetables..
MEDIUM LOW (4- 5)	Keep foods cooking; poaching and stewing.
LOW (Lo-3)	Keep warm, melting and simmering.

CAUTION

Heat may be transferred from the cookware to the ceramic glass and the areas surrounding the elements may become **hot enough to cause burns**. **The Hot Element Message Light will turn ON and will continue to glow until the glass cooktop has cooled down to a moderate level. The glass surface may still be hot and burns may occur if the glass surface is touched before the indicator light has turned OFF.**

Do not place plastic items such as salt and pepper shakers, spoon holders or plastic wrappings on top of the range when it is in use. These items could melt or ignite. Potholders, towels or wooden spoons could catch fire if placed too close to the surface elements.

Setting power boost feature

Your induction cooktop is equipped with a Power Boost feature on each cooking zone. The Power Boost feature is used to bring large quantities of water or food to cooking temperature at the fastest speed possible. The Power Boost feature will give you up to 139% power output for a maximum of 10 minutes.

To Turn ON the Power Boost Feature:

- Press the **ON OFF** pad to turn on the cooking zone you want to set to Power Boost.
- Press the **“hi +”** key pad and the **PB** will be shown in the display (figure 1).

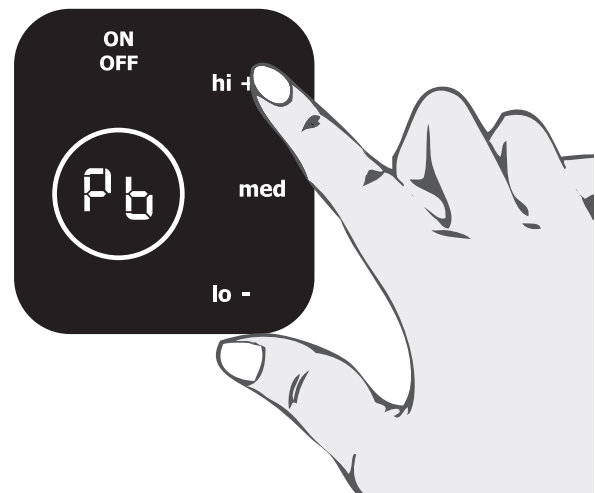

Figure 1

To set the Power Boost, press **hi +** when the zone is first turned on.

Operational noises

The electronic processes involved with Induction Cooking create some unusual background noises. These noises are normal and part of the Induction Cooking process.

Please note that these noises are more noticeable while cooking at the Power BOOST level. Very loud noises are not part of normal Induction Cooking.

Lower oven operation

The lower oven provides three basic modes, baking, slow cooking and warming. The lower oven is ideal for cooking foods such as pizza, casseroles, baked potatoes and frozen convenience foods. Use the keep warm feature to keep hot cooked foods at serving temperature. The lower oven can only be used with some cooking modes; Bake, Slow Cook and Keep Warm (read their sections for precise instructions).

WARNING

KEEP CHILDREN AWAY FROM THE LOWER OVEN WHEN HOT. FAILURE TO DO SO CAN RESULT IN BURNS.

CAUTION

Always use oven mitts when removing food from the lower oven. The lower oven rack, compartment, cookware/plates may be hot.

Lower Oven Tips:

- The lower oven rack must always be in place when cooking or warming. Be sure that the rack is placed with the down turned sides into the drawer. This will provide for some air space between the drawer and the food.
- When placing food in the lower oven always use a baking sheet or pan with 4 raised sides to prevent food from sliding off.
- **DO NOT LINE THE OVEN DRAWER WITH FOIL OR COVER THE OVEN RACK WITH FOIL.** This may result in damage to your oven.
- The maximum height of foods and utensils that may be used in the lower oven is 4". The maximum width is 15". **Pay close attention to foods that have potential to rise beyond the recommended 4" maximum height.**
- Use pans in the lower oven large enough to contain food and any juices created from the cooking process.

- **Do not use plastic wrap to cover food. Plastic may melt onto the drawer or surrounding areas and be very difficult to clean.** Use a lid or aluminum foil instead. Use only utensils and cookware in the oven drawer that are recommended for oven use in the upper oven.
- When using the lower oven, limit the number of times the drawer is opened; this will minimize heat loss. Repeated opening of the drawer during the cooking process may increase cooking times and produce uneven cooking results. The cooking times for the lower oven may vary slightly from the upper oven.

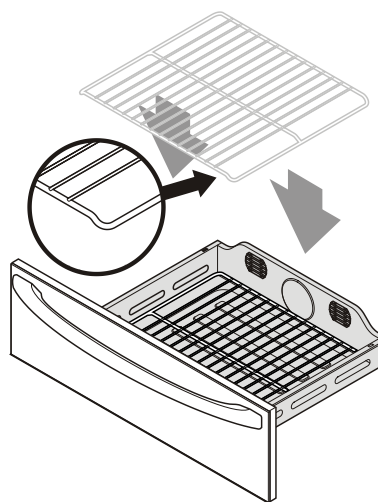

NOTE: The lower oven will not operate when the upper oven is set for self-cleaning or if the control lockout feature is active.

WARNING

Should an oven fire occur, close the drawer and turn the lower oven OFF. If the fire continues, use a fire extinguisher. **DO NOT** put water or flour on the fire. Flour may be explosive.

Air circulation in the oven

For best air circulation and baking results allow 2-4" (5-10 cm) around the cookware for proper air circulation and be sure pans and cookware do not touch each other, the oven door, sides or back of the oven cavity. The hot air must circulate around the pans and cookware in the oven for even heat to reach around the food.

NOTE

Always use caution when removing food from the oven.

Oven vents location

The oven is vented **above the door**. When the oven is on, warm air is released through the vents. This venting is necessary for proper air circulation in the oven and good baking results. Steam and moisture may appear near the oven vent. This is normal.

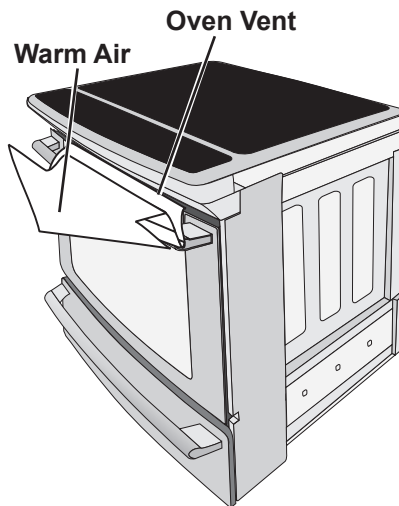

Oven rack positions

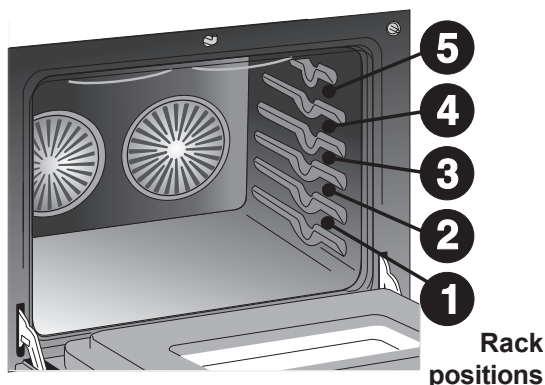

Oven racks

Regular rack

This model comes with lubricated porcelain oven racks, which can remain in the oven during the self-clean cycle. Do not clean this vegetable oil lubrication off the racks. It is important that the sides of the oven racks always have a light coating of vegetable oil. To maintain optimal rack performance, re-apply a thin layer of vegetable oil to the sides of the rack after every self-clean cycle or when the rack becomes difficult to slide.

CAUTION

Always use **potholders** or **oven mitts** when removing food or adjusting the oven racks. Wait until the oven has completely cooled if possible. Oven racks may be **HOT** and may cause burns.

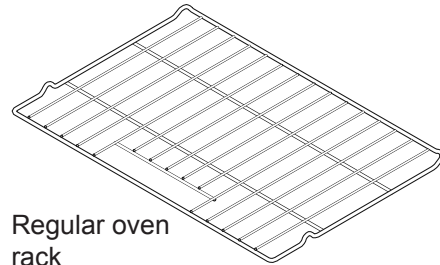

Regular oven rack

The **regular** oven rack may be used in all of the rack position.

Removing, replacing, and arranging flat or offset oven racks

- **To arrange** - Always arrange the oven racks when the oven is cool (prior to operating the oven).
- **To remove** - Pull the oven rack straight forward until it reaches the stop position. Lift up the front of the oven rack slightly and slide out.
- **To replace** - Place the oven rack on the rack guides on both sides of oven walls. Tilt the front of oven rack upward slightly and slide the oven rack back into place. Be sure oven racks are level before using.

WARNING

- Protective liners - Do not use aluminum foil to line the oven bottom. Only use aluminum foil as recommended in this manual. Improper installation of these liners may result in risk of electric shock or fire.
- It is recommended to remove all racks from the oven during a self-clean cycle, but porcelain racks may be left in the oven if they are soiled. For care of oven racks, see the Care and Cleaning section.
- Be sure to remove all oven accessories before starting a self clean cycle.

CAUTION

Always use pot holders or oven mitts when using the oven. When cooking, the oven interior and exterior, as well as the oven racks, will become very hot which can cause burns.

Glide rack

The glide rack is an extendable rack that makes food preparation easier. It has glide tracks that allow the rack to be pulled away from the oven without rubbing the sides of the oven wall.

It is recommended to remove all racks from the oven during self-clean cycles, but porcelain racks may be left in the oven if they are soiled. After a self-clean cycle, or anytime the gliding is rough, the glide racks should be treated with graphite lubrication. For instructions on how to care for your oven racks, see “Caring for Your Porcelain Enamelled Glide Racks” in the Care and Cleaning section.

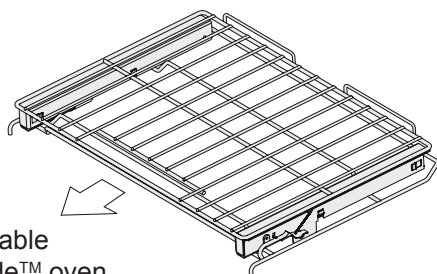

Full extendable
Luxury-Glide™ oven
rack

Removing and replacing the Luxury-Glide™ oven racks

To remove - Make sure the baking rack is in the closed position. Using one hand, reach through handle opening and grasp both the upper and lower portions of the glide rack as shown in Figure 1.

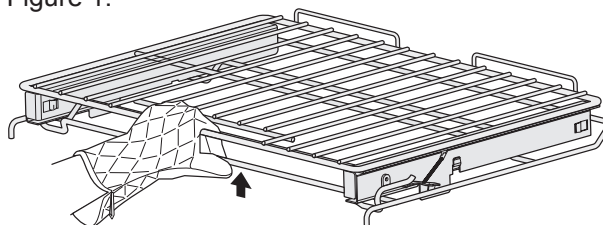

Figure 1 - Hold both upper and lower rack portions. Using both hands, lift up the front of the rack slightly and continue to pull the rack away from the oven (Figure 2). Be sure to grasp both upper and lower rack portions together when removing or handling the glide rack.

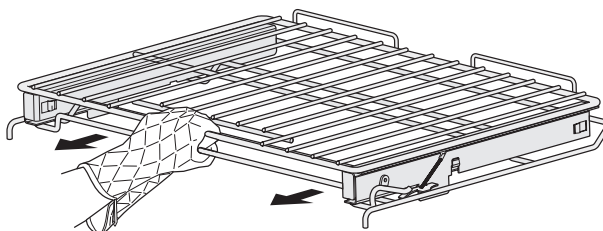

Figure 2 - Pull the rack away from the oven

The rack portions move independently and should be held together when removing and replacing.

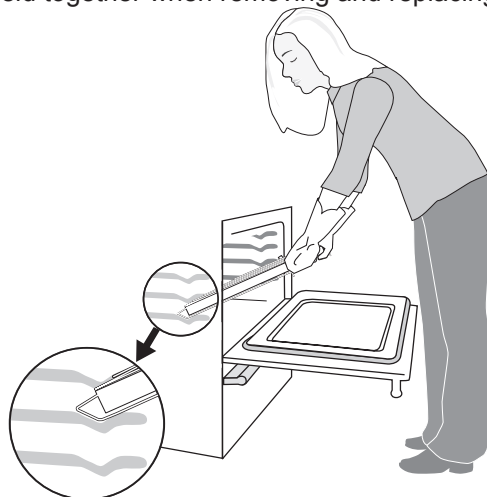

Figure 3 - Use two hands when handling the glide rack

To replace - Make sure the baking rack is in the closed position. Grasp both upper and lower portions of glide rack. Lift and hold the rack level between the oven cavity walls. Tilt the front of the rack upward slightly and slide the rack completely into position.

Baking

This mode is best used for your standard recipes. The hidden bake element is used to heat the air and maintain temperature. The temperature probe can be used in this cooking mode. The upper oven can be programmed to bake at any temperature from 170°F to 550°F with a default temperature of 350°F. The lower oven can be programmed to bake at any temperature from 170°F to 450°F with a default temperature of 350°F.



Upper Oven Baking Tips

- During preheat, the 3 elements and the convection fan are used in cycle to quickly heat the oven. The convection fan will turn off once the oven is fully preheated.
- Fully preheat the oven before baking items like cookies, cakes, biscuits and breads.
- When using any single oven rack, position the rack in the oven so that the food is in the center of the oven. For multiple rack baking, use the convection bake function.
- If using two racks, place the oven racks in positions 1 (glide rack) and 4 (flat rack) Figure 1 and position cookware as shown in Figure 2.
- Be sure the pans do not touch each other, the door, sides or back of the oven. Allow at least 2 inches (5 cm) of space between bakeware to allow for proper air circulation.
- Dark or dull bakeware absorbs more heat than shiny bakeware, resulting in dark or overbrowned foods. It may be necessary to reduce oven temperature or cook time to prevent overbrowning of some foods.
- Dark pans are recommended for pies; shiny pans are recommended for cakes, cookies, and muffins.
- Do not open oven door often. Opening the door will reduce the temperature in the oven and may increase cook time.

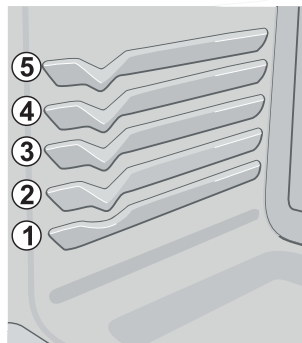





Figure 1

Lower Oven Baking Tips:

- Follow recommendations for lower oven cooking modes in the **Lower Oven Operation** section of this manual.

To set a Bake Temperature of 350°F:

1. Arrange interior oven racks.
2. Select oven by pressing **UPPER OVEN** ^{UPPER} **OVEN** or **LOWER OVEN** ^{LOWER} **OVEN**.
3. Press **BAKE** .
4. Press **START** . The oven display shows **PRE-HEATING**.
5. Place food in the oven when the chime signals and temperature display shows that the oven has reached the set target temperature and the **PRE-HEATING** message disappear.
6. Cook Time, Timer and End Time features can be set to control your cooking time in both ovens (read their sections for directions). The Temperature Probe and Rapid Preheat features can be used only with the upper oven.
7. Remove food. Always use oven mitts when removing hot pans from the oven.
8. Press **CANCEL**  to stop or cancel the Bake feature at any time.

To change to a Bake Temperature of 425°F:

1. Select oven by pressing **UPPER OVEN** ^{UPPER} **OVEN** or **LOWER OVEN** ^{LOWER} **OVEN**.
+ -
2. Press the **HI hi** or **LO lo** pads to get to the desired temperature.

Baking Problems

Refer to the Baking Problems Table in the Solutions to Common Problems section of this manual.

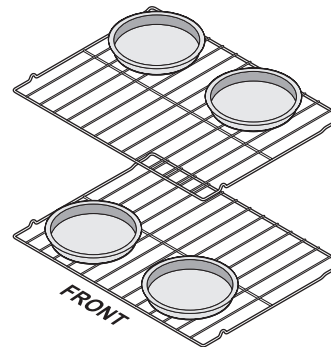

Figure 2

Cook time

Cook Time allows the oven to be set to cook for a set length of time and shut off automatically.

The time remaining will always be shown in the timer section of the display. The oven will shut off and will chime when the countdown is finished. This feature can be used with Bake, Convection Bake, Convection Roast, Slow Cook, Keep Warm, Defrost, Bread Proof and Dehydrate cooking modes. It can also be part of a Multi-Stage sequence.

To set a timed cooking (example is a 450°F Bake for 30 minutes):

1. Select oven by pressing **UPPER OVEN** UPPER OVEN.
2. Press **BAKE** . The temperature numbers will blink in the display.
3. Enter temperature needed; **4** **5** **0**.
4. Press **COOK OPTIONS** to bring up the cook options items.
5. Press **COOK TIME** .
6. Enter time needed; **3** **0**.
7. Press **START** . The oven will start heating. The cook time will start counting down for the set time.
8. Press **CANCEL** to stop the audible alarm or to cancel cooking at anytime.

End time

End Time allows the oven to be set to shut off automatically at a set time of day. The oven control will calculate the remaining time by itself. The time remaining will always be shown in the timer section of the display. The oven will shut off and will chime when the countdown is finished. This feature can be used with Bake, Convection Bake, Convection Roast, Slow Cook, Keep Warm, Defrost, Dehydrate, Clean and Bread Proof cooking modes. This oven can be programmed with Cook Time and End Time to start and stop by itself at the right time.

To set a delayed timed cooking (example is a 450°F Bake for 30 minutes which will end at 6:00PM):

1. Select oven by pressing **UPPER OVEN** UPPER OVEN.
2. Press **BAKE** . The temperature numbers will blink in the display.
3. Enter temperature needed; **4** **5** **0**.
4. Press **COOK OPTIONS** to bring up the cook options items.
5. Press **COOK TIME** .
6. Enter time needed; **3** **0**.
7. Press **END TIME** .
8. Enter time of day needed; **6** **0** **0**.
9. Press **START** . The time remaining will be shown in the display.
10. Press **CANCEL** to stop the audible alarm or to cancel cooking at anytime.

CAUTION

Use caution with the **COOK TIME** or **END TIME** features. Use the automatic timer when cooking cured or frozen meats and most fruits and vegetables. Foods that can easily spoil such as milk, eggs, fish, meat or poultry, should be chilled in the refrigerator first. Even when chilled, they should not stand in the oven for more than 1 hour before cooking begins, and should be removed promptly when cooking is completed. Eating spoiled food can result in sickness from food poisoning.

Convection baking

This mode of cooking enables you to obtain the best culinary results when baking with multiple pans and racks. Multiple rack baking may slightly increase cook time for some foods but the overall result is time saved. Most foods cooked in a standard oven will cook faster and more evenly with Convection Bake. Convection baking uses the three elements and a fan to circulate the oven's heat evenly and continuously within the oven. The temperature probe can be used in this cooking mode. The oven can be programmed for Convection baking at any temperature between 170°F to 550°F with a default temperature of 350°F.



Convection Baking Tips

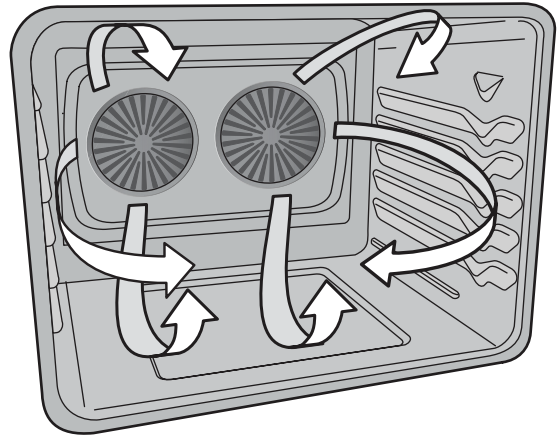

- Fully preheat the oven before baking items like cookies, cakes, biscuits and breads.
- If your recipe's baking temperature has already been converted for convection baking there is no need to reduce your oven temperature. If your recipe has not had the temperature converted for convection baking you can easily reduce the temperature using the Convection Convert feature. Please see Convection Convert section on next page for further instruction on temperature conversion.
- Use tested recipes with times adjusted for convection baking when using this mode. With single rack convection baking some foods may have as much as a 25% reduction in cook time; check food at minimum time. Time reductions will vary depending on the amount and type of food to be cooked.
- Cookies and biscuits should be baked on pans with no sides or very low sides to allow heated air to circulate around the food.
- For single rack baking, use the radiant bake function.
- When baking using two oven racks, position cookware as shown in Figure 2.
- Allow at least 2 inches (5 cm) of space between bakeware to allow for proper air circulation.
- Dark or dull bakeware absorbs more heat than shiny bakeware, resulting in dark or overbrowned foods. It may be necessary to reduce oven temperature or cook time to prevent overbrowning of some foods.
- Dark pans are recommended for pies; shiny pans are recommended for cakes, cookies, and muffins.
- Do not open oven door often. Opening the door will reduce the temperature in the oven and may increase cook time.



Convection Bake Air Flow

Figure 1

To set a Convection Bake Temperature of 350°F:

1. Arrange interior oven racks.
2. Select oven by pressing **UPPER OVEN** UPPER OVEN.
3. Press **CONVECTION BAKE** .
4. Press **START** . The oven display shows **PRE-HEATING**.
5. Place food in the oven when the chime signals and temperature display shows that the oven has reached the set target temperature and the **PRE-HEATING** message disappear.
6. Remove food. Always use oven mitts when removing hot pans from the oven.
7. Press **CANCEL**  to stop or cancel the Convection Bake feature at any time.

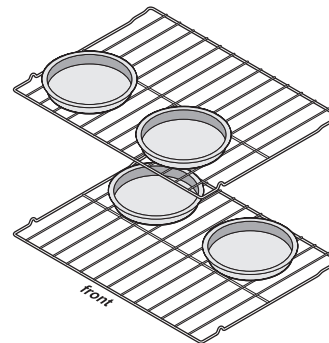

Figure 2

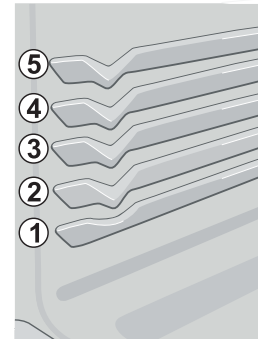











Figure 3

Convection convert

The Convection Convert pad is used to automatically convert a standard baking recipe for convection baking. When set properly, this feature is designed to display the actual converted (reduced) temperature in the display. Convection Convert may ONLY be used with a Convection Bake cooking mode. It can be used with the features End Time and Cook Time (see their sections for directions). If convection conversion is used with the cook time and end time features, "CF" (check food) will be displayed when 75% of the bake time is complete. At this time the oven control will chime at regular intervals until baking had finished. When the bake time has completely finished the control will chime at regular interval until the **CANCEL**  pad is pressed. **NOTE:** To use this feature with the **COOK TIME**  option, the **COOK TIME**  pad must be pressed before the **CONVECTION CONVERT**  pad.

Changing from a normal bake temperature to a convection bake temperature:





1. Select oven by pressing **UPPER OVEN** .
2. Press **CONVECTION BAKE** .
3. Press **COOK OPTIONS** . The cook options items will light up.
4. Press **CONVECTION CONVERT** . The temperature displayed will be 25°F lower than what it used to be.
5. Press **START**  to begin the convection baking (see Convection Baking section for more informations).

Rapid preheat

The Preheat feature will bring the oven up to temperature faster than a regular preheat and then indicate when to place the food in the oven. Preheating is not necessary when roasting or cooking casseroles. The oven can be programmed to preheat at any temperature between 170°F to 550°F with some of the cooking modes; Bake, Convection Bake and Convection Roast.

IMPORTANT! The rapid preheat feature is for single rack ONLY. The heat distribution with multiple rack will be uneven. For batter- and dough-based baked goods such as cakes, pastries, and breads, use the standard bake and convection bake functions for best results.

To set a rapid preheat (example is for a 350°F Bake):

1. Select oven by pressing **UPPER OVEN** .
2. Press **BAKE** .
3. Press **COOK OPTIONS** . The cook options items will light up.
4. Press **RAPID PREHEAT** .
5. Press **START**  to begin the baking with the rapid preheat feature enabled.
6. Place food in the oven when the chime signals and temperature display shows that the oven has reached the set target temperature.

Convection roasting





This mode is best for cooking tender cuts of beef, lamb, pork and poultry. Use this mode when cooking speed is desired. The Convection Roasting gently browns the exterior and seals in the juices. Convection roasting uses the hidden bake element, the hidden convection element, the broil element and a fan to circulate the oven's heat evenly and continuously within the oven. The temperature probe can be used in this cooking mode. The oven can be programmed for Convection Roasting at any temperature between 170°F to 550°F with a default temperature of 350°F.



Convection Roasting Tips

- Use the broiler pan and grid, and the roasting rack (Figure 1). The broiler pan will catch grease spills and the grid will help prevent spatters. The roasting rack will hold the meat.
- Place an oven rack on rack position 2 (next-bottom).
- Make sure the roasting rack is securely seated on the grid in the broiler pan. The roasting rack fits on the grid allowing the heated air to circulate under the food for even cooking and helps to increase browning on the underside.
- There is no need to reduce the convection temperature or to use the Convection Convert feature with this cooking mode.
- **DO NOT** use the broiler pan without the grid or cover the grid with aluminum foil.
- Always pull the rack out to the stop position before removing food.
- Position food (fat side up) on the roasting rack.

To set a Convection Roast Temperature of 350°F:

1. Arrange interior oven racks.
2. Select oven by pressing **UPPER OVEN** .
3. Press **CONVECTION ROAST** .
4. Press **START** .
5. The Temperature Probe, Cook Time, Timer, End Time and Rapid Preheat features can be set to control your cooking time (read their sections for directions).
6. Remove food. Always use oven mitts when removing hot pans from the oven.
7. Press **CANCEL**  to stop or cancel the Convection Roast feature at any time.

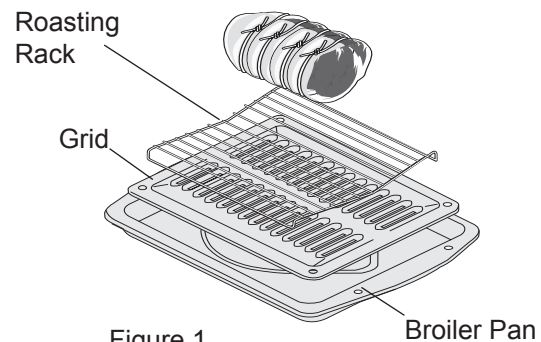

Figure 1

Convection Roasting Chart					
Meat		Weight	Oven Temp	Internal Temp	Min per lb.
Beef	Standing rib roast	4 to 6 lbs.	350° F	*	25-30
	Rib eye roast	4 to 6 lbs.	350° F	*	25-30
	Tenderloin roast	2 to 3 lbs.	400° F	*	15-25
Poultry	Turkey, whole**	12 to 16 lbs.	325° F	180° F	8-10
	Turkey, whole**	16 to 20 lbs.	325° F	180° F	10-15
	Turkey, whole**	20 to 24 lbs.	325° F	180° F	12-16
Pork	Chicken	3 to 4 lbs.	350-375° F	180° F	12-16
	Ham roast, fresh	4 to 6 lbs.	325° F	160° F	30-40
	Shoulder blade roast	4 to 6 lbs.	325° F	160° F	20-30
	Loin	3 to 4 lbs.	325° F	160° F	20-25
	Pre-cooked ham	5 to 7 lbs.	325° F	160° F	30-40

* For beef: med rare 145°F, med 160°F, well done 170°F

** Stuffed turkey requires additional roasting time. Shield legs and breast with foil to prevent overbrowning and drying of the skin.

Broiling





This mode is best for meats, fish and poultry up to 1" thick. Broiling is a method of cooking tender cuts of meat by direct heat under the broil element of the oven. The high heat cooks quickly and gives a rich, brown outer appearance. The temperature probe cannot be used with this mode. The oven can be programmed to broil at any temperature from 300°F to 550°F with a default temperature of 550°F.



Broiling Tips

- Broiling is direct heat cooking and will produce some smoke. If smoke is excessive, place food further away from the broil element. Always watch food carefully to prevent burning.
- For optimum browning, preheat the broil element for 2 minutes.
- Broil one side until the food is browned; turn and cook on the second side. Season and serve.
- Always pull the rack out to the "stop" position before turning or removing food.
- Always use the broiler pan and its grid when broiling. It allows the dripping grease to be kept away from the high heat of the broil element (see Figure 1).
- **DO NOT** use the broil pan without the insert. **DO NOT cover the broil pan insert with foil.** The exposed grease could catch fire. **DO NOT** use the roasting rack when broiling.

To set a Broil Temperature of 550°F:

1. Arrange interior oven racks.
2. Select oven by pressing **UPPER OVEN** .
3. Press **BROIL** .
4. Press **START** .
5. Place food in the oven after 2 minutes. **Close the oven door.**
6. Turn food when the top side is browned and cook on the second side.
7. Remove food. Always use oven mitts when removing hot pans from the oven.
8. Press **CANCEL**  to stop or cancel the Broil feature at any time.

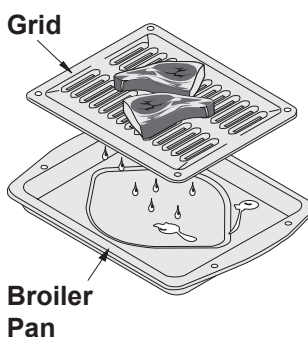

Figure 1

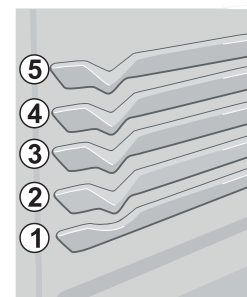

Figure 2

Broiling Times

Electric Wall Oven Broiling Table Recommendations						
Food Item	Rack position	Temp Setting	Cook Time		Doneness	
			1st side	2nd side		
Steak 1" thick	5	550° F	6:00	4:00	Rare	
	5	550° F	7:00	5:00	Medium	
Pork Chops 3/4" thick	5	550° F	8:00	6:00	Well	
Chicken - Bone In	3	450° F	20:00	10:00	Well	
Chicken - Boneless	5	450° F	8:00	6:00	Well	
Fish	5	500° F	13:00	0:00	Well	
Shrimp	3	550° F	5:00	0:00	Well	
Hamburger 1" thick	5	550° F	9:00	7:00	Medium	
	3	550° F	10:00	8:00	Well	

WARNING

- Should an oven fire occur, close the oven door and turn off the oven. If the fire continues, throw baking soda on the fire or use a fire extinguisher. **DO NOT** put water or flour on the fire. Flour may be explosive and water can cause a grease fire to spread and cause personal injury.
- Use pot holders or oven mitts when working with a hot oven.
- Consuming raw or undercooked meats, poultry, seafood or shellfish may increase your risk of food borne illness.

Convection broiling

Use this mode for thicker cuts of meat, fish and poultry. The Convection Broiling gently browns the exterior and seals in the juices. Convection broiling uses the broil element and a fan to circulate the oven's heat evenly and continuously within the oven. The temperature probe cannot be used in this cooking mode. The oven can be programmed for Convection Broiling at any temperature between 300°F to 550°F with a default temperature of 550°F.



Convection Broiling Tips

- For optimum browning, preheat the broil element for 2 minutes.
- Broil one side until the food is browned; turn and cook on the second side. Season and serve.
- Always pull the rack out to the “stop” position before turning or removing food.
- Always use the broiler pan and its grid when broiling. It allows the dripping grease to be kept away from the high heat of the broil element (see Figure 1).
- **DO NOT** use the broil pan without the insert. **DO NOT cover the broil pan insert with foil.** The exposed grease could catch fire. **DO NOT** use the roasting rack when broiling.
- Convection broiling is generally faster than conventional broiling. Check for doneness at the minimum recommended time.

→ IMPORTANT

Always use this cooking mode with the oven door closed or the fan will not turn on.

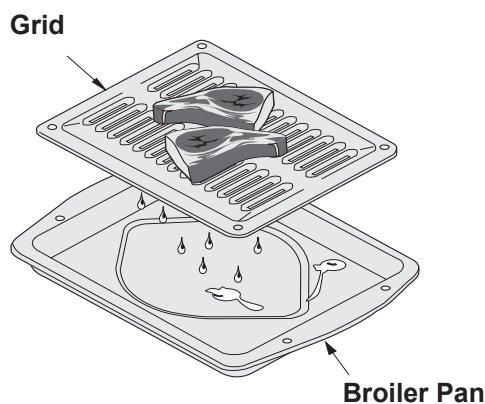





Figure 1

To set a Convection Broil Temperature of 550°F:

1. Arrange interior oven racks.
2. Select oven by pressing **UPPER OVEN** UPPER OVEN.
3. Press **CONVECTION BROIL** .
4. Press **START** .
5. Place food in the oven after 2 minutes.
6. Turn food when the top side is browned and cook on the second side.
7. Remove food. Always use oven mitts when removing hot pans from the oven.
8. Press **CANCEL**  to stop or cancel the Convection Broil feature at any time.



WARNING

Should an oven fire occur, close the oven door and turn off the oven. If the fire continues, throw baking soda on the fire or use a fire extinguisher. **DO NOT** put water or flour on the fire. Flour may be explosive and water can cause a grease fire to spread and cause personal injury.

Keep warm

This mode is best for keeping oven baked foods warm for serving after cooking has finished. The Keep Warm feature uses the hidden bake element to maintain the temperature within the oven. The Keep Warm feature may be used with Multi-Stage (refer to its section for directions) if you wish to have the Keep Warm feature turn ON automatically when cooking has finished. The oven can be programmed for Keep Warm at any temperature between 150°F to 190°F with a default temperature of 170°F.



Keep Warm Tips for Upper Oven



- Always start with hot food.
- Do not use the Keep Warm feature to heat cold food.
- Food in heat-safe glass and glass ceramic containers may need higher temperature settings compared to food in regular containers.
- Avoid repeated openings of the oven, it will allow hot air to escape and the food to cool.
- Aluminum foil may be used to cover food to increase moisture content.



Keep Warm Tips for Lower Oven

- Follow recommendations for lower oven cooking modes in the **Setting Lower Oven** section of this manual.

To set a Keep Warm Temperature of 170°F:

1. Arrange interior oven racks (for upper oven only).
2. Select oven by pressing **UPPER OVEN** UPPER OVEN or **LOWER OVEN** LOWER OVEN.
3. Press **KEEP WARM** .
4. Press **START** .
5. The Multi-Stage, Cook Time, Timer and End Time features can be set to control your warming time (read their sections for directions).
6. Remove food. Always use oven mitts when removing hot pans from the oven.
7. Press **CANCEL**  to stop or cancel the Keep Warm feature at any time.

Food poisoning hazard: do not let food sit for more than one hour before or after cooking. Doing so may result in food borne illness.

Slow cook



This mode may be used to cook foods more slowly, at lower oven temperatures and provide cooking results much the same way as a Slow Cooker or Crock-Pot. The Slow Cook feature is ideal for roasting beef, pork & poultry. Slow Cooking meats may result in the exterior of meats becoming dark but not burnt. This is normal. The Slow Cook mode uses the hidden bake element to maintain a low temperature in the oven. The temperature probe cannot be used in this cooking mode. There are 2 settings available, high (HI) or low (LO). The maximum cook time for the Slow Cook feature is 12 hours unless the oven control has been changed to the Continuous Bake mode or the Sabbath mode has been activated.



Slow Cook Tips

- Completely thaw all frozen foods before cooking with the Slow Cook feature.
- When using a single oven rack, position it so the food is in the center of the oven.
- Position multiple racks to accommodate size of cooking utensils when cooking multiple food items.
- Do not open the oven door often or leave the door open when checking foods. If the oven heat escapes often, the Slow Cook time may need to be extended.
- Cover the foods to keep them moist or use a loose or vented type cover to allow foods to turn crisp or brown.
- Cook times will vary; depending on the weight, fat content, bone & the shape of the meat.
- Use the recipe's recommended food temperature and a food thermometer to determine when the food is done.
- Preheating the oven will not be necessary when using the Slow Cook feature.
- Add any cream or cheese sauces during the last hour of cooking.

To set a Slow Cook:

1. Arrange interior oven racks and place food in the oven.
2. Select oven by pressing **UPPER OVEN** UPPER OVEN or **LOWER OVEN** LOWER OVEN.
3. Press **SLOW COOK** .
4. Press $+$ _{hi} for high (HI) setting or $-$ _{lo} low (Lo) setting.
5. Press **START** .
6. The Cook Time, Timer and End Time features can be set to control your Slow Cook time (read their sections for directions).
7. Remove food. Always use oven mitts when removing hot pans from the oven.
8. Press **CANCEL**  to stop or cancel the Slow Cook feature at any time.

Dehydrating

This mode dries foods with heat from the bake and the convection element. The heat is circulated throughout the oven by the convection fan. Dehydrating is used to dry and/or preserve foods such as fruits, meats, vegetables and herbs. This mode holds an optimum low temperature while circulating the heated air to slowly remove moisture. The oven can be programmed for Dehydrating at any temperature between 100°F to 225°F with a default temperature of 120°F.



Dehydrating Tips

- Do not preheat the oven.
- Multiple racks can be used simultaneously.
- Drying times vary depending on the moisture and sugar content of the food, the size of the pieces, the amount being dried and the humidity in the air.
- Check food at the minimum drying time.
- Treat fruits with antioxidants to avoid discoloration.
- Consult a food preservation book or a library for additional information.

To set a Dehydrate Temperature of 120°F:

1. Arrange interior oven racks and place food.
2. Select oven by pressing **UPPER OVEN** UPPER OVEN.
3. Press **DEHYDRATE**
4. Press **START**
5. Remove food. Always use oven mitts when removing hot pans from the oven.
6. Press **CANCEL**

Defrosting

Use the defrost feature to thaw small portions of delicate items such as cream cakes, frozen cream pies and cheesecake, at room temperature. While in the defrost mode, the convection fan will operate to circulate room temperature air around the food slowly, accelerating the natural defrosting of the food without heat.

To set a Defrost:

1. Arrange interior oven racks and place food in the oven.
2. Select oven by pressing **UPPER OVEN** UPPER OVEN.
3. Press **DEFROST**
4. Press **START**
5. The Cook Duration, End Time and Timer features can be set to control your Defrost time (read their sections for directions).
6. Press **CANCEL**

NOTE

This feature is not meant for thawing frozen meats, poultry, seafood or other foods that need to be cooked before serving. Follow USDA recommendations for thawing foods. Only frozen foods that can be defrosted and served without cooking should be used with this feature.

Bread Proofing





Proofing bread prepares the dough for baking by activating the yeast. This feature is ideal for proofing, or rising bread dough. The oven can be programmed for Bread Proofing at any temperature between 85°F to 100°F with a default temperature of 100°F. The temperature visual display is not available for this function.



Bread Proofing Tips

- No need to preheat for this feature.
- Proof bread until dough has doubled in bulk.
- For best results, place a shallow pan with 1 to 3 cups of boiling hot water on the lowest rack position to keep the air moist inside the oven cavity.
- Allow at least 1" between edge of pan and walls of the oven.
- Limit frequent door openings to prevent losing heat and lengthening proofing time.

To set a Bread Proof temperature of 100°F:

1. Arrange interior oven racks and place bread dough in the oven.
2. Select oven by pressing **UPPER OVEN** .
3. Press **BREAD PROOF** .
4. Press **START**  to begin the bread proofing.
5. The Cook Time, Timer and End Time features can be set to control your Bread Proof time (read their sections for directions).
6. Remove food.
7. Press **CANCEL**  to stop or cancel the Bread Proof feature at any time.

To change a Bread Proof temperature while the function is active:

1. Select oven by pressing **UPPER OVEN** .
2. Press the **HI** ⁺_{hi} or **LO** _{lo} pads to get to the desired temperature.

Perfect turkey



This mode uses the temperature probe to control precisely the cooking of a perfect turkey. The convection system gently browns the turkey's exterior and seals in the juices. The temperature probe is **required** with this cooking mode (read its section on next page for more details). The oven can be programmed for Perfect Turkey at any temperature between 170°F to 550°F with a default temperature of 325°F. The probe default temperature for the perfect turkey feature is 180°F.





Perfect Turkey Tips

- Thaw the turkey in the refrigerator at least 24 hours per 5 lbs before cooking the bird.
- Use the broiler pan and grid, and the roasting rack. The broiler pan will catch grease spills and the grid will help prevent spatters. The roasting rack will hold the turkey.
- Place an oven rack on rack position 2 (next-bottom).
- Make sure the roasting rack is securely seated on the grid in the broiler pan. The roasting rack fits on the grid allowing the heated air to circulate under the food for even cooking and helps to increase browning on the underside.

To set a Perfect Turkey of 325°F:

1. Arrange interior oven racks and place food in the oven.
2. Insert the meat probe into the bird and connect it in the oven (read the Probe section).
3. Select oven by pressing **UPPER OVEN** .
4. Press **PERFECT TURKEY** . A temperature can be entered if another value than the default is needed.

Optional : Press **PROBE**  if you wish to change the probe target temperature (see Probe section).

5. Press **START** .
6. Remove food from the oven when the temperature probe chime signals that the oven has reached the set target temperature.
7. Press **CANCEL**  to stop or cancel the Perfect Turkey feature at any time.

Perfect Turkey Chart

	Weight (lbs)	Oven Temp.	Internal Temp.	Minute per lb.
Turkey, Whole*	12 to 16	325°F	180°F	8-10
Turkey, Whole*	16 to 20	325°F	180°F	10-15
Turkey, Whole*	20 to 24	325°F	180°F	12-16
Chicken	3 to 4	350-375°F	180°F	12-16

* Stuffed turkey requires additional roasting time. Shield legs and breast with foil to prevent overbrowning and drying of the skin.

Temperature probe

For many foods, especially roasts and poultry, testing the internal temperature is the best method to insure properly cooked food. The Temperature Probe gets the exact temperature you desire without having to guess. This feature can be used with Bake, Convection Bake, Convection Roast and Perfect Turkey cooking modes. The oven can be programmed for Probe at any temperature between 130°F to 210°F with a default temperature of 170°F. This unit is equipped with one temperature probe entry in the upper oven.

→ IMPORTANT







- Use only the probe supplied with your appliance; any other may result in damage to the probe or the appliance.
- Handle the Temperature Probe carefully when inserting and removing it from the food and outlet.
- Do not use tongs to pull the cable when inserting or removing the Probe. It could damage the Probe.
- Defrost your food completely before inserting the Probe to avoid breaking it.
- Never leave or store the Temperature Probe inside the oven when not in use.
- To prevent the possibility of burns, carefully unplug the Temperature Probe using hot pads.

Proper Temperature Probe Placement:

1. Always insert the probe so that the tip rests in the center of the thickest part of the meat. Do not allow probe to touch bone, fat, gristle or pan.
2. For bone-in ham or lamb, insert the Probe into the center of the lowest large muscle or joint. For dishes such as meat loaf or casseroles, insert the Probe into the center of the food. When cooking fish, insert the Probe from just above the gill into the meatiest area, parallel to the backbone.
3. For whole poultry (chicken, turkey, etc.), insert the probe into the thickest part of the inner thigh from below and parallel to the leg (see figure 1).

Setting the Oven when using the Temperature Probe:

1. Insert the Temperature Probe into the food (see Proper Temperature Probe Placement above).
2. Plug the Temperature Probe into its outlet in the oven. **(The outlet is located on the top left hand side of the cavity wall, near front of the oven).** Always insert the probe into a cool oven. Make sure it is pushed all the way into the outlet. Close the oven door.

3. Select oven by pressing **UPPER OVEN** UPPER OVEN.
4. Select a cooking mode. A target temperature must be set to trigger the buzzer when the food reaches the set temperature. Press **COOK OPTIONS**  to bring up the cook options items and press **PROBE**  pad to enter the temperature. Adjust temperature to the desired setting using the numeric pads or just press **START**  to use the default target temperature of 170°F. The pads **hi** or **lo** can also be pressed to raise or lower the temperature. The target temperature setting will be accepted after the **START**  pad is pressed.
5. At any time during the cooking, the **PROBE**  pad can be pressed once to display the actual meat temperature or pressed twice to display the target temperature. When on the target temperature display, a new temperature can be entered. After 5-8 seconds, the display will go back to showing the oven temperature.
6. When the food reaches the target temperature, the oven will go into a **KEEP WARM** mode until you press **CANCEL** .

The probe can be damaged by very high temperature. To protect the probe against this damage, the oven control will not allow you to start a self-clean, broil or convection broil while the probe is connected.

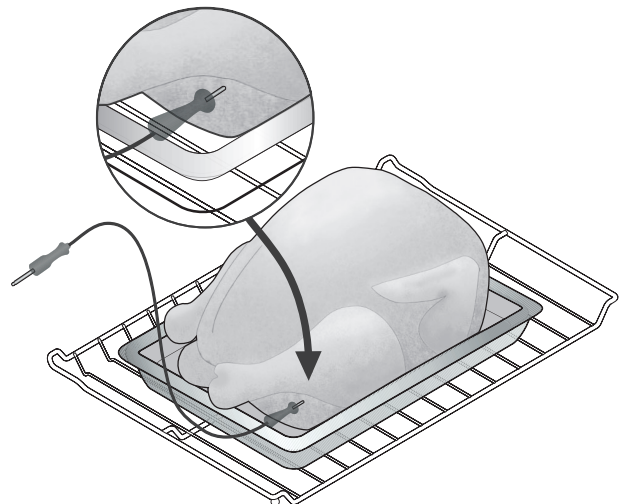



















Figure 1







Multi stage

This feature enables you to perform sequential cooking at the touch of a button. Its purpose is to program a queue of up to three cooking modes with individual cooking time and temperatures in a sequence. This feature can be used with most cooking modes; Baking, Broiling, Convection Baking, Convection Roasting, Convection Broiling, Keep Warm and Bread Proof. A Cook Time can be programmed with your cooking mode and then queued. An auto-suggested set temperature outputs in the display as a default value during the set temperature programming. Any stage programmed with Broil or Convection Broil cannot last longer than 10 minutes. A proper cook time and a set temperature are required for every stage programming. At least two stages must be programmed before a Multi-Stage cooking operation starts. During stage 1 cooking the electronic control provides temperature visual output in the display. During stage 2 and 3, the electronic control displays the set temperature only.

To set a Multi Stage sequence (Timed Convection Bake, Timed Broil, Keep Warm):

1. Arrange interior oven racks and place food.
 2. Select oven by pressing **UPPER OVEN** .
 3. Press **MULTI STAGE** .
- Stage 1 —
4. Press **CONVECTION BAKE** . “350” will flash in the display prompting to enter a temperature.
 5. Enter a temperature using the numeric pads  to .
 6. Press **START** . “00:00” will start flashing in the display prompting to enter a cook time.
 7. Enter a cook time using the numeric pads  to .
 8. Press **START** . The Multi-Stage indicator will now display the 2nd stage.

- Stage 2 —
9. Press **BROIL** . “550” will start flashing in the display prompting to enter a temperature.
 10. Enter a temperature using the numeric pads  to .
 11. Press **START** . “00:00” will start flashing in the display prompting to enter a cook time.
 12. Enter a cook time using the numeric pads  to .
 13. Press **START** . The Multi-Stage indicator will now display the 3rd stage. If a third stage is not needed, press **START**  a second time. This will start the cooking sequence.

- Stage 3 —
14. Press **KEEP WARM** . “170” will start flashing in the display prompting to enter a temperature.
 15. Enter a temperature using the numeric pads  to .
 16. Press **START** . “00:00” will start flashing in the display prompting to enter a cook time.
 17. Enter a cook time using the numeric pads  to .
 18. Press **START** . The cooking sequence will begin.

- Canceling —
19. At the end of the sequence, the display will show “End” and a chime will sound.
 20. Remove food.
 21. Press **CANCEL**  to stop or cancel the Multi-Stage sequence at any time (see below for further details).

To cancel a Multi Stage sequence:
 A multi stage cooking can be canceled any time while it is in progress (or during its programming) by the Cancel  key.

If the key is pressed during a multi-stage programming, the electronic control returns to Idle mode.





34 Setting Oven Controls

My favorite

The Favorites settings allows you to save your most frequently used or most complex cooking sequences. This feature will save the cooking mode, the target temperature and the cooktime (if any). The oven can recall up to six cooking sequences from its internal memory, three for each oven, which are easily accessible from a one touch button. These functions can be used with all cooking modes and features.



To save a Favorite (example is a 450°F Bake for 30 minutes):

- Saving a Favorite can only be done for an oven which is currently in operation.

1. Select oven by pressing either **UPPER OVEN** UPPER OVEN or **LOWER OVEN** LOWER OVEN.
2. Press **BAKE** . The default temperature will appear in the display.
3. Enter temperature needed; **4 5 0**.
4. Press **COOK OPTIONS**  to bring up the cook options items.
5. Press **COOK TIME** .
6. Enter time needed; **3 0**.
7. Press **START** .
8. Press and hold for 3 seconds any **MY FAVORITE**  pad. Notice that the red indicator above the key will light up.

To recall a Favorite:

- Recalling a Favorite can only be done for an oven which is not currently in operation.

1. Select oven by pressing either **UPPER OVEN** UPPER OVEN or **LOWER OVEN** LOWER OVEN.
2. Press any **MY FAVORITE**  pad which is currently lighted up.
3. Press **START** .

To overwrite a Favorite:

1. To overwrite a My Favorite simply start a new cooking sequence and save it into the same My Favorite location (1, 2 or 3) for the selected oven as shown in example above. The new My Favorite settings will overwrite the old ones.

To delete a Favorite:

1. Select oven by pressing either **UPPER OVEN** UPPER OVEN or **LOWER OVEN** LOWER OVEN.
2. Press the currently lighted up **MY FAVORITE**  pad you wish to delete for **3 seconds**.

Sabbath feature (for use on the Jewish sabbath & holidays)







The **HI**⁺_{hi} and **LO**⁻_{lo} pads are used to set the Sabbath feature. The Sabbath feature may only be used with the **BAKE**  pad. The oven temperature may be set higher or lower after setting the Sabbath feature (the oven temperature adjustment feature should be used only during Jewish Holidays), however the display will not visibly show or provide any audible tones indicating whether the change occurred correctly. Once the oven is properly set using Bake with the Sabbath feature active, the oven will remain continuously ON until cancelled. This will override the factory preset 12-Hour Energy Saving feature.

If the oven light will be needed during the Sabbath, press **OVEN LIGHT**  before activating the Sabbath feature. Once the oven light is turned ON and the Sabbath feature is active, the oven light will remain ON until the Sabbath feature is turned OFF. If the oven light needs to be OFF, be sure to turn the oven light OFF before activating the Sabbath feature.

→ IMPORTANT

It is not advised to attempt to activate any other program feature other than **BAKE** while the Sabbath feature is active. ONLY the following key pads will function after setting the Sabbath feature; **CANCEL** , **HI**⁺_{hi} and **LO**⁻_{lo}. **ALL OTHER KEYPADS** will not function once the Sabbath feature is properly activated.

To Program the Upper Oven to Begin Baking Immediately & Activate the Sabbath feature (example: baking at 350°F)

1. Place the food in the oven.
2. Select oven by pressing either **UPPER OVEN**  or **LOWER OVEN** .
3. Press **BAKE** .
4. If you desire to set the oven control for a **COOK TIME**  do so at this time. If not, skip this step and continue to step 5. Refer to their section for complete instructions. Remember the oven will shut down after using **COOK TIME**  and therefore may only be used once during the Sabbath/Jewish Holidays.
5. Press **START** .

6. The oven will turn ON and begin heating immediately.

7. Press and hold both the **HI**⁺_{hi} and **LO**⁻_{lo} pads for at least 3 seconds. **SAb** will appear in the oven display and **Sb** in the cooktop displays. Once **SAb** appears in the display the oven control will no longer sound or display any further changes and the oven is properly set for the Sabbath feature.

NOTE

You may change the oven temperature once baking has started. The **HI**⁺_{hi} key pad will increase the temperature by 5°F (2°C) at each key press. The **LO**⁻_{lo} key pad will decrease the temperature by 5°F (2°C) at each key press. Remember that **the oven control will no longer sound or display any further changes** once the oven is set for the Sabbath feature.

8. The oven may be turned OFF at any time by pressing **CANCEL**  pad (this will turn the oven OFF only). To turn OFF the Sabbath feature press and hold both the **HI**⁺_{hi} and **LO**⁻_{lo} pads for at least 3 seconds. **SAb** will disappear from the display.

Should you experience a power failure or interruption, the oven will shut off. When power is returned the oven will not turn back on automatically. **SF** (Sabbath Failure) will be displayed in the oven control display and the surface element displays. The oven will remember that it is set for the Sabbath and the food may be safely removed from the oven while still in the Sabbath feature, however the oven cannot be turned back on until after the Sabbath. After the Sabbath observance turn OFF the Sabbath feature. Press and hold both the **HI**⁺_{hi} and **LO**⁻_{lo} pads for at least 3 seconds. **SAb** will disappear from the display and the oven may be used with all normal functions. For further assistance, guidelines for proper usage, and a complete list of models with the Sabbath feature, please visit the web at <http://www.star-k.org>.

Food poisoning hazard: do not let food sit for more than one hour before or after cooking. Doing so may result in food borne illness.





Notes for the use of the cooktop in Sabbath mode:

- No Sabbath mode is available for induction cooktops. When Sabbath mode is enabled, the cooktop will lock and it will not be possible to turn a cooking zone ON. If a cooking zone is ON when Sabbath is set, it will turn off.

User preferences

The User Preferences menu includes all user defined options. This feature enables you to control the various options of the electronic controls. This menu features the Time of Day, Celsius or Fahrenheit display mode, Continuous Bake or 12 Hour Energy Saving modes, Clock display or No-Clock display, 12 Hours Time of Day or 24 Hours Time of Day, Audio Control, and Adjusting the oven temperature. The User Preferences menu is only available when the oven is not being used (not cooking).

To browse through the User Preferences menu:

1. Press **USER PREF**  to bring up the User Preferences menu.
2. Press **USER PREF**  again to browse through the menu pages.
3. Press **hi** or **lo** to toggle between the available options.
4. Press **START**  while the chosen option is on display to change.
5. Press **CANCEL**  when finished to get back to the standard oven display.

User Preferences menu items:



- **CLO 12:00**; Setting the clock.
- **CLO on**; Clock on/off.
- **CLO 12hr**; 12/24 hour time of day display.
- **UPO**; Adjusting oven temperature.
- **F-C F**; Fahrenheit / Celsius display.
- **AUd**; Audio on/off and volume.
- **E S on**; 12 hour Energy Saving on/off.
- **rSt**; Reset to default factory settings.

Setting the clock - time of day

The clock may be set for 12 or 24 hour time of day operation (see advanced settings section). The clock has been preset at the factory for the 12 hour operation. When the range is first plugged in, or when the power supply to the range has been interrupted, the display will show "**CLO 12:00**". The clock must be set before the oven can be used.

When power to the unit has been interrupted, "**12:00**" appears and flashes in the display. To set the Clock in this case, skip step 1 in the example below and follow steps 2 and 3.



To set the clock (example for 1:30):

1. Press **USER PREF**  until you get to the **CLO 12:00** menu page.
2. Press **1 3 0** pads to set the time of day to 1:30. The pads **hi** or **lo** can also be pressed to raise or lower the actual time displayed.
3. Press **START**  to accept the changes and go back to user preferences menu display.

Setting clock display- on or off

The oven control can be programmed to display the time of day or not. The oven has been preset at the factory to display the time of day.



Changing clock display between ON and OFF:

1. Press **USER PREF**  until you get to the **CLO on** menu page.
2. Press **lo** or **hi** to toggle between displaying or hiding the clock.
3. Press **START**  to accept the changes and go back to user preferences menu display.

Setting time of day display - 12 or 24 hours

The oven control can be programmed to display time of day in 12 hours or 24 hours mode. The oven has been preset at the factory to display in 12 hours mode.

Changing between 12 or 24 hour time of day display:



1. Press **USER PREF**  until you get to the **CLO 12hr** menu page.
- +
2. Press **lo** or **hi** to toggle the display of the clock in 12 or 24 hours.
3. Press **START**  to accept the changes and go back to user preferences menu display.
4. Remember to set your clock after changing the time of day display mode.

Adjusting oven temperature

The temperature in the oven has been pre-set at the factory. When first using the oven, be sure to follow recipe times and temperatures. If you think the oven is too hot or too cool, the temperature in the oven can be adjusted. Before adjusting, test a recipe by using a temperature setting that is higher or lower than the recommended temperature. The baking results should help you to decide how much of an adjustment is needed. Each oven can be individually adjusted.

Do not use oven thermometers such as those found in grocery stores to check the temperature settings inside the oven. These thermometers may display temperatures that vary greatly from the actual temperature.



To adjust the oven temperature:

1. Press **USER PREFERENCES**  until you get to the **UPO** menu page.
2. To select the oven you want to adjust, press **USER PREFERENCES**  again to toggle between the upper and the lower display.
3. Enter the temperature by pressing the **hi** or **lo** pads. The temperature can only be adjusted by $\pm 35^{\circ}\text{F}$.
4. Press **START**  to accept the changes and go back to user preferences menu display.

Setting temperature display - Fahrenheit or Celsius

The oven control can be programmed to display temperatures in Fahrenheit or Celsius. The oven has been preset at the factory to display in Fahrenheit.



To change display from Fahrenheit to Celsius or Celsius to Fahrenheit:

1. Press **USER PREF**  until you get to the **F-C F** menu page.
2. Press **hi** or **lo** to toggle between the $^{\circ}\text{C}$ and $^{\circ}\text{F}$ display options.
3. Press **START**  to accept the changes and go back to user preferences menu display.

Audio control

The Audio Control feature allows the oven control to be operated without or with sounds whenever necessary. If desired the control can be programmed for silent operation and later returned to operating with all the default sounds and chimes. The volume of the chimes can also be adjusted.



To change the audio mode or audio volume:

1. Press **USER PREF**  until you get to the **AUd** menu page.
2. Press **hi** or **lo** to toggle between the available volume settings. **AUd 5** for the highest volume setting to **AUd 1** for the lowest volume. **AUd OFF** to disable the chimes.
3. Press **START**  to accept the changes and go back to user preferences menu display.

Setting continuous bake or 12 hour energy saving

The oven control has a factory preset built-in 12 Hour Energy Saving feature that will shut off the oven if the oven control is left on for more than 11 hours and 59 minutes. The oven can be programmed to override this feature for Continuous Baking.



Changing between 12 hour energy saving and continuous bake:

1. Press **USER PREF**  until you get to the **ES** menu page.
2. Press $\overset{+}{hi}$ or $\overset{-}{lo}$ to toggle the energy saving setting on and off.
3. Press **START**  to accept the changes and go back to user preferences menu display.

Re-setting to default factory settings

The oven control can be set to return to its original factory settings. This includes: Setting the Clock ON/OFF to ON, Setting the clock display mode to 12h, Display mode to Fahrenheit, Setting the oven temperature adjustment to zero, Setting audio level to 5 and Enabling the 12h energy saving mode. Resetting the control also erases the My Favorite recipes.

To reset the oven control to its original settings:

1. Press **USER PREF**  until you get to the **rSt no** menu page.
 2. Press $\overset{+}{hi}$ or $\overset{-}{lo}$ to select **YES**.
 3. Press **START**  to reset to default factory settings.
-

Using the self-clean feature

Adhere to the Following Cleaning Precautions:

- Allow the oven to cool before cleaning.
- Wear rubber gloves when cleaning any exterior parts of the oven manually.

During the self-cleaning cycle, the outside of the oven can become very hot to the touch. DO NOT leave small children unattended near the appliance.

Before cleaning any part of the oven, be sure the oven is turned off or else push **CANCEL** (⏏) pad. Wait until the oven is cool.

DO NOT use commercial oven cleaners or oven protective coatings in or around any part of the self-cleaning oven. **DO NOT** clean the oven door gasket. The gasket on the oven door is essential for a good seal. Care should be taken not to rub, damage or move the gasket. **DO NOT** use any cleaning materials on the gasket. Doing so could damage it. **DO NOT** use aluminum foil to line the oven bottom. This may affect cooking or foil could melt and damage the oven surface.

Preparing the Oven for Self-Cleaning:

- Remove any excess spillovers in the oven cavity before starting the self-cleaning cycle. To clean, use hot soapy water and a cloth. Large spillovers can cause smoke or a fire when subjected to high temperatures. **DO NOT** allow food spills with a high sugar or acid content (such as tomatoes, sauerkraut, fruit juices or pie filling) to remain on the surface as they may leave a dull spot even after cleaning.
- Clean any soil from the oven frame and the door liner (see illustration). These areas heat sufficiently during a self-clean to burn soil on. Clean with hot soapy water.

- Remove the broiler pan and insert, all utensils and any foil. These items can not withstand high cleaning temperatures.
- This model comes with lubricated porcelain oven racks, which can remain in the oven during the self-clean cycle. Do not clean this vegetable oil lubrication off the racks. It is important that the sides of the oven racks always have a light coating of vegetable oil. To maintain optimal rack performance, re-apply a thin layer of vegetable oil to the sides of the rack after every self-clean cycle or when the rack becomes difficult to slide.
- After a self-clean cycle, or anytime the gliding is rough, the glide racks should be treated with graphite lubrication. For instructions on how to care for your oven racks, see “Caring for Your Porcelain Enamelled Glide Racks” in the Care and Cleaning section.

CAUTION





- The health of some birds is extremely sensitive to the fumes given off during the self-cleaning cycle of any range. Move birds to another well-ventilated room.



Starting self-clean cycle



A self-cleaning oven cleans itself with high temperatures (well above cooking temperatures) which eliminate soil completely or reduce it to a fine powdered ash you can whisk away with damp cloth. If you are planning to use the oven directly after a self-clean cycle remember to allow time for the oven to cool down and the oven door to unlock. This normally takes about one hour.

To set the controls for a Self-Cleaning cycle:



1. Porcelain racks can stay in the oven during the self-clean cycle but it is recommended to remove them.
2. Be sure the clock is set with the correct time of day and the oven door is closed.
3. Select oven by pressing **UPPER OVEN** UPPER OVEN.
4. Press **CLEAN** .
5. Press **LITE** ● for a 2 hour self-clean, or press **MEDIUM** ●● for 3 hours, or press **HEAVY** ●●● for 4 hours.
6. Press **START** . The “**DOOR**  ” icon will flash.
7. As soon as the control is set, the motor driven oven door lock will begin to close automatically. Once the door has been locked the “**DOOR**  ” indicator light will stop flashing and remain on.

Note: When the oven is set to run a self-clean cycle, the motor door lock will begin locking the oven door. Do not open the oven door while the lock motor is running or when any locking indicators or displays are showing. The oven door is completely locked in about 15 seconds.

To set the controls for a delayed Self-Cleaning cycle:

1. Follow the instructions above.
2. Press **COOK OPTIONS**  to bring up the cook options items.
3. Press **END TIME** .
4. Enter time of day needed for the end of the cycle (example for “6:00”; **6** **0** **0**).
5. Press **START** .

When the Self-Clean Cycle is Completed:

1. The time of day and “**DOOR**  ” will remain ON.
2. The display will show an “**Hot**” message while the oven is still too hot to open door.
3. Once the oven has cooled down for 1 HOUR, and the “**DOOR**  ” icon is no longer displayed, the oven door can then be opened.

Stopping or Interrupting a Self-Cleaning Cycle:

If it becomes necessary to stop or interrupt a self-cleaning cycle due to excessive smoke:

1. Press **CANCEL** .
2. Once the oven has cooled down for approximately 1 HOUR and the “**DOOR**  ” icon is no longer displayed, the oven door can then be opened.

WARNING

- During the self-cleaning cycle, the outside of the appliance can become very hot to the touch. **DO NOT** leave small children unattended near the appliance; they may be burned if they touch the hot oven door surfaces.
- Do not force the oven door open when self-clean is active. This can damage the automatic door-locking system. Use caution when opening the door after self-clean cycle is complete; the oven may still be very hot.
- The oven bake and broil elements may appear to have cooled after they have been turned off. The elements may still be hot and burns may occur if these elements are touched before they have cooled.
- To avoid possible burns, use care when opening the oven door after the self-cleaning cycle. Stand to the side of the oven when opening the door to allow hot steam and air to escape.

Cleaning various parts of your appliance chart

Cleaning Various Parts of Your appliance

Before cleaning any part of the appliance, be sure all controls are turned OFF and the appliance is COOL. REMOVE SPILLOVERS AND HEAVY SOILING AS SOON AS POSSIBLE. REGULAR CLEANINGS WILL REDUCE THE NUMBER OF MAJOR CLEANINGS LATER

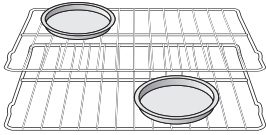
Surfaces	How to Clean
Glass, Painted and Plastic Body Parts and Decorative Trim	<i>For general cleaning</i> , use hot, soapy water and a cloth. <i>For more difficult soils and built-up grease</i> , apply a liquid detergent directly onto the soil. Leave on soil for 30 to 60 minutes. Rinse with a damp cloth and dry. DO NOT use abrasive cleaners on any of these materials; they can scratch.
Control Panel	<i>Before cleaning the control panel</i> , turn all controls to OFF. Lightly spray the control panel with a liquid cleaner. Wipe with a soft cloth or paper towel. DO NOT use abrasive cleaners or scouring pads. These can permanently damage the control panel surface.
Porcelain Enamel Broiler Pan and Grid	Gentle scouring with a soapy scouring pad will remove most spots. Rinse with a 1:1 solution of clear water and ammonia. <i>If necessary</i> , cover difficult spots with an ammonia-soaked paper towel for 30 to 40 minutes. Rinse with clean water and a damp cloth, and then scrub with a soap-filled scouring pad. Rinse and wipe dry with a clean cloth. Remove all cleaners or the porcelain may become damaged during future heating.
Stainless Steel, Chrome Decorative Trim, Oven Racks, Oven Racks Support	Clean with hot, soapy water and a dishcloth. Rinse with clean water and a cloth. Cover stubborn spots with an ammonia-soaked paper towel for 30 to 40 minutes. Rinse. Cleaners made especially for stainless steel are recommended. Be sure to rinse the cleaners as bluish stains may occur during heating and cannot be removed.
Porcelain Coated Oven Racks 	This oven comes with lubricated porcelain oven racks, which can remain in the oven during the self-clean cycle. Do not clean this vegetable oil lubrication off the racks. It is important that the sides of the oven racks always have a light coating of vegetable oil. To maintain optimal rack performance, re-apply a thin layer of vegetable oil to the sides of the rack after every self-clean cycle or when the rack becomes difficult to slide. For instructions on how to care for your glide racks, see “Caring for Your Porcelain Enameled Glide Racks” on page 46.
Oven Door	To clean oven door, wash with hot, soapy water and a clean cloth. DO NOT immerse the door in water or clean the oven door gasket
Oven Door Gasket	The oven gasket located on the inner frame of the door and visible when the door is opened is essential for a good seal. Care should be taken not to rub, damage or remove the gasket.
Lower Oven	To remove burned-on fat on oven walls, moisten soiled parts with household ammonia, using a wet cloth. Complete cleaning with a damp cloth and use a fine steel wool scouring agent if necessary.

Care and cleaning of stainless steel

Special care and cleaning are **required** for maintaining the appearance of stainless parts. Please refer to the table provided at the beginning of the **General Care & Cleaning** section in this Use & Care Manual.

Special door care instructions

➔ IMPORTANT

Most oven doors contain glass that can break. Read the following recommendations:

- **Do not** close the oven door until all the interior oven racks are fully inserted and retracted to the back of the oven.
- Do not hit the glass with pots, pans, or any other object. The oven door glass may break or even break at a later time unexpectedly.
- Scratching, hitting, jarring or stressing the oven door glass may weaken its structure causing an increased risk of breakage at a later time.
- You may use a glass cleaner on the outside of the oven door glass. **Do not spray** or allow water or the cleaner to enter or drip down into the oven door vents. Spray cleaner on cloth first and then wipe the oven door clean.
- **Do not** use strong oven cleaners, powders or any harsh abrasive cleaning materials on the outside of the oven door or glass.
- **Never clean** the oven door gasket. The oven door gasket should always clean during the Self-clean cycle.

Replacing the dual left/right corner oven lights

The interior oven lights are located at the rear of the oven cavity and are covered with a glass shield. The glass shield must be in place whenever the oven is in use.

To replace the oven interior light bulb:

⚠ CAUTION

Be sure the range is unplugged and all parts are **COOL** before replacing oven light. Wear a leather-faced glove for protection against possible broken glass.

1. Turn electrical power off at the main source.
2. Remove interior oven light shield by turning a quarter turn counter-clockwise.
3. Replace bulb with a new T-4 type Halogen 25 watt appliance bulb. Do not twist the bulb, pull it straight out.

IMPORTANT! Do not allow your fingers to touch the new bulb when replacing. This will shorten the life of the bulb. Use a paper towel or cotton glove while handling the new bulb when installing.

4. Replace glass oven light shield by rotating clockwise.
5. Turn power back on again at the main source (or plug the appliance back in).
6. Be sure to reset the time of day on the clock.

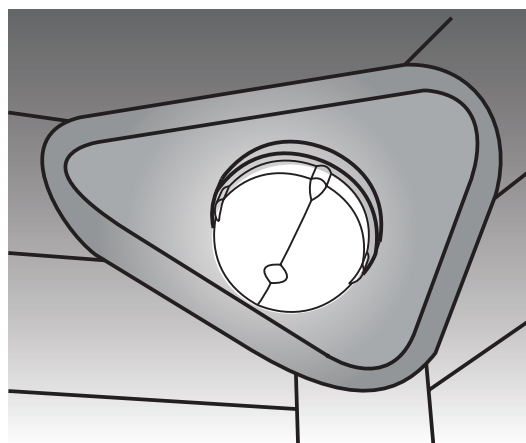

Removing and replacing the oven door

CAUTION

To prevent possible burns, do not attempt to remove the oven door until the oven has completely cooled.

WARNING

The door is heavy. Be careful when removing and lifting the door. Do not lift the oven door by the handle.

To Remove Oven Door:

1. Open oven door completely (horizontal with floor- Fig. 1).
2. Pull the door hinge locks on both left and right door hinges down from the oven frame completely towards the oven door (Fig. 2). A tool such as a small flat-blade screwdriver may be required.
3. Firmly grasp both sides of oven door along the door sides (Do not use the oven door handle).
4. Close the door to about a 10 degrees. The oven door will stop into this position just before fully closing.
5. With the oven door in this position (Fig. 3), lift and carefully pull the oven door away from the oven frame. To avoid finish damage, be careful not to allow the oven door hinges to contact the oven front frame.

To Replace Oven Door:

1. Firmly grasp both sides of oven door along the door sides (Do not use the oven door handle).
2. Holding the oven door at the same angle as the removal position, carefully line up and insert both door hinge arms between the pins located on each side of the oven door frame (Fig. 4)
3. With both door hinge arms in place, open the oven door (horizontal with floor- Fig. 1).
4. Push the door hinge locks up towards and into the oven frame for both left and right oven door hinges (Fig. 2) to the locked position.
5. Close the oven door.

Special Door Care Instructions

CAUTION - Most oven doors contain glass that can break.

Read the following recommendations:

- Do not close the oven door until all the oven racks are fully in place.
- Do not hit the glass with pots, pans, or any other object.
- Scratching, hitting, jarring or stressing the glass may weaken its structure causing an increased risk of breakage at a later time.

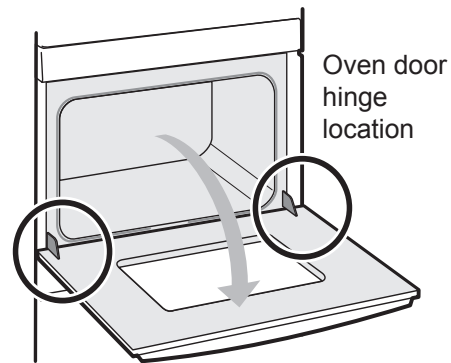

Figure 1 - Door hinge location

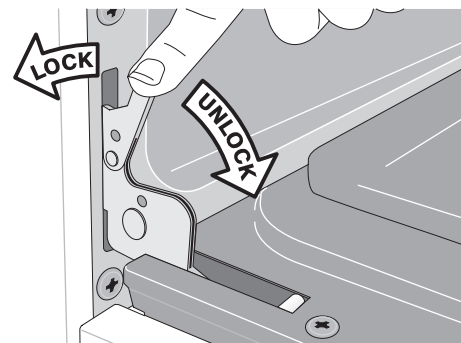

Figure 2 - Door hinge locks

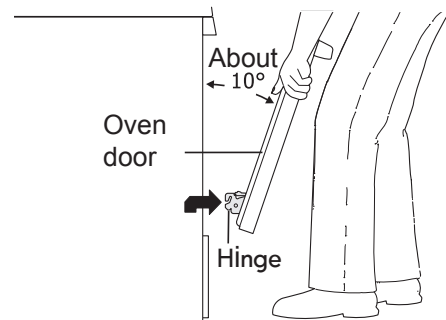

Figure 3 - Holding door for removal

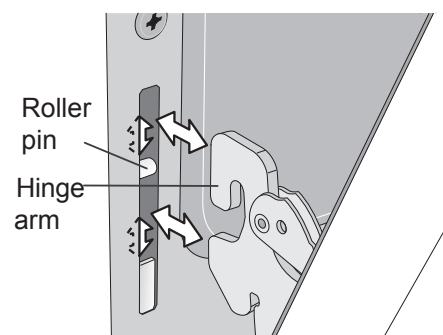

Figure 4 - Location of hinge arm and roller pin

Cooktop cleaning and maintenance

Consistent and proper cleaning is essential to maintaining your ceramic glass cooktop

Prior to using your cooktop for the first time, apply the recommended Cleaning Creme to the ceramic surface. A sample of that cleaning creme is supplied with your cooktop and it is available in most hardware stores. Clean and buff with a paper towel. This will make cleaning easier when soiled from cooking. The special cooktop cleaning cream leaves a protective finish on the glass to help prevent scratches and abrasions.

Sliding aluminum or copper clad bottom pans on the cooktop can cause metal markings on the cooktop surface. These marks should be removed **immediately** after the cooktop has cooled using the cooktop cleaning cream. Metal marks can become permanent if not removed prior to future use.

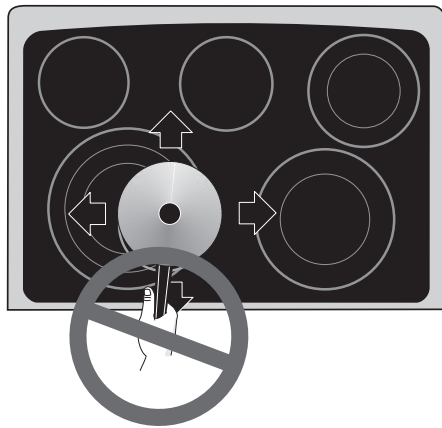

Cookware (cast iron, metal, ceramic or glass) with rough bottoms can mark or scratch the cooktop surface. **Do not slide anything metal or glass** across the cooktop. **Do not** use your cooktop as a cutting board or work surface in the kitchen. **Do not** cook foods directly on the cooktop surface without a pan. **Do not** drop heavy or hard objects on the glass cooktop, they may cause it to crack or break.

Cleaning recommendations for the ceramic glass cooktop

CAUTION

Before cleaning the cooktop, be sure the controls are turned to OFF and the cooktop is COOL.

WARNING

DO NOT use a cooktop cleaner on a hot cooktop. The fumes can be hazardous to your health, and can chemically damage the ceramic-glass surface.

For light to moderate soil:

Apply a few drops of CookTop® Cleaning Creme directly to the cooktop. Use a paper towel to clean the entire cooktop surface. Make sure the cooktop is cleaned thoroughly, leaving no residue. Do not use the towel you use to clean the cooktop for any other purpose.

For heavy, burned on soil:

First, clean the surface as described above. Then, if soils remain, carefully scrape soils with a metal razor blade scraper, holding scraper at a 30 degree angle to the surface. Remove loosened soils with cooktop cleaning cream and buff surface clean.

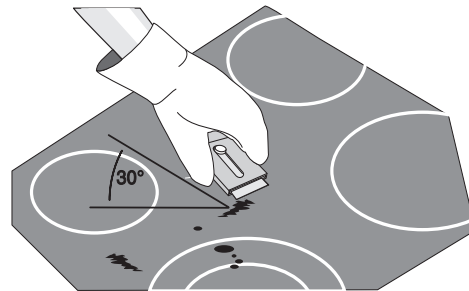

Cleaning recommendations for the ceramic glass cooktop (continued)

CAUTION

Damage to the ceramic glass cooktop may occur if you use scrub pad.

Plastic or foods with a high sugar content:

These types of soils must be removed immediately if spilled or melted onto the ceramic cooktop surface. Permanent damage (such as pitting of the cooktop surface) may occur if not removed **immediately**. After turning the surface elements OFF, use a razor blade scraper or a metal spatula with a mitt and scrape the soil from the hot surface (as illustrated on previous page). Allow the cooktop to cool, and use the same method for heavy or burned on soils.

Special Caution for Aluminum Foil and Aluminum Cooking Utensils

- **Aluminum foil** - Use of aluminum foil will damage the cooktop. Do not use thin aluminum cooking utensils or allow foil to touch the ceramic cooktop under ANY circumstances.
- **Aluminum utensils** - The melting point of aluminum is much lower than that of other metals. Care must be taken when aluminum pots or pans are used on the cooktop. If allowed to boil dry, not only will the utensil be destroyed, but it may fuse to, break or mark the ceramic glass surface, permanently damaging the cooktop surface.

Do not use the following on the ceramic glass cooktop:



- Do not use abrasive cleaners and scouring pads, such as metal and some nylon pads. They may scratch the cooktop, making it more difficult to clean.
- Do not use harsh cleaners, such as chlorine bleach, ammonia or oven cleaners, as they may etch or discolor the cooktop.
- Do not use dirty sponges, cloths or paper towels, as they can leave soil or lint on the cooktop which can burn and cause discoloration.

Broiler pan cleaning tips

To make cleaning easier, line the bottom of the broiler pan with aluminum foil. DO NOT cover the broiler grid with foil.

To prevent grease from baking on, remove the broiler pan from the oven as soon as cooking is completed. Use hot pads because the broiler pan is extremely hot. Pour off grease. Soak the pan in HOT, soapy water.

Clean the broiler pan as soon as possible after each use. If necessary, use soap-filled steel wool pads. Heavy scouring may scratch the grid.

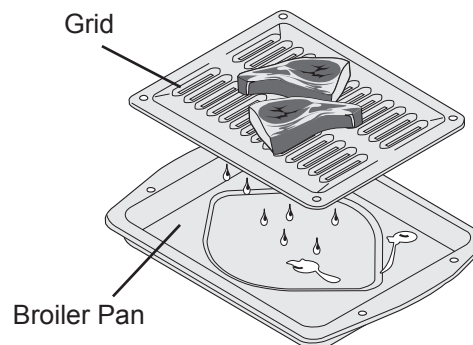

Caring for your porcelain enameled glide racks

CAUTION

Handle oven racks only when they are cool. After cooking or after the self clean cycle, racks will be very hot and can cause burns.

IMPORTANT

- It is recommended to remove all racks from the oven during self-clean cycles, but porcelain racks may be left in the oven if they are soiled. After a self clean cycle, or anytime the gliding is rough, the glide racks should be treated with graphite lubrication.
- Do not use cooking oil, cooking spray, or other oil-based lubrication products on the glide rack extension tracks. Use only the graphite lubrication in this area. To order graphite lubrication, contact your installer, servicer or dealer.
- It is important that the parts of the rack that contact the oven sides always have a light coating of vegetable oil. Apply a thin layer of vegetable oil to the sides of the rack after every self-clean cycle and when the rack becomes difficult to reposition in the oven.

To lubricate the glide rack:

1. Remove the rack from the oven and place the rack on a large flat surface covered with newspaper or scrap cloth. Fully extend the rack.
2. Wipe away debris and crumbs from the glide track using a cloth or sponge.

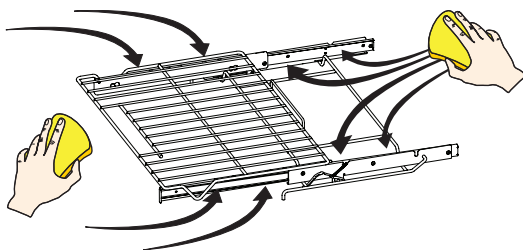

3. Shake graphite lubrication very well before applying. Apply to loading guides, and rotation pin. Repeat on both sides of the glide rack.

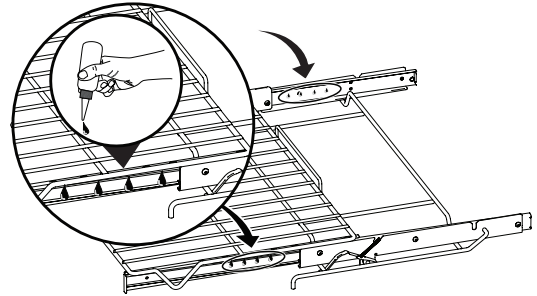

4. Extend and return the glide rack several times along the tracks to distribute the lubrication.

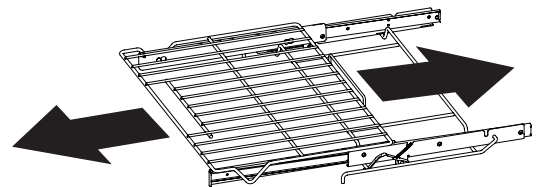

5. Turn the rack upside down and apply graphite lubrication to the insides of the loading guides.

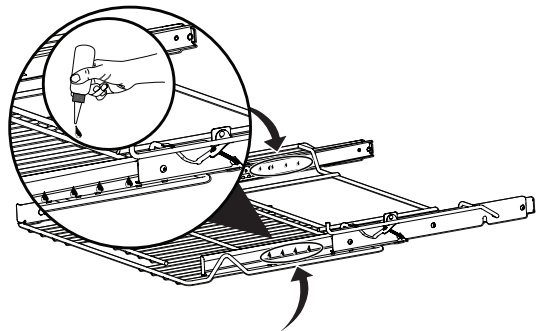

6. Extend and return the glide rack several times along the tracks to distribute the lubrication.
7. Apply a thin layer of cooking oil to the bottom of the "V" and the glide channels. Keeping the frame sides lightly lubricated allows the entire rack to slide easily when changing rack positions.

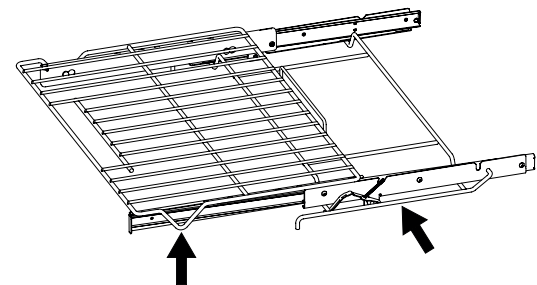





8. Replace rack in oven right-side up.

Baking problems

For best cooking results pre-heat the oven when baking cookies, breads, cakes, pies or pastries, etc. There is no need to preheat the oven for roasting meats or baking casseroles. The cooking times and temperatures needed to bake a product may vary slightly from your previous appliance.

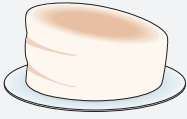
Baking Problems and Solutions Chart

BAKING PROBLEMS	CAUSES	CORRECTIONS
Cookies and biscuits burn on the bottom. 	<ul style="list-style-type: none"> • Cookies and biscuits put into the oven before the preheating time is completed. • Oven rack overcrowded. • Dark pan absorbs heat too fast. 	<ul style="list-style-type: none"> • Allow oven to preheat to the selected temperature before placing food in oven. • Choose pan sizes that will permit 5.1 cm to 10.2 cm (2" to 4") of air space on all sides when placed in the oven. • Use a medium-weight aluminum baking sheet.
Cakes too dark on top or bottom. 	<ul style="list-style-type: none"> • Cakes put into the oven before preheating time is completed. • Rack position too high or low. • Oven too hot. 	<ul style="list-style-type: none"> • Allow oven to preheat to the selected temperature before placing food in the oven. • Use proper rack position for baking needs. • Set oven temperature 25°F/12°C lower than recommended.
Cakes not done in the center. 	<ul style="list-style-type: none"> • Oven too hot. • Incorrect pan size. • Pan not centered in oven. 	<ul style="list-style-type: none"> • Set oven temperature 25°F/12°C lower than recommended. • Use pan size suggested in recipe. • Use proper rack position and place pan so there is 5.1cm to 10.2cm (2" to 4") of space on all sides of pan.
Cakes not level. 	<ul style="list-style-type: none"> • Range not level. • Pan too close to oven wall or rack overcrowded. • Pan warped. • Oven light left on during baking 	<ul style="list-style-type: none"> • Place a marked glass measuring cup filled with water on the center of the oven rack. If the water level is uneven, refer to the installation instructions for leveling the range. • Be sure to allow 5.1cm to 10.2cm (2" to 4") of clearance on all sides of each pan in the oven. • Do not use pans that are dented or warped. • Do not leave oven light on while baking.
Foods not done when cooking time is up. 	<ul style="list-style-type: none"> • Oven too cool. • Oven overcrowded. • Oven door opened too frequently. 	<ul style="list-style-type: none"> • Set oven temperature 25°F/12°C higher than suggested and bake for the recommended time. • Be sure to remove all pans from the oven except the ones to be used for baking. • Open oven door only after shortest recommended baking time.

Before calling for service, review this list. It may save you both time and expense. This list includes common experiences that are not the result of defective workmanship or material in your cooktop.

Before you call	
Problem	Solution
Oven control chimes and displays an F error code.	<ul style="list-style-type: none"> Electronic control has detected a fault condition. Push CANCEL pad to clear the display and stop the display from beeping. Reprogram the oven. If a fault reoccurs, record the fault number, push the CANCEL pad and contact an authorized servicer.
Installation	<ul style="list-style-type: none"> Place oven rack in center of oven. Place a level on the oven rack. Contact installing agent if rack and cabinet cutout flooring are not level. Kitchen cabinet misalignment may make range appear to be not level. Be sure cabinets are square and level. Contact cabinet maker to correct problem.
Entire range does not operate	<ul style="list-style-type: none"> When the range is first plugged in, or when the power supply to the oven has been interrupted, the display will flash. The range cannot be programmed until the clock is set. Be sure electrical cord is securely connected into the electrical junction box. Cord/plug is not installed and/or connected. Cord is not supplied with range. Contact your dealer, installing agent or authorized servicer. Service wiring not complete. Contact your dealer, installing agent or authorized servicer. Power outage. Check house lights to be sure. Call your local electric company. Short in cord/plug. Replace cord/plug. Controls are not set properly. See instructions to set the controls. House fuse has blown or circuit breaker has tripped immediately following installation. House fuse may not be fully engaged. Check fuse and screw or engage circuit breaker securely.
Oven light does not work	<ul style="list-style-type: none"> Burned-out or loose bulb. Follow the instructions under Oven Light to replace or tighten the bulb.
Self-cleaning cycle does not work	<ul style="list-style-type: none"> Make sure the oven door is closed. Controls not set properly. Follow instructions under "Setting Self-Clean".
Oven smokes excessively during broiling	<ul style="list-style-type: none"> Meat too close to the broiler element. Reposition the rack to provide more clearance between the meat and the broiler. Preheat broil element for quick searing operation. Meat not properly prepared. Remove excess fat from meat. Cut remaining fatty edges to prevent curling, but do not cut into the lean. Grid on broiler pan wrong side-up. Grease does not drain into broiler pan. Always place the grid on the broiler pan with the ribs up and the slots down to allow grease to drip into the pan. Broiler pan used without grid or grid cover with aluminum foil. DO NOT use the broiler pan without the grid or cover the grid with aluminum foil. Oven needs to be cleaned. Grease has built up on oven surfaces. Regular cleaning is necessary when broiling frequently. Grease or food spatters cause excessive smoking.

Before you call

Problem	Solution
Soil not completely remove after self-cleaning cycle is completed	<ul style="list-style-type: none"> • Failure to clean bottom, from top of oven, frame of oven or door area outside oven seal. These areas are not in the self-cleaning area, but get hot enough to burn on residue. Clean these areas before the self-cleaning cycle is started. Burned on residue can be cleaned with a stiff nylon brush and water or a nylon scrubber. Be careful not to damage the oven gasket. • Excessive spillovers in oven. Set the self-clean cycle for longer cleaning time.
Poor cooking results	<ul style="list-style-type: none"> • Many factors affect baking results. See baking for hints, cause and corrections. See Adjusting Oven Temperature. • Adjust the recipe's recommended power levels or cooking times. • Cookware is too lightweight or warped. Use heavier quality cookware so foods being prepared may cook more evenly.
Flames inside oven or smoking from oven vent	<ul style="list-style-type: none"> • Excessive spillovers in oven. This is normal, especially for high oven temperatures, pie spillovers or for large amounts of grease on bottom of oven. Wipe up excessive spillovers.
Surface element does not heat	<ul style="list-style-type: none"> • No power to appliance. Check/reset breaker or replace fuse. If the problem is a circuit overload, or improper connection of the armored cable supplied with the appliance, have this situation corrected by a qualified electrician. • Too low heat setting. Turn control to a slightly higher setting until element comes on. • Incorrect control is ON. Be sure to use correct control for the element needed. • No cookware was placed on the induction cooking zones or the cookware material type is incorrect for induction cooking.
Surface element too hot or not hot enough	<ul style="list-style-type: none"> • Incorrect control setting. Raise or lower setting until proper amount of heat is obtained. Dial markings are an indicator of relative heat settings and will vary slightly. • Lightweight or warped pans being used. Use only flat, evenly balanced, medium or heavyweight cookware. • Voltage is incorrect. Be sure appliance is properly connected to the specified power source. • Use only flat bottom, evenly balanced, medium or heavyweight cookware. Pans having a flat bottom heat better than warped pans. Cookware material affects heating. Heavy and medium weight pans heat evenly. Because lightweight pans heat unevenly, foods may burn easily.
Food not heating evenly	<ul style="list-style-type: none"> • Improper cookware. Select flat-bottomed cookware of a proper size to fit element. • Incorrect control setting. Raise or lower setting until proper amount of heat is obtained.
Oven racks do not slide easily.	<ul style="list-style-type: none"> • This oven comes with lubricated porcelain oven racks, which can remain in the oven during the self-clean cycle. Do not clean this vegetable oil lubrication off the racks. It is important that the sides of the oven racks always have a light coating of vegetable oil. To maintain optimal rack performance, re-apply a thin layer of vegetable oil to the sides of the rack after every self-clean cycle or when the rack becomes difficult to slide.

Before you call

Problem	Solution
Glide racks do not slide smoothly	<ul style="list-style-type: none"> Glide racks need lubrication. For instructions on how to care for your oven racks, see “Caring for Your Porcelain Enameled Glide Racks” on page 46.
Scratches or abrasions on ceramic glass cooktop surface	<ul style="list-style-type: none"> Coarse particles (such as salt or sand) are between cooktop and utensil. Be sure cooktop surface and bottom of utensils are clean before use. Small scratches do not affect cooking and will become less visible with use. Cleaning materials not recommended for glass ceramic cooktop have been used. See Ceramic-Glass Cooktop section in this Owner’s Guide. Cookware with rough bottom has been used. Use flat-bottomed, smooth utensils. See Selecting Surface Cooking Utensils in this Owner’s Guide
Brown streaks and specks on ceramic glass cooktop surface	<ul style="list-style-type: none"> Boilovers have cooked onto surface. Use razor blade scraper to remove soil. See instructions under General Care & Cleaning. Cleaning materials not recommended for ceramic-glass cooktop have been used. Use recommended cleaners and cleaning method. See Ceramic-Glass Cooktop section in this Owner’s Guide.
Areas of discoloration on ceramic glass cooktop surface	<ul style="list-style-type: none"> Mineral deposits from water and food. Wet surface with water and sprinkle on a cooktop cleaning creme. Scrub with a clean damp paper towel until the stain disappears. Wipe remaining paste away, then apply a small amount of cooktop cleaning creme and polish with a clean paper towel. Use cookware with clean, dry bottoms. See Ceramic-Glass Cooktop section in this Owner’s Guide.
Metal marks on ceramic glass cooktop surface	<ul style="list-style-type: none"> Sliding or scraping of metal utensils on cooktop surface. Do not slide metal utensils on cooktop surface. Use a mildly abrasive cleanser to remove marks

Your appliance is covered by a one year limited warranty. For one year from your original date of purchase, Electrolux will repair or replace any parts of this appliance that prove to be defective in materials or workmanship when such appliance is installed, used, and maintained in accordance with the provided instructions. In addition, the glass cooktop or radiant surface element of your appliance (excluding built-in and free-standing range appliances) is covered by a two through five year limited warranty. During the 2nd through 5th years from your original date of purchase, Electrolux will provide a replacement glass cooktop or radiant surface element for your appliance which has proven to be defective in materials or workmanship when such appliance is installed, used, and maintained in accordance with the provided instructions.

Exclusions

This warranty does not cover the following:

1. Products with original serial numbers that have been removed, altered or cannot be readily determined.
2. Product that has been transferred from its original owner to another party or removed outside the USA or Canada.
3. Rust on the interior or exterior of the unit.
4. Products purchased "as-is" are not covered by this warranty.
5. Food loss due to any refrigerator or freezer failures.
6. Products used in a commercial setting.
7. Service calls which do not involve malfunction or defects in materials or workmanship, or for appliances not in ordinary household use or used other than in accordance with the provided instructions.
8. Service calls to correct the installation of your appliance or to instruct you how to use your appliance.
9. Expenses for making the appliance accessible for servicing, such as removal of trim, cupboards, shelves, etc., which are not a part of the appliance when it is shipped from the factory.
10. Service calls to repair or replace appliance light bulbs, air filters, water filters, other consumables, or knobs, handles, or other cosmetic parts.
11. Labor or in-home service costs during the additional limited warranty periods beyond the first year from your original date of purchase.
12. Pickup and delivery costs; your appliance is designed to be repaired in the home.
13. Surcharges including, but not limited to, any after hour, weekend, or holiday service calls, tolls, ferry trip charges, or mileage expense for service calls to remote areas, including the state of Alaska.
14. Damages to the finish of appliance or home incurred during transportation or installation, including but not limited to floors, cabinets, walls, etc.
15. Damages caused by: services performed by unauthorized service companies; use of parts other than genuine Electrolux parts or parts obtained from persons other than authorized service companies; or external causes such as abuse, misuse, inadequate power supply, accidents, fires, or acts of God.

DISCLAIMER OF IMPLIED WARRANTIES; LIMITATION OF REMEDIES

CUSTOMER'S SOLE AND EXCLUSIVE REMEDY UNDER THIS LIMITED WARRANTY SHALL BE REPAIR OR REPLACEMENT AS PROVIDED HEREIN. **CLAIMS BASED ON IMPLIED WARRANTIES, INCLUDING WARRANTIES OF MERCHANTABILITY OR FITNESS FOR A PARTICULAR PURPOSE, ARE LIMITED TO ONE YEAR OR THE SHORTEST PERIOD ALLOWED BY LAW, BUT NOT LESS THAN ONE YEAR.** ELECTROLUX SHALL NOT BE LIABLE FOR CONSEQUENTIAL OR INCIDENTAL DAMAGES SUCH AS PROPERTY DAMAGE AND INCIDENTAL EXPENSES RESULTING FROM ANY BREACH OF THIS WRITTEN LIMITED WARRANTY OR ANY IMPLIED WARRANTY. SOME STATES AND PROVINCES DO NOT ALLOW THE EXCLUSION OR LIMITATION OF INCIDENTAL OR CONSEQUENTIAL DAMAGES, OR LIMITATIONS ON THE DURATION OF IMPLIED WARRANTIES, SO THESE LIMITATIONS OR EXCLUSIONS MAY NOT APPLY TO YOU. THIS WRITTEN WARRANTY GIVES YOU SPECIFIC LEGAL RIGHTS. YOU MAY ALSO HAVE OTHER RIGHTS THAT VARY FROM STATE TO STATE.

If You Need Service

Keep your receipt, delivery slip, or some other appropriate payment record to establish the warranty period should service be required. If service is performed, it is in your best interest to obtain and keep all receipts. Service under this warranty must be obtained by contacting Electrolux at the addresses or phone numbers below.

This warranty only applies in the USA, Puerto Rico and Canada. In the USA and Puerto Rico, your appliance is warranted by Electrolux Major Appliances North America, a division of Electrolux Home Products, Inc. In Canada, your appliance is warranted by Electrolux Canada Corp. Electrolux authorizes no person to change or add to any obligations under this warranty. Obligations for service and parts under this warranty must be performed by Electrolux or an authorized service company. Product features or specifications as described or illustrated are subject to change without notice.

USA

1.800.944.9044

Electrolux Home Products, Inc.,
10200 David Taylor Drive
Charlotte, NC 28262

Canada

1-800-265-8352

Electrolux Canada Corp.
5855 Terry Fox Way
Mississauga, Ontario, Canada L5V 3E4

electrolux.com/shop



CE

