



# GAS RANGE USER INSTRUCTIONS

THANK YOU for purchasing this high-quality product. Register your range at [www.whirlpool.com](http://www.whirlpool.com). In Canada, register your range at [www.whirlpool.ca](http://www.whirlpool.ca).

For future reference, please make a note of your product model and serial numbers. These can be located on the oven frame behind the top right side of the oven door.

Model Number \_\_\_\_\_ Serial Number \_\_\_\_\_

Para una versión en español, visite: [www.whirlpool.com](http://www.whirlpool.com).

Deberá tener a mano el número de modelo y de serie, que está ubicado en el marco del horno detrás del lado superior izquierdo de la puerta del horno.

## Table of Contents

<b>RANGE SAFETY</b> .....	<b>2</b>
The Anti-Tip Bracket .....	3
<b>FEATURE GUIDE</b> .....	<b>4</b>
<b>COOKTOP USE</b> .....	<b>5</b>
Sealed Surface Burners .....	5
Burner Size .....	6
Cookware .....	6
Home Canning .....	7
<b>OVEN USE</b> .....	<b>7</b>
Electronic Oven Controls .....	7
Sabbath Mode .....	8
Aluminum Foil .....	8
Positioning Racks and Bakeware .....	9
Oven Vent .....	9
Baking and Roasting .....	9
Broiling .....	9
Cook Time .....	10
<b>RANGE CARE</b> .....	<b>10</b>
Self-Cleaning Cycle .....	10
General Cleaning .....	11
Oven Light .....	11
<b>TROUBLESHOOTING</b> .....	<b>12</b>
<b>ACCESSORIES</b> .....	<b>15</b>
<b>WARRANTY</b> .....	<b>16</b>

# RANGE SAFETY

## Your safety and the safety of others are very important.

We have provided many important safety messages in this manual and on your appliance. Always read and obey all safety messages.



This is the safety alert symbol.

This symbol alerts you to potential hazards that can kill or hurt you and others.

All safety messages will follow the safety alert symbol and either the word "DANGER" or "WARNING."

These words mean:

**⚠ DANGER**

You can be killed or seriously injured if you don't immediately follow instructions.

**⚠ WARNING**

You can be killed or seriously injured if you don't follow instructions.

All safety messages will tell you what the potential hazard is, tell you how to reduce the chance of injury, and tell you what can happen if the instructions are not followed.

**WARNING: If the information in these instructions is not followed exactly, a fire or explosion may result causing property damage, personal injury or death.**

- **Do not store or use gasoline or other flammable vapors and liquids in the vicinity of this or any other appliance.**
- **WHAT TO DO IF YOU SMELL GAS:**
  - **Do not try to light any appliance.**
  - **Do not touch any electrical switch.**
  - **Do not use any phone in your building.**
  - **Immediately call your gas supplier from a neighbor's phone. Follow the gas supplier's instructions.**
  - **If you cannot reach your gas supplier, call the fire department.**
- **Installation and service must be performed by a qualified installer, service agency or the gas supplier.**

**WARNING:** Gas leaks cannot always be detected by smell.

Gas suppliers recommend that you use a gas detector approved by UL or CSA.

For more information, contact your gas supplier.

If a gas leak is detected, follow the "What to do if you smell gas" instructions.

State of California Proposition 65 Warnings:

**WARNING:** This product contains one or more chemicals known to the State of California to cause cancer.

**WARNING:** This product contains one or more chemicals known to the State of California to cause birth defects or other reproductive harm.

## The Anti-Tip Bracket

The range will not tip during normal use. However, the range can tip if you apply too much force or weight to the open door without the anti-tip bracket fastened down properly.



### ⚠ WARNING

#### Tip Over Hazard

**A child or adult can tip the range and be killed.**

**Verify the anti-tip bracket has been properly installed and engaged per installation instructions.**

**Re-engage anti-tip bracket if range is moved.**

**Do not operate range without anti-tip bracket installed and engaged.**

**Failure to follow these instructions can result in death or serious burns to children and adults.**

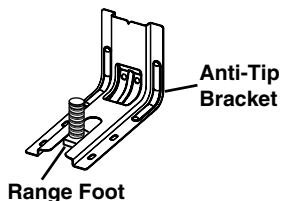

**To verify the anti-tip bracket is installed and engaged:**

- Slide range forward.
- Look for the anti-tip bracket securely attached to floor or wall.
- Slide range back so rear range foot is under anti-tip bracket.
- See installation instructions for details.

## IMPORTANT SAFETY INSTRUCTIONS

**WARNING:** To reduce the risk of fire, electrical shock, injury to persons, or damage when using the range, follow basic precautions, including the following:

- **WARNING:** TO REDUCE THE RISK OF TIPPING OF THE RANGE, THE RANGE MUST BE SECURED BY PROPERLY INSTALLED ANTI-TIP DEVICES. TO CHECK IF THE DEVICES ARE INSTALLED PROPERLY, SLIDE RANGE FORWARD, LOOK FOR ANTI-TIP BRACKET SECURELY ATTACHED TO FLOOR OR WALL, AND SLIDE RANGE BACK SO REAR RANGE FOOT IS UNDER ANTI-TIP BRACKET.
- **WARNING:** NEVER use this appliance as a space heater to heat or warm the room. Doing so may result in carbon monoxide poisoning and overheating of the oven.
- **WARNING:** NEVER cover any slots, holes or passages in the oven bottom or cover an entire rack with materials such as aluminum foil. Doing so blocks air flow through the oven and may cause carbon monoxide poisoning. Aluminum foil linings may also trap heat, causing a fire hazard.
- **CAUTION:** Do not store items of interest to children in cabinets above a range or on the backguard of a range – children climbing on the range to reach items could be seriously injured.

- Proper Installation – The range, when installed, must be electrically grounded in accordance with local codes or, in the absence of local codes, with the *National Electrical Code, ANSI/NFPA 70*. Be sure the range is properly installed and grounded by a qualified technician.
- This range is equipped with a three-prong grounding plug for your protection against shock hazard and should be plugged directly into a properly grounded receptacle. Do not cut or remove the grounding prong from this plug.
- Disconnect power before servicing.
- Injuries may result from the misuse of appliance doors or drawers such as stepping, leaning, or sitting on the doors or drawers.
- Maintenance – Keep range area clear and free from combustible materials, gasoline, and other flammable vapors and liquids.
- Storage in or on the Range – Flammable materials should not be stored in an oven or near surface units.
- Top burner flame size should be adjusted so it does not extend beyond the edge of the cooking utensil.

#### For self-cleaning ranges –

- Before Self-Cleaning the Oven – Remove broiler pan and other utensils. Wipe off all excessive spillage before initiating the cleaning cycle.

## SAVE THESE INSTRUCTIONS

# FEATURE GUIDE

This manual covers several models. Your model may have some or all of the items listed. Refer to this manual or the Frequently Asked Questions (FAQs) section of our website at [www.whirlpool.com](http://www.whirlpool.com) for more detailed instructions. In Canada, refer to the Customer Service Section at [www.whirlpool.ca](http://www.whirlpool.ca).

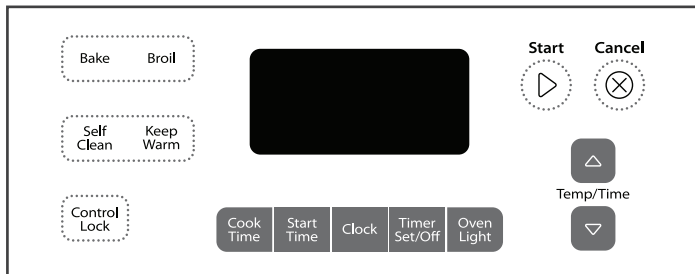

## ! WARNING

### Food Poisoning Hazard

**Do not let food sit in oven more than one hour before or after cooking.**

**Doing so can result in food poisoning or sickness.**

KEYPAD	FEATURE	INSTRUCTIONS
<b>CLOCK</b>	<b>Clock</b>	The Clock uses a 12-hour cycle. <ol style="list-style-type: none"> <li>1. Check that the oven is off.</li> <li>2. Press CLOCK.</li> <li>3. Press TEMP/TIME “up” or “down” arrow pads to set the time of day.</li> <li>4. Press CLOCK or START.</li> </ol>
<b>OVEN LIGHT</b>	<b>Oven cavity light</b>	The oven light is controlled by a keypad on the oven control panel. While the oven door is closed, press the oven light switch to turn the light on and off. The oven light will come on when the oven door is opened.
<b>TIMER (Set/Off)</b>	<b>Oven timer</b>	The Timer can be set in hours or minutes up to 12 hours and 59 minutes. <ol style="list-style-type: none"> <li>1. Press TIMER.</li> <li>2. Press TEMP/TIME “up” or “down” arrow pads to set the length of time.</li> <li>3. Press START to begin the countdown. If enabled, end-of-cycle tones will sound at end of countdown.</li> <li>4. Press TIMER twice to cancel the Timer. Do not press the Cancel keypad because the oven will turn off.</li> <li>5. If the Timer is running, but not in the display, press TIMER to display the countdown for 5 seconds.</li> </ol>
<b>START</b>	<b>Cooking start</b>	The Start pad begins any oven function. If Start is not pressed within 5 seconds, “PUSH” appears in the display. If Start is not pressed within 1 minute after pressing a keypad, the function is canceled and the time of day is displayed.
<b>CANCEL</b>	<b>Range function</b>	The Cancel keypad stops any function except the Clock, Timer and Oven Control Lockout.
<b>TEMP/TIME</b>	<b>Temperature and time adjust</b>	The “up” or “down” arrow pads are used to adjust time and temperature settings.
<b>BAKE</b>	<b>Baking and roasting</b>	<ol style="list-style-type: none"> <li>1. Press BAKE.</li> <li>2. Press TEMP/TIME “up” or “down” arrow pads to set a temperature other than 350°F (175°C) in 5°F (5°C) increments between 170°F and 500°F (75°C and 260°C).</li> <li>3. Press START.</li> <li>4. To change the temperature repeat Step 2. Press START or wait 5 seconds for the change to take effect.</li> <li>5. Press CANCEL when finished.</li> </ol>
<b>BROIL</b>	<b>Broiling</b>	<ol style="list-style-type: none"> <li>1. Press BROIL.</li> <li>2. Press TEMP/TIME “up” or “down” arrow pads to change the temperature in 5°F (5°C) increments between 300°F and 500°F (150°C and 260°C).</li> <li>3. Press START, and allow oven to preheat for 5 minutes.</li> <li>4. Position cookware in oven and close the oven door.</li> <li>5. Press CANCEL when finished.</li> </ol>
<b>KEEP WARM</b>	<b>Hold warm</b>	Food must be at serving temperature before placing it in the warmed oven. <ol style="list-style-type: none"> <li>1. Press KEEP WARM.</li> <li>2. Temperature is set at 170°F (75°C) for 60 minutes (1.00 hour).</li> <li>3. Press START.</li> <li>4. Press CANCEL when finished.</li> </ol> <p><b>NOTE:</b> The oven will automatically turn off after 60 minutes.</p>

KEYPAD	FEATURE	INSTRUCTIONS
START TIME	Delayed start	The Start Time keypad is used to enter the starting time for an oven function with a delayed start. Start Time should not be used for foods such as breads and cakes because they may not bake properly. To set a Timed Cook or a Delayed Timed Cook, see “Cook Time” section.
COOK TIME	Timed cooking	Timed Cooking allows the oven to be set to turn on at a certain time of day, cook for a set length of time, and/or shut off automatically. To set a Timed Cook or a Delayed Timed Cook, see “Cook Time” section.
SELF CLEAN	Self-Cleaning cycle	See the “Self-Cleaning Cycle” section.
CONTROL LOCK	Oven control lockout	<ol style="list-style-type: none"> <li>1. Check that the oven is off.</li> <li>2. Press and hold the CONTROL LOCK keypad for 3 seconds.</li> <li>3. A tone will sound, and “Loc” will be displayed.</li> <li>4. Repeat to unlock. Only the CLOCK, OVEN LIGHT and TIMER keypads will function with the controls locked. The cooktop functions are not affected by the oven control lockout.</li> </ol>

## COOKTOP USE

**⚠ WARNING**



**Fire Hazard**

**Do not let the burner flame extend beyond the edge of the pan.**

**Turn off all controls when not cooking.**

**Failure to follow these instructions can result in death or fire.**

Electric igniters automatically light the surface burners when control knobs are turned to IGNITE.

Before setting a control knob, place filled cookware on the grate. Do not operate a burner using empty cookware or without cookware on the grate.

### To Set:

1. Push in and turn knob counterclockwise to IGNITE.  
All surface burners will click. Only the burner with the control knob turned to IGNITE will produce a flame.
2. Turn knob to anywhere between HIGH and LOW.

**REMEMBER:** When range is in use or (on some models) during the Self-Cleaning cycle, the entire cooktop area may become hot.

### Power Failure

In case of prolonged power failure, the surface burners can be lit manually. Hold a lit match near a burner and turn knob counterclockwise to IGNITE. After burner lights, turn knob to setting.

### Sealed Surface Burners

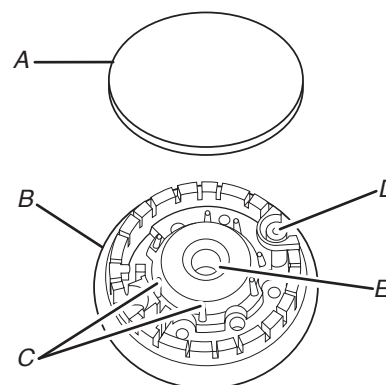

- A. Burner cap
- B. Burner base
- C. Alignment pins
- D. Igniter
- E. Gas tube opening

**IMPORTANT:** Do not obstruct the flow of combustion and ventilation air around the burner grate edges.

**Burner Cap:** Always keep the burner cap in place when using a surface burner. A clean burner cap will help avoid poor ignition and uneven flames. Always clean the burner cap after a spillover and routinely remove and clean the caps according to the “General Cleaning” section.

**Gas Tube Opening:** Gas must flow freely throughout the gas tube opening for the burner to light properly. Keep this area free of soil, and do not allow spills, food, cleaning agents or any other material to enter the gas tube opening. Keep spillovers out of the gas tube by always using a burner cap.

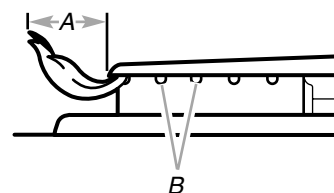

- A. 1 to 1 1/2" (2.5 to 3.8 cm)
- B. Burner ports

**Burner Ports:** Check burner flames occasionally for proper size and shape as shown in the previous illustration. A good flame is blue in color, not yellow. Keep this area free of soil and do not allow spills, food, cleaning agents or any other material to enter the burner ports.

**To Clean:**

**IMPORTANT:** Before cleaning, make sure all controls are OFF and the oven and cooktop are cool. Do not use oven cleaners, bleach or rust removers.

1. Remove the burner cap from the burner base and clean according to “General Cleaning” section.
2. Clean the gas tube opening with a damp cloth.
3. Clean clogged burner ports with a straight pin as shown. Do not enlarge or distort the port. Do not use a wooden toothpick. If the burner needs to be adjusted, contact a trained repair specialist.

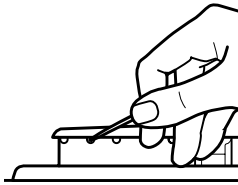

4. Replace the burner cap, making sure the alignment pins are properly aligned with the burner cap.

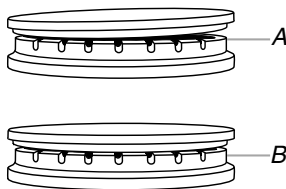

A. Incorrect  
B. Correct

5. Turn on the burner. If the burner does not light, check cap alignment. If the burner still does not light, do not service the sealed burner yourself. Contact a trained repair specialist.

**Burner Size**

Select a burner that best fits your cookware. See the following illustration and chart.

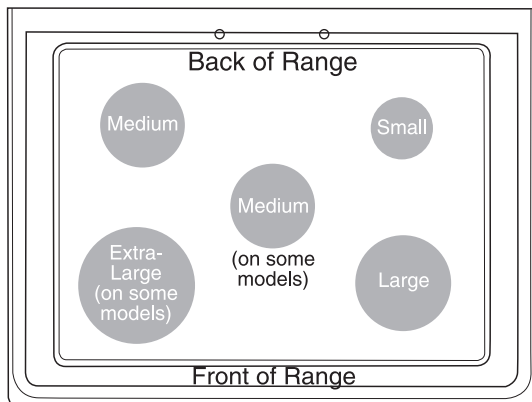

Burner Size	Recommended Use
<b>Small</b>	<ul style="list-style-type: none"> <li>Low-heat cooking</li> <li>Melting chocolate or butter</li> </ul>
<b>Medium</b>	<ul style="list-style-type: none"> <li>Multipurpose burner</li> </ul>
<b>Large</b>	<ul style="list-style-type: none"> <li>For large cookware</li> </ul>
<b>Extra-Large</b>	<ul style="list-style-type: none"> <li>Most powerful burner</li> <li>For large cookware</li> </ul>

**Cookware**

**IMPORTANT:** Do not leave empty cookware on a hot surface cooking area, element or surface burner.

Ideal cookware should have a flat bottom, straight sides and a well-fitting lid, and the material should be of medium-to-heavy thickness.

Rough finishes may scratch the cooktop or grates. Aluminum and copper may be used as a core or base in cookware.

Cookware material is a factor in how quickly and evenly heat is transferred, which affects cooking results.

Cookware with nonstick surfaces should not be used under the broiler.

Check for flatness by placing the straight edge of a ruler across the bottom of the cookware. While you rotate the ruler, no space or light should be visible between it and the cookware.

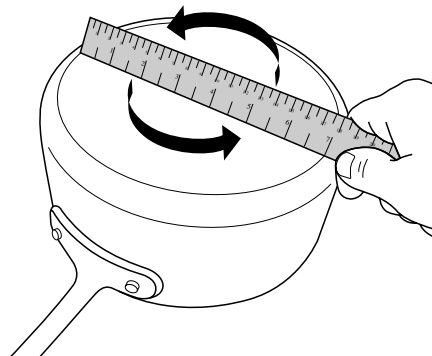

Use the following chart as a guide for cookware material characteristics.

Cookware	Characteristics
<b>Aluminum</b>	<ul style="list-style-type: none"> <li>Heats quickly and evenly.</li> <li>Suitable for all types of cooking.</li> <li>Medium or heavy thickness is best for most cooking tasks.</li> </ul>
<b>Cast iron</b>	<ul style="list-style-type: none"> <li>Heats slowly and evenly.</li> <li>Good for browning and frying.</li> <li>Maintains heat for slow cooking.</li> </ul>
<b>Ceramic or Ceramic glass</b>	<ul style="list-style-type: none"> <li>Follow manufacturer’s instructions.</li> <li>Heats slowly but unevenly.</li> <li>Ideal results on low to medium heat settings.</li> </ul>
<b>Copper</b>	<ul style="list-style-type: none"> <li>Heats very quickly and evenly.</li> <li>May leave copper residues, which may be diminished if cleaned immediately after cooking.</li> </ul>
<b>Earthenware/ Stoneware</b>	<ul style="list-style-type: none"> <li>Follow manufacturer’s instructions.</li> <li>Use on low heat settings.</li> </ul>
<b>Porcelain enamel-on-steel or cast iron</b>	<ul style="list-style-type: none"> <li>See stainless steel or cast iron.</li> </ul>
<b>Stainless steel</b>	<ul style="list-style-type: none"> <li>Heats quickly but unevenly.</li> <li>A core or base of aluminum or copper on stainless steel provides even heating.</li> </ul>

For best results, the cookware should be centered above the burner with the bottom sitting level on the grate. The flame should be adjusted so that it does not extend up the sides of the pan.

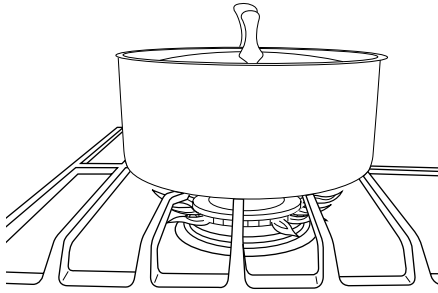

---

## Home Canning

When canning for long periods, alternate the use of surface burners between batches. This allows time for the most recently used areas to cool.

- Center the canner on the grate above the burner.
- Do not place canner on 2 surface burners at the same time.
- For more information, contact your local agricultural extension office or refer to published home canning guides. Companies that manufacture home canning products can also offer assistance.

---

## OVEN USE

The normal operation of the range will include several noises that may be heard each time the Bake or Broil burners ignite during the cooking cycle:

- Gas valves may make a “popping” sound when opening or closing.
- Igniters will “click” several times until a flame is sensed.

- A “poof” sound is heard when a Bake or Broil burner ignites.

Odors and smoke are normal when the oven is used the first few times or when it is heavily soiled.

**IMPORTANT:** The health of some birds is extremely sensitive to the fumes given off. Exposure to the fumes may result in death to certain birds. Always move birds to another closed and well-ventilated room.

---

## Electronic Oven Controls

---

### Control Display

The display will flash when powered up or after a power loss. Press CANCEL to clear. When oven is not in use, the time of day is displayed.

---

### Options Mode

Press and hold TIMER for 5 seconds, and “Opt” will appear. Use the Temp/Time “up” or “down” arrow pads to cycle through the following options. Press CANCEL to exit the mode.

### Fahrenheit and Celsius

The temperature is preset at Fahrenheit, but can be changed to Celsius. Press TIMER to toggle between Fahrenheit and Celsius. Press CANCEL to exit.

### End of Cycle Tones

“b1” (beep once) or “b” (continue to beep) will be displayed. Press TIMER to toggle through selections. Press CANCEL to exit.

### Oven Light with Door Open

“LOn” indicates that the oven light will turn on when the door is open. If “LOFF” is displayed, the oven light will turn on only with the oven light switch. Press TIMER to toggle through selection. Press CANCEL to exit.

### 12-Hour Shutoff

If “12 Hr” is displayed, the oven will automatically shut off after 12 hours. Press TIMER to toggle to “- - Hr” to disable the 12-hour shutoff. Press CANCEL to exit.

---

### Tones

Tones are audible signals, indicating the following:

### Basic Functions

#### One tone

- Valid pad press
- Oven is preheated (long tone)
- Function has been entered
- Reminder (on some models), repeating every 20 seconds after the end-of-cycle tones

#### Three tones

- Invalid pad press

#### Four tones

- End of cycle

---

### Oven Temperature Control

**IMPORTANT:** Do not use a thermometer to measure oven temperature. Elements will cycle on and off as needed to provide consistent temperature but may run slightly hot or cool at any point in time due to this cycling. Most thermometers are slow to react to temperature change and will not provide an accurate reading due to this cycling.

The oven provides accurate temperatures; however, it may cook faster or slower than your previous oven, so the temperature can be adjusted to personalize it for your cooking needs. It can be changed in Fahrenheit or Celsius.

#### To Adjust Oven Temperature:

1. Press and hold BAKE for 5 seconds until the oven display shows the current setting, for example “0°F CAL” or “00.”
2. Press the Temp/Time “up” or “down” arrow pads to increase or to decrease the temperature in 10°F (5°C or 6°C) amounts. The adjustment can be set between 30°F (17°C) and -30°F (-17°C).
3. Press START.

---

## Sabbath Mode

The Sabbath Mode sets the oven to remain on in a Bake setting until turned off. A Timed Bake can also be set to keep the oven on for only part of the Sabbath. The Oven Control Lockout Feature (if present) will be disabled during the Sabbath Mode. After the Sabbath Mode is set no tones will sound, the display will not show the temperature, the Kitchen Timer Mode will be canceled (if active) and only the following pads will function:

- “up” or “down” arrow pads
- Cancel

When the oven door is opened or closed, the oven light will not turn on or off and the heating elements will not turn on or off immediately.

When power is restored after a power failure, the oven will return to Sabbath Mode and remain Sabbath compliant with the bake elements off until the Cancel keypad is pressed.

Pressing the Cancel keypad at any time returns the oven to the normal cooking mode (not Sabbath Mode compliant).

Before entering the Sabbath Mode, it must be decided if the oven light is to be on or off for the entire Sabbath Mode period. If the light is on when entering Sabbath Mode, it will remain on for the entire time Sabbath Mode is in use. If the light is off when entering Sabbath Mode, it will remain off for the entire time Sabbath Mode is in use. Opening the oven door or pressing the Oven Light keypad will not affect the oven light once Sabbath Mode has been entered.

If the oven has the Convection Bake feature, the oven light is controlled by a separate Oven Light switch on the console. If the oven light is on when entering the Sabbath Mode, it will remain on for the entire time Sabbath Mode is in use. For the oven light to be off during the Sabbath Mode, the light bulb must be removed from the oven prior to entering the Sabbath Mode. Not performing these steps will cause the oven light to turn on when the oven door is opened, resulting in the oven being not Sabbath compliant.

On the Holiday, the oven temperature can be changed once the oven is in Sabbath Mode by pressing the “up” or “down” arrow pads. The oven temperature will change 25°F (14°C) each time the keypad is pressed. The display will not change, and there will be no sounds during this adjustment.

### To Bake Using Sabbath Mode:

1. Press BAKE.
2. Press the “up” or “down” arrow pads.
3. Press START.
4. Press and hold the TIMER keypad for 5 seconds. “SAb” will flash in the display.
5. Press START within 5 seconds to enter Sabbath Mode; otherwise, the entire cycle cancels out. “SAb” will stop flashing and remain on in the display. The oven is now in Sabbath Mode and is Sabbath compliant.

Pressing the Cancel keypad at any time returns the oven to the normal cooking mode (not Sabbath Mode compliant).

### To set a Timed Bake using Sabbath Mode (on some models):

## WARNING

### Food Poisoning Hazard

**Do not let food sit in oven more than one hour before or after cooking.**

**Doing so can result in food poisoning or sickness.**

1. Press BAKE.
2. Press the “up” or “down” arrow pads to enter a temperature other than the one displayed.
3. Press COOK TIME. The Cook Time oven indicator light will light up.
4. Press the “up” or “down” arrow pads to enter a cook time length.
5. Press START.
6. Press and hold the TIMER keypad for 5 seconds. “SAb” will flash in the display.
7. Press START within 5 seconds to enter Sabbath Mode; otherwise, the entire cycle cancels out. “SAb” will stop flashing and remain on in the display. The oven is now in Sabbath Mode and is Sabbath compliant. The Bake, On and Cook Time indicator lights will be displayed.

When the set cook time ends, the oven will shut off automatically and the indicator lights will turn off, indicating the end of the cycle.

Pressing the Cancel keypad at any time returns the oven to the normal cooking mode (not Sabbath Mode compliant).

### To set a Delayed Timed Bake using Sabbath Mode (on some models):

1. Press BAKE.
2. Press the “up” or “down” arrow pads to enter a temperature other than the one displayed.
3. Press COOK TIME. The Cook Time oven indicator light will light up.
4. Press the “up” or “down” arrow pads to enter a cook time length.
5. Press START TIME. The Start Time indicator light will light up.
6. Press the “up” or “down” arrow pads to enter a start time.
7. Press START.
8. Press and hold the TIMER keypad for 5 seconds. “SAb” will flash in the display.
9. Press START within 5 seconds to enter Sabbath Mode; otherwise, the entire cycle cancels out. “SAb” will stop flashing and remain on in the display. The oven is now in Sabbath Mode and is Sabbath compliant. The On and Delay indicator lights will be displayed.

When the start time is reached the Bake, On and Cook Time indicator lights will automatically turn on. When the set cook time ends, the oven will shut off automatically and the indicator lights will turn off, indicating the end of the cycle.

Pressing the Cancel keypad at any time returns the oven to the normal cooking mode (not Sabbath Mode compliant).

---

## Aluminum Foil

**IMPORTANT:** To avoid permanent damage to the oven bottom finish, do not line the oven bottom with any type of foil or liner.

For best cooking results, do not cover entire oven rack with foil because air must be able to move freely.



## Positioning Racks and Bakeware

**IMPORTANT:** To avoid permanent damage to the porcelain finish, do not place food or bakeware directly on the oven door or bottom.

### Bakeware

To cook food evenly, hot air must be able to circulate. Allow 2" (5 cm) of space around bakeware and oven walls. Make sure that no bakeware piece is directly over another.

### Racks

- Position racks before turning on the oven.
- Do not position racks with bakeware on them.
- Make sure racks are level.

To move a rack, pull it out to the stop position, raise the front edge, and then lift out. Use the following illustration and charts as a guide.

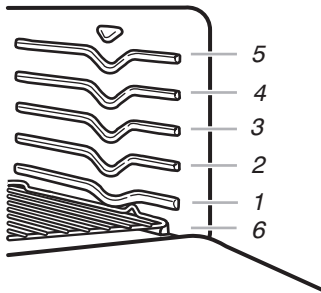

### Rack Positions

Rack 5: 2-rack baking.

Rack 4: Use for broiling and toasting.

Rack 3: Most baked goods on a cookie sheet, jelly roll pan, or in muffin pans; casseroles; frozen convenience foods.

Rack 2: Roasting small cuts of meat, pies, casseroles, bundt and angel food cakes, yeast bread, quick breads, and 2-rack baking.

Rack 1: Roasting large cuts of meat and poultry.

Rack 6: Extra-large items.

### Multiple Rack Cooking

2-rack: Use rack positions 2 and 5.

### Baking Layer Cakes on 2 Racks

For best results when baking cakes on 2 racks, use racks 2 and 5 for baking. Place the cakes on the racks as shown.

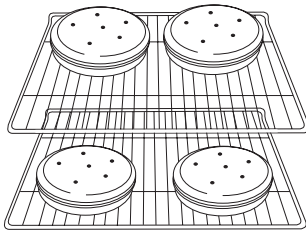

## Oven Vent

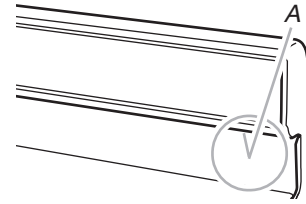

A. Oven vent

The oven vent releases hot air and moisture from the oven, and should not be blocked or covered. Blocking or covering the oven vent will cause poor air circulation, affecting cooking and cleaning results. Do not set plastics, paper or other items that could melt or burn near the oven vent.

## Baking and Roasting

### ACCUBAKE® Temperature Management System

The ACCUBAKE® system electronically regulates the oven heat levels during preheat and bake to maintain a precise temperature range for optimal cooking results. The bake and broil elements or burners cycle on and off in intervals. On convection range models, the fan may be cycled on and off for short intervals to provide the best results.

Before baking and roasting, position racks according to “Positioning Racks and Bakeware” section. When roasting, it is not necessary to wait for the oven preheat cycle to end before putting food in unless it is recommended in the recipe.

### Preheating

When START is pressed, the oven will begin preheating. Once 100°F (35°C) is reached, the display temperature will increase as the actual temperature of the oven increases. When the preheat temperature is reached, a tone will sound, and the selected temperature will appear on the display. Factors that have an impact on preheat times are: room temperature, starting oven temperature, and the number of oven racks. Unused oven racks can be removed prior to preheating your oven to reduce the preheat times.

## Broiling

When broiling, preheat the oven for 5 minutes before putting food in unless recommended otherwise in the recipe. Position food on grid in a broiler pan, then place it in the center of the oven rack.

**IMPORTANT:** Close the door to ensure proper broiling temperature.

Changing the temperature when Custom Broiling allows more precise control when cooking. The lower the broil setting, the slower the cooking. Thicker cuts and unevenly shaped pieces of meat, fish and poultry may cook better at lower broil settings. Use racks 4 or 5 for broiling. Refer to the “Positioning Racks and Bakeware” section for more information.

- For best results, use a broiler pan and grid. It is designed to drain juices and help avoid spatter and smoke.

If you would like to purchase a broiler pan, one may be ordered. Please refer to the “Accessories” section for more information.

**NOTE:** Odors and smoke are normal the first few times the oven is used or if the oven is heavily soiled.

## Cook Time

### **⚠ WARNING**

#### **Food Poisoning Hazard**

**Do not let food sit in oven more than one hour before or after cooking.**

**Doing so can result in food poisoning or sickness.**

#### **To Set a Timed Cook:**

1. Press BAKE. The bake indicator light will light up.
2. Press the TEMP/TIME “up” or “down” arrow pads to enter a temperature other than the one displayed.
3. Press COOK TIME. The cook time oven indicator light will light up.
4. Press the TEMP/TIME “up” or “down” arrow pads to enter the length of time to cook.
5. Press START. The display will count down the time. When the time ends, the oven will shut off automatically and “End” will appear on the display.
6. Press CANCEL to clear the display.

#### **To Set a Delayed Timed Cook:**

Before setting, make sure the clock is set to the correct time of day. See “Clock” keypad feature in the “Feature Guide” section.

1. Press BAKE.
2. Press the TEMP/TIME “up” or “down” arrow pads to enter a temperature other than the one displayed.
3. Press COOK TIME. The cook time oven indicator light will light up.
4. Press TEMP/TIME “up” or “down” arrow pads to enter the length of time to cook.
5. Press START TIME. The start time/delay oven indicator light will light up.
6. Press TEMP/TIME “up” or “down” arrow pads to enter the time of day to start.
7. Press START.

When the start time is reached, the oven will automatically turn on. The temperature and/or time settings can be changed anytime after pressing Start by repeating steps 1-7. When the set cook time ends, the oven will shut off automatically and “End” will appear on the display.

8. Press CANCEL to clear the display.

## RANGE CARE

### Self-Cleaning Cycle

### **⚠ WARNING**



#### **Burn Hazard**

**Do not touch the oven during the Self-Cleaning cycle.**

**Keep children away from oven during Self-Cleaning cycle.**

**Failure to follow these instructions can result in burns.**

**IMPORTANT:** The health of some birds is extremely sensitive to the fumes given off during the Self-Cleaning cycle. Exposure to the fumes may result in death to certain birds. Always move birds to another closed and well-ventilated room.

Keep the kitchen well-ventilated during the Self-Cleaning cycle to help get rid of heat, odors and smoke.

Do not block the oven vent during the Self-Cleaning cycle. Air must be able to move freely. See “Oven Vent” section.

Do not clean, rub, damage or move the oven door gasket.

#### **Prepare Range**

- Remove the broiler pan, grid, cookware and bakeware, all cooking utensils, oven racks and aluminum foil and, on some models, the temperature probe from the oven.
- Use a damp cloth to clean inside door edge and the 1½” (3.8 cm) area around the inside oven cavity frame, being certain not to move or bend the gasket.
- Remove plastic items from the cooktop because they may melt.
- Remove all items from the storage drawer.

#### **How the Cycle Works**

**IMPORTANT:** The heating and cooling of porcelain on steel in the oven may result in discoloring, loss of gloss, hairline cracks and popping sounds.

Before self-cleaning, make sure the door is completely closed or the door will not lock and the self-cleaning cycle will not begin.

Once the oven has completely cooled, remove ash with a damp cloth. To avoid breaking the glass, do not apply a cool damp cloth to the inner door glass before it has completely cooled.

To stop the self-cleaning cycle at anytime, press the CANCEL button on the keypad. If the temperature is too high, the oven door will remain locked and “cool” and “locked” will be displayed. The cooling fan may continue to run.

Once the cleaning temperature has been reached, the electronic control requires a 12-hour delay before another self-clean cycle can be started.

The oven light will not function during the self-cleaning cycle.

#### **Electronic Oven Control with Adjustable Clean Time (on some models)**

The SELF CLEAN self-cleaning cycle is time adjustable between 2 hours 30 minutes and 4 hours 30 minutes in 15-minute increments. Suggested clean times are 2 hours 30 minutes for light soil, and 4 hours 30 minutes for heavy soil. The last 30 minutes of the cycle is for cool down.

#### **To Self-Clean:**

1. Press SELF CLEAN.
2. Press the TEMP/TIME “+” or “-” arrow pads to enter the desired self-clean cycle time.
3. Press START.  
The oven door will automatically lock. The DOOR LOCKED and CLEAN indicator lights will be displayed. The time remaining will also be displayed.
4. When the self-clean cycle is complete and the oven cools, the DOOR LOCKED and CLEAN indicator lights will turn off.
5. When the oven is completely cooled, remove ash with a damp cloth.

---

## General Cleaning

**IMPORTANT:** Before cleaning, make sure all controls are OFF and the oven and cooktop are cool. Always follow label instructions on cleaning products. For additional information, you can visit the Frequently Asked Questions (FAQs) section of our website at [www.whirlpool.com](http://www.whirlpool.com). In Canada, reference the Customer Service section at [www.whirlpool.ca](http://www.whirlpool.ca).

Soap, water and a soft cloth or sponge are suggested first unless otherwise noted.

---

### EXTERIOR PORCELAIN ENAMEL SURFACES (on some models)

Food spills containing acids, such as vinegar and tomato, should be cleaned as soon as the entire range is cool. These spills may affect the finish.

#### Cleaning Method:

- Glass cleaner, mild liquid cleaner or nonabrasive scrubbing pad: Gently clean around the model and serial number plate because scrubbing may remove numbers.
- Affresh® Kitchen and Appliance Cleaner Part Number W10355010 (not included): See the “Accessories” section for more information.

---

### STAINLESS STEEL (on some models)

**NOTE:** To avoid damage to stainless steel surfaces, do not use soap-filled scouring pads, abrasive cleaners, Cooktop Cleaner, steel-wool pads, gritty washcloths or abrasive paper towels. Damage may occur to stainless steel surfaces, even with one-time or limited use.

#### Cleaning Method:

Rub in direction of grain to avoid damaging.

- Affresh® Stainless Steel Cleaner Part Number W10355016 (not included): See the “Accessories” section for more information.

---

### METALLIC PAINT (on some models)

Do not use abrasive cleaners, cleaners with bleach, rust removers, ammonia or sodium hydroxide (lye) because paint surface may stain.

---

### PORCELAIN-COATED GRATES AND CAPS

Food spills containing acids, such as vinegar and tomato, should be cleaned as soon as the cooktop, grates and caps are cool. These spills may affect the finish.

To avoid chipping, do not bang grates and caps against each other or hard surfaces such as cast iron cookware.

Do not reassemble caps on burners while wet.

#### Cleaning Method:

- Nonabrasive plastic scrubbing pad and mildly abrasive cleanser: Clean as soon as cooktop, grates and caps are cool.
- Dishwasher (grates only, not caps): Use the most aggressive cycle. Cooked-on soils should be soaked or scrubbed before going into a dishwasher.
- Gas Grate and Drip Pan Cleaner Part Number 31617A: See the “Accessories” section for more information.

---

### SURFACE BURNERS

- See “Sealed Surface Burners” section.

---

### COOKTOP CONTROLS

To avoid damage to the cooktop controls, do not use steel wool, abrasive cleansers or oven cleaner.

To avoid damage, do not soak knobs. When replacing knobs, make sure knobs are in the Off position.

On some models, do not remove seals under knobs.

#### Cleaning Method:

- Soap and water: Pull knobs straight away from control panel to remove.

---

### CONTROL PANEL AND OVEN DOOR EXTERIOR

To avoid damage to the control panel, do not use abrasive cleaners, steel-wool pads, gritty washcloths or abrasive paper towels.

#### Cleaning Method:

- Glass cleaner and soft cloth or sponge: Apply glass cleaner to soft cloth or sponge, not directly on panel.
- Affresh® Kitchen and Appliance Cleaner Part Number W10355010 (not included): See the “Accessories” section for more information.

---

### OVEN RACKS

#### Cleaning Method:

- Steel-wool pad
- For racks that have discolored and are harder to slide, a light coating of vegetable oil applied to the rack guides will help them slide.

---

### STORAGE DRAWER

Check that storage drawer is cool and empty before cleaning.

#### Cleaning Method:

- Mild detergent

---

### OVEN CAVITY

Do not use oven cleaners.

Food spills should be cleaned when oven cools. At high temperatures, foods react with porcelain and staining, etching, pitting or faint white spots can result.

#### Cleaning Method:

- Clean cycle: See “Self-Cleaning Cycle” section

---

## Oven Light

The oven light is a standard 40-watt appliance bulb. Before replacing, make sure the oven and cooktop are cool and the control knobs are in the Off position.

#### To Replace:

1. Unplug range or disconnect power.
2. Turn the glass bulb cover in the back of the oven counterclockwise to remove.
3. Turn bulb counterclockwise to remove from socket.
4. Replace bulb by turning clockwise.
5. Replace bulb cover by turning clockwise.
6. Plug in range or reconnect power.

# TROUBLESHOOTING

First try the solutions suggested here. If you need further assistance or more recommendations that may help you avoid a service call, refer to the warranty page in this manual, or visit [www.whirlpool.com/product\\_help](http://www.whirlpool.com/product_help). In Canada, visit <http://www.whirlpool.ca>.

Contact us by mail with any questions or concerns at the address below:

In the U.S.A.:

Whirlpool Brand Home Appliances  
Customer eXperience Center  
553 Benson Road  
Benton Harbor, MI 49022-2692

In Canada:

Whirlpool Brand Home Appliances  
Customer eXperience Centre  
200 - 6750 Century Ave.  
Mississauga, Ontario L5N 0B7

Please include a daytime phone number in your correspondence.

**⚠ WARNING**



**Electrical Shock Hazard**

**Plug into a grounded 3 prong outlet.**

**Do not remove ground prong.**

**Do not use an adapter.**

**Do not use an extension cord.**

**Failure to follow these instructions can result in death, fire, or electrical shock.**

PROBLEM	POSSIBLE CAUSES	SOLUTIONS
<b>Nothing will operate</b>	Power supply cord is unplugged.	Plug into a grounded 3 prong outlet.
	Household fuse is blown or a circuit breaker is tripped.	Replace the fuse or reset the circuit breaker. If the problem continues, call an electrician.
	Main or regulator gas shutoff valve is in the off position.	See the Installation Instructions.
	The range is improperly connected to the gas supply.	Contact a trained repair specialist or see Installation Instructions.
<b>Surface burners will not operate</b>	The control knob is not set correctly.	Push in knob before turning to a setting.
	Air in the gas lines.	If this is the first time the surface burners have been used, turn on any one of the surface burner knobs to release air from the gas lines.
	Clogged burner ports.	See "Sealed Surface Burners" section.
<b>Surface burner flames are uneven, yellow and/or noisy</b>	Clogged burner ports.	See "Sealed Surface Burners" section.
	Burner caps positioned improperly.	See "Sealed Surface Burners" section.
	Range converted improperly.	If propane gas is being used, contact a service technician or see cover for contact information.
<b>Excessive heat around cookware on cooktop</b>	Cookware and flame are not matched.	The cookware should be centered above the burner with the bottom sitting level on the grate. The flame should be adjusted so that it does not extend up the sides of the pan.
<b>Cooktop cooking results not what expected</b>	Improper cookware.	Ideal cookware should have a flat bottom, straight sides and a well fitting lid, and the material should be of a medium to heavy thickness.
	Control knob set to incorrect heat level.	See "Cooktop Use" section.
	Range is not level.	Level the range. See the Installation Instructions.

<b>PROBLEM</b>	<b>POSSIBLE CAUSES</b>	<b>SOLUTIONS</b>
<b>Oven will not operate</b>	Air in the gas lines.	If this is the first time the oven has been used, turn on any one of the surface burner knobs to release air from the gas lines.
	Control is locked.	Press and hold START for 3 seconds to unlock.
	Control is in Demo Mode.	Press and hold START TIME for 10 seconds to exit Demo Mode. Demo Mode is used for display models in a showroom.
	Electronic oven control set incorrectly.	See “Electronic Oven Controls” section.
<b>Oven burner flames are yellow or noisy</b>	Range converted improperly.	If propane gas is being used, contact a service technician or see cover for contact information.
<b>Oven temperature too high or too low</b>	Oven temperature needs adjustment.	See “Oven Temperature Control” in the “Electronic Oven Controls” section.
<b>Convection fan not working</b>	The convection cycle is in the first 5 minutes of operation.	This is normal. The convection fan will start running approximately 5 minutes into the cycle.
	Oven door is open.	If the oven door is opened during convention cooking, the fan will turn off immediately. It will come back on when the oven door is closed.
<b>Display shows messages</b>	Power failure (display shows flashing time).	Clear the display. On some models, reset the clock, if needed. See “Clock” keypad feature in the “Feature Guide” section.
	Error code (display shows letter followed by number).	Depending on your model, press CANCEL to clear the display. See “Control Display” in the “Electronic Oven Controls” section. If it reappears, call for service. See cover for contact information.
	Start needs to be pressed so a cycle can begin (display shows “PUSH” or “PSH”).	See the “Start” keypad feature in the “Feature Guide” section.
	Range is in Sabbath Mode (display shows “SAb”).	Press CANCEL to exit Sabbath Mode.
<b>Self-Cleaning Cycle will not operate</b>	The oven door is not closed.	Make sure the oven door is fully closed.
	The Self-Cleaning function has not been entered correctly.	See the “Self-Cleaning Cycle” section.
	A Timed Cooking function has been entered.	See the “Cook Time” section.
	The range is in Sabbath Mode.	See the “Sabbath Mode” section.
	A Self-Cleaning cycle has been run in the past 12 hours.	If a Self-Cleaning cycle has been run, or has been canceled after the oven reached temperature, the oven control requires a 12-hour delay before starting another Self-Cleaning cycle.

<b>PROBLEM</b>	<b>POSSIBLE CAUSES</b>	<b>SOLUTIONS</b>
<b>Oven cooking results not what expected</b>	Range is not level.	Level the range. See the Installation Instructions.
	The temperature set was incorrect.	Double-check the recipe in a reliable cookbook.
	Oven temperature needs adjustment.	See “Oven Temperature Control” in the “Electronic Oven Controls” section.
	Oven was not preheated.	See “Baking and Roasting” section.
	Racks were positioned improperly.	See “Positioning Racks and Bakeware” section.
	Not enough air circulation around bakeware.	See “Positioning Racks and Bakeware” section.
	Darker browning of food caused by dull or dark bakeware.	Lower oven temperature 25°F (15°C) or move rack to a higher position in the oven.
	Lighter browning of food caused by shiny or light colored bakeware.	Move rack to a lower position in the oven.
	Batter distributed unevenly in pan.	Check that batter is level in the pan.
	Incorrect length of cooking time was used.	Adjust cooking time.
	Oven door was not closed.	Be sure that the bakeware does not keep the door from closing.
	Oven door was opened during cooking.	Oven peeking releases oven heat and can result in longer cooking times.
Rack is too close to bake burner, making baked items too brown on bottom.	Move rack to higher position in the oven.	
Pie crusts browning too quickly.	Use aluminum foil to cover the edge of the crust and/or reduce baking temperature.	

## Noises

<b>PROBLEM</b>	<b>POSSIBLE CAUSES</b>	<b>SOLUTIONS</b>
<b>Surface burner making popping noises</b>	Wet burner.	Allow it to dry.
<b>Gas range noises during Bake and Broil operations</b> The following are some normal sounds with the explanations.	These sounds are normal operational noises that can be heard each time the Bake or Broil burners ignite during the cycle.	
Pop	Gas valve is opening or cycling on and will make a single pop when it snaps open from the solenoid. It sounds similar to a suction cup being pulled off of a piece of glass.	This is normal.
Click	The igniters will click several times until the flame is detected. These are short clicking sounds like tapping a nail onto a piece of glass.	This is normal.
	Convection fan relay is cycling on and off (on some models).	This is normal.
Woosh or poof	Bake or Broil burner is igniting.	This is normal.
<b>Oven burner flames are yellow or noisy</b>	Range converted improperly.	If propane gas is being used, contact a service technician or see cover for contact information.

---

# ACCESSORIES

For accessories in the U.S.A., you can visit our website at [www.whirlpool.com](http://www.whirlpool.com) or call us at **1-800-253-1301**.

In Canada, you can visit our website at [www.whirlpool.ca](http://www.whirlpool.ca) or call us at **1-800-807-6777**.

**Affresh® Stainless Steel Cleaner**

(stainless steel models)  
Order Part Number W10355016

**Affresh® Stainless Steel Cleaning Wipes**

(stainless steel models)  
Order Part Number W10355049

**Affresh® Kitchen and Appliance Cleaner**

Order Part Number W10355010

**Affresh® Cooktop Cleaner**

Order Part Number W10355051

**Granite Cleaner and Polish**

Order Part Number W10275756

**Gas Grate and Drip Pan Cleaner**

Order Part Number 31617A

**Standard Flat Oven Rack**

Order Part Number W10268578

**Gourmet Griddle**

Order Part Number 4396096RB

**Porcelain Broiler Pan and Grid**

Order Part Number 4396923

**Premium Broiler Pan and Roasting Rack**

Order Part Number W10123240

# WHIRLPOOL® MAJOR APPLIANCE LIMITED WARRANTY

ATTACH YOUR RECEIPT HERE. PROOF OF PURCHASE IS REQUIRED TO OBTAIN WARRANTY SERVICE.

Please have the following information available when you call the Customer eXperience Center:

- Name, address and telephone number
- Model number and serial number
- A clear, detailed description of the problem
- Proof of purchase including dealer or retailer name and address

## IF YOU NEED SERVICE:

1. Before contacting us to arrange service, please determine whether your product requires repair. Some questions can be addressed without service. Please take a few minutes to review the Troubleshooting or Problem Solver section of the Use and Care Guide, or visit [www.whirlpool.com/product\\_help](http://www.whirlpool.com/product_help).
2. All warranty service is provided exclusively by our authorized Whirlpool Service Providers. In the U.S. and Canada, direct all requests for warranty service to:

**Whirlpool Customer eXperience Center**

**In the U.S.A., call 1-800-253-1301. In Canada, call 1-800-807-6777.**

If outside the 50 United States or Canada, contact your authorized Whirlpool dealer to determine whether another warranty applies.

## ONE YEAR LIMITED WARRANTY

### WHAT IS COVERED

For one year from the date of purchase, when this major appliance is installed, operated and maintained according to instructions attached to or furnished with the product, Whirlpool Corporation or Whirlpool Canada LP (hereafter "Whirlpool") will pay for Factory Specified Replacement Parts and repair labor to correct defects in materials or workmanship that existed when this major appliance was purchased, or at its sole discretion replace the product. In the event of product replacement, your appliance will be warranted for the remaining term of the original unit's warranty period.

YOUR SOLE AND EXCLUSIVE REMEDY UNDER THIS LIMITED WARRANTY SHALL BE PRODUCT REPAIR AS PROVIDED HEREIN. Service must be provided by a Whirlpool designated service company. This limited warranty is valid only in the United States or Canada and applies only when the major appliance is used in the country in which it was purchased. This limited warranty is effective from the date of original consumer purchase. Proof of original purchase date is required to obtain service under this limited warranty.

### WHAT IS NOT COVERED

1. Commercial, non-residential, multiple-family use, or use inconsistent with published user, operator or installation instructions.
2. In-home instruction on how to use your product.
3. Service to correct improper product maintenance or installation, installation not in accordance with electrical or plumbing codes or correction of household electrical or plumbing (i.e. house wiring, fuses or water inlet hoses).
4. Consumable parts (i.e. light bulbs, batteries, air or water filters, preservation solutions, etc.).
5. Defects or damage caused by the use of non-genuine Whirlpool parts or accessories.
6. Conversion of products from natural gas or Propane gas.
7. Damage from accident, misuse, abuse, fire, floods, acts of God or use with products not approved by Whirlpool.
8. Repairs to parts or systems to correct product damage or defects caused by unauthorized service, alteration or modification of the appliance.
9. Cosmetic damage including scratches, dents, chips, and other damage to the appliance finishes unless such damage results from defects in materials and workmanship and is reported to Whirlpool within 30 days.
10. Discoloration, rust or oxidation of surfaces resulting from caustic or corrosive environments including but not limited to high salt concentrations, high moisture or humidity or exposure to chemicals.
11. Food or medicine loss due to product failure.
12. Pick-up or delivery. This product is intended for in-home repair.
13. Travel or transportation expenses for service in remote locations where an authorized Whirlpool servicer is not available.
14. Removal or reinstallation of inaccessible appliances or built-in fixtures (i.e. trim, decorative panels, flooring, cabinetry, islands, countertops, drywall, etc.) that interfere with servicing, removal or replacement of the product.
15. Service or parts for appliances with original model/serial numbers removed, altered or not easily determined.

**The cost of repair or replacement under these excluded circumstances shall be borne by the customer.**

### DISCLAIMER OF IMPLIED WARRANTIES

IMPLIED WARRANTIES, INCLUDING ANY IMPLIED WARRANTY OF MERCHANTABILITY OR IMPLIED WARRANTY OF FITNESS FOR A PARTICULAR PURPOSE, ARE LIMITED TO ONE YEAR OR THE SHORTEST PERIOD ALLOWED BY LAW. Some states and provinces do not allow limitations on the duration of implied warranties of merchantability or fitness, so this limitation may not apply to you. This warranty gives you specific legal rights, and you also may have other rights that vary from state to state or province to province.

### DISCLAIMER OF REPRESENTATIONS OUTSIDE OF WARRANTY

Whirlpool makes no representations about the quality, durability, or need for service or repair of this major appliance other than the representations contained in this warranty. If you want a longer or more comprehensive warranty than the limited warranty that comes with this major appliance, you should ask Whirlpool or your retailer about buying an extended warranty.

### LIMITATION OF REMEDIES; EXCLUSION OF INCIDENTAL AND CONSEQUENTIAL DAMAGES

YOUR SOLE AND EXCLUSIVE REMEDY UNDER THIS LIMITED WARRANTY SHALL BE PRODUCT REPAIR AS PROVIDED HEREIN. WHIRLPOOL SHALL NOT BE LIABLE FOR INCIDENTAL OR CONSEQUENTIAL DAMAGES. Some states and provinces do not allow the exclusion or limitation of incidental or consequential damages, so these limitations and exclusions may not apply to you. This warranty gives you specific legal rights, and you also may have other rights that vary from state to state or province to province.



**W11122569A**  
**SP PN W11156387A**

®/™ ©2017 Whirlpool. Used under license in Canada. All rights reserved.  
®/™ ©2017 Whirlpool. Utilise sous licence au Canada. Tous droits reserves.

07/17  
Printed in U.S.A.  
Imprimé aux É.-U.