

Use & Care Guide
Guía de uso y cuidada
English / Español

Model/Modelos: 790.7443*

Kenmore®

Gas Range

Estufa de gas

* = color number, número de color

P/N 808530402 Rev E

Sears Brands Management Corporation
Hoffman Estates, IL 60179 U.S.A.
www.kenmore.com
www.sears.com



Table of Contents

Cooking Recommendations.....	9	Care and Cleaning	26
Before Setting Surface Controls.....	12	Before You Call	30
Setting Surface Controls.....	14	Oven Baking	30
Before setting oven controls	15	Solutions to Common Problems	31
Oven vent location	15		
Oven Controls	16		
Self Clean	23		

KENMORE LIMITED WARRANTY

WITH PROOF OF SALE the following warranty coverage applies when this appliance is correctly installed, operated and maintained according to all supplied instructions.

One Year on Appliance

FOR ONE YEAR from the date of sale this appliance is warranted against defects in material or workmanship. A defective appliance will receive free repair or replacement at option of seller.

Lifetime on Cooktop Gas Burners, Cooktop Electric Elements and Oven Door Glass

FOR AS LONG AS IT IS USED from the date of sale, a free replacement will be supplied for a defective cooktop gas burner, cooktop electric element or oven door glass. If the defect appears within the first year, a new burner, element or door glass will be installed at no charge. If the defect appears after the first year, a new burner, element or door glass will be supplied but not installed at no charge. This Lifetime warranty covers only the burner, element or door glass, and does not apply to any other related component or mechanism. You are responsible for the labor cost of burner or element installation after the first year from the date of sale.

For warranty coverage details to obtain free repair or replacement, visit the web page: www.kenmore.com/warranty

All warranty coverage applies for only 90 DAYS from the sale date if this appliance is ever used for other than private household purposes.

This warranty covers ONLY defects in material and workmanship, and will NOT pay for:

1. Cracks in a ceramic glass cooktop that are not a result of thermal shock.
2. Stains and scratches on a ceramic glass cooktop resulting from accident or improper operation or maintenance.
3. Discoloration of cooktop surfaces resulting from normal use.
4. Expendable items that can wear out from normal use, including but not limited to filters, belts, bags or screw-in base light bulbs.
5. A service technician to clean or maintain this appliance, or to instruct the user in correct appliance installation, operation and maintenance.
6. Service calls to correct appliance installation not performed by Sears authorized service agents, or to repair problems with house fuses, circuit breakers, house wiring, and plumbing or gas supply systems resulting from such installation.
7. Damage to or failure of this appliance resulting from installation not performed by Sears authorized service agents, including installation that was not in accord with electrical, gas or plumbing codes.
8. Damage to or failure of this appliance, including discoloration or surface rust, if it is not correctly operated and maintained according to all supplied instructions.
9. Damage to or failure of this appliance, including discoloration or surface rust, resulting from accident, alteration, abuse, misuse or use for other than its intended purpose.
10. Damage to or failure of this appliance, including discoloration or surface rust, caused by the use of detergents, cleaners, chemicals or utensils other than those recommended in all instructions supplied with the product.
11. Damage to or failure of parts or systems resulting from unauthorized modifications made to this appliance.
12. Service to an appliance if the model and serial plate is missing, altered, or cannot easily be determined to have the appropriate certification logo.

Disclaimer of implied warranties; limitation of remedies

Customer's sole and exclusive remedy under this limited warranty shall be product repair or replacement as provided herein. Implied warranties, including warranties of merchantability or fitness for a particular purpose, are limited to one year on the appliance and for as long as used on cooktop gas burners, cooktop electric elements or oven door glass, or the shortest period allowed by law. Seller shall not be liable for incidental or consequential damages. Some states and provinces do not allow the exclusion or limitation of incidental or consequential damages, or limitation on the duration of implied warranties of merchantability or fitness, so these exclusions or limitations may not apply to you.

This warranty applies only while this appliance is used in the United States.

This warranty gives you specific legal rights, and you may also have other rights which vary from state to state.

Sears Brands Management Corporation, Hoffman Estates, IL 60179

IMPORTANT SAFETY INSTRUCTIONS

Read all instructions before using this appliance.

This manual contains important safety symbols and instructions. Please pay attention to these symbols and follow all instructions given.

Do not attempt to install or operate your appliance until you have read the safety precautions in this manual. Safety items throughout this manual are labeled with a WARNING or CAUTION statement based on the risk type.

Warnings and important instructions appearing in this guide are not meant to cover all possible conditions and situations that may occur. Common sense, caution, and care must be exercised with installing, maintaining, or operating your appliance.

DEFINITIONS

⚠ This is the safety alert symbol. It is used to alert you to potential personal injury hazards. Obey all safety messages that follow this symbol to avoid possible injury or death.

⚠ WARNING - Indicates a potentially hazardous situation which, if not avoided, may result in death or serious injury.

⚠ CAUTION - Indicates a potentially hazardous situation which, if not avoided, may result in minor or moderate injury.

IMPORTANT - Indicates installation, operation, maintenance, or valuable information that is not hazard related.

NOTE - Indicates a short, informal reference – something written down to assist the memory or for future reference.

⚠ WARNING If the information in this manual is not followed exactly, a fire or explosion may result causing property damage, personal injury or death.

FOR YOUR SAFETY:

- Do not store or use gasoline or other flammable vapors and liquids in the vicinity of this or any other appliance.
- WHAT TO DO IF YOU SMELL GAS:
 - Do not try to light any appliance.
 - Do not touch any electrical switch; do not use any phone in your building.
 - Immediately call your gas supplier from a neighbor's phone. Follow the gas supplier's instructions.
 - If you cannot reach your gas supplier, call the fire department.
- Installation and service must be performed by a qualified installer, servicer or the gas supplier.

IMPORTANT SAFETY INSTRUCTIONS

Read all instructions before using this appliance.

⚠ WARNING

Tip Over Hazard



- A child or adult can tip the range and be killed.
- Verify the anti-tip device has been installed to floor or wall.

- Ensure the anti-tip device is re-engaged to floor or wall when the range is moved.
- Do not operate the range without the anti-tip device in place and engaged.
- Failure to follow these instructions can result in death or serious burns to children and adults.



Range

leveling leg

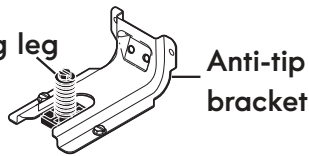

Anti-tip
bracket

To check if the anti-tip bracket is installed properly, use both arms and grasp the rear edge of the range back. Carefully attempt to tilt range forward. When properly installed, the range should not tilt forward.

Refer to the anti-tip bracket installation instructions supplied with your range for proper installation.

IMPORTANT INSTRUCTIONS FOR UNPACKING AND INSTALLATION

IMPORTANT - Read and follow the below instructions and precautions for unpacking, installing, and servicing your appliance:

Remove all tape and packaging before using the appliance. Destroy the carton and plastic bags after unpacking the appliance. Never allow children to play with packaging material. Do not remove the wiring label and other literature attached to the appliance. Do not remove model/serial number plate.

Cold temperatures can damage the electronic control. When using this appliance for the first time, or when the appliance has not been used for an extended period of time, be sure the appliance has been in temperatures above 32°F (0°C) for at least 3 hours before turning on the power to the appliance.

Never modify or alter the construction of the appliance by removing the leveling legs, panels, wire covers, anti-tip brackets/screws, or any other part of the appliance.

Be sure to have an appropriate foam-type fire extinguisher available, visible, and easily accessible located near the appliance.

⚠ WARNING - Air curtain or other overhead range hoods which operate that operate by blowing a downward air flow onto a range or cooktop, shall not be used in conjunction with gas ranges or cooktops other than when the range or cooktop and hood have been designed, tested, and listed by an independent test laboratory for use in combination with each other.

IMPORTANT SAFETY INSTRUCTIONS

Read all instructions before using this appliance.

GROUNDING INSTRUCTIONS

⚠ WARNING - Avoid fire hazard or electrical shock. Failure to follow this warning may cause serious injury, fire, or death.

⚠ WARNING - Avoid fire hazard or electrical shock. Do not use an adapter plug, use an extension cord, or remove grounding prong from the power cord. Failure to follow this warning may cause serious injury, fire, or death.

Proper Installation—Be sure your appliance is properly installed and grounded by a qualified technician. In the United States, install in accordance with the National Fuel Gas Code ANSI Z223.1/NPFA No. 54, latest edition and National Electrical Code NFPA No. 70 latest edition, and local electrical code requirements. In Canada, install in accordance with CAN/CGA B149.1 and CAN/CGA B149.2 and CSA Standard C22.1, Canadian Electrical code, Part 1-latest editions and local electrical code requirements. Install only per installation instructions provided in the literature package for this appliance.

For personal safety, this appliance must be properly grounded. For maximum safety, the power cord must be securely connected to an electrical outlet or junction box that is the correct voltage, is correctly polarized and properly grounded, and protected by a circuit breaker in accordance with local codes.

It is the personal responsibility of the consumer to have the appropriate outlet or junction box with the correct, properly grounded wall receptacle installed by a qualified electrician. It is the responsibility and obligation of the consumer to contact a qualified installer to assure that the electrical installation is adequate and is in conformance with all local codes and ordinances.

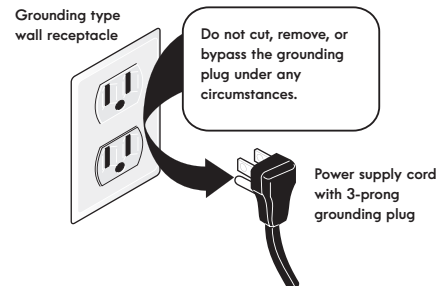

Figure 1: Grounding type wall receptacle

This appliance is equipped with a 3-prong grounding plug for your protection against shock hazard and should be plugged directly into a properly grounded receptacle. Do not cut or remove the grounding prong from this plug.

For personal safety, the appliance must be properly grounded. For maximum safety, the power cord must be plugged into an electrical outlet that is correctly polarized and properly grounded.

If a 2-prong wall receptacle is the only available outlet, it is the personal responsibility of the consumer to have it replaced with a properly grounded 3-prong wall receptacle, installed by a qualified technician.

Conversion to (L.P.) Gas

This appliance allows for conversion to Liquefied Petroleum (L.P.) Gas.

⚠ WARNING - Personal injury or death from electrical shock may occur if the conversion to L.P. gas is not made by a qualified installer or electrician. Any additions, changes or conversions required in order for this appliance to satisfactorily meet the application needs must be made by a qualified technician.

If L.P. conversion is needed, contact your local L.P. Gas provider for assistance.

See the installation instructions packaged with this appliance for complete installation and grounding instructions.

IMPORTANT SAFETY INSTRUCTIONS

Read all instructions before using this appliance.

IMPORTANT INSTRUCTIONS FOR USING THE APPLIANCE

⚠ WARNING - Storage In or On Appliance—Flammable materials should not be stored in an oven or microwave, near surface burners or elements, or in the storage or warmer drawer (if equipped). This includes paper, plastic, and cloth items, such as cookbooks, plastic ware, and towels, as well as flammable liquids. Do not store explosives, such as aerosol cans, on or near the appliance.

⚠ WARNING - Do not leave children alone - Children should not be left alone or unattended in the area where appliance is in use. They should never be allowed to sit or stand on any part of the appliance, including the storage drawer, lower broiler drawer, warmer drawer, or lower double oven.

⚠ WARNING - Do not store items of interest to children in the cabinets above the appliance or on the backguards of ranges. Children climbing on or near the appliance to reach items could be seriously injured.

⚠ WARNING - Do not allow children to climb or play around the appliance. The weight of a child on an open oven door may cause the appliance to tip, resulting in serious burns or other injury. An open drawer when hot may cause burns.

⚠ WARNING - Stepping, leaning, or sitting on the door or drawers of this appliance can result in serious injuries and also cause damage to the appliance.

⚠ WARNING - Never cover any slots, holes or passages in the oven bottom or cover and entire rack with materials such as aluminum foil. Doing so blocks air flow through the oven and may cause carbon monoxide poisoning. Aluminum foil linings may also trap heat, causing a fire hazard.

⚠ WARNING - Do not use oven or warmer drawer (if equipped) for storage.

⚠ WARNING - Never use your appliance as a space heater to heat or warm the room. Doing so may result in carbon monoxide poisoning and overheating of the appliance.

⚠ CAUTION - When heating fat or grease, watch it closely. Grease may catch fire if it becomes too hot.

⚠ CAUTION - Do not use water or flour on grease fires. Smother fire or flame or use dry chemical or foam-type extinguisher. Cover the fire with a pan lid or use baking soda.

⚠ CAUTION - Use dry potholders. Moist or damp potholders on hot surfaces may result in burns from steam. Do not let potholders touch hot cooking areas. Do not use towels or other bulky cloths.

⚠ CAUTION - Do not heat unopened food containers - Build-up of pressure may cause container to burst and result in injury.

⚠ CAUTION - Wear proper apparel - Loose-fitting or hanging garments should never be worn while using the appliance. Do not let clothing or other flammable materials contact hot surfaces.

⚠ CAUTION - Do not touch surface burners or elements, areas near these burners or elements, interior surfaces of the oven, or the warmer drawer (if equipped). Surface burners and elements may be hot even though they appear cool. Areas near surface burners and elements may become hot enough to cause burns. During and after use, do not touch, or let clothing or other flammable materials touch these areas until they are cool. These areas may include the cooktop, surfaces facing the cooktop, oven vent areas, oven door, and oven window.

⚠ CAUTION - Do not attempt to operate the appliance during a power failure. If the power fails, always turn off the appliance. If the appliance is not turned off and the power resumes, electric surface elements may resume operation when power is restored. Once the power resumes, reset the clock and the oven function.

IMPORTANT SAFETY INSTRUCTIONS

Read all instructions before using this appliance.

IMPORTANT INSTRUCTIONS FOR USING YOUR GAS COOKTOP

⚠ CAUTION - Use Proper Flame Size — Adjust flame size so it does not extend beyond the edge of the utensil. The use of undersized utensils will expose a portion of the burner flame to direct contact and may result in ignition of clothing. Proper relationship of utensil to flame will also improve efficiency.

Know which knob or key controls each surface heating area. Place cookware with food on the cooking area before turning it on. Turn the cooking area off before removing the cookware.

Use proper pan size. This appliance is equipped with one or more surface units of different sizes. Select cookware with flat bottoms that match the surface unit heating element. The use of undersized cookware may expose a portion of the flame to direct contact and may result in the ignition of clothing or other items. Using the proper cookware on the cooking areas will improve efficiency.

Always turn knob to the full LITE position when igniting top burners. Visually check that burner has lit. Then adjust the flame so it does not extend beyond the edge of the utensil.

To reduce the risk of burns, ignition of flammable materials, and spillage due to unintentional contact with the utensil, the handle of the utensil should be positioned so that it is turned inward, and does not extend over adjacent surface burners

Never leave surface burners unattended at high heat settings — Boil overs cause smoking and greasy spill overs that may ignite, or a pan that has boiled dry may melt.

Glazed cooking utensils — Only certain types of glass, glass/ceramic, ceramic, earthenware, or other glazed utensils are suitable for cook top service without breaking due to the sudden change in temperature. Check the manufacturer's recommendations for cook top use.

When you are flaming foods under a ventilating hood, turn the fan on.

IMPORTANT INSTRUCTIONS FOR USING YOUR OVEN

Protective liners—Do not use aluminum foil, aftermarket oven liners, or any other materials or devices to line oven bottom, oven racks, or any other part of the appliance. Only use aluminum as recommended for baking, such as lining cookware or as a cover placed on food. Any other use of protective liners or aluminum foil may result in a risk of electric shock or fire or a short circuit.

Use care when opening oven door, lower oven door, or warmer drawer (some models). Stand to the side of the appliance when opening the door of a hot oven. Let hot air or steam escape before you remove or replace food in the oven.

Keep oven vent ducts unobstructed. Touching surfaces in this area when the oven is on may cause severe burns. Do not place plastic or heat-sensitive items on or near the oven vent. These items can melt or ignite.

Placement of oven racks - Always place oven racks in desired location while oven is cool. If rack must be moved while oven is hot, do not let potholder contact hot burner or element in oven. Use potholders and grasp the rack with both hands to reposition. Remove all cookware and utensils before moving the rack.

Do not use a broiler pan without its insert. Broiler pans and inserts allow dripping fat to drain away from the high heat of the broiler. Do not cover the broiler insert with aluminum foil; exposed fat and grease could ignite.

Do not cook food on the oven bottom. Always cook in proper cookware and always use the oven racks.

IMPORTANT INSTRUCTIONS FOR CLEANING YOUR APPLIANCE

⚠ CAUTION - Before manually cleaning any part of the appliance, be sure all controls are turned off and the appliance is cool. Cleaning a hot appliance can cause burns.

IMPORTANT SAFETY INSTRUCTIONS

Read all instructions before using this appliance.

Clean the appliance regularly to keep all parts free of grease that could catch fire. Do not allow grease to accumulate. Greasy deposits in the fan could catch fire.

Always follow the manufacturer's recommended directions for use of kitchen cleaners and aerosols. Be aware that excess residue from cleaners and aerosols may ignite, causing damage and injury.

Clean ventilating hoods frequently - Grease should not be allowed to accumulate on hood or filter. Follow the manufacturer's instructions for cleaning vent hoods.

IMPORTANT INSTRUCTIONS FOR SELF CLEANING OVENS

Do not clean the oven door gasket. The door gasket is essential for a good seal. Care should be taken not to rub, damage, or move the gasket.

Do not use oven cleaners. No commercial oven cleaner or oven liner protective coating of any kind should be used in or around any part of the appliance.

Use the self clean cycle to clean only the parts listed in this manual.

Before using self clean, remove the broiler pan, any food, utensils, and cookware from the oven, storage drawer or warming drawer (if equipped). Remove oven racks unless otherwise instructed.

Some birds are extremely sensitive to the fumes given off during the self clean cycle of any oven. Move birds to another well-ventilated room.

IMPORTANT INSTRUCTIONS FOR SERVICE AND MAINTENANCE

Do not repair or replace any part of the appliance unless specifically recommended in the manuals. All other servicing should be done only by a qualified technician. This reduces the risk of personal injury and damage to the appliance.

Always contact your dealer, distributor, service agent, or manufacturer about problems or conditions you do not understand.

Ask your dealer to recommend a qualified technician and an authorized repair service. Know how to disconnect the power to the appliance at the circuit breaker or fuse box in case of an emergency.

Remove the oven door from any unused oven if it is to be stored or discarded.

Do not touch a hot oven light bulb with a damp cloth. Doing so could cause the bulb to break. Handle halogen lights (if equipped) with paper towels or soft gloves. Disconnect the appliance or shut off the power to the appliance before removing and replacing the bulb.

⚠ WARNING California Residents: for cancer and reproductive harm information, visit www.P65Warnings.ca.gov

PRODUCT RECORD

In this space below, record the date of purchase, model and serial number of your product. You will find the model and serial number printed on an identification plate. See [Figure 2](#) for serial plate location.

Model No. _____

Serial No. _____

Date of Purchase _____

Save sales receipt for future reference.

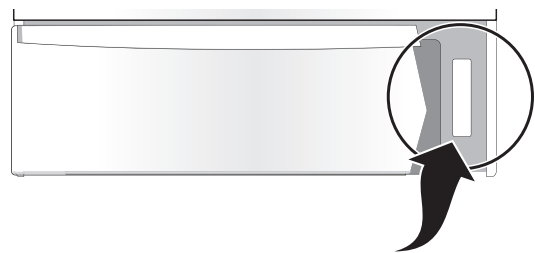



Figure 2: Serial plate location

To locate the serial plate, open storage drawer (some models) or warmer drawer (some models). The serial plate is attached to the lower right oven frame.

Cooking Recommendations

Bakeware

The material of bakeware affects how evenly and quickly it transfers heat from the pan to the food.

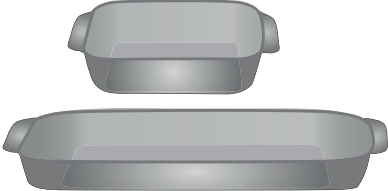
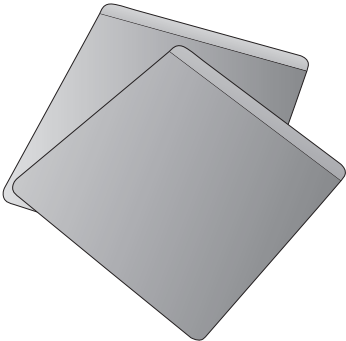
Material	Attributes	Recommendation
<p>Shiny metal bakeware</p> 	<p>Shiny, aluminum, and non-coated bakeware is the best for even heating. It is suitable for all baked goods.</p>	<p>Recommended cooking temperatures and times are based on shiny metal bakeware.</p>
<p>Dark metal bakeware</p> 	<p>Dark bakeware cooks hotter than shiny bakeware.</p>	<p>Reduce the cooking temperature by 25° F (13-14° C) when using dark bakeware.</p>
<p>Glass bakeware</p> 	<p>Glass bakeware cooks hotter than shiny bakeware.</p> <p>Glass is convenient, as the same piece of bakeware can be used for cooking, serving, and storing food.</p>	<p>Reduce the cooking temperature by 25° F (13-14° C) when using glass bakeware.</p>
<p>Insulated bakeware</p> 	<p>Insulated bakeware cooks cooler than shiny bakeware.</p> <p>Insulated bakeware is designed for baking in gas ovens.</p>	<p>Increase the cooking temperature by 25° F (13-14° C) when using insulated bakeware.</p>

Cooking Recommendations

Cooking Conditions

Conditions in your kitchen can affect the performance of your appliance when cooking food.

Condition	Attributes	Recommendation
Aging cookware	As pans age and become discolored, cooking times may need to be reduced slightly.	If food is too dark or overcooked, use the minimum cook time in the recipe or packaging. If food is too light or undercooked, use the middle to maximum cook time in the recipe or packaging.
High altitude	Air is drier and air pressure is lower. Water boils at a lower temperature, and liquids evaporate faster. Foods may take longer to bake. Doughs may rise faster.	Adjust cooking temperature, cooking time, or recipes as needed. Increase amount of liquid in baking recipes. Increase cook time on cooktop. Cover dishes to reduce evaporation. Increase bake time or oven temperature. Reduce amount of baking soda or baking powder in recipe. Reduce rising time or punch down dough and allow it to rise twice.

Cooking Results:

Small adjustments may fix a problem with food not being as done as you like.

Result	Recommendation
Food too light	Use the middle to maximum cook time recommended on packaging or recipe.
Food too dark	Use the minimum cook time recommended on packaging or recipe.

Cooking Tips:

Use these additional tips to get the best results from your appliance.

Cooking	Tips
Baking	
Rack placement	Follow the instructions in “Oven Controls” on starting on page 16 . When using only one rack, place the rack so the food is in the center of the oven.
Preheat	Fully preheat the oven before baking items like cookies, cakes, biscuits and breads. Insert food immediately after the beep.
Checking food	Use the window and oven light when checking food. Opening the door may reduce baking performance.
Food placement	Allow at least 2 inches (5 cm) of space between bakeware for proper air circulation.

Cooking	Tips
Broiling/Roasting	
Broiling pan	<p>For best results when broiling, use a broil pan with a broil pan insert designed to drain the fat from the food, help avoid spatter, and reduce smoking. The broiler pan will catch grease spills, and the insert helps prevent grease splatters.</p> <p>Note: If a broiler pan and insert are not supplied with this appliance, they may be purchased from Sears. Call 1-844-553-6667 and order broiler pan kit 5304442087.</p>

Before Setting Surface Controls

Check burner cap placement before operating the surface burners

CAUTION To prevent flare-ups and avoid creation of harmful by-products, do not use the cooktop without all burner caps properly installed to insure proper ignition and gas flame size.

On round style burners, the burner cap lip (See Fig. 1) should fit snug into the center of burner head and rest level. Refer to Figs. 2 & 3 for correct and incorrect burner cap placement. Once in place, you may check the fit by gently sliding the burner cap from side to side (Fig. 4) to be sure it is centered and firmly seated. When the burner cap lip makes contact inside the center of the burner head you will be able to hear the burner cap click. Please note that the burner cap should NOT move off the center of the burner head when sliding from side to side. Check and be sure that all oval style (some models) burner caps are correctly in place on oval burner heads.

It is very important to be sure that all surface burner caps and burner grates are properly installed and in the correct locations BEFORE operating the cooktop burners.

Remember:

- Always keep surface burner caps in place whenever using a surface burner.
- When placing the burner caps, be sure that all burner caps are seated firmly and rest level on top of burner heads.
- For proper flow of gas and ignition of burners DO NOT allow spills, food, cleaning agents or any other material to enter the gas orifice port opening.

Installing burner grates

CAUTION Do not use the surface burners without the burner caps and burner grates properly installed. Missing pieces or improper installation may lead to spills, burns, or damage to your range and cookware.

Make sure the burner grates are properly placed on the cooktop before using the surface burners. The grates are designed to rest inside the recess on the cooktop.

To install burner grates, place grates flat-side down and align into the cooktop recess. Grates should rest flush against each other and against the sides of the recess.

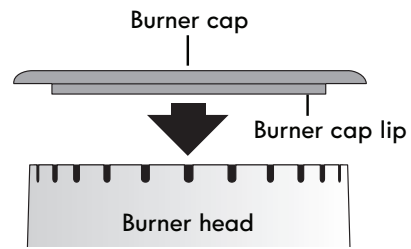

Figure 3: Burner cap on burner head

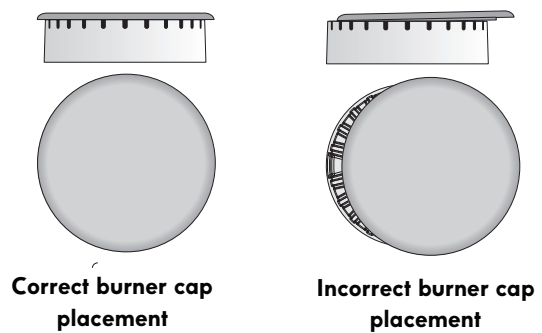

Figure 4: Correct placement (L) Incorrect placement (R)

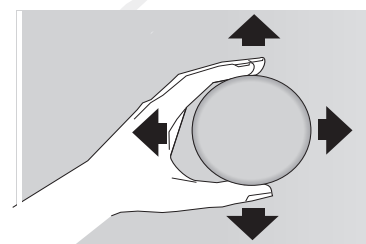

Figure 5: Moving cap gently until seated properly

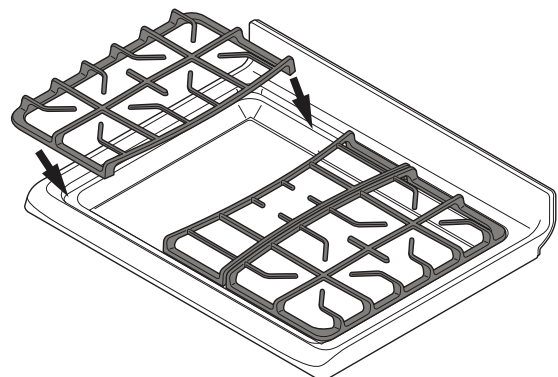

Figure 6: How to place burner grates properly

Using proper cookware

⚠ CAUTION DO NOT place flammable items such as plastic salt and pepper shakers, spoon holders or plastic wrappings on the cooktop when it is in use. These items could melt or ignite. Potholders, towels or wooden spoons could catch fire if placed too close to the range cooktop.

Important: DO NOT place aluminum foil, or ANY material that can melt on the range cooktop. If these items melt they **may damage the cooktop.**

For best cooking results, cookware should have flat bottoms that rest level on the burner grate. Before using cookware, check for flatness by rotating a ruler across the bottom of the cookware (Fig. 1).



Figure 7: Check for flat bottom cookware

Please note: The size and type of utensil used, and the amount and type of food being cooked will influence the burner flame setting needed for best cooking results.

Cookware material types

The most popular materials available are:

Aluminum - Excellent heat conductor. Some types of food will cause it to darken (Anodized aluminum cookware resists staining & pitting).

Copper - Excellent heat conductor but discolors easily.

Stainless - Slow heat conductor with uneven cooking results. Is durable, easy to clean and resists staining.

Cast Iron - A slow heat conductor however will retain heat very well. Cooks evenly once cooking temperature is reached.

Porcelain-enamel on metal - Heating characteristics will vary depending on base material.

Glass - Slow heat conductor.

Setting proper burner flame size

⚠ CAUTION Never extend the flame beyond the outer edge of the cooking utensil. A higher flame wastes energy, and increases your risk of being burned by the flame.

*These settings are based for medium-weight metal or aluminum pans with lids. Settings may vary when using other types of pans.

The color of the flame is the key to proper burner adjustment. A good flame is clear, blue and hardly visible in a well-lighted room. Each cone of flame should be steady and sharp. Adjust or clean burner if flame is yellow-orange.

For most cooking; start on the highest setting and then turn to a lower setting to complete the process. Use the recommendations below as a guide for determining proper flame size for various types of cooking (Fig. 2)

For deep fat frying; use a thermometer and adjust the surface knob accordingly. If the fat is too cool, the food will absorb the fat and be greasy. If the fat is too hot, the food will brown so quickly that the center will be under cooked. Do not attempt to deep fat fry too much food at once as the food will neither brown or cook properly.

Table 1: Suggested flame settings

Flame size	Type of cooking
High flame	Start most foods, bring water to a boil, pan broiling.
Medium flame	Maintain a slow boil, thicken sauces, gravies, steaming.
Low flame	Keep foods cooking, poaching and stewing.



Figure 8: How to set flame for efficient cooking

Setting Surface Controls

Setting Surface Burners

Your gas appliance may be equipped with different sized surface burners. The ability to heat food quicker and in larger volumes increases as the burner size increases. It is important to select cookware that is suitable for the amount and type of food being prepared.

The smaller **SIMMER** burner (on some models) is best suited for simmering delicate sauces, etc.

The standard size burners may be used for most surface cooking needs. Some models are equipped with a center burner.

The larger **POWER** burners (on some models) or **TURBO BOIL** burner (on some models) are recommended for bringing large quantities of liquid to temperature and when preparing larger quantities of food.

To set surface burners:

1. Place cooking utensil on center of surface burner grate. Be sure the cooking utensil sets stable on the burner grate.
2. Push the desired surface control knob in and turn counterclockwise out of the OFF position (See [Figure 9](#)).
3. Release the surface control knob and rotate to the LITE position. Visually check that the burner has lit.
4. Once the burner has a flame, push the control knob in and turn counterclockwise to the desired flame size. Use the control knob markings and adjust the flame as needed.

Important notes:

- Do not cook with the surface control knob left in the LITE position. The electronic ignitor will continue to spark if the control knob setting remains in the LITE position .
- When setting any surface control knob to the LITE position, all electronic surface ignitors will spark at the same time. However, only the surface burner you are setting will ignite.
- Never place or straddle a cooking utensil over two different surface cooking areas at the same time. This can cause uneven heating results.
- In the event of an electrical power outage, the surface burners can be lit manually. Use caution when lighting surface burners manually. To light a surface burner, hold a lit match to the burner head, then slowly turn the surface control knob to LITE. After burner lights push in and turn knob to desired setting.



Figure 9: Surface control knob

CAUTION Do not place flammable items such as plastic salt and pepper shakers, spoon holders or plastic wrappings on the cooktop when it is in use. These items could melt or ignite. Potholders, towels or wooden spoons could catch fire if placed too close to the range cooktop.

CAUTION Do not place aluminum foil, or ANY material that can melt on the range cooktop. If these items melt they may permanently damage the cooktop surface.

CAUTION When operating the oven, it is possible for residual heat from the oven to build-up and over time to eventually transfer to the surface control knobs located directly above the oven door.

Before setting oven controls

Oven vent location

The oven vent is located under the left side of the control panel. When the oven is on, warm air passes through this vent. This venting is necessary for proper air circulation in the oven and good baking results. **Do not block oven vent:**

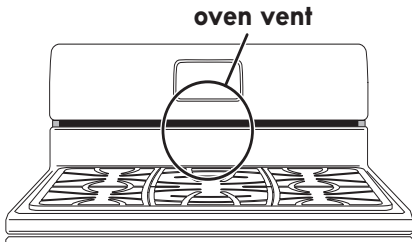

Figure 10: Oven vent in rear of range top

⚠ CAUTION Always use pot holders or oven mitts when using the oven. When cooking, the oven interior and exterior, oven racks and cooktop will become very hot which can cause burns.

⚠ WARNING Protective Liners — **DO NOT USE ALUMINUM FOIL to line the oven bottom.** Only use aluminum foil as recommended in this manual. Improper installation of these liners may result in risk of electric shock, or fire

Air circulation in the oven

For best baking results allow 2-4" (5-10 cm) around the cookware for proper air circulation and be sure pans and cookware do not touch each other, the oven door, sides or back of the oven cavity. Hot air must be able to circulate around the cookware in the oven for even heat to reach around the food.

Types of oven racks

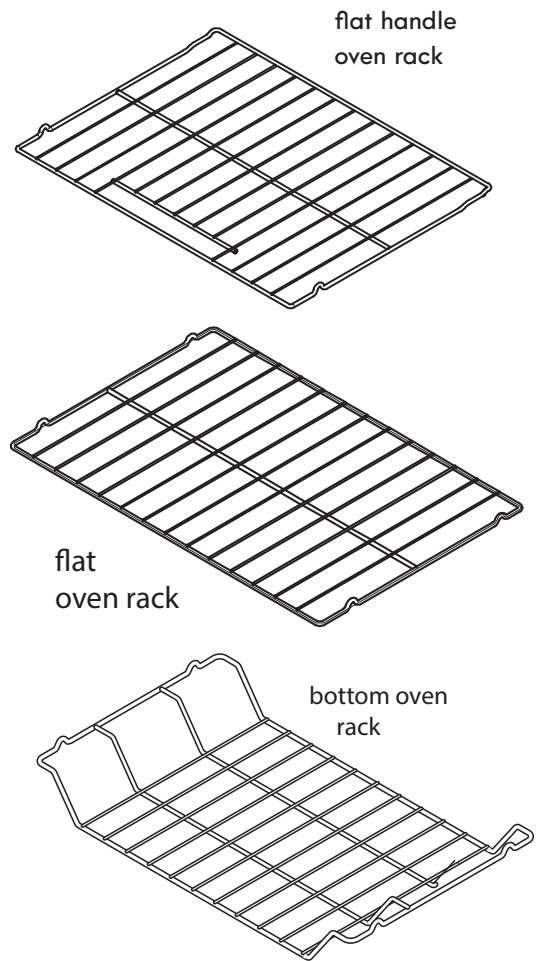

Figure 11: Variety of racks and their uses

The flat oven rack (some models) or flat handle oven rack (some models) may be used for most cooking needs.

The offset oven rack (on some models) is designed to place the base of the rack about 1/2 of a rack position lower than flat oven racks. This design allows several additional positions between the flat rack positions.

To maximize oven cooking space place the **bottom oven rack** (on some models) in the lowest rack position for roasting large cuts of meat.

Oven Controls

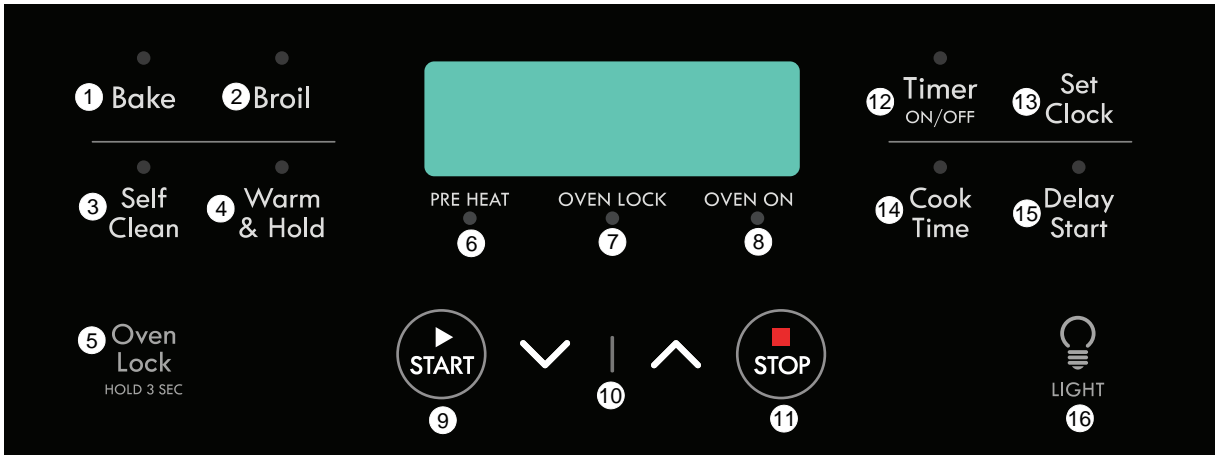

1. **Bake** - Selects Bake function.
2. **Broil** - Selects Broil function.
3. **Self Clean** - Use to select 2, 3, or 4hr Self-Clean cycle.
4. **Warm & Hold** - Use to keep cooked food warm and at serving temperature for up to 3 hours.
5. **Oven Lock** - Use to lock oven door and oven functions.
6. **PREHEAT indicator light** - Is on when oven is preheating. Stays on until the oven reaches the desired temperature.
7. **OVEN LOCK indicator light** - Is on when door locks or unlocks and when oven lockout is active.
8. **OVEN ON indicator light** - Glows each time the oven cycles on to maintain the set oven temperature.
9. **START** - Use to start all cooking functions.
10. **Up / Down arrows** - Use with the function keys to accept settings and adjust temperature and times.
11. **STOP** - Cancels any active oven function except clock and timer.
12. **Timer On/Off** - Use to set and cancel the timer and to set the Continuous Bake feature.
13. **Set Clock** - Use with arrow keys to set time of day.
14. **Cook Time** - Use to set a specific amount of time needed for cooking. Automatically cancels cooking process at end of set time.
15. **Delay Start** - Use with Bake and Self Clean functions to program a delayed start bake or delayed start self clean cycle.
16. **LIGHT** - Use to turn internal oven light on and off.

Minimum and Maximum Control Settings

All of the features listed have minimum and maximum time and temperature settings that may be entered into the control. An entry acceptance beep will sound each time a key is touched (the Oven Lockout tone is delayed by 3 seconds). An entry error tone (three short beeps) will sound if the entry of the temperature or time is below the minimum or above the maximum settings for the feature.

Table 2: Minimum and maximum control settings



Feature	Min. Temp or Time	Max. Temp or Time
Bake	170°F (77°C)	550°F (288°C)
Broil	LO	Hi
Timer	1 minute	11 hrs. 59 mins.
Self Clean	2 Hours	4 Hours
Warm & Hold	170°F (77°C)	3 Hours
Cook Time	1 Minute	11:59
Delay Time 12 Hr.	1:00	12:59
Delay Time 24 Hr.	0:00	23:59
Clock 12 Hr.	1:00	12:59
Clock 24 Hr.	0:00	23:59

Setting Clock

When the appliance is first powered up or when the power supply to the appliance has been interrupted, 12:00 will flash in the display. Press **STOP** or **Set Clock** to stop the flashing and set the clock.

The time of day must first be set before operating the oven.

To set the clock

1. Press **Set Clock** once. **CLO** appears in display.
2. Press  or  and the time appears in the display. Continue to hold arrow key until the correct time of day appears in the display.
3. Press **START** to accept time of day.



Important note:

The time of day cannot be changed when the oven is set for cooking.

Changing Temperature Display (°F or °C)

The electronic oven control is set to display °F (Fahrenheit) when shipped from the factory. The display may be changed to show either Fahrenheit or °C (Celsius) oven temperatures.

To change temperature display mode from °F to °C or from °C to °F

1. Press **Broil**. **HI** appears in the display.
2. Press and hold **Broil** until **F** or **C** appears in the display.
3. Press either  or  to toggle between **F** or **C** mode choices.
4. Press **START** to accept change. The display will return to the time of day.

Important note:

The temperature display mode cannot be changed when the oven is set for cooking.

Changing between continuous bake setting or 12-Hour Energy Saving feature

The oven control has a factory-preset 12-Hour Energy Saving feature that will turn the oven off automatically if the oven is left on for more than 12 hours. The control may be programmed to override this feature to continuously bake.

To change to continuous bake mode

1. Press and hold **Timer On/Off** until the control beeps once (about 6 seconds). **12 hr** will appear in display.
2. Use **Up/Down** key to toggle between continuous bake (- - hr) and 12hr Energy Saving (**12hr**).
3. Press **START** to accept the change.

Oven Lock

The **OVEN LOCK** feature allows you to lock the oven portion of the appliance while the oven is not in use.

To activate **OVEN LOCK** feature:

1. Be sure the door is completely closed.
2. Press and hold **OVEN LOCK** for 3 seconds. **Loc** will appear in the display. The **OVEN LOCK** indicator light will flash while the motor driven door latch begins locking the oven door. Do not open the door during this time. Allow 15 seconds for the door to completely lock. Once oven door is locked, the time of day will appear in the display.

To cancel the **OVEN LOCK** feature

1. Press and hold **OVEN LOCK** for 3 seconds. The **OVEN LOCK** indicator light will flash and the motor driven door latch will begin to unlock. Do not open the door at this time. The door will unlock completely in about 15 seconds.
2. The oven control keys will be available and the oven door can be opened again.

Important notes:



- To avoid possible damage to the oven door latch mechanism, do not attempt to open or close the oven door whenever the **OVEN LOCK** indicator light is flashing.
- If a control key is pressed when the **OVEN LOCK** is active, **Loc** will appear in the display as a reminder that the oven keys are inactive when the **OVEN LOCK** feature is active.



Oven Controls

Setting Timer

The timer may be set from 1 minute to 11 hours and 59 minutes.

To set the timer

1. Press **Timer On/Off** .
2. Press and hold  to increase the time. Release  when the desired time appears in the display.
3. Press **START** and timer will begin to count down.
4. When the set time has run out, the Timer will sound with 3 beeps and will continue to beep 3 times every 60 seconds until **Timer On/Off** is pressed.

To change time remaining in Timer, press and hold  or  to increase or decrease any time remaining.

To cancel the Timer before at any time, press **Timer On/Off** once.

Important notes:

- The timer does not start or stop the cooking process. It serves as an extra timer in the kitchen that will beep when the set time has run out. The timer may be used alone or when any other oven function is active.
- The indicator light located above **Timer On/Off** will glow when the timer is active.
- The timer will display hours and minutes until 1 hour remains. When less than 1 hour remains, the display will count down in minutes and seconds. Once the timer has less than 1 minute remaining only seconds will display.
- If the timer is active when oven cooking, the minute timer will show in the display by default. To view information of any other active oven function, press the key once for the active function to view status.



Operating Oven Light

The oven light will automatically turn on when the oven door is opened.

Press **LIGHT** on the control panel to turn the oven light ON or OFF whenever the oven door is closed. The oven light will not operate during a self clean cycle. The oven light is located at the upper left rear wall of the oven interior and is covered with a glass shield held in place by a wire holder. The glass shield protects the bulb from high temperatures and should always be in place when the oven is in use.

To replace the interior oven light see **Replacing oven light** in the **Care and Cleaning** section.

Silent or audible control mode





1. Press and hold **Delay Start** until the control beeps once (about 3 seconds). The present mode appears as OFF (silent operation) or ON (for audible operation).
2. Use  or  to toggle between audible or silent modes. To save press **START** when the desired mode of operation appears in the display

Setting Bake

Use the bake function whenever the recipe calls for baking using normal temperatures. A reminder tone will sound when the set bake temperature is reached. Bake may be programmed for any temperature from 170°F to 550°F (77°C to 288°C). The factory preset bake temperature is 350°F (177°C).



⚠ CAUTION Always use pot holders or oven mitts when using the oven. When cooking the oven interior, oven racks and cooktop will become very hot which can cause burns.

To set Bake

1. Arrange oven racks and close oven door.
2. Press **Bake**. 350° appears in display.
3. Within 15 seconds, press  or . By pressing  or , the oven temperature may be adjusted in 5°F increments (1°C if the control is set to display Celsius).
4. Press **START** when desired temperature appears, the oven will begin heating to the selected temperature. When the oven temperature reaches the set temperature, the PRE-HEAT indicator light will turn off and the oven control will beep 3 times.

To cancel bake at anytime Press .

To change the oven temperature after Bake has started

1. Press **Bake**. The current set oven temperature will display.
2. Press  or  to increase or decrease the current set temperature to the new oven temperature.

Important note:

- The oven will bake no longer than 12 hours. If you wish to bake for a longer period, see **Changing between continuous bake setting or 12-Hour Energy Saving** mode for detailed information.
- When cooking meats and poultry use rack positions 1 or 2.

Baking tips

- Fully preheat the oven before cooking items like cookies, biscuits and breads.
- When using any single rack, position the rack so that the food is in the center of the oven.
- For best results when baking cakes or cookies using 2 oven racks, place cookware as shown in Fig. 12, on page 19 and place racks in rack positions 3 & 5. (Fig. 13, on page 19)
- Dark or dull pans absorb more heat than shiny bakeware, resulting in dark or over-browning of foods. It may be necessary to reduce the oven temperature or cook time to prevent over-browning of some foods. Dark pans are recommended for pies; shiny pans are recommended for cakes, cookies and muffins.

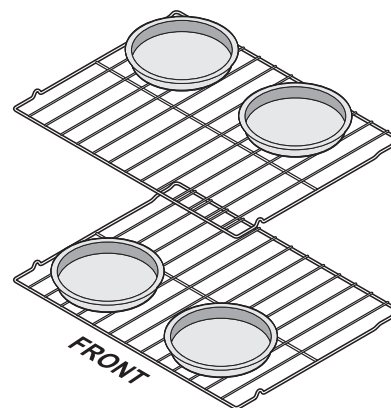

Figure 12: Baking on multiple levels

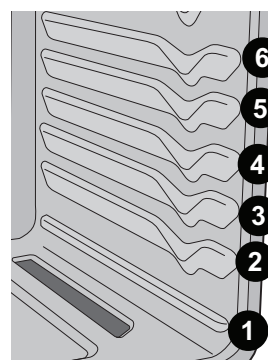

Fig. 13 Oven rack positions







Oven Controls

Setting Cook Time

Use Cook Time to set the amount of time needed for baking. The oven will turn on immediately and stop automatically after the set cook time ends.



⚠ WARNING FOOD POISONING HAZARD. Do not let food sit for more than one hour before or after cooking. Doing so can result in food poisoning or sickness.

To program the oven to begin baking immediately and to shut off automatically

1. Be sure that the clock displays the correct time of day.
2. Arrange oven racks and close oven door.
3. Press **Bake**. **350°** appears in display.
4. Within 15 seconds, press  or . The display will show the default oven temperature of 350°F (177°C). By pressing  or , the temperature may be adjusted in 5°F increments (1°C if the control is set to display Celsius). Press **START** to accept.
5. Press **Cook Time::00** will appear in display.
6. Press  or  to reach the desired cook time.
7. Press **START** to accept. When the oven temperature reaches the set temperature, the PREHEAT indicator light turns off and the oven control will beep once.
8. To cancel at anytime press .

When the cook time runs out **End** will appear in the display. The oven control will beep 3 times every minute as a reminder until **STOP** is pressed.

To change the oven temperature or cook time after baking has started

1. Press **Bake** (for oven temperature) or **Cook Time**.
2. To adjust temperature or cook time press  or  and release when the desired temperature or cook time setting appears in the display.

Important notes:

- Cook Time and Delay Start can not be used with Broil.
- While baking with Cook Time, press **Cook Time** to display any cook time remaining.
- Cook Time and Delay Start can be set with Bake.
- The maximum Cook Time or Delay Start setting is 11 hours and 59 minutes.







Setting Delay Start

Delay Start allows you to set a delayed starting time to the oven baking or cleaning functions.

⚠ WARNING FOOD POISONING HAZARD. Do not let food sit for more than one hour before or after cooking. Doing so can result in food poisoning or sickness.



⚠ CAUTION Always use pot holders or oven mitts when using the oven. When cooking the oven interior, oven racks and cook-top will become very hot which can cause burn

To program oven for a delayed starting time and to shut off automatically

1. Be sure that the clock displays the correct time of day.
2. Arrange oven racks and close oven door.
3. Press **Bake**. **350°** appears in display.
4. Within 15 seconds press  or , the oven temperature may be adjusted in 5°F increments (1°C if the control is set to display Celsius). When desired temperature is reached press **START** to accept.
5. Press **Cook Time::00** will appear in display.
6. Press the  or  to set the desired cook time. Then press **START** to accept.
7. Press **Delay Start**. The time of day will appear in the display. Press  or  until the desired starting time appears in the display and press **START**.
8. The oven will turn on at the set delayed starting time and begin heating. When the oven temperature reaches the set temperature, the **PREHEAT** indicator light will turn off and the oven control will beep 3 times.

To cancel at anytime press .

To change the oven temperature or cook time after baking has started

1. Press **Bake** (for oven temperature) or **Cook Time**.
2. Press  or  and release when the desired temperature or cook time setting appears in the display.

When the cook time runs out:

End will appear in the display. The oven control will beep 3 times every minute until  is pressed.

Setting Broil

Use the broil function to cook meats that require direct exposure to flame heat for optimum browning results. The Broil function is factory preset to broil at 550°F.

The suggested broil settings is provided for recommendations only. Increase or decrease broiling times, or move to a different rack position to suit for doneness. If the food you are broiling is not listed in the table, follow the instructions provided in your cookbook and watch the item closely.

CAUTION Always use pot holders or oven mitts when using the oven. When cooking the oven interior, oven racks and cook-top will become very hot which can cause burns.





WARNING Should an oven fire occur, close the oven door and turn the oven off. If fire continues, use a fire extinguisher. Do not put water or flour on fire. Flour may be explosive.

Important notes:

- Always arrange oven racks when the oven is cool.
- For best results when broiling, use a broil pan with broil pan insert designed to drain the fat from the food and help avoid spatter and reduce smoking.
- When broiling, always pull the oven rack out to the stop position before turning or removing food.

Important note: To purchase broil pan and insert call Sears at 1-844-553-6667 and order broiler kit 5304442087.

To set Broil

1. Arrange the oven racks when cool. For optimum browning results, preheat oven for 5 minutes before adding food.
2. Position cookware in oven. **Close oven door** when broiling.
3. Press **Broil**. **HI** will appear in display.
4. Press  or  until the desired broil setting level appears in the display. Press  for **HI** broil or  for **LO** broil setting.
5. Press **START**. Broil on one side until food is browned. Turn and broil food on other side. When finished broiling or cancel at any time press .

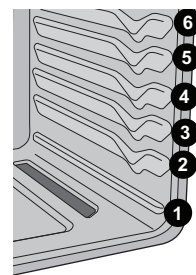
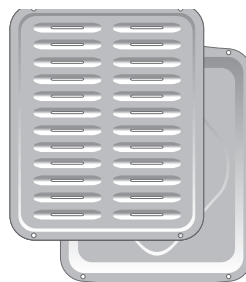

Table 3: Suggested Broil Settings

Food	Rack Position	Setting	Cook time in minutes		Doneness
			1st side	2nd side	
Steak, 1 inch thick	6th*	Hi	6	5	Rare
Steak, 1 inch thick	5th or 6th*	Hi	8	6	Medium
Steak, 1 inch thick	5th or 6th*	Hi	10	8	Medium-well
Steak, 1 inch thick	5th or 6th*	Hi	11	10	Well
Pork Chops, 3/4 inch thick	5th	Hi	12	8	Well
Chicken, bone-in	5th	Lo	25	15	Well
Chicken, boneless	5th	Lo	10	8	Well
Fish	5th	Hi	as directed		Well
Shrimp	4th	Hi	as directed		Well
Hamburger, 1 inch	5th or 6th	Hi	12	10	Medium
Hamburger, 1 inch	6th	Hi	6	6	Rare

For steaks, cook times are suggestions and should only be used as a guide. The U.S. Department of Agriculture states, "Rare fresh beef is popular, but you should know that cooking it to only 140°F (60°C) means some food poisoning organisms may survive." (Source: Safe Food Book, Your Kitchen Guide, USDA). The lowest temperature recommended by the USDA is 145°F (63°C) for medium rare fresh beef. For well done 170°F (77°C).

Oven Controls

Warm & Hold™





Warm & Hold will keep cooked foods warm and ready for serving for up to 3 hours after cooking has finished. After 3 hours the Warm & Hold will shut off automatically. Warm & Hold should only be used with foods that are already at serving temperatures. Warm & Hold will maintain the oven temperature at 170° F (77°C).

Example - To set Warm & Hold:

- If needed, arrange oven racks and place cooked food in oven.
- Press **Warm & Hold**. **Hld** will appear in the display. If no other keys are touched within 25 seconds the request for Warm & Hold will clear.
- Press **START**. Warm & Hold will automatically turn off after 3 hours.

To turn Warm & Hold off at any time press  .

To set Warm & Hold to start after a Timed Bake automatically



1. Press **Bake**. Press  or  to set temperature.
2. Press **START**.
3. Press **Cook Time**. Press  or  to set time.
4. Press **START**.
5. Press **Warm & Hold**.
6. Warm & Hold is set to turn on automatically after the Timed Bake or Delay Timed Bake has finished. The Warm & Hold indicator light will glow indicating that the Warm & Hold feature is set to start when the timed bake is finished.

Adjusting Oven Temperature



Your appliance has been factory calibrated and tested to ensure an accurate baking temperature. For the first few uses, follow your recipe times and temperature recommendations carefully. If you think the oven is cooking too hot or too cool for your recipe times, you may adjust the **UPO** (User Programmable Offset) so the oven cooks hotter or cooler than the oven temperature displayed.

The oven temperature may be increased as much as +35 °F (+19 °C) or decreased -35 °F (-19 °C) from the factory calibrated settings.

To adjust oven temperature

1. Press **Bake** and hold for 6 seconds. The UPO value will appear in the display with a degree sign.
2. The display now indicates the amount of degrees offset from the original factory temperature setting. If the control still has the original factory calibration, the display will read **0**.
3. The temperature may be adjusted up or down 35 °F (19°C), in 5F/1C increments by pressing and holding  or . Adjust until the desired amount of temperature offset appears in the display and press **START** to save.
4. If the **STOP** key is pressed during the programming mode, the UPO value will remain unchanged.

Important notes:

- Oven temperature adjustments made will not change the Broil or Self-Clean operating temperatures.
- Do not use oven thermometers such as those found in grocery stores to check the temperature settings inside your oven. These oven thermometers may vary as much as 20 to 40 °F degrees from actual temperatures.
- The oven temperature adjustment may be made if your oven control has been set to display °C (Celsius) temperatures. Minimum and maximum settings for Celsius is plus (+) or minus (-) 19 °C.
- If the display mode is set for Celsius, adjustments made will be in 1 °C increments on each press of  or .

Self Clean

A self cleaning oven cleans itself with high temperatures (well above normal cooking temperatures) which eliminate soils completely or reduces them to a fine powdered ash you can wipe away afterwards with a damp cloth.

The Self Clean function allows you to select 3 different cleaning times from 2, 3 or 4 hours. A 3-hour cleaning time is best used for normal cleaning; 2-hour time for light soils and a 4-hour clean time for heavier stubborn soils.

Read before starting Self Clean

Be sure to read all following caution and important statements before starting a self clean cycle

⚠ WARNING Do not leave small children unattended near appliance. During self clean cycle the outside of the oven can become very hot and cause burns if touched.

⚠ WARNING Do not line the oven walls, racks, oven bottom or any part of the range with aluminum foil. This will cause permanent damage to the oven interior and destroy heat distribution, and will melt to the oven interior.

⚠ WARNING Do not force the oven door open. This will damage the automatic door locking system. Use caution when opening the oven door after the self clean cycle ends. The oven may still be very hot and cause burns. To avoid possible burns stand to side of oven when opening door to allow steam or hot air to escape.

The health of some birds is extremely sensitive to fumes given off during the self clean cycle of any range. Move birds to a well ventilated room.

Important notes:

- Completely remove all oven racks and any accessories from oven cavity to avoid damage to oven racks. If the oven racks are not removed they may discolor. Remove all items from the oven and cooktop including cookware, utensils and any aluminum foil. Aluminum foil will not withstand high temperatures from a self clean cycle and will melt.
- Do not use oven cleaners or oven protective coatings in or around any part of the oven interior. Clean any soil from the oven frame, the door liner outside the oven door gasket and the small area at the front center of the oven bottom (Fig. 16, on page 23). These areas heat sufficiently to burn soil on. Clean using soap and water prior to starting Self Clean.

- Remove any excessive spills. Any spills on the oven bottom should be wiped up and removed before starting a self clean cycle. To clean use hot, soapy water and a cloth. Large spills can cause heavy smoke or fire when subjected to high temperatures. Do not allow food spills with high sugar or acid content (such as milk, tomatoes, sauerkraut, fruit juices or pie fillings) to remain on the surface as they may leave a dull spot even after cleaning.

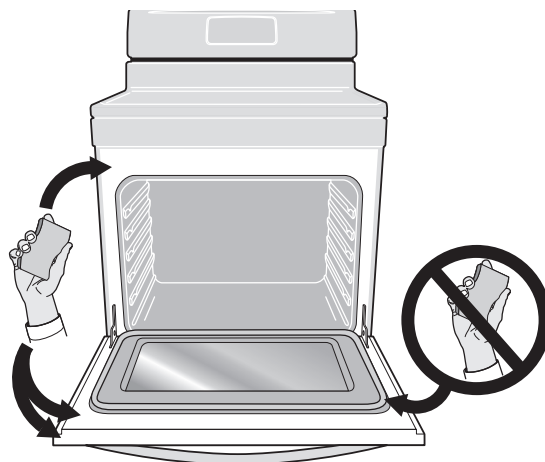

Fig. 16 Areas to clean and to avoid

- Do not clean the oven door gasket (figure). The woven material in the gasket is essential for a good seal. Care should be taken not to rub, damage or remove the oven door gasket. Doing so could cause damage to the door gasket and compromise the performance of the oven.



Important notes:

- The kitchen area should be well ventilated using an open window, ventilation fan or exhaust hood during the 1st self clean cycle. This will help eliminate the normal odors associated with the 1st self clean cycle.
- Do not attempt to open the oven door when the OVEN LOCK indicator light is flashing. Allow about 15 seconds for the motorized door latch mechanism to completely lock or unlock the oven door.
- When the clean time finishes the oven door will remain locked until the range has cooled sufficiently. In addition to the clean time that was programmed, you must allow about 1 additional hour for the oven to cool before you will be able to open the oven door.

Oven Controls

Setting Self Clean

To set Select Clean to start immediately:

1. Be sure the oven is empty and all oven racks are removed. Remove all items from the cooktop. Be sure the oven door is completely closed.
2. Press **Self Clean**. **3:00** appears in the display.
3. To change to a 2 hour clean time press  ; **2:00** appears in the display. To select a 4 hour clean time press  : **4:00** appears in the display.
4. After selecting the clean time press **START** to activate the self clean. The **OVEN LOCK** indicator light will light and **CLn** will appear in the display.

When Self Clean begins the cleaning cycle, the motorized door latch mechanism will automatically start to lock the oven door and the OVEN LOCK indicator light will flash. Do not open the oven door when the OVEN LOCK indicator light is flashing. Allow about 15 seconds for the oven door to completely lock.

Once the oven door has locked the OVEN LOCK indicator light will glow steady. When **CLn** will appear in the display Self Clean is active.





CAUTION Use caution when opening the oven door after self cleaning. The oven may still be **VERY HOT** and can cause burns. To avoid possible burns stand to the side of the oven when opening the oven door to allow hot air or steam to escape.

When Self Clean is finished:

1. The time of day will appear in the display window and the and the OVEN LOCK indicator light will continue to glow.
2. Once the oven has cooled down (about 1 hour) and the OVEN LOCK indicator light has turned off the oven door may be opened.
3. When the oven interior has completely cooled, wipe away any residue or powdered ash with a damp cloth or paper towel.

Delayed Start Self Clean:

To start Delay Start Self Clean:

1. Be sure the oven is empty and all oven racks are removed. Remove all items from the cooktop. Be sure oven door is completely closed.
2. Be sure the clock shows the correct time of day.
3. Press **Delay Start**.
4. Press and hold  to scroll to the time desired to start the self clean cycle. Press **START** when the desired start time is displayed.
5. Press **Self Clean**. **3:00** appears in the display.
6. Press  or  once. **3:00** appears in the display indicating the default 3 hour clean time is selected. To select a 2 hour clean time press  ; **2:00** appears in the display. To select a 4 hour clean time press  ; **4:00** appears in the display.
7. After selecting the desired clean time press **START**. Self Clean is set to activate. The OVEN LOCK indicator light will turn on and the oven door will lock in advance of the starting time. Once the starting time is reached **CLn** will appear in the display.

If it becomes necessary to stop Self Clean when active

1. Press  .
2. If Self Clean has heated the oven to a high temperature, allow enough time for the oven to cool and for the OVEN LOCK indicator light to turn off. When this indicator light turns off the oven door may be opened.
3. Restart Self Clean if needed.

Important notes:

If Self Clean is active and a power failure occurs, the oven may not have thoroughly cleaned. This would depend on how much cleaning time had elapsed before the power failure. If needed after power is restored, set Self Clean again.

Steam Clean

Steam cleaning works best for spot cleaning and light soils on the oven bottom. Steam clean may also be used before manually cleaning the oven.

⚠ WARNING Do not set the cleaning temperature higher than the temperature listed in these instructions. Higher temperatures will dry the steam too soon and may lead to burns or serious injury when cleaning.

⚠ WARNING Do not attempt to wipe out the oven before the cooling off period or attempt to shorten the cooling off period. Doing so may lead to burns or other serious injury when cleaning.

⚠ CAUTION Do not add ammonia, oven cleaners, or any other household cleaners or chemicals to the water used for steam cleaning.

To set the controls for steam clean:

1. Oven should be at room temperature. Remove all racks and oven accessories.
2. Scrape or wipe loose debris from the oven bottom.
3. Pour 8 oz (235 ml) of distilled or filtered water onto the oven bottom (See [Figure 17](#)). Close the oven door.

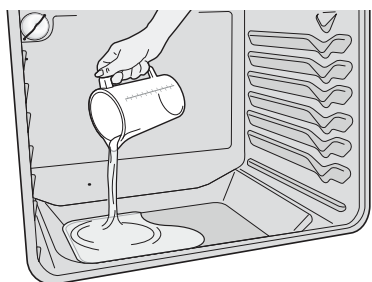



Figure 17: Pour water onto the oven bottom

4. Press **Bake**. Enter **170°F (77°C)** using the arrow keys
5. Set the minute timer for **20** minutes.
6. Allow the oven to heat. Do not open the oven door while the oven is heating.
7. An alert will sound when the timer is finished. Press **Timer ON/Off** to stop the timer and press  to return to the clock.
8. Set the minute timer for **10** minutes to allow for a cool-down period. Do not attempt to wipe out the oven before a 10 minute cool-down period.
9. An alert will sound when the timer is finished. Press **Timer ON/Off** to stop the timer.

10. Stand to the side of the range out of the way of escaping vapor when opening the oven door.
11. Wipe oven cavity and bottom. Do not clean oven door gasket (See [Figure 18](#)).

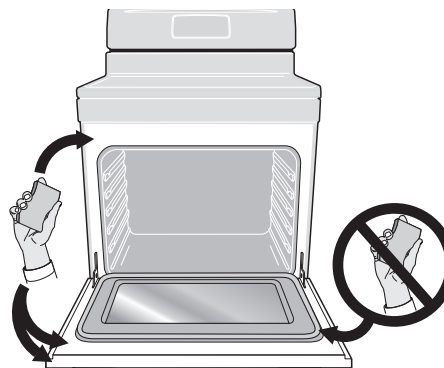

Figure 18: Do not clean the oven door gasket

To stop the steam cleaning cycle at any time, press .

Important notes:

- Always stay close to the oven when steam cleaning, so you can hear the timer alert.
- For best results, wipe out oven immediately after the cool-down period is complete.
- Removal of especially stubborn or baked-on soils may require a manual cleaning.
- Some condensation or water vapor may appear close to the oven vent, and some water may remain on the oven bottom. This is normal. Wipe with a soft cloth or sponge when the cool-down period is complete.
- The oven gasket may become damp; do not wipe dry. Open door to broil position and allow to air dry.
- Local water sources often contain minerals (hard water) and will leave deposits on the oven cavity surfaces. If this occurs, wipe cavity surfaces with diluted vinegar or lemon juice. Use distilled or filtered water.
- If the door is opened during steam cleaning or cool-down period, steam will escape and the oven may be more difficult to clean. Keep oven door closed during steam cleaning.

Care and Cleaning

Remove spills and any heavy soiling as soon as possible. Regular cleaning will reduce the difficulty of major cleaning later.

⚠ CAUTION Before cleaning any part of the appliance, be sure all controls are turned off and the appliance is cool.

⚠ CAUTION If ammonia or appliance cleaners are used, they must be removed and the appliance must be thoroughly rinsed before operating. Follow manufacturer's instructions and provide adequate ventilation.

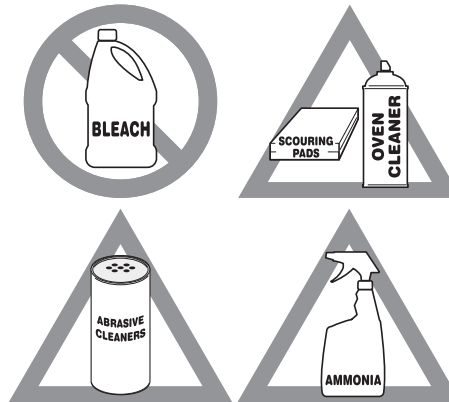

Surface or Area	Cleaning Recommendation
Aluminum and vinyl	Using a soft cloth, clean with mild dish detergent and water. Rinse with clean water, dry and polish with a soft, clean cloth.
Painted and plastic control knobs Painted body parts Painted decorative trims	Using a soft cloth, clean with mild dish detergent and water or a 50/50 solution of vinegar and water. Rinse with clean water, dry and polish with a soft, clean cloth. Glass cleaners may be used, but do not apply directly to surface; spray onto cloth and wipe.
Control panel	Using a soft cloth, clean with mild dish detergent and water or a 50/50 solution of vinegar and water. Do not spray liquids directly on the oven control and display area. Do not use large amounts of water on the control panel - excess water on the control area may cause damage to the appliance. Do not use other liquid cleaners, abrasive cleaners, scouring pads, or paper towels - they will damage the finish.
Control knobs	Using a soft cloth, clean with mild dish detergent and water or a 50/50 solution of vinegar and water. To remove control knobs: turn to the OFF position, grasp firmly, and pull off the shaft. To replace knobs after cleaning, line up the OFF markings and push the knobs into place.
Stainless Steel	Using a soft cloth, clean with mild dish detergent and water or a 50/50 solution of vinegar and water. Rinse with clean water, dry with a soft clean cloth. Do not use cleaners containing abrasives, chlorides, chlorine, or ammonia.
Easy Clean Stainless Steel Black Stainless Steel	Using a soft cloth, clean with mild dish detergent and water or a 50/50 solution of vinegar and water. Rinse with clean water, dry with a soft clean cloth. Do not use appliance cleaner, stainless steel cleaner, or cleaner containing abrasives, chlorides, chlorine, or ammonia. These cleaners may damage the finish.
Porcelain-enameled broiler pan and insert Porcelain door liner Porcelain body parts	Rinse with clean water and a damp cloth. Scrub gently with a soapy, non-abrasive scouring pad to remove most spots. Rinse with a 50/50 solution of clean water and ammonia. If necessary, cover difficult spots with an ammonia-soaked paper towel for 30 to 40 minutes. Rinse and wipe dry with a clean cloth. Remove all cleaners or future heating could damage the porcelain. Do not allow food spills with a high sugar or acid content (milk, tomatoes, sauerkraut, fruit juices or pie filling) to remain on porcelain surfaces. These spills may cause a dull spot even after cleaning.
Self-cleaning oven interior	Before setting a self-clean cycle, clean soils from the oven frame, areas outside the oven door gasket, and the small area at the front center of the oven bottom. See "Setting Self Clean" on page 24 .
Oven door	Use mild dish detergent and water or a 50/50 solution of vinegar and water to clean the top, sides, and front of the oven door. Rinse well. Glass cleaner may be used on the outside glass of the door. Ceramic smoothtop cleaner or polish may be used on the interior door glass. Do not immerse the door in water. Do not spray or allow water or cleaners to enter the door vents. Do not use oven cleaners, cleaning powders, or any harsh abrasive cleaning materials on the outside of the oven door. Do not clean the oven door gasket. The oven door gasket is made of a woven material which is essential for a good seal. Do not rub, damage, or remove this gasket.

General Cleaning

Refer to this chapter for more detailed information about cleaning specific parts of the range.

⚠ CAUTION Before manually cleaning any part of the range, be sure all controls are turned off and the range is cool. The range may be hot and can cause burns.

⚠ CAUTION Ammonia must be rinsed before operating the oven. Provide adequate ventilation.

Aluminum foil and utensils

⚠ WARNING Never cover any slots, holes, or passages in the oven bottom or cover an entire oven rack with materials such as aluminum foil. Doing so blocks air flow through the oven and may cause carbon monoxide poisoning. Aluminum foil linings may trap heat, causing a fire hazard.

⚠ WARNING Protective Liners — Do not use aluminum foil to line the oven bottom. Only use aluminum foil as recommended in this manual. Improper installation of these liners may result in risk of electric shock, or fire.

- Aluminum foil - Use of aluminum foil on a hot cooktop can damage the cooktop. Do not use thin aluminum cooking utensils or allow aluminum foil to touch the surface burners under any circumstances.
- Aluminum utensils - The melting point of aluminum is much lower than that of other metals. Care must be taken when aluminum pots or pans are used on the cooktop. If aluminum pans are allowed to boil dry when using the cooktop, the utensil will be damaged or destroyed.

Cleaning the Cooktop and Surface Burners

⚠ CAUTION To avoid possible burns, do not attempt any of the cooktop cleaning instructions provided before turning OFF all of the surface burners and allow them to completely cool.

⚠ CAUTION Any additions, changes or conversions required in order for this appliance to satisfactorily meet the application needs must be made by an authorized qualified agency.

Routinely clean the cooktop. Wipe with a clean, damp cloth and wipe dry to avoid scratches. Keeping the surface burner head ports and slots clean will prevent improper ignition and an uneven flame.

Cleaning recessed and contoured areas of cooktop

If a spill occurs on or in the recessed or contoured areas, blot up spill with an absorbent cloth. Rinse with a clean, damp cloth and wipe dry.

Cleaning surface burner grates

- Clean only after the grates are completely cool.
- Use nonabrasive plastic scrubbing pad and mild abrasive cleanser or clean in the dishwasher.
- Food soils containing acids may affect the finish. Clean immediately after the grates are cool.
- Thoroughly dry grates immediately following cleaning.

Cleaning burner caps

- Remove caps from burner heads after they have cooled.
- Clean heavy soils with a plastic scrubbing pad and absorbent cloth.
- Thoroughly dry burner caps immediately following cleaning including the bottom and inside of cap.
- Do not use abrasive cleaners. They can scratch porcelain.
- Do not clean burner caps in the dishwasher.
- Do not operate surface burners without burner caps properly in place. Read important notes.

Cleaning surface burner heads

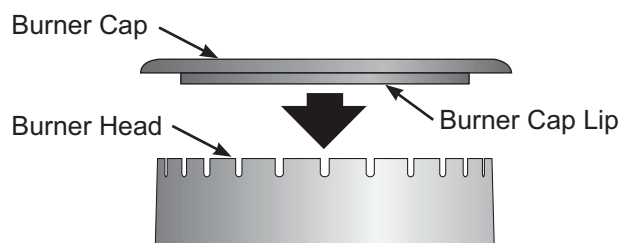

For proper gas flow it may be necessary to clean the burner head and slots. To clean, first use a clean DAMP cloth to soak up any spills. Remove any food from between the burner slots using a small nonabrasive brush like a toothbrush and afterwards wipe up using a damp cloth. For stubborn soils located in the slots, use a small-gauge wire or needle to clean.

Any spill on or around the electrode must be carefully cleaned. Take care not to hit the electrode with any thing hard or it could be damaged.

Important note:

Small food particulars on or around the electrode could stop the burner from lighting.

Care and Cleaning

To clean the burner head ignition ports

Each burner head has a small ignition port located as shown. Should you experience ignition problems it may be that this port hole is partially blocked with soil. With the burner head in place, use a small wire gauge needle or the end of a paper clip to clear the ignition port.

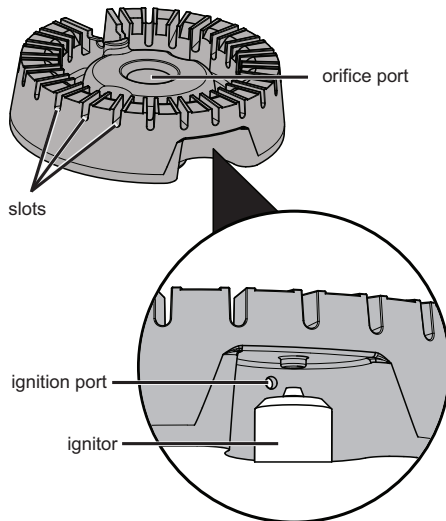

Important notes:

- The surface burner heads are secured to the cooktop and must be cleaned in place on the cooktop.
- Always keep the surface burner caps in place whenever a surface burner is in use.
- When replacing the burner caps, be sure the burner caps are seated firmly on top of the burner heads.
- For proper flow of gas and ignition of burners do not allow spills, food, cleaning agents or any other material to enter the gas orifice port opening.

To remove and replace storage drawer (some models)

Use the storage drawer for storing cooking utensils. The drawer can be removed to facilitate cleaning under the range. Use care when handling the drawer.

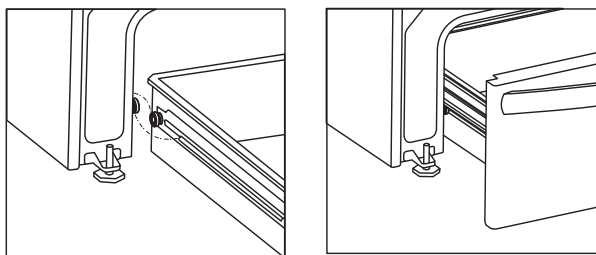

Figure 19: Open drawer(L) Closed drawer(R)

Replacing oven light (some models)

CAUTION Be sure the range is unplugged and all parts are cool before replacing oven light. Wear a leather-faced glove for protection against possible broken glass.

The oven light is located at the rear of the oven cavity and is covered with a glass shield held by a wire holder. The glass shield protects the light bulb and must be in place whenever the oven is in use.

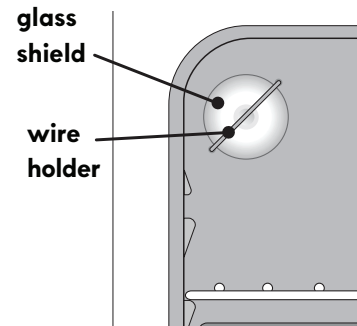

Figure 20: Replacing the oven light

To replace the interior oven light bulb:

1. Turn electrical power off at the main source or unplug the range.
2. Press wire holder to one side to release the glass shield that covers the light bulb.
3. Replace light with a new 40 watt appliance bulb.
4. Replace glass shield over bulb and snap wire holder back into place.
5. Turn power on at the main source (or plug the appliance in).
6. The clock will then need to be reset. To reset, see ["Setting Clock"](#) on [page 17](#).

Removing and replacing the lift-off oven door

⚠ CAUTION To avoid possible injury when removing or replacing the oven door, follow the instructions below carefully and always hold the oven door with both hands positioned away from the door hinge area.

⚠ CAUTION The door is heavy. For safe, temporary storage, lay the door flat with the inside of the door facing down.

To remove the oven door:

1. Open oven door completely (horizontal with floor - [Figure 21](#)).
2. Pull the door hinge locks on both left and right door hinges down from the oven frame completely towards the oven door ([Figure 22](#)). A tool such as a small flat-blade screwdriver may be required.
3. Firmly grasp both sides of oven door along the door sides (Do not use the oven door handle - [Figure 23](#)).
4. Close the door to the broil stop position (the oven door will stop into this position just before fully closing).
5. With the oven door in the broil stop position, lift the oven door hinge arms over the roller pins located on each side of the oven frame ([Figure 24](#)).

To replace oven door:

1. Firmly grasp both sides of oven door along the door sides (Do not use the oven door handle - [Figure 23](#)).
2. Holding the oven door at the same angle as the removal position, seat the hook of the hinge arm over the roller pins located on each side of the oven door frame ([Figure 24](#)). The hook of the hinge arms must be fully seated onto the roller pins.
3. Fully open the oven door (horizontal with floor - [Figure 21](#)).
4. Push the door hinge locks up towards and into the oven frame on both left and right oven door hinges ([Figure 22](#)) to the locked position; then, close the oven door.

Special care instructions

Most oven doors contain glass that can break. Follow these recommendations:

- Do not close the oven door until all the oven racks are fully in place inside the oven cavity.
- Do not hit the glass with pots, pans, or any other object.
- Scratching, hitting, jarring, or stressing the glass may weaken its structure causing an increased risk of breakage at a later time.

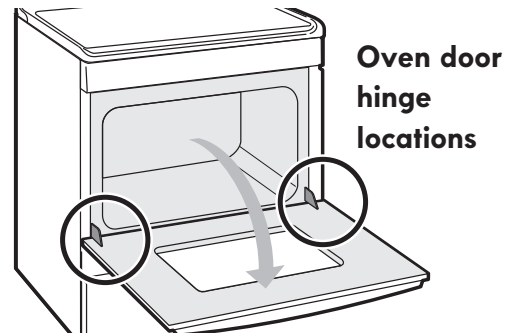

Figure 21: Oven hinge locations

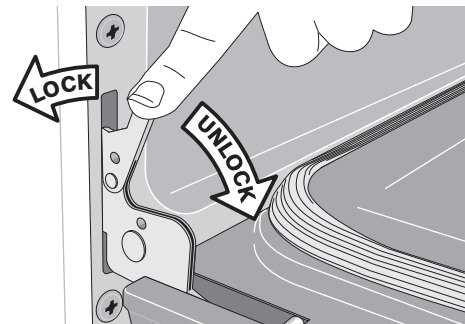

Figure 22: Hinge lock/unlock positions

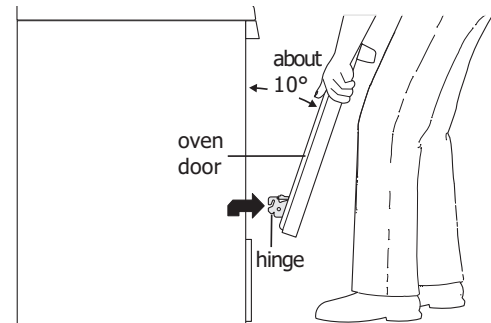

Figure 23: How to remove door

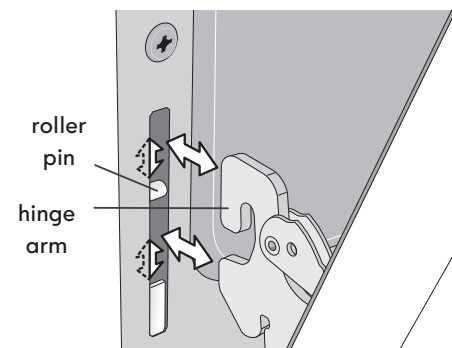

Figure 24: Hinge pin locations





Before You Call

Oven Baking

For best cooking results, heat the oven before baking cookies, breads, cakes, pies or pastries, etc. There is no need to preheat the oven for roasting meat or baking casseroles.

The cooking times and temperatures needed to bake a product may vary slightly from your previously owned appliance.

Baking Problems and Solutions

Baking Problems	Causes	Corrections
Cookies and biscuits burn on the bottom. 	<ul style="list-style-type: none"> • Cookies and biscuits put into oven before the preheating time is completed. • Oven rack is overcrowded. • Dark pans absorb heat too fast. 	<ul style="list-style-type: none"> • Allow oven to preheat to desired temperature before placing food in oven. • Choose pan sizes that permit 2" to 4" of air space (5.1 cm to 10.2 cm) on all sides when placed in the oven. • Use a medium weight baking sheet.
Cakes too dark on top or bottom 	<ul style="list-style-type: none"> • Cakes put in oven before preheating time is completed. • Rack position too high or too low. • Oven too hot. 	<ul style="list-style-type: none"> • Allow oven to preheat to the selected temperature before placing food in the oven. • Use proper rack position for baking needs. • Set oven temperature 25°F/12°C lower than recommended.
Cakes not done in center 	<ul style="list-style-type: none"> • Oven too hot. • Incorrect pan size. • Pan not centered in oven. 	<ul style="list-style-type: none"> • Set oven temperature 25°F/12°C lower than recommended. • Use pan size suggested in recipe. • Use proper rack position and place pan so there is 5.1 cm to 10.2 cm (2" to 4") of space on all sides of pan.
Cakes not level. 	<ul style="list-style-type: none"> • Oven not level. • Pan too close to oven wall or rack overcrowded. • Pan warped. 	<ul style="list-style-type: none"> • Place a marked glass measuring cup filled with water on the center of the oven rack. If the water level is uneven, refer to the installation instructions for leveling the oven. • Be sure to allow 5.1 cm to 10.2 cm (2" to 4") of clearance on all sides of each pan in the oven. • Do not use pans that are dented or warped.
Foods not done when cooking time is over. 	<ul style="list-style-type: none"> • Oven too cool. • Oven overcrowded. • Oven door opened too frequently. 	<ul style="list-style-type: none"> • Set oven temperature 25°F/12°C higher than suggested and bake for the recommended time. • Be sure to remove all pans from the oven except the ones to be used for baking. • Open oven door only after shortest recommended baking time.

Solutions to Common Problems

Before you call for service, review the following list. It may save you time and expense. Possible solutions are provided with the problem listed:

Problem	Solution
Poor baking results	<ul style="list-style-type: none"> Many factors affect baking results. Make sure the proper oven rack position is used. Center food in the oven and space pans to allow air to circulate. Allow the oven to preheat to the set temperature before placing food in the oven. Try adjusting the recipe's recommended temperature or baking time. If you feel the oven is too hot or cool, see "Adjusting Oven Temperature" on page 22.
Appliance is not level.	<ul style="list-style-type: none"> Be sure floor is level, strong, and stable enough to adequately support range. If floor is sagging or sloping, contact a carpenter to correct the situation. Poor installation. Place oven rack in center of oven. Place a level on the oven rack. Adjust leveling legs at base of appliance until the rack is level. Kitchen cabinet alignment may make range appear not level. Be sure cabinets are square and have sufficient room for appliance clearance.
Cannot move appliance easily. Appliance must be accessible for service.	<ul style="list-style-type: none"> Cabinets not square or are built in too tightly. Contact builder or installer to make appliance accessible. Carpet interferes with appliance. Provide sufficient space so appliance can be lifted over carpet. Gas line is hard-plumbed. Have a flexible CSA International approved metal appliance connector installed.
Entire appliance does not operate.	<ul style="list-style-type: none"> Make sure power cord is plugged properly into outlet. Electrical power outage. Check house lights to be sure. Call your local electric company for service outage information. Service wiring is not complete. Call 1-844-553-6667 for assistance (See back cover).
Oven portion of appliance does not operate.	<ul style="list-style-type: none"> Be sure regulator gas valve is turned to ON. See installation instructions. The time of day is not set. The time of day must first be set in order to operate the oven. See "Setting Clock" on page 17. Be sure the oven controls are set properly for the desired function. See the "Oven Controls" chapter starting on page 16 and review instructions for the desired cooking function in this manual or see "Entire appliance does not operate" in this checklist.
Oven light does not work.	<ul style="list-style-type: none"> Be sure the oven light is secure in the socket. Also see "Replacing oven light (some models)" on page 28.
Oven smokes excessively when broiling.	<ul style="list-style-type: none"> Incorrect setting. Follow the "Setting Broil" instructions on page 21. Be sure oven door is closed when broiling. Meat too close to the broiler. Reposition the broil rack to provide proper clearance between the meat and the broiler. Preheat the broiler for searing. Meat not properly prepared. Remove excess fat from meat. Cut remaining fatty edges to prevent curling, but do not cut into lean. Grease has built up on oven surfaces. Regular cleaning is necessary when broiling frequently. Old grease or food spatters cause excessive smoking.

Before You Call

Flames inside oven or smoking from oven vent.	<ul style="list-style-type: none">Excessive spillovers in oven. For example, this will happen for pie spillovers or large amounts of grease left on the oven bottom. Wipe up excessive spillovers before starting oven. If flames or excessive smoke are present, follow the "Setting Broil" instructions on page 21.
Oven control panel beeps and displays any F code error.	<ul style="list-style-type: none">Oven control has detected a fault or error condition. Press STOP to clear the error code. Try Bake or Broil function. If the F code error repeats, remove power from appliance, wait 5 minutes, and then repower appliance and set clock with the correct time of day. Try Bake or Broil function again. If the fault recurs, press STOP to clear and call 1-844-553-6667 for assistance (See back cover).
Surface burners do not ignite.	<ul style="list-style-type: none">Surface control knob was not completely turned to LITE. Push in and turn the surface control knob to LITE until burner ignites and then turn control knob to desired flame size.Burner ports are clogged. With the burner OFF, use a small-gauge wire or needle to burner head slots and ignition ports. See "Cleaning the Cooktop and Surface Burners" in the Care & Cleaning section on page 26 for additional cleaning instructions.Range power cord is disconnected from outlet (electric ignition models only). Be sure power cord is securely plugged into the power outlet.Electrical power outage. Burners may be lit manually. See "Setting Surface Burners" on page 14.
Surface burner flame uneven or only part way around burner cap.	<ul style="list-style-type: none">Burner slots or ports are clogged. With the surface burner OFF, clean ports with a small-gauge wire or needle.Moisture is present after cleaning. Lightly fan the flame and allow burner to operate until flame is full.Burner caps are not seated properly. Check that all burner caps are level and seated correctly on burner heads. See "Cleaning the Cooktop and Surface Burners" in the Care & Cleaning section on page 26 for additional cleaning instructions.
Surface burner flame is too high.	<ul style="list-style-type: none">Surface control knob is set too high. Adjust to lower flame setting.Burner caps are not seated properly. Check that all surface burner caps are level and seated correctly on surface burner heads. See "Cleaning the Cooktop and Surface Burners" in the Care & Cleaning section on page 26 for additional cleaning instructions.Incorrect L.P. conversion. Refer to L.P. conversion kit instructions to correct.
Surface burner flame is orange.	<ul style="list-style-type: none">Dust particles in main gas line. Allow the burner to operate a few minutes until flame turns blue. In coastal areas, a slightly orange flame is unavoidable due to salt content in air.Incorrect L.P. conversion. Refer to L.P. conversion kit instructions to correct.
The oven control display shows "SCC" and self-clean is not working.	<ul style="list-style-type: none">If the cooktop is used during a self-clean cycle, the oven may turn off. The oven control display will show "SCC". Press STOP to clear the SCC message. The oven door will remain locked until the oven has cooled down below cleaning temperature. If the oven is below cleaning temperature, the user can start another clean cycle immediately. If the oven is in cleaning temperature range, another self-clean cycle can be set once the door unlocks (after 4 hours).

Kenmore[®]

Customer Care Hotline

To schedule repair service or order parts

Para pedir servicio o ordenar piezas

1-844-553-6667

www.kenmore.com.

