

Use & Care Guide  
Manual de Uso y Cuidado  
English / Español

Model/Modelo: 790.9263\*

# Kenmore®

## Electric Range

## Estufa eléctrica

\* = color number, número de color

P/N 808530005 Rev. A

Sears Brands Management Corporation  
Hoffman Estates, IL 60179 U.S.A.  
[www.kenmore.com](http://www.kenmore.com)  
[www.sears.com](http://www.sears.com)



# Table of Contents

Cooking Recommendations.....	9
Before Setting Surface Controls.....	12
Setting Surface Controls.....	15
Before Using Oven.....	19
Oven Controls .....	20
Minimum and Maximum Control Settings .....	20
Self Clean .....	28
Care & Cleaning .....	31
Before You Call .....	37

---

## KENMORE LIMITED WARRANTY

WITH PROOF OF SALE the following warranty coverage applies when this appliance is correctly installed, operated and maintained according to all supplied instructions.

### One Year on Appliance

FOR ONE YEAR from the date of sale this appliance is warranted against defects in material or workmanship. A defective appliance will receive free repair or replacement at option of seller.

### Lifetime on Cooktop Gas Burners and Cooktop Electric Elements

FOR AS LONG AS IT IS USED from the date of sale, a free replacement will be supplied for a defective cooktop gas burner or cooktop electric element. If the defect appears within the first year, a new burner or element will be installed at no charge. If the defect appears after the first year, a new burner or element will be supplied but not installed at no charge. This Lifetime warranty covers only the burners or elements, and does not apply to any other related component or mechanism. You are responsible for the labor cost of burner or element glass installation after the first year from the date of sale.

For warranty coverage details to obtain free repair or replacement, visit the web page: [www.kenmore.com/warranty](http://www.kenmore.com/warranty)

All warranty coverage applies for only 90 DAYS from the sale date if this appliance is ever used for other than private household purposes.

### This warranty covers ONLY defects in material and workmanship, and will NOT pay for:

1. Cracks in a ceramic glass cooktop that are not a result of thermal shock.
2. Stains and scratches on a ceramic glass cooktop resulting from accident or improper operation or maintenance.
3. Discoloration of cooktop surfaces resulting from normal use.
4. Expendable items that can wear out from normal use, including but not limited to filters, belts, bags or screw-in base light bulbs.
5. A service technician to clean or maintain this appliance, or to instruct the user in correct appliance installation, operation and maintenance.
6. Service calls to correct appliance installation not performed by Sears authorized service agents, or to repair problems with house fuses, circuit breakers, house wiring, and plumbing or gas supply systems resulting from such installation.
7. Damage to or failure of this appliance resulting from installation not performed by Sears authorized service agents, including installation that was not in accord with electrical, gas or plumbing codes.
8. Damage to or failure of this appliance, including discoloration or surface rust, if it is not correctly operated and maintained according to all supplied instructions.
9. Damage to or failure of this appliance, including discoloration or surface rust, resulting from accident, alteration, abuse, misuse or use for other than its intended purpose.
10. Damage to or failure of this appliance, including discoloration or surface rust, caused by the use of detergents, cleaners, chemicals or utensils other than those recommended in all instructions supplied with the product.
11. Damage to or failure of parts or systems resulting from unauthorized modifications made to this appliance.
12. Service to an appliance if the model and serial plate is missing, altered, or cannot easily be determined to have the appropriate certification logo.

### Disclaimer of implied warranties; limitation of remedies

Customer's sole and exclusive remedy under this limited warranty shall be product repair or replacement as provided herein. Implied warranties, including warranties of merchantability or fitness for a particular purpose, are limited to one year on the appliance and for as long as used on cooktop gas burners or cooktop electric elements, or the shortest period allowed by law. Seller shall not be liable for incidental or consequential damages. Some states and provinces do not allow the exclusion or limitation of incidental or consequential damages, or limitation on the duration of implied warranties of merchantability or fitness, so these exclusions or limitations may not apply to you.

This warranty applies only while this appliance is used in the United States.

This warranty gives you specific legal rights, and you may also have other rights which vary from state to state.

Sears Brands Management Corporation, Hoffman Estates, IL 60179

# IMPORTANT SAFETY INSTRUCTIONS

Read all instructions before using this appliance.

This manual contains important safety symbols and instructions. Please pay attention to these symbols and follow all instructions given.

Do not attempt to install or operate your appliance until you have read the safety precautions in this manual. Safety items throughout this manual are labeled with a WARNING or CAUTION statement based on the risk type.

Warnings and important instructions appearing in this guide are not meant to cover all possible conditions and situations that may occur. Common sense, caution, and care must be exercised with installing, maintaining, or operating your appliance.

## DEFINITIONS

**⚠** This is the safety alert symbol. It is used to alert you to potential personal injury hazards. Obey all safety messages that follow this symbol to avoid possible injury or death.

**⚠ WARNING** - Indicates a potentially hazardous situation which, if not avoided, may result in death or serious injury.

**⚠ CAUTION** - Indicates a potentially hazardous situation which, if not avoided, may result in minor or moderate injury.

**IMPORTANT** - Indicates installation, operation, maintenance, or valuable information that is not hazard related.

**NOTE** - Indicates a short, informal reference – something written down to assist the memory or for future reference.

### **⚠ WARNING**

### Tip Over Hazard

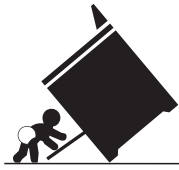

- A child or adult can tip the range and be killed.
- Verify the anti-tip device has been installed to floor or wall.

- Ensure the anti-tip device is re-engaged to floor or wall when the range is moved.
- Do not operate the range without the anti-tip device in place and engaged.
- Failure to follow these instructions can result in death or serious burns to children and adults.



Range

leveling leg

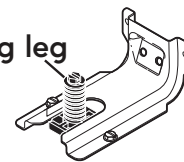

Anti-tip  
bracket

To check if the anti-tip bracket is installed properly, use both arms and grasp the rear edge of the range back. Carefully attempt to tilt range forward. When properly installed, the range should not tilt forward.

Refer to the anti-tip bracket installation instructions supplied with your range for proper installation.

# IMPORTANT SAFETY INSTRUCTIONS

Read all instructions before using this appliance.

## IMPORTANT INSTRUCTIONS FOR UNPACKING AND INSTALLATION

**IMPORTANT** - Read and follow the below instructions and precautions for unpacking, installing, and servicing your appliance:

Remove all tape and packaging before using the appliance. Destroy the carton and plastic bags after unpacking the appliance. Never allow children to play with packaging material. Do not remove the wiring label and other literature attached to the appliance. Do not remove model/serial number plate.

Cold temperatures can damage the electronic control. When using this appliance for the first time, or when the appliance has not been used for an extended period of time, be sure the appliance has been in temperatures above 32°F (0°C) for at least 3 hours before turning on the power to the appliance.

Never modify or alter the construction of the appliance by removing the leveling legs, panels, wire covers, anti-tip brackets/screws, or any other part of the appliance.

Be sure to have an appropriate foam-type fire extinguisher available, visible, and easily accessible located near the appliance.

## GROUNDING INSTRUCTIONS

**⚠ WARNING** - Avoid fire hazard or electrical shock. Failure to follow this warning may cause serious injury, fire, or death.

**⚠ WARNING** - Avoid fire hazard or electrical shock. Do not use an adapter plug, use an extension cord, or remove grounding prong from the power cord. Failure to follow this warning may cause serious injury, fire, or death.

**Proper Installation**—Be sure your appliance is properly installed and grounded by a qualified technician. In the United States, install in accordance with the National Fuel Gas Code ANSI Z223.1/NPFA No. 54, latest edition and National Electrical Code NFPA No. 70 latest edition, and local electrical code requirements. In Canada, install in accordance with CAN/CGA B149.1 and CAN/CGA B149.2 and CSA Standard C22.1, Canadian Electrical code, Part 1-latest editions and local electrical code requirements. Install only per installation instructions provided in the literature package for this appliance.

For personal safety, this appliance must be properly grounded. For maximum safety, the power cord must be securely connected to an electrical outlet or junction box that is the correct voltage, is correctly polarized and properly grounded, and protected by a circuit breaker in accordance with local codes.

It is the personal responsibility of the consumer to have the appropriate outlet or junction box with the correct, properly grounded wall receptacle installed by a qualified electrician. It is the responsibility and obligation of the consumer to contact a qualified installer to assure that the electrical installation is adequate and is in conformance with all local codes and ordinances.

See the installation instructions packaged with this appliance for complete installation and grounding instructions.

# IMPORTANT SAFETY INSTRUCTIONS

Read all instructions before using this appliance.

## IMPORTANT INSTRUCTIONS FOR USING THE APPLIANCE

**⚠ WARNING** - Storage In or On Appliance—Flammable materials should not be stored in an oven or microwave, near surface burners or elements, or in the storage or warmer drawer (if equipped). This includes paper, plastic, and cloth items, such as cookbooks, plastic ware, and towels, as well as flammable liquids. Do not store explosives, such as aerosol cans, on or near the appliance.

**⚠ WARNING** - Do not leave children alone - Children should not be left alone or unattended in the area where appliance is in use. They should never be allowed to sit or stand on any part of the appliance, including the storage drawer, lower broiler drawer, warmer drawer, or lower double oven.

**⚠ WARNING** - Do not store items of interest to children in the cabinets above the appliance or on the backguards of ranges. Children climbing on or near the appliance to reach items could be seriously injured.

**⚠ WARNING** - Do not allow children to climb or play around the appliance. The weight of a child on an open oven door may cause the appliance to tip, resulting in serious burns or other injury. An open drawer when hot may cause burns.

**⚠ WARNING** - Stepping, leaning, or sitting on the door or drawers of this appliance can result in serious injuries and also cause damage to the appliance.

**⚠ WARNING** - Never cover any slots, holes or passages in the oven bottom or cover and entire rack with materials such as aluminum foil. Doing so blocks air flow through the oven and may cause carbon monoxide poisoning. Aluminum foil linings may also trap heat, causing a fire hazard.

**⚠ WARNING** - Do not use oven or warmer drawer (if equipped) for storage.

**⚠ WARNING** - Never use your appliance as a space heater to heat or warm the room. Doing so may result in carbon monoxide poisoning and overheating of the appliance.

**⚠ CAUTION** - When heating fat or grease, watch it closely. Grease may catch fire if it becomes too hot.

**⚠ CAUTION** - Do not use water or flour on grease fires. Smother fire or flame or use dry chemical or foam-type extinguisher. Cover the fire with a pan lid or use baking soda.

**⚠ CAUTION** - Use dry potholders. Moist or damp potholders on hot surfaces may result in burns from steam. Do not let potholders touch hot cooking areas. Do not use towels or other bulky cloths.

**⚠ CAUTION** - Do not heat unopened food containers - Build-up of pressure may cause container to burst and result in injury.

**⚠ CAUTION** - Wear proper apparel - Loose-fitting or hanging garments should never be worn while using the appliance. Do not let clothing or other flammable materials contact hot surfaces.

# IMPORTANT SAFETY INSTRUCTIONS

Read all instructions before using this appliance.

**⚠ CAUTION** - Do not touch surface burners or elements, areas near these burners or elements, interior surfaces of the oven, or the warmer drawer (if equipped). Surface burners and elements may be hot even though they appear cool. Areas near surface burners and elements may become hot enough to cause burns. During and after use, do not touch, or let clothing or other flammable materials touch these areas until they are cool. These areas may include the cooktop, surfaces facing the cooktop, oven vent areas, oven door, and oven window.

**⚠ CAUTION** - Do not attempt to operate the appliance during a power failure. If the power fails, always turn off the appliance. If the appliance is not turned off and the power resumes, electric surface elements may resume operation when power is restored. Once the power resumes, reset the clock and the oven function.

## IMPORTANT INSTRUCTIONS FOR USING YOUR RADIANT COOKTOP

Know which knob or key controls each surface heating area. Place cookware with food on the cooking area before turning it on. Turn the cooking area off before removing the cookware.

Cookware handles should be turned inward and not extend over adjacent surface elements — To reduce the risk of burns, ignition of flammable materials, and spillage due to unintentional contact with the utensil, the handle of the cookware should be positioned so that it is turned inward, and does not extend over other cooking areas.

Use proper pan size - This appliance is equipped with one or more surface units of different sizes. Select cookware with flat bottoms that match the surface unit size. Using the proper cookware on the cooking area will improve efficiency.

Glazed cooking utensils— Only certain types of glass, glass/ceramic, ceramic, earthenware, or other glazed utensils are suitable for cooktop service without breaking due to the sudden change in temperature. Check the manufacturer's recommendations for cooktop use.

Improper cookware may break due to sudden changes in temperature. Check the cookware manufacturer's recommendations for cooktop use.

Never leave surface elements unattended. Boil-overs may cause smoking and greasy spills that may ignite. A pan that has boiled dry could be damaged and may damage the cooktop.

Do not use a searing grill meant for use with a broiler pan on the cooktop. The searing grill is not designed for use on the cooktop. Doing so may result in a fire.

When you are flaming foods under a ventilating hood, turn on the fan.

## IMPORTANT INSTRUCTIONS FOR GLASS AND CERAMIC COOKTOPS

Do Not Clean or Operate a Broken Cooktop. If cooktop should break, cleaning solutions and spillovers may penetrate the broken cooktop and create a risk of electric shock. Contact a qualified technician immediately.

Clean cooktop glass with caution. If a wet sponge or cloth is used to wipe spills on a hot cooking area, be careful to avoid a steam burn. Some cleaners can produce harmful fumes if applied to a hot surface.

Avoid scratching the cooktop glass with sharp objects.

# IMPORTANT SAFETY INSTRUCTIONS

Read all instructions before using this appliance.

## IMPORTANT INSTRUCTIONS FOR USING YOUR OVEN

Protective liners—Do not use aluminum foil, aftermarket oven liners, or any other materials or devices to line oven bottom, oven racks, or any other part of the appliance. Only use aluminum as recommended for baking, such as lining cookware or as a cover placed on food. Any other use of protective liners or aluminum foil may result in a risk of electric shock or fire or a short circuit.

Use care when opening oven door, lower oven door, or warmer drawer (some models). Stand to the side of the appliance when opening the door of a hot oven. Let hot air or steam escape before you remove or replace food in the oven.

Keep oven vent ducts unobstructed. Touching surfaces in this area when the oven is on may cause severe burns. Do not place plastic or heat-sensitive items on or near the oven vent. These items can melt or ignite.

Placement of oven racks - Always place oven racks in desired location while oven is cool. If rack must be moved while oven is hot, do not let potholder contact hot burner or element in oven. Use potholders and grasp the rack with both hands to reposition. Remove all cookware and utensils before moving the rack.

Do not use a broiler pan without its insert. Broiler pans and inserts allow dripping fat to drain away from the high heat of the broiler. Do not cover the broiler insert with aluminum foil; exposed fat and grease could ignite.

Do not cook food on the oven bottom. Always cook in proper cookware and always use the oven racks.

## IMPORTANT INSTRUCTIONS FOR CLEANING YOUR APPLIANCE

**CAUTION** - Before manually cleaning any part of the appliance, be sure all controls are turned off and the appliance is cool. Cleaning a hot appliance can cause burns.

Clean the appliance regularly to keep all parts free of grease that could catch fire. Do not allow grease to accumulate. Greasy deposits in the fan could catch fire.

Always follow the manufacturer's recommended directions for use of kitchen cleaners and aerosols. Be aware that excess residue from cleaners and aerosols may ignite causing damage and injury.

Clean ventilating hoods frequently - Grease should not be allowed to accumulate on hood or filter. Follow the manufacturer's instructions for cleaning vent hoods.

## IMPORTANT INSTRUCTIONS FOR SELF CLEANING OVENS

Do not clean the oven door gasket. The door gasket is essential for a good seal. Care should be taken not to rub, damage, or move the gasket.

Do not use oven cleaners. No commercial oven cleaner or oven liner protective coating of any kind should be used in or around any part of the appliance.

Use the self clean cycle to clean only the parts listed in this manual.

Before using self clean, remove the broiler pan, any food, utensils, and cookware from the oven, storage drawer or warming drawer (if equipped). Remove oven racks unless otherwise instructed.

# IMPORTANT SAFETY INSTRUCTIONS

**Read all instructions before using this appliance.**

Some birds are extremely sensitive to the fumes given off during the self clean cycle of any oven. Move birds to another well-ventilated room.

**⚠ WARNING** - California Residents: for cancer and reproductive harm information, visit [www.P65Warnings.ca.gov](http://www.P65Warnings.ca.gov)

## IMPORTANT INSTRUCTIONS FOR SERVICE AND MAINTENANCE

Do not repair or replace any part of the appliance unless specifically recommended in the manuals. All other servicing should be done only by a qualified technician. This reduces the risk of personal injury and damage to the appliance.

Always contact your dealer, distributor, service agent, or manufacturer about problems or conditions you do not understand.

Ask your dealer to recommend a qualified technician and an authorized repair service. Know how to disconnect the power to the appliance at the circuit breaker or fuse box in case of an emergency.

Remove the oven door from any unused oven if it is to be stored or discarded.



Do not touch a hot oven light bulb with a damp cloth. Doing so could cause the bulb to break. Handle halogen lights (if equipped) with paper towels or soft gloves. Disconnect the appliance or shut off the power to the appliance before removing and replacing the bulb.



# Cooking Recommendations

## Bakeware

The material of bakeware affects how evenly and quickly it transfers heat from the pan to the food.

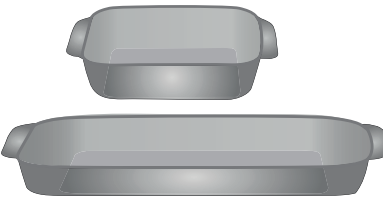
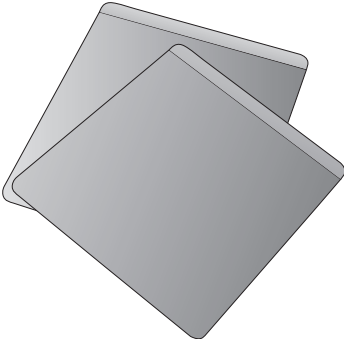
Material	Attributes	Recommendation
<p>Shiny metal bakeware</p> 	<p>Shiny, aluminum, and non-coated bakeware is the best for even heating. It is suitable for all baked goods.</p>	<p>Recommended cooking temperatures and times are based on shiny metal bakeware.</p>
<p>Dark metal bakeware</p> 	<p>Dark bakeware cooks hotter than shiny bakeware.</p>	<p>Reduce the cooking temperature by 25° F (13-14° C) when using dark bakeware.</p>
<p>Glass bakeware</p> 	<p>Glass bakeware cooks hotter than shiny bakeware.</p> <p>Glass is convenient, as the same piece of bakeware can be used for cooking, serving, and storing food.</p>	<p>Reduce the cooking temperature by 25° F (13-14° C) when using glass bakeware.</p>
<p>Insulated bakeware</p> 	<p>Insulated bakeware cooks cooler than shiny bakeware.</p> <p>Insulated bakeware is designed for baking in gas ovens.</p>	<p>Increase the cooking temperature by 25° F (13-14° C) when using insulated bakeware.</p>

## Cooking Recommendations

### Cooking Conditions

Conditions in your kitchen can affect the performance of your appliance when cooking food.

Condition	Attributes	Recommendation
Aging cookware	As pans age and become discolored, cooking times may need to be reduced slightly.	If food is too dark or overcooked, use the minimum cook time in the recipe or packaging.  If food is too light or undercooked, use the middle to maximum cook time in the recipe or packaging.
High altitude	Air is drier and air pressure is lower.  Water boils at a lower temperature, and liquids evaporate faster.  Foods may take longer to bake.  Doughs may rise faster.	Adjust cooking temperature, cooking time, or recipes as needed.  Increase amount of liquid in baking recipes. Increase cook time on cooktop. Cover dishes to reduce evaporation.  Increase bake time or oven temperature.  Reduce amount of baking soda or baking powder in recipe. Reduce rising time or punch down dough and allow it to rise twice.

### Cooking Results

Small adjustments may fix a problem with food not being as done as you like or more done than you like.

Result	Recommendation
Food too light	Use the middle to maximum cook time recommended on packaging or recipe.
Food too dark	Use the minimum cook time recommended on packaging or recipe.

### Cooking Tips

Use these additional tips to get the best results from your appliance.

Cooking	Tips
<b>Baking</b>	
Rack placement	Follow the instructions in <a href="#">“Oven Controls”</a> on starting on <a href="#">page 20</a> .  When using only one rack, place the rack so the food is in the center of the oven.
Preheat	Fully preheat the oven before baking items like cookies, cakes, biscuits and breads. Insert food immediately after the beep.
Checking food	Use the window and oven light when checking food. Opening the door may reduce baking performance.
Bake or Convection Bake	Convection bake is the best function to use for baking on multiple racks. For best performance, see <a href="#">“Convection Bake”</a> on <a href="#">page 25</a> .
Food placement	Allow at least 2 inches (5 cm) of space between bakeware for proper air circulation.

Cooking	Tips
<b>Broiling / Roasting</b>	
Broiling pan	<p>For best results when broiling, use a broil pan with a broil pan insert designed to drain the fat from the food, help avoid spatter, and reduce smoking. The broiler pan will catch grease spills, and the insert helps prevent grease splatters.</p> <p>If a broiler pan and insert are not supplied with this appliance, they may be purchased from Sears. Call 1-844-553-6667 and order broiler pan kit 5304442087.</p>
<b>Convection Cooking</b>	
Convection attributes	<p>Convection cooking uses a fan to circulate hot air around the oven and food. It browns food more evenly and reduces hot spots in the oven.</p> <p>Convection saves time when using multiple racks or cooking several food items at once.</p>
Convection bake	<p>Reduce cooking temperature by 25° F (13-14° C) from the recipe unless the recipe is written for convection baking.</p> <p>Preheat the oven for best results.</p>

# Before Setting Surface Controls

## Using Proper Cookware

The size and type of cookware used will influence the heat setting needed for best cooking results. Be sure to follow the recommendations for using proper cookware as illustrated in Figure 1 and Figure 2.

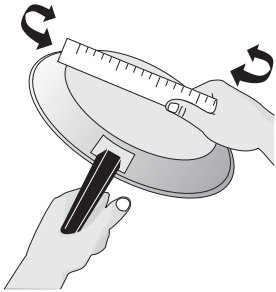

Check for flatness by rotating a ruler across the bottom of the cookware (see Figure 1). Cookware should have flat bottoms that make good contact with the entire surface heating element (see Figure 2).

Figure 1: Testing cookware

## Cookware Material Types

The cookware material determines how evenly and quickly heat is transferred from the surface element to the pan bottom. The most popular materials available are:

- **Aluminum** - Excellent heat conductor. Some types of food will cause it to darken (Anodized aluminum cookware resists staining and pitting). If aluminum pans slide across the ceramic cooktop, they may leave metal marks which will resemble scratches. Remove these marks immediately.
- **Copper** - Excellent heat conductor but discolors easily (see Aluminum).
- **Stainless** - Slow heat conductor with uneven cooking results. Is durable, easy to clean and resists staining.
- **Cast Iron** - A slow heat conductor that will retain heat very well. Cooks evenly once cooking temperature is reached. If cast iron pans slide across the ceramic cooktop, they may leave metal marks which will resemble scratches. Remove these marks immediately.
- **Porcelain-enamel on metal** - Heating characteristics will vary depending on base material. Porcelain-enamel coating must be smooth to avoid scratching ceramic cooktops.
- **Glass** - Slow heat conductor. Not recommended for ceramic cooktop surfaces because it may scratch the glass.

**Important note:** Do not place empty aluminum, glass, or porcelain-enamel coated cookware on the ceramic cooktop. The melting point of cookware made with these materials may be reached quickly, especially if left empty, and they may bond to the ceramic cooktop. If the cookware melts it will damage the cooktop. Follow all the cookware manufacturer's recommendations for use and care of cookware.

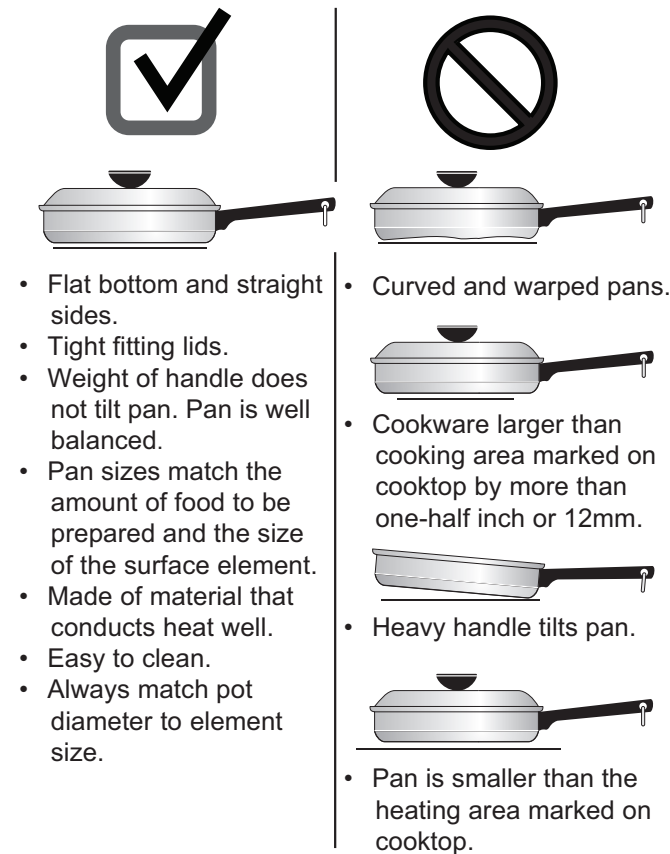

Figure 2: Proper cookware

### About the Ceramic Glass Cooktop

The ceramic glass cooktop has heating elements below a smooth glass surface. The designs on the ceramic cooktop outline the areas of the surface elements underneath. Always match the pan size with the diameter of the element outline on the cooktop. Only flat-bottomed cookware should be used.

Prior to using your cooktop for the first time, apply a ceramic cooktop cleaning cream (available in most hardware, grocery and department stores) to the ceramic surface. Clean and buff with a clean paper towel. This will make cleaning easier when soiled from cooking. Cooktop cleaning creams leave a protective finish on the glass to help prevent scratches and abrasions.

The type and size of cookware, the number of surface elements in use, and their settings will all affect the amount of heat that will spread to areas beyond the surface elements. **The areas surrounding the elements may become hot enough to cause burns.**

#### Important notes:

- The cooktop should not be used as a cutting board or work surface.
- Dropping heavy or hard objects on the cooktop may crack it.
- Placing food directly on the smoothtop surface (without a cooking utensil) is not recommended, as difficult cleaning will result, and foods may smoke and cause potential fire hazard.
- Always lift cookware before moving on the ceramic glass cooktop. Any cookware that has a rough or dirty bottom can scratch the ceramic cooktop. Always start with clean cookware.

**Important note:** White glass cooktops only - Due to the high intensity of heat generated by the surface elements, the glass surface may discolor when the element is turned off. This is normal and the glass will return to its original white color after it has completely cooled down.

### About the Radiant Surface Elements

The element temperature rises gradually and evenly. As the temperature rises, the element will glow red. To maintain the selected setting the element will cycle on and off. The heating element retains enough heat to provide a uniform and consistent heat during the off cycle.

For efficient cooking, turn the element off several minutes before cooking is complete. This will allow residual heat to complete the cooking process.

**CAUTION** - Surface elements may appear to have cooled after they have been turned off. **The element surface may still be hot**, and burns may occur if the element or surrounding area is touched before it has cooled to a safe temperature.

**CAUTION** - **Do not** place flammable items such as plastic salt and pepper shakers, spoon holders, or plastic wrapping on top of the range when it is in use. These items could melt or ignite. Potholders, towels, or wooden spoons could catch fire if placed too close to the surface elements.

**CAUTION** - **Do not** allow aluminum foil, or any material that can melt, to make contact with the ceramic glass cooktop. If these items melt on the cooktop, they will damage the ceramic cooktop.

#### Important notes:

- Radiant elements have a limiter that allows the element to cycle on and off, even at the HI setting. This helps to prevent damage to the ceramic smooth top. Cycling at the HI setting is normal and can occur if the cookware is too small for the radiant element or if the cookware bottom is not flat.
- Be sure to read detailed instructions for ceramic glass cooktop cleaning in the [“Care & Cleaning”](#) section and [“Before You Call”](#) checklist section of this *Use and Care Guide*.

## Before Setting Surface Controls

### Element On and Hot Surface Indicator Lights

The ELEMENT ON indicator light will turn on when one or more elements are turned on.

A quick glance at this indicator light when cooking is finished is an easy check to be sure all surface elements are turned off.

The HOT SURFACE indicator light will turn on when the burner is hot enough to cause burns and will remain on after the burner is turned off until the surface has cooled to a safe temperature.



Figure 3: Element indicator light

### Types of ceramic cooktop elements

The circles on the ceramic glass cooktop outline the size and type of element underneath. The elements on your cooktop depend on the model.

- A single radiant element has one circle.
- A dual radiant element (some models) has two circles. The dual radiant element may be set using only the smaller inner element or both inner and outer elements may be set to heat together for a larger surface.
- A triple radiant element (some models) has three circles. The element may be set using only the inner element, the inner and middle elements, or all three elements together.
- Dual and triple elements allow more flexibility with the size of cookware.

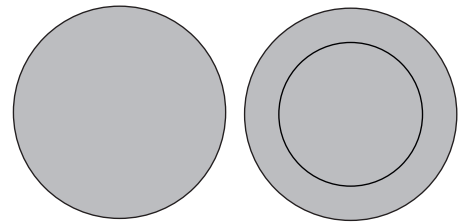

Figure 4: Single and double elements

- A keep warm element (some models) has one small circle. It is used to keep food warm after cooking. The keep warm element is not designed to cook food.

# Setting Surface Controls

## Single radiant surface elements (all models)

To operate the single radiant element:

1. Place correctly sized cookware on surface element.
2. Push in and turn the surface control knob in either direction (Figure 1) to the desired setting (refer to the “Suggested radiant surface element settings” in Table 1).
3. When cooking is complete, turn the radiant surface element OFF before removing the cookware.

Start most cooking operations on a higher setting and then turn to a lower setting to finish cooking. The surface control knobs do not have to be set exactly on a particular spot. Use the graphics provided as a guide and adjust the control knob as needed (see Figure 1).

A glowing red surface heating area extending beyond the bottom edge of the cookware indicates the cookware is too small for the surface heating area.

## Suggested radiant surface element settings

The suggested settings found in Table 1 below are based on cooking with medium-weight aluminum pans with lids. Settings may vary when using other types of pans.

Settings	Type of Cooktop
High (HI - 9)	Start most foods, bring water to a boil, pan broiling
Medium High (7 - 8)	Continue a rapid boil, fry, deep fat fry
Medium (5 - 6)	Maintain a slow boil, thicken sauces and gravies or steam vegetables
Medium Low (2 - 4)	Keep foods cooking, poach, stew
Low (1)	Low temperature cooking
Low (LO)	Keep warm, melt

**Table 1: Suggested radiant surface element settings**

**Important note:** Do not allow aluminum foil or ANY material that can melt to make contact with the ceramic glass cooktop. If these items melt on the cooktop, they will damage the ceramic cooktop.

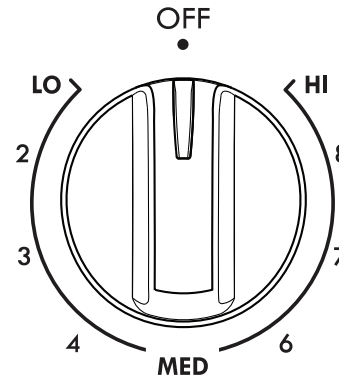

**Figure 1: Single element knob**

**CAUTION** - Radiant surface elements may appear to have cooled after they have been turned off. **The glass surface may still be hot** and burns may occur if the glass surface is touched before it has cooled sufficiently.

**CAUTION** - Do not place flammable items such as plastic salt and pepper shakers, spoon holders, or plastic wrappings on top of the range when it is in use. These items could melt or ignite. Potholders, towels, or wooden spoons could catch fire if placed too close to the surface elements.

## Important notes:

- The size and type of utensil used, and the amount and type of food being cooked will influence the setting needed for best cooking results.
- The Element ON indicator lights will turn on when one or more elements are turned ON. A quick glance at these indicator lights when finished cooking is an easy check to be sure all control knobs are turned OFF. The Hot Surface indicator light will remain on AFTER the control knob is turned to the “OFF” position and will stay on until the heating surface area has cooled sufficiently.

## Setting Surface Controls

### Dual radiant surface elements (some models)

Symbols on the backguard will help choose which portion of the dual radiant element to set. You may switch the element setting at any time during cooking.

#### To operate a dual radiant element:

1. Place correctly sized cookware on the surface element.
2. Push in and turn the surface control knob clockwise to begin heating both the inner and outer elements. If only the inner element is needed for smaller cookware, push in and turn the knob counter-clockwise (see [Figure 2](#)).
3. When cooking is complete, turn the knob to OFF before removing the cookware.

Start most cooking operations on a higher setting and then turn to a lower setting to finish cooking. The surface control knobs do not have to be set exactly on a particular mark. Use the marks as a guide and adjust the control knob as needed.

A glowing red surface heating area extending beyond the bottom edge of the cookware indicates the cookware is too small for the surface heating area.

You may switch from either single or dual element setting at any time during cooking. See [“Suggested radiant surface element settings”](#) on [page 15](#).

**CAUTION** - Radiant surface elements may appear to have cooled after they have been turned off. **The glass surface may still be hot** and burns may occur if the glass surface is touched before it has cooled sufficiently.

**CAUTION** - **Do not** place flammable items such as plastic salt and pepper shakers, spoon holders or plastic wrappings on top of the range when it is in use. These items could melt or ignite. Potholders, towels or wooden spoons could catch fire if placed too close to the surface elements.

**Important note:** Do not allow aluminum foil or ANY material that can melt to make contact with the ceramic glass cooktop. If these items melt on the cooktop, they will damage the ceramic cooktop.

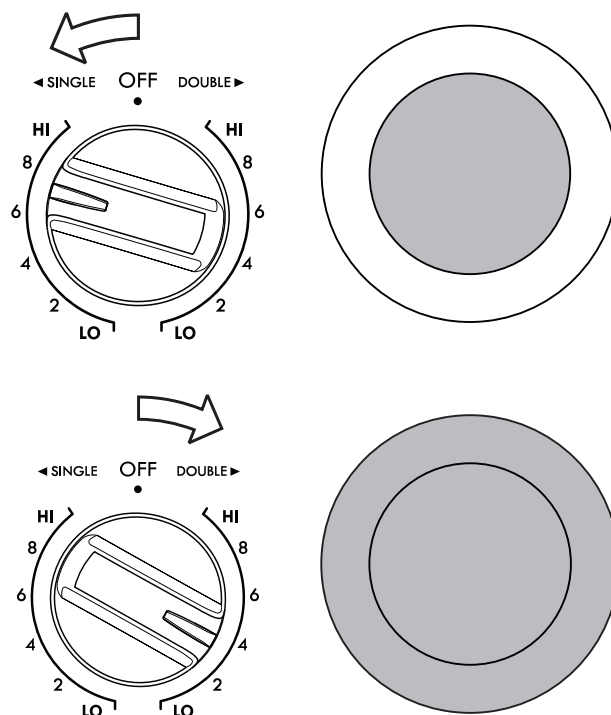

Figure 2: Dual element knob settings

#### Important notes:

- The size and type of utensil used and the amount and type of food being cooked will influence the setting needed for best cooking results.
- The Element ON indicator lights will turn on when one or more elements are turned ON. A quick glance at these indicator lights when finished cooking is an easy check to be sure all control knobs are turned OFF. The Hot Surface indicator light will remain on AFTER the control knob is turned to the “OFF” position and will stay on until the heating surface area has cooled sufficiently.

**CAUTION** - Radiant surface elements may appear to have cooled after they have been turned off. **The glass surface may still be hot** and burns may occur if the glass surface is touched before it has cooled sufficiently.

**CAUTION** - **Do not** place flammable items such as plastic salt and pepper shakers, spoon holders, or plastic wrappings on top of the range when it is in use. These items could melt or ignite. Potholders, towels, or wooden spoons could catch fire if placed too close to the surface elements.



**Important note:** Do not allow aluminum foil or ANY material that can melt to make contact with the ceramic glass cooktop. If these items melt on the cooktop, they will damage the ceramic cooktop.

**Important note:** The bridge element knob controls one element and the bridge element. It does not control the adjacent single element. The adjacent element must be adjusted with its own knob. See [“Suggested radiant surface element settings”](#) on page 15.

#### Important notes:

- NEVER place or straddle a cooking utensil over two different surface cooking areas at the same time unless the cooktop has a bridge element and the cookware is specifically designed for the purpose. Incorrect use may cause the ceramic cooktop to fracture.
- Do not allow aluminum foil or ANY material that can melt to make contact with the ceramic glass cooktop. If these items melt on the cooktop, they will damage the ceramic cooktop.

**CAUTION** - The griddle should be placed carefully over the bridge elements. When the bridge control is activated along with the rear single element, they combine to heat the whole surface of the griddle.

**CAUTION** - **The griddle will be very hot.** Always use oven mitts when handling the griddle during and after cooking. The griddle may appear to have cooled, but the residual heat can cause burns. Allow the griddle to cool for several minutes after the bridge has been turned off. Do not allow aluminum foil or ANY material that can melt to make contact with the ceramic glass cooktop. If these items melt on the cooktop, they will damage the ceramic cooktop.

**CAUTION** - Radiant surface elements may appear to have cooled after they have been turned off. **The glass surface may still be hot** and burns may occur if the glass surface is touched before it has cooled sufficiently.

**CAUTION** - **Do not** place flammable items such as plastic salt and pepper shakers, spoon holders, or plastic wrappings on top of the range when it is in use. These items could melt or ignite. Potholders, towels, or wooden spoons could catch fire if placed too close to the surface elements.

#### Keep warm (some models)

Use the keep warm feature to keep cooked foods hot.

**Always start with hot food.** It is not recommended to heat cold food on the keep warm zone. All food placed on the warming zone should be covered with a lid to maintain quality.

For best results, when warming pastries or breads, the cover should have an opening to allow moisture to escape. **Do not use plastic wrap to cover food. Plastic may melt onto the surface and be very difficult to clean.** Use only dishware, utensils, and cookware recommended for oven and cooktop use on the keep warm zone.

#### Setting the keep warm control:

1. Press **Keep Warm** on the control panel.
2. When ready to serve, press **Keep Warm** again to turn the warmer off. The hot surface indicator light will remain on until the warm zone cools.

**CAUTION** - Unlike the surface elements, the keep warm zone will not glow red when it is hot. To avoid burns always use potholders or oven mitts when removing food from the cooktop, including the keep warm zone, as cookware and plates will be hot.

**CAUTION** - Radiant surface elements may appear to have cooled after they have been turned off. **The glass surface may still be hot** and burns may occur if the glass surface is touched before it has cooled sufficiently.

**CAUTION** - **Do not** place flammable items such as plastic salt and pepper shakers, spoon holders, or plastic wrappings on the cooktop when it is in use. These items could melt or ignite. Potholders, towels, or wooden spoons could catch fire if placed too close to the surface elements.

**Important note:** Do not allow aluminum foil or ANY material that can melt to make contact with the ceramic glass cooktop. If these items melt on the cooktop, they will damage the ceramic cooktop.

## Setting Surface Controls

### Home Canning

Be sure to read and observe all the following points when home canning with your appliance. Check with the USDA (United States Department of Agriculture) Web site and be sure to read all the information they have available as well as follow their recommendations for home canning procedures.

- Use only a completely flat bottom canner with no ridges that radiate from the bottom center when home canning. Heat is spread more evenly when the bottom surface is flat. Use a straight-edge to check canner bottom.
- Make sure the diameter of the canner does not exceed 1 inch beyond the surface element markings or burner.
- It is recommended to use smaller diameter canners on electric coil and ceramic glass cooktops and to center canners on the burner grates.
- Start with hot tap water to bring water to boil more quickly.
- Use the highest heat setting when first bringing the water to a boil. Once boiling is achieved, reduce heat to lowest possible setting to maintain that boil.
- Use tested recipes and follow instructions carefully. Check with your local Cooperative Agricultural Extension Service or a manufacturer of glass jars for the latest canning information.
- It is best to can small amounts and light loads.
- Do not leave water bath or pressure canners on high heat for an extended amount of time.

# Before Using Oven

## Oven Vent Location

The oven is vented as shown below. When the oven is on, warm air is released through the vent. This venting is necessary for proper air circulation in the oven and good baking results. Do not block oven vent. Never close off the openings with aluminium foil or any other material. Steam or moisture may appear near the oven vent. This is normal.

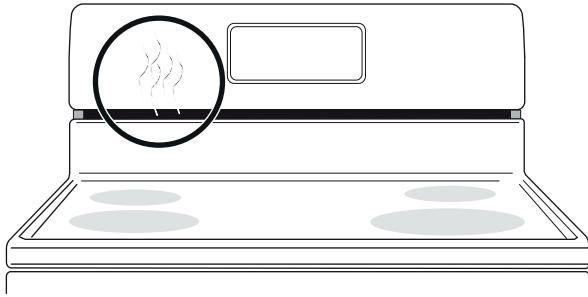

Figure 1: Oven vent

**⚠ WARNING** -Protective Liners — **Do not** use aluminum foil or any other material or liners to line the oven bottom, walls, racks or any other part of the range. Doing so will alter the heat distribution, produce poor baking results, and possibly cause permanent damage to the oven interior. Improper installation of these liners may result in risk of electric shock or fire. During self clean, temperatures in the oven will be hot enough to melt foil.

**⚠ CAUTION** - Always use pot holders or oven mitts when using the oven. When cooking, the oven interior, oven exterior, oven racks, and cooktop will become very hot which can cause burns.

- Remove all oven racks before starting a self clean cycle. If oven racks are left inside the oven during a cleaning cycle, the slide ability of the oven racks may be damaged and all of the oven racks will lose their shiny finish.

**⚠ CAUTION** - To prevent possible damage to the oven, do not attempt to close the oven door until all the oven racks are fully positioned back inside the oven cavity

## Types of oven racks

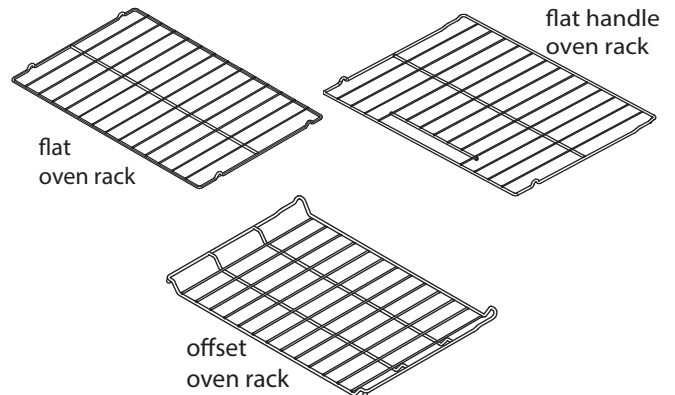

Figure 2: Oven rack types

- **Flat oven racks** may be used for most cooking needs and may be placed in most oven rack positions.
- The **offset oven rack** (some models) provides additional step down positions from the standard flat rack design. The offset design positions the base of the rack about  $\frac{1}{2}$  of a rack position lower than the flat rack and may be used in most oven rack positions. To maximize oven cooking space, place the bottom oven rack in the lowest rack position for baking or roasting large cuts of meat.

## Removing, replacing, and arranging flat or offset oven racks

Always arrange the oven racks when the oven is cool.

**To remove** - Pull the oven rack straight forward until it reaches the stop position. Lift up front of oven rack slightly and slide out.

**To replace** - Place the oven rack on the rack guides on both sides of oven walls. Tilt the front of oven rack upward slightly and slide the oven rack back into place. Be sure oven racks are level before using.

## Oven Controls

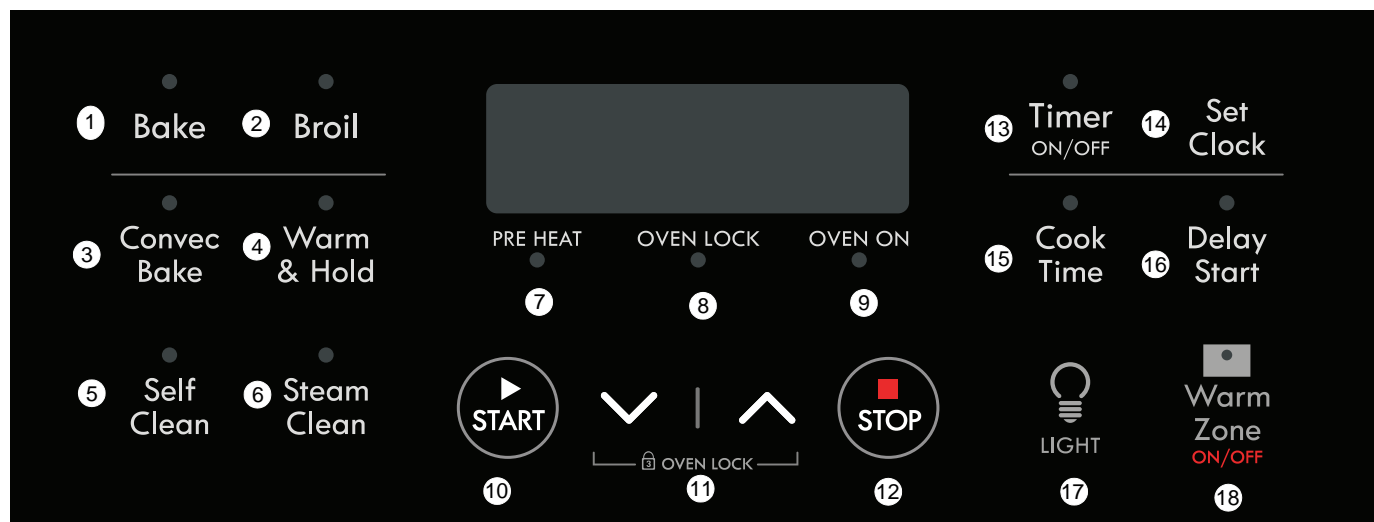

1. **Bake** - Selects Bake function.
2. **Broil** - Selects Broil function.
3. **Convec Bake** - Use to set convection feature.
4. **Warm & Hold** - Use to keep cooked food warm and at serving temperature for up to 3 hours.
5. **Self Clean** - Use to select 2, 3, or 4hr Self-Clean cycle.
6. **Steam Clean** - Use to select Steam Clean cycle.
7. **PREHEAT indicator light** - Is on when oven is preheating. Stays on until the oven reaches the desired temperature.
8. **OVEN LOCK indicator light** - Is on when door locks or unlocks and when oven lockout is active.
9. **OVEN ON indicator light** - Glows each time the oven cycles on to maintain the set oven temperature.
10. **START** - Use to start all cooking functions.
11. **Up / Down arrows** - Use with the function keys to accept settings and adjust temperature and times.
12. **STOP** - Cancels any active oven function except clock and timer.
13. **Timer ON/Off** - Use to set and cancel the timer and to set the Continuous Bake feature.
14. **Set Clock** - Use with arrow keys to set time of day.
15. **Cook Time** - Use to set a specific amount of time needed for cooking. Automatically cancels cooking process at end of set time.
16. **Delay Start** - Use with Bake and Self Clean functions to program a delayed start bake or delayed start self clean cycle.
17. **LIGHT** - Use to turn internal oven light on and off.
18. **Warm Zone** - Use to turn the surface Warm Zone on and off.

### Minimum and Maximum Control Settings

All of the features listed have minimum and maximum time and temperature settings that may be entered into the control. An entry acceptance beep will sound each time a key is touched (the Oven Lockout tone is delayed by 3 seconds). An entry error tone (three short beeps) will sound if the entry of the temperature or time is below the minimum or above the maximum settings for the feature.



**Table 1: Minimum and maximum control settings**

Feature	Min. Temp or Time	Max. Temp or Time
Bake	170°F (77°C)	550°F (288°C)
Broil	LO	Hi
Timer	1 minute	11 hrs. 59 mins.
Self Clean	2 Hours	4 Hours
Warm & Hold	170°F (77°C)	3 Hours
Cook Time	1 Minute	11:59
Delay Time 12 Hr.	1:00	12:59
Delay Time 24 Hr.	0:00	23:59
Clock 12 Hr.	1:00	12:59
Clock 24 Hr.	0:00	23:59

## Setting Clock

When the appliance is first powered up or when the power supply to the appliance has been interrupted, **12:00** will flash in the display. The time of day must first be set before operating the oven.

### To set the clock

1. Press **CLOCK** once. **CLO** appears in display.
2. Press  or  and the time appears in the display. Continue to hold arrow key until the correct time of day appears in the display.
3. Press **START** to accept time of day.



### Important note:

The time of day cannot be changed when the oven is set for cooking.



## Oven Lock

The Oven Lock feature allows you to lock the oven portion of the appliance while the oven is not in use.

### To activate Oven Lock feature:

1. Be sure the door is completely closed.
2. Press and hold  and  together for 3 seconds. **Loc** will appear in the display. The OVEN LOCK indicator light will flash while the motor driven door latch begins locking the oven door. Do not open the door during this time. Allow 15 seconds for the door to completely lock. Once oven door is locked, the time of day will appear in the display.

### To cancel the Oven Lock feature:



1. Press and hold  and  together for 3 seconds. The OVEN LOCK indicator light will flash and the motor driven door latch will begin to unlock. Do not open the door at this time. The door will unlock completely in about 15 seconds.
2. The oven control keys will be available, and the oven door can be opened again.

### Important notes:

- To avoid possible damage to the oven door latch mechanism, do not attempt to open or close the oven door whenever the OVEN LOCK indicator light is flashing.
- If a control key is pressed when the OVEN LOCK is active, **Loc** will appear in the display as a reminder that the oven keys are inactive when the OVEN LOCK feature is active.

## Silent or audible control mode



The appliance may be set for silent or audible operation. If the silent mode is selected, most of the sounds associated with setting the controls will be silent. But, sounds will be heard when the timer ends, when a baking function ends, and when the set preheat temperature is reached.

1. Press and hold **Delay Start** until the control beeps once (about 3 seconds). The present mode appears as OFF (silent operation) or ON (for audible operation).
2. Use  or  to toggle between audible or silent modes. To save, press **START** when the desired mode of operation appears in the display.

## Changing Temperature Display to Fahrenheit (°F) or Celsius (°C)

The electronic oven control is set to display °F when shipped from the factory. The display may be changed to show either °F or °C oven temperatures.

### To change temperature display mode from °F to °C or from °C to °F:

1. Press **Broil**. **HI** appears in the display.
2. Press and hold **Broil** until **F** or **C** appears in the display.
3. Press either  or  to toggle between **F** or **C** mode choices.
4. Press **START** to accept change. The display will return to the time of day.

### Important note:

The temperature display mode cannot be changed when the oven is set for cooking.

## Operating Oven Light

The oven light will automatically turn on when the oven door is opened.

Press **LIGHT** to turn the oven light on or off whenever the oven door is closed. The oven light will not operate during the self clean operation.

The oven light is located at the upper left rear wall of the oven interior and is covered with a glass shield held in place by a wire holder. The glass shield protects the bulb from high temperatures and should always be in place when the oven is in use.



To replace the interior oven light, see [“Replacing the Oven Light”](#) on page 36.

## Oven Controls

### Changing between continuous bake setting or 12-hour energy saving feature

The oven control has a factory-preset 12-hour energy saving feature that will turn the oven off automatically if the oven is left on for more than 12 hours. The control may be programmed to override this feature to continuously bake.

#### To change to continuous bake mode:



Press and hold **Timer ON/OFF** until the control beeps once (about 6 seconds). “- - hr” will appear in display. The control is set for continuous bake. Press  and  to toggle between continuous bake and 12hr energy saving. **12 Hr** will appear in display for energy saving mode.



To save the selected mode, press **START**. The display will return to idle.

### Setting Timer

The timer may be set from 1 minute to 11 hours and 59 minutes.

#### To set the timer:

1. Press **Timer ON/OFF**.
2. Press and hold  to increase the time. Release  when the desired time appears in the display.
3. Press **START**, and the timer will begin to count down.
4. When the set time has run out, the timer will sound with three beeps and will continue to beep three times every 60 seconds until **Timer ON/OFF** is pressed.

To change time remaining in timer, press and hold  or  to increase or decrease any time remaining.

To cancel the timer before at any time, press **Timer ON/Off** once.

#### Important notes:





- The timer does not start or stop the cooking process. It serves as an extra timer in the kitchen that will beep when the set time has run out. The timer may be used alone or when any other oven function is active.
- The indicator light located above **Timer ON/OFF** will glow when the timer is active.
- The timer will display hours and minutes until 1 hour remains. When less than 1 hour remains, the display will count down in minutes and seconds. Once the timer has less than 1 minute remaining, only seconds will display.
- If the timer is active when oven cooking, the minute timer will show in the display by default. To view information of any other active oven function, press the key once for the active function to view status.

### Setting Bake

Use the bake function whenever the recipe calls for baking using normal temperatures. A reminder tone will sound when the set bake temperature is reached. Bake may be programmed for any temperature from 170°F to 550°F (77°C to 288°C). The factory preset bake temperature is 350°F (177°C).



**CAUTION** Always use pot holders or oven mitts when using the oven. When cooking the oven interior, oven racks and cook-top will become very hot which can cause burns.

#### To set Bake

1. Arrange oven racks and close oven door.
2. Press **Bake**. **350°** appears in display.
3. Within 15 seconds, press  or . The display will show the default oven temperature of **350°F (177°C)**. By pressing  or , the oven temperature may be adjusted in 5°F increments (1°C).
4. Press **START** when the desired temperature appears. The oven will begin heating to the selected temperature. When the oven temperature reaches the set temperature, the PRE-HEAT indicator light will turn off, and the oven control will beep three times.

To cancel bake at anytime, Press .

#### To change the oven temperature after Bake has started:

1. Press **Bake**. The current set oven temperature will display.
2. Press  or  to increase or decrease the current set temperature to the new oven temperature.

#### Important notes:

- The oven will bake no longer than 12 hours. If you wish to bake for a longer period, see [“Changing between continuous bake setting or 12-hour energy saving feature”](#) on [page 22](#) mode for detailed information.

### Baking tips

- Fully preheat the oven before cooking items like cookies, biscuits, and breads.
- When using any single rack, position the rack so that the food is in the center of the oven.
- For best results when baking cakes or cookies using two oven racks, place racks in positions 3 and 6 (See Figure 2).
- Dark or dull bakeware absorbs more heat than shiny bakeware. It may be necessary to reduce oven temperature and cook time to prevent overbrowning of some foods. Dark bakeware is recommended for pies. Shiny bakeware is recommended for cakes, cookies, and muffins.
- For best results when baking cakes or cookies using two oven racks, place pans as shown in Figure 1.

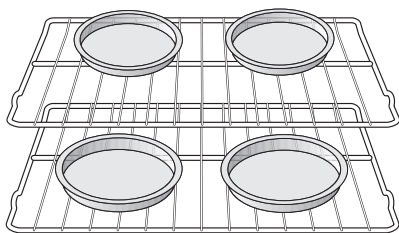

Figure 1: Baking on multiple levels

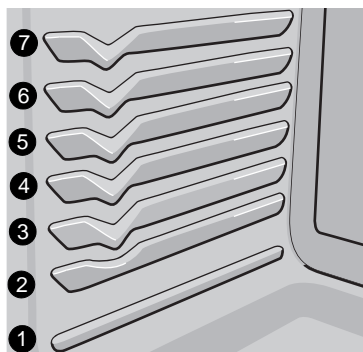









Figure 2: Oven rack positions

### Setting Cook Time

Use Cook Time to set the amount of time needed for baking. The oven will turn on immediately and stop automatically after the set cook time ends.



**⚠ WARNING** Food Poisoning Hazard. Do not let food sit for more than one hour before or after cooking. Doing so can result in food poisoning or sickness. Foods that can easily spoil such as milk, eggs, fish, meat, or poultry should be chilled in the refrigerator first. Even when chilled, they should not stand in the oven for more than 1 hour before cooking begins and should be removed promptly when finished cooking.

#### To program the oven to begin baking immediately and to shut off automatically:

1. Be sure that the clock displays the correct time of day. Arrange oven racks and close oven door.
2. Press **Bake**. **350°** appears in display.
3. Within 15 seconds, press  or . The display will show the default oven temperature of **350°F (177°C)**. By pressing  or , the temperature may be adjusted in 5°F increments (1°C). Press **START** to accept.
4. Press **Cook Time**. **00** will appear in display.
5. Press  or  to reach the desired cook time.
6. Press **START** to accept. When the oven temperature reaches the set temperature, the PRE HEAT indicator light turns off and the oven control will beep once.
7. To cancel at anytime, press .

When the cook time runs out, **End** will appear in the display. The oven control will beep three times every minute as a reminder until **STOP** is pressed.

#### To change the oven temperature or cook time after baking has started:

1. Press **Bake** (for oven temperature) or **Cook Time**.
2. To adjust temperature or cook time, press  or  and release when the desired temperature or cook time setting appears in the display.

#### Important notes:

- Cook Time and Delay Start may be set with Bake but are not available for use with Broil.
- While baking with Cook Time, press **Cook Time** to display any cook time remaining.
- Cook Time and Delay Start can be set with Bake or Convection (on some models).
- The maximum Cook Time or Delay Start setting is 11 hours and 59 minutes.

## Oven Controls









### Setting Delay Start

Delay Start allows you to set a delayed starting time to the oven baking or cleaning functions.

**⚠ WARNING** Food Poisoning Hazard. Do not let food sit for more than one hour before or after cooking. Doing so can result in food poisoning or sickness. Foods that can easily spoil such as milk, eggs, fish, meat, or poultry should be chilled in the refrigerator first. Even when chilled, they should not stand in the oven for more than 1 hour before cooking begins and should be removed promptly when finished cooking.



**⚠ CAUTION** Always use pot holders or oven mitts when using the oven. When cooking the oven interior, oven racks and cook-top will become very hot which can cause burn

**To program oven for a delayed starting time and to shut off automatically:**

1. Be sure that the clock displays the correct time of day.
2. Arrange oven racks and close oven door.
3. Press **Bake**. **350°** appears in display.
4. Within 15 seconds, press  or . The display will show the default oven temperature of **350°F (177°C)**. By pressing  or , the oven temperature may be adjusted in 5°F increments (1°C). When desired temperature is reached press **START** to accept.
5. Press **Cook Time**. **00** will appear in display.
6. Press the  or  to set the desired cook time. Then press **START** to accept.
7. Press **Delay Start**. The time of day will appear in the display. Press  or  until the desired starting time appears in the display and press **START**.
8. The oven will turn on at the set delayed starting time and begin heating. When the oven temperature reaches the set temperature, the PRE HEAT indicator light will turn off and the oven control will beep three times.

To cancel at anytime, press .

**To change the oven temperature or cook time after baking has started:**

1. Press **Bake** (for oven temperature) or **Cook Time**.
2. Press  or  and release when the desired temperature or cook time setting appears in the display.

When the cook time runs out, **End** will appear in the display.

The oven control will beep three times every minute until  is pressed.



## Convection Bake

Benefits of convection cooking include:

- Foods cook up to 25 to 30% faster, saving time and energy.
- Multiple rack baking.
- No special pans or bakeware needed.



Convection functions use a fan to circulate the oven's heat uniformly and continuously around the oven. This improved heat distribution allows for fast, even cooking and browning results. It also gives better baking results when using two oven racks at the same time.

Heated air flows around the food from all sides, sealing in juices and flavors. Breads and pastry brown more evenly.

Most foods baked in a standard pan will cook faster and more evenly with the convection feature.

Convec Bake may be set for any oven temperature between 170°F (77°C) and 550°F (288°C).

### To set Convec. Bake with a default oven set temperature of 350°F:

1. Arrange oven racks and close oven door.
2. Press **Convec Bake. 350** will appear in the display.
3. By pressing  or , the oven temperature may be adjusted in 5°F increments (1°C). When setting for convection, be sure to set the oven temperature between 300°F (149°C) and 550°F (288°C).

To cancel Convec Bake at any time, press .

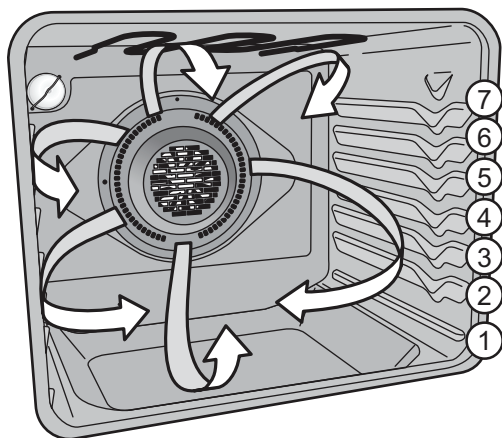

Figure 3: Air movement using convection

### Important notes:

- The convection fan will begin rotating once Convec Bake has been activated.
- If the oven door is opened when Convec Bake is active, the convection fan will stop rotating until the oven door is closed.
- When using Convec Bake, cook time reductions may vary depending on the amount and type of food being cooked.

### Suggestions for Convec Bake:

- For optimum cooking results, it is recommended to preheat the oven when baking foods such as cookies, biscuits, and breads.
- Reduce oven temperature 25°F from recipe's recommended oven temperature. Follow the remainder of the recipe's instructions using the minimum recommended cook time.
- For best results when using a single oven rack, place rack in position 4 or 5 (See [Figure 3](#)). When using two oven racks, place in positions 3 and 6. When using three oven racks, place in positions 2, 4, and 6 (use offset rack only in position 7).
- Dark or dull pans absorb more heat than shiny bakeware resulting in dark or overbrowning of foods. It may be necessary to reduce the oven temperature or cook time to prevent overbrowning of some foods. Dark pans are recommended for pies. Shiny pans are recommended for cakes, cookies, and muffins.
- When using any single rack, position the rack so that the food is in the center of the oven.
- For best results when baking cakes or cookies using two oven racks, place pans as shown in [Figure 4](#).

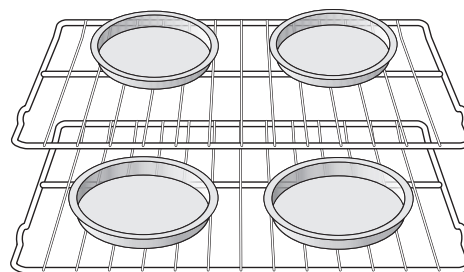

Figure 4: Baking on multiple levels

## Oven Controls

### Setting Broil

Use the broil function to cook meats that require direct exposure to flame heat for optimum browning results. The Broil function is factory preset to broil, shown as **Hi**. The suggested broil settings are recommendations only. Increase or decrease broiling times or move to a different rack position to suit for doneness.

#### To set Broil:

1. Arrange the oven racks when cool. For optimum browning results, preheat oven for 2 minutes before adding food.
2. Position cookware in oven. Leave door open at broil stop position.

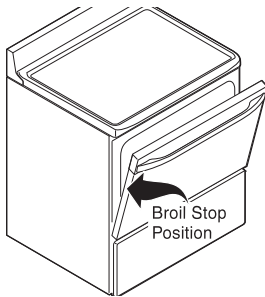

Figure 5: Door open for broiling





3. Press **Broil**. **HI** will appear in display.
4. Press  or  until the desired broil setting level appears in the display. Press  for HI broil or  for LO broil setting.
5. Press **START**. Broil on one side until food is browned. Turn and broil food on other side. When finished broiling, press **STOP**.

Table 2: Suggested Broil Settings<sup>1</sup>

Food	Rack Position	Setting	Cook time in minutes		DonenessYou
			1st side	2nd side	
Steak, 1 inch thick	6th*	Hi	6	6	Rare
Steak, 1 inch thick	6th or 7th*	Hi	8	6	Medium
Steak, 1 inch thick	5th or 6th*	Hi	10	8	Medium-well
Steak, 1 inch thick	5th or 6th*	Hi	11	10	Well
Pork Chops, 3/4 inch thick	5th	Hi	12	8	Well
Chicken, bone-in	5th	Lo	25	15	Well
Chicken, boneless	5th	Lo	10	8	Well
Fish	5th	Hi	as directed		Well
Shrimp	4th	Hi	as directed		Well
Hamburger, 1 inch	5th or 6th	Hi	12	10	Medium

<sup>1</sup>For steaks, cook times are suggestions and should only be used as a guide. The USDA states, "Rare fresh beef is popular, but you should know that cooking it to only 140° means some food poisoning organisms may survive." (Source; Safe Food Book, Your Kitchen Guide USDA) The lowest temperature recommended by the USDA is 145° for medium rare fresh beef. For well done 170°.

**CAUTION** Always use pot holders or oven mitts when using the oven. When cooking, the oven interior, oven racks, and cook-top will become very hot which can cause burns.

**WARNING** Should an oven fire occur, close the oven door and turn the oven off. If the fire continues, use a fire extinguisher. Do not put water or flour on fire. Flour may be explosive.

#### Important notes:

- Always arrange oven racks when the oven is cool.
- For best results when broiling, use a broil pan with broil pan insert designed to drain the fat from the food and help avoid spatter and reduce smoking. To purchase them, call Sears at 1-844-553-6667 and order broil pan kit 5304442087.
- When broiling, always pull the oven rack out to the stop position before turning or removing food.

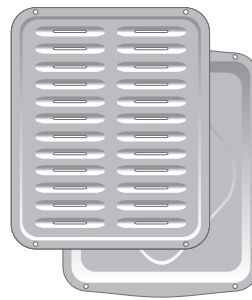

Figure 6: Broiler pan and insert

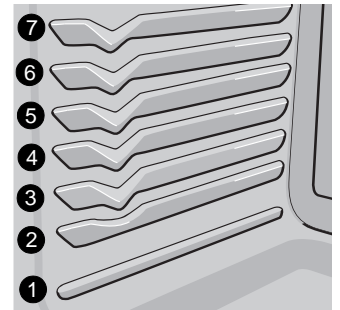



Figure 7: Rack positions

## Warm & Hold™





Warm & Hold will keep cooked foods warm and ready for serving for up to 3 hours after cooking has finished. After 3 hours, Warm & Hold will shut off automatically. Warm & Hold should only be used with foods that are already at serving temperatures. Warm & Hold will maintain the oven temperature at 170°F (77°C).

### To set Warm & Hold:

1. If needed, arrange oven racks and place cooked food in oven.
2. Press **Warm & Hold**. **Hld** will appear in the display. If no other keys are touched within 25 seconds, the request for Warm & Hold will clear.
3. Press **START**.
4. Warm & Hold will automatically turn off after 3 hours.

To turn Warm & Hold off at any time, press .

### To set Warm & Hold to start after a Timed Bake automatically:



1. Press **Bake**. Press  or  to set temperature.
2. Press **START**.
3. Press **Cook Time**. Press  or  to set time.
4. Press **START**.
5. Press **Warm & Hold**.
6. Press **START**. Warm & Hold is set to turn on automatically after the Timed Bake or Delay Timed Bake has finished. The Warm & Hold indicator light will glow indicating that the Warm & Hold feature is set to start when the timed bake is finished.

## Adjusting oven temperature



The appliance has been factory calibrated and tested to ensure an accurate baking temperature, known as the User Preference Offset (UPO). For the first few uses, follow your recipe times and temperature recommendations carefully. If you think the oven is cooking too hot or too cool for your recipe times, you may adjust the control so the oven cooks hotter or cooler than the oven temperature displayed.

The oven temperature may be increased as much as +35°F (+19°C) or decreased -35°F (-19°C) from the factory calibrated settings.

### To adjust oven temperature:

1. Press **Bake** and hold for 3 seconds. The UPO value will appear in the display with a degree sign.
2. The display now indicates the amount of degrees offset from the original factory temperature setting. If the control still has the original factory calibration, the display will read **0**.
3. The temperature may be adjusted up or down 35°F (19°C), in 1°F increments by pressing and holding  or . Adjust until the desired amount of temperature offset appears in the display and press **START** to save.
4. If the **STOP** key is pressed during the programming mode, the UPO value will remain unchanged.

### Important notes:

- Oven temperature adjustments made will not change the Broil or Self-Clean operating temperatures.
- Do not use oven thermometers such as those found in grocery stores to check the temperature settings inside your oven. These oven thermometers may vary as much as 20°F to 40°F degrees from actual temperatures.
- The oven temperature adjustment may be made if your oven control has been set to display °C temperatures. Minimum and maximum settings for °C is plus (+) or minus (-) 19°C.
- If the display mode is set for °C, adjustments made will be in 1°C increments on each press of  or .

## Self Clean

A self cleaning oven cleans itself with high temperatures (well above normal cooking temperatures), which eliminate soils completely or reduces them to a fine powdered ash you can wipe away afterwards with a damp cloth.

The Self Clean function allows you to select three different cleaning times from 2, 3, or 4 hours. A 3-hour cleaning time is best used for normal cleaning; 2-hour time for light soils, and a 4-hour clean time for heavier stubborn soils.

**Read before starting Self Clean.** Be sure to read all following caution and important statements before starting a self clean cycle.

**⚠ CAUTION** Do not leave small children unattended near appliance. During self clean cycle, the outside of the oven can become very hot and cause burns if touched.

**⚠ CAUTION** Do not line the oven walls, racks, oven bottom, or any part of the range with aluminum foil. This will cause permanent damage to the oven interior and destroy heat distribution, and will melt to the oven interior.

**⚠ CAUTION** Do not force the oven door open. This will damage the automatic door locking system. Use caution when opening the oven door after the self clean cycle ends. The oven may still be very hot and cause burns. To avoid possible burns, stand to side of oven when opening door to allow steam or hot air to escape.

**⚠ CAUTION** The health of some birds is extremely sensitive to fumes given off during the self clean cycle of any range. Move birds to a well ventilated room.

**⚠ CAUTION** Radiant surface elements will operate when an oven is in Self Clean mode IF the range is equipped with knobs. If this is the case, it is NOT advisable to use the surface elements when using the Self Clean function. The oven reaches very high temperatures and you could be burned.

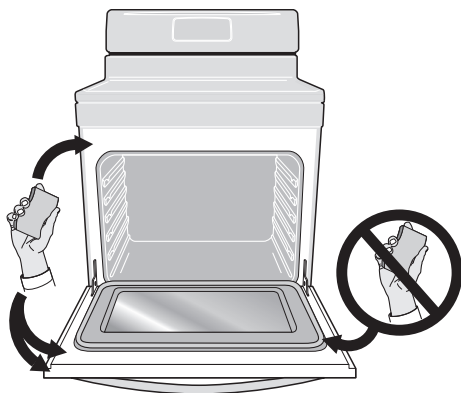



Figure 8: Areas to clean and to avoid

### Important notes:

- Completely remove all oven racks and any accessories from oven cavity to avoid damage to oven racks. If the oven racks are not removed they may discolor. Remove all items from the oven and cooktop including cookware, utensils and any aluminum foil. Aluminum foil will not withstand high temperatures from a self clean cycle and will melt.
- Do not use oven cleaners or oven protective coatings in or around any part of the oven interior. Clean any soil from the oven frame, the door liner outside the oven door gasket, and the small area at the front center of the oven bottom (See Figure 8). These areas heat sufficiently to burn soil on. Clean using soap and water prior to starting Self Clean.
- Remove any excessive spills. Any spills on the oven bottom should be wiped up and removed before starting a Self Clean cycle. To clean use hot, soapy water and a cloth. Large spills can cause heavy smoke or fire when subjected to high temperatures. Do not allow food spills with high sugar or acid content (such as milk, tomatoes, sauerkraut, fruit juices, or pie fillings) to remain on the surface as they may leave a dull spot even after cleaning.
- Do not clean the oven door gasket. The woven material in the gasket is essential for a good seal. Care should be taken not to rub, damage, or remove the oven door gasket. Doing so could cause damage to the door gasket and compromise the performance of the oven.
- The kitchen area should be well ventilated using an open window, ventilation fan, or exhaust hood during the first Self Clean cycle. This will help eliminate the normal odors.
- Do not attempt to open the oven door when the OVEN LOCK indicator light is flashing. Allow about 15 seconds for the motorized door latch mechanism to completely lock or unlock the oven door.
- When the clean time finishes, the oven door will remain locked until the range has cooled sufficiently. In addition to the clean time that was programmed, you must allow about 1 additional hour for the oven to cool before you will be able to open the oven door.

## Setting Self Clean

### To set Select Clean to start immediately:

1. Be sure the oven is empty and all oven racks are removed. Remove all items from the cooktop. Be sure the oven door is completely closed.
2. Press **Self Clean**. **3:00** appears in the display.
3. To change to a 2 hour clean time, press . **2:00** appears in the display. To select a 4 hour clean time, press . **4:00** appears in the display.
4. After selecting the clean time, press **START** to activate Self Clean. The **OVEN LOCK** indicator light will light, and **CLn** will appear in the display.

When Self Clean begins the cleaning cycle, the motorized door latch mechanism will automatically start to lock the oven door, and the **OVEN LOCK** indicator light will flash. Do not open the oven door when the **OVEN LOCK** indicator light is flashing. Allow about 15 seconds for the oven door to completely lock.

Once the oven door has locked, the **OVEN LOCK** indicator light will glow steady. When **CLn** will appear in the display, Self Clean is active.



### When Self Clean is finished:

**⚠ CAUTION** Use caution when opening the oven door after self cleaning. The oven may still be very hot and can cause burns. To avoid possible burns, stand to the side of the oven when opening the oven door to allow hot air or steam to escape.

1. The time of day will appear in the display window, and the **OVEN LOCK** indicator light will continue to glow.
2. Once the oven has cooled down (about 1 hour) and the **OVEN LOCK** indicator light has turned off, the oven door may be opened.
3. When the oven interior has completely cooled, wipe away any residue or powdered ash with a damp cloth or paper towel.

## Delayed Start Self Clean

### To start Delay Start Self Clean:

1. Be sure the oven is empty and all oven racks are removed. Remove all items from the cooktop. Be sure oven door is completely closed.
2. Be sure the clock shows the correct time of day.
3. Press **Delay Start**.
4. Press and hold  to scroll to the time desired to start the self clean cycle. Press **START** when the desired start time is displayed.
5. Press **Self Clean**. **3:00** appears in the display.
6. To select a 2 hour clean time, press . **2:00** appears in the display. To select a 4 hour clean time, press . **4:00** appears in the display.
7. After selecting the desired clean time, press **START**. Self Clean is set to activate. The **OVEN LOCK** indicator light will turn on, and the oven door will lock in advance of the starting time. Once the starting time is reached, **CLn** will appear in the display.

### If it becomes necessary to stop Self Clean when active:

1. Press .
2. If Self Clean has heated the oven to a high temperature, allow enough time for the oven to cool and for the **OVEN LOCK** indicator light to turn off. When this indicator light turns off, the oven door may be opened.
3. Restart Self Clean, if needed.

### Important notes:

- If Self Clean is active and a power failure occurs, the oven may not have thoroughly cleaned. This would depend on how much cleaning time had elapsed before the power failure. If needed after power is restored, set Self Clean again.

## Oven Controls

### Steam Clean

The Steam Clean feature offers a chemical free and time saving method to assist in the routine cleaning of small and light soils. For heavier baked on soils use the Self Clean feature.

**⚠ CAUTION** Do not add bleach, ammonia, oven cleaner, or any other abrasive household cleaners to the water used for Steam Clean.

**⚠ CAUTION** Before cleaning any part of the oven, be sure all controls are turned off and the oven is cool. The oven may be hot and can cause burns.

Be sure the oven is level and cool before starting Steam Clean. If the oven temperature is above room temperature a triple beep will be heard and the function will not start. Steam Clean produces best results when started with a cool oven

To set a Steam Clean cycle:

1. Remove all racks and oven accessories.
2. Scrape or wipe loose debris and grease from the oven bottom.
3. Pour 1 cup of tap water onto the oven bottom. (Figure 9) Close oven door.

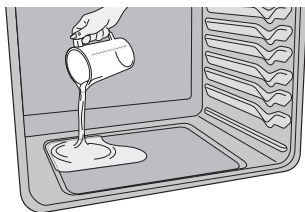

Figure 9: Add 1 cup of tap water

4. Press **Steam Clean**.
5. Press **START**.  
**St Cn** will appear in the display.
6. The time remaining in the Steam Clean cycle is shown in the display. Do not open the door during this time. If door is open while in Steam Clean (d-O) will appear in the display.
7. When the steam clean cycle is complete an alert will sound and the **END** message will show in the display. Press off to return to the clock.
8. Take care opening the door when the steam clean is finished. Stand to the side of the oven out of the way of escaping vapor.
9. Wipe oven cavity and bottom. Do not clean oven door gasket (Figure 10). Avoid leaning or resting on the oven door glass while cleaning cavity.

10. To cancel Steam Clean at any time press **OFF**.

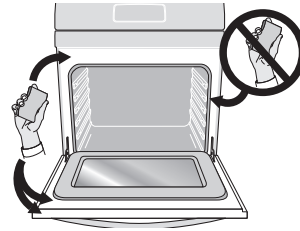

Figure 10: Clean around the oven door gasket

#### Notes:

- Opening oven door during Steam Clean cycle prevents the water from reaching the temperature needed to clean.
- For best results, clean oven immediately after the cycle is complete. Steam clean works best for soils on the oven bottom.
- Place a paper towel or cloth in front of the oven to capture any water that may spill while wiping out.
- A non abrasive scouring pad, stainless steel sponge, plastic scraper, or eraser style cleaning pad (without cleaner) can be used for difficult soils. Moisten pads with water before use.
- Do not leave the residual water in the oven for any length of time.
- Some condensation or water vapor may appear close to the oven vent. This is normal. The oven gasket may become damp; do not wipe dry.
- Local water sources often contain minerals (hard water). If hard water deposits occur, wipe cavity with a 50/50 solution of water and vinegar or 50/50 solution of lemon juice and water.
- Steam clean cannot be programmed with a delay start.
- If Steam Clean results are not satisfactory, run a Self Clean. See "[Setting Self Clean](#)" on [page 29](#).

## Care & Cleaning

Remove spills and any heavy soiling as soon as possible. Regular cleaning will reduce the difficulty of major cleaning later.

**CAUTION** - Before cleaning any part of the appliance, be sure all controls are turned off and the appliance is cool.

**CAUTION** - If ammonia or appliance cleaners are used, they must be removed and the appliance must be thoroughly rinsed before operating. Follow manufacturer's instructions and provide adequate ventilation.

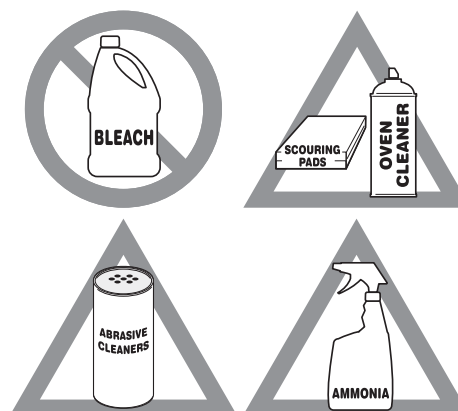

Figure 1: Use cleaners with caution

Surface or Area	Cleaning Recommendation
Aluminum and vinyl	Using a soft cloth, clean with mild dish detergent and water. Rinse with clean water, dry and polish with a soft, clean cloth.
Painted and plastic control knobs Painted body parts Painted decorative trims	Using a soft cloth, clean with mild dish detergent and water or a 50/50 solution of vinegar and water. Rinse with clean water, dry and polish with a soft, clean cloth. Glass cleaners may be used, but do not apply directly to surface; spray onto cloth and wipe.
Control panel	Using a soft cloth, clean with mild dish detergent and water or a 50/50 solution of vinegar and water. Do not spray liquids directly on the oven control and display area. Do not use large amounts of water on the control panel - excess water on the control area may cause damage to the appliance. Do not use other liquid cleaners, abrasive cleaners, scouring pads, or paper towels - they will damage the finish.
Control knobs	Using a soft cloth, clean with mild dish detergent and water or a 50/50 solution of vinegar and water. To remove control knobs: turn to the OFF position, grasp firmly, and pull off the shaft. To replace knobs after cleaning, line up the OFF markings and push the knobs into place.
Stainless Steel	Using a soft cloth, clean with mild dish detergent and water or a 50/50 solution of vinegar and water. Rinse with clean water, dry with a soft clean cloth. Do not use cleaners containing abrasives, chlorides, chlorine, or ammonia.
Easy Clean Stainless Steel Black Stainless Steel	Using a soft cloth, clean with mild dish detergent and water or a 50/50 solution of vinegar and water. Rinse with clean water, dry with a soft clean cloth. Do not use appliance cleaner, stainless steel cleaner, or cleaner containing abrasives, chlorides, chlorine, or ammonia. These cleaners may damage the finish.
Porcelain-enameled broiler pan and insert Porcelain door liner Porcelain body parts	Rinse with clean water and a damp cloth. Scrub gently with a soapy, non-abrasive scouring pad to remove most spots. Rinse with a 50/50 solution of clean water and ammonia. If necessary, cover difficult spots with an ammonia-soaked paper towel for 30 to 40 minutes. Rinse and wipe dry with a clean cloth. Remove all cleaners or future heating could damage the porcelain. Do not allow food spills with a high sugar or acid content (milk, tomatoes, sauerkraut, fruit juices or pie filling) to remain on porcelain surfaces. These spills may cause a dull spot even after cleaning.
Self-cleaning oven interior	Before setting a self-clean cycle, clean soils from the oven frame, areas outside the oven door gasket, and the small area at the front center of the oven bottom. See <a href="#">"Setting Self Clean"</a> on <a href="#">page 29</a> .

## Care & Cleaning

Surface or Area	Cleaning Recommendation
Oven door	<p data-bbox="532 241 1484 426">Use mild dish detergent and water or a 50/50 solution of vinegar and water to clean the top, sides, and front of the oven door. Rinse well. Glass cleaner may be used on the outside glass of the door. Ceramic smoothtop cleaner or polish may be used on the interior door glass. Do not immerse the door in water. Do not spray or allow water or cleaners to enter the door vents. Do not use oven cleaners, cleaning powders, or any harsh abrasive cleaning materials on the outside of the oven door.</p> <p data-bbox="532 447 1435 506">Do not clean the oven door gasket. The oven door gasket is made of a woven material which is essential for a good seal. Do not rub, damage, or remove this gasket.</p>
Ceramic cooktop	See <a href="#">“Cooktop Maintenance”</a> on <a href="#">page 33</a> .



## Cooktop Maintenance

Consistent and proper cleaning is essential to maintaining your ceramic glass cooktop.

Prior to using your cooktop for the first time, apply a ceramic cooktop cleaning cream (available in most hardware, grocery, and department stores) to the ceramic surface. Clean and buff with a clean paper towel. This will make cleaning easier when soiled from cooking. Cooktop cleaning creams leave a protective finish on the glass to help prevent scratches and abrasions.

Sliding aluminum, cast iron, or copper bottomed pans on the cooktop can cause metal markings on the cooktop surface. These marks should be removed immediately after the cooktop has cooled using cooktop cleaning cream. Metal marks can become permanent if not removed prior to future use.

Cookware (cast iron, metal, ceramic, or glass) with rough bottoms can mark or scratch the cooktop surface.

### Do not:

- Slide anything metal or glass across the cooktop.
- Use cookware with dirt or dirt build up on the bottom; always use clean cookware.
- Use your cooktop as a cutting board or work surface in the kitchen.
- Cook foods directly on the cooktop surface without a pan.
- Drop heavy or hard objects on the ceramic glass cooktop; they may cause it to crack.

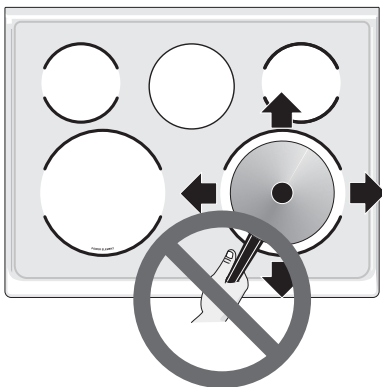

Figure 2: Cooktop care

## Cooktop Cleaning

**⚠ WARNING** - Do not use a cooktop cleaner on a hot cooktop. The fumes can be hazardous to your health, and can chemically damage the ceramic-glass surface.

**⚠ CAUTION** - Before cleaning the cooktop, be sure the controls are turned to OFF and the cooktop is cool. The glass surface could be hot and burns may occur if the glass surface is touched before it has cooled sufficiently.

### For light to moderate soil:

For light to moderate soil: Apply a few drops of cooktop cleaning cream directly to the cooktop. Use a clean paper towel to clean the entire cooktop surface. Make sure the cooktop is cleaned thoroughly, leaving no residue. Do not use the towel you use to clean the cooktop for any other purpose.

### For heavy, burned on soil:

Apply a few drops of cooktop cleaning cream directly to the soiled area. Rub the soiled area using a non-abrasive cleaning tool, applying pressure as needed. Do not use the pad you use to clean the cooktop for any other purpose.

If soils remain, carefully scrape soils with a metal razor blade scraper, holding scraper at a 30 degree angle to the surface. Remove loosened soils with cooktop cleaning cream and buff the surface clean.

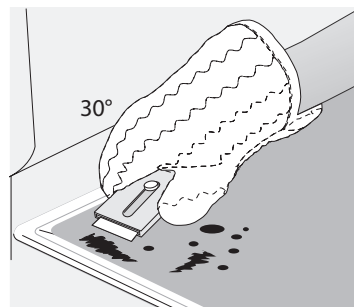

Figure 3: Cooktop cleaning

**Important:** Damage to the ceramic glass cooktop may occur if you use an abrasive type cleaning pad. Only use cleaning products that have been specifically designed for ceramic glass cooktops.

## Care & Cleaning

### Aluminum Foil and Utensils

**⚠ WARNING** - Never cover any slots, holes, or passages in the oven bottom or cover an entire oven rack with materials such as aluminum foil. Aluminum foil linings may trap heat, causing a fire hazard.

**⚠ WARNING** - Protective Liners — Do not use aluminum foil to line the oven bottom. Improper installation of these liners may result in risk of electric shock or fire.

### Important notes:

- Aluminum foil - Use of aluminum foil on a hot cooktop can damage the cooktop. Do not use thin aluminum cooking utensils or allow aluminum foil to touch the surface elements under any circumstances.
- Aluminum utensils - The melting point of aluminum is much lower than that of other metals. Care must be taken when aluminum pots or pans are used on the cooktop. If aluminum pans are allowed to boil dry when using the cooktop, not only will the utensil be damaged or destroyed, but it may fuse to, break, or mark the ceramic glass surface, permanently damaging the cooktop surface.

### Replacing the Oven Light

**⚠ CAUTION** - Be sure the oven is unplugged and all parts are cool before replacing the oven light.

**⚠ CAUTION** - Be sure the oven is unplugged and all parts are cool before replacing the oven light.

### Replacing the oven interior light bulb:

The interior oven light is located at the rear of the oven cavity and covered with a glass shield. The glass shield must be in place whenever the oven is in use (Figure 4).

1. Turn electrical power off at the main source or unplug the appliance.
2. Remove the interior oven light shield after removing the wire holder by carefully moving the wire to the side of the glass shield. The tension from the wire holds the glass shield in place.
3. Pull the shield straight out. Do not twist or turn.
4. Replace the bulb with a new appliance bulb.
5. Replace the glass oven light shield. Replace wire holder.
6. Turn the power back on again at the main source (or plug the appliance back in).
7. Be sure to reset the time of day on the clock.

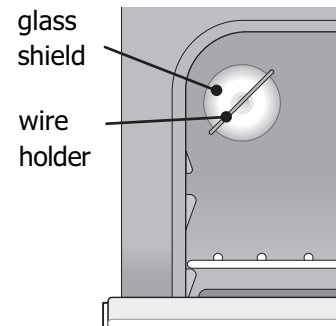

Figure 4: Oven light protected by glass shield

### Remove and replace storage drawer (some models)

Use the storage drawer for storing cooking utensils. The drawer can be removed to facilitate cleaning under the range. Use care when handling the drawer.

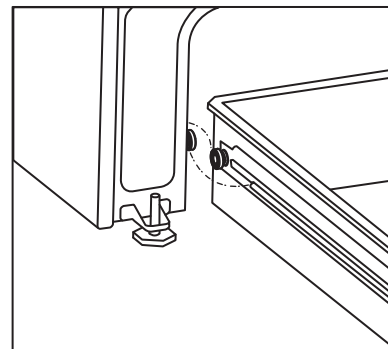

Figure 5: Open storage drawer

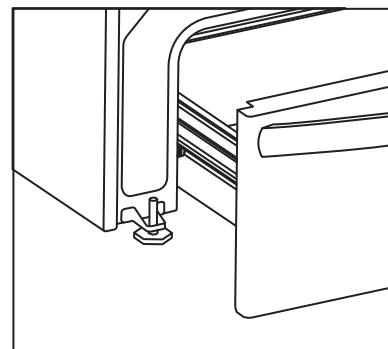

Figure 6: Closed storage drawer

## Removing and Replacing the Oven Door

### To remove oven door:

**⚠ CAUTION** - The door is heavy. For safe, temporary storage, lay the door flat with the inside of the door facing down.

1. Open oven door completely, horizontal with floor (See [Figure 7](#)).
2. Pull the door hinge locks on both left and right door hinges down from the oven frame completely towards the oven door (See [Figure 8](#)). A tool such as a small flat-blade screwdriver may be required.
3. Firmly grasp both sides of oven door along the door sides. Do not use the oven door handle (See [Figure 9](#)).
4. Close the door to approximately 10 degrees from the door frame (See [Figure 9](#)).
5. Lift the oven door hinge arms over the roller pins located on each side of the oven frame (See [Figure 10](#)).

### To replace oven door:

1. Firmly grasp both sides of oven door along the door sides. Do not use the oven door handle (See [Figure 9](#)).
2. Holding the oven door at the same angle as the removal position, seat the hook of the hinge arm over the roller pins located on each side of the oven door frame (See [Figure 9](#) and [Figure 10](#)). The hook of the hinge arms must be fully seated onto the roller pins.
3. Fully open the oven door, horizontal with floor (See [Figure 7](#)).
4. Push the door hinge locks up towards and into the oven frame on both left and right oven door hinges to the locked position (See [Figure 8](#)).
5. Close the oven door.

**Important:** Special door care instructions - Most oven doors contain glass that can break. Do not hit the glass with pots, pans, or any other object. Scratching, hitting, jarring, or stressing the glass may weaken its structure, causing an increased risk of breakage at a later time. Do not close the oven door until all of the oven racks are fully in place.

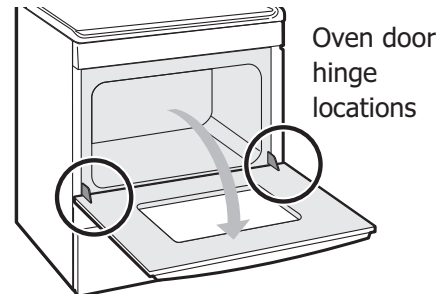

Figure 7: Door hinge location

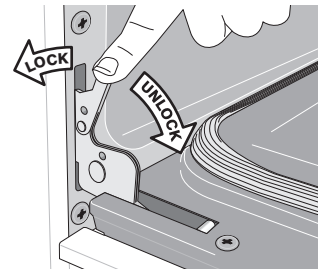

Figure 8: Door hinge locks

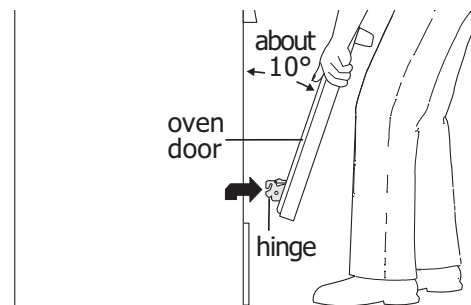

Figure 9: Holding door for removal

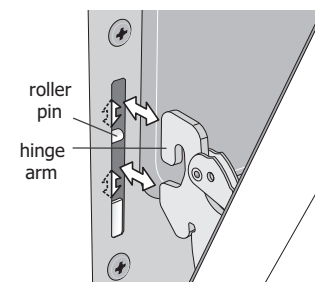

Figure 10: Replacement and location of hinge arm and roller pin

## Care & Cleaning

### Replacing the Oven Light

**⚠ CAUTION** - Be sure the oven is unplugged and all parts are cool before replacing the oven light.

#### Replacing the oven interior light bulb:

The interior oven light is located at the rear of the oven cavity and covered with a glass shield. The glass shield must be in place whenever the oven is in use (Figure 11).

1. Turn electrical power off at the main source or unplug the appliance.
2. Remove the interior oven light shield after removing the wire holder by carefully moving the wire to the side of the glass shield. The tension from the wire holds the glass shield in place.
3. Pull the shield straight out. Do not twist or turn.
4. Replace the bulb with a new appliance bulb.
5. Replace the glass oven light shield. Replace wire holder.
6. Turn the power back on again at the main source (or plug the appliance back in).
7. Be sure to reset the time of day on the clock.

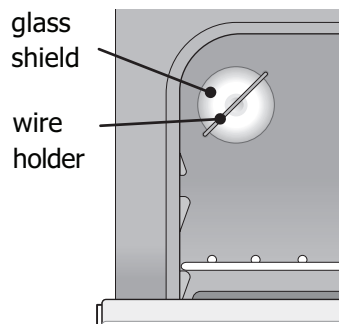

Figure 11: Oven light protected by glass shield

**⚠ CAUTION** - Be sure the oven is unplugged and all parts are cool before replacing the oven light.

### Remove and replace storage drawer (some models)

Use the storage drawer for storing cooking utensils. The drawer can be removed to facilitate cleaning under the range. Use care when handling the drawer.

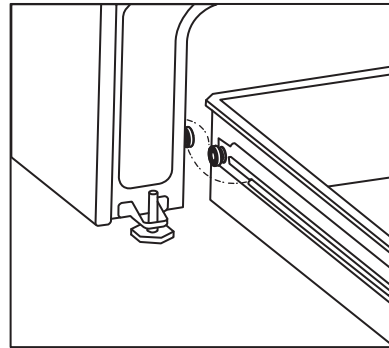

Figure 12: Open storage drawer

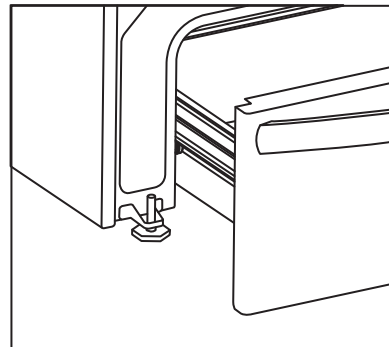

Figure 13: Closed storage drawer

# Before You Call

## Solutions to Common Problems:

Before you call for service, review the following list. It may save you time and expense. Possible solutions are provided with the problem listed.

Problem	Cause / Solution
Entire appliance does not operate.	Appliance not connected. Make sure power cord is plugged properly into outlet. Check your fuse box or breaker box to make sure the circuit is active.  Electrical power outage. Check house lights to be sure. Call your local electric company for service outage information.
<b>Oven Problems</b>	
Poor baking results.	Many factors affect baking results. Use proper oven rack position. Center food in the oven and space pans to allow air to circulate. Preheat the oven to the set temperature before placing food in the oven. Try adjusting the recipe's recommended temperature or baking time. See <a href="#">"Adjusting oven temperature"</a> on <a href="#">page 27</a> if you feel the oven is too hot or too cool.
Flames inside oven or smoking from oven vent.	Excessive spills in oven. Grease or food spilled onto the oven bottom or oven cavity. Wipe up excessive spills before starting the oven. If flames or excessive smoke are present when using broil, see <a href="#">"Setting Broil"</a> on <a href="#">page 26</a> .
Oven smokes excessively when broiling.	Incorrect setting. Follow the <a href="#">"Setting Broil"</a> instructions on <a href="#">page 26</a> .  Meat too close to the broil element or burner. Reposition the broil pan to provide proper clearance between the meat and broil element or burner. Remove excess fat from meat. Cut remaining fatty edges to prevent curling, but do not cut into lean.  Grease build up on oven surfaces. Regular cleaning is necessary when broiling frequently. Grease or food splatters will cause excessive smoking.
Oven control panel beeps and displays any F or E code error.	Oven control has detected a fault or error condition. To clear the error, press the <b>OFF</b> key on the control panel. Once the error code is cleared, try the bake or broil function. If the F or E code error repeats, turn off the power to appliance, wait 5 minutes, and then repower the appliance. Set the clock with correct time of day. Try the bake or broil function again. If the fault recurs, press the <b>OFF</b> key to clear.
Oven portion of appliance does not operate.	The time of day is not set. The clock must be set in order to operate the oven. See <a href="#">"Setting Clock"</a> on <a href="#">page 21</a> .  Be sure the oven controls are set properly for the desired function. See <a href="#">"Oven Controls"</a> starting on <a href="#">page 20</a> and review instructions for the desired cooking function in this manual or see <a href="#">"Entire appliance does not operate."</a> in this checklist.
<b>Cooktop Problems</b>	
Surface element is too hot or not hot enough.	Incorrect surface control setting. Adjust power level setting.
Surface element does not heat or does not heat evenly.	Be sure the correct surface control knob is turned on for the element needed.  Cookware is light weight or warped. Use only flat, evenly balanced, medium or heavyweight cookware. Flat pans heat better than warped pans. Cookware materials and weight of the material affect heating. Heavy and medium-weight pans heat evenly. Because lightweight pans heat unevenly, foods may burn easily.
<b>Self Clean Problems</b>	
Self clean does not work	Oven control not set properly. See <a href="#">"Setting Self Clean"</a> on <a href="#">page 29</a>

## Before You Call

<b>Problem</b>	<b>Cause / Solution</b>
Oven racks discolored or do not slide easily	Oven racks left in oven cavity during self clean. Remove oven racks from oven cavity before starting a self-clean cycle. Clean by using a mild abrasive cleaner following manufacturer's instructions. Rinse with clean water, dry, and replace in oven.
Soil not completely removed after self clean	Self clean was interrupted. Review instructions on <a href="#">"Setting Self Clean"</a> on page 29. Excessive spills on oven bottom. Remove excessive spills before starting self clean. Failure to clean soil from the oven frame, the door liner outside the oven door gasket, and the small area at the front center of the oven bottom. These areas are not in the self-cleaning area, but get hot enough to burn on residue. Clean these areas before starting the self-cleaning cycle. Burned-on residue can be cleaned with a stiff nylon brush and water or a nylon scrubber. Be careful not to damage the oven gasket
Areas of discoloration with metallic sheen on cooktop surface.	Mineral deposits from water and food. Remove them using cooktop cleaning creme applied to the ceramic surface. Buff with a non-abrasive cloth or sponge.
Scratches or abrasions on cooktop surface.	Coarse particles such as salt or hardened soils between cooktop and utensils can cause scratches. Be sure the cooktop surface and bottoms of utensils are clean before use. Small scratches do not affect cooking and will become less visible with time. Cleaning materials not recommended for ceramic-glass cooktop have been used. Apply cooktop cleaning creme to the ceramic surface. Buff with a non-abrasive cloth or sponge. Cookware with a rough bottom was used. Use smooth, flat-bottomed cookware.
Metal marks on the cooktop.	Sliding or scraping of metal utensils on cooktop surface. Do not slide metal utensils on the cooktop surface. Apply cooktop cleaning creme to the ceramic surface. Buff with a non-abrasive cloth or sponge. For more information, see <a href="#">"Cooktop Maintenance"</a> on page 33.
Brown streaks or specks on cooktop surface.	Boil overs are cooked onto the surface. When cooktop is cool, use a razor blade scraper to remove soil. For more information see <a href="#">"Cooktop Maintenance"</a> on page 33.
<b>Self Clean Problems</b>	
Self clean does not work.	Oven control not set properly. See <a href="#">"Setting Self Clean"</a> on page 29.
Oven racks discolored or do not slide easily.	Oven racks left in oven cavity during self clean. Remove oven racks from oven cavity before starting a self-clean cycle. Clean by using a mild abrasive cleaner following manufacturer's instructions. Rinse with clean water, dry, and replace in oven.
Soil not completely removed after self clean.	Self clean was interrupted. Review instructions on <a href="#">"Setting Self Clean"</a> on page 29. Excessive spills on oven bottom. Remove excessive spills before starting self clean. Failure to clean soil from the oven frame, the door liner outside the oven door gasket, and the small area at the front center of the oven bottom. These areas are not in the self-cleaning area, but get hot enough to burn on residue. Clean these areas before starting the self-cleaning cycle. Burned-on residue can be cleaned with a stiff nylon brush and water or a nylon scrubber. Be careful not to damage the oven gasket.

Problem	Cause / Solution
<b>Other Problems</b>	
Appliance is not level.	<p>Be sure the floor is level, strong, and stable enough to adequately support the range.</p> <p>If the floor is sagging or sloping, contact a carpenter to correct the situation.</p> <p>Poor installation. Place the oven rack in the center of the oven. Place a level on the oven rack. Adjust the leveling legs at the base of the appliance until the rack is level.</p> <p>Kitchen cabinet alignment may make range appear not level. Be sure cabinets are square and have sufficient room for appliance clearance.</p>
Cannot move appliance easily. Appliance must be accessible for service.	<p>Cabinets not square or are built in too tightly. Contact the builder or installer to make the appliance accessible.</p> <p>Carpet interferes with appliance. Provide sufficient space so the appliance can be lifted over carpet. Installation over carpet is not advised. See the installation instructions for guidelines specific to your appliance.</p>
Oven light does not work.	Be sure the oven light is secure in the socket. See <a href="#">“Replacing the Oven Light”</a> on <a href="#">page 36</a> .

# Kenmore®

## Customer Care Hotline

To schedule in-home repair service  
or order replacement parts

Para pedir servicio de reparación  
a domicilio, y ordenar piezas

# 1-844-553-6667

[www.kenmore.com](http://www.kenmore.com)

