











*Microwave
Use & Care Manual
Over-the-Range Microwave Oven*

FMT148

FRIGIDAIRE
Gallery
&
Gallery
Professional
S e r i e s

Product Registration Cover		Operating Instructions 12-31	
Important Safety Information 2-8		Care and Cleaning 35-39	
Grounding Instructions 9		Troubleshooting 40-41	
Features 10, 32-34		Consumer Services	
Getting Started 11		Warranty & Service 42-44	

**Record All Information For
Future Reference**

Brand: _____

Model #: _____

Serial #: _____
(See Features page for location)

Date of Purchase: _____

Register Your Product!

Please fill in completely, sign and return promptly!



Questions ? 1-800-944-9044
(United States)

READ AND SAVE THESE INSTRUCTIONS



IMPORTANT SAFETY INFORMATION

READ ALL INFORMATION BEFORE USING



PRECAUTIONS TO AVOID POSSIBLE EXPOSURE TO EXCESSIVE MICROWAVE ENERGY

For your safety the information in this manual must be followed to minimize the risk of fire or explosion or to prevent property damage, personal injury or loss of life.

Do Not Attempt to operate this oven with the door open since open-door operation can result in harmful exposure to microwave energy. It is important not to defeat or tamper with the safety interlocks.

Do Not Place any object between the oven front face and the door or allow soil or cleaner residue to accumulate on sealing surfaces.

Do Not Operate the oven if it is damaged. It is particularly important that the oven door close properly and that there is no damage to the:

1. door (bent)
2. hinges and latches (broken or loosened)
3. door seals and sealing surfaces.

The Oven Should Not be adjusted or repaired by anyone except properly qualified service personnel.

NEED HELP? Help us, help you: 1-800-944-9044.

Before you call for service, there are a few things you can do to help us serve you better.

Read this manual.

It contains instructions to help you use and maintain your microwave properly.

If you received a damaged oven...immediately contact the dealer (or builder) that sold you the oven.

Save time and money.

Check the section titled "Troubleshooting" before calling. This section helps you solve common problems that might occur. If you do need service, you can relax knowing help is only a phone call away. A list of toll-free customer service numbers is included in the back of this manual. Or call Frigidaire Consumer Services at 1-800-944-9044, 24 hours a day, 7 days a week.



IMPORTANT SAFETY INFORMATION



WARNING!

To reduce the risk of fire, burns, electric shock, injury to persons, or exposure to excessive microwave energy when using your appliance, follow basic precautions, including the following sections.

SAFETY PRECAUTIONS

*This microwave oven is UL listed for installation over electric and gas ranges.
This microwave oven is not approved or tested for marine use.*

- Read and follow the specific “Precautions to Avoid Possible Exposure to Excessive Microwave Energy” on page 2.
- This appliance must be grounded. Connect only to properly grounded outlet. See Grounding Instructions section on page 9.
- Do not mount this appliance over a sink.
- Install or locate this appliance only in accordance with the provided Installation Instructions.
- This over-the-range oven was designed for use over ranges no wider than 42 inches. It may be installed over both gas and electric cooking equipment.
- Do not operate this appliance if it has a damaged power cord or plug, if it is not working properly, or if it has been damaged or dropped.
- Do not cover or block any openings on the appliance.
- Use this appliance only for its intended use as described in this manual. Do not use corrosive chemicals or vapors in this appliance. This microwave oven is specifically designed to heat, dry or cook food, and is not intended for laboratory or industrial use.



IMPORTANT SAFETY INFORMATION

READ ALL INFORMATION BEFORE USING

- Do not store this appliance outdoors. Do not use this product near water—for example, in a wet basement, near a swimming pool or near a sink.
- Keep power cord away from heated surfaces.
- Do not immerse power cord or plug in water.
- See door surface cleaning instructions in the Care and Cleaning section(s) of this manual.
- This appliance should be serviced only by qualified service personnel. Contact nearest authorized service facility for examination, repair or adjustment.
- As with any appliance, close supervision is necessary when used by children.
- To reduce the risk of fire in the oven cavity:
 - Do not overcook food. Carefully attend appliance if paper, plastic or other combustible materials are placed inside the oven while cooking.
 - Remove wire twist-ties and metal handles from paper or plastic containers before placing them in the oven.
 - Do not use the oven for storage purposes. Do not leave paper products, cooking utensils or food in the oven when not in use.
 - If materials inside oven should ignite, keep the oven door closed, turn the oven off and disconnect the power cord, or shut off power at the fuse or circuit breaker panel. If the door is opened, the fire may spread.

**SAVE THESE
INSTRUCTIONS.**



IMPORTANT SAFETY INFORMATION

Special Notes About Microwaving

Arcing

If you see arcing, press the CLEAR/OFF pad and correct the problem.

Arcing is the microwave term for sparks in the oven. Arcing is caused by:

- The temperature probe in the microwave but not inserted in the food.
- The metal shelf not installed correctly so it touches the microwave wall.
- Metal or foil touching the side of the oven.
- Foil not molded to food (upturned edges act like antennas).
- Metal, such as twist-ties, poultry pins, or gold-rimmed dishes, in the microwave.
- Recycled paper towels containing small metal pieces being used in the microwave.

Foods

- Do not pop popcorn in your microwave oven unless in a special microwave popcorn accessory or unless you use popcorn labeled for use in microwave ovens.
- Some products such as whole eggs and sealed containers—for example, closed jars—will explode and should not be heated in this microwave oven. Such use of the microwave oven could result in injury.
- Do not boil eggs in a microwave oven. Pressure will build up inside egg yolk and will cause it to burst, possibly resulting in injury.
- Operating the microwave with no food inside for more than a minute or two may cause damage to the oven and could start a fire. It increases the heat around the magnetron and can shorten the life of the oven.
- Foods with unbroken outer “skin” such as potatoes, hot dogs, sausages, tomatoes, apples, chicken livers and other giblets, and egg yolks should be pierced to allow steam to escape during cooking.



IMPORTANT SAFETY INFORMATION

READ ALL INFORMATION BEFORE USING

Safety Fact – *SUPERHEATED WATER*

Microwaved water and other liquids do not always bubble when they reach the boiling point. They can actually get superheated and not bubble at all.

Superheated liquid will bubble up out of the cup when it is moved or when something like a spoon or tea bag is put into it.

To prevent this from happening and causing injury, do not heat any liquid for more than 2 minutes per cup. After heating, let the cup stand in the microwave for 30 seconds before moving it or putting anything into it.

- Avoid heating baby food in glass jars, even with the lid off. Make sure all infant food is thoroughly cooked. Stir food to distribute the heat evenly. Be careful to prevent scalding when warming formula or breast milk. The container may feel cooler than the milk really is. Always test the milk before feeding the baby.
- Spontaneous boiling—Under certain special circumstances, liquids may start to boil during or shortly after removal from the microwave oven. To prevent burns from splashing liquid, we recommend the following: before removing the container from the oven, allow the container to stand in the oven for 30 to 40 seconds after the oven has shut off. Do not boil liquids in narrow-necked containers such as soft drink bottles, wine flasks and especially narrow-necked coffee cups. Even if the container is opened, excessive steam can build up and cause it to burst or overflow.
- Do not defrost frozen beverages in narrow-necked bottles (especially carbonated beverages). Even if the container is opened, pressure can build up. This can cause the container to burst, possibly resulting in injury.
- Hot foods and steam can cause burns. Be careful when opening any containers of hot food, including popcorn bags, cooking pouches and boxes. To prevent possible injury, direct steam away from hands and face.
- Do not overcook potatoes. They could dehydrate and catch fire, causing damage to your oven.
- Cook meat and poultry thoroughly—meat to at least INTERNAL 160°F. and poultry to at least INTERNAL 180°F. Cooking to these internal temperatures usually protects against foodborne illness.



IMPORTANT SAFETY INFORMATION

Special Notes About Microwaving

Microwave-Safe Cookware

Make sure all cookware used in your microwave oven is suitable for microwaving. Most glass casseroles, cooking dishes, measuring cups, custard cups, pottery or china dinnerware which does not have metallic trim or glaze with a metallic sheen can be used. Some cookware is labeled “suitable for microwaving.”



How to test for a microwave-safe dish.

- Do not use recycled paper products. Recycled paper towels, napkins and waxed paper can contain metal flecks which may cause arcing or ignite. Paper products containing nylon or nylon filaments should be avoided, as they may also ignite.
 - Do not use the microwave to dry newspapers.
 - Not all plastic wrap is suitable for use in microwave ovens. Check the package for proper use.
 - Paper towels, waxed paper and plastic wrap can be used to cover dishes in order to retain moisture and prevent spattering. Be sure to vent plastic wrap so steam can escape.
 - Cookware may become hot because of heat transferred from the heated food. Pot holders may be needed to handle the cookware.
 - “Boilable” cooking pouches and tightly closed plastic bags should be slit, pierced or vented as directed by package. If they are not, plastic could burst during or immediately after cooking, possibly resulting in injury. Also, plastic storage containers should be at least partially uncovered because they form a tight seal. When cooking with containers tightly covered with plastic wrap, remove covering carefully and direct steam away from hands and face.
- If you are not sure if a dish is microwave-safe, use this test: Place in the oven both the dish you are testing and a glass measuring cup filled with 1 cup of water—set the measuring cup either in or next to the dish. Microwave 1 minute at high. If the dish heats, it should not be used for microwaving. If the dish remains cool and only the water in the cup heats, then the dish is microwave-safe.
 - If you use a meat thermometer while cooking, make sure it is safe for use in microwave ovens.
 - Some styrofoam trays (like those that meat is packaged on) have a thin strip of metal embedded in the bottom. When microwaved, the metal can burn the floor of the oven or ignite a paper towel.



IMPORTANT SAFETY INFORMATION READ ALL INFORMATION BEFORE USING

Microwave-Safe Cookware (continued)

- Use foil only as directed in this manual. TV dinners may be microwaved in foil trays less than 3/4" high; remove the top foil cover and return the tray to the box. When using foil in the microwave oven, keep the foil at least 1 inch away from the sides of the oven.
 - Plastic cookware—Plastic cookware designed for microwave cooking is very useful, but should be used carefully. Even microwave-safe plastic may not be as tolerant of overcooking conditions as are glass or ceramic materials and may soften or char if subjected to short periods of overcooking.
- In longer exposures to overcooking, the food and cookware could ignite. Follow these guidelines:
1. Use microwave-safe plastics only and use them in strict compliance with the cookware manufacturer's recommendations.
 2. Do not microwave empty containers.
 3. Do not permit children to use plastic cookware without complete supervision.

The Exhaust Fan

The fan will operate automatically under certain conditions (see Automatic Fan feature). Take care to prevent the starting and spreading of accidental cooking fires while the exhaust fan is in use.

- Clean the underside of the microwave often. Do not allow grease to build up on the microwave or the fan filters.
- In the event of a grease fire on the surface units below the microwave oven, smother a flaming pan on the surface unit by covering the pan completely with a lid, a cookie sheet or a flat tray.
- Use care when cleaning the exhaust fan filters. Corrosive cleaning agents, such as lye-based oven cleaners, may damage the filters.
- When flaming foods under the microwave, turn the exhaust fan off. The fan, if operating, may spread the flame.
- Never leave surface units beneath your microwave oven unattended at high heat settings. Boilovers cause smoking and greasy spillovers that may ignite and spread if the microwave exhaust fan is operating. To minimize automatic fan operation, use adequate sized cookware and use high heat on surface units only when necessary.



IMPORTANT SAFETY INFORMATION

Grounding Instructions/Optional Kits

Grounding Instructions

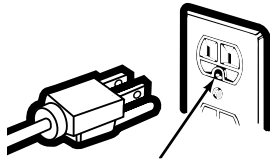

Ensure proper ground exists before use.



WARNING

Improper use of the grounding plug can result in a risk of electric shock.

This appliance must be grounded. In the event of an electrical short circuit, grounding reduces the risk of electric shock by providing an escape wire for the electric current.

This appliance is equipped with a power cord having a grounding wire with a grounding plug. The plug must be plugged into an outlet that is properly installed and grounded.

Consult a qualified electrician or service technician if the grounding instructions are not completely understood, or if doubt exists as to whether the appliance is properly grounded.

If the outlet is a standard 2-prong wall outlet, it is your personal responsibility and obligation to have it replaced with a properly grounded 3-prong wall outlet.

Do not under any circumstances cut or remove the third (ground) prong from the power cord.

Do not use an adapter plug with this appliance.

Do not use an extension cord with this appliance. If the power cord is too short, have a qualified electrician or service technician install an outlet near the appliance.

For best operation, plug this appliance into its own electrical outlet to prevent flickering of lights, blowing of fuse or tripping of circuit breaker.

Optional Kits

Filler Panel Kits

JX40WH or JX46WH—White

JX41 or JX46BL—Black

JX40AL or JX46AL—Almond

When replacing a 36" or 42" range hood, filler panel kits fill in the additional width to provide a custom built-in appearance.

For installation between cabinets only; not for end-of-cabinet installation. Each kit contains two 3"-wide filler panels. Two kits are needed for a 42" opening.

Filter Kits

JX81A—Recirculating Charcoal Filter Kit

Filter kits are used when the microwave oven cannot be vented to the outside.

Available at extra cost from your Frigidaire supplier.



Microwave Features

Here is a quick guide to the features and controls of your microwave oven.

NOTE: This manual covers several models so the illustration may not look exactly like your model. However, operating instructions for each of the features and functions of your microwave will be found in this manual.

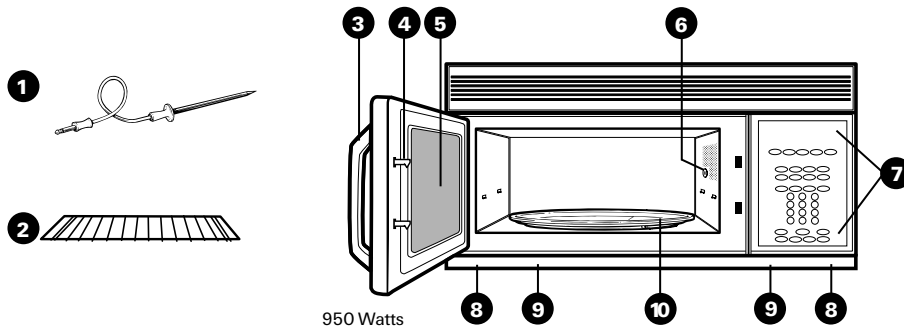

1. Temperature Probe.

Use with Temp Cook and Roast functions only.

2. Shelf. Lets you microwave several foods at once. Food microwaves best when placed directly on the turntable.

3. Door Handle. Pull to open the door. The door must be securely latched for the microwave to operate.

4. Door Latches.

5. Window with Metal Shield. Screen allows cooking to be viewed while keeping microwaves confined in the oven.

6. Receptacle for Temperature Probe.

Probe must be securely inserted into the receptacle before the oven will Temp Cook or Roast.

7. Touch Control Panel Display.

8. Cooktop Lights.

9. Grease Filters.

10. Removable Turntable. Turntable and support **must** be in place when using the oven. The turntable may be removed for cleaning.

NOTE: Rating plate, oven vent(s) and oven light are located on the inside walls of the microwave oven. Model and serial numbers are on a label inside the oven.



Getting Started

You can microwave by time, temperature, or with the sensor features.

(Throughout this manual, features and appearance may vary from your model.)



Time & Auto Features

Press		Enter
Cook Time I & II	<i>Press once or twice</i>	Amount of cooking time.
Auto/Time Defrost	<i>Press once</i> <i>Press twice</i>	Food weight. Amount of defrosting time.
Express Cook	<i>Starts immediately!</i>	
Power Level		Power level 1-10.
Plus 30 Sec	<i>Starts immediately!</i>	



Temperature Features – Probe Cooking

Press		Enter
Temp Cook/Roast	<i>Press once</i> <i>Press twice</i> <i>Press three times</i> <i>Press four times</i>	Desired food temperature. Medium automatically selected. Well automatically selected. Simmer automatically selected.

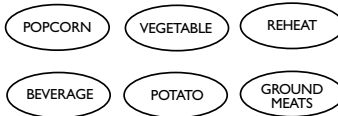

Sensor Features

Press	Enter	Option
Popcorn	<i>Starts immediately!</i>	more/less time
Vegetable	<i>Starts immediately!</i>	more/less time
Fresh Vegetables	<i>Press once</i>	more/less time
Frozen Vegetables	<i>Press twice</i>	more/less time
Canned Vegetables	<i>Press three times</i>	more/less time (on some models)
Reheat	<i>Starts immediately!</i>	more/less time
Beverage	<i>Starts immediately!</i>	
Potato	<i>Starts immediately!</i>	more/less time
Ground Meats	<i>Starts immediately!</i>	more/less time



Operating Instructions

Changing Power Levels

How to Change the Power Level

The power level may be entered or changed immediately after entering the feature time for COOK TIME, TIME DEFROST or EXPRESS COOK. The power level may also be changed during time countdown.

1. Press COOK TIME or select Time Defrost.
2. Enter cooking or defrosting time.
3. Press POWER LEVEL.



4. Select desired power level 1-10.

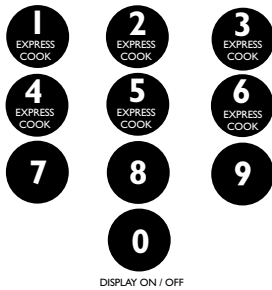

5. Press START.

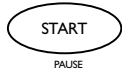

Variable power levels add flexibility to microwave cooking. The power levels on the microwave oven can be compared to the surface units on a range. High (power level 10) or full power is the fastest way to cook and gives you 100% power. Each power level gives you microwave energy a certain percent of the time. Power level 7 is microwave energy 70% of the time. Power level 3 is energy 30% of the time.

A high setting (10) will cook faster but food may need more frequent stirring, rotating or turning over. Most cooking will be done on High (power level 10). A lower setting will cook more evenly and need less stirring or rotating of the food.

Some foods may have better flavor, texture or appearance if one of the lower settings is used. Use a lower power level when cooking foods that have a tendency to boil over, such as scalloped potatoes.

Rest periods (when the microwave energy cycles off) give time for the food to “equalize” or transfer heat to the inside of the food. An example of this is shown with power level 3—the defrost cycle. If microwave energy did not cycle off, the outside of the food would cook before the inside was defrosted.

Here are some examples of uses for various power levels:

Power Level	Best Uses
High 10	Fish, bacon, vegetables, boiling liquids.
Med-High 7	Gentle cooking of meat and poultry; baking casseroles and reheating.
Medium 5	Slow cooking and tenderizing such as stews and less tender cuts of meat.
Low 2 or 3	Defrosting without cooking; simmering; delicate sauces.
Warm 1	Keeping food warm without overcooking; softening butter.



Operating Instructions

Time features

Cook Time

Cook Time I

Allows you to microwave for any time up to 99 minutes and 99 seconds.

Power level 10 (High) is automatically set, but you may change it for more flexibility.

You may open the door during Cook Time to check the food. Close the door and press START to resume cooking.

1. Press COOK TIME.



2. Enter cooking time.

3. Change power level if you don't want full power. (Press POWER LEVEL. Select a desired power level 1-10.)



4. Press START.



Cook Time II

Lets you change power levels automatically during cooking. Here's how to do it:

1. Press COOK TIME.
2. Enter the first cook time.
3. Change the power level if you don't want full power. (Press POWER LEVEL. Select a desired power level 1-10.)
4. Press COOK TIME again.
5. Enter the second cook time.
6. Change the power level if you don't want full power. (Press POWER LEVEL. Select a power level 1-10.)
7. Press START.

At the end of Cook Time I, Cook Time II counts down.



Operating Instructions

Cooking Guide For Cook Time I & II

NOTE: Use power level High (10) unless otherwise noted.

Vegetable	Amount	Time	Comments
Asparagus (fresh spears)	1 lb.	6 to 9 min., Med-High (7)	In 1½-qt. oblong glass baking dish, place 1/4 cup water.
(frozen spears)	10-oz. package	5 to 7 min.	In 1-qt. casserole.
Beans (fresh green)	1 lb. cut in half	9 to 11 min.	In 1½-qt. casserole, place 1/2 cup water.
(frozen green)	10-oz. package	6 to 8 min.	In 1-qt. casserole, place 2 tablespoons water.
(frozen lima)	10-oz. package	6 to 8 min.	In 1-qt. casserole, place 1/4 cup water.
Beets (fresh, whole)	1 bunch	17 to 21 min.	In 2-qt. casserole, place 1/2 cup water.
Broccoli (fresh cut)	1 bunch (1¼ to 1½ lbs.)	7 to 10 min.	In 2-qt. casserole, place 1/2 cup water.
(fresh spears)	1 bunch (1¼ to 1½ lbs.)	9 to 13 min.	In 2-qt. oblong glass baking dish, place 1/4 cup water. Rotate dish after half of time. (Turntable should be turned off.)
(frozen, chopped)	10-oz. package	5 to 7 min.	In 1-qt. casserole.
(frozen spears)	10-oz. package	5 to 7 min.	In 1-qt. casserole, place 3 tablespoons water.
Cabbage (fresh)	1 medium head (about 2 lbs.)	8 to 11 min.	In 1½- or 2-qt. casserole, place 1/4 cup water.
(wedges)		7 to 10 min.	In 2- or 3-qt. casserole, place 1/4 cup water.
Carrots (fresh, sliced)	1 lb.	7 to 9 min.	In 1½-qt. casserole, place 1/4 cup water.
(frozen)	10-oz. package	5 to 7 min.	In 1-qt. casserole, place 2 tablespoons water.
Cauliflower (flowerets)	1 medium head	9 to 14 min.	In 2-qt. casserole, place 1/2 cup water.
(fresh, whole)	1 medium head	10 to 17 min.	In 2-qt. casserole, place 1/2 cup water.
(frozen)	10-oz. package	5 to 7 min.	In 1-qt. casserole, place 2 tablespoons water.



Operating Instructions

Cooking Guide For Cook Time I & II

Vegetable	Amount	Time	Comments
Corn (frozen kernel)	10-oz. package	5 to 7 min.	In 1-qt. casserole, place 2 tablespoons water.
Corn on the cob (fresh)	1 to 5 ears	3 to 4 min. per ear	In 2-qt. oblong glass baking dish, place corn. If corn is in husk, use no water; if corn has been husked, add 1/4 cup water. Rearrange after half of time. (Turntable should be turned off.)
(frozen)	1 ear 2 to 6 ears	5 to 6 min. 3 to 4 min. per ear	Place in 2-qt. oblong glass baking dish. Cover with vented plastic wrap. Rearrange after half of time. (Turntable should be turned off.)
Mixed vegetables (frozen)	10-oz. package	5 to 7 min.	In 1-qt. casserole, place 3 tablespoons water.
Peas (fresh, shelled)	2 lbs. unshelled	9 to 12 min.	In 1-qt. casserole, place 1/4 cup water.
(frozen)	10-oz. package	5 to 7 min.	In 1-qt. casserole, place 2 tablespoons water.
Potatoes (fresh, cubed, white)	4 potatoes (6 to 8 oz. each)	9 to 12 min.	Peel and cut into 1 inch cubes. Place in 2-qt. casserole with 1/2 cup water. Stir after half of time.
(fresh, whole, sweet or white)	1 (6 to 8 oz.)	3 to 4 min.	Pierce with cooking fork. Place in center of the oven. Let stand 5 minutes.
Spinach (fresh)	10 to 16 oz.	5 to 7 min.	In 2-qt. casserole, place washed spinach.
(frozen, chopped and leaf)	10-oz. package	5 to 7 min.	In 1-qt. casserole, place 3 tablespoons water.
Squash (fresh, summer and yellow)	1 lb. sliced	5 to 7 min.	In 1½-qt. casserole, place 1/4 cup water.
(winter, acorn, butternut)	1 to 2 squash (about 1 lb. each)	8 to 11 min.	Cut in half and remove fibrous membranes. In 2-qt. oblong glass baking dish, place squash cut-side-down. Turn cut-side-up after 4 minutes. (Turntable should be turned off.)



Operating Instructions

Time Features

Time Defrost

Allows you to defrost for the length of time you select. See the Defrosting Guide for suggested times.

1. Press AUTO/TIME DEFROST twice.



2. Enter defrosting time.

3. Press START.



4. Turn food over when the oven signals.

5. Press START.

(Auto Defrost explained in the section on Auto Features.)

Power level 3 is automatically set, but you may change this for more flexibility. You may defrost small items more quickly by raising the power level after entering the time. However, they will need more frequent attention than usual.

Power level 7 cuts the total defrosting time in about half; power level 10 cuts the total time to approximately 1/3. Rotate or stir food frequently.

At one half of selected defrosting time, the oven signals TURN. At this time, turn food over and break apart or rearrange pieces for more even defrosting. Shield any warm areas with small pieces of foil.

A dull thumping noise may be heard during defrosting. This sound is normal when the oven is not operating at High power.

Defrosting Tips

- Foods frozen in paper or plastic can be defrosted in the package. Tightly closed packages should be slit, pierced or vented AFTER food has partially defrosted. Plastic storage containers should be at least partially uncovered.
- Family-size, prepackaged frozen dinners can be defrosted and microwaved. If the food is in a foil container, transfer it to a microwave-safe dish.
- Foods that spoil easily, such as milk, eggs, fish, stuffings, poultry and pork, should not be allowed to sit out for more than one hour after defrosting. Room temperature promotes the growth of harmful bacteria.
- For more even defrosting of larger foods, such as beef, lamb and veal roasts, use Auto Defrost.
- Be sure large meats are completely defrosted before cooking.
- When defrosted, food should be cool but softened in all areas. If still slightly icy, return to the microwave very briefly, or let it stand a few minutes.



Operating Instructions

Defrosting Guide

Food	Time	Comments
Breads, Cakes Bread, buns or rolls (1 pc.) Sweet rolls (approx. 12 oz.)	1 min. 3 to 5 min.	
Fish and Seafood Filletts, frozen (1 lb.) Shellfish, small pieces (1 lb.)	6 to 8 min. 5 to 7 min.	Place block in casserole. Turn over and break up after half the time.
Fruit Plastic pouch—1 to 2 (10-oz. package)	3 to 6 min.	
Meat Bacon (1 lb.) Franks (1 lb.) Ground meat (1 lb.) Roast: beef, lamb, veal, pork Steaks, chops and cutlets	2 to 5 min. 2 to 5 min. 5 to 7 min. 12 to 16 min. per lb. 5 to 7 min. per lb.	Place unopened package in oven. Let stand 5 minutes after defrosting. Place unopened package in oven. Microwave just until franks can be separated. Let stand 5 minutes, if necessary, to complete defrosting. Turn meat over after half the time. Use power level 1. Place unwrapped meat in cooking dish. Turn over after half the time and shield warm areas with foil. When finished, separate pieces and let stand to complete defrosting.
Poultry Chicken, broiler-fryer cut up (2½ to 3 lbs.) Chicken, whole (2½ to 3 lbs.) Cornish hen Turkey breast (4 to 6 lbs.)	15 to 19 min. 17 to 21 min. 7 to 13 min. per lb. 5 to 9 min. per lb.	Place wrapped chicken in dish. Unwrap and turn over after half the time. When finished, separate pieces and microwave 2 to 4 minutes more, if necessary. Let stand to finish defrosting. Place wrapped chicken in dish. After half the time, unwrap and turn chicken over. Shield warm areas with foil. Finish defrosting. If necessary, run cold water in the cavity until giblets can be removed. Place unwrapped hen in the oven breast-side-up. Turn over after half the time. Run cool water in the cavity until giblets can be removed. Place unwrapped breast in dish breast-side-down. After half the time, turn over and shield warm areas with foil. Finish defrosting. Let stand 1 to 2 hours in refrigerator to complete defrosting.



Operating Instructions

Time Features

Express Cook



This is a quick way to set cooking time for 1–6 minutes.

Press one of the Express Cook pads (from 1 to 6) for 1 to 6 minutes of cooking at power level 10. For example, press the 2 pad for 2 minutes of cooking time.

The power level can be changed as time is counting down. Press POWER LEVEL and enter 1–10.

Plus 30 Seconds



You can use this feature two ways:

- It will add 30 seconds to the time counting down each time the pad is pressed.
- It can be used as a quick way to set 30 seconds of cooking time.

Operating Instructions

Auto Features

Auto Defrost

Auto Defrost automatically sets the defrosting times and power levels to give even defrosting results for meats, poultry and fish.

1. Press AUTO/TIME DEFROST once.



2. Using the Conversion Guide at right, enter food weight. For example, press pads 1 and 2 for 1.2 pounds (1 pound, 3 ounces).

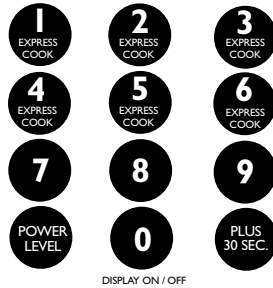

3. Press START.



(Time Defrost is explained in the Time Features section.)

The Auto/Time Defrost feature gives you two ways to defrost frozen foods. Press AUTO/TIME DEFROST once for Auto Defrost or twice for Time Defrost.

Use Auto Defrost for meat, poultry and fish. Use Time Defrost for most other frozen foods.

Conversion Guide

If the weight of food is stated in pounds and ounces, the ounces must be converted to tenths (.1) of a pound.

Weight of Food in Ounces	Enter Food Weight (tenths of a pound)
1-2	.1
3	.2
4-5	.3
6-7	.4
8	.5
9-10	.6
11	.7
12-13	.8
14-15	.9

- Remove meat from package and place on microwave-safe dish.
- Twice during defrost, the oven signals TURN. At each TURN signal, turn the food over. Remove defrosted meat or shield warm areas with small pieces of foil.
- After defrosting, most meats need to stand 5 minutes to complete defrosting. Large roasts should stand for about 30 minutes.

Operating Instructions

Temperature Features

Temperature Probe

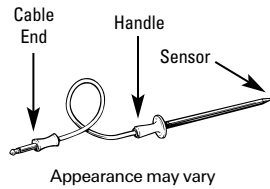

What happens when you use the probe...

Cooking with the probe allows you to heat food to a certain temperature. This is the best way to cook many foods.

The Temperature Probe

NOTE: The turntable will not turn when the probe is in use.

The temperature probe is a food thermometer that monitors the temperature of the food. The probe must be used when using Temp Cook or Roast.

The probe is not recommended for batters, doughs, frozen foods and foods which are difficult to cook precisely by temperature. Use the Cook Time setting for these foods.

- Make sure the cable end is inserted all the way into the oven wall receptacle.
- Insert the probe into the center of the food. Make sure the handle does not touch the food or the top or sides of the oven.
- Do not leave the probe in the oven if it's not inserted in food. If it touches the oven wall, it may damage the oven.

Cooking Tips

- Do not twist, drop or bend the probe.
- Be sure frozen food has been completely defrosted before inserting the probe. The probe may break off if used in frozen foods.
- Cover foods loosely for moisture control and quick, even heating.
- Use a lower power level with the probe; foods will take longer to cook but they will heat more evenly.

Operating Instructions

Temperature Features

Temp Cook/Roast

Three Ways to Use the Temp Cook/Roast Feature

1. You set the temperature you want.



Press TEMP COOK/ROAST once. This is good for foods such as soups, casseroles and beverages.

2. Temperature is automatically selected for cooking roasts medium or well.

Roast Medium—Press TEMP COOK/ROAST twice.

Roast Well—Press TEMP COOK/ROAST three times.

See the Roasting Guide for suggestions.

3. Temperature is automatically selected for slow cooking of foods (simmer).

Simmer—Press TEMP COOK/ROAST 4 times.

See the Simmer Guide for specific directions.

How to Use the Probe and Set the Temperature Yourself

1. Insert the temperature probe in the center of a casserole and attach it securely in the oven wall.



2. Press TEMP COOK/ROAST once.



3. Enter the desired food temperature.

4. Change power level if you don't want full power. (Press POWER LEVEL. Select a power level 1-10.)

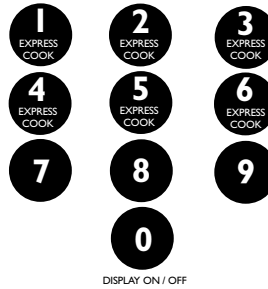

5. Press START.



6. When the temperature is reached, the microwave will signal. Food will be held at this temperature for 60 minutes. The oven beeps when the hold time is complete.

Operating Instructions

Temperature Features

What happens when you use the probe for roasting...

For the two Roast settings, the probe temperature is preprogrammed.

Food will be held at this temperature for 60 minutes. The oven beeps when hold time is complete.

Just as in regular roasting, only tender roasts should be roasted by using the probe. Less tender roasts should be microwaved by time.

How to Use the Probe with the Roast Settings

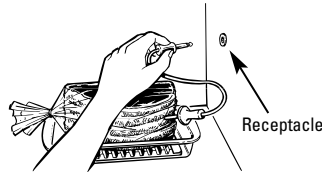

1. Insert the probe in the roast and attach it securely in the oven wall.

2. Roast Medium—Press TEMP COOK/ROAST twice.

Roast Well—Press TEMP COOK/ROAST three times.

3. Press START.

4. The microwave signals when it's time to turn the roast over. After you turn the roast, close the door and press START.

NOTE: The oven continues to cook after the signal whether or not roast is turned over.

Preparing Meats for Roasting

- Place a tender beef roast in a cooking bag on a trivet in a microwave-safe dish. (Refer to package instructions for proper use of the cooking bag.)

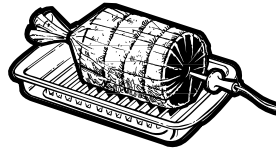

- Insert the probe through the cooking bag horizontally into the center meaty area not touching bone or fat. Make sure the handle does not touch the food or top or sides of the oven.
- When using the probe in chicken, turkey or other poultry, insert the probe horizontally into the meatiest area.

Roasting Guide

Food Type	Doneness Selection	Approx. Time (minutes per pound)
Beef (5 lb. max.) Tender Roast	Medium	15-23
	Well	23-30
Pork (5 lb. max.) Loin Roast	Well	23-30
Poultry (6 lb. max.) Turkey Breast	Well	16-19

Operating Instructions

Temperature Features

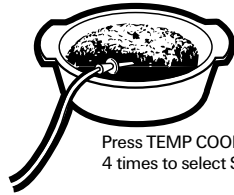

Press TEMP COOK/ROAST 4 times to select Simmer.

How to Use the Probe to Simmer

The Simmer feature heats food to 180°F. and holds it at that temperature up to 12 hours or until you remove it and press CLEAR/OFF.

1. Insert the temperature probe into the food, resting it on the side of the dish. Attach it securely in the oven wall.
2. Press TEMP COOK/ROAST 4 times to select Simmer.
3. Press START. If you need to stir the food, restart the oven by pressing START again.

When the simmer temperature is reached, the oven holds the food at that temperature until CLEAR/OFF is pressed.

Simmer Guide

Food Type	Hours*	Comments
Beef Pot Roast	5-7	Add enough liquid to just cover meat. If adding vegetables, make sure they are completely covered by liquid.
Chili	5-8	Precook meat. Stir after 3 hours, if possible.
Chicken Stewing	4-6	Add 4 cups liquid. Insert probe into meatiest area of thigh from below end and parallel to leg. Turn over after 1/2 of time.
Broiler/Fryer	3-4	Same as above.
Ham/Pork Roast	4-6	Add 4 cups liquid.
Soup Stock/Vegetable	7-10	Make sure that vegetables and meat are covered by liquid. Stir every 3 hours.
Split Pea	5-7	Add enough liquid to cover peas at least 2 inches. Stir after 3 hours.

*Total time includes time to bring food to 180°F. and hold at that temperature until done.



Operating Instructions

Sensor Features

Humidity Sensor

What happens when using the Sensor Features...

The Sensor Features detect the increasing humidity released during cooking. The oven automatically adjusts the cooking time to various types and amounts of food.



Dry off dishes so they don't mislead the sensor.

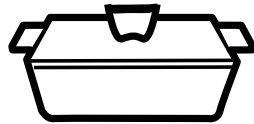

Covered

- The proper containers and covers are essential for best sensor cooking.

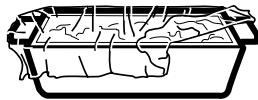

Vented

- Always use microwave-safe containers and cover them with lids or vented plastic wrap. Never use tight sealing plastic containers—they can prevent steam from escaping and cause food to overcook.

- Be sure the outside of the cooking containers and the inside of the microwave oven are dry before placing food in the oven. Beads of moisture turning into steam can mislead the sensor.



Operating Instructions

Sensor Features

Popcorn

How to Use the Popcorn Feature

NOTE: Do not use the metal shelf when cooking popcorn.

1. Follow package instructions, using Cook Time if the package is less than 1.75 ounces or larger than 3.5 ounces. Place the package of popcorn in the center of the microwave.
2. Press POPCORN. The oven starts immediately.

POPCORN

If you open the door while "POPCORN" is displayed, "SENSOR ERROR" will appear. Close the door, press CLEAR/OFF and begin again.

How to Adjust the Popcorn Program to Provide a Shorter or Longer Cook Time

If you find that the brand of popcorn you use underpops or overcooks consistently, you can add or subtract 20–30 seconds to the automatic popping time.

To add time:

After pressing POPCORN, press 9 immediately after the oven starts for an extra 20 seconds.

9

Press 9 again to add another 10 seconds (total 30 seconds additional time).

To subtract time:

After pressing POPCORN, press 1 immediately after the oven starts for 20 seconds less cooking time.



Press 1 again to reduce cooking time another 10 seconds (total 30 seconds less time).

Beverage

BEVERAGE

Press BEVERAGE to heat a cup of coffee or other beverage.

Drinks heated with the Beverage feature may be very hot. Remove the container with care.



Operating Instructions

Sensor Features

Reheat

How to Use the Reheat Feature

For reheating single servings of previously cooked foods or a plate of leftovers.

NOTE: Do not use the metal shelf when using the Reheat feature.

1. Place covered food in the oven. Press REHEAT. The oven starts immediately.

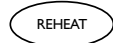

2. The oven signals when steam is sensed and the time remaining begins counting down.

Do not open the oven door until time is counting down. If the door is opened, close it and press START immediately.

After removing food from the oven, stir, if possible, to even out the temperature. If food is not hot enough, use Cook Time to reheat for more time. Reheated foods may have wide variations in temperature. Some areas may be extremely hot.

How to Change the Automatic Settings

To reduce time by 10%:

Press 1 after the feature pad.



To add 10% to cooking time:

Press 9 after the feature pad.



Some Foods Not Recommended For Use With Reheat

It is best to use Cook Time for these foods:

- Bread products.
- Foods that must be reheated uncovered.
- Foods that need to be stirred or rotated.
- Foods calling for a dry look or crisp surface after reheating.



Operating Instructions

Sensor Features

Sensor Cooking

Vegetable, Potato, Ground Meats

Sensor Cooking gives you easy automatic results with a variety of foods.

NOTE: Do not use the metal shelf with Sensor Cooking.

1. Place covered food in the oven. Press the food pad. (For vegetables, press the VEGETABLE pad once for fresh vegetables, twice for frozen vegetables, or three times for canned vegetables.) The oven starts immediately.



2. The oven signals when steam is sensed and time remaining is counting down. Turn or stir the food if necessary.

Do not open the oven door until time is counting down. If the door is opened, close it and press START immediately.

NOTE: If the food is not done enough, use Cook Time to cook for more time.

How to Change the Automatic Settings (automatic settings for canned vegetables cannot be adjusted on some models)

You can adjust the cooking time for all foods to suit your personal taste.

Reduce time by 10%:
Press 1 after the food pad.



Add 10% to cooking time:
Press 9 after the food pad.



Cooking Guide

Food Type	Amount	Comments
Canned Vegetables	4-16 oz.	Cover with lid or vented plastic wrap.
Frozen Vegetables	4-16 oz.	Follow package instructions for adding water. Cover with lid or vented plastic wrap.
Fresh Vegetables	4-16 oz.	Add 1/4 cup water per serving. Cover with lid or vented plastic wrap.
Potato	1/2-2 lbs.	Pierce skin with fork. Place potatoes on the turntable.
Ground Meats (Beef, Pork, Turkey)	1/2-3 lbs.	Use round casserole dish. Crumble meat into dish. Cover with lid or vented plastic wrap. Drain and stir at signal.



Operating Instructions

Other Features

Cooking Complete Reminder

To remind you that you have food in the oven, the oven will display “FOOD IS READY” and beep once a minute until you either open the oven door or press CLEAR/OFF.

Display On/Off



DISPLAY ON / OFF

To turn the clock display off, press and hold 0 for about three seconds.

To redisplay the clock, repeat.

Clock

Press to enter the time of day or to check the time of day while microwaving.

1. Press CLOCK.



2. Enter time of day.

3. Select AM or PM.



4. Press START or CLOCK.

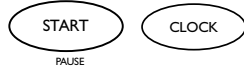

Start/Pause

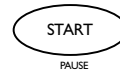

In addition to starting many functions, START/PAUSE allows you to stop cooking without opening the door or clearing the display.

Scroll Speed



The scroll speed of the display can be changed. Press and hold the AM/PM pad about 3 seconds to bring up the display. Select 1-5 for slow to fast scroll speed.



Operating Instructions

Other Features

Delay Start

Delay Start allows you to set the microwave to delay cooking up to 24 hours.

1. Press DELAY START.



2. Enter the time you want the oven to start. (Be sure the microwave clock shows the correct time of day.)

3. Select AM or PM.



4. Select any combination of Auto/Time Defrost or Cook Time I & II.

5. Press START.



The Delay Start time will be displayed plus "DS." The oven will automatically start at the delayed time.

The time of day may be displayed by pressing CLOCK.

Surface Light



Press SURFACE LIGHT **once** for bright light, **twice** for the night light or **three** times to turn the light off.

Timer On/Off

Timer On/Off operates as a minute timer and can be used at any time, even when the oven is operating.

1. Press TIMER ON/OFF.



2. Enter time you want to count down.

3. Press TIMER ON/OFF to start.



When time is up, the oven will signal. To turn off the timer signal, press TIMER ON/OFF.

NOTE: The timer indicator will be lit while the timer is operating.

Beeper Volume



The beeper sound level can be adjusted. Press BEEPER VOLUME. Choose 0–3 for mute to loud.



Operating Instructions

Other Features

Reminder

The Reminder feature can be used like an alarm clock and can be used at any time, even when the oven is operating. The Reminder time can be set up to 24 hours later.

1. Press REMINDER.



2. Enter the time you want the oven to remind you. (Be sure the microwave clock shows the correct time of day.)

3. Select AM or PM.



4. Press REMINDER. When Reminder signal occurs, press REMINDER to turn it off. The Reminder time may be displayed by pressing REMINDER.



NOTE: The REM indicator will remain lit to show that the Reminder is set. To clear the Reminder before it occurs, press REMINDER, then 0. The REM indicator will no longer be lit.

Child Lock-Out



You may lock the control panel to prevent the microwave from being accidentally started or used by children.

To lock or unlock the controls, press and hold CLEAR/OFF for about three seconds. When the control panel is locked, an “L” will be displayed to the extreme right.

Turntable



For best cooking results, leave the turntable on. It can be turned off for large dishes. Press TURNTABLE to turn the turntable on or off.

Sometimes the turntable can become too hot to touch. Be careful touching the turntable during and after cooking.



Operating Instructions

Other Features

Exhaust Fan



The exhaust fan removes steam and other vapors from surface cooking.

Press EXHAUST **once** for high fan speed, **twice** for low fan speed or a **third** time to turn the fan off.

Automatic Fan

An automatic fan feature protects the microwave from too much heat rising from the cooktop below it. It automatically turns on at low speed if it senses too much heat.

If you have turned the fan on you may find that you cannot turn it off. The fan will automatically turn off when the internal parts are cool. It may stay on for 30 minutes or more after the cooktop and microwave controls are turned off.

Auto Nite Light

You can set the night light to turn on and off automatically at any time you want.

1. Press AUTO NITE LIGHT.



2. Enter the time you want the light to turn on. Select AM or PM.



3. Press AUTO NITE LIGHT again and enter the time you want the light to turn off. Select AM or PM.

4. Press AUTO NITE LIGHT.

NITE will stay lit to remind you that the feature is set. You can review the Auto Nite Light settings by pressing AUTO NITE LIGHT.

To erase your settings and turn off the automatic feature, press AUTO NITE LIGHT, then 0.

0



Feature Information

Two Position Shelf

Microwaving with the Shelf

- Make sure the shelf is positioned properly inside the microwave to prevent damage to the oven from arcing.
- Do not use a microwave browning dish on the shelf. The shelf could overheat.
- Do not cook with the shelf on the microwave floor. This could damage the microwave.
- Use pot holders when handling the shelf—it may be hot.
- Do not use the shelf when cooking popcorn.
- Do not use the shelf with Sensor Cooking or Reheat.

How to Use the Shelf When Microwaving



Food microwaves best when placed on the turntable or on the shelf in the lower position.

For best cooking results, remove the shelf unless you are cooking on two levels.

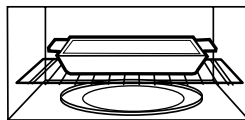

For best results

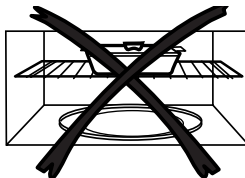

Uneven results

The lower position provides a flat surface for placing dishes that may tilt if placed on the turntable.

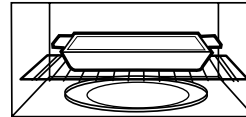

The lower position also allows you to place 2 dishes side-by-side. This is helpful for casseroles or other cookware that may be too tall to cook on two levels.

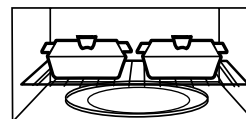

The upper position gives you the option to reheat or cook more than one dish of food at the same time.

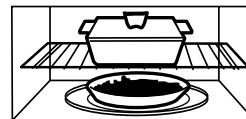

2-level cooking



Feature Information

Two Position Shelf

Cooking and Reheating

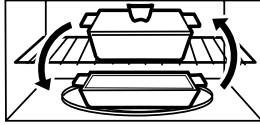

Switch places after 1/2 time.

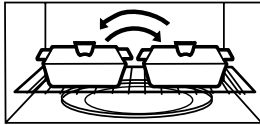

Switch places after 1/2 time.

- To cook on 2 levels

or

- To cook 2 dishes on the lower level:

- 1 Double the cooking time.
- 2 Switch places after 1/2 the time and give dishes 1/2 turn. (Place dense foods, or those that require a longer cook time, on the shelf first.)

- To reheat on 2 levels

or

- To reheat 2 dishes on the lower level:

- 1 Multiply reheat time by 1½.
- 2 Switch places after 1/2 the time.



Feature Information

Microwave Terms

Term	Definition
Arcing	<p>Arcing is the microwave term for sparks in the oven. Arcing is caused by:</p> <ul style="list-style-type: none"> • the temperature probe staying in the oven but not inserted in the food. • the metal shelf being installed incorrectly and touching the microwave walls. • metal or foil touching the side of the oven. • foil that is not molded to food (upturned edges act like antennas). • metal such as twist ties, poultry pins, gold-rimmed dishes. • recycled paper towels containing small metal pieces.
Covering	<p>Covers hold in moisture, allow for more even heating and reduce cooking time. Venting plastic wrap or covering with wax paper allows excess steam to escape.</p>
Shielding	<p>In a regular oven, you shield chicken breasts or baked foods to prevent over-browning. When microwaving, you use small strips of foil to shield thin parts, such as the tips of wings and legs on poultry, which would cook before larger parts.</p>
Standing Time	<p>When you cook with regular ovens, foods such as roasts or cakes are allowed to stand to finish cooking or to set. Standing time is especially important in microwave cooking. Note that a microwaved cake is not placed on a cooling rack.</p>
Venting	<p>After covering a dish with plastic wrap, you vent the plastic wrap by turning back one corner so excess steam can escape.</p>



Care and Cleaning

Helpful Hints



Open the oven door a few minutes after cooking to air out the inside. An occasional thorough wiping with a solution of baking soda and water keeps the inside fresh.

NOTE: Be certain the power is off before cleaning any part of this oven.

How to Clean the Inside

Walls, Floor, Inside Window, Metal and Plastic Parts on the Door

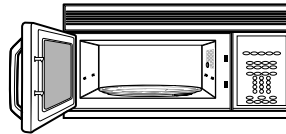

Some spatters can be removed with a paper towel, others may require a damp cloth. Remove greasy spatters with a sudsy cloth, then rinse with a damp cloth. Do not use abrasive cleaners or sharp utensils on oven walls. **Never use a commercial oven cleaner on any part of your microwave.**

Removable Turntable and Turntable Support

To prevent breakage, do not place the turntable into water just after cooking. Wash it carefully in warm, sudsy water or in the dishwasher. The turntable and support can be broken if dropped. Remember, do not operate the oven without the turntable and support in place.

Temperature Probe

Clean immediately after using. To clean, wipe with sudsy cloth, then rub lightly with plastic scouring ball if necessary. Rinse and dry. The probe can also be washed in the dishwasher.

Shelf

Clean with mild soap and water or in the dishwasher. **Do not clean in a self-cleaning oven.**



Care and Cleaning

How to Clean the Outside

Do not use cleaners containing ammonia or alcohol on the microwave oven. Ammonia or alcohol can damage the appearance of the microwave.

Case

Clean the outside of the microwave with a sudsy cloth. Rinse and then dry. Wipe the window clean with a damp cloth.

Control Panel and Door

Wipe with a damp cloth. Dry thoroughly. Do not use cleaning sprays, large amounts of soap and water, abrasives or sharp objects on the panel—they can damage it. Some paper towels can also scratch the control panel.

Door Surface

It's important to keep the area clean where the door seals against the microwave. Use only mild, non-abrasive detergents applied with a clean sponge or soft cloth. Rinse well.

Bottom

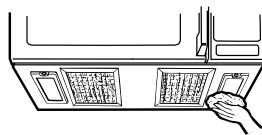

Clean off the grease and dust on the bottom often. Use a solution of warm water and detergent.

Stainless Steel (on some models)

To clean the surface use hot soapy water, then rinse and dry. Do not use steel wool pads or other abrasive cleaners. They will scratch the surface.



Care and Cleaning

Cooktop Light/Night Light

Replace the burned-out bulb with a 40-watt incandescent bulb (WB36X10003), available from your Frigidaire supplier.

1. To replace the bulb(s), first disconnect the power at the main fuse or circuit breaker panel or pull the plug.
2. Remove the screw at the front of the light cover and lower the cover.

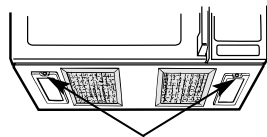

REMOVE SCREWS

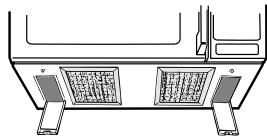

3. Be sure the bulb(s) to be replaced are cool before removing. After breaking the adhesive seal, remove the bulb by gently turning.
4. Replace the screw. Connect electrical power to the oven.

Oven Light

Replace the burned-out bulb with a 40-watt incandescent bulb (WB36X10003), available from your Frigidaire supplier.

1. To replace the oven light, first disconnect the power at the main fuse or circuit breaker panel or pull the plug.
2. Remove the top grille by taking out the 2 screws that hold it in place.

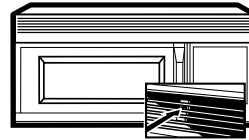

3. Next, remove the screw located above the door near the center of the oven that secures the light housing.

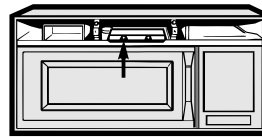

4. Replace the screw. Connect electrical power to the oven.



Care and Cleaning

The Exhaust Feature

The Exhaust Fan

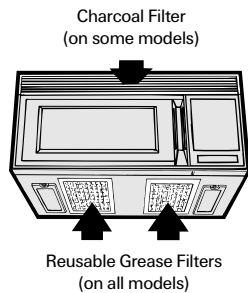

The exhaust fan has 2 metal reusable grease filters.

Models that recirculate air back into the room also use a charcoal filter.

Reusable Grease Filters

The metal filters trap grease released by foods on the cooktop. They also prevent flames from foods on the cooktop from damaging the inside of the microwave.

For this reason, the filters must ALWAYS be in place when the hood is used. The grease filters should be cleaned once a month, or as needed.

Removing and Cleaning the Filter

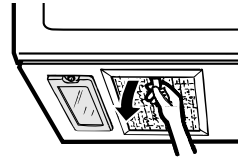

To remove, slide it to the rear using the tab. Pull it down and out.

To clean the grease filter, soak it and then swish it around in hot water and detergent. Don't use ammonia or ammonia products because they will darken the metal.

Light brushing can be used to remove embedded dirt.

Rinse, shake and let it dry before replacing.

To replace, slide the filter in the frame slot on the back of the opening. Pull up and to the front to lock into place.



Care and Cleaning The Exhaust Feature

Charcoal Filter (on some models)

**The charcoal filter cannot be cleaned.
It must be replaced. Order part No.
WB02X9883 from your Frigidaire supplier.**

If the model is not vented to the outside, the air will be recirculated through a disposable charcoal filter that helps remove smoke and odors.

The charcoal filter should be replaced when it is noticeably dirty or discolored (usually after 6 to 12 months, depending on hood usage).

To Install Charcoal Filter

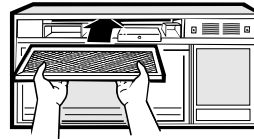

To install a new filter, remove plastic and other outer wrapping from the new filter.

Insert the filter into the top opening of the oven as shown. It will rest at an angle on 2 side support tabs and in front of the right rear tab. Replace the grille and 2 screws.

To Remove Charcoal Filter

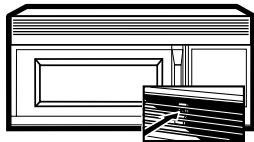

Remove 2 grille screws to
remove the grille.

To remove the charcoal filter, disconnect power at the main fuse or circuit breaker panel or pull the plug.

Remove the top grille by removing the 2 screws that hold it in place. Slide the filter towards the front of the oven and remove it.



Troubleshooting Before You Call For Service...

Troubleshooting Tips

Save time and money! Review this list first and you may not need to call for service.

"BAD PROBE" appears in the display?

The probe has not been completely inserted into the wall receptacle. Insert the probe properly into the wall receptacle.

The probe is defective. Replace the probe.

Floor of the oven is warm, even when the oven has not been used?

The cooktop light is located below the oven floor. When the light is on, the heat it produces may make the oven floor get warm. This is normal.

Food amount is too large for Sensor Reheat?

Sensor Reheat is for single servings of recommended foods. Use Cook Time for large amounts of food.

"LOCKED" appears in the display?

The control has been locked. Press and hold CLEAR/OFF for about 3 seconds to unlock the control.

Oven will not start?

A fuse in your home may be blown or the circuit breaker tripped. Replace fuse or reset circuit breaker.

Power surge. Unplug the microwave oven, then plug it back in.

Plug not fully inserted into wall outlet. Make sure the 3-prong plug on the oven is fully inserted into wall outlet.

"PLEASE INSERT PROBE" appears in the display?

Probe has been forgotten or not inserted properly. Insert the probe properly into the wall receptacle.



Troubleshooting Before You Call For Service...

“SENSOR ERROR” appears in the display?

When using a Sensor feature, the door was opened before steam could be detected. Do not open door until steam is sensed and time is shown counting down on display.

Steam was not detected in maximum amount of time. Use Cook Time to heat for more time.

You hear an unusual, low-tone beep?

You have tried to start the Reminder without a valid time of day. Start over and enter a valid time of day.

You have tried to start the Auto Nite Light without a valid time of day entered for the on-time and off-time. Start over and enter a valid time of day.

You have tried to turn the turntable on when the probe is in use. The turntable will not operate when the probe is in use.

You have tried to change the power level when it is not allowed. Many of the oven's features are preset and cannot be changed.

Things That Are Normal

- Steam or vapor escaping from around the door.
- Light reflection around door or outer case.
- Dimming oven light and change in the blower sound at power levels other than high.
- Dull thumping sound while oven is operating.
- TV-radio interference might be noticed while using the microwave. Similar to the interference caused by other small appliances, it does not indicate a problem with the microwave. Plug the microwave into a different electrical circuit, move the radio or TV as far away from the microwave as possible, or check the position and signal of the TV/radio antenna.



**Consumer Services
WARRANTY**

MICROWAVE WARRANTY (USA Only)

Your microwave is protected by this warranty

	WARRANTY PERIOD	FRIGIDAIRE, THROUGH ITS AUTHORIZED SERVICERS, WILL:	THE CONSUMER WILL BE RESPONSIBLE FOR:
FULL ONE-YEAR WARRANTY	One year from original purchase date.	Pay all costs for repairing or replacing any parts of this appliance which prove to be defective in materials or workmanship.	Costs of service calls that are listed under NORMAL RESPONSIBILITIES OF THE CONSUMER.*
LIMITED 2ND YEAR WARRANTY (Microwave Oven)	Two years from original purchase date.	Repair or replace any part of the microwave oven which proves to be defective in materials or workmanship.	Cost of shipping the replacement part to the nearest authorized servicer; and all labor and service charges.
LIMITED 2ND-10TH YEAR WARRANTY (Magnetron Tube)	Second through tenth years from original purchase date.	Provide a replacement for any magnetron tube which proves to be defective in workmanship or material.	Cost of shipping the replacement part to the nearest authorized servicer; and all labor and service charges.
LIMITED WARRANTY (Applicable to the State of Alaska)	Time periods listed above.	All of the provisions of the full warranties above and the exclusions listed below apply.	Costs of the technician's travel to the home and any costs for pick up and delivery of the appliance required because of service.

Your appliance is warranted by White Consolidated Industries, Inc. We authorize no person to change or add to any of our obligations under this warranty. Our obligations for service and parts under this warranty must be performed by Frigidaire or an authorized Frigidaire servicer.

***Keep your bill of sale, delivery slip or some other appropriate payment record.
The date on the bill establishes the warranty period should service be required.***



Consumer Services

WARRANTY (Continued)

*** NORMAL RESPONSIBILITIES OF THE CONSUMER**

This warranty applies only to products in ordinary household use, and the consumer is responsible for the items listed below:

1. Proper use of the appliance in accordance with instructions provided with the product.
2. Proper installation by an authorized servicer in accordance with instructions provided with the appliance and in accordance with all local plumbing, electrical and/or gas codes.
3. Proper connection to a grounded power supply of sufficient voltage, replacement of blown fuses, repair of loose connections or defects in house wiring.
4. Expenses for making the appliance accessible for servicing, such as removal of trim, cupboards, shelves, etc., which are not a part of the appliance when it was shipped from the factory.
5. Damages to finish after installation.
6. Replacement of light bulbs and/or fluorescent tubes (on models with these features).

EXCLUSIONS

This warranty does not cover the following:

1. CONSEQUENTIAL OR INCIDENTAL DAMAGES SUCH AS PROPERTY DAMAGE AND INCIDENTAL EXPENSES RESULTING FROM ANY BREACH OF THIS WRITTEN OR ANY IMPLIED WARRANTY.
Note: Some states do not allow the exclusion or limitation of incidental or consequential damages, so this limitation or exclusion may not apply to you.
2. Service calls which do not involve malfunction or defects in workmanship or material, or for appliances not in ordinary household use. The consumer shall pay for such service calls.
3. Damages caused by services performed by servicers other than Frigidaire or its authorized servicers; use of parts other than genuine Frigidaire Home Products parts; obtained from persons other than such servicers; or external causes such as abuse, misuse, inadequate power supply or acts of God.
4. Products with original serial numbers that have been removed or altered and cannot be readily determined.



Consumer Services

IF YOU NEED SERVICE

Keep your bill of sale, delivery slip, or some other appropriate payment record. The date on the bill establishes the warranty period should service be required. If service is performed, it is in your best interest to obtain and keep all receipts. This written warranty gives you specific legal rights. You may also have other rights that vary from state to state. Service under this warranty must be obtained by contacting Frigidaire Home Products:

800•944•9044

Frigidaire Home Products
P.O. Box 212378
Augusta, GA 30917



Product features or specifications as described or illustrated are subject to change without notice. All warranties are made by White Consolidated Industries, Inc. This warranty applies only in the 50 states of the U.S.A. and Puerto Rico.

Visit Frigidaire Home Products' Web Site at
<http://www.frigidaire.com>

Part No. 164D3370P065 Rev. 1
Pub. No. 49-40065-1

Printed in Korea

44

FMT148

9-00 JR