

Haier

PORTABLE AIR CONDITIONER
CLIMATISEUR PORTATIF
ACONDICIONADOR DE AIRE PORTATIL

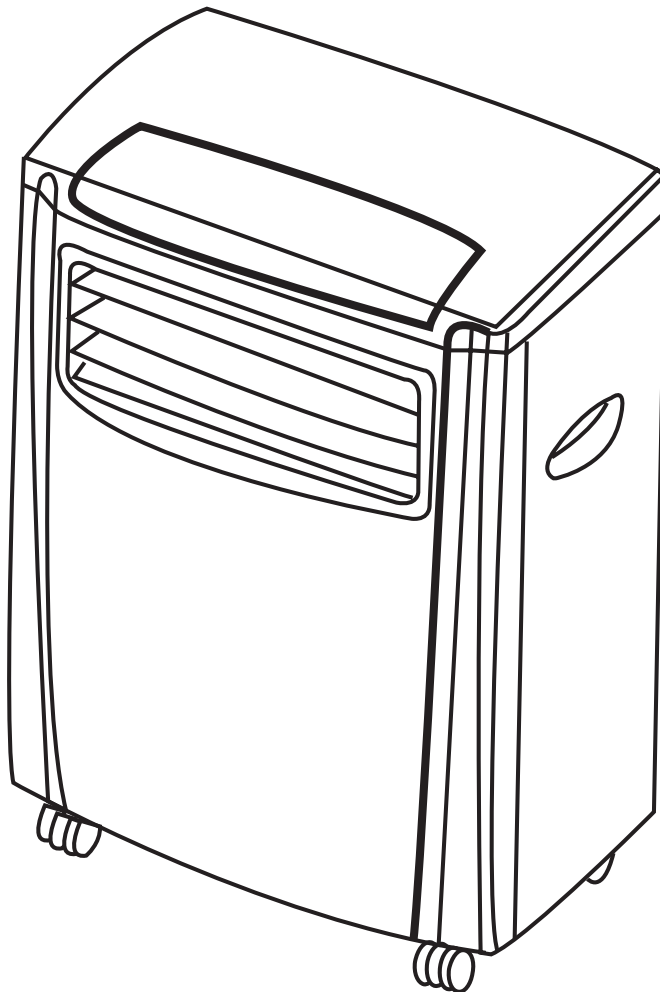

Model#

Modèle#

Modelo#

HPAC90E

A Word From Haier

Thank You for buying a dependable, energy saving and easy to operate HAIER air conditioner. This manual contains useful information for you to maintain, operate, install and safely use your air conditioner. Your air conditioner cleans, cools and dehumidifies the air in your room to provide you with the ultimate level of comfort.

Please read instructions carefully before using the product. Also, do not forget to fill out and mail the **Product Registration Card**.

Product Registration

Record Your Model and Serial Number.

For all your service calls during the warranty period the following information will be needed. Attach the sales receipt to this guide and keep for future reference. This information can be obtained from the serial plate, which is on your air conditioner.

Model Number:





Serial Number:

Date of Purchase:

Dealer's Name:

Dealers Address:

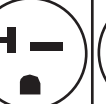
Dealers Phone Number:

TABLE					
RECEPTACLE AND FUSE TYPES					
RATED VOLTS	125/60		250/60		
AMPS	15	20	15	20	30
WALL OUTLET					
FUSE SIZE	15	20*	15	20*	30
TIME DELAY FUSE (or circuit breaker)	Plug	Plug	Plug		

SAFETY PRECAUTIONS

WARNING: *Following these basic precautions will reduce the risk of fire, electrical shock, injury or death when using your air conditioner.*



- 1) Air conditioner must be connected to proper electrical outlet with the correct electrical supply. (see table)
- 2) Proper grounding must be ensured to reduce the risk of shock and fire. **DO NOT CUT OR REMOVE THE GROUNDING PRONG.** If you do not have a three-prong electric receptacle outlet in the wall, have a certified electrician install the proper receptacle. The wall receptacle **MUST** be properly grounded.
- 3) Do not operate air conditioner if power cord is frayed or otherwise damaged. Also avoid using it if there are cracks or abrasion damage along the length, plug connector or if the unit malfunctions or is damaged in any manner. Contact an authorized service for examination, repairs or adjustments.
- 4) **DO NOT USE AN ADAPTER OR AN EXTENSION CORD.**
- 5) Do not block airflow around the air conditioner. Also the exhaust hose should be free of any obstructions.
- 6) Always unplug the air conditioner before servicing it or moving it.
- 7) Do not install or use the air conditioner in any area where the atmosphere contains combustible gases or where the atmosphere is oily or sulphurous. Avoid any chemicals coming in contact with your air conditioner.
- 8) Do not place any object on the top of the unit.
- 9) Never operate the air conditioner without the filters in place.
- 10) Do not use the air conditioners near a bathtub, shower or wash basin.

Table Of Contents

	PAGE
A Word From Haier.....	1
Product Registration.....	1
Safety Precautions.....	2
Advantages.....	4
Parts and Features.....	5
Assembly and Installation.....	6
Operation.....	7
Product Specification.....	7
Care and Cleaning.....	8
Storage.....	8
Trouble Shooting.....	9
Warranty Information.....	10

Advantages of this Model

1. This model is easy to operate. The manual control panel has a timer, thermostat, two speed cooling speeds and two fan speeds.
2. This portable air conditioner does not require water to be added.
3. The unit has a unique design which evaporates the water. Therefore no condensation tank is necessary, thus avoiding you to have to wake up in the middle of the night to empty the bucket and turn on the unit.
4. Easy to install window kit is included which consists of the exhaust duct, exhaust hose, hose nozzle and the window panel kit.
5. Full directional adjustable casters are included to help to move the unit to be conveniently used in almost any area.
6. The filter screen is designed for easy cleaning and is easily accessible.
7. Portable air conditioners are easy to store when not in use.

Parts and Features

FRONT

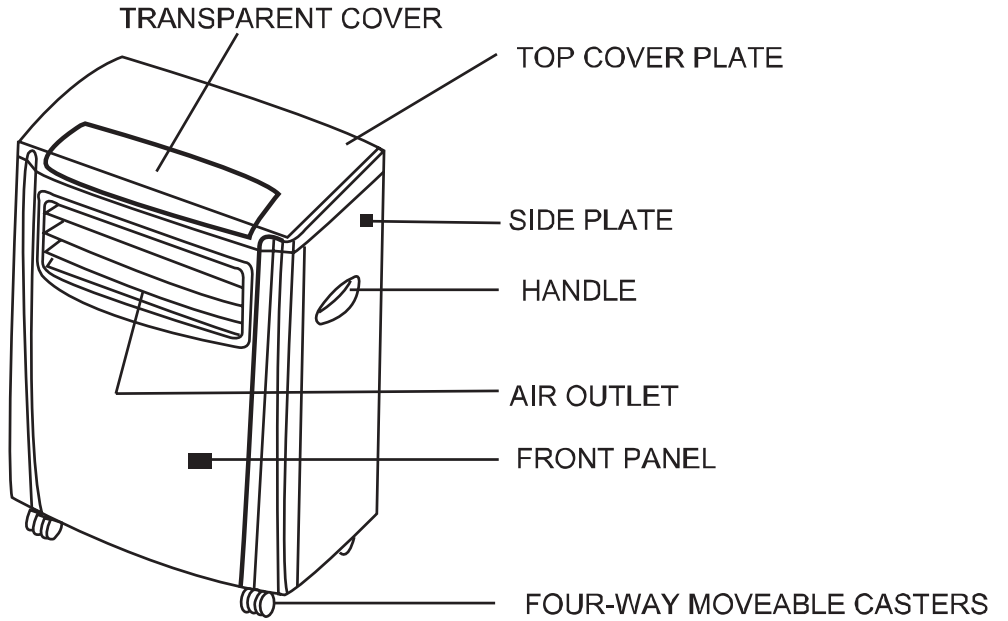

REAR

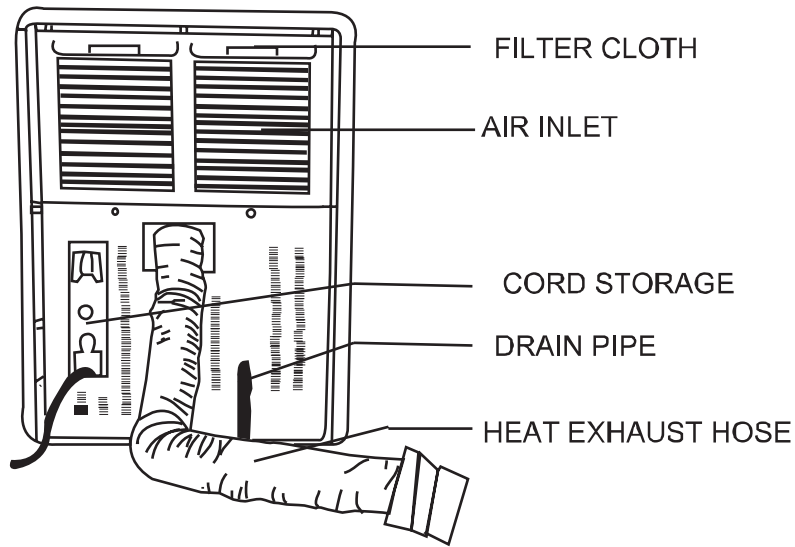

Description of Control Panel

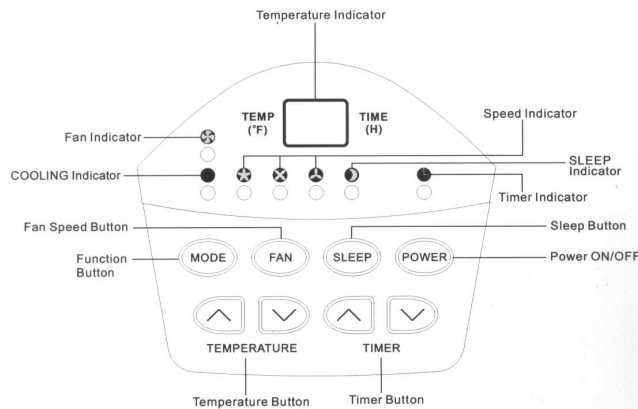

Assembly and Installation

A. Connect exhaust hose to the back of the unit. Extend hose to desired length and connect with window kit.

USING EXHAUST DUCT SET

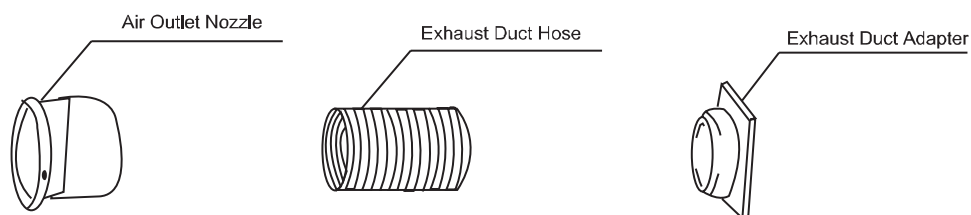

1. Insert ends of Exhaust hose into air outlet nozzle and Exhaust duct "A" by twisting until it stops.
2. Fix the Exhaust duct "A" to the exhaust outlet on the rear of the unit. This is achieved by sliding the appropriate connector downwards over the exhaust outlet ensuring that the lugs on the outlet are engaged with the grooves on the connector.
3. Extend the Exhaust hose and close the Window as far as possible trapping the air outlet nozzle.

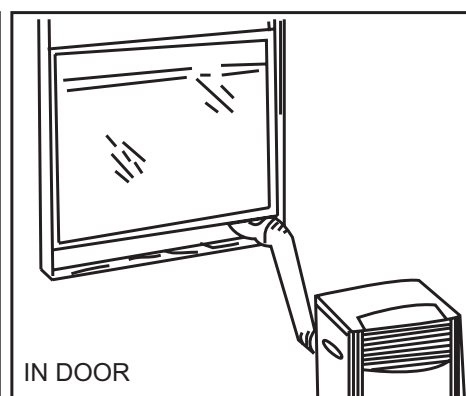
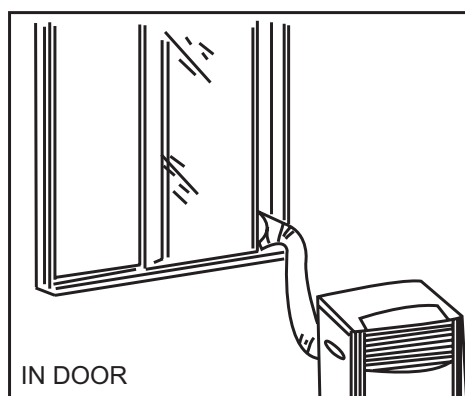
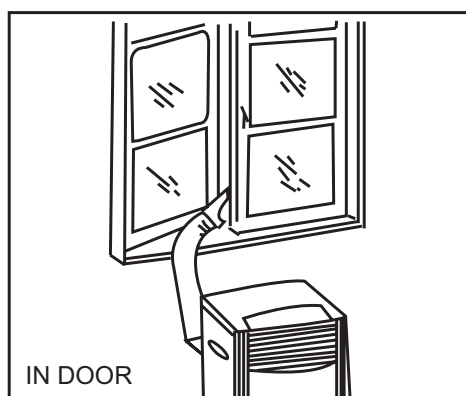
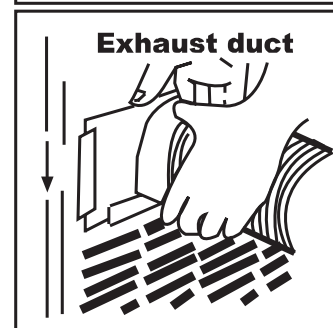
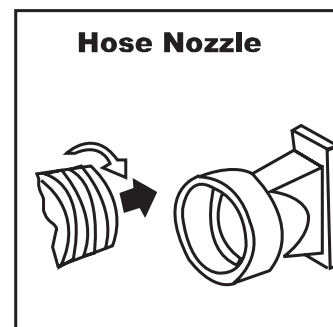

USING WINDOW PANEL KIT

1. Plastic panel - 1 piece
2. Nozzle Fitting - 1 piece
3. Screws - 4 pieces

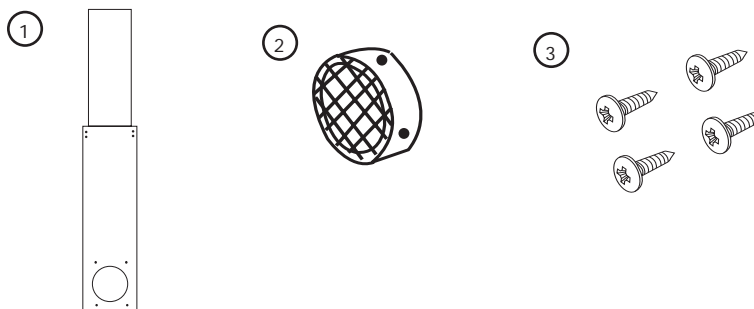

Operation

1. Wait 20 minutes before starting the unit to assure that the coolant has leveled off.
2. **Wait 3 minutes** before restarting the unit after a normal shutdown so as to complete the compressor cycle.
3. Use an 115 volt 20 amp outlet for the air conditioner. Do not use any other electrical appliances on this line or you may trip the fuse. Dedicate the electric line for the air conditioner alone.
4. Do not place the air conditioner in direct sunlight or close to any heating appliances. eg. baseboard heaters, stoves, etc.
5. Operate the unit on a flat surface only.
6. Check the filter at least once a month in order to achieve highest cooling efficiency.
7. If the unit is not being used for a long period of time, please remove the plug to drain pipe and drain out any condensed water.

Product Specification

Voltage and Frequency	115V / 60Hz
Input Power	950 W
Cooling Capacity	9000 BTU
Moisture Removal (pints/hr)	2.60
Coolant	R22
Timer	8 Hours
Operating Temperature Range	64.4° F - 100° F
Unit Dimensions (WxDxH) (inches)	20 1/4 x 13 13/32 x 29 13/16
Net Weight lbs. approximate	71.5 lbs.

Care and Cleaning Guide

- Always unplug your air conditioner before cleaning.
- Air filter needs to be cleaned at least once a month for your unit to operate at optimum efficiency. The filter can be slid out from the back by pulling on the tab. The filter may be washed or vacuumed. Remove the excess water from the filter by gently shaking the filter. This will remove dust and particles trapped in the filter. After cleaning, reinstall the filter. **DO NOT** use your air conditioner without the air filter in place.
- To clean the cabinet **DO NOT** use harsh chemicals, abrasives, ammonia, chlorine, bleach, concentrated detergents, solvents or metal scouring pads. Some of these chemicals may dissolve, damage and/or discolor your air conditioner.
- Always use a soft cloth dampened with water or mild soap and water solution to wipe the front of the cabinet. Wipe dry with a soft cloth.

Storage

- To store your air conditioner when not being used for a long period of time, drain condensed water using the drain pipe. Remove exhaust hose, clean filters, cover with plastic bag and store away.

Trouble-Shooting

If air conditioner does not operate:

- Check if unit is plugged in. The plug may have come loose.
- Check if the electrical wall receptacle is of proper voltage.
- Check if the circuit breaker needs to be reset or if the fuse needs to be replaced.
- Check if the unit is in "Off" mode.
- The fan control may be in "Off" position.

Air conditioner working but room not cooling:

- Room may have appliances that produce heat. Use an exhaust fan to remove excess heat.
- Check exhaust hose for proper installation.
- Redirect the airflow. Remove any obstacles.
- All doors and windows need to be closed so cool air does not escape the room.
- Air filter may be blocked or may need cleaning.
- Unit BTU may be too low for the required cooling area.
- On extreme hot & humid days air conditioners may take a little longer to cool.

Limited Warranty

This warranty covers all defects in workmanship or materials for:

1. The mechanical and electrical parts (including labor costs) contained in this Haier product, for a period of 12 months, from the date of purchase, (commercial or rental application, the warranty is 90 days).
2. The sealed system and compressor contained in this Haier product is for a period of 5 years, from the date of purchase (excluding labor costs after the initial 12 month period). In commercial or rental use, the additional limited compressor warranty is for 1 year and 9 months, (excluding labor costs after the initial 90 days period).

You must keep and be able to provide your original sales receipt as proof of the date of purchase.

Who is covered?

The original retail purchaser of this Haier product.

What will be done?

Haier will repair or replace, in your home, any mechanical, electrical part or the compressor, which proves defective in normal household, use for a period of 12 months. Haier will repair or replace (excluding labor costs) the sealed system and compressor (parts only) for an additional 4 year period.

How can you get service?

1. Contact your nearest Haier authorized Service Depot. For the name of the Service Depot nearest you, contact Haier at (877) 337-3639.
2. All service must be performed, by an authorized Haier Service Depot.

THIS WARRANTY COVERS UNITS WITHIN THE CONTINENTAL UNITED STATES, CANADA AND PUERTO RICO AND DOES NOT COVER:

- Damages from improper installation
- Damages in shipping
- Damages from misuse, abuse, accident, alteration, lack of proper care and maintenance
- Damages from service, by other than an authorized dealer or service center
- Labor, service, transportation and shipping charges for the removal of defective parts and installation of a replacement part, beyond the initial 12 month period.

THIS LIMITED WARRANTY IS GIVEN IN LIEU OF ALL OTHER WARRANTIES, EXPRESS OR IMPLIED, INCLUDING THE WARRANTIES OF MERCHANTABILITY AND FITNESS FOR A PARTICULAR PURPOSE.

The remedy provided in this warranty is exclusive and is granted in lieu of all other remedies. This warranty does not cover incidental or consequential damages. Some states do not allow the exclusion of incidental or consequential damages, so this limitation may not apply to you. Some states do not allow limitations on how long an implied warranty lasts, so this limitation may not apply to you. This warranty gives you specific legal rights, and you may also have other rights, which vary from state to state.