

XQJ100-96

Automatic Washing Machine



- Please read this manual carefully before using.
- Please retain it attentively for future reference.

Contents

Before using

- Names of the parts.....the 2nd cover
- Safety precautions1
- Installation and adjustment3
- Installation the water inlet hose.....4
- Temperature & hardness of water5
- Wash cycle and sound.....6

Using process

- Preparation before washing7
- Put in the laundries8
- Put in the detergent9
- Close the top lid9
- Select water level.....10
- Select temperature.....10
- Select program.....10
- Finish washing11
- Disposal after washing11

Trouble shooting

- *Answer to question.....12

- Packing list**13

- After-sales service**.....13

- Specification**.....the back cover

Names of the parts

Honorable users,

Thanks for your choosing Haier products.



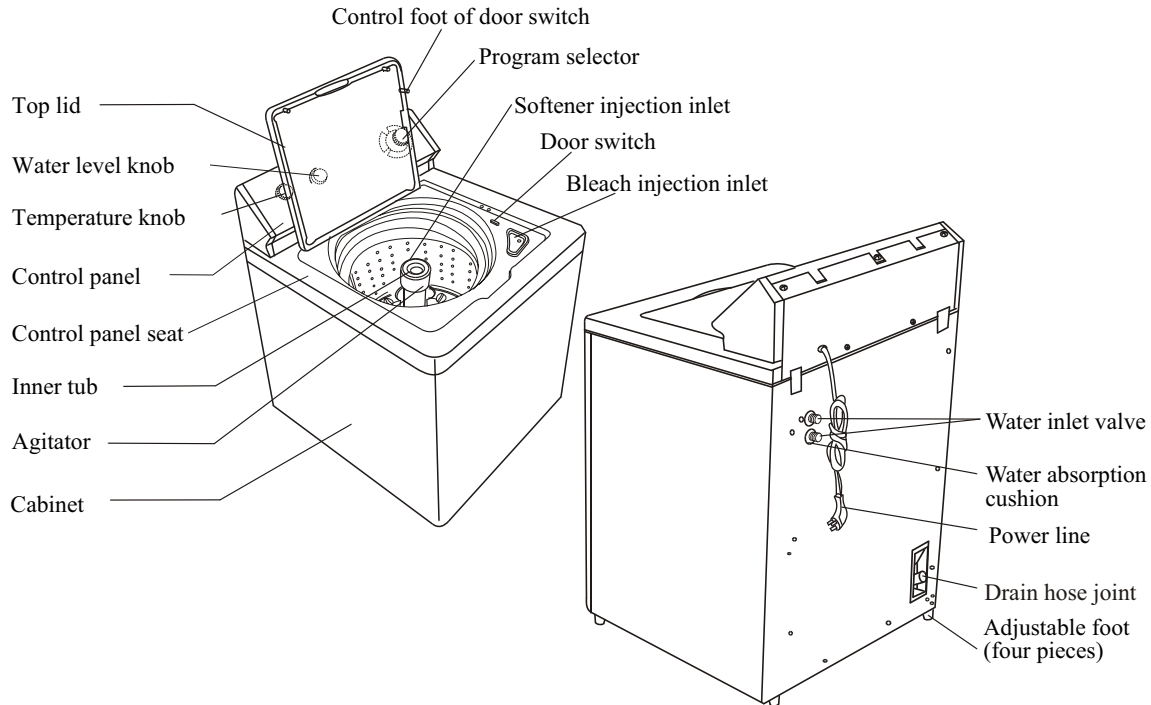

Haier products integrate high-tech, precision frontier science and possess the best quality among similar products. To facilitate your operation, please read the manual carefully and operate this machine according to it.

Haier's star-level service is always accompanying you. No matter what problems you meet in use please do not hesitate to contact us by the telephone number and address on the certificate of warranty. We are at your service all the time.



Thanks again for your choosing and introducing Haier products.
Haier-sincere forever!

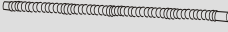

Accessories

	Water inlet hose (two)
	Drain hose hook (one)
	Drain hose clamp (one)
	Outer drain hose component (one)
	Flat water inlet hose washers (four)

Meaning and description of the symbols

Warning sign 	Contents marked with that symbol are related to the safety of the product and the personal safety of the users. Please operate in strict conformity to the contents, otherwise it may cause damage of the machine or injure the personal safety of the user.
Forbidding sign 	Contents marked with that symbol are actions forbidden to perform. Performing of those actions may result in damage of the machine or injure the personal safety of the user.

Safety precautions

Read all instructions in the manual before using the washer.

The washer must be grounded. In the event of a malfunction or breakdown, grounding will reduce the risk of electrical shock by providing a path of least resistance for electric current. The plug must be plugged into an appropriate outlet that is properly installed and grounded in accordance with all local codes and ordinances.

WARNING:

1. Improper connection of the equipment-grounding conductor can result in a risk of electric shock. Check with a qualified electrician or serviceman if you are in doubt as to whether the appliance is properly grounded.
2. Do not modify the plug provided with the appliance if it will not fit the outlet, have a proper outlet installed by a qualified electrician.
3. Do not repair or replace any part of the washer or attempt any servicing unless specifically recommended in this use and care guide or in published user-repair instructions that you understand and have the skills to carry out.
4. Be sure to pull the plug off when the machine is idle or when cleaning the machine.
5. Do not use an extension cord.



Do not put the machine at damp place like the bathroom. Never wash it with water.

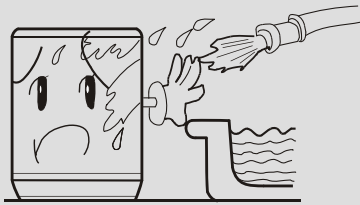

Do not install or store the washer where it will be exposed to the weather.

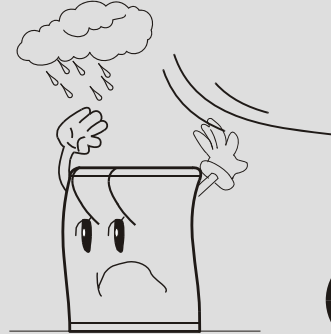

Do not let the machine share one receptacle with other electric appliances. If the power plug is damaged, or the plugging into the receptacle is loose, do not use the plug any more.

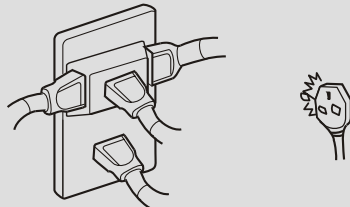

Do not wash water-proof laundries like the raincoat, bike covers etc. to avoid abnormal vibrations in spinning.



Safety precautions

IMPORTANT SAFETY INSTRUCTIONS

WARNING -To reduce the risk of fire, electric shock, or injury to persons when using your appliance, follow basic precautions, including the following:

- 1) Read all instructions before using the appliance.
- 2) Do not wash articles that have been previously cleaned in, washed in, soaked in, or spotted with gasoline, dry-cleaning solvents, other flammable, or explosive substances as they give off vapors that could ignite or explode.
- 3) Do not add gasoline, dry-cleaning solvents, or other flammable, or explosive substances to the wash water. These substances give off vapors that could ignite or explode.
- 4) Under certain conditions, hydrogen gas may be produced in a hot water system that has not been used for 2 weeks or more. **HYDROGEN GAS IS EXPLOSIVE.** If the hot water has not been used for such a period, before using the washing machine, turn on all hot faucets and let the water flow from each for several minutes. This will release any accumulated hydrogen gas. As the gas is flammable, do not smoke or use an open flame during this time.
- 5) Do not allow children to play on or in the appliance. Close supervision of children is necessary when the appliance is used near children.
- 6) Before the appliance is removed from service or discarded, remove the door.
- 7) Do not reach into the appliance if the tub or agitator is moving.
- 8) Do not install or store the washer where it will be exposed to the weather.
- 9) Do not tamper with controls.
- 10) Do not repair or replace any part of the washer or attempt any service unless specifically recommended in this use and care guide or in published user-repair instructions that you understand and have the skills to carry out.

SAVE THESE INSTRUCTIONS

GROUNDING INSTRUCTIONS

For a grounded, cord-connected appliance:

The washer must be grounded. In the event of a malfunction or breakdown, grounding will reduce the risk of electrical shock by providing a path of least resistance for electric current. The plug must be plugged into an appropriate outlet that is properly installed and grounded in accordance with all local codes and ordinances.

WARNING: Improper connection of the equipment-grounding conductor can result in a risk of electric shock. Check with a qualified electrician or serviceman if you are in doubt as to whether the appliance is properly grounded.

Do not modify the plug provided with the appliance if it will not fit the outlet, have a proper outlet installed by a qualified electrician.

Safety precautions

Before Using

Read all instructions in the manual before using the washer.

Do not let the machine share one receptacle with other electric appliances. If the power plug is damaged, or the plugging into the receptacle is loose, do not use the plug any more.

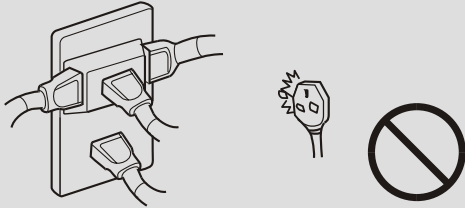

Do not put the machine at damp place like the bathroom. Never wash it with water.



Do not stretch hands into the working machine. It is dangerous even if the rotation is slow. Take special care of the children.



Do not wash water-proof laundries like the raincoat, bike covers etc. to avoid abnormal vibrations in spinning.

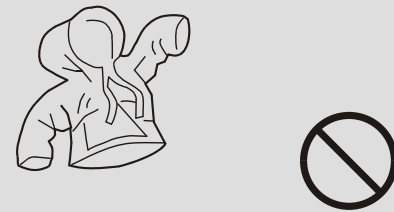

Do not put any hot or heavy items (such as the kettle with hot water) on the washing machine.

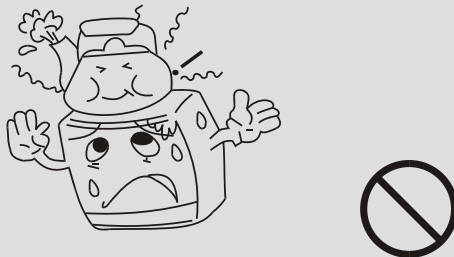

Do not decompose, repair or alter the machine by yourself.

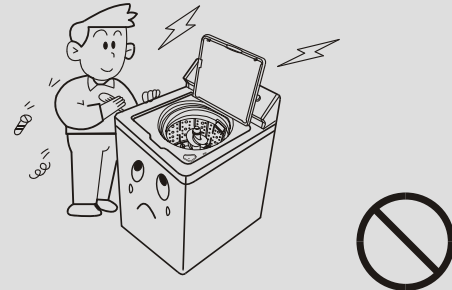

The handicapped or children without care shall not use the machine.

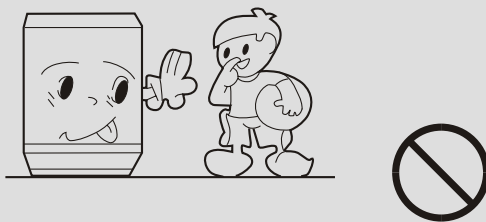

Keep the machine away from direct sunlight and heat source like the heater.

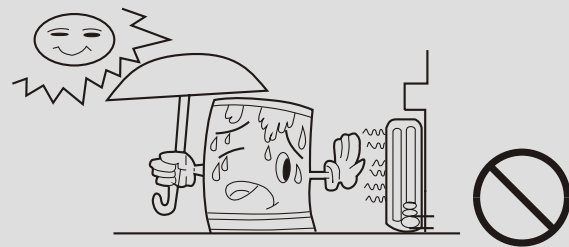

Installation and adjustment

Please install and adjust the machine according to the requirement of the manual. It is very important to your security and correct operating the machine.

Adjust the installation position

The largest allowed slope of the base of the machine is 2° . The slanting or rough ground will result in unstable running or stoppage of the machine. Please adjust it with following methods:

- **Confirm it's horizontal:**

Hang the lead line to confirm if it is horizontal.

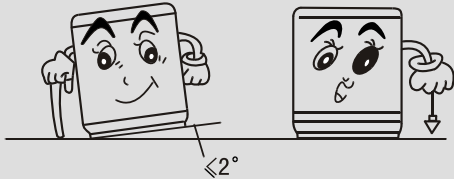

- **Adjust the adjustable foot:**

1. To twist the adjustable foot, please first lift up the side of the foot slightly, and twist the foot.
2. Fasten the nut after adjustment.

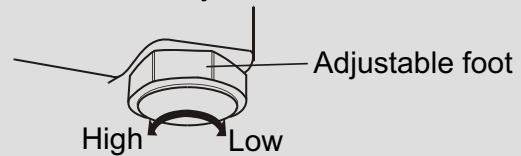

Install the drain hose

- First install the drain hose hook on the parts of outer drain hose component.
- Put the drain hose clamp on the outer drain hose, insert the outer drain hose into the joint for it, and then clutch tightly with drain hose clamp.

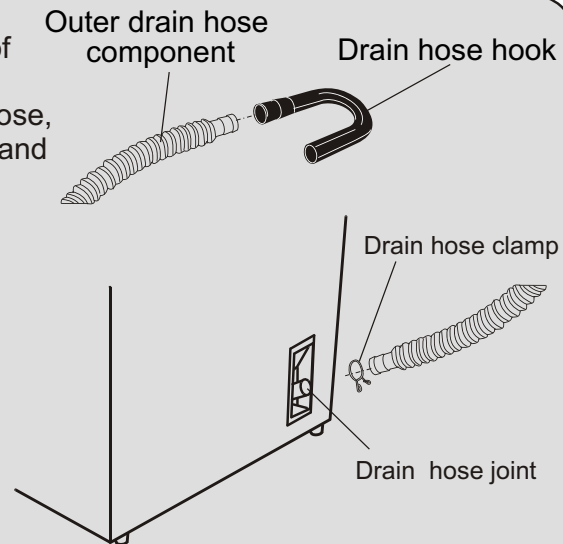

Usage of the drain hose

- Hang the outer drain hose on the proper place before washing (do not use it toppled down on the ground).
- Attend that the outlet of drain hose shall be higher than the water level in washtub to avoid siphon phenomenon.

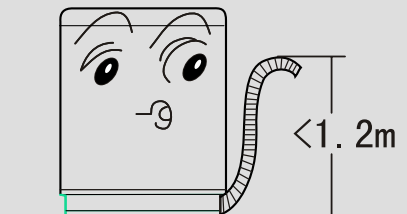

Install the water inlet hose

Connect the Water Inlet Hoses

1. Insert a new flat washer into each end of the inlet hoses. Firmly seat the washers in the coupling. (As figure 1)

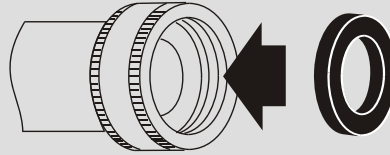

Figure 1

2. Respectively attach the water inlet hoses to the hot water faucet and the cold water faucet. Using pliers, tighten the coupling . (As figure 2)

NOTE: Do not overtighten. Damage to the valves can result.

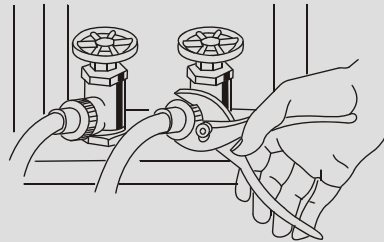

Figure 2

3. Run water through both faucets and inlet hoses, into a bucket or laundry tub, to get rid of particles in the water lines that might clog the inlet valves screens.
4. Attach the hose connected with hot water faucet to the HOT water inlet valve(sign with "H") . Attach the hose connected with cold water faucet to the COLD water valve(sign with "C"). (As figure 3)

NOTE: Do not overtighten. Damage to the valves can result.

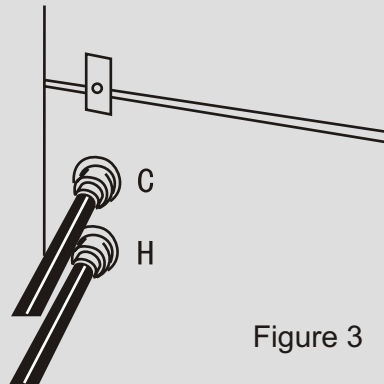

Figure 3

5. Check for leaks
 - (1). Swing the water inlet hose gently to confirm if it's suitable.
 - (2). Turn on the water faucets and check for leaks. A small amount of water might enter the washers. You will drain this later.

Temperature & hardness of water

How to select water temperature

Wash water temperature	Suggested fabrics	Effect
HOT 111° F (44°C) or above	<ul style="list-style-type: none"> • Work clothes • Solid white fabrics /uneasy fading and quietly elegant fabrics 	<ul style="list-style-type: none"> • May get the best wash effect for heavily-soiled articles • May remove grease, perspiration or mechanical oil • May stop losing luster or yellowing
WARM 90-110° F (32-43°C)	<ul style="list-style-type: none"> • Deep color/easy fading articles • Often change clothing • Nylon,silk and woolen articles • Knitting articles/delicate articles 	<ul style="list-style-type: none"> • Mostly applicable for washing general -soiled or light-soiled articles • May not damage the most fibre-made articles • Slight fading and lightly mutual dyeing • May reduce the degree of wrinkling
COLD 70-90° F (21-32°C)	<ul style="list-style-type: none"> • Articles with very sensitive color • Easy fading articles • Articles with hand washing 	<ul style="list-style-type: none"> • Mostly applicable for light-soiled articles • Economize hot water • The optimum rinsing temperature

In water temperature options, the cold water is commonly used to rinse. Warm water wash and warm water rinsing may also be adopted. Comparing cold water rinse, a better rinse effect may be got and the laundries will dry more quickly if use warm rinse, but the warm water rinse may make the laundries wrinkle easily. In the cold winter, the warm water rinse will provide you a more comfortable temperature when dispose the washed laundries.

Check the temperature of hot water

The temperature of hot water shall be 111°F(44°C) or above. If you do not know what degree the temperature of hot water is up, it will be easy to detect. Maybe you need increase the temperature of water heater. How to detect the temperature of hot water?

1.To get a full bowl of hottest water from injection inlet of hot water used by the washing machine.

Note: If there is no injection inlet on your washing machine, then get hot water from the nearest place away from washing machine.

2.To put a thermometer into the water to detect the temperature.

Note:The temperature of wash water lower than 70°F(21°C)will affect the solution of detergent, and this will make it difficult to clean the soil, some fabrics will wrinkling arks and small fluffing increase.

Hardness of water quality

The reason for not washing the laundry clean may be that the water quality is too hard. You may detect the hardness of water quality according to the following methods:

Tap water -- please consult the local tap water company.

Well water -- please consult the local residents institutions.

The content of mineral substances in water shall be calculated as galling/gallon or ?/10000.

If the content of mineral substance in water exceeds 8 galling/gallon, or higher than 132/10000, you shall:

- add softener
- put more detergent
- not use soap any more

Wash Cycle and sound

How to choose washing cycle and washing time

Follows will help you to choose the right washing cycle for the fabrics you are washing. Every cycle is set according to the type and soil degree of the fabrics.

- There is pause step in every cycle, it is normal if it happens during washing.
- Saturated soak(20 minutes): use this option for the heavy-soiled fabrics, for every 3 minutes interval, the fabrics will be agitated 1 minute. In order to improve the cleaning, please use 2 times the amount of recommended detergent(Soak time can be selected according to your need).

REGULAR cycle

REGULAR cycle is used for normal soiled fabrics, this cycle combine the high-speed washing and short high-speed spin. This cycle is mainly used for cottons and linens, you can choose the washing time according to the soil degree of the fabrics, 6 minutes for light-soiled fabric, 12 minutes for heavy-soiled fabrics.

PERM PRESS cycle

This cycle is one kind of the delicate cycle, which rinse 2 times, the cold water wash can be used to prevent the fabrics from wrinkling. This cycle is for heavy-duty fabrics or synthetics. You can choose washing time according to the soil degree of the fabrics.

DELICATES cycle

This cycle can use low speed wash action to remove the soil, the low speed spin can prevent the fabrics from wrinkling. For light soiled delicate fabrics, use this cycle.

HAND WASHABLE cycle

This cycle, low speed wash 20s in every interval of about 20s, this cycle is suitable for the fabrics needed special care. The low speed spin can prevent the fabrics from wrinkling.

Rinse and spin

In all above cycles, PERM PRESS cycle rinses 2 times, and other cycle rinses 1 times. It is necessary of additional rinsing when washing heavy-soiled fabrics with superfluous detergent or special care fabrics.

- When the cycle is completed, If you want to rinse once more, push in the button and turn the knob in clock wise direction to "rinse " in "NORMAL" cycle(drain-spin-fill-rinse-drain-spin).

Spin

If you need separate drain and spin, you can operate as follows:

- Push in the button and turn the knob to the "spin " in "NORMAL" cycle.
- Pull out the knob, the washing machine start to drain then spin.

Sounds during operation of washing machine

The following sounds shall be the normal sounds of washing machine in operation:

Wash cycle

If the low water level is selected for washing a small amount of laundry, you may hear "kada" sound from agitator due to the lower water level in washtub, this is normal washing sound.

Draining stage

The draining speed of washing machine is dependent on the installation of it. When the water is quickly drained out from the washing machine, you hear the sound of drawing of the air to the drain pump. This phenomenon may appear in the final draining stage.

After draining and before spinning

When the wash cycle turns from draining to spinning, the sound of gear meshing and puller opening may be heard.

1 Preparation before washing



Preparation before washing

1. Connect the water inlet hose. Open the water faucet.
2. Confirm that the washing machine is earthed reliably. Then insert the power plug into the receptacle. The earth terminal shall not link to gas pipeline and faucet water pipeline.
3. Put the drain hose up to suitable position.

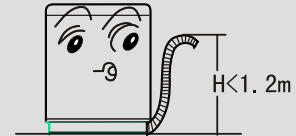
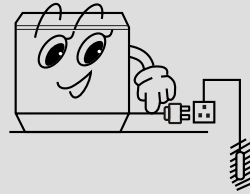

Note: "H" is the height of the hanged drain hose.

Pay attention to followings before washing the laundries

- Confirm if there has special requirement for the laundries.
- The quantity of the laundries shall not exceed the rated value. The big laundries like jeans shall be put in loosely.
- Close zippers, snaps, and hooks to avoid snagging other items. Remove pins, buckles, and other hard objects to avoid scratching the washer interior. Remove non-washable trim and ornaments
- Empty pockets and turn them inside out.
- Turn down cuffs, brush away lint and dirt.
- Tie strings and sashes so they will not tangle.
- Mend tears, loose herms, and seams.
- Treat spots and stains.
- Stained or wet garments should be washed promptly for best results.
- Separate heavily soiled items from lightly soiled ones, even if they would normally be washed together.
- Separate lint givers (towels, chenille) from lint takers (corduroy, synthetics, permanent press). When possible, turn lint givers inside out.
- Separate dark colors from light colors, colorfast items from non-colorfast items.
- Sort by fabric and construction (sturdy cottons, knits, delicate items).

2 Put in the laundries

How to place the laundry into the washing machine in a right way



Place a load of sorted clothes into the washer

- Place the laundry into the washing machine loosely till the upper of the washtub is full of the laundries (up to the highest holes located). Do not twist the laundry round the agitator, the laundry should be easily lifted from water to obtain the best washing effect and anti-crease effect. The laundry should go downward first, after some time go up again.
- Correctly load the laundry and choose the right water level. Overload or stack or too low water level will lead to:
 - wash not clean
 - winkling of the fabrics
 - fluffing
 - rapid wears of the fabrics (because of fluffing)
- Loading should depend on the place the laundry occupied, instead of the weight of the laundry itself.
- Every time when you wash, mix the larger item and smaller item and evenly place them into the washing machine to keep the machine in balance. Unbalance will lead to vibration and noise when spin cycle starts.
- For heavy-duty fabrics and some synthetics, in order to prevent them from wrinkling, the allowed washing laundry should be larger than the actual laundry size, when washing, these laundry need largest space to move than the bulky item like blankets and jeans.
- The washing time should be reduced when you wash fewer laundry. The less the laundry placed in, the shorter the washing time needed.

Loading suggestions (maximum size loads)

Please set water level to "high" for the following maximum size loads		
Heavy Work Clothes 3 trousers 3 shirts 4 jeans 1 coat 1 overcoat	Towels 10 bath towels 10 hand towels 14 wash clothes 1 bath blanket	Mixed load 3 double bedsheets 4 pillowcases 8 T-shirts 6 cotta 2 shirts 2 boy's suits 8 handkerchiefs
Knitting 3 trouser 3 boy's suits 6 shirts 4 caps 4 formal dress	Delicate fabrics 3 woman's underwear 1 coat 4 slippers 4 underwear 2 corset 1 babywear	

3 Add the detergent

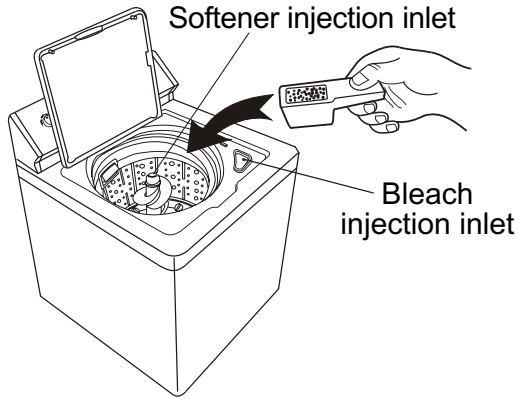

If the content of mineral substances in water exceeds the standard limits, please add softener, and softener shall be added from softener injection inlet.

How to use the washing powder

How to use the bleacher

- Fill water to decided level. Dilute the bleacher with container. Pour it slowly into the washing tub.
- Avoid using bleacher on laundries with color or pattern as they are prone to lose color.
- The bleacher shall not touch the laundries directly.
- Refer to the user's manual for the usage and quantity of the bleacher.
- For powder bleacher, please dissolve it before use.
The bleach injection inlet is suitable only for liquid bleacher.

- Direct dissolved in the machine
 - 1.Fill water to "Low" water level.
 - 2.Add the power. Run for 30 seconds to dissolve it completely.
 - 3.Put in the laundries. Select suitable water level.
- The instant dissolving of the washing powder:
 1. Prepare warm water of 30°C and a container.
 2. Add the powder while stirring to fully dissolve it.
- The powder is more prone to pollute the laundries than the detergent. Therefore please use it with proper quantity.
- It is suggested not to use high sudsing detergent.
- Different washing powders have different dosage. Please refer to the usage manual of the washing powder for the details.

Standard dosage of the detergent and water quantity(suggest)

Water level	Water quantity	Common powder, Add 40g in each 30L water	Concentrated powder, Add 25g in each 30L water
High	About 88L	About 117g	About 73g
Medium	About 60L	About 80g	About 50g
Low	About 38L	About 51g	About 32g

4 Close the top lid

If you open the top lid, the machine will stop working.

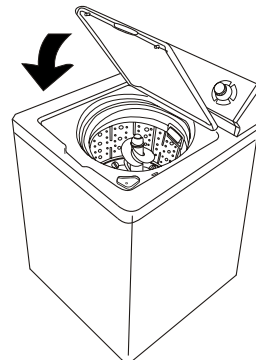

5 Select water level

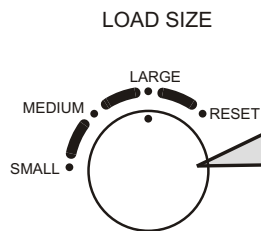

LOAD SIZE KNOB

- Three water levels available according to the laundries quantity: Large; Medium; Small. **Page 8**
- After the water inlet as per the preset water level, in case additional water quantity is required, please first set the button to the "RESET", and perform automatic water inlet. When it reaches the suitable water level, you can turn it to the preset water level.
- After the water inlet under set water level, if higher water level is needed, please first turn the knob to "Reset", then turn back to needed water level. The washing machine will fill water to the new water level automatically.

6 Set of temperature of wash and rinse water

According to the different washing laundries, 5 kinds of different wash/rinse temperature may be selected.

Note:

For the marked temperature, the upper is wash temperature, and the lower is rinse temperature.

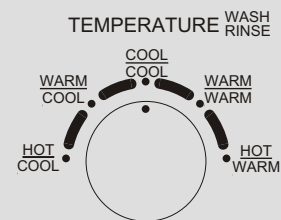

7 Cycle program select

- First push on the cycle selection button.
- Rotate this button in clock wise direction. You may select the following cycles singly: REGULAR cycle, DELICATES cycle, HAND WASHABLE and PERM PRESS cycle. The wash time may be set for each cycle according to the requirements.
- After finishing the selection of cycle, pull out the button and the washing machine may begin to work.
- If want to stop the washing machine at any time, push in the cycle control button.
- If restart the washing machine, close the cover first, then pull out the cycle control button.

Note:

There is pause step in each washing cycle, this is normal in operation of washing machine. In the operation of washing machine, sounds appeared in P may be heard, and most of these sounds are normal.

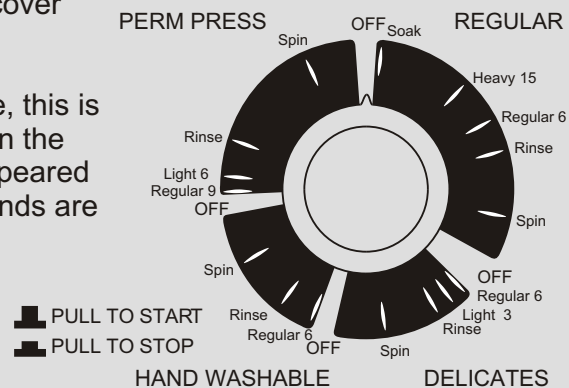

Attention

- The pulsator will not rotate unless the water is filled to selected water level.
- Do not use the SOAK program for the woolen laundries.

8 The washing is finished



It beeps to indicate the finishing of washing

The power will be switched off automatically after the finishing of the washing.

9 Disposal after washing

- After using, please clean the lint and foreign materials of the lint filter etc. in time. Otherwise it may influence your using the machine.
- Please first pull off the power plug from the receptacle before cleaning.

The filter screen of the water inlet valve is likely to be blocked by foreign materials and influence the water inlet. Please clean it with brush every two months.



If the cabinet is dirty, wipe it with wet cloth

- Do not flush it directly with water.
- Wipe it with neutral detergent.
- Do not wipe it with thinner, petrol, alcohol etc.

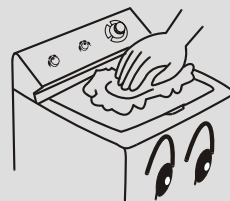

1. After washing, close the water faucet. (If needed, you can dismantle the water inlet hose).
2. Do not store water in the washing machine for a long period. Drain the water completely after each using.
3. Be sure to pull off the power plug before maintenance.
4. Hang up the power cord and drain hose.
5. Wipe off the water drops on the surface of the machine and inside the tub. Open the top lid for some time (about 1 hour), then close the top lid.

Trouble-shooting Answer to question

(If there's breakdown, please pull off the power plug before checking) The following phenomena are not breakdowns sometimes. Please confirm again before sending it to repair. If there are real breakdowns, please come to the special maintenance department or after-sale service department of our company. Do not repair it by yourself.

Phenomenan	The reason	How to settle
In washing,rinsing,spinning, the machine stops running.	<ul style="list-style-type: none"> ● The top lid is not closed. 	<ul style="list-style-type: none"> ● Close the top lid.
No water filling or filling slowly	<ul style="list-style-type: none"> ● Is the drain hose put down? ● Is the drain hose blocked by foreign material? ● Is the water pressure lower? 	<ul style="list-style-type: none"> ● Put down the drain hose. Open and close the top lid once. ● Clean the foreign material. Open and close the top lid once. ● Wait for the normal water pressure before use.
The machine does not act.	<ul style="list-style-type: none"> ● Is there power failure? ● Is the power plug loose? 	<ul style="list-style-type: none"> ● Use it when the power is on ● Insert the power plug tightly.
There's abnormal sound inside the machine.	<ul style="list-style-type: none"> ● Is the machine slanting? ● Are the laundries slanting in spinning? 	<ul style="list-style-type: none"> ● Level the machine properly ● Re-order the laundries.
The water faucet leaks.	<ul style="list-style-type: none"> ● Is the jointer screw of the water inlet hose is loose or twisted awry? 	<ul style="list-style-type: none"> ● Fasten the jointer screw properly.
During draining, the washer continues draining when push in programme selector knob.	<ul style="list-style-type: none"> ● It is special phenomena for washer with pump. 	<ul style="list-style-type: none"> ● If do not need continue draining, you can raise the entrance of drain hose and let water flow back inner tub. .

Common phenomena

Phenomena	Explanation
<ul style="list-style-type: none"> ● Rotate the "Process selector" knob to select "Spin", but it doesn't work. 	<ul style="list-style-type: none"> ● The program is setting the drain time. Some time is needed before it starts spinning.
<ul style="list-style-type: none"> ● There may be some water flowing out of the drain hose in the first use of the machine. 	<ul style="list-style-type: none"> ● It is the water remained in the factory inspection of performance.

Specification

Model	XQJ100-96
Rated voltage • frequency	240V ~ • 50Hz
Rated washing / spinning capacity	10.0kg (weight of standard dry cloth)
Water level/Water quantity (about)	High/95L, Medium/72L, Low/51L
Max water consumption	About 190L(High water level; Normal program)
Injection pressure	0.03Mpa-0.78Mpa
Rated washing power	680W
Rated spinning power	680W
Weight(about)	68kg
Dimension	L 686 mm W 686 mm H 1115mm