

Ice Maker

User Manual
HI6LMK

www.HaierAmerica.com

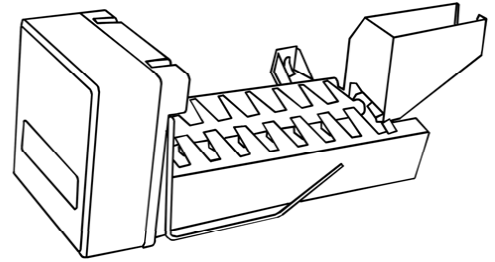

Model # HI6LMK
Issue Date: April 2013
120 V, 60 Hz

Made in China

Haier America
New York, NY 10018
©2013 Haier America Trading, LLC.

Haier

SMARTER LIFE BETTER PLANET

P/N 0060517641 Rev A

TABLE OF CONTENTS

SAFETY INFORMATION

Important Safety Instructions3

SET UP & CARE

Supplies Required for Installation.....4
Tools Required for Installation.....4
Parts Included 4
Installation Instructions..... 5-8
Water Supply Connection..... 9
Ice Maker Operation.....10
Tips & Care..... 10
Normal Operating Sounds 10

TROUBLESHOOTING & WARRANTY

Ice Maker Fill Adjustment.....11
Customer Service11
Troubleshooting.....12
Limited Warranty..... 13

PRODUCT REGISTRATION

Thank you for purchasing our Haier product. This easy-to-use manual will guide you in getting the best use of your product.

_____ **Model Number**

Remember to record the model and serial numbers. They are located on a label on the ice maker.

_____ **Date of Purchase**

Staple your receipt to your manual. You will need it to obtain warranty service.

IMPORTANT SAFETY INSTRUCTIONS



WARNING

TO AVOID ELECTRICAL SHOCK, WHICH CAN CAUSE DEATH OR SEVERE PERSONAL INJURY, DISCONNECT THE POWER SUPPLY BEFORE CONNECTING A WATER SUPPLY LINE TO THE REFRIGERATOR.



WARNING

DO NOT PLACE FINGERS OR HAND ON THE AUTOMATIC ICE MAKING MECHANISM WHILE THE REFRIGERATOR IS PLUGGED IN. THIS WILL HELP PROTECT YOU FROM POSSIBLE INJURY AS WELL AS PREVENT INTERFERENCE WITH MOVING PARTS OF THE EJECTOR MECHANISM AND THE HEATING ELEMENT THAT RELEASES THE CUBES.

PROFESSIONAL INSTALLATION IS RECOMMENDED.

TO AVOID PROPERTY DAMAGE:

- Copper tubing is recommended for the water supply line. Water supply tubing should be 1/4". Plastic is not recommended since it greatly increases the potential for water leaks.
- Do not install water supply tubing in areas where the temperature falls below freezing.
- Connect the ice maker to a drinkable water source that is not connected to a water softening system. Chemicals from the softener may damage the ice maker, causing it to malfunction.

SAVE THESE INSTRUCTIONS HOUSEHOLD USE ONLY

SUPPLIES REQUIRED FOR INSTALLATION

The following items are required to install the ice maker.

- ¼-inch copper supply line with shut off valve.
- ¼-inch brass compression nut and ferrule (sleeve).

NOTE: The copper tubing and shut-off valve should be available at your local hardware or plumbing supply store. Coil enough tubing in the back of the unit to allow movement of the refrigerator for cleaning and service.

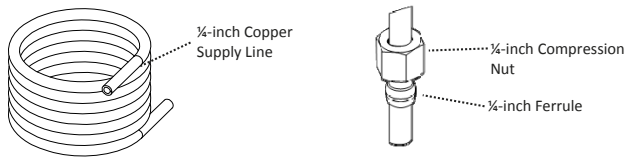

TOOLS REQUIRED FOR INSTALLATION

- 1/4-inch socket wrench or nut driver
- Phillips & Flathead screwdriver
- Adjustable wrench
- Pliers

PARTS INCLUDED

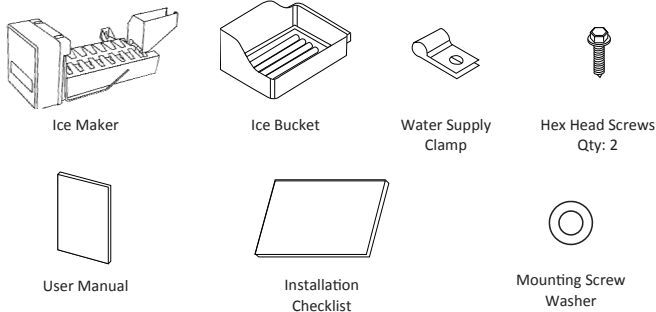

PAGE 4 • SET UP & CARE

LIMITED WARRANTY

In-Home Service - What is covered and for how long?

This warranty covers all defects in workmanship or materials of the automatic ice maker for a period of:

12 months labor
12 months parts

The warranty commences on the date the item was purchased and the original purchase receipt must be presented to the authorized service center before warranty repairs are rendered.

What is covered?

1. The mechanical and electrical parts, which serve as a functional, purpose of this kit for a period of 12 months.

What will be done?

1. We will repair or replace, at our discretion any mechanical or electrical part which proves to be defective in normal usage during the warranty period so specified.
2. There will be no charge to the purchaser for parts and labor on any covered items during the initial 12 month period.
3. Contact your nearest authorized service center. For the name of the nearest service center please call 1-877-337-3639

THIS WARRANTY COVERS WITHIN THE CONTINENTAL UNITED STATES, PUERTO RICO AND CANADA. IT DOES NOT COVER THE FOLLOWING:

- Damages from improper installation.
- Damages in shipping.
- Defects other than manufacturing.
- Damage from misuse, abuse, accident, alteration, lack of proper care and maintenance or incorrect current or voltage.
- Damage from other than household use.
- Damage from service by other than an authorized dealer or service center.
- Transportation and shipping.
- Improper installation. If you have an installation problem, contact your dealer or installer. You are responsible for providing adequate electrical, plumbing and other connecting facilities, including the water line to the ice maker and the water line installation.
- Replacement of house fuses or resetting of circuit breakers.
- Failure of the product if it is used for other than its intended purpose or used commercially.
- Damage to product caused by accident, fire, floods or Acts of God.

WARRANTOR IS NOT RESPONSIBLE FOR CONSEQUENTIAL DAMAGES. THIS LIMITED WARRANTY IS GIVEN IN LIEU OF ALL OTHER WARRANTIES, EXPRESSED OR, INCLUDING THE WARRANTIES OF MERCHANTABILITY AND FITNESS FOR A PARTICULAR PURPOSE.

The remedy provided in this warranty is exclusive and is granted in lieu of all other remedies. This warranty does not cover incidental or consequential damages, so the above limitations may not apply to you. Some States do not allow limitations on how long an implied warranty lasts, so the above limitations may not apply to you. This warranty gives you specific legal rights, and you may have other rights, which vary, from state to state.

Haier America
New York, NY 10018

PAGE 13 • TROUBLESHOOTING & WARRANTY

P/N 0060517641 Rev A

TROUBLESHOOTING

PROBLEM	CAUSE/SOLUTION
No ice produced	Ensure that refrigerator is plugged in to power source
	Wire control arm is fully raised. See Page 9.
	Check that ice maker is plugged into electrical socket in rear of freezer compartment. See Pages 5-6.
	Water supply is turned off or disconnected.
	Disconnect refrigerator from power source, remove rear access cover, then check to see that water valve is plugged into wiring harness in rear bottom compartment.
	Check water connections on water valve. See Page 8.
Low/slow ice production	Adjust freezer temperature to colder setting. See Refrigerator User Manual for instructions.
	Check for leaks or kinks in water tubing on rear of refrigerator.
	Increase water fill amount. See Page 11.
Small ice cubes	Increase water fill amount. See Page 11.
Water leak in freezer	Check that fill tube is aligned into fill cup on rear of ice maker. See Page 7.
	Decrease water fill amount. See Page 11.
Water leak under refrigerator	Check for leaks in water tubing on rear of refrigerator.
	Disconnect refrigerator from power supply, remove rear compartment cover, then check water connections on water valve.

INSTALLATION INSTRUCTIONS

1. Move refrigerator away from wall and unplug.
2. Remove freezer shelf by lifting up and sliding it out of freezer compartment.

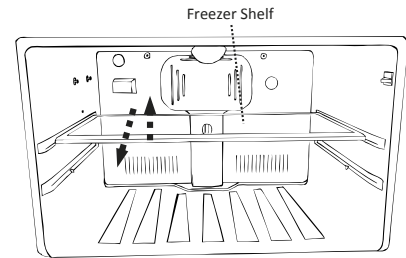

3. Remove plastic plug above electrical socket by grasping firmly and pulling end of plug down.

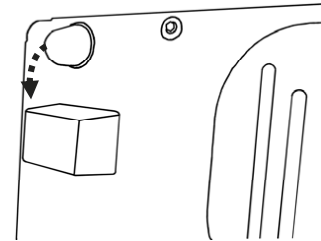

4. Remove electrical socket cover by grasping both sides of cover and pulling left side towards front of refrigerator. **(Do not discard electrical plug cover)**



INSTALLATION INSTRUCTIONS CONT.

5. Position ice maker harness in ice maker hook as shown below:

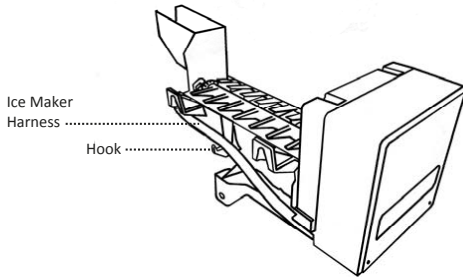

6. Insert ice maker electrical plug into socket using notches in socket and plug to help with alignment, then press firmly.

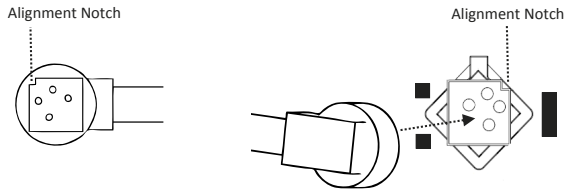

7. Re-install electrical plug cover by pushing cover down on plug, inserting tab into slot on rear cover and then snapping front prongs into square holes.

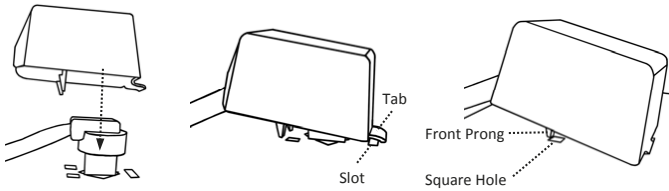

PAGE 6 • SET UP & CARE

ICE MAKER FILL ADJUSTMENT

THESE INSTRUCTIONS SHOULD ONLY BE USED IF THE HOME HAS UNUSUALLY LOW WATER PRESSURE THAT RESULTS IN LOW ICE PRODUCTION OR SMALL ICE CUBE SIZE. CHANGES TO HOME PLUMBING COULD AFFECT ICE MAKER FILL AMOUNT AND RESULT IN OVERFLOWED WATER IN THE FREEZER COMPARTMENT.

If your ice maker is making small ice cubes or isn't producing a satisfactory amount of ice, it is possible to improve this by adjusting the amount of water used to fill the ice cube tray in the ice maker.

NOTE: Increasing the water fill amount could cause water to overflow out of the ice maker. Make half-turn adjustments until ice cube size or ice production amount is satisfactory. Be sure to closely monitor the freezer compartment for water overflow after adjusting the fill adjustment screw.

1. Use flathead screwdriver to pry front cover of ice maker. Do not discard front cover.

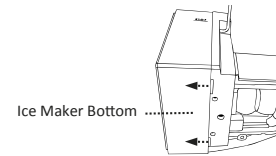

2. Use a Phillips screwdriver to turn fill adjustment screw clockwise to DECREASE water fill amount. Turn screw counter-clockwise to INCREASE water fill amount.

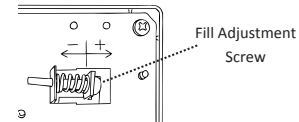

3. Replace front cover of ice maker.

CUSTOMER SERVICE

IMPORTANT

DO NOT RETURN THIS PRODUCT TO THE STORE

If you have a problem with this product, please contact the Haier Customer Satisfaction Center at 1-877-337-3639

DATED PROOF OF PURCHASE, MODEL NUMBER AND SERIAL NUMBER REQUIRED FOR WARRANTY SERVICE



PAGE 11 • TROUBLESHOOTING & WARRANTY

P/N 0060517641 Rev A

ICE MAKER OPERATION

NOTE: It takes approximately 24 hours for the ice maker to produce ice.

New plumbing may cause ice discoloration and poor flavor.

Discard ice made in the first 24 hours.

To stop the ice maker, lift the wire arm until it clicks and locks in the OFF (raised) position. The ice maker turns OFF automatically when the ice container is full. If your model has an adjustable freezer shelf, place the shelf so that when the ice container is full, the ice will hit the wire control arm.

TIPS & CARE

- Water quality determines ice quality. Do not connect the ice maker to water that is softened. Chemicals from a malfunctioning softener can damage the ice maker.
- Ice stored too long may develop an odd flavor. Empty the container and make sure the wire arm is in the ON (lowered) position. The ice maker will then produce ice.
- Keep the wire arm in OFF position until the refrigerator is connected to the water supply or whenever the water supply is turned OFF.

CAUTION:

- Do not wash the ice bucket in your dishwasher.
- Be sure to stop the ice maker when cleaning the freezer or on vacation.
- If the ice maker has to be turned OFF for a long period of time, turn the water supply valve to the closed position.
- Do not store anything on top of or in the ice maker or the ice bucket.

NORMAL OPERATING SOUNDS

The following sounds are normal when the ice maker is operating:

- Motor running (inside freezer compartment)
- Ice dropping into ice bucket (inside freezer compartment)
- Running water (inside freezer compartment)
- Water valve opening or closing (clicking from rear of refrigerator)

INSTALLATION INSTRUCTIONS CONT.

8. Position fill tube into slot in rear of ice maker fill cup.

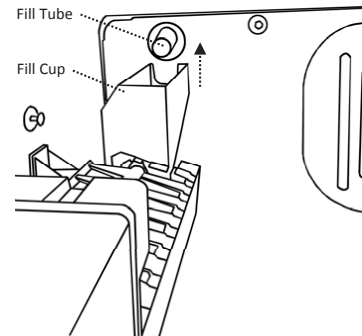

9. Hang ice maker from mounting posts.

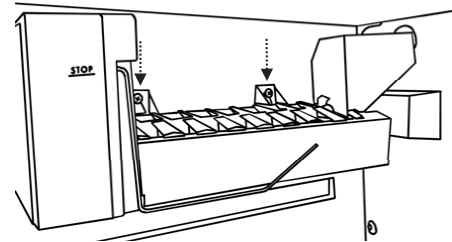

10. Use hex head screw and washer to secure tab on bottom of ice maker to inside of freezer.

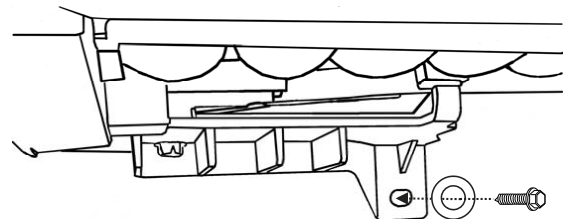

INSTALLATION INSTRUCTIONS CONT.

13. Re-install freezer shelf on lowest rail as shown and place ice bucket under the ice maker. Raise wire control arm on ice maker to OFF position.

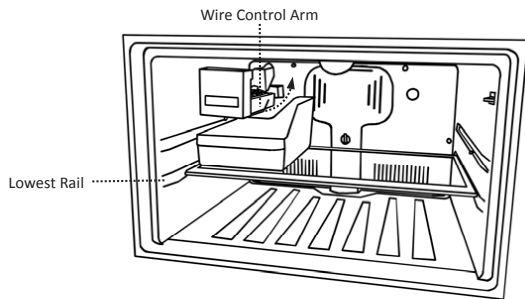

14. Locate water valve on rear of refrigerator. Valve protrudes slightly through rear compartment cover.

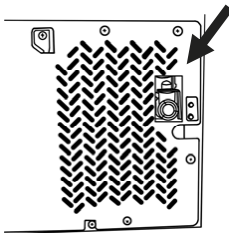

15. Insert supply line fully into water valve inlet. Slide ferrule (sleeve) into valve inlet and finger-tighten compression nut onto valve being careful not to cross-thread. Tighten another half-turn with a wrench. Do not over-tighten. Do not use Teflon tape on threads.

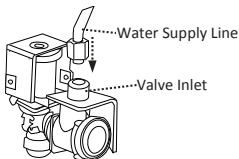

PAGE 8 • SET UP & CARE

WATER SUPPLY CONNECTION



WARNING

This water supply installation is not covered under warranty by the refrigerator or ice maker manufacturer(s). Follow these instructions carefully to minimize the risk of expensive water damage.

Supplies Required for Installation:

- Access to a household **cold water** line with water pressure between 20psi and 120psi.
 - A water supply line made of 1/4-inch Outside Diameter, copper tubing. To determine the length of the copper tubing needed, you will need to measure the distance from the ice maker water valve at the back of the refrigerator to your cold water line. Then add approximately 7 feet for the refrigerator to be moved out for cleaning and service.
 - A **shut-off valve** to connect the water supply line to your household water system.
- NOTE:** Do not use a self-piercing type shut-off valve.
- A compression nut and ferrule (sleeve) for connecting the water supply line to the ice maker inlet valve. See page 4 for picture.

1. Turn off water supply at shut-off valve.
2. Connect copper water supply line to household water system.
3. Turn ON water supply and tighten any connections that leak.
4. Coil excess water supply line behind refrigerator, as shown below and arrange coils so they do not vibrate or wear against other surfaces. Use water supply clamp and hex head screw to secure water supply line to rear of refrigerator.

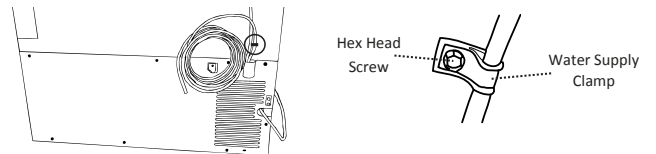

6. Reconnect refrigerator to power supply.
7. Move refrigerator back into place and level it using instructions in User Manual.
8. Turn ice maker ON by lowering wire control arm.

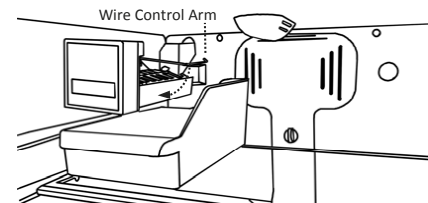

PAGE 9 • SET UP & CARE

P/N 0060517641 Rev A