

# LG SIGNATURE

## OWNER'S MANUAL

### DUAL FUEL RANGE

Read this owner's manual thoroughly before operating the appliance and keep it handy for reference at all times.

#### WARNING

If the information in this manual is not followed exactly, a fire or explosion may result causing property damage, personal injury or death.

- Do not store or use gasoline or other flammable vapors and liquids in the vicinity of this or any other appliance.
- **WHAT TO DO IF YOU SMELL GAS**
  - Do not try to light any appliance.
  - Do not touch any electrical switch.
  - Do not use any phone in your building.
  - Immediately call your gas supplier from a neighbor's phone. Follow the gas supplier's instructions.
  - If you cannot reach your gas supplier, call the fire department.
- Installation and service must be performed by a qualified installer, service agency, or the gas supplier.

LUTD4919SN



MFL68920507

[www.LGSIGNATURE.com](http://www.LGSIGNATURE.com)

Copyright © 2016 - 2017 LG Electronics Inc. All Rights Reserved.

## PRODUCT FEATURES

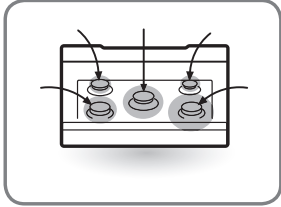

### Multiple Gas Burner Sizes

Choose a burner to fit the size of your cookware.

Cooking multiple items at once is possible by using different burners at the same time.

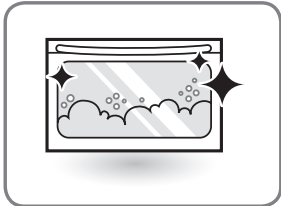

### Self Clean & EasyClean®

Useful for easy cleaning.

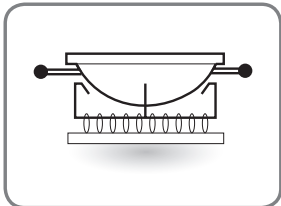

### Wok Grate

Use the included wok grate to safely support a 12" to 14" round-bottomed wok to stir-fry or saute meats, fish, or vegetables.

# TABLE OF CONTENTS

## 2 PRODUCT FEATURES

---

## 4 IMPORTANT SAFETY INSTRUCTIONS

---

## 12 PRODUCT OVERVIEW

---

- 12 Parts
- 12 Accessories

## 13 INSTALLATION

---

- 13 Installation Overview
- 13 Product Specifications
- 14 Before Installing the Range
- 16 Installing the Range
- 19 Optional Rear Filler
- 20 Providing Adequate Gas Supply
- 20 Connecting the Range to Gas
- 21 Connecting Electricity
- 24 Engaging the Anti-tip Device
- 24 Test Run
- 25 Assembling the Surface Burners
- 25 Checking Ignition of the Surface Burners

## 26 OPERATION

---

- 26 Control Panel Overview
- 27 Changing Oven Settings
- 31 Using the Gas Surface Burners
  - 32 Burner Locations
  - 32 Using the Gas Surface Burners
  - 32 Setting the Flame Size
- 33 In Case of Power Failure
- 33 Range-Top Cookware
- 33 Using a Wok
- 33 Using the Wok Grate
- 34 Using Stove-Top Grills
- 34 Using the Griddle
- 35 Using the Oven
  - 35 Before Using the Oven
  - 35 Oven Vent
  - 35 Using Oven Racks
  - 35 Bake
  - 36 Convection Mode
  - 37 Recommended Baking and Roasting Guide

- 38 Broil
- 39 Recommended Broiling Guide
- 40 Warm
- 40 Proof
- 40 Meat Probe
- 41 Remote Start

## 42 SMART FEATURES

---

- 42 Before Using Smart Features
- 42 Product Registration
- 42 Using the Wi-Fi Function
- 43 Open Source Software Notice Information
- 43 FCC Notice (For transmitter module contained in this product)
- 43 FCC RF Radiation Exposure Statement

## 44 MAINTENANCE

---

- 44 Gas Surface Burners
- 45 Burner Grates
- 45 Cleaning the Cooktop Surface
- 45 Oven Air Vents
- 45 Control Panel
- 46 Front Manifold Panel and Knobs
- 46 EasyClean®
- 49 Self Clean
- 51 Changing the Oven Light
- 51 Cleaning the Exterior
- 53 Removing and Replacing the Lift-Off Oven Doors
- 54 Door Care Instructions

## 55 TROUBLESHOOTING

---

- 55 FAQs
- 57 Before Calling for Service

## 60 SMART DIAGNOSIS™

---

- 60 Using Smart Diagnosis™
- 60 Smart Diagnosis™ Through the Call Center

## 61 WARRANTY

---

# IMPORTANT SAFETY INSTRUCTIONS

Read and follow all instructions when using the range to prevent the risk of fire, electric shock, personal injury, or damage. This guide does not cover all possible conditions that may occur. Always contact your service agent or manufacturer about problems that you do not understand.

Download this owner's manual at: <http://www.LGSIGNATURE.com>

 This is the safety alert symbol. This symbol alerts you to potential hazards that can result in property damage and/or serious bodily harm or death. All safety messages will follow the safety alert symbol and either the word WARNING or CAUTION. These words mean:

 **WARNING** - Indicates a hazardous situation which, if not avoided, could result in death or serious injury.

 **CAUTION** - Indicates a hazardous situation which, if not avoided, could result in minor or moderate injury.

## ANTI-TIP DEVICE

### WARNING

**TO REDUCE THE RISK OF TIPPING, THE APPLIANCE MUST BE SECURED BY A PROPERLY INSTALLED ANTI-TIP DEVICE. TO CHECK IF THE DEVICE IS INSTALLED PROPERLY, VERIFY THAT THE ANTI-TIP DEVICE IS ENGAGED, OR GRASP THE TOP REAR EDGE OF THE RANGE BACK GUARD AND CAREFULLY ATTEMPT TO TILT IT FORWARD.** Refer to the installation section for instructions.

- It is possible for a child or adult to tip the range and be killed.
- Verify that the anti-tip device has been properly installed and attached to the floor or wall and engaged to the leveling leg of the range.
- Do not operate the range without the anti-tip device in place and engaged.
- Never remove the oven legs. The range will not be secured to the anti-tip bracket if the legs are removed.
- Do not step or sit on the oven door. The range could be tipped and injury might result from spilled hot liquid, food, or the range itself.
- Do not rest large, heavy items such as whole turkeys on the open oven door. The range could tip forward and cause injury.
- Reengage the anti-tip device after pulling the range out for cleaning, service, or any other reason.
- Failure to follow these instructions can result in death or serious burns to children or adults.

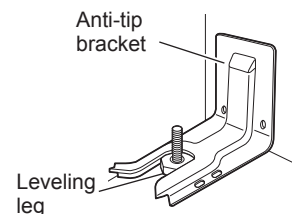

## INSTALLATION SAFETY PRECAUTIONS

Have the installer show you the location of the range gas shut-off valve and how to shut it off if necessary.

### **WARNING**

- Make sure the range is properly installed and grounded by a qualified installer, according to the installation instructions. Any adjustment and service should be performed only by qualified gas range installers or service technicians.
- Make sure the range is properly adjusted by a qualified service technician or installer for the type of gas (natural or LP) that is to be used. The range can be converted for use with either type of gas. See the installation instructions.
- These adjustments must be done by a qualified service technician according to the manufacturer's instructions and all codes and requirements of the authority having jurisdiction. Failure to follow these instructions could result in serious injury or property damage. The qualified agency performing these adjustments assumes responsibility for the conversion.
- Disconnect the electrical supply before servicing the appliance.
- Never use the appliance door as a step stool or seat, as this may result in tipping of the appliance and serious injuries.
- This product should not be installed below ventilation type hood systems that direct air in a downward direction.  
Doing so may cause ignition and combustion problems with the gas burners resulting in personal injury and may affect the cooking performance of the unit.
- To prevent fire hazard or electrical shock, do not use an adapter plug or an extension cord, or remove the grounding prong from the electrical power cord. Failure to follow this warning can cause serious injury, fire or death.
- To prevent poor air circulation, place the range out of the kitchen traffic path and out of drafty locations.
- Do not attempt to repair or replace any part of the range unless it is specifically mentioned in this manual. All other services should be referred to a qualified technician.
- Make sure that all packaging materials are removed from the range before operating it to prevent fire or smoke damage should the packaging material ignite.
- After using the range for an extended period of time high floor temperatures may result. Many floor coverings will not withstand this kind of use.
- Never install the range over vinyl tile or linoleum that cannot withstand such type of use. Never install it directly over interior kitchen carpeting.

## SAFETY PRECAUTIONS

The Safe Drinking Water and Toxic Enforcement Act requires the Governor of California to publish a list of substances known to the state to cause birth defects or other reproductive harm, and requires businesses to warn customers of potential exposure to such substances. Gas appliances can cause minor exposure to four of these substances, namely benzene, carbon monoxide, formaldehyde and soot, caused primarily by the imperfect combustion of natural or LP gas. Correctly adjusted burners, indicated by a bluish rather than a yellow flame, will minimize imperfect combustion. Exposure to these substances can be minimized by opening windows or using a ventilation fan or hood.

### **WARNING**

This product contains chemicals known to the State of California to cause cancer and birth defects or other reproductive harm. ***Wash hands after handling.***

- **DO NOT TOUCH HEATING ELEMENTS OR INTERIOR SURFACES OF OVEN.** Heating elements may be hot even though they are dark in color. Interior surfaces of an oven become hot enough to cause burns. During and after use, do not touch or let clothing or other flammable materials contact heating elements or interior surfaces of oven until they have had sufficient time to cool. Other surfaces, such as oven vent openings and surfaces near these openings, oven doors, and windows of oven doors, also get hot and may cause burns if not cooled.
- **Use care when opening door.** The hot air and steam that escape can cause burns to hands, face and eyes. Let hot air or steam escape from the oven before removing or replacing food in the oven.
- Do not repair or replace any part of the appliance unless specifically recommended in the manual. All other servicing should be performed by a qualified technician.
- Do not use harsh etching, abrasive cleaners or sharp metal scrapers to clean the oven door glass since they can scratch the surface. Scratches may cause the glass to shatter.

### **WARNING**

If the door glass, surface, or oven heating unit of the range are damaged, discontinue use of the range and call for service.

- Do not operate the oven without the charcoal heater mesh.
- Do not use plastic to cover food. Use foil or oven-safe lids only.
- Do not allow anyone to climb, stand or hang on the door or cooktop. They could damage the range and even tip it over, causing severe personal injury.
- Do not line the oven walls, racks, bottom, or any other part of the oven with aluminum foil or any other material. Doing so will disrupt heat distribution, produce poor baking results and cause permanent damage to the oven interior (aluminum foil will melt to the interior surface of the oven)
- Never attempt to dry a pet in the oven.
- **Never use your appliance for warming or heating the room.**
- Always use pot holders or oven mitts when removing food from the oven or the surface element. Cookware will be hot. **Use only dry pot holders.** Moist or damp pot holders on hot surfaces may result in burns from steam. Do not let the pot holder touch hot heating elements. Do not use a towel or other bulky cloth to remove food.
- **Do not heat unopened food containers.** Pressure in the containers may cause them to burst which may result in injury.
- Large scratches or impacts to glass doors can lead to broken or shattered glass.
- Leak testing of the appliance must be conducted according to the manufacturer's instructions.

- To eliminate the risk of burns or fire by reaching over heated surface units, cabinet storage space located above the surface units should be avoided. If cabinet storage is to be provided, the risk can be reduced by installing a range hood that projects horizontally a minimum of 5 inches beyond the bottom of the cabinets.

### WARNING

- Gas leaks may occur in the system and result in a serious hazard. Gas leaks may not be detected by smell alone. Gas suppliers recommend you purchase and install a UL approved gas detector. Install and use in accordance with the gas detector manufacturer's instructions.
- To prevent staining or discoloration, clean appliance after each use.
- Do not attempt to open or close the door or operate the oven until the door is properly installed.
- Never place fingers between the hinge and front oven frame. Hinge arms are spring mounted. If accidentally hit, the hinge will slam shut against the oven frame and injure your fingers.

### CAUTION

- Wear gloves when cleaning the range to avoid injury or burns.
- Do not use the oven for storing food or cookware.
- To prevent damage to the oven door, do not attempt to open the door when Lock is displayed.
- Do not stand or place excessive weight on an open door. This could tip the range, break the door, or injure the user.
- Do not use delayed baking for highly perishable foods such as dairy products, pork, poultry, or seafood.

## FLAMMABLE MATERIALS

### WARNING

Be certain that all packing materials are removed from the appliance before operating. Keep plastic, clothes, paper, and other flammable materials away from parts of the appliance that may become hot.

- Do not store or use flammable material in the oven or near or on the cooktop. Flammable materials include paper, plastic, pot holders, linens, wall coverings, curtains, and gasoline or other flammable vapors and liquids such as grease or cooking oil. These materials can be ignited when the oven and cooktop are in use.
- **Wear proper apparel.** Do not wear loose-fitting or hanging garments, which may ignite if they contact hot surfaces, and cause severe burns.
- Do not use the oven for drying clothes. Only use the oven for its intended purpose.
- If a cabinet storage is provided directly above cooking surface, place items that are not frequently used and can be safely stored in an area subjected to heat. Temperatures may be unsafe for volatile items such as flammable liquids, cleaners or aerosol sprays.

## ELECTRICAL SAFETY

### CAUTION

Be certain that all packing materials are removed from the appliance before operating. Keep plastic, clothes, paper, and other flammable materials away from parts of the appliance that may become hot.

- Always disconnect power from the appliance before servicing.
- Do not use aluminum foil or any other material to line the oven bottom. Improper installation of these liners may result in a risk of electric shock or fire.
- Do not allow aluminum foil or the temperature probe to contact heating elements.

### WARNING

Before replacing the oven light bulb, switch off the electrical power to the oven at the main fuse or circuit breaker panel. Failure to do so can result in severe personal injury, death, or electrical shock.

## DEEP FAT FRYER

- Use extreme caution when moving or disposing of hot grease.
- Always heat fat slowly, and watch as it heats.
- If frying combinations of oils and fats, stir them together before heating.
- Use a deep fat thermometer, if possible, to prevent overheating fat beyond the smoking point.
- Use the least possible amount of fat for effective shallow or deep-fat frying. Filling the pan with too much fat can cause spillovers when food is added.

## CHILD SAFETY

- Do not leave small children unattended near the oven.

### WARNING

**Do not leave children alone** or unsupervised near the appliance when it is in use or is still hot. Children should never be allowed to sit or stand on any part of the appliance as they could be injured or burned.

### CAUTION

Do not store items of interest to children in cabinets above a range or on the back guard of a range – children climbing on the range to reach items could be seriously injured.

- Never let a child hang on the oven door.
- Do not allow children to crawl into the oven.
- Let hot utensils cool in a safe place, out of reach of small children.
- Children should not be allowed to play with controls or other parts of the appliance.



## SURFACE BURNERS

### WARNING

- Even if the top burner flame goes out, gas is still flowing to the burner until the knob is turned to the **Off** position. If you smell gas, immediately open a window and ventilate the area for five minutes prior to using the burner. Do not leave the burners on unattended.
- **Use proper pan size.** Do not use pans that are unstable or that can be easily tipped. Select cookware with flat bottoms large enough to cover burner grates. To avoid spillovers, make sure the cookware is large enough to contain the food properly. This will both save cleaning time and prevent hazardous accumulations of food, since heavy spattering or spillovers left on the range can ignite. Use pans with handles that can be easily grasped and remain cool.

### CAUTION

- Be sure that all surface controls are set in the **Off** position prior to supplying gas to the range.
- Never leave the surface burners unattended at high flame settings. Boilovers may cause smoke and greasy spillovers that may ignite.
- Always turn the knobs to the **Lite** position when igniting the top burners and make sure the burners have ignited.
- Control the top burner flame size so it does not extend beyond the edge of the cookware. Excessive flame is hazardous.
- Only use dry pot holders- moist or damp pot holders on hot surfaces may result in burns from steam. Do not let pot holders come near open flames when lifting cookware. Do not use towels or other bulky cloth items. Use a pot holder.
- If using glass cookware, make sure the cookware is designed for range-top cooking.
- To prevent burns from ignition of flammable materials and spillage, turn cookware handles toward the side or back of the range without extending them over adjacent burners.
- Never leave any items on the cooktop. The hot air from the vent may ignite flammable items and will increase pressure in closed containers, which may cause them to burst.
- Carefully watch foods being fried at a high flame setting.
- Always heat fat slowly, and watch as it heats.
- If frying combinations of oils and fats, stir together before heating.
- Use a deep fat thermometer if possible to prevent fat from heating beyond the smoking point.
- Use the least possible amount of fat for effective shallow or deep fat frying. Filling the pan with too much fat can cause spillovers when food is added.
- Do not cook foods directly on an open flame on the cooktop.
- Do not use a wok on the surface burners if the wok has a round metal ring that is placed over the burner grate to support the wok. This ring acts as a heat trap, which may damage the burner grate and burner head. It may also cause the burner to work improperly. This may cause carbon monoxide levels which are higher than what is allowed by current standards, resulting in a health hazard.
- Foods for frying should be as dry as possible. Frost or moisture on foods can cause hot fat to bubble up and spill over the sides of the pan.
- Never try to move a pan of hot fat, especially a deep fryer. Wait until the fat is cool.
- Do not place plastic items on the cooktop- they may melt if left too close to the vent.
- Keep all plastics away from the surface burners.

**CAUTION**

- To prevent burns, always be sure that the controls for all burners are in the **Off** position and all grates are cool before attempting to remove them.
- If you smell gas, turn off the gas to the range and call a qualified service technician. Never use an open flame to locate a leak.
- Always turn the knobs to the **Off** position before removing cookware.
- Do not lift the cooktop. Lifting the cooktop can cause damage and improper operation of the range.
- If the range is located near a window, do not hang long curtains that could blow over the surface burners and catch on fire.
- Use care when cleaning the cooktop. The pointed metal ends on the electrodes could cause injury.
- Stand away from the range while frying.
- Keep an eye on foods being fried at high or medium high heat settings.

**ENERGY SAVING TIPS**

- Multiple-rack cooking saves time and energy. Whenever possible, cook foods requiring the same cooking temperature together in one oven.
- For optimal performance and energy savings, follow the guides on page 37 for proper rack and pan placements.
- Match the size of the cookware to the amount of food being cooked to save energy when heating. Heating  $\frac{1}{2}$  quart of water requires more energy in a 3-quart pot than in a 1-quart pot.
- Match the size of the cooktop burner or element to the size of the cookware in use. Using a large element for a small pan wastes heating energy, and the exposed surface of the element is a burn or fire hazard.
- Reduce energy use by cleaning light oven soils with the EasyClean® feature instead of self-clean.
- Avoid opening the oven door more than necessary during use. This helps the oven maintain temperature, prevents unnecessary heat loss, and saves on energy use.

**SAFETY DURING USE**

- Do not touch the oven racks while they are hot.
- If a rack must be moved while the oven is hot, do not let the pot holder contact the hot heating element in the oven.
- Use caution with the Timed Cook or Delayed Timed Cook features. Use the automatic timer when cooking cured or frozen meats and most fruits and vegetables. Foods that can easily spoil, such as milk, eggs, fish, meat or poultry, should be chilled in the refrigerator first. Even when chilled, they should not stand in the oven for more than 1 hour before cooking begins, and should be removed promptly when cooking is complete. Eating spoiled food can result in sickness from food poisoning.
- Accessible parts may become hot when the grill is in use.
- Do not place food or cookware on the bottom of the oven cavity. Doing so will cause permanent damage to the oven bottom finish.
- **Do not use water on grease fires.** Should an oven fire occur, leave the oven door closed and turn the oven off. If the fire continues, throw baking soda on the fire or use a fire extinguisher. Do not put water or flour on the fire. Flour may be explosive and water can spread a grease fire and cause personal injury.

- When disposing of the range, cut off the power cord and remove the door.
- Do not make any attempt to operate the electric ignition oven during an electrical power failure.
- Pull the oven rack to the stop-lock position when loading and unloading food from the oven. This helps prevent burns caused by touching hot surfaces of the door and oven walls.
- Do not use the oven if a heating element develops a glowing spot during use or shows other signs of damage. A glowing spot indicates the heating element may fail and present a potential burn, fire, or shock hazard. Turn the oven off immediately and have the heating element replaced by a qualified service technician.
- When using cooking or roasting bags in the oven, follow the manufacturer's directions.

## SAFETY WHEN CLEANING

- Open a window or turn on a ventilation fan or hood before self-cleaning.
- If the oven is heavily soiled with oil, self-clean the oven before using the oven again. The oil could cause a fire.
- Wipe up heavy soil on the bottom of the oven before using the Self Clean function.
- **Do not use oven cleaners.** Commercial oven cleaner or oven liner protective coating of any kind should not be used in or around any part of the oven.
- Never keep pet birds in the kitchen. The health of birds is extremely sensitive to the fumes released during an oven self-clean cycle. Fumes may be harmful or fatal to birds. Move birds to a well-ventilated room.
- Clean in the self-clean cycle only parts listed in this manual. Before self-cleaning the oven, remove the broiler pan, all oven racks, the meat probe and any utensils or food from the oven.
- Important Instruction. The oven displays an F error code and sounds three long beeps during the self-cleaning process if it malfunctions in the self-clean mode. Switch off the electrical power to the main fuse or breaker and have the oven serviced by a qualified technician.
- It is normal for the cooktop of the range to become hot during a self-clean cycle. Do not touch the cooktop during a self-clean cycle.
- Never pour cold water over a hot oven for cleaning. Doing so may cause the oven to malfunction.
- Make sure oven lights are cool before cleaning.
- **Do not clean door gasket.** The door gasket is essential for a good seal. Care should be taken not to rub, damage, or move the gasket.
- If there is a fire in the oven during self-clean, turn the oven off and wait for the fire to go out. Do not force the door open. Introduction of fresh air at self-clean temperatures may lead to a burst of flame from the oven. Failure to follow this instruction may result in severe burns.
- For your safety, do not use high-pressure water cleaners or steam jet cleaners to clean the product.

## COOK MEAT AND POULTRY THOROUGHLY

- To protect against food-borne illnesses, cook meat and poultry thoroughly. The USDA has indicated the following as safe minimum internal temperatures for consumption:
  - Ground meats: 160 °F
  - All poultry: 165 °F
  - Beef, veal, pork, or lamb: 145 °F
  - Fish/seafood: 145 °F

# PRODUCT OVERVIEW

## Parts

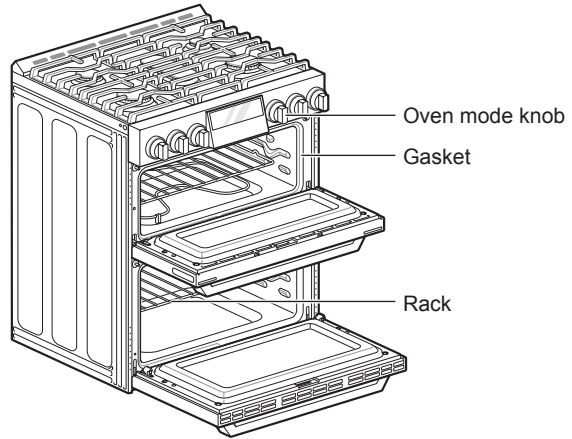
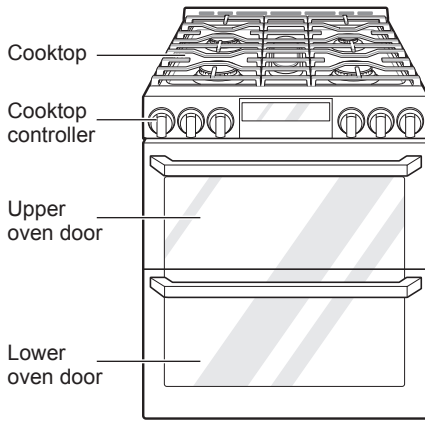

## Accessories

### Included Accessories



Heavy rack (2ea)

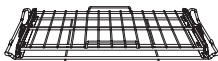

Gliding rack (1ea)



Spray bottle (1ea)

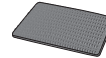

Non-scratch scouring pad (1ea)



Wok grate (1ea)

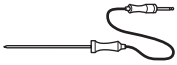

Meat probe (1ea)

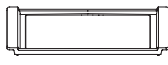

Griddle (1ea)



Rear filler (1ea)



Owner's manual (1ea)

### Anti-tip kit

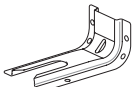

Anti-tip

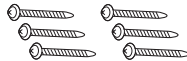

Screws (6ea)

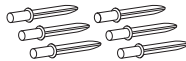

Anchors (6ea)

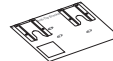

Template

### LP nozzle conversion kit

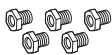

Cooktop nozzles (5ea)

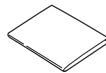

Installation guide (1ea)



Choke (1ea)



Set screw (1ea)

### Optional Accessories

Grid

Broiler pan

### NOTE

- Contact the LG SIGNATURE Customer Information Center at 1-800-984-6306 if any accessories are missing.
- For your safety and for extended product life, only use authorized components.
- The manufacturer is not responsible for product malfunction or accidents caused by the use of separately purchased, unauthorized components or parts.
- The images in this guide may be different from the actual components and accessories, which are subject to change by the manufacturer without prior notice for product improvement purposes.

# INSTALLATION

## Installation Overview

Please read the following installation instructions first after purchasing this product or transporting it to another location.

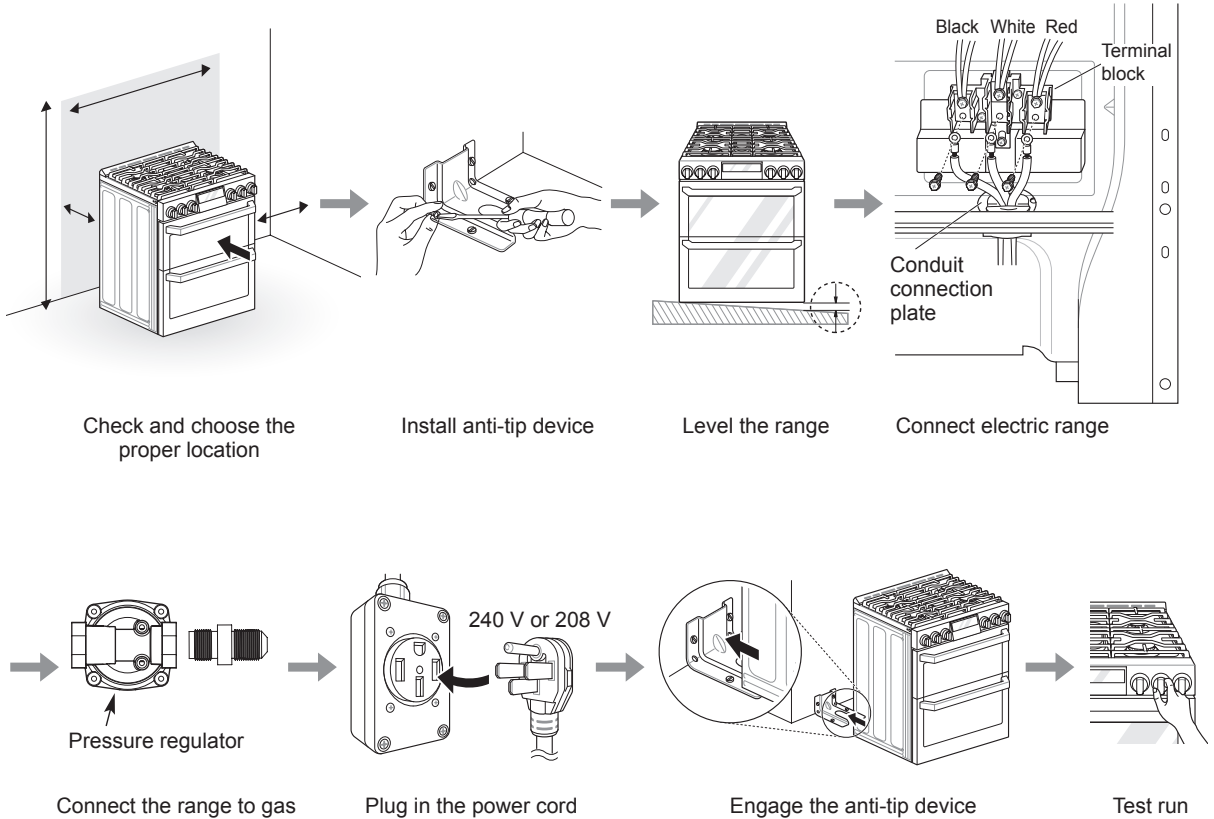

## Product Specifications

The appearance and specifications listed in this manual may vary due to constant product improvements.

Oven Range Models	LUTD4919SN
Description	Dual Fuel Double Oven Range
Electrical requirements	6.9 kW 120/240 VAC or 5.2kW 120/208 VAC
Exterior Dimensions	29 7/8" (W) x 37 59/64" (H) x 28 15/16" (D) (D with door closed) 75.9 cm (W) x 96.3 cm (H) x 73.5 cm (D) (D with door closed)
Height to cooking surface	36" (91.4 cm)
Net weight	196.2 lb (89.0 kg)
Total capacity	Upper Oven: 3.0 cu. ft. Lower Oven: 4.3 cu. ft. Total cap.: 7.3 cu. ft.

## Before Installing the Range

### WARNING

#### Tip - Over Hazard

A child or adult can tip the range and be killed. Verify the anti-tip bracket has been installed. Ensure the anti-tip bracket is engaged when the range is moved.

Do not operate the range without the anti-tip bracket in place. Failure to follow these instructions can result in death or serious burns to children and adults.



To check that leveling leg is inserted into anti-tip bracket, grasp the top rear edge of the range and carefully attempt to tilt it forward.

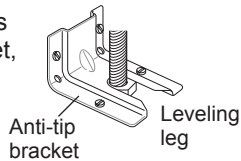

If you did not receive an anti-tip bracket with your purchase, call 1-800-984-6306 to receive one at no charge.

### WARNING

- **The information in this manual should be followed exactly.** Failure to do so may result in fire, electrical shock, property damage, personal injury, or death.
- **Wear gloves during the installation procedure.** Failure to do so can result in bodily injury.
- Make sure no parts came loose during shipping.

## In the Commonwealth of Massachusetts

- This product must be installed by a licensed plumber or gas fitter.
- When using ball type gas shut-off valves, they must be the T-handle type.
- When using a flexible gas connector, it must not exceed 3 feet in length.

### NOTE

- Observe all governing codes and ordinances.
- Have the installer show you the location of the circuit breaker or fuse. Mark it for easy reference.
- As when using any appliance generating heat, there are certain safety precautions you should follow.
- Be sure your range is installed and grounded properly by a qualified installer or service technician according to the installation instructions.
- Any adjustment and service should be performed only by qualified gas range installers or service technicians.

## Preparing for Installation

### Tools Needed



Phillips screwdriver



Flat-blade screwdriver

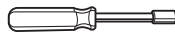

1/4" Nut driver

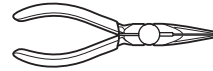

Pliers

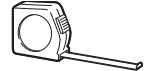

Tape measure



Level

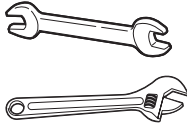

Open-end or adjustable wrench

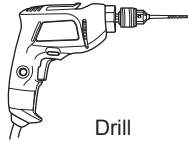

Drill



Safety glasses



Gloves

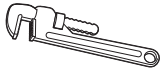

Pipe wrench (2)  
(one for support)

### Parts Provided



Template (1)



Anti-tip bracket kit (1)

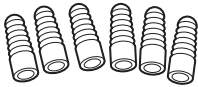

Anchor sleeves (6)



Lag bolts (6)

### Parts not Provided



4-Wire cord or  
3-Wire cord  
(UL approved 40 or 50  
AMP)

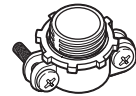

Strain relief  
**(For conduit  
Installations only)**

### Materials You May Need

- Gas line shut-off valve
- Pipe joint sealant that resists action of natural and LP gases
- Flexible metal appliance connector (3/4" or 1/2" NPT x 1/2" I.D.)  
Never use an old connector when installing a new range.
- Flare union adapter for connection to gas supply line (3/4" or 1/2" NPT x 1/2" I.D.)
- Flare union adapter for connection to pressure regulator on range (1/2" NPT x 1/2" I.D.)
- Liquid leak detector or soapy water
- Lag bolt or 1/2" O.D. sleeve anchor (for concrete floors only)

## Installing the Range

### Unpacking and Moving the Range

#### CAUTION

- **You should use two or more people to move and install the range. (Excessive Weight Hazard)** Failure to do so can result in back or other injury.
- **Do not use the door handles to push or pull the range during installation or when moving the range out for cleaning or service.** Doing so can result in serious damage to the door of the range.

Remove packing material, tape and any temporary labels from your range before using. Do not remove any warning-type labels, the model and serial number label, or the Tech Sheet that is located on the back of the range.

To remove any remaining tape or glue, rub the area briskly with your thumb. Tape or glue residue can also be easily removed by rubbing a small amount of liquid dish soap over the adhesive with your fingers. Wipe with warm water and dry.

Do not use sharp instruments, rubbing alcohol, flammable fluids, or abrasive cleaners to remove tape or glue. These products can damage the surface of your range.

The range is heavy and can be installed on soft floor coverings such as cushioned vinyl or carpeting. Use care when moving the range on this type of flooring. Use a belt when moving the range to prevent damaging the floor. Or slide the range onto cardboard or plywood to avoid damaging the floor covering.

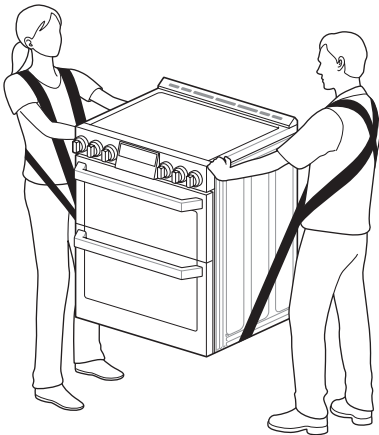

### Choosing the Proper Location

#### CAUTION

- **Avoid placing cabinets above the range.** To minimize the hazard caused by reaching over the open flames of operating burners, install a ventilation hood over the range that projects forward at least five inches beyond the front of the cabinets.
- **Do not locate your range where it may be subject to strong drafts.** Any openings in the floor or wall behind the range should be sealed. Make sure the openings around the base of the range that supply fresh air for combustion and ventilation are not blocked by carpeting or woodwork.
- **This range is for indoor, household use only.** Do not install the range in areas exposed to the weather and/or water.
- **If the range is located near a window, do not hang long curtains or paper blinds on that window.**
- **Make sure wall covering, countertop and cabinets around the range can withstand the heat (up to 194 °F) generated by the range.** Discoloration, delamination or melting may occur. This range has been designed to comply with the maximum allowable wood cabinet temperature of 194 °F.
- **Before installing the range in an area covered with linoleum or other synthetic floor covering, make sure the floor covering can withstand temperatures of at least 160 °F(70°C).**
- **Use an insulated pad or 1/4 in. (0.64 cm) plywood under the range if installing the range over carpeting.**

The range should always be plugged into its own individual properly grounded electrical outlet. This prevents overloading house wiring circuits which could cause a fire hazard from overheated wires. It is recommended that a separate circuit serving only this appliance be provided.

This appliance must not be installed with a ventilation system that blows air downward toward the range. This type of ventilation system may cause ignition and combustion problems with the gas cooking appliance resulting in personal injury or unintended operation.

When the floor covering ends at the front of the range, the area that the range will be installed on should be built up with plywood to the same level or higher than the floor covering. This will allow the range to be moved for cleaning and servicing, as well as provide proper air flow to the range.



### **Mobile Home - Additional Installation Requirements**

The installation of this range must conform to the Manufactured Home Construction and Safety Standard, Title 24 CFR, Part 3280 (formerly the Federal Standard for Mobile Home Construction and Safety, Title 24, HUD Part 280), or when such standard is not applicable, the Standard for Manufactured Home Installations, ANSI A225.1/NFPA 501A or with local codes.

- When this range is installed in a mobile home, it must be secured to the floor during transit. Any method of securing the range is adequate as long as it conforms to the standards listed above.
- A four-wire power supply cord or cable must be used in a mobile home installation.

### Dimensions and Clearances

**NOTE**

Save for the use of the local electrical inspector.

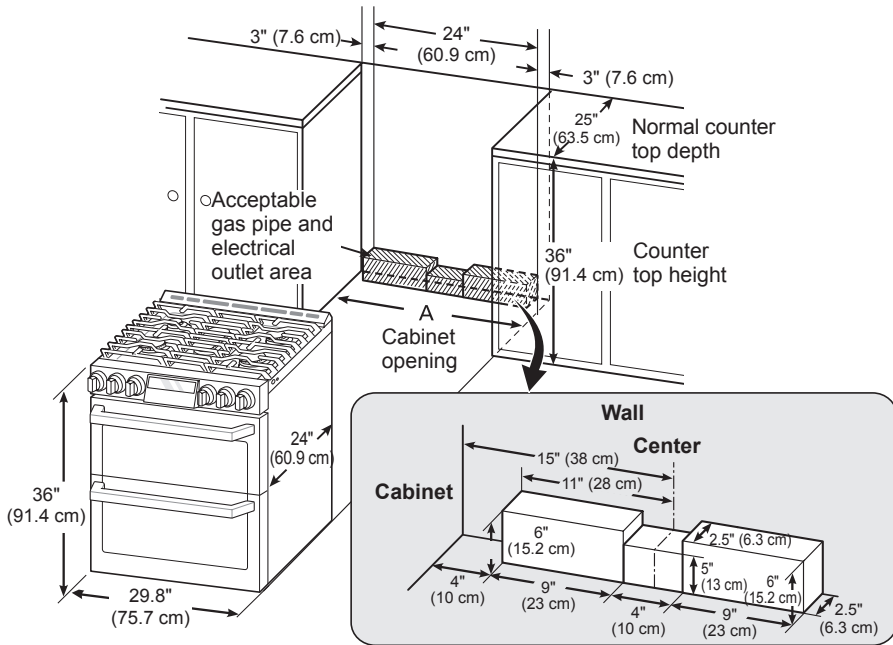

A = 30" (76.2 cm) For U.S.A  
 = 30" (76.2 cm) ~ 31" (78.7 cm) For CANADA

For installation in Canada, a free-standing range is not to be installed closer than <sup>15</sup>/<sub>32</sub>" (12 mm) from any adjacent surface.

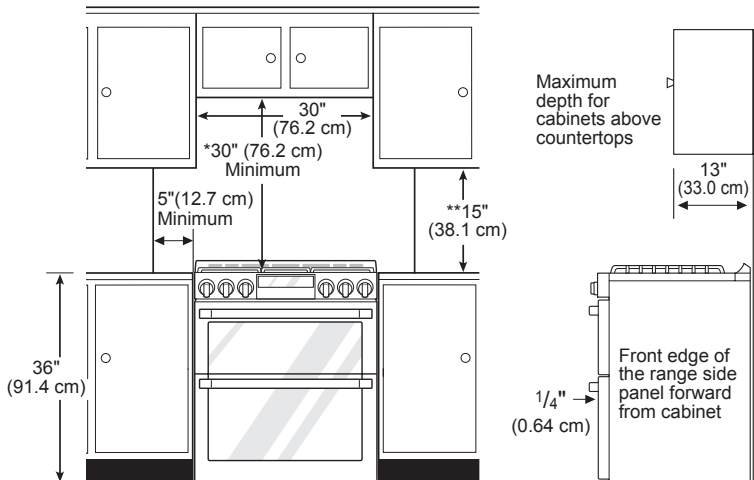

**Minimum Dimensions**

\* 30" (76.2 cm) minimum clearance between the top of the cooking surface and the bottom of an unprotected wood or metal cabinet; or 24" (60.9 cm) minimum when bottom of wood or metal cabinet is protected by not less than 1/4" (0.64 cm) flame retardant millboard covered with not less than no. 28 MSG sheet steel, 0.015" (0.381 mm) stainless steel, 0.024" (0.610 mm) aluminum or 0.020" (0.508 mm) copper.

\*\* 15" (38.1 cm) minimum between countertop and adjacent cabinet bottom.

## Installing the Anti-tip Device

### WARNING

#### Tip - Over Hazard

A child or adult can tip the range and be killed. Verify the anti-tip bracket has been installed. Ensure the anti-tip bracket is engaged when the range is moved. Do not operate the range without the anti-tip bracket in place. Failure to follow these instructions can result in death or serious burns to children and adults.



To check that leveling leg is inserted into anti-tip bracket, grasp the top rear edge of the range and carefully attempt to tilt it forward.

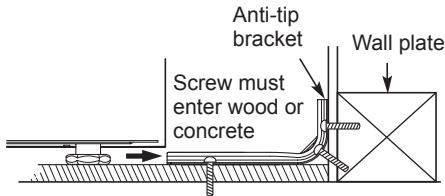
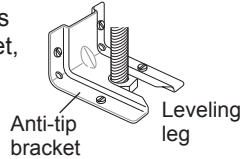

### Locate the anti-tip bracket using the template

An anti-tip bracket is packaged with the template. The instructions include necessary information to complete the installation. Read and follow the range installation instruction sheet (template).

### Leveling the Range

Level the range by adjusting the leveling legs with a wrench. Extending the legs slightly may also make it easier to insert the rear leg into the anti-tip bracket.

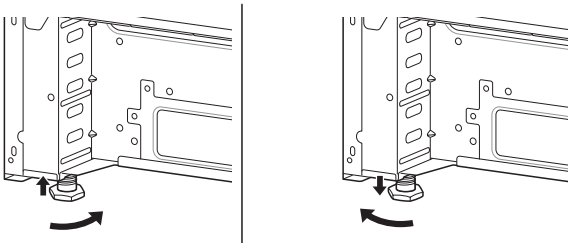

Use a level to check your adjustments. Place the level diagonally on the oven rack, and check each direction for level.

First check direction ①.

Then check direction ②. If the level doesn't show level on the rack, adjust the leveling legs with a wrench.

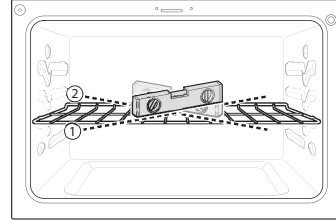

## Optional Rear Filler

If the counter does not bridge the opening at the rear wall, use the rear filler kit provided with the slide-in range.

### NOTE

If the countertop depth is greater than 26" there will be a gap between the filler kit and the back wall.

If the countertop depth is less than 25", the control panel will not sit flush with the countertop.

### Installing the Rear Filler

- 1 Using a screwdriver, remove the upper four screws that attach the rear bracket and loosen the lower two screws.
- 2 Place the rear filler on the rear bracket.
- 3 Tighten the two lower screws on the rear bracket. Insert one of the screws removed in step 1 in the slot at each end of the rear filler.
- 4 Store the remaining two screws with these instructions for future use.

## Providing Adequate Gas Supply

The range is designed to operate at a pressure of 5" of water column on natural gas or 10" of water column on LP.

Make sure you are supplying the range with the type of gas for which it is configured.

This range is convertible for use on natural or LP gas. When using this range on LP gas, conversion must be made by a qualified LP installer before attempting to operate the range.

For proper operation, the pressure of natural gas supplied to the regulator must be between 5" and 13" of water column.

For LP gas, the pressure supplied to the regulator must be between 10" and 13" of water column. When checking for correct operation of the regulator, the inlet pressure must be at least 1" more than the operating (manifold) pressure as given above.

The pressure regulator located at the inlet of the range must remain in the supply line regardless of which type of gas is being used.

A flexible metal appliance connector used to connect the range to the gas supply line should have an I.D. of  $\frac{5}{8}$ " and a maximum length of 5 feet. In Canada, flexible connectors must be single wall metal connectors less than 6 feet in length.

## Connecting the Range to Gas

Shut off the range gas supply valve before removing the old range and leave it off until the new hook-up has been completed.

Because hard piping restricts movement of the range, a CSA International-certified flexible metal appliance connector should be used unless local codes require a hard-piped connection.

A manual valve shall be installed in an accessible location in the gas piping external to the appliance for the purpose of turning on or shutting off gas to the appliance.

Never reuse an old connector when installing a new range.

To protect against gas leaks, use a qualified pipe joint sealant on all external threads.

- 1 Install a male  $\frac{1}{2}$ " or  $\frac{3}{4}$ " flare union adapter to the NPT internal thread of the manual shut-off valve, taking care to back-up the shut-off valve to keep it from turning.
- 2 Install a male  $\frac{1}{2}$ " flare union adapter to the  $\frac{1}{2}$ " NPT internal thread at the inlet of the pressure regulator. Use a backup wrench on the pressure regulator fitting to prevent damage.
- 3 Connect a flexible metal appliance connector to the adapter on the range. Position the range to permit connection at the shut-off valve.
- 4 When all connections have been made, be sure all range controls are in the **Off** position and turn on the main gas supply valve. Gas leaks may occur in your system and create a hazard. Gas leaks may not be detected by smell alone.

Check all gas connection joints and fittings for leaks with a non-corrosive leak detection fluid, then wipe off.

Gas suppliers recommend you purchase and install a UL approved gas detector. Install and use in accordance with the installation instructions.



### WARNING

- Do not use a flame to check for gas leaks.
- Isolate the range from the gas supply system by closing its individual shut-off valve during any pressure testing of the gas supply system at test pressures equal to or less than  $\frac{1}{2}$ " psig (3.5 kPa).

### Flexible Connector Hookup

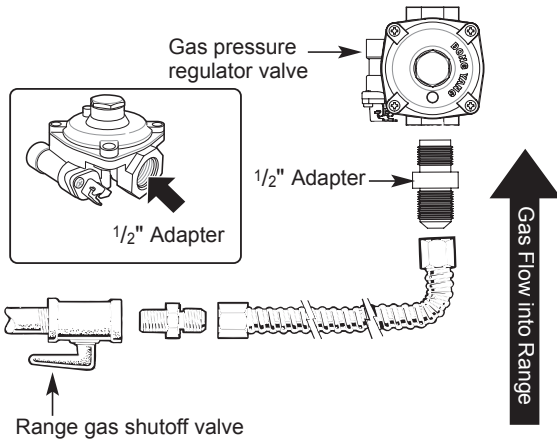

Installer: Inform the consumer of the location of the gas shutoff valve.

### Pressure Regulator Position

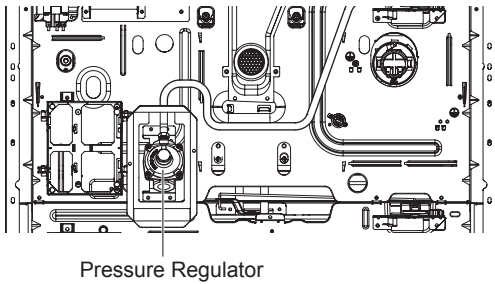

### WARNING

- Allow 2 to 3 ft (61.0 cm to 91.4 cm) of slack in the line so that the range can be moved if servicing is ever necessary.
- The power supply cord and plug should not be modified. If it will not fit the outlet, have a proper outlet installed by a qualified electrician.
- Using an extension cord to connect the power is prohibited. Connect the power cord and plug directly.
- Electrical ground is required on this appliance.
- Make sure that the power cord is not pinched by the range or heavy objects. Failure to do so can result in serious burns or electrical shock.
- Do not use a damaged power plug, power cord, or loose power outlet.
- Do not put a fuse in a neutral or ground circuit.
- Do not connect the ground wire to plastic plumbing lines, gas lines, or hot water pipes.

### Specified power-supply-cord kit rating

Range rating, watts		Specified rating of power supply-cord kit, amperes	Diameter (inches) of Range connection Opening	
			Power cord	Conduit
120/240 volts 3-wire	120/208 volts 3-wire	40 or 50A	1 3/8"	1 1/8"
8,750 - 16,500	7,801 - 12,500			
16,501 - 22,500	12,501 - 18,500	50	1 3/4"	1 3/8"

## Connecting Electricity

### Electrical Requirements

This appliance must be installed and grounded on a branch circuit by a qualified technician in accordance with the National Electrical code ANSI/NFPA NO. 70 - latest edition.

All wiring should conform to Local and NEC codes. This range requires a single-phase, 3 wire, A.C 120/208 V or 120/240 V 60 Hz electrical system. Use only a 3-conductor or a 4-conductor UL-listed range cord with closed-loop terminals, open-end spade lugs with upturned ends or similar termination. Do not install the power cord without a strain relief.

A range cord rated at 40 amps with 120/208 or 120/240 minimum volt range is required. If a 50 amp range cord is used, it should be marked for use with 1 3/8" diameter connection openings. This appliance may be connected by means of a conduit or power cord. If a conduit is being used, go to page 23 for **3 wire conduit connections** or **4 wire conduit connections**.

3, 4 - Wire electrical wall Receptacle



**4 Wire receptacle (14-50R)**



**3 Wire receptacle (10-50R)**

### Connecting the Power Cord

The rear access cover must be removed. Loosen the two screws with a screwdriver. The terminal block will then be accessible.

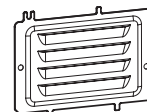

Access cover

Use the cord/conduit connection plate to install the power cord or conduit. Leave the connection plate as installed for power cord installations. Remove the connection plate for conduit installations and use the smaller 1<sup>1</sup>/<sub>8</sub> in. (2.8 cm) conduit hole instead of the 1<sup>3</sup>/<sub>8</sub> in. (3.5 cm) power cord hole.

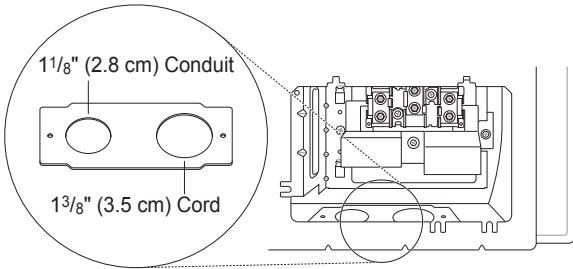

Remove the Conduit connection plate

For power cord installations, hook the strain relief over the 1<sup>3</sup>/<sub>8</sub> in. (3.5 cm) power cord hole located below the rear of the oven. Insert the power cord through the strain relief and tighten it.

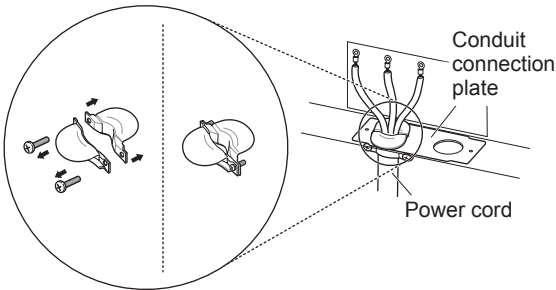

Assembling power cord strain relief at the 1<sup>3</sup>/<sub>8</sub>" opening

For conduit installations, insert the conduit strain relief in the 1<sup>1</sup>/<sub>8</sub> in. (2.8 cm) conduit hole. Then install the conduit through the body of the strain relief and fasten the strain relief with its ring.

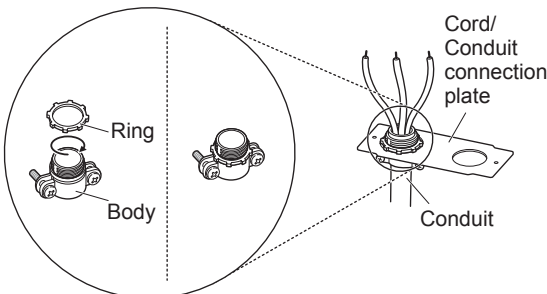

Assembling conduit cord strain relief at the 1<sup>1</sup>/<sub>8</sub>" opening

### 3-Wire Connection : Power Cord

#### **! WARNING**

- The middle (neutral or ground) wire, which is white, of a 3-wire power cord or a 3-wire conduit has to be connected to the middle post of the main terminal block. The remaining two wires of the power cord or conduit have to be connected to the outside posts of the main terminal connection block. Failure to do so can result in electrical shock, severe personal injury or death.

#### Install the power cord as follows:

For power cord installations, hook the strain relief over the power cord hole (1<sup>3</sup>/<sub>8</sub>" located below the rear of the oven. Insert the power cord through the strain relief and tighten it.

#### Do not install the power cord without a strain relief.

- 1 Remove the lower 3 screws from the terminal block and retain them.
- 2 Insert the 3 screws through each power cord terminal ring and into the lower terminals of the terminal block. Make sure that the center (neutral) wire, which is white, is connected to the center lower position of the terminal block.
- 3 Tighten the 3 screws securely into the terminal block. Do not remove the ground strap connections.

#### 3-wire connection

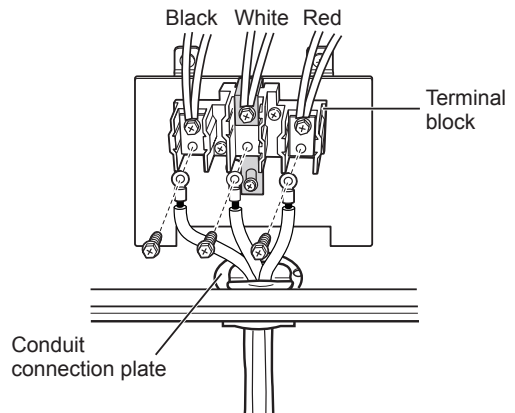

If screws are not tightened securely, it can result in electrical spark and severe personal injury or death.

### 4-Wire Connection : Power Cord

#### **WARNING**

- Only a 4-conductor power-supply cord kit rated 120/208 or 120/240 volts, 50 amperes and marked for use with ranges with closed-loop connectors or opened spade lugs with upturned ends shall be used. The white middle (neutral) wire of the power cord or 4-wire conduit has to be connected to the middle post of the main terminal block. The other two wires of the power cord or conduit have to be connected to the outside posts of the main terminal connection block. The 4th ground wire (green) must be connected to the frame of the range with the ground screw. Failure to do so can result in electrical shock, severe personal injury or death.

Install the power cord as follows:

**Do not install the power cord without a strain relief.**

- 1 Remove the lower 3 screws from the terminal block and retain them.
- 2 Remove the ground screw and bend the end of the ground strap up so the slot is over the hole of the center screw removed in step 1.
- 3 Insert the ground screw into the power cord ground wire (green) terminal ring and secure it to the range frame.
- 4 Insert the 3 screws through each power cord terminal ring and into the lower terminals of the terminal block. Make sure that the white center (neutral) wire is connected to the center lower position of the terminal block.
- 5 Tighten the 3 screws securely into the terminal block. The center screw now attaches the bent up ground strap to the block.

#### 4-wire connection

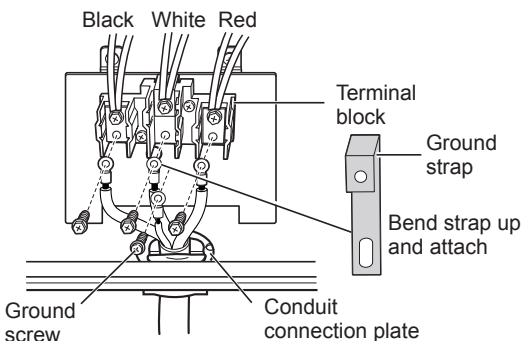

If screws are not tightened securely, it can result in electrical spark and severe personal injury or death.

### 3-Wire Connection: Conduit

Install the conduit as follows:

Remove the conduit connection plate from the rear of the oven and rotate it. The conduit hole (1 1/8") must be used.

First, prepare the conduit wires as shown below.

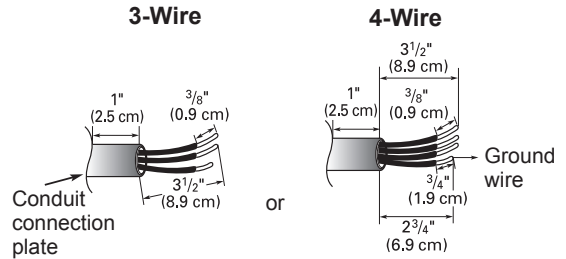

Second, install the conduit strain relief.

For conduit installations, purchase a strain relief and insert it in the 1 1/8 in. (2.8 cm) conduit hole. Then install the conduit through the body of the strain relief and fasten the strain relief with its ring. Reinstall the bracket.

For conduit connections:

If the wire in the conduit is copper it must be 8 or 10 AWG wiring.

If the wire in the conduit is aluminum it must be 6 or 8 AWG wiring.

- 1 Loosen the lower 3 screws from the terminal block.
- 2 Insert the bare wire (white/neutral) end through the center terminal block opening. Do not remove the ground strap connections.
- 3 Insert the two side bare wire ends into the lower left and the lower right terminal block openings. Tighten the 3 screws securely into the terminal block. (approximately 35 - 50 IN-LB)

#### 3-wire connection

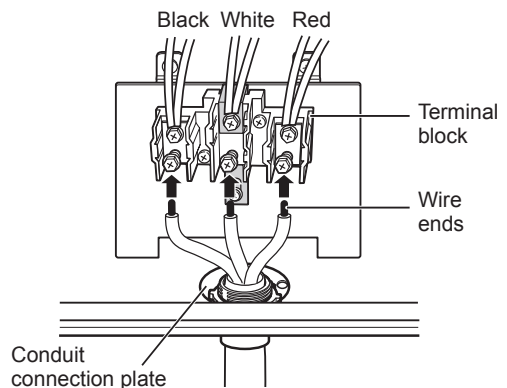

If screws are not tightened securely, it can result in electrical spark and severe personal injury or death.

## 4-Wire Connection: Conduit

### WARNING

- The white middle (neutral) wire of the power cord or 4-wire conduit has to be connected to the middle post of the main terminal block. The other two wires of the power cord or conduit have to be connected to the outside posts of the main terminal connection block. The 4th ground wire (green) must be connected to the frame of the range with the ground screw. Failure to do so can result in electrical shock, severe personal injury or death.

- 1 Follow the instructions for installing the conduit under 3-Wire Connection: Conduit until the strain relief and bracket are installed. Do not install the conduit without a strain relief.
- 2 Loosen the 2 lower left and right screws from the terminal block. Remove the lower 2 center screws. Do not discard any screws.
- 3 Remove the ground screw and bend the end of the ground strap up so the slot is over the hole of the center screw removed in step 1.
- 4 Attach the ground (green) bare wire end to the range frame and secure it in place with the ground screw.
- 5 Insert the bare wire (white/neutral) end through the center terminal block opening. The center screw now attaches the bent up ground strap to the block.
- 6 Insert the two side bare wire ends into the left and the right terminal block openings. Tighten the 3 screws securely into the terminal block. (approximately 35 - 50 IN-LB)

### 4-wire connection

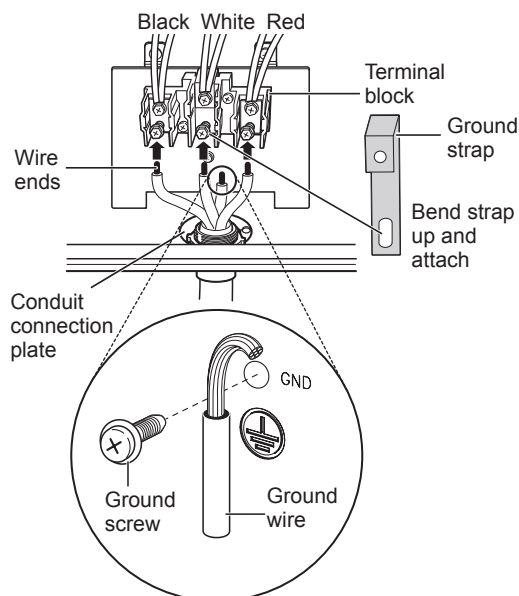

If screws are not tightened securely, it can result in electrical spark and severe personal injury or death.

## Engaging the Anti-tip Device

- Move the range close enough to the opening to plug into the receptacle.
- Slide the range into position ensuring that the back leg slides under the anti-tip bracket. The range should sit flush against the back wall when properly installed.
- Carefully attempt to tip the range forward to ensure that the anti-tip bracket is engaged properly. If properly installed, the anti-tip bracket will prevent the range from being tipped. If the range can be tipped, reinstall the range until the anti-tip bracket is properly installed and the range will not tip forward.
- Turn on electrical power. Check the range for proper operation.



## Test Run

Check if the range is properly installed and run a test cycle.

- 1 Remove all packing materials from inside the oven. Press **Lower Clear/Off** to start the test.
- 2 Check the oven's operation. Turn oven mode knob to select Lower Bake. 350 °F appears in the display.
- 3 Press Start.
- 4 The oven should finish preheating in 15 minutes, and the convection fan should operate while the oven is preheating.
- 5 After checking the oven's operation, turn the temperature up to 450 °F and leave the oven on for at least an hour to help remove any oil which might cause smoke and odors when first using the oven.

### NOTE

Smoke may come out of the range when it is first used.



## Assembling the Surface Burners

### CAUTION

Do not operate the burners without all parts in place.

Place the burner caps and heads on the cooktop. Make sure that the caps and heads are placed in the correct locations. There is one small, one medium, one large, one oval(center), and one extra large burner head and cap.

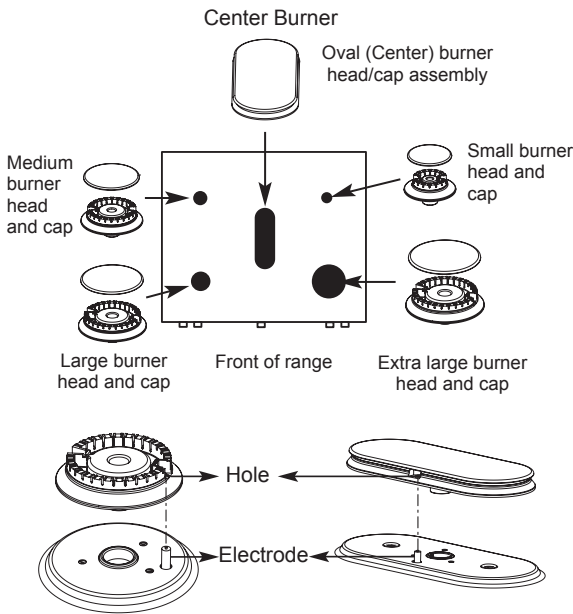

Make sure the hole in the burner head is positioned over the electrode.

## Checking Ignition of the Surface Burners

### Electric Ignition

Select a surface burner knob and simultaneously push in and turn to the **Lite** position. You will hear a clicking sound indicating proper operation of the spark module.

Once the air has been purged from the supply lines the burner should ignite within 4 seconds. After the burner ignites, rotate the knob out of the **Lite** position. Try each burner in succession until all burners have been checked.

## Quality of Flames

The combustion quality of the burner flames needs to be confirmed visually.



A **Yellow flames** - Call for service.



B **Yellow tips on outer cones** - This is normal for LP gas.



C **Soft blue flames** - This is normal for natural gas.

### NOTE

- With LP gas, some yellow tipping on outer cones is normal.

## Adjusting the Surface Burner to the Low Flame (Simmer) Setting

- 1 Light all surface burners.
- 2 Turn the knob on the burner being adjusted to **Lo**.
- 3 Remove the knob.
- 4 Insert a small, flat-blade screwdriver into the valve shaft.

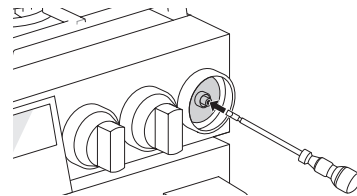

### NOTE

Hold the valve shaft with one hand while turning the screw to adjust with the other.

- 5 Replace the knob.
- 6 Test the flame stability.
 

Test 1: Turn the knob from **Hi** to **Lo** quickly. If the flame goes out, increase the flame size and test again.

Test 2: With the burner on a **Lo** setting, open and close the oven door quickly. If the flame is extinguished by the air currents created by the door movement, increase the flame height and test again.
- 7 Repeat steps 1-6 for each surface burner.

# OPERATION

## Control Panel Overview

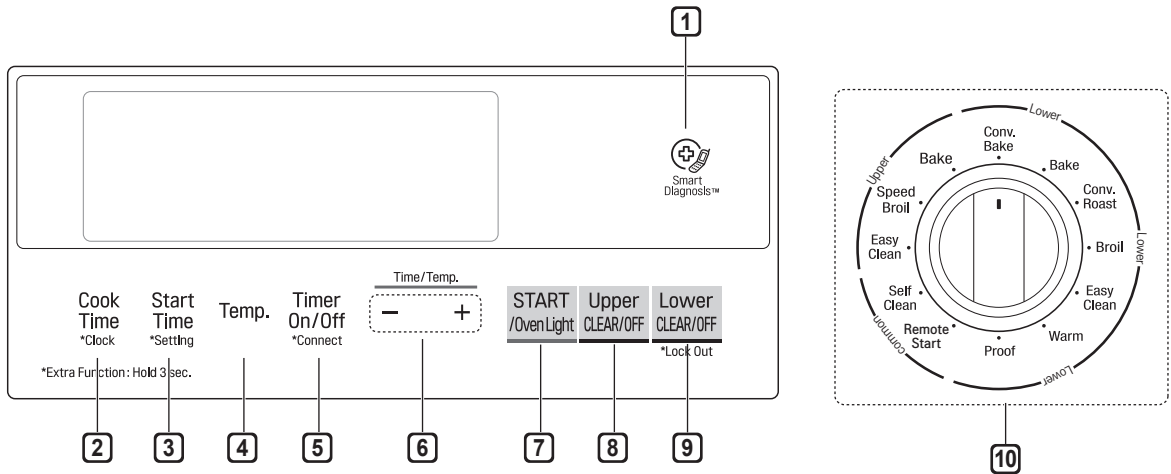

### 1 Smart Diagnosis™

Use during the Smart Diagnosis feature.

### 2 Cook Time / Clock

- Press the button to set the desired amount of time for food to cook. The oven shuts off when the set cooking time runs out.
- Press and hold button for three seconds to set the time of day.

### 3 Start Time / Setting

- Press the button to set the delayed timed cook. The oven starts at the set time.
- Press and hold button for three seconds to select and adjust oven settings.

### 4 Temp.

- Press the button to change the oven or meat probe temperature during cooking.

### 5 Timer On/Off / Connect

- Press the button to set or cancel automatic timer.
- Press and hold button for three seconds to connect to Wi-Fi network.

### 6 - /+

Press the plus button to increase cooking time or oven temperature.  
Press the minus button to decrease cooking time or oven temperature.

### 7 START / Oven Light

- Press the button to start all oven features.
- Press the button to manually turn the oven light on/off.

### 8 Upper CLEAR/OFF

Press the button to end all upper oven features.

### 9 Lower CLEAR/OFF / Lock Out

- Press the button to end all lower oven feature.
- Press and hold button for three seconds to lock the door and control panel.

### 10 Oven Mode Knob

Turn the knob to select oven operating mode.

## Changing Oven Settings

### Clock

The clock must be set to the correct time of day in order for the automatic oven timing functions to work properly.

- 1 Press and hold Cook Time for three seconds. CLO shows in the display.
- 2 Press **plus(+)** or **minus(-)** to select the desired time. Plus(+) to increase the time and minus(-) to decrease the time.
- 3 Press **Start** to enter the time and start the clock.

#### NOTE

- The time of day cannot be changed during a timed baking or self-clean cycle.

### Oven Light

The interior oven light automatically turns on when the door is opened. Press **Oven Light** to manually turn the oven light on.

#### NOTE

- The oven light cannot be turned on if the Self Clean function is active.

## Minimum & Maximum Default Settings

All of the features listed have a minimum and a maximum time or temperature setting that may be entered into the control. An entry acceptance beep sounds each time a control key is pressed.

An entry error tone (two short tones) sounds if the entry of the temperature or time is below the minimum or above the maximum setting for the feature.

Feature		min. Temp. / Time	max. Temp. / Time	Default
Clock	12 Hr.	1:00 Hr. / min.	12:59 Hr. / min.	
	24 Hr.	0:00 Hr. / min.	23:59 Hr. / min.	
Timer	12 Hr.	0:10 min.	11:59 Hr. / min.	
	24 Hr.	0:10 min.	11:59 Hr. / min.	
Cook Time	12 Hr.	1:00 min.	11:59 Hr. / min.	
	24 Hr.	1:00 min.	11:59 Hr. / min.	
Conv. Bake		300 °F / 150 °C	550 °F / 285 °C	350 °F (*325 °F)/ 12 Hr.
Conv. Roast		300 °F / 150 °C	550 °F / 285 °C	350 °F (*325 °F)/ 12 Hr.
Speed Broil & Broil		Lo 400 °F	Hi 500 °F	Hi / 3 Hr.
Bake		170 °F / 80 °C	550 °F / 285 °C	350 °F / 12 Hr.
Proof		1:00 min.	11:59 Hr. / min.	
Warm				3 Hr.
Self Clean		3 Hr.	5 Hr.	4 Hr.
EasyClean®				10 min.

\* Using Auto Conversion

- Default cook mode times are without setting cook time.

## Timer On/Off

The Lower Timer On/Off serves as an extra timer in the kitchen that beeps when the set time has run out. It does not start or stop cooking.

The Timer On/Off feature can be used during any of the oven control function.

### Setting the Timer (for example to set 5 minutes)

- 1 Press **Timer On/Off**. 0:00 with HR inside it appears and Timer flashes in the display.
- 2 Press **plus(+)** or **minus(-)** to select the desired time. Plus(+) increases the time and minus(-) decreases the time.
- 3 Press **Timer On/Off** or **Start** to start the Timer. The remaining time countdown appears in the display.
- 4 When the set time runs out, **End** shows in the display. The indicator tones sound every 15 seconds until **Timer On/Off** is pressed.

#### NOTE

- If the remaining time is not in the display, recall the remaining time by pressing **Timer On/Off**.
- Press **Timer On/Off** twice to set the time in minutes and seconds.
- Press **Timer On/Off** once to set the time in hours and minutes.

### Cancelling the Timer

- 1 Press **Timer On/Off** once.

## Connect

The Connect button is used to connect the appliance to a home Wi-Fi network.

- 1 Press **Upper CLEAR/OFF** and **Lower CLEAR/OFF**.
- 2 Press and hold **Timer On/Off** for 3 seconds.
- 3 The power-on chime sounds, Set appears in the display, and the Wi-Fi icon (📶) blinks.
- 4 Register the appliance on the Wi-Fi network using the smart phone app. (See page 42.)
- 5 To disconnect the appliance from the network, press and hold **Timer On/Off** for 3 seconds.

## Settings

Press and hold **Start Time** for three seconds. Then press the **Start Time** key repeatedly to toggle through and change oven settings.

The **Settings** key allows you to:

- set the hour mode on the clock (12 or 24 hours)
- enable/disable convection auto conversion
- adjust the oven temperature
- activate/deactivate the preheating alarm light
- set the beeper volume
- switch the temperature scale between Fahrenheit and Celsius

### Setting the Hour Mode

The control is set to use a 12-hour clock. To reset the clock to 24-hour mode, follow the steps below.

- 1 Press and hold **Start Time** for three seconds.
- 2 Press **plus(+)** or **minus(-)** to set the desired hour mode on the clock.
- 3 Press **Start** to accept the desired change.

### Setting Convection Auto Conversion

When **Conv. Bake** and **Conv. Roast** are selected, Convection Auto Conversion automatically converts the standard recipe temperature entered to a convection temperature by subtracting 25 °F / 14 °C. This auto-converted temperature shows on the display. For example, select **Conv. Bake**, enter 350 °F, and 325 °F shows on the display after preheat.

Convection Auto Conversion is enabled by default. To change the setting, follow these instructions.

- 1 Press and hold **Start Time** for three seconds. Then press **Start Time** repeatedly until **Auto** appears in the display
- 2 Press **plus(+)** or **minus(-)** to enable or disable the feature.
- 3 Press **Start** to accept the change.

## Adjusting the Oven Temperature

Your new oven may cook differently from the one it replaced. Use your new oven for a few weeks to become more familiar with it before changing the temperature settings. If after familiarizing yourself with the new oven, you still think that it is too hot or too cold, you can adjust the oven temperature yourself.

### NOTE

To begin, either raise or lower the thermostat 15 °F (8 °C). Try the oven with the new setting. If the oven still needs adjustment, raise or lower the thermostat again, using the first adjustment as a gauge. For example, if the adjustment was too much, raise or lower the thermostat 10 °F (5 °C). If the adjustment was not enough, raise or lower the thermostat 20 °F (12 °C). Proceed in this way until the oven is adjusted to your satisfaction.

- 1 Press and hold **Start Time** for three seconds. Then press **Start Time** repeatedly until **U\_AJ** or **L\_AJ** appears in the display.
- 2 To increase the temperature, press **plus (+)** until the desired amount appears in the display. To decrease the temperature, press **minus (-)** until the desired amount appears in the display.
- 3 Press **Start** to accept the change.

### NOTE

- This adjustment does not affect the broiling or Self Clean temperatures. The adjustment is retained in memory after a power failure. The oven temperature can be increased (+) or decreased (-) as much as 35 °F or 19 °C.
- Once the temperature is increased or decreased, the display shows the adjusted temperature until it readjusts.

## Turning the Preheat Alarm Light On/Off

When the oven reaches its set-temperature, the preheating alarm light flashes 5 times or until the oven door is opened.

You can activate or deactivate the preheating alarm light.

- 1 Press and hold **Start Time** for three seconds. Then press **Start Time** repeatedly until **PrE** appears in the display.
- 2 Press **plus(+)** or **minus(-)** to turn the function on/off.
- 3 Press **Start** to accept the change.

## Adjusting the Beeper Volume

- 1 Press and hold **Start Time** for three seconds. Then press **Start Time** repeatedly until **BEEP** appears in the display.
- 2 Press **plus(+)** or **minus(-)** to select the desired volume.
- 3 Press **Start** to accept the change.



## Selecting Fahrenheit or Celsius

Set the oven temperature display to show either Fahrenheit (°F) or Celsius (°C) units. The oven defaults to Fahrenheit unless changed by the user.

- 1 Press and hold **Start Time** for three seconds. Then press **Start Time** repeatedly until **Unit** appears in the display.
- 2 Press **plus(+)** or **minus(-)** to select F(Fahrenheit) or C(Centigrade).
- 3 Press **Start** to accept the change.

## Lock Out

The Lock Out feature automatically locks the oven door and prevents most oven controls from being turned on. It does not disable the clock, timer or the interior oven light.

- 1 Press and hold **Lower CLEAR/OFF** for three seconds.
- 2 The lock melody sounds, **Loc** appears in the Display and the lock icon  blinks in the display.
- 3 Once the oven door is locked, the lock  indicator stops blinking and remains on.
- 4 To deactivate the Lock Out feature, press and hold **Lower CLEAR/OFF** for three seconds. The unlock melody sounds and the door and the controls unlock.

## Start Time (Delayed Timed Cook)

The automatic timer of the Delayed Timed Cook function turns the oven on and off at the time you select. This feature can be used with the **Bake**, **Conv. Bake** and **Conv. Roast** modes.

### Setting a Delayed Timed Cook

For example, to bake at 300 °F and delay the start of baking until 4:30, first set the clock for the correct time of day.

- 1 Turn the oven mode knob to select the **Bake** mode. 350 °F appears in the display.
- 2 Set the temperature: press **minus(-)** until 300 °F appears in the display.
- 3 Press **Cook Time** and press plus (+) or minus (-) to set the baking time.
- 4 Press **Start Time**.
- 5 Set the start time: press **plus(+)** until 4:30 appears in the display.
- 6 Press **Start**. A short beep sounds and **Timed Delay** and the start time appear in the display. The oven begins baking at the set start time.

#### NOTE

- To cancel the Delayed Timed Cook function, Press **Clear/Off** at any time.
- To change the cooking time, repeat step 3 and press **Start**.
- If the oven clock is set as a 12-hour clock, you can delay the cook time for 12 hours. If the oven clock is set as a 24-hour clock, you can delay the cook time for 24 hours.

The oven will continue to cook for the set amount of time and then turn off automatically. When the cooking time has elapsed:

- **End** and the time of day show in the display.
- The cook-end indicator tone sounds every 60 seconds until **Clear/Off** is Pressed.



#### CAUTION

- Use the automatic timer when cooking cured or frozen meats and most fruits and vegetables. Foods that can easily spoil, such as milk, eggs, fish, meat or poultry, should be chilled in the refrigerator. Even when chilled, they should not stand in the oven for more than 1 hour before cooking begins, and should be removed promptly when cooking is completed.
- Eating spoiled food can result in sickness from food poisoning.

## Cook Time (Timed Cook)

Set the oven to cook for a specific length of time using the Timed Cook feature. This feature can only be used with the **Bake**, **Conv. Bake** and **Conv. Roast** modes.

### Setting the Cook Time Function

For example, to bake at 300 °F for 30 minutes, first set the clock to the correct time of day.

- 1 Turn the oven mode knob to select the **Bake** mode. 350 °F appears in the display.
- 2 Set the oven temperature. For this example, press **minus(-)** until 300 °F appears in the display.
- 3 Press **Cook Time**. **Timed** flashes in the display. **Bake**, 0:00 and 300 °F appear in the display.
- 4 Set the baking time: press **plus(+)** until 30:00 appears in the display. The baking time can be set for any amount of time between 1 minute and 11 hours and 59 minutes.
- 5 Press **Start**.

The oven will continue to cook for the set amount of time and then turn off automatically. When the cooking time has elapsed:

- **End** and the time of day show in the display.
- The cook end indicator tone sounds every 60 seconds until **Clear/Off** is Pressed.

### Changing the Cook Time during Cooking

For example, to change the cook time from 30 minutes to 1 hour and 30 minutes, do the following.

- 1 Press **Cook Time**.
- 2 Change the baking time: press **plus(+)** until 1 hour and 30 minutes appears in the display.
- 3 Press **Start** to accept the change.

## Using the Gas Surface Burners

### Before Use

Read all instructions before using.

**Make sure that all burners are properly placed.**

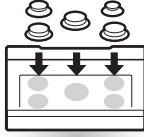

**Make sure that all grates are properly placed before using the burner.**

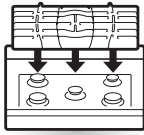

### CAUTION

Do not operate the burner for an extended period of time without cookware on the grate.

The finish on the grate may chip without cookware to absorb the heat.

**Make sure the burners and grates are cool before touching them, or placing a pot holder, cleaning cloth, or other materials on them.**

Touching grates before they cool down may cause burns.



### CAUTION

#### WHAT TO DO IF YOU SMELL GAS

- Open windows.
- Do not try to light any appliance.
- Do not touch any electrical switch.
- Do not use any phone in your building.
- Immediately call your gas supplier from a neighbor's phone. Follow the gas supplier's instructions.
- If you cannot reach your gas supplier, call the fire department.

#### NOTE

Electric spark igniters from the burners cause a clicking noise. All the spark igniters on the cooktop will activate when igniting just one burner.

## Burner Locations

Your gas range cooktop has four or five sealed gas burners, depending on the model. These can be assembled and separated. Follow the guide below.

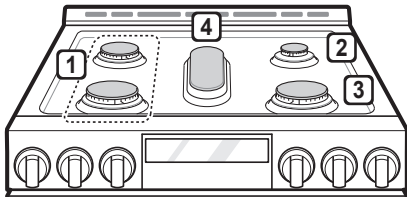

### 1 Medium and Large Burners

The medium and large burners are the primary burners for most cooking. These general purpose burners can be turned down from **Hi** to **Lo** to suit a wide range of cooking needs.

### 2 Small Burner

The smallest burner is used for delicate foods such as sauces or foods that require low heat for a long cooking time.

### 3 Extra Large Burner

The extra large burner is the maximum output burner. Like the other four burners, it can be turned down from **Hi** to **Lo** for a wide range of cooking applications. This burner is also designed to quickly bring large amounts of liquid to a boil. It can be used with cookware 10 inches or larger in diameter.

### 4 Oval Burner

The center, oval burner is for use with a griddle or oval pots.

## Using the Gas Surface Burners

- 1 Be sure that all of the surface burners and grates are placed in the correct positions.
- 2 Place cookware on the grate.
- 3 Push the control knob and turn to the **Lite** position.

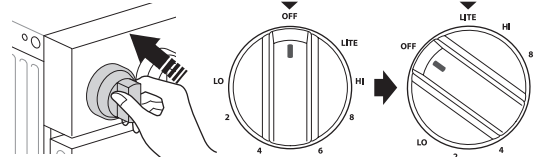

The electric spark ignition system makes a clicking noise.

- 4 Turn the control knob to control the flame size.

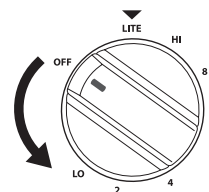

### CAUTION

Do not attempt to disassemble or clean around any burner while another burner is on. All the burners spark when any burner is turned to **Lite**. An electric shock may result causing you to knock over hot cookware.

## Setting the Flame Size

Watch the flame, not the knob, as you reduce heat. Match the flame size on a gas burner to the cookware being used for fastest heating.

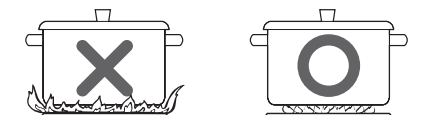

### CAUTION

Never let the flames extend up the sides of the cookware.

### NOTE

- The flames on the surface burners may burn yellow in the presence of high humidity, such as a rainy day or a nearby humidifier.
- After LP gas conversion, flames can be bigger than normal when you put a pot on the surface burner.
- When turning a surface burner from high heat to simmer quickly, make sure the flames stay lit. See page 25 to adjust the burner flames, if necessary.



## In Case of Power Failure

In case of a power failure, you can light the gas surface burners on your range with a match.

Surface burners in use when an electrical power failure occurs will continue to operate normally.

- 1 Hold a lit match to the burner, then push in the control knob.
- 2 Turn the control knob to the **Lo** position.

### ⚠ CAUTION

Use extreme caution when lighting burners with a match. Doing so can cause burns and other damage.

## Range-Top Cookware

Aluminum	Medium-weight cookware is recommended because it heats quickly and evenly. Most foods brown evenly in an aluminum skillet. Use saucepans with tight fitting lids when cooking with minimum amounts of water.
Cast-Iron	If heated slowly, most skillets will give satisfactory results.
Stainless Steel	This metal alone has poor heating properties and is usually combined with copper, aluminum or other metals for improved heat distribution. Combination metal skillets work satisfactorily if they are used with medium heat as the manufacturer recommends.
Enamelware	Under some conditions, the enamel of this cookware may melt. Follow cookware manufacturer's recommendations for cooking methods.
Glass	There are two types of glass cookware. Those for oven use only and those for top-of-range cooking.
Heatproof Glass Ceramic	Can be used for either surface or oven cooking. It conducts heat very slowly and cools very slowly. Check cookware manufacturer's directions to be sure it can be used on gas ranges.

## Using a Wok

14-inch or smaller flat-bottomed woks can be used directly on the grate. Make sure that the wok bottom sits flat on the grate.

### ⚠ CAUTION

If using a round-bottomed wok, use the included wok grate. Do not use a wok support ring. Placing the ring over the burner or grate may cause the burner to work improperly, resulting in carbon monoxide levels above allowable standards. This can be hazardous to your health.

## Using the Wok Grate

Use the included wok grate to support a 12" to 14" round-bottomed wok.

- 1 Turn off all burners and allow the grates and cooktop to cool before installing or removing the wok grate. Remove the griddle, if necessary. Do not remove the standard burner grates.
- 2 Place the wok grate on top of the left or right front burner grate, aligning the notches on the wok grate with the burner grate's fingers. Make sure the side marked **FRONT** is toward the front.

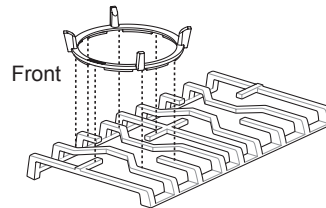

- 3 Make sure the wok grate is stable and the wok rests firmly on the wok grate. Use a 12" to 14" round-bottomed wok. Do not use a wok that is the wrong size to fit securely in the wok grate.

### NOTE

- The wok grate and griddle cannot be used at the same time.
- For best performance, place the wok grate over the extra large, right front burner.
- Do not use the wok grate with cookware other than a wok.
- Clean the wok grate with hot, soapy water. Do not use oven cleaners, steel wool, or abrasive cleansers. Do not clean with the self-clean mode.

**CAUTION**

- Turn off all burners and allow wok grate, burner grates, and cooktop to cool before installing or removing wok grate.
- The wok grate retains hot for a long time. Always use an oven mitt when installing or removing the wok grate. Do not store the wok grate on the burner grate.
- Do not use flat-bottomed cookware or incorrectly sized woks with the wok grate. The cookware or wok could tip and cause personal injury.
- Do not use a wok larger than 14" with the wok grate. Doing so could cause burner flames to spread excessively and damage the cooktop.

**Using Stove-Top Grills**

Do not place stove-top grills on the burner.

**CAUTION**

Do not use stove top grills on the surface burners. Using a stove top grill on the surface burner will cause incomplete combustion and can result in exposure to carbon monoxide levels above allowable current standards. This can be a health hazard.

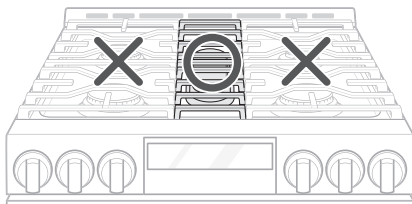
**Using the Griddle**

The non-stick coated griddle provides an extra-large cooking surface for meats, pancakes or other food usually prepared in a frying pan or skillet.

**NOTE**

It is normal for the griddle to become discolored over time.

**CAUTION**

- Do not remove the center grate when using the griddle.
- Do not remove the griddle plate until the cooktop grates, surfaces and griddle plate have completely cooled.
- The griddle plate on the cooktop may become very hot when using the cooktop, oven or broiler systems. Always use oven mitts when placing or removing the griddle plate.

Preheat the griddle according to the guide below and adjust for the desired setting.

Type of Food	Preheat Conditions	Cook Setting
Warming Tortillas	-	5 (MED)
Pancakes	HI 5 min.	HI
Hamburgers	HI 5 min.	HI
Fried Eggs	HI 5 min.	HI
Bacon	HI 5 min.	HI
Breakfast Sausage Links	HI 5 min.	HI
Hot Sandwiches	HI 5 min.	HI

**NOTE**

After cooking on the griddle for an extended period, adjust the griddle temperature settings as the griddle retains heat.

**IMPORTANT NOTES**

- Avoid cooking extremely greasy foods as grease spillover can occur.
- The griddle can become hot when surrounding burners are in use.
- Do not overheat the griddle. This can damage the non stick coating.
- Do not use metal utensils that can damage the griddle surface. Do not use the griddle as a cutting board.
- Do not place or store items on the griddle.

# Using the Oven

## Before Using the Oven

### NOTE

- Because the oven temperature cycles, an oven thermometer placed in the oven cavity may not show the same temperature that is set on the oven.
- It is normal for the convection fan to run while preheating during a regular bake cycle.
- The convection fan motor may run periodically during a regular bake cycle.
- The heat turns off if the door is left open during baking. If the door is left open for longer than 30 seconds during baking, the heat turns off. The heat turns back on automatically once the door is closed.

## Oven Vent

Areas near the vent may become hot during operation and may cause burns. Do not block the vent opening. Avoid placing plastics near the vent as heat may distort or melt the plastic.

It is normal for steam to be visible when cooking foods with high moisture content.

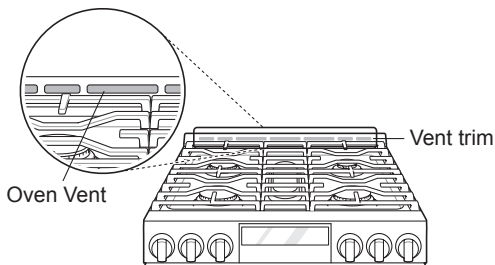

### CAUTION

- **The edges of the range vent and vent trim are sharp and may become hot during operation.** Wear gloves when cleaning the range to avoid burns or other injury.

## Using Oven Racks

The racks have a turned-up back edge that prevents them from being pulled out of the oven cavity.

### Removing Racks

- 1 Pull the rack straight out until it stops.
- 2 Lift up the front of the rack and pull it out.

### Replacing Racks

- 1 Place the end of the rack on the support. Make sure rack is level and both sides are in the same rack position.
- 2 Tilt the front end up and push the rack in.

### CAUTION

- Replace oven racks before turning the oven on to prevent burns.
- Do not cover the racks with aluminum foil, or any other material, or place anything on the bottom of the oven. Doing so will result in poor baking and may damage the oven bottom.
- Only arrange oven racks when the oven is cool.

## Bake

Bake is used to prepare foods such as pastries, breads and casseroles. The oven can be programmed to bake at any temperature from 170 °F (80 °C) to 550 °F (285 °C). The default temperature is 350 °F (175 °C).

### Setting the Bake Function (example, 375 °F)

- 1 Turn the oven mode knob to select **Bake**.
- 2 Set the oven temperature: For example, press **plus(+)** until 375 °F appears in the display.
- 3 Press **Start**. The oven starts to preheat.

As the oven preheats, the temperature is displayed and rises in 5 degree increments. Once the oven reaches the set temperature, a tone sounds and the oven light blinks on and off.

- 4 When cooking is complete, press **Clear/Off**.
- 5 Remove food from the oven.

### NOTE

It is normal for the convection fan to operate periodically throughout a normal bake cycle in the lower oven. This is to ensure even baking results.

### Changing the Temperature during Cooking

- 1 Press **Temp**.
- 2 Press + or – to increase or decrease the set temperature.
- 3 Press **Start**.

### Baking Tips

- Baking time and temperature will vary depending on the characteristics, size, and shape of the baking pan used.
- Check for food doneness at the minimum recipe time.
- Use metal bakeware (with or without a nonstick finish), heatproof glass-ceramic, ceramic or other bakeware recommended for oven use.
- Dark metal pans or nonstick coatings will cook food faster with more browning. Insulated bakeware will slightly lengthen the cooking time for most foods.

#### NOTE

The oven bottom has a porcelain-enamel finish. To make cleaning easier, protect the oven bottom from excessive spillovers by placing a cookie sheet on the rack below the rack you are cooking on. This is particularly important when baking a fruit pie or other foods with a high acid content. Hot fruit fillings or other foods that are highly acidic may cause pitting and damage to the porcelain-enamel surface and should be wiped up immediately.

### Convection Mode

The convection system uses a fan to circulate the heat evenly within the oven. Improved heat distribution allows for even cooking and excellent results while cooking with single or multiple racks.

#### Setting the Convection Function (example, 375 °F)

- 1 Turn the oven mode knob to select the **Conv. Bake** or **Conv. Roast**.
- 2 Set the oven temperature: For example, press **plus(+)** until 375 °F appears in the display.
- 3 Press **Start**. The display shows **Conv. Bake** or **Conv. Roast** and the oven temperature starting at 100 °F.

As the oven preheats, the display shows increasing temperatures in 5-degree increments. Once the oven reaches the set adjusted temperature, a tone sounds and the oven light flashes on and off. The display shows the auto-converted oven temperature, 350 °F and the fan icon.

- 4 When cooking has finished or to cancel, press **Clear/Off**.

#### NOTE

The oven fan runs while convection baking. The fan stops when the door is open. In some cases, the fan may shut off during a convection bake cycle.

### Tips for Convection Baking

- Use Convection Bake for faster and more even multiple-rack cooking of pastries, cookies, muffins, biscuits, and breads of all kinds.
- Bake cookies and biscuits on pans with no sides or very low sides to allow heated air to circulate around the food. Food baked on pans with a dark finish will cook faster.
- When using Convection Bake with a single rack, place the oven rack in position 3. If cooking on multiple racks, place the oven racks in positions 1 and 3 (for two racks).
- Multiple oven rack cooking may slightly increase cook times for some foods.
- Cakes, cookies and muffins have better results when using multiple racks.

The Convection Roast feature is designed to give optimum roasting performance. Convection Roast combines cooking with the convection fan to roast meats and poultry. The heated air circulates around the food from all sides, sealing in juices and flavors. Foods are crispy brown on the outside while staying moist on the inside. Convection roasting is especially good for large tender cuts of meat, uncovered.

### Tips for Convection Roasting

Use a broiler pan and grid when preparing meats for convection roasting. The broiler pan catches grease spills and the grid helps prevent grease splatters.

- 1 Place the oven rack in the bottom rack position.
- 2 Place the grid in the broiler pan.
- 3 Place the broiler pan on the oven rack.

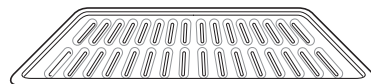

Grid (sold separately)

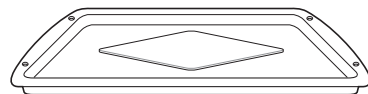

Broiler pan (sold separately)



#### CAUTION

- Do not use a broiler pan without a grid.
- Do not cover the grid with aluminum foil.
- Position food (fat side up) on the grid.

## Recommended Baking and Roasting Guide

Baking results will be better if baking pans are centered in the oven as much as possible. If cooking on multiple racks, place the oven racks in the positions shown.

### Rack and Pan Placement

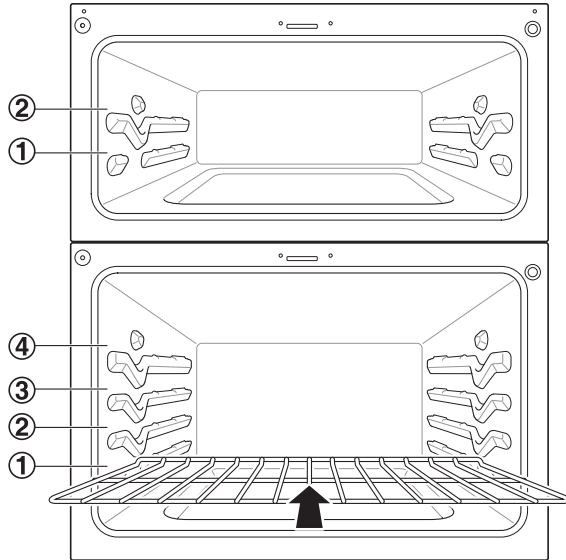

### Multiple rack baking

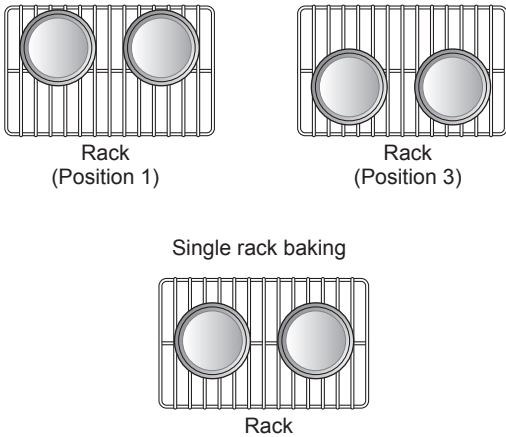

### Baking rack guide

Food	Rack position		
	Upper Oven	Lower Oven	
<b>Cakes</b>	• Layer cakes	1	3
	• Bundt cakes	1	3
<b>Cookies</b>	• Sugar cookies	1	3
	• Chocolate chips	1	3
	• Brownies	1	3
<b>Pizza</b>	• Fresh	2	2
	• Frozen	2	2
<b>Pastry Crust</b>	• From scratch	1	2
	• Refrigerator	1	2
<b>Breads</b>	• Biscuit, canned	1	3
	• Biscuit, from scratch	1	2
	• Muffins	1	2
<b>Desserts</b>	• Fruit crisps and cobblers, from scratch	1	3
	• Pies, from scratch, 2-crust fruit	1	2

### Roasting rack guide

Food	Rack position		
		Lower Oven	
<b>Beef</b>	Rib	Rare	1
		Medium	1
		Well done	1
	Boneless rib, top sirloin	Rare	1
		Medium	1
		Well done	1
Beef tenderloin	Rare	1	
	Medium	1	
<b>Pork</b>	Rib		1
	Bone-in, sirloin		1
	Ham, cooked		1
<b>Poultry</b>	Whole chicken		1
	Chicken pieces		1
	Turkey		1

## Broil

The Broil function uses intense heat from the upper heating element to cook food. Broiling works best for tender cuts of meat, fish, and thinly cut vegetables.

Some models may feature a hybrid broiler consisting of an inner broiler that utilizes a carbon heating element which provides instantaneous heat, and a traditional outer broiling element. During normal broiler operation, it is normal for either element to cycle off intermittently.

### CAUTION

- Do not use a broiler pan without a grid. Oil can cause a grease fire.
- Do not cover the grid and broiler pan with aluminum foil. Doing so will cause a fire.
- Always use a broiler pan and grid for excess fat and grease drainage. This will help to reduce splatter, smoke, and flare-ups.
- Do not broil meat too close to the burner flame. Trim excess fat from meat before cooking.

### NOTE

- This range is designed for closed-door broiling. Close the door to set the Broil function. If the door is open, the Broil function cannot be set and **door** appears on the display. Close the door and reset the Broil function. Opening the door turns off the broil burner during broiling. If the door is opened during broiling, the broil burner turns off after five seconds. The broiler turns back on automatically once the door is closed.

## Speed Broil

The Speed Broil setting is designed to reduce the amount of time it takes to broil foods. By utilizing the infrared broil element, which provides heat instantaneously, there is no need for preheating.

### Setting the oven to Broil / Speed Broil

- 1 Turn the oven mode knob to select **Broil** or **Speed Broil**. Press **plus(+)** or **minus(-)** to select **Hi** or **Lo**.
- 2 Press **Start**. The oven begins to heat.
- 3 Let the oven preheat for approximately five minutes before cooking the food if using broil.
- 4 Press **Clear/Off** to cancel at any time or when cooking is complete.

## Smoking

Due to the intense heat associated with broiling, it is normal to experience smoke during the cooking process. This smoke is a natural byproduct of searing and should not cause you to worry. If you are experiencing more smoke than you are comfortable with, use the following tips to reduce the amount of smoke in your oven.

- 1 Always use a broiler pan. Do not use saute pans or regular baking sheets for safety reasons.
- 2 The broiler pan should always be thoroughly cleaned and at room temperature at the beginning of cooking.
- 3 Always run your cooktop ventilation system or vent hood during broiling.
- 4 Keep the interior of your oven as clean as possible. Leftover debris from prior meals can burn or catch fire.
- 5 Avoid fatty marinades and sugary glazes. Both of these will increase the amount of smoke you experience. If you would like to use a glaze, apply it at the very end of cooking.
- 6 If you are experiencing significant smoke with any food item, consider:
  - Lowering the broiler to the Lo setting.
  - Lowering the rack position to cook the food further away from the broiler.
  - Using the Hi broil setting to achieve the level of searing you desire, and then either switching to the Lo broil setting, or switching to the Bake function.
- 7 As a rule, fattier cuts of meat and fish will produce more smoke than leaner items.
- 8 Adhere to the recommended broil settings and cooking guidelines in the chart on the following page whenever possible.

## Recommended Broiling Guide

The size, weight, thickness, starting temperature, and your preference of doneness will affect broiling times.

This guide is based on meats at refrigerator temperature. For best results when broiling, use a pan designed for broiling.

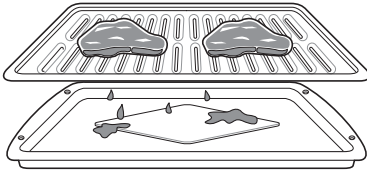

Food	Quantity and/or Thickness	Upper oven			Lower oven			Comments
		Rack Position	First Side (minutes)	Second Side (minutes)	Rack Position	First Side (minutes)	Second Side (minutes)	
<b>Ground Beef</b> Well done	1 lb. (4 patties) 1/2 to 3/4" thick	2	4-7	2-5	4	4-7	3-5	Space evenly. For 1-4 patties, use Speed Broil in upper oven. For more than 4 patties, use Broil in lower oven.
<b>Beef Steaks</b> Rare Medium Well done	1" thick 1 to 1 1/2 lbs.	2 2 2	3-4 4-5 5-6	2-3 2-3 3-4	4 4 4	4-5 4-7 6	2-3 3-4 4-5	Steaks less than 1" thick cook through before browning. Pan frying is recommended. Slash fat.
Rare Medium Well done	1 1/2" thick 2 to 2 1/2 lbs.	1 1 1	8 9 10	3-4 4-5 5-6	3 3 3	10 10-12 12	4 5-6 6-8	
<b>Chicken</b>	1 whole cut up 2 to 2 1/2 lbs., split lengthwise 2 Breasts	1 1	10 8-10	4-6 3-5	3 3	14-16 8-9	4-6 3-5	
<b>Lobster Tails</b>	2-4 10 to 12 oz. each	-	-	-	2	14	Do not turn over	Cut through back of shell. Spread open. Brush with melted butter before broiling and after half of broiling time.
<b>Fish Fillets</b>	1/4 to 1/2" thick	2	5	2-3	4	6	3-4	Handle and turn very carefully. Brush with lemon butter before and during cooking, if desired.
<b>Ham Slices</b> (precooked)	1/2" thick	2	4-5	2-3	4	6-8	2-4	Increase time 5 to 10 minutes per side for 1 1/2" thick or home-cured ham.
<b>Pork Chops</b> Well done	1 (1/2" thick) 2 (1" thick) about 1 lb.	2 1	7 7	3-5 2-4	4 3	5-6 9-10	2-4 4-6	
<b>Lamb Chops</b> Medium Well done	2 (1" thick) about 10 to 12 oz.	2 2	4-5 5-6	2-3 3-4	4 4	6 8	3-4 4-5	
Medium Well done	2 (1 1/2" thick) about 1 lb.	1 1	9 10	4-5 5-6	3 3	10 12	5-6 6-8	
<b>Salmon Steaks</b>	2 (1" thick) 4 (1" thick) about 1 lb.	2 1	6 7	3-5 3-5	4 3	8 9	4-6 4-6	Grease pan. Brush steaks with melted butter.

- This guide is only for reference. Adjust cook time according to your preference.
- For best performance, center food on rack when using Speed Broil/Broil.

## Tips for Broiling

### Beef

- Steaks and chops should always be allowed to rest for five minutes before being cut into and eaten. This allows the heat to distribute evenly through the food and creates a more tender and juicy result.
- Pieces of meat that are thicker than two inches should be removed from the refrigerator 30 minutes prior to cooking. This will help them cook more quickly and evenly, and will produce less smoke when broiling. Cooking times will likely be shorter than the times indicated in the Broiling Chart.
- For bone-in steaks or chops that have been *frenched* (all meat removed from around the bone), wrap the exposed sections of bone in foil to reduce burning.

### Seafood

- When broiling skin-on fish, always use the Lo broil setting and always broil the skin side last.
- Seafood is best consumed immediately after cooking. Allowing seafood to rest after cooking can cause the food to dry out.
- It is a good idea to rub a thin coating of oil on the surface of the broiling pan before cooking to reduce sticking, especially with fish and seafood. You can also use a light coating of non-stick pan spray.

### Vegetables

- Toss your vegetables lightly in oil before cooking to improve browning.

## Warm

This function will maintain an oven temperature of 170 °F. The Warm function will keep cooked food warm for serving up to three hours after cooking has finished. The Warm function may be used without any other cooking operations.

### Setting the Warm Function

- 1 Turn the oven mode knob to select **Warm**.
- 2 Press **Start**.
- 3 Press **Clear/Off** at any time to cancel.

#### NOTE

- The Warm function is intended to keep food warm. Do not use it to cool food down.
- It is normal for the fan to operate during the Warm function.

## Proof

This feature maintains a warm oven for rising yeast leavened products before baking.

### Setting the Proof Function

- 1 Use rack position 2 or 3 for proofing.
- 2 Turn the oven mode knob to select **Proof**.
- 3 Press **Start**.
- 4 Press **Clear/Off** when proofing is finished.

#### NOTE

- To avoid lowering the oven temperature and lengthening proofing time, do not open the oven door unnecessarily. Check bread products early to avoid over proofing.
- Do not use the proofing mode for warming food or keeping food hot. The proofing oven temperature is not hot enough to keep foods at safe temperatures. Use the Warm feature to keep food warm. Proofing does not operate when the oven is above 125 °F. **Hot** shows in the display.
- It is normal for the fan to operate during the Proof function.

## Meat Probe

The meat probe accurately measures the internal temperature of meat, poultry and casseroles. It should not be used during broiling, self clean, warming or proofing. Always unplug and remove the meat probe from the oven when removing food. Before using, insert the probe into the center of the thickest part of the meat or into the inner thigh or breast of poultry, away from fat or bones. Place food in the oven and connect the meat probe to the jack. Keep the probe as far away from heat sources as possible.

### Using the Meat Probe

- 1 Insert the meat probe into the meat.

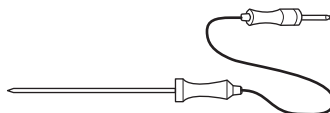

- 2 Connect the meat probe to the jack.
- 3 The meat probe icon flashes in the display if the meat probe is properly connected.



### Setting the Meat Probe Function (example for Roast 375 °F with probe temp. 160 °F)

- 1 Select cook mode. Turn the oven mode knob to select **Conv. Roast**.
- 2 Set the oven temperature: press **plus(+)** or **minus(-)** until 375 °F appears in the display.
- 3 Press **Start**.
- 4 Set the probe temperature: press **plus(+)** or **minus(-)** until 160 °F appears in the display.
- 5 Press **Start**.

The default probe temperature is 150 °F (65 °C), but can be changed to any temperature between 80 °F (27 °C) and 210 °F (100 °C). The display shows the changing probe temperature. When the set probe temperature is reached, the oven shuts off automatically.

### Changing the Probe Temperature while Cooking

- 1 Press **Temp**.
- 2 Set the oven temperature and probe temperature.
- 3 Press **Start**.

### IMPORTANT NOTE

Press Clear/Off to cancel the Meat Probe function at any time. To avoid breaking the probe, make sure food is completely defrosted before inserting.



### CAUTION

- **Always use an oven mitt to remove the temperature probe. Do not touch the broil element.** Failure to obey this caution can result in severe personal injury.
- **To avoid damage to the meat probe, Do not use tongs to pull on the probe when removing it.**
- **Do not store the meat probe in the oven.**

### Recommended Probe Temperature Chart

Doneness	Probe Temp.
<b>Beef, Lamb and Veal</b>	
Rare	130 °F (54 °C)
Medium Rare	140 °F (60 °C)
Medium	150 °F (66 °C)
Well Done	160 °F (71 °C)
<b>Pork</b>	
Well Done	170 °F (77 °C)
<b>Poultry</b>	
Breast, Well Done	170 °F (77 °C)
Thigh, Well Done	180 °F (82 °C)
Stuffing, Well Done	165 °F (74 °C)

### Remote Start

If the appliance is registered on a home Wi-Fi network, this function starts or stops the pre-heating function of the appliance. Follow the instructions on page 42 to register the appliance on the network.

Set the oven mode knob to the Remote Start position to use the function.

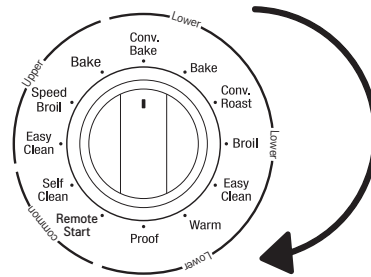

### Setting Remote Start

- 1 Open the oven door to make sure the oven is empty and ready for pre-heating. Do not place food in the oven. Close the oven door.
- 2 Within 30 seconds of closing the door, turn the oven mode knob to select Remote Start.
- 3 When ON appears in the display, the Remote Start function is ready to use.
- 4 Follow the directions in the smart phone app to set Remote Start times.

### NOTE

Remote Start is disconnected in the following situations:

- Remote Start is never set up in the smart phone app.
- The Remote Start status is “ready.”
- Remote Start experiences a problem during operation.

# SMART FEATURES

## Before Using Smart Features

The Smart Features allow you to conveniently use Smart Diagnosis™, set the cook mode and communicate with the appliance using a smart phone. To use the Smart Features, you will need the following devices and apps:

- 1 A wireless router and home Wi-Fi network.
- 2 The LG SIGNATURE Range oven.
- 3 An Android-based smart phone.
- 4 The Smart ThinQ app from the Google Play Store.

## Product Registration

- 1 Search for the Smart ThinQ application from the Google Play Store on a smart phone. Install and open the Smart ThinQ application.
- 2 Create an account and sign in.
- 3 Select **Register**.
- 4 Select **Built-In** and **Oven**.
- 5 Choose your home wireless router from the list of routers in the app. If necessary, enter the password for your router and click the connect button in the app.
- 6 Press and hold the Timer On/Off button on the control panel for three seconds. The Connect Icon (📶) should blink while the connection is being made.
- 7 The app will automatically go through the process of registering your product on the network, using the information you've provided. This may take some time, and the Connect Icon (📶) will continue to blink during this process. After the registration process is completed, a message is displayed and the app shows the product status screen.
- 8 Verify the Wi-Fi connection. The Connect icon (📶) should be illuminated.



## Using the Wi-Fi Function

Communicate with the appliance from a smart phone using the convenient smart features.

### Using the Application

- 1 Select the appliance in the application and connect it to a Wi-Fi network.
- 2 Select the menu on the upper right side to access settings and features.

### Cleaning

This function helps you to check the energy efficiency, usage and guide of EasyClean®.

### Smart Diagnosis™

This function provides useful information for diagnosing and solving issues with the appliance based on the pattern of use.

### Settings

Allows you to set various options on the oven and in the Application.

### Monitoring

This function helps you recognize the current status, remaining time, cook settings and end time on the screen.

### Push Alerts

Turn on the Push Alerts to receive appliance status notifications.

The notifications are triggered even if the Smart ThinQ application is off.

### Timer

You can set the timer from the application.

**IMPORTANT** : Features could be added or deleted when the Smart ThinQ application is updated. Data saved on the Smart ThinQ application could be deleted when the application is updated or you change smart phones.

**NOTE**

- LG SIGNATURE is not responsible for any network connection problems or any faults, malfunctions, or errors caused by network connection.
- The machine supports 2.4 Ghz Wi-Fi networks only.
- If the appliance is having trouble connecting to the Wi-Fi network, it may be too far from the router.  
Purchase a Wi-Fi repeater (range extender) to improve the Wi-Fi signal strength.
- The Wi-Fi connection may not connect or may be interrupted because of the home network environment.
- The network connection may not work properly depending on the internet service provider.
- The surrounding wireless environment can make the wireless network service run slowly.
- This information is current at the time of publication. The application is subject to change for product improvement purposes without notice to users.

## Open Source Software Notice Information

To obtain the source code under GPL, LGPL, MPL, and other open source licenses, that is contained in this product, please visit <http://opensource.lge.com>.

In addition to the source code, all referred license terms, warranty disclaimers and copyright notices are available for download.

LG Electronics will also provide open source code to you on CD-ROM for a charge covering the cost of performing such distribution (such as the cost of media, shipping, and handling) upon email request to [opensource@lge.com](mailto:opensource@lge.com). This offer is valid for three (3) years from the date on which you purchased the product.

## FCC Notice (For transmitter module contained in this product)

This equipment has been tested and found to comply with the limits for a Class B digital device, pursuant to Part 15 of the FCC Rules. These limits are designed to provide reasonable protection against harmful interference in a residential installation. This equipment

generates, uses, and can radiate radio frequency energy and, if not installed and used in accordance with the instructions, may cause harmful interference to radio communications. However, there is no guarantee that interference will not occur in a particular installation. If this equipment does cause harmful interference to radio or television reception, which can be determined by turning the equipment off and on, the user is encouraged to try to correct the interference by one or more of the following measures:

- Reorient or relocate the receiving antenna.
- Increase the separation between the equipment and the receiver.
- Connect the equipment to an outlet on a circuit different from that to which the receiver is connected.
- Consult the dealer or an experienced radio/TV technician for help.

This device complies with part 15 of the FCC Rules. Operation is subject to the following two conditions:

- 1) this device may not cause harmful interference and
- 2) this device must accept any interference received, including interference that may cause undesired operation of the device.

**CAUTION**

- Any changes or modifications in construction of this device which are not expressly approved by the party responsible for compliance could void the user's authority to operate the equipment.

## FCC RF Radiation Exposure Statement

This equipment complies with FCC radiation exposure limits set forth for an uncontrolled environment. This transmitter must not be collocated or operating in conjunction with any other antenna or transmitter.

This equipment should be installed and operated with minimum distance 20 cm (7.8 inches) between the antenna and your body. Users must follow the specific operating instructions for satisfying RF exposure compliance.

### Wireless LAN module (LCW-003) Specifications

Frequency Range	2412~2462 MHz
Output Power (max.)	IEEE 802.11 b : 17.56 dBm
	IEEE 802.11 g : 25.53 dBm
	IEEE 802.11 n : 25.29 dBm

# MAINTENANCE

## CAUTION

- Do not clean this appliance with bleach.
- To prevent burns, wait until the cooktop has cooled down before touching any of its parts.
- Always wear gloves when cleaning the cooktop.

## Gas Surface Burners

### Removing and Replacing the Gas Surface Burners

Grates and burner heads/caps can be removed for care and cleaning.

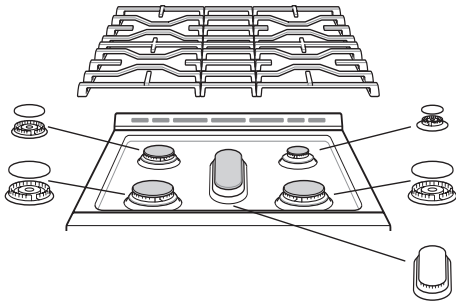

	General burner
Burner cap is properly set.	
Burner cap is NOT properly set.	

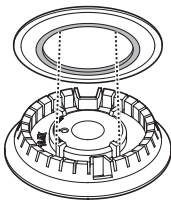

## CAUTION

Make sure Burner heads and caps are reinstalled properly. They will be stable and rest flat when correctly installed.

## Cleaning Burner Heads/Caps

For even and unhampered flame, the slits in the burner heads must be kept clean at all times. The burner heads and caps (and the oval burner head and cap assembly) can be lifted off. Do not attempt to remove the oval burner cap.

- Wash the burner caps in hot soapy water and rinse with clean water. Run water through the oval burner from the bottom stem to flush out debris.
- Use care when cleaning the cooktop. The pointed metal ends on the electrodes could cause injury. Hitting an electrode with a hard object may damage it.
- To remove burnt-on food, soak the burner heads in a solution of mild liquid detergent and hot water for 20–30 minutes. For stubborn stains, use a toothbrush or wire brush.
- The burners will not operate properly if the burner ports or electrodes are clogged or dirty.
- Burner caps and heads should be cleaned routinely, especially after excessive spillover.
- Burners will not light if the cap is removed.

## CAUTION

- Do not hit the electrodes with anything hard. Doing so could damage them.
- Do not use steel wool or scouring powders to clean the burners.
- Do not scratch or gouge the port features of the burner base.

## NOTE

- To clean port openings, use a stiff nylon bristle tooth brush.
- Do not use steel wool or steel bristle brushes as they can scratch the burner surface.

## After Cleaning the Burner Heads/ Caps

Shake out any excess water and then let them dry thoroughly. Placing the oval burner upside down will allow the water to drain out more easily. Replace the burner heads and caps over the electrodes on the cooktop in the correct locations according to their size. Make sure the hole in the burner head is positioned over the electrode.

## Burner Grates

The range consists of three separate professional-style grates. For maximum stability, these grates should only be used when in their proper position. The two side grates can be interchanged from left to right and front to back. The center grate can be interchanged from front to back.

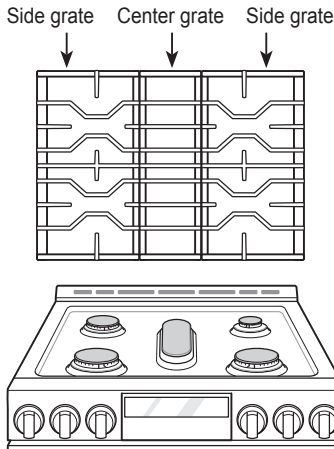

### NOTE

Do not operate a burner for an extended period of time without cookware on the grate. The finish on the grate may chip without cookware to absorb the heat.

## Cleaning the Burner Grates

### CAUTION

- Do not lift the grates out until they have cooled.
- Do not put the grate in the oven during self cleaning mode.
- Grates should be washed regularly and after spillovers.
- Wash the grates in hot, soapy water and rinse with clean water.
- The grates are dishwasher safe.
- After cleaning the grates, let them dry completely and securely position them over the burners.

## Cleaning the Cooktop Surface

### CAUTION

- To avoid burns, do not clean the cooktop surface until it has cooled.
- Do not lift the cooktop surface. Lifting the cooktop surface can lead to damage and improper operation of the range.
- When water is spilled on the cooktop, wipe up water immediately. If water is left on the cooktop for a long time, discoloration may occur.

Foods with high acid or sugar content may cause a dull spot if allowed to set. Wash and rinse soon after the surface has cooled. For other spills such as oil/grease spattering, etc., wash with soap and water when the surface has cooled, then rinse and polish with a dry cloth.

## Oven Air Vents

Air openings are located at the rear of the cooktop, at the top and bottom of the oven door, and at the bottom of the range.

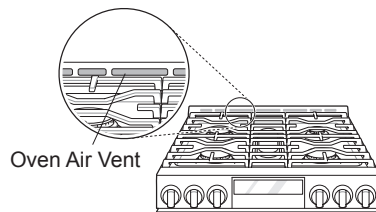

### CAUTION

- **The edges of the range vent are sharp.** Wear gloves when cleaning the range to avoid injury.
- Clean ventilating hoods frequently. Grease should not be allowed to accumulate on the hood or filter.

### NOTE

Do not block the vents and air openings of the range. They provide the air inlet and outlet that are necessary for the range to operate properly with correct combustion.

## Control Panel

To prevent activating the control panel during cleaning, unplug the range. Clean up splatters with a damp cloth using a glass cleaner. Remove heavier soil with warm, soapy water. Do not use abrasives of any kind.

## Front Manifold Panel and Knobs

It is best to clean the manifold panel after each use of the range. For cleaning, use a damp cloth and mild soapy water or a 50/50 solution of vinegar and water. For rinsing, use clean water and polish dry with a soft cloth.

The control knobs may be removed for easy cleaning.

- 1 To clean the knobs, make sure that they have the position indicator centered at the top or Off position and pull them straight off the stems. Be careful not to lose the knob springs.
- 2 To replace the knobs, make sure that the knobs have the position indicator centered at the top or **Off** position, and slide the knobs directly onto the stem.

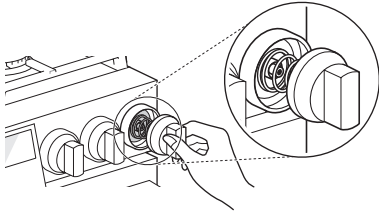

### CAUTION

- Do not use abrasive cleansers, strong liquid cleaners, plastic scouring pads or oven cleaners on the manifold panel. Doing so will damage the finish.
- Do not try to bend the knobs by pulling them up or down, and do not hang a towel or other objects on them. This can damage the gas valve shaft.
- If you slide the knobs onto the stem without the knob springs, it may cause malfunction.

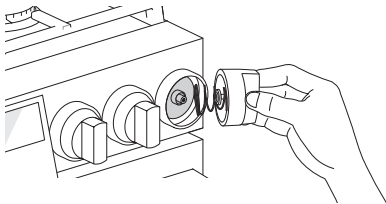

### NOTE

To prevent scratching, do not use abrasive cleaners on any of these materials.

## EasyClean®

LG's EasyClean® enamel technology provides two cleaning options for the inside of the range. The EasyClean® feature takes advantage of LG's new enamel to help lift soils without harsh chemicals, and it runs using **ONLY WATER** for just 10 minutes in low temperatures to help loosen **LIGHT** soils before hand-cleaning.

While EasyClean® is quick and effective for small and **LIGHT** soils, the Self Clean feature can be used to remove **HEAVY**, built up soils. The intensity and high heat of the Self Clean cycle may result in smoke which will require the opening up of windows to provide ventilation. Compared to the more intense Self Clean process, your LG oven gives you the option of cleaning with **LESS HEAT, LESS TIME**, and virtually **NO SMOKE OR FUMES**.

When needed, the range still provides the Self Clean option for longer, more thorough oven cleaning for heavier, built up soils.

### Benefits of EasyClean®

- Helps loosen light soils before hand-cleaning
- EasyClean® only uses water; no chemical cleaners
- Makes for a better self-clean experience
  - Delays the need for a self-clean cycle
  - Minimizes smoke and odors
  - Can allow shorter self-clean time

## When to Use EasyClean®

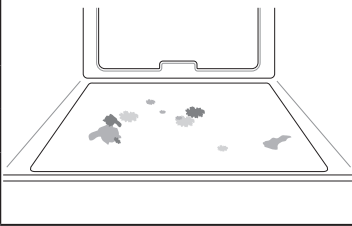
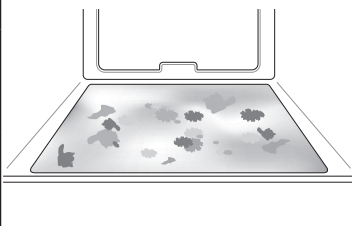
Suggested Cleaning Method	Example of Oven Soiling	Soil Pattern	Types of Soils	Common Food Items That Can Soil Your Oven
EasyClean®		Small drops or spots	Cheese or other ingredients	Pizza
		Light splatter	Fat/grease	Steaks, broiled
				Fish, broiled
				Meat roasted at low temperatures
Self Clean*		Medium to heavy splatter	Fat/grease	Meat roasted at high temperatures
		Drops or spots	Filling or sugar based soils	Pies
			Cream or tomato sauce	Casseroles

\* The Self Clean cycle can be used for soil that has been built up over time.

## Cleaning Tips

- Allow the oven to cool to room temperature before using the EasyClean® cycle. If your oven cavity is above 150 °F (65 °C), **Hot** will appear in the display, and the EasyClean® cycle will not be activated until the oven cavity cools down.
- A plastic spatula can be used as a scraper to scrape off any chunks or debris before and during oven cleaning.
- Using the rough side of a non-scratch scouring pad may help to take off burnt-on stains better than a soft sponge or towel.
- Certain non-scratch scrubbing sponges, such as those made of melamine foam, available at your local stores, can also help improve cleaning.
- The range should be level to ensure that the bottom surface of the oven cavity is entirely covered by water at the beginning of the EasyClean® cycle.
- For best results, use distilled or filtered water. Tap water may leave mineral deposits on the oven bottom.
- Soil baked on through several cooking cycles will be more difficult to remove with the EasyClean® cycle.
- Do not open the oven door during the EasyClean® cycle. Water will not get hot enough if the door is opened during the cycle.
- For hard to reach areas such as the back surface of the lower oven, it is better to use the Self Clean cycle.

## EasyClean® Instruction Guide

- 1 Remove oven racks and accessories from the oven.
- 2 Scrape off and remove any burnt-on debris with a plastic scraper.
 

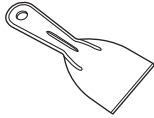

Suggested plastic scrapers:

  - Hard plastic spatula
  - Plastic pan scraper
  - Plastic paint scraper
  - Old credit card
- 3 Fill a spray bottle with 1¼ cups (10 oz or 300 ml) of water and use the spray bottle to thoroughly spray the inside surfaces of the oven.
- 4 Use at least ¼ cup (2 oz or 60 ml) of the water to completely saturate the soil on both the walls and in the corners of the oven.

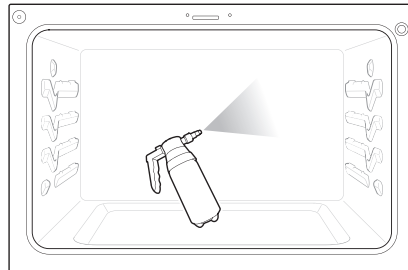

- 5** Spray or pour the remaining 1 cup (8 oz or 250 ml) of water onto the bottom center of the oven cavity. The indentation on the oven bottom should be fully covered to submerge all soils. Add water if necessary.

**NOTE**

Use the "mist" setting on the spray bottle for better coverage. The entire 1¼ cup (10 oz or 300 ml) of water should be used for each oven cavity cleaned. Do not spray water directly on the door. Doing so will result in water dripping to the floor.

- 6** Close the oven door. Turn the oven mode knob to select **EasyClean®**. Press **Start**.

**CAUTION**

- Some surfaces may be hot after the EasyClean® cycle. Wear rubber gloves while cleaning to prevent burns.
- During the EasyClean® cycle, the oven may become hot enough to cause burns. Wait until the cycle is over before wiping the inside surface of the oven. Failure to do so may result in burns.
- Avoid leaning or resting on the oven door glass while cleaning the oven cavity.

- 7** A tone will sound at the end of the 10 minute cycle. Press **Clear/Off** to clear the display and end the tone.

- 8** After the cleaning cycle and during hand-cleaning, enough water should remain on the oven bottom to completely submerge all soils. Add water if necessary. Place a towel on the floor in front of the oven to capture any water that may spill out during hand-cleaning.

- 9** Clean the oven cavity immediately after the EasyClean® cycle by scrubbing with a wet, non-scratch scouring sponge or pad. (The scouring side will not scratch the finish.) Some water may spill into the bottom vents while cleaning, but it will be captured in a pan under the oven cavity and will not hurt the burner.

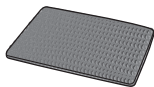
**NOTE**

Do not use any steel scouring pads, abrasive pads or cleaners as these materials can permanently damage the oven surface.

- 10** Once the oven cavity is cleaned, wipe any excess water with a clean dry towel. Replace racks and any other accessories.

- 11** If some light soils remain, repeat the above steps, making sure to thoroughly soak the soiled areas. If stubborn soils remain after multiple EasyClean® cycles, run the Self Clean cycle. Be sure that the oven cavity is empty of oven racks and other accessories, and that the oven cavity surface is dry before running the Self Clean cycle. Consult the Self Clean section of your owner's manual for further details.

**NOTE**

- If you forget to saturate the inside of the oven with water before starting EasyClean®, press **Clear/Off** to end the cycle. Wait for the range to cool to room temperature and then spray or pour water into the oven and start another EasyClean® cycle.
- The cavity gasket may be wet when the EasyClean® cycle finishes. This is normal. Do not clean the gasket.
- If mineral deposits remain on the oven bottom after cleaning, use a cloth or sponge soaked in vinegar to remove them.
- It is normal for the fan to operate during the EasyClean® cycle.



## Self Clean

The Self Clean cycle uses extremely hot temperatures to clean the oven cavity. While running the Self Clean cycle, you may notice smoking or an odor. This is normal; especially if the oven is heavily soiled.

During Self Clean, the kitchen should be well ventilated to minimize the odors from cleaning.

### Before Starting Self Clean

- Remove the oven racks, broiler pan, broiler grid, all cookware, aluminum foil or any other material from the oven.
- The kitchen should be well ventilated to minimize the odors from cleaning.
- Wipe any heavy spillovers on the bottom of the oven.
- Make sure that the oven light bulb cover is in place and the oven light is off.
- The oven light cannot be turned on during a Self Clean cycle. The oven light cannot be turned on until the oven temperature has cooled below 500 °F (260 °C) after a Self Clean cycle is complete.

### CAUTION

- Do not leave small children unattended near the appliance. During the Self Clean cycle, the outside of the range can become very hot to the touch.
- If you have pet birds, move them to another well-ventilated room. The health of some birds is extremely sensitive to the fumes given off during the Self Clean cycle of any range.
- Do not line the oven walls, racks, bottom or any other part of the range with aluminum foil or any other material. Doing so will destroy heat distribution, produce poor baking results and cause permanent damage to the oven interior (aluminum foil will melt to the interior surface of the oven).
- Do not force the door open. This can damage the automatic door locking system. Use care when opening the oven door after the Self Clean cycle. Stand to the side of the oven when opening the door to allow hot air or steam to escape. The oven may still be VERY HOT.

### NOTE

- Remove oven racks and accessories before starting the Self Clean cycle.
- If oven racks are left in the oven cavity during the Self Clean cycle, they will discolor and become difficult to slide in and out.
- Clean the frame of the oven and door with hot soapy water. Rinse well.
- Do not clean the gasket. The fiberglass material of the oven door gasket cannot withstand abrasion. It is essential for the gasket to remain intact. If you notice it becoming worn or frayed, replace it.
- Wipe up any heavy spillovers on the oven bottom.
- Make sure that the oven light bulb cover is in place and the oven light is off.
- It is normal for the fan to operate during the Self Clean cycle.

## Setting Self Clean

The Self Clean function has cycle times of 3, 4, or 5 hours.

### Self Clean Soil Guide

Soil Level	Cycle Setting
Lightly Soiled Oven Cavity	3-Hour Self Clean
Moderately Soiled Oven Cavity	4-Hour Self Clean
Heavily Soiled Oven Cavity	5-Hour Self Clean

- 1 Remove all racks and accessories from the oven.
- 2 Turn the oven mode knob to select **Self Clean**. The oven defaults to the recommended four-hour self clean for a moderately soiled oven. Press **plus(+)** or **minus(-)** repeatedly to cycle through self-clean times in the upper or lower oven. Both ovens cannot use the self-clean function at the same time.
- 3 Press **Start**.
- 4 Once the self-clean cycle is set, the oven door locks automatically and the lock icon displays. You will not be able to open the oven door until the oven has cooled. The lock releases automatically when the oven has cooled.

### CAUTION

Do not force the oven door open when the lock icon is displayed. The oven door remains locked until the oven temperature has cooled. Forcing the door open will damage the door.

## Setting Self Clean with a Delayed Start

- 1 Remove all racks and accessories from the oven.
- 2 Turn the oven mode knob to select **Self Clean**. The oven defaults to the recommended four-hour self clean for a moderately soiled oven. Press **plus(+)** or **minus(-)** repeatedly to cycle through self-clean times in the upper or lower oven. Both ovens cannot use the self-clean function at the same time.
- 3 Press **Start Time**.
- 4 Press **plus(+)** or **minus(-)** to enter the time of day you would like the Self Clean to start.
- 5 Press **Start**.

### NOTE

It may become necessary to cancel or interrupt a Self Clean cycle due to excessive smoke or fire in the oven. To cancel the Self Clean function, press **Clear/Off**.

## During Self Clean

- The Self Clean cycle uses extremely hot temperatures to clean the oven cavity. While running the Self Clean cycle, you may notice smoking or an odor. This is normal, especially if the oven is heavily soiled.
- As the oven heats, you may hear sounds of metal parts expanding and contracting. This is normal and will not damage the oven.
- Do not force the oven door open when the lock  is displayed. The oven door remains locked until the oven temperature has cooled. Forcing the door open will damage the door.

## After the Self Clean Cycle

- The oven door remains locked until the oven temperature has cooled.
- You may notice some white ash in the oven. Wipe it off with a damp cloth or a soap-filled steel wool pad after the oven cools. If the oven is not clean after one self-clean cycle, repeat the cycle.
- If oven racks were left in the oven and do not slide smoothly after a self-clean cycle, wipe racks and rack supports with a small amount of vegetable oil to make them glide more easily.
- Fine lines may appear in the porcelain because it went through heating and cooling. This is normal and will not affect performance.

### NOTE

- The Self Clean cycle cannot be started if the Lockout feature is active.
- Once the Self Clean cycle is set, the oven door locks automatically. You will not be able to open the oven door until the oven is cooled. The lock releases automatically.
- Once the door has been locked, the lock  indicator light stops flashing and remains on. Allow about 15 seconds for the oven door lock to activate.
- If the clock is set for a 12-hour display (default) the Delayed Self Clean can never be set to start more than 12 hours in advance.
- After the oven is turned off, the convection fan keeps operating until the oven has cooled down.

## Changing the Oven Light

The oven light is a standard 40-watt appliance bulb. It turns on when the oven door is open. When the oven door is closed, press and hold Start for three seconds to turn it on or off.

- 1 Unplug the range or disconnect power and make sure that the oven and bulb are cool first.
- 2 Turn the glass bulb cover in the back of the oven counterclockwise to remove.
- 3 Turn the bulb counterclockwise to remove it from the socket.
- 4 Insert the new bulb and turn it clockwise.
- 5 Insert the glass bulb cover and turn it clockwise.
- 6 Plug in the range or reconnect the power.

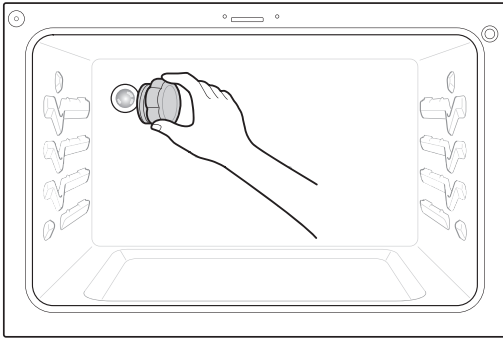

### **WARNING**

- Make sure that the oven and bulb are cool.
- Disconnect the electrical power to the range at the main fuse or circuit breaker panel. Failure to do so can result in severe personal injury, death, or electrical shock.

## Cleaning the Exterior

### Painted and Decorative Trim

For general cleaning, use a cloth with hot soapy water. For more difficult soils and built-up grease, apply a liquid detergent directly onto the soil. Leave it on for 30 to 60 minutes. Rinse with a damp cloth and dry. Do not use abrasive cleaners.

### Stainless Steel Surfaces

To avoid scratches, do not use steel wool pads.

- 1 Place a small amount of stainless steel appliance cleaner or polish on a damp cloth or paper towel.
- 2 Clean a small area, rubbing with the grain of the stainless steel if applicable.
- 3 Dry and buff with a clean, dry paper towel or soft cloth.
- 4 Repeat as necessary.

#### NOTE

- Do not use a steel wool pad. It will scratch the surface.
- To clean the stainless steel surface, use warm sudsy water or a stainless steel cleaner or polish.
- Always wipe in the direction of the metal surface finish.
- To purchase stainless steel appliance cleaner or polish, or to locate a dealer near you, call our toll-free customer service number: 1-800-984-6306 or visit our website at: [www.LGSIGNATURE.com](http://www.LGSIGNATURE.com)

### Oven Door

- Use soapy water to thoroughly clean the oven door. Rinse well. Do not immerse the door in water.
- You may use a glass cleaner on the outside glass of the oven door. Do not spray water or glass cleaner on the door vents.
- Do not use oven cleaners, cleaning powders, or harsh abrasive cleaning materials on the outside of the oven door.
- Do not clean the oven door gasket. The oven door gasket is made of a woven material that is essential for a good seal. Care should be taken not to rub, damage, or remove this gasket.

**CAUTION**

Do not use harsh cleaners or harsh abrasive cleaning materials on the outside of the oven door. Doing so can cause damage.

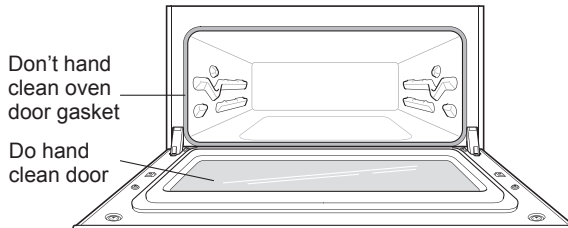

### Broiler Pan and Grid

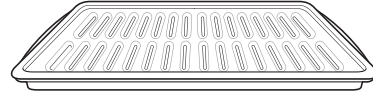

- Do not store a soiled broiler pan or grid anywhere in the range.
- Do not clean the broiler pan or grid in a self-cleaning mode.
- Remove the grid from the pan. Carefully pour out the grease from the pan into a proper container.
- Wash and rinse the broiler pan and grid in hot water with a soap-filled or plastic scouring pad.
- If food has burned on, sprinkle the grid with cleaner while hot and cover with wet paper towels or a dishcloth. Soaking the pan will remove burned-on foods.
- Both the broiler pan and grid may be cleaned with a commercial oven cleaner or in the dishwasher.

### Oven Racks

Remove the oven racks before operating the self clean cycle.

- 1 Food spilled into the tracks could cause the racks to become stuck. Clean racks with a mild, abrasive cleaner.
- 2 Rinse with clean water and dry.

**NOTE**

If the racks are cleaned using the self clean cycle (not recommended), the color will turn slightly blue and the finish will become dull. After the self clean cycle is complete, and the oven has cooled, rub the sides of the racks with wax paper or a cloth containing a small amount of vegetable oil. This will make the racks glide more easily into the rack tracks.

# Removing and Replacing the Lift-Off Oven Doors

## CAUTION

- Be careful when removing and lifting the door.
- Do not lift the door by the handle. The door is very heavy.

## Upper Oven

### Removing the Door

- 1 Fully open the door.
- 2 Lift up and rotate the hinge locks toward the hinge until they stop.

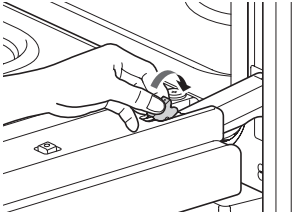

- 3 Close the door to 30 degrees (you will feel the door stop). The hinge locks will contact the oven frame.

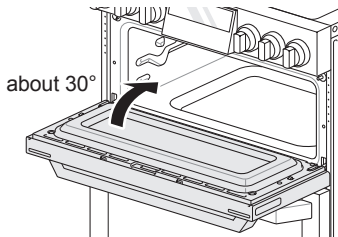

- 4 On both sides of the door, touch down on the release buttons on each hinge.

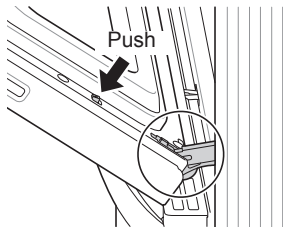

- 5 Lift the door up until it is clear of the hinges.

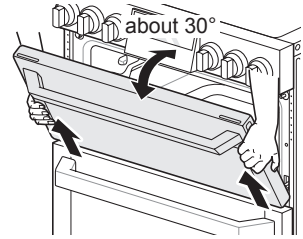

### Replacing the Door

- 1 Be sure both hinges are in a 30 degree position.
- 2 Slide the door back onto the hinges until you hear a solid click and the release buttons have engaged.

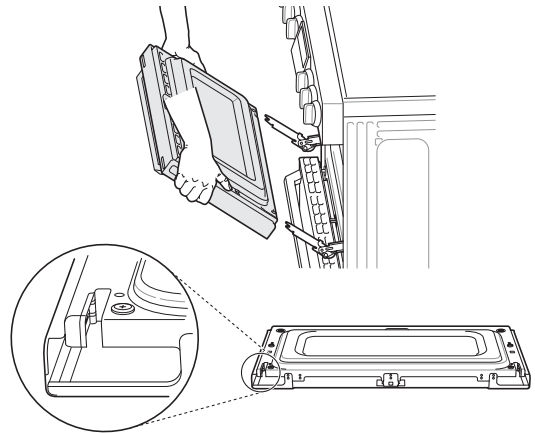

- 3 Fully open the door.
- 4 Push the hinge locks down onto the door frame.

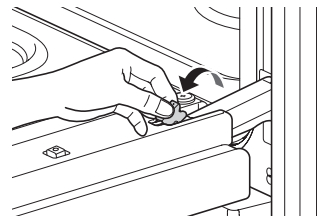

- 5 Close the oven door.

## Lower Oven

### Removing the Door

- 1 Fully open the door.
- 2 Unlock the hinge locks, rotating them as far toward the open door frame as they will go.

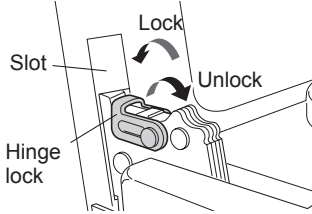

- 3 Firmly grasp both sides of the door at the top.
- 4 Close the door to the removal position (approximately five degrees) which is halfway between the broil stop position and fully closed. If the position is correct, the hinge arms will move freely.

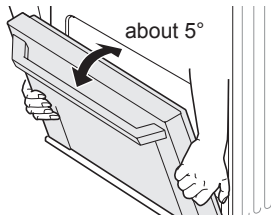

- 5 Lift door up and out until the hinge arms are clear of the slots.

### Replacing the Door

- 1 Firmly grasp both sides of the door at the top.
- 2 With the door at the same angle as the removal position, seat the indentation of the hinge arms into the bottom edge of the hinge slots. The notch in the hinge arms must be fully seated into the bottom edge of the slots.

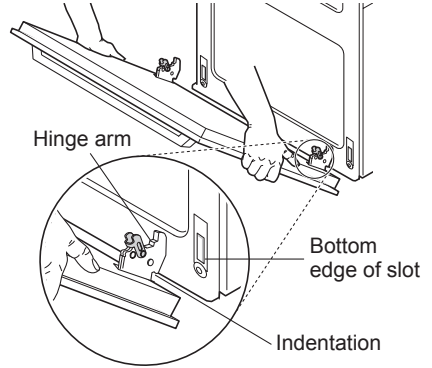

- 3 Open the door fully. If the door will not open fully, the indentation is not seated correctly in the bottom edge of the slots.
- 4 Lock the hinge locks, rotating them back toward the slots in the oven frame until they lock.

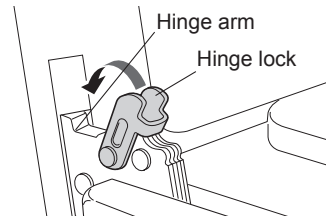

- 5 Close the oven door.

## Door Care Instructions

Most oven doors contain glass that can break.



### CAUTION

- Do not close the oven door until all the oven racks are fully in place.
- Do not hit the glass with pots, pans, or any other object.
- Scratching, hitting, jarring, or stressing the glass may weaken its structure causing an increased risk of breakage at a later time.

# TROUBLESHOOTING

## FAQs

### What types of cookware are recommended for use with the cooktop?

- The pans must have a flat bottom and straight sides.
- Only use heavy-gauge pans.
- The pan size must match the amount of food to be prepared and the size of the surface element.
- Use tight fitting lids.
- Only use flat-bottom woks or 12" to 14" round-bottom woks when using a LG supplied wok grate.

### Why do the heating elements appear to be turning ON and OFF during use of the cooktop or oven?

Depending on your cooktop element setting or the temperature selected in your oven, it is NORMAL for the cooking elements to cycle on and off.

### My new oven doesn't cook like my old one. Is there something wrong with the temperature settings?

No, your oven has been factory tested and calibrated. For the first few uses, follow your recipe times and temperatures carefully. If you still think your new oven is too hot or too cold, you can adjust the oven temperature yourself to meet your specific cooking needs. Refer to the Oven Temperature Adjustment section in this manual for easy instructions on how to adjust your thermostat.

### Is it normal to hear a clicking noise coming from the back of my oven when I am using it?

Your new range is designed to maintain a tighter control over your oven's temperature. You may hear your oven's heating elements click on and off more frequently on your new oven. This is NORMAL.

### Why is the time flashing?

This means that the product has just been plugged in, or that it has experienced a power interruption. To clear the flashing time, press any button and reset the clock if needed.

### During convection cooking the fan stops when I open the door. Is that normal?

Yes, this is normal. When the door is opened, the convection fan will stop until the door is closed.

### Can I use aluminum foil to catch drippings in my oven cavity?

Never use aluminum foil to line the bottom or sides of the oven. The foil will melt and stick to the bottom surface of the oven and will not be removable. Use a sheet pan lined with parchment paper and placed on a lower oven rack to catch drippings instead. (If foil has already melted onto the bottom of the oven, it will not interfere with the oven's performance.)

### Can I use aluminum foil on the racks?

Do not cover racks with aluminum foil. Covering entire racks with foil restricts air flow, leading to poor cooking results. Use a sheet pan lined with parchment paper under fruit pies or other acidic or sugary foods to prevent spills from damaging the oven finish.



### CAUTION

Foil may be used to wrap food in the oven, but do not allow the foil to come into contact with the exposed heating/broiling elements in the oven. The foil could melt or ignite, causing smoke, fire, or injury.

### Can I leave my racks in the oven when running a Self Clean cycle?

No. Although it will not damage the racks, it will discolor them and may make them hard to slide in and out during use. Remove all items from the oven before starting a Self Clean cycle.

### What should I do if my racks are sticky and have become hard to slide in and out?

Over time, the racks may become hard to slide in and out. Apply a small amount of olive oil to the ends of the racks. This will work as a lubricant for easier gliding.

### What should I do for hard to remove stains on my cooktop?

The cooktop should be cleaned after every use to prevent permanent staining. When cooking foods with high sugar content, such as tomato sauce, clean the stain off with a scraper while the cooktop is still warm. Use an oven mitt when scraping to prevent burns. Refer to the MAINTENANCE section of this owner's manual for further instruction.

### Why aren't the function buttons working?

Make sure that the range is not in Lock Out mode. The lock  will show in the display if Lock Out is activated. To deactivate Lock Out, press and hold **Lower CLEAR/OFF** for three seconds. The unlock melody sounds and **Loc** appears in the display until the controls are unlocked.

**My range is still dirty after running the EasyClean® cycle. What else should I do?**

The EasyClean® cycle only helps to loosen light soils in your oven range to assist in hand-cleaning of your oven. It does not automatically remove all soils after the cycle. Some scrubbing of your oven range is required after running the EasyClean® cycle.

**I tried scrubbing my oven after running EasyClean®, but some soils still remain. What can I do?**

The EasyClean® feature works best when the soils are fully soaked and submerged in water before running the cycle and during hand-cleaning. If soils are not sufficiently soaked in water, it can negatively affect the cleaning performance. Repeat the EasyClean® process using sufficient water.

Sugar-based and certain greasy soils are especially hard to clean. If some stubborn soils remain, use the Self Clean feature to thoroughly clean your oven.

**Soils on my oven walls are not coming off. How can I get my walls clean?**

Soils on the side and rear walls of your oven range may be more difficult to fully soak with water. Try repeating the EasyClean® process with more than the ¼ cup (2 oz or 60 ml) spray recommended.

**Will EasyClean® get all of the soils and stains out completely?**

It depends on the soil type. Sugar-based and certain grease stains are especially hard to clean. Also, if stains are not sufficiently soaked in water, this can negatively affect cleaning performance.

If stubborn or built-up stains remain, use the Self Clean feature. Refer to the Self Clean section of your owner's manual.

**Are there any tricks to getting some of the stubborn soils out?**

Scraping the soils with a plastic scraper before and during hand-cleaning is recommended. Fully saturating soils with water is also recommended.

However, certain types of soils are harder to clean than others. For these stubborn soils, the Self Clean cycle is recommended. Consult the Self Clean section of your owner's manual for details.

**Is it safe for my convection fan, broil burner or heater element to get wet during EasyClean®?**

Yes. The convection fan, broiler burner or heater element may get a little wet during cleaning. However, direct spray onto the broil burner and heater elements is not necessary because these are self-cleaning during regular use.

**Do I need to use all 1¼ cups (10 oz or 300 ml) of water for EasyClean®?**

Yes. It is highly recommended that 1 cup (8 oz or 250 ml) of water be sprayed or poured on the bottom and an additional ¼ cup (2 oz or 60 ml) of water be sprayed on walls and other soiled areas to fully saturate the soils for better cleaning performance.

**I see smoke coming out of my oven range's cooktop vents during EasyClean®. Is this normal?**

This is normal. This is not smoke. It is actually water vapor (steam) from the water in the oven cavity. As the oven heats briefly during EasyClean®, the water in the cavity evaporates and escapes through the oven vents.

**How often should I use EasyClean®?**

EasyClean® can be performed as often as you wish. EasyClean® works best when your oven is LIGHTLY soiled from such things as LIGHT grease splatter and small drops of cheese. Please refer to the EasyClean® section in your owner's manual for more information.

**What is required for EasyClean®?**

A spray bottle filled with 1¼ cups (10 oz or 300 ml) of water, a plastic scraper, a non-scratch scrubbing pad and a towel. You should not use abrasive scrubbers such as heavy-duty scouring pads or steel wool. Except for a towel, all of the materials you need are included in a special cleaning kit with your new range.

**Can I run the EasyClean® cycle on both of my ovens at once?**

Yes. You can run the EasyClean® cycle on both ovens at the same time. Some oven surfaces will be hot after the cycle completes running. Avoid leaning or resting on the oven door glass while cleaning the oven cavities.

You cannot run the Self Clean cycle on both ovens at the same time.



## Before Calling for Service

Before you call for service, review this list. It may save you time and expense. The list includes common occurrences that are not the result of defective workmanship or materials in this appliance.

Symptoms	Possible Causes / Solutions								
<b>Range is not level.</b>	<ul style="list-style-type: none"> <li>• Poor installation. Place oven rack in center of oven. Place a level on the oven rack. Adjust leveling legs at base of range until the oven rack is level.</li> <li>• Be sure floor is level and strong and stable enough to adequately support range.</li> <li>• If floor is sagging or sloping, contact a carpenter to correct the situation.</li> <li>• Kitchen cabinet alignment may make range appear unlevel. Be sure cabinets are square and have sufficient room for range clearance.</li> </ul>								
<b>Cannot move appliance easily. Appliance must be accessible for service.</b>	<ul style="list-style-type: none"> <li>• Cabinets not square or are built in too tightly. Contact builder or installer to make appliance accessible.</li> <li>• Carpet interferes with range. Provide sufficient space so range can be lifted over carpet.</li> <li>• Anti-tip device engaged.</li> </ul>								
<b>Oven control beeps and displays any F code error.</b>	<table border="1"> <thead> <tr> <th>CODE</th> <th>CAUSE</th> </tr> </thead> <tbody> <tr> <td>F-3</td> <td>Key short error</td> </tr> <tr> <td>F-9</td> <td>Oven not heating (Upper oven)</td> </tr> <tr> <td>F-19</td> <td>Oven not heating (Lower oven)</td> </tr> </tbody> </table> <ul style="list-style-type: none"> <li>• Electronic control has detected a fault condition. Press <b>Clear/Off</b> to clear the display and stop beeping. Reprogram oven. If fault recurs, record fault number. Press <b>Clear/Off</b> and contact a Service agent.</li> </ul>	CODE	CAUSE	F-3	Key short error	F-9	Oven not heating (Upper oven)	F-19	Oven not heating (Lower oven)
CODE	CAUSE								
F-3	Key short error								
F-9	Oven not heating (Upper oven)								
F-19	Oven not heating (Lower oven)								
<b>Top burners do not light or do not burn evenly.</b>	<ul style="list-style-type: none"> <li>• Make sure that the electrical plug is inserted into a live, properly grounded outlet.</li> <li>• Remove the burners and clean them. Check the electrode area for burnt on food or grease. See Cleaning Burner Heads/Caps in the MAINTENANCE section.</li> <li>• Make sure that the burner parts are installed correctly. See Removing and Replacing the Gas Surface Burners in the MAINTENANCE section.</li> </ul>								
<b>Burner flames are very large or yellow.</b>	If the range is connected to LP gas, contact the technician who installed your range or made the conversion.								
<b>Surface burners light but the oven does not.</b>	Make sure that the oven gas shut-off valve, located behind the range, is fully open.								
<b>Oven will not work</b>	<ul style="list-style-type: none"> <li>• Plug on range is not completely inserted in the electrical outlet. <ul style="list-style-type: none"> <li>- Make sure electrical plug is plugged into a live, properly grounded outlet.</li> </ul> </li> <li>• A fuse in your home may be blown or the circuit breaker tripped. <ul style="list-style-type: none"> <li>- Replace the fuse or reset the circuit breaker.</li> </ul> </li> <li>• Oven controls improperly set. <ul style="list-style-type: none"> <li>- See the Using the Oven section.</li> </ul> </li> <li>• Oven too hot. <ul style="list-style-type: none"> <li>- Allow the oven to cool to below locking temperature.</li> </ul> </li> </ul>								
<b>Steam is exhausted through the oven vent.</b>	<ul style="list-style-type: none"> <li>• Cooking foods with high moisture produces steam. This is normal.</li> </ul>								

Symptoms	Possible Causes / Solutions
<b>Appliance does not operate.</b>	<ul style="list-style-type: none"> <li>• Make sure cord is plugged correctly into outlet. Check circuit breakers.</li> <li>• Service wiring is not complete. Contact your electrician for assistance.</li> <li>• Power outage. Check house lights to be sure. Call your local electric company for service.</li> </ul>
<b>Oven light does not work.</b>	<ul style="list-style-type: none"> <li>• Replace or tighten bulb. See Changing the Oven Light section in this Owner's Manual.</li> </ul>
<b>Oven smokes excessively during broiling.</b>	<ul style="list-style-type: none"> <li>• Control not set properly. Follow instructions under Setting Oven Controls.</li> <li>• Meat too close to the element. Reposition the rack to provide proper clearance between the meat and the element. Preheat broil element for searing.</li> <li>• Meat not properly prepared. Remove excess fat from meat. Cut remaining fatty edges to prevent curling.</li> <li>• Insert on broiler pan wrong side up and grease not draining. Always place grid on the broiler pan with ribs up and slots down to allow grease to drip into pan.</li> <li>• Grease has built up on oven surfaces. Regular cleaning is necessary when broiling frequently. <ul style="list-style-type: none"> <li>- Old grease or food spatters cause excessive smoking.</li> </ul> </li> </ul>
<b>Food does not bake or roast properly</b>	<ul style="list-style-type: none"> <li>• Oven controls improperly set. <ul style="list-style-type: none"> <li>- See the Using the Oven section.</li> </ul> </li> <li>• Rack position is incorrect or the rack is not level. <ul style="list-style-type: none"> <li>- See the Using the Oven section.</li> </ul> </li> <li>• Incorrect cookware or cookware of improper size being used. <ul style="list-style-type: none"> <li>- See the Using the Oven section.</li> </ul> </li> <li>• Oven sensor needs to be adjusted. <ul style="list-style-type: none"> <li>- See Oven Temperature Adjustment in the Features section.</li> </ul> </li> </ul>
<b>Food does not broil properly</b>	<ul style="list-style-type: none"> <li>• Improper rack position being used. <ul style="list-style-type: none"> <li>- See the Broiling Guide.</li> </ul> </li> <li>• Cookware not suited for broiling. <ul style="list-style-type: none"> <li>- Use broiling pan and grid.</li> </ul> </li> </ul>
<b>Food does not broil properly</b>	<ul style="list-style-type: none"> <li>• Aluminum foil used on the broiling pan and grid has not been fitted properly and slit as recommended. <ul style="list-style-type: none"> <li>- See the Using the Oven section.</li> </ul> </li> <li>• In some areas the power voltage may be low. <ul style="list-style-type: none"> <li>- Preheat the broil element for 5-7 minutes.</li> <li>- See the Broiling Guide.</li> </ul> </li> </ul>
<b>Oven temperature too hot or too cold</b>	<ul style="list-style-type: none"> <li>• Oven sensor needs to be adjusted. <ul style="list-style-type: none"> <li>- See Oven Temperature Adjustment in the Features section.</li> </ul> </li> </ul>
<b>Oven will not Self Clean</b>	<ul style="list-style-type: none"> <li>• The oven temperature is too high to set a Self Clean operation. <ul style="list-style-type: none"> <li>- Allow the range to cool and reset the controls.</li> </ul> </li> <li>• Oven controls improperly set. <ul style="list-style-type: none"> <li>- See the Self Clean section.</li> </ul> </li> <li>• A Self Clean cycle cannot be started if the oven lockout feature is active.</li> </ul>
<b>“Crackling” or “popping” sound</b>	<ul style="list-style-type: none"> <li>• This is the sound of the metal heating and cooling during both the cooking and Self Clean functions. <ul style="list-style-type: none"> <li>- This is normal.</li> </ul> </li> </ul>

Symptoms	Possible Causes / Solutions
<b>Fan noise</b>	<ul style="list-style-type: none"> <li>• A convection fan may automatically turn on and off.</li> <li>- This is normal.</li> </ul>
<b>Convection Fan stops</b>	<ul style="list-style-type: none"> <li>• Convection fan stops during a convection bake cycle.</li> <li>- This is normal and is done to allow for more even heating during the cycle. This is not a failure of the range and should be considered normal operation.</li> </ul>
<b>Displayed colon in the clock is flashing</b>	<ul style="list-style-type: none"> <li>• This is normal. This means that the product has just been plugged in, or that it has experienced a power interruption. Press <b>Cook Time</b> for three seconds and reset the clock, or press any key to stop the flashing.</li> </ul>
<b>Excessive smoking during a Self Clean cycle</b>	<ul style="list-style-type: none"> <li>• Excessive soil.</li> <li>- Press the <b>Clear/Off</b> button. Open the windows to rid the room of smoke. Wait until the Self Clean mode is cancelled. Wipe up the excess soil and reset the clean.</li> </ul>
<b>Oven door does not open after a Self Clean cycle</b>	<ul style="list-style-type: none"> <li>• Oven is too hot.</li> <li>- Allow the oven to cool below locking temperature.</li> <li>• Allow about one hour for the oven to cool after the completion of a Self Clean cycle. The door can be opened when the lock  is no longer displayed.</li> <li>• The control and door may be locked.</li> </ul>
<b>The oven does not clean after a Self Clean cycle</b>	<ul style="list-style-type: none"> <li>• Oven controls not properly set.</li> <li>- See the Self Clean section.</li> <li>• Oven was heavily soiled.</li> <li>- Clean up heavy spillovers before starting the clean cycle. Heavily soiled ovens may need to Self Clean again or for a longer period of time.</li> </ul>
<b>CLEAN and door flash in the display</b>	<ul style="list-style-type: none"> <li>• The Self Clean cycle has been selected, but the door is not closed.</li> <li>- Close the oven door.</li> </ul>
<b>LOCKED is on in the display when you want to cook</b>	<ul style="list-style-type: none"> <li>• The oven door is locked because the temperature inside the oven has not dropped below the locking temperature.</li> <li>- Press the <b>Clear/Off</b> button. Allow the oven to cool.</li> </ul>
<b>Burning or oily odor emitting from the vent</b>	<ul style="list-style-type: none"> <li>• This is normal in a new oven and will disappear in time.</li> <li>- To speed the process, set a Self Clean cycle for a minimum of 3 hours. See the Self Clean section.</li> </ul>
<b>Oven racks are difficult to slide</b>	<ul style="list-style-type: none"> <li>• The shiny, silver-colored racks were cleaned in a Self Clean cycle.</li> <li>- Apply a small amount of vegetable oil to a paper towel and wipe the edges of the oven racks with the paper towel.</li> </ul>
<b>Moisture collects on oven window or steam comes from oven vent</b>	<ul style="list-style-type: none"> <li>• This is normal when cooking foods high in moisture.</li> <li>• Excessive moisture was used when cleaning the window.</li> </ul>

# SMART DIAGNOSIS™



Should you experience any problems with your range, it has the capability of transmitting data to your smart phone using the Smart ThinQ application or via your telephone to the LG call center.

Smart Diagnosis™ cannot be activated unless your range is turned on by pressing the **Start** button. If your range is unable to turn on, then troubleshooting must be done without using Smart Diagnosis™.

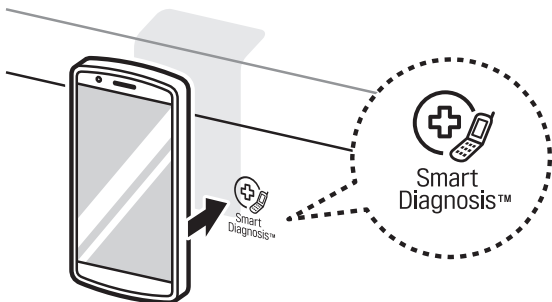

## Using Smart Diagnosis™

### Smart Diagnosis™ Using Your Smart Phone

- 1 Download the Smart ThinQ application on your smart phone.
- 2 Open the Smart ThinQ application on your smart phone. Touch Smart Diagnosis™ button to advance to the next screen.
- 3 Follow directions of the application. Using 'Tag On' is recommended but, if it does not work well, the application will show how to use Audible Diagnosis.
- 4 Touch [ ? ] in the Smart ThinQ application for a more detailed guide on how to use the Tag On function.

#### NOTE

- Call quality differences by region may affect the function.
- Use the home telephone for better communication performance, resulting in better service.
- Bad call quality may result in poor data transmission from your phone to the machine, which could cause Smart Diagnosis™ to malfunction.

## Smart Diagnosis™ Through the Call Center

- 1 Call the LG SIGNATURE Customer Information Center at 1-800-984-6306.
- 2 When instructed to do so by the call center agent, hold the mouthpiece of your phone over the Smart Diagnosis™ logo on the machine. Hold the phone no more than one inch from (but not touching) the machine.

#### NOTE

Do not touch any other buttons or icons on the display screen.

- 3 Press and hold the **Start** button for three seconds.
- 4 Keep the phone in place until the tone transmission has finished. This takes about 6 seconds and the display will count down the time.
- 5 Once the countdown is over and the tones have stopped, resume your conversation with the call center agent, who will then be able to assist you in using the information transmitted for analysis.

#### NOTE

- For best results, do not move the phone while the tones are being transmitted.
- If the call center agent is not able to get an accurate recording of the data, you may be asked to try again.

# WARRANTY (USA)

Should your LG Dual Fuel Range fail due to a defect in materials or workmanship under normal home use, during the warranty period set forth below, LG will at its option repair or replace the product. This limited warranty is valid only to the original retail purchaser of the product and applies only when purchased and used within the United States including U.S. Territories. Proof of original retail purchase is required to obtain warranty service under this limited warranty.

Warranty Period	Scope of Warranty	HOW SERVICE IS HANDLED
One (1) year from date of original retail purchase	Parts and Labor	LG will provide parts and labor to repair or replace defective parts.

- Replacement products and parts are warranted for the remaining portion of the original warranty period or ninety (90) days, whichever is greater.
- Replacement products and parts may be new or remanufactured.

**THIS WARRANTY IS IN LIEU OF ANY OTHER WARRANTY, EXPRESS OR IMPLIED, INCLUDING WITHOUT LIMITATION, ANY WARRANTY OF MERCHANTABILITY OR FITNESS FOR A PARTICULAR PURPOSE. TO THE EXTENT ANY IMPLIED WARRANTY IS REQUIRED BY LAW, IT IS LIMITED IN DURATION TO THE EXPRESS WARRANTY PERIOD ABOVE. NEITHER THE MANUFACTURER NOR ITS U.S. DISTRIBUTOR SHALL BE LIABLE FOR ANY INCIDENTAL, CONSEQUENTIAL, INDIRECT, SPECIAL, OR PUNITIVE DAMAGES OF ANY NATURE, INCLUDING WITHOUT LIMITATION, LOST REVENUES OR PROFITS, OR ANY OTHER DAMAGE WHETHER BASED IN CONTRACT, TORT, OR OTHERWISE.**

Some states do not allow the exclusion or limitation of incidental or consequential damages or limitations on how long an implied warranty lasts, so the above exclusion or limitation may not apply to you. This warranty gives you specific legal rights and you may also have other rights that vary from state to state.



## **THIS LIMITED WARRANTY DOES NOT COVER:**



- Service trips to deliver, pick up, or install or repair the product; instruction to the customer on operation of the product; repair or replacement of fuses or correction of wiring or plumbing, or correction of unauthorized repairs/installation.
- Failure of the product to perform during power failures and interruptions or inadequate electrical service.
- Damage caused by leaky or broken water pipes, frozen water pipes, restricted drain lines, inadequate or interrupted water supply or inadequate supply of air.
- Damage resulting from operating the Product in a corrosive atmosphere or contrary to the instructions outlined in the Product's owner's manual.
- Damage to the Product caused by accidents, pests and vermin, lightning, wind, fire, floods, or acts of God.
- Damage or failure caused by unauthorized modification or alteration, or if it is used for other than the intended purpose, or any water leakage where the unit was not properly installed.
- Damage or failure caused by incorrect electrical current, voltage, or plumbing codes, commercial or industrial use, or use of accessories, components, or consumable cleaning products that are not approved by LG.
- Damage caused by transportation and handling, including scratches, dents, chips, and/or other damage to the finish of your product, unless such damage results from defects in materials or workmanship and is reported within one (1) week of delivery.
- Damage or missing items to any display, open box, discounted, or refurbished Product.
- Products with original serial numbers that have been removed, altered, or cannot be readily determined. Model and Serial numbers, along with original retail sales receipt, are required for warranty validation.
- Increases in utility costs and additional utility expenses.
- Repairs when your Product is used in other than normal and usual household use (e.g. commercial use, in offices and recreational facilities) or contrary to the instructions outlined in the Product's owner's manual.
- Costs associated with removal of your Product from your home for repairs.

## 62 WARRANTY

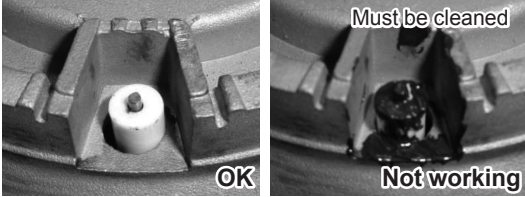
- The removal and reinstallation of the Product if it is installed in an inaccessible location or is not installed in accordance with published installation instructions, including LG's owner's and installation manuals.
- Damage resulting from misuse, abuse, improper installation, repair, or maintenance. Improper repair includes use of parts not approved or specified by LG.

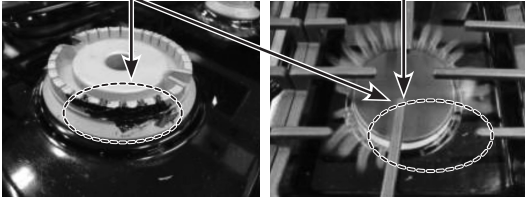
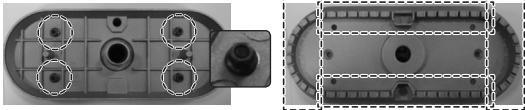
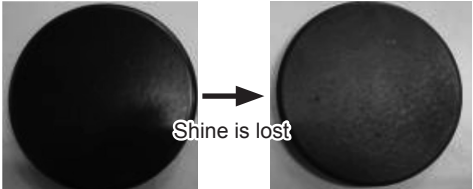
The following circumstances are not covered under the warranty:

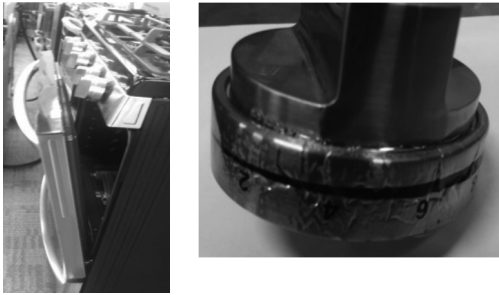
Problem	Cause	Prevention
<ul style="list-style-type: none"> <li>• Burners do not light</li> </ul>	<p>Clogged or dirty burner ports or electrodes will not allow the burner to operate properly</p> 	<ul style="list-style-type: none"> <li>• Check and clean the gas electrode.</li> </ul>
<ul style="list-style-type: none"> <li>• Uneven flame</li> </ul>	<ol style="list-style-type: none"> <li>1. Improper burner cap installation           <p>Burner cap is properly seated.      Burner cap is NOT properly seated.</p>  </li> <li>2. Burner ports clogged by food residue           <p>Ports blocked by dirt      Flames uneven</p>  </li> </ol> <p>* Oval burner</p> <p>To clean: Release 4 nuts      Clean ports with toothbrush</p> 	<ul style="list-style-type: none"> <li>• Check installation of burner head and cap</li> <li>• Hardened residue should be removed using a toothbrush.</li> <li>• Oval burner           <ol style="list-style-type: none"> <li>1) Release 4 nuts</li> <li>2) Clean residue using toothbrush</li> </ol> </li> </ul>
<ul style="list-style-type: none"> <li>• Burner cap color change and lost shine</li> </ul>	<ol style="list-style-type: none"> <li>1. Scratching</li> <li>2. Use of detergent or abrasive cleansers</li> </ol> 	<ul style="list-style-type: none"> <li>• Do not use steel wool or abrasive cleansers to clean.</li> <li>• To remove burnt-on food, soak the burner heads in hot water for 20–30 minutes. (Do not use detergent)</li> </ul>

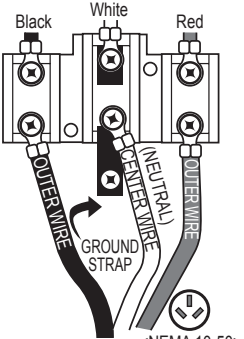
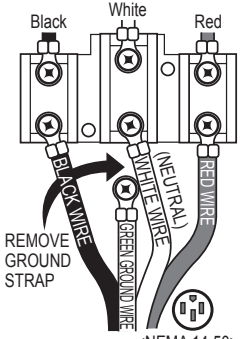
Problem	Cause	Prevention
<ul style="list-style-type: none"> <li>Knobs melt</li> </ul>	<p>Improper usage</p> 	<ul style="list-style-type: none"> <li>Do not leave door at stop position during Broil/Bake mode or right after cooking.</li> </ul>
<ul style="list-style-type: none"> <li>Oven or racks are stained after using aluminum foil</li> </ul>	<p>Aluminum foil has melted in the oven</p> 	<ul style="list-style-type: none"> <li>Never cover the oven bottom or cover an entire rack with materials such as aluminum foil.</li> <li>If the foil has already melted onto the oven, it will not affect the performance of the oven.</li> </ul>
<ul style="list-style-type: none"> <li>Unit has no power</li> </ul>	<ol style="list-style-type: none"> <li>House power turned off (power supply)</li> <li>Tripped breaker</li> <li>The power cord is not installed properly.</li> </ol> <div style="display: flex; justify-content: space-around;"> <div data-bbox="410 952 655 1338"> <p><b>3-WIRE HOOK UP</b></p>  <p>&lt;NEMA 10-50&gt;</p> </div> <div data-bbox="673 952 918 1338"> <p><b>4-WIRE HOOK UP</b></p>  <p>REMOVE GROUND STRAP</p> <p>&lt;NEMA 14-50&gt;</p> </div> </div>	<ul style="list-style-type: none"> <li>Check power at main board before calling for service.</li> <li>Match power cord type and outlet type</li> <li>Properly install the power cord</li> </ul>

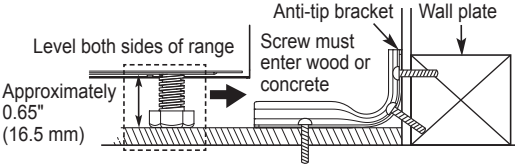
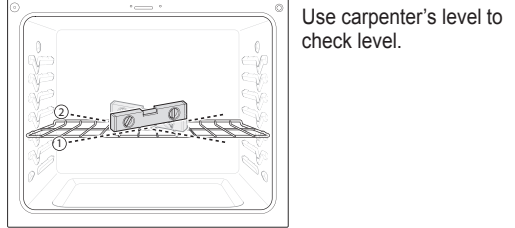
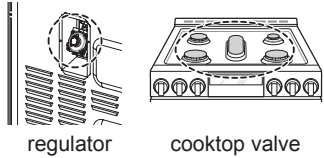
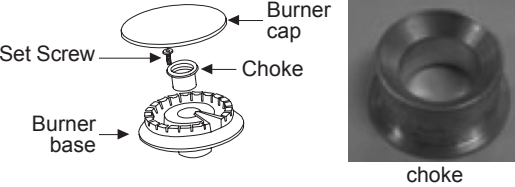
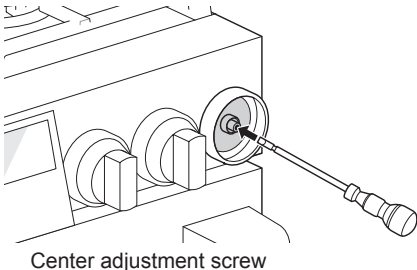
Problem	Cause	Prevention
<ul style="list-style-type: none"> <li>• Surface is not level</li> <li>• Oven is tipping</li> </ul>	<ol style="list-style-type: none"> <li>1. Range not leveled</li> <li>2. Anti-tip device not installed correctly</li> </ol>  	<ul style="list-style-type: none"> <li>• Check with installer first</li> </ul>
<ul style="list-style-type: none"> <li>• Flames too big on converted cooktop (NP → LP)</li> </ul>	<p>The installer missed part of the conversion. (Check 2 parts: regulator, cooktop valve).</p>  <p style="text-align: center;">regulator                  cooktop valve</p>	<ul style="list-style-type: none"> <li>• Check with installer first</li> <li>• Refer to installation manual</li> </ul>
	<p>18.5 K burner needs choke.</p>  <p style="text-align: center;">choke</p>	<ul style="list-style-type: none"> <li>• Check with installer first</li> <li>• Refer to installation manual</li> </ul>
<ul style="list-style-type: none"> <li>• Flame is too small or too large</li> </ul>	<ol style="list-style-type: none"> <li>1. Variable gas pressure</li> <li>2. Installer did not check</li> </ol>  <p style="text-align: center;">Center adjustment screw</p>	<ul style="list-style-type: none"> <li>• Check with installer first</li> </ul>

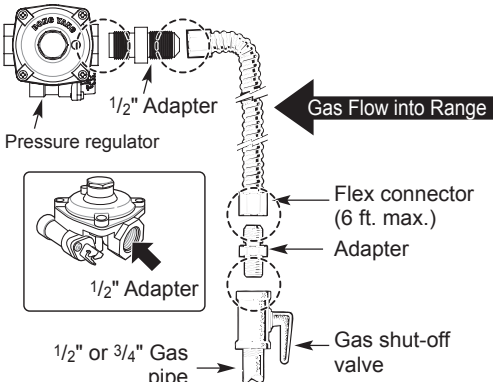

Problem	Cause	Prevention
<ul style="list-style-type: none"> <li>Gas smell</li> </ul>	<p>Improper connection</p> <p><b>Flexible Connector Hookup</b></p>  <p>Pressure regulator</p> <p>1/2" Adapter</p> <p>Gas Flow into Range</p> <p>Flex connector (6 ft. max.)</p> <p>Adapter</p> <p>Gas shut-off valve</p> <p>1/2" or 3/4" Gas pipe</p> <p>1/2" Adapter</p>	<ul style="list-style-type: none"> <li>Check with installer first</li> </ul>

**The cost of repair or replacement under these excluded circumstances shall be borne by the consumer.**

#### OBTAIN WARRANTY SERVICE AND ADDITIONAL INFORMATION

If you do not have access to the internet and you need assistance using your product or you would like to schedule service, you may contact LG Electronics at the number below.

For assistance or service, call 1-800-984-6306.

If you need further assistance, you can write to LG with any questions or concerns at the address below:

LG Electronics, 201 James Record Road, Huntsville, Alabama 35813

For additional product information, visit our website at <http://www.LGSIGNATURE.com>

# MEMO

# LG SIGNATURE

Customer Information Center

For inquires or comments, call:

**1-800-984-6306** USA

Printed in Korea