

Use & Care Guide
Manual de Uso y Cuidado
English / Español

Model/Modelo: 790.3263*, 790.3264*

Kenmore Elite®

Slide-in Gas Range

Estufa a Gas

* = color number, número de color

P/N A00539101 Rev. A

Sears Brands Management Corporation

Hoffman Estates, IL 60179 U.S.A.

www.kenmore.com

www.sears.com

Sears Canada Inc.

Toronto, Ontario, Canada M5B 2C3

www.sears.ca



Table of Contents

Before Setting Surface Controls.....	9	Replacing the Oven Light	37
Setting Surface Burners.....	13	Removing and Replacing the Oven Door	38
Before Setting Oven Controls	14	Before You Call.....	40
Setting Oven Controls	16	Oven Baking	40
Care and Cleaning	35	Solutions to Common Problems	41
Cleaning Various Parts of Your Oven	35		

KENMORE ELITE LIMITED WARRANTY

FOR ONE YEAR from the date of sale this appliance is warranted against defects in material or workmanship when it is correctly installed, operated and maintained according to all supplied instructions.

WITH PROOF OF SALE, a defective appliance will receive free repair or replacement at option of seller.

For warranty coverage details to obtain free repair or replacement, visit the web page: www.kenmore.com/warranty

This warranty applies for only 90 DAYS from the sale date in the United States, and is void in Canada, if this appliance is ever used for other than private household purposes.

This warranty covers ONLY defects in material and workmanship, and will NOT pay for:

1. Cracks in a ceramic glass cooktop that are not a result of thermal shock.
2. Stains and scratches on a ceramic glass cooktop resulting from accident or improper operation or maintenance.
3. Discoloration of cooktop surfaces resulting from normal use.
4. Expendable items that can wear out from normal use, including but not limited to filters, belts, bags or screw-in base light bulbs.
5. A service technician to clean or maintain this appliance, or to instruct the user in correct appliance installation, operation and maintenance.
6. Service calls to correct appliance installation not performed by Sears authorized service agents, or to repair problems with house fuses, circuit breakers, house wiring, and plumbing or gas supply systems resulting from such installation.
7. Damage to or failure of this appliance resulting from installation not performed by Sears authorized service agents, including installation that was not in accord with electrical, gas or plumbing codes.
8. Damage to or failure of this appliance, including discoloration or surface rust, if it is not correctly operated and maintained according to all supplied instructions.
9. Damage to or failure of this appliance, including discoloration or surface rust, resulting from accident, alteration, abuse, misuse or use for other than its intended purpose.
10. Damage to or failure of this appliance, including discoloration or surface rust, caused by the use of detergents, cleaners, chemicals or utensils other than those recommended in all instructions supplied with the product.
11. Damage to or failure of parts or systems resulting from unauthorized modifications made to this appliance.
12. Service to an appliance if the model and serial plate is missing, altered, or cannot easily be determined to have the appropriate certification logo.

Disclaimer of implied warranties; limitation of remedies

Customer's sole and exclusive remedy under this limited warranty shall be product repair or replacement as provided herein. Implied warranties, including warranties of merchantability or fitness for a particular purpose, are limited to one year or the shortest period allowed by law. Seller shall not be liable for incidental or consequential damages. Some states and provinces do not allow the exclusion or limitation of incidental or consequential damages, or limitation on the duration of implied warranties of merchantability or fitness, so these exclusions or limitations may not apply to you.

This warranty applies only while this appliance is used in the United States or Canada*.

This warranty gives you specific legal rights, and you may also have other rights which vary from state to state.

* In-home repair service is not available in all Canadian geographical areas, nor will this warranty cover user or servicer travel and transportation expenses if this product is located in a remote area (as defined by Sears Canada Inc.) where an authorized servicer is not available.

Sears Brands Management Corporation, Hoffman Estates, IL 60179
Sears Canada Inc., Toronto, Ontario, Canada M5B 2C3

IMPORTANT SAFETY INSTRUCTIONS

Read all instructions before using this appliance.

This manual contains important safety symbols and instructions. Pay attention to these symbols and follow all instructions given.

Do not attempt to install or operate your appliance until you have read the safety precautions in this manual. Safety items throughout this manual are labeled with a WARNING or CAUTION statement based on the hazard type.

DEFINITIONS

⚠ This is the safety alert symbol. It is used to alert you to potential personal injury hazards. Obey all safety messages that follow this symbol to avoid possible injury or death.

⚠ WARNING - Indicates a potentially hazardous situation which, if not avoided, may result in death or serious injury.

⚠ CAUTION - Indicates a potentially hazardous situation which, if not avoided, may result in minor or moderate injury.

Important: Indicates installation, operation, maintenance, or valuable information that is not hazard related.

Important Safety Notice - The California Safe Drinking Water and Toxic Enforcement Act requires the governor of California to publish a list of substances known to cause cancer, birth defects, or other reproductive harms, and it requires businesses to warn customers of potential exposures to such substances.

⚠ WARNING Never cover any slots, holes, or passages in the oven bottom or cover an entire oven rack with materials, such as aluminum foil. Aluminum foil linings may trap heat, causing a fire hazard.

⚠ WARNING If the information in this manual is not followed exactly, a fire or explosion may result causing property damage, personal injury or death.

FOR YOUR SAFETY: Do not store or use gasoline or other flammable vapors and liquids in the vicinity of this or any other appliance.

WHAT TO DO IF YOU SMELL GAS:

- Do not try to light any appliance.
- Do not touch any electrical switch; do not use any phone in your building.
- Immediately call your gas supplier from a neighbor's phone. Follow the gas supplier's instructions.
- If you cannot reach your gas supplier, call the fire department.
- Installation and service must be performed by a qualified installer, servicer or the gas supplier.

⚠ WARNING Do not leave children alone. Children should not be left alone or unattended in the area where appliance is in use. They should never be allowed to sit or stand on any part of the appliance, including the storage drawer, lower broiler drawer, warmer drawer, or lower double oven.

⚠ WARNING Do not store items of interest to children in the cabinets above a range or on the backguard of the range. Children climbing on the range to reach items could be seriously injured.

⚠ CAUTION Do not use water or flour on grease fires. Smother fire or flame or use dry chemical or foam-type extinguisher. Cover the fire with a pan lid or use baking soda.

IMPORTANT SAFETY INSTRUCTIONS

Read all instructions before using this appliance.

⚠ WARNING

Tip Over Hazard



- A child or adult can tip the appliance and be killed.
- Verify the device is engaged with the

countertops or that the device has been installed to the walls of the cabinet, the wall, or the floor as per the installation instructions

- Ensure the anti-tip device is re-engaged with the countertop, the walls of the cabinet, the wall, or the floor as per the installation instructions when the appliance is moved.
- Do not operate the appliance without the anti-tip device in place and engaged.
- Failure to follow these instructions can result in death or serious burns to children and adults.



To check if the anti-tip bracket is installed properly, use both arms to grasp the rear edge of the

appliance back. Carefully attempt to tilt appliance forward. When properly installed, the appliance should not tilt forward.

Refer to the anti-tip bracket installation instructions supplied with your range for proper installation.

⚠ WARNING Storage in or on appliance—Flammable materials should not be stored in an oven or near surface units. This includes paper, plastic, and cloth items, such as cookbooks, plastic ware, and towels, as well as flammable liquids. Do not store explosives, such as aerosol cans, on or near the oven.

⚠ WARNING Stepping, leaning, or sitting on the door or drawers of an oven can result in serious injuries and also cause damage to the appliance. Do not allow children to climb or play around the oven. The weight of a child on an open over door may cause the oven to tip, resulting in serious burns or other injury.

⚠ CAUTION Wear proper apparel. Loose-fitting or hanging garments should never be worn while using this appliance. Do not let clothing or other flammable materials come into contact with hot surfaces.

⚠ CAUTION Do not heat unopened food containers. Build-up of pressure may cause container to burst and result in injury.

⚠ CAUTION When heating fat or grease, watch it closely. Grease may catch fire if it becomes too hot.

⚠ CAUTION Use dry potholders. Moist or damp potholders on hot surfaces may result in burns from steam. Do not let potholders touch hot cooking areas. Do not use towels or other bulky cloths.

⚠ WARNING Stepping, leaning, or sitting on the door or drawers of an oven can result in serious injuries and also cause damage to the appliance. Do not allow children to climb or play around the oven. The weight of a child on an open over door may cause the oven to tip, resulting in serious burns or other injury.

IMPORTANT SAFETY INSTRUCTIONS

Read all instructions before using this appliance.

⚠ CAUTION Read and follow the below instructions and precautions for unpacking, installing, and servicing your appliance:

- Remove all tape and packaging before using the oven. Destroy the carton and plastic bags after unpacking the oven. Never allow children to play with packaging material.
 - Proper Installation—Be sure your appliance is properly installed and grounded by a qualified technician in accordance with the National Electrical Code ANSI/NFPA No. 70 latest edition and local electrical code requirements. In Canada, install in accordance with CSA Standard C22.1, Canadian Electrical code, Part 1, and local electrical code requirements. Install only per installation instructions provided in the literature package for this oven.
 - User Servicing—Do not repair or replace any part of the appliance unless specifically recommended in the manuals. All other servicing should be done only by a qualified technician. This reduces the risk of personal injury and damage to the oven.
 - Ask your dealer to recommend a qualified technician and an authorized repair service. Know how to disconnect the power to the oven at the circuit breaker or fuse box in case of an emergency.
 - Never modify or alter the construction of an oven by removing the leveling legs, panels, wire covers, anti-tip brackets/screws, or any other part of the oven.
 - Remove the oven door from any unused oven if it is to be stored or discarded.
- Do not attempt to operate the oven during a power failure. If the power fails, always turn off the oven. If the oven is not turned off and the power resumes, the oven will begin to operate again. Once the power resumes, reset the clock and oven function.
 - Be sure to have an appropriate foam-type fire extinguisher available, visible, and easily located near the appliance.
 - Cold temperatures can damage the electronic control. When using this appliance for the first time, or when the appliance has not been used for an extended period of time, be sure the appliance has been in temperatures above 32 °F (0 °C) for at least 3 hours before turning on the power to the appliance.
 - Air curtain or other overhead range hoods, which operate by blowing a downward air flow on to a range, shall not be used in conjunction with gas ranges other than when the hood and range have been designed, tested and listed by an independent test laboratory for use in combination with each other.

⚠ CAUTION Do not heat unopened food containers. Build-up of pressure may cause container to burst and result in injury.

⚠ CAUTION When heating fat or grease, watch it closely. Grease may catch fire if it becomes too hot.

⚠ CAUTION Use dry potholders. Moist or damp potholders on hot surfaces may result in burns from steam. Do not let potholders touch hot cooking areas. Do not use towels or other bulky cloths.

Save these instructions for future reference.

IMPORTANT SAFETY INSTRUCTIONS

Read all instructions before using this appliance.

IMPORTANT INSTRUCTIONS FOR USING YOUR OVEN

- Never use your appliance for warming or heating the room.
- Use care when opening oven door, lower oven door, or warmer drawer (some models). Stand to the side of the oven when opening the door of a hot oven. Let hot air or steam escape before you remove or replace food in the oven.
- Keep oven vent ducts unobstructed. Touching surfaces in this area when the oven is on may cause severe burns. Do not place plastic or heat-sensitive items on or near the oven vent. These items can melt or ignite.
- Placement of oven racks - Always place oven racks in desired location while oven is cool. If rack must be moved while oven is hot, do not let potholder contact hot heating element in oven. Use potholders and grasp the rack with both hands to reposition. Remove all bakeware and utensils before moving the rack.
- Do not use a broiler pan without its insert. Broiler pans and inserts allow dripping fat to drain away from the high heat of the broiler. Do not cover the broiler insert with aluminum foil; exposed fat and grease could ignite.
- Protective liners - Do not use aluminum foil to line surface unit drip bowls or oven bottoms, except as suggested in the manual. Improper installation of these liners may result in a risk of electric shock, or fire.
- Do not cook food on the oven bottom. Always cook in proper bakeware and always use the oven racks.
- Do not cover the broiler insert with aluminum foil. Exposed fat and grease could ignite.

IMPORTANT INSTRUCTIONS FOR USING YOUR COOKTOP

⚠ WARNING Use proper flame size — Adjust flame size so it does not extend beyond the edge of the utensil. The use of undersized utensils will expose a portion of the burner flame to direct contact and may result in ignition of clothing. Proper relationship of utensil to flame will also improve efficiency.

- Know which knob controls each surface burner. Place a pan of food on the burner before turning it on, and turn the burner off before removing the pan.
- Always turn knob to the full LITE position when igniting top burners. Visually check that burner has lit. Then adjust the flame so it does not extend beyond the edge of the utensil.
- Utensil handles should be turned inward and not extend over adjacent surface burners — To reduce the risk of burns, ignition of flammable materials, and spillage due to unintentional contact with the utensil, the handle of the utensil should be positioned so that it is turned inward, and does not extend over adjacent surface burners.
- Never leave surface burners unattended at high heat settings — Boilovers cause smoking and greasy spillovers that may ignite, or a pan that has boiled dry may melt.
- Glazed cooking utensils — Only certain types of glass, glass/ceramic, ceramic, earthenware, or other glazed utensils are suitable for cook top service without breaking due to the sudden change in temperature. Check the manufacturer's recommendations for cook top use.
- When you are flaming foods under a ventilating hood, turn the fan on.

Save these instructions for future reference.

IMPORTANT SAFETY INSTRUCTIONS

Read all instructions before using this appliance.

IMPORTANT INSTRUCTIONS FOR CLEANING YOUR OVEN

⚠ CAUTION Before manually cleaning any part of the oven, be sure all controls are turned off and the oven is cool. Cleaning a hot oven can cause burns.

- Clean the oven regularly to keep all parts free of grease that could catch fire. Do not allow grease to accumulate.
- Always follow the manufacturer's recommended directions for use of kitchen cleaners and aerosols. Be aware that excess residue from cleaners and aerosols may ignite causing damage and injury.
- Clean ventilating hoods frequently. Grease should not be allowed to accumulate on the hood or filter. Follow the manufacturer's instructions for cleaning hoods.

SELF-CLEANING OVENS

- Clean only the parts listed in this manual. Before using self-clean, remove the broiler pan, any food, utensils, and bakeware from the oven. Remove oven racks unless otherwise instructed.
- Do not use oven cleaners. No commercial oven cleaner or oven liner protective coating of any kind should be used in or around any part of the oven.
- Do not clean the door gasket. The door gasket is essential for a good seal. Care should be taken not to rub, damage, or move the gasket.
- Some birds are extremely sensitive to the fumes given off during the self-clean cycle of any oven. Move birds to another well-ventilated room.

⚠ CAUTION Do not touch heating elements or interior surfaces of oven. Heating elements may be hot even though they are dark in color. Interior surfaces of an oven become hot enough to cause burns.

⚠ CAUTION During and after use, do not touch, or let clothing or other flammable materials contact heating elements or interior surfaces of oven until they have sufficient time to cool.

⚠ CAUTION Other surfaces of the appliance may become hot enough to cause burns including oven vent openings and surfaces near these openings, oven doors, and windows of oven doors.

IMPORTANT SAFETY INSTRUCTIONS

Read all instructions before using this appliance.

Grounding Instructions

⚠ WARNING Avoid fire hazard or electrical shock. Do not use an adapter plug, and extension cord, or remove grounding prong from the power cord. Failure to follow this warning may cause serious injury, fire, or death.

This appliance is equipped with a three-prong grounding plug. For your protection against shock hazard, it should be plugged directly into a properly grounded receptacle. Do not cut or remove the grounding prong from this plug.

For personal safety, this appliance must be properly grounded. For maximum safety, the power cord must be plugged into an electrical outlet that is correctly polarized and properly grounded.

If a two-prong wall receptacle is the only available outlet, it is the personal responsibility of the consumer to have it replaced with a properly grounded three-prong wall receptacle installed by a qualified electrician.

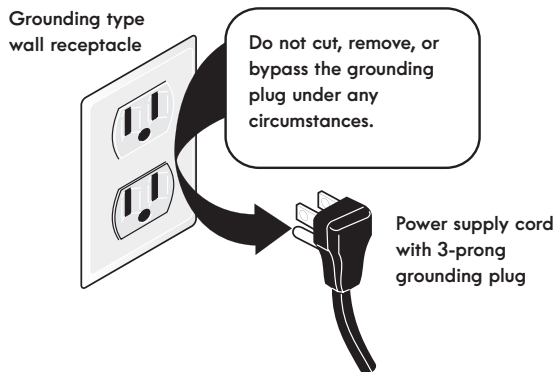

See the installation instructions packaged with this appliance for complete installation and grounding instructions.

Conversion to L.P. Gas

⚠ WARNING Personal injury or death from electrical shock may occur if the conversion to L.P. gas is not made by a qualified installer or electrician.

⚠ WARNING Any additions, changes or conversions required in order for this appliance to satisfactorily meet the application needs must be made by a qualified technician.

This appliance allows for conversion to **Liquefied Petroleum (L.P.) Gas**.

If an L.P. conversion is needed, contact your local L.P. Gas provider for assistance. The L.P. conversion kit is provided with this appliance and is located on the lower REAR (back side) panel of the range. Before installing the kit be sure to read the L.P. Installation Instructions and follow them carefully when making the installation.

Product Registration and Customer Information

Serial Plate Location

The serial plate is on the left side of the oven frame.

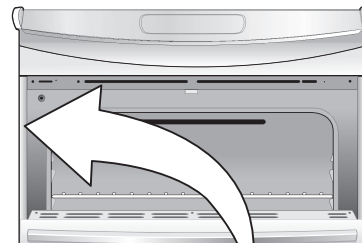

Record the date of purchase, model and serial number of your product in the corresponding space below.

Model Number: _____

Serial Number: _____

Date of Purchase: _____

Save your sales receipt for future reference.

Save these instructions for future reference.

Before Setting Surface Controls

Check burner cap placement before operating the surface burners

⚠ CAUTION To prevent flare-ups and avoid creation of harmful by-products, do not use the cooktop without all burner caps properly installed to insure proper ignition and gas flame size.

On round style burners, the burner cap lip (Figure 1) should fit snug into the center of burner head and rest level. Refer to Figure 2 for correct and incorrect burner cap placement. Once in place, you may check the fit by gently sliding the burner cap from side to side (Figure 3) to be sure it is centered and firmly seated. When the burner cap lip makes contact inside the center of the burner head you will be able to hear the burner cap click. Please note that the burner cap should not move off the center of the burner head when sliding from side to side. Check and be sure that all oval style (some models) burner caps are correctly in place on oval burner heads.

It is very important to be sure that all surface burner caps and burner grates are properly installed and in the correct locations before operating the cooktop burners.

Remember:

- Always keep surface burner caps in place whenever using a surface burner.
- When placing the burner caps, be sure that all burner caps are seated firmly and rest level on top of burner heads.
- For proper flow of gas and ignition of burners do not allow spills, food, cleaning agents or any other material to enter the gas orifice port opening.

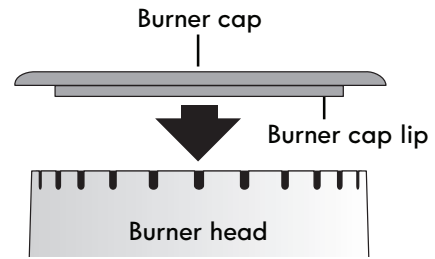

Figure 1: Burner cap on burner head

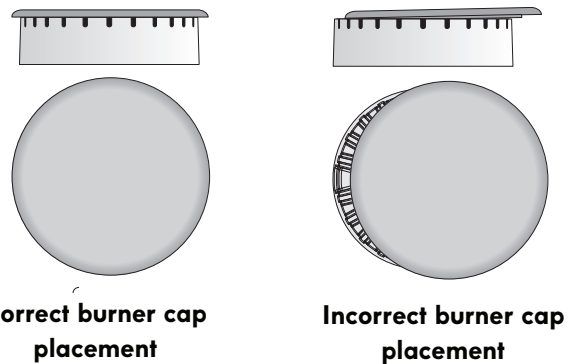

Figure 2: Correct placement (L) Incorrect placement (R)

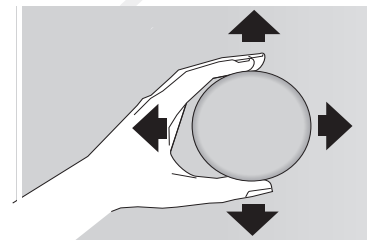

Figure 3: Moving cap gently until seated properly

Before Setting Surface Controls

Double Ring style burners (some models)

The Double Ring burner only operates properly with two burner caps in place. Be sure the burner cap lips are positioned facing down towards the burner head and into the recessed areas (Figure 4) on each side of the burner head. Be sure both burner caps are seated firmly and rest level on the burner head before operating.

Check the fit for each cap using the same method for the round burner caps by gently sliding each cap from side to side. Please note that the burner cap lips should not move out of recessed areas of the burner head.

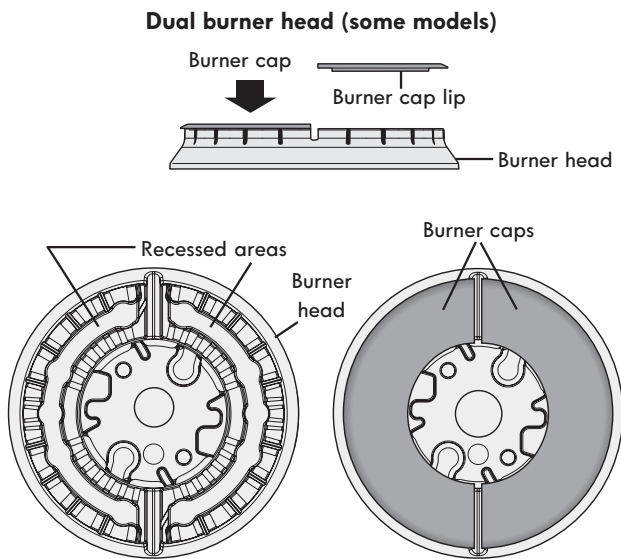

Figure 4: Dual burner head using two burner caps

Installing burner grates:

CAUTION Do not use the surface burners without the burner caps and burner grates properly installed. Missing pieces or improper installation may lead to spills, burns, or damage to your range and cookware.

Make sure the burner grates are properly placed on the cooktop before using the surface burners. The grates are designed to rest inside the recess on the cooktop.

To install burner grates, place grates flat-side down and align into the cooktop recess. Grates should rest flush against each other and against the sides of the recess.

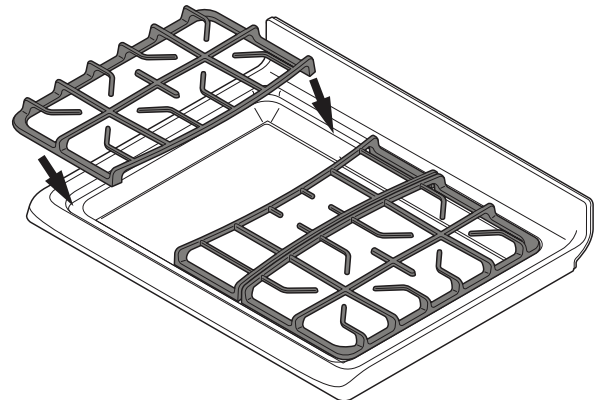

Figure 5: How to place burner grates properly

Using Proper Cookware

⚠ CAUTION Do not place flammable items such as plastic salt and pepper shakers, spoon holders or plastic wrappings on the cooktop when it is in use. These items could melt or ignite. Potholders, towels or wooden spoons could catch fire if placed too close to the range cooktop.

⚠ CAUTION Do not place aluminum foil, or any material that can melt on the range cooktop. If these items melt they may damage the cooktop.

⚠ CAUTION Do not straddle cookware between two cooking surfaces unless the cookware is designed for that purpose, as with a griddle.

For best cooking results, cookware should have flat bottoms that rest level on the burner grate. Before using cookware, check for flatness by rotating a ruler across the bottom of the cookware (See Figure 6).



Figure 6: Check for flat bottom cookware

Please note: The size and type of utensil used, and the amount and type of food being cooked will influence the burner flame setting needed for best cooking results.

Cookware material types

The most popular materials available are:

- **Aluminum** - Excellent heat conductor. Some types of food will cause it to darken (Anodized aluminum cookware resists staining & pitting).
- **Copper** - Excellent heat conductor but discolors easily.
- **Stainless** - Slow heat conductor with uneven cooking results. Is durable, easy to clean and resists staining.
- **Cast Iron** - A slow heat conductor however will retain heat very well. Cooks evenly once cooking temperature is reached.
- **Porcelain -enamel on metal** - Heating characteristics will vary depending on base material.
- **Glass** - Slow heat conductor.

Before Setting Surface Controls

Setting Proper Burner Flame Size¹

⚠ CAUTION Never extend the flame beyond the outer edge of the cooking utensil. A higher flame wastes energy, and increases your risk of being burned by the flame.

The color of the flame is the key to proper burner adjustment. A good flame is clear, blue and hardly visible in a well-lighted room. Each cone of flame should be steady and sharp. Adjust or clean burner if flame is yellow-orange.

For most cooking

Start on the highest setting and then turn to a lower setting to complete the process. Use the recommendations below as a guide for determining proper flame size for various types of cooking (See [Table 1](#))

For deep fat frying

Use a thermometer and adjust the surface knob accordingly. If the fat is too cool, the food will absorb the fat and be greasy. If the fat is too hot, the food will brown so quickly that the center will be under cooked. Do not attempt to deep fat fry too much food at once as the food will neither brown or cook properly.

Table 1: Suggested flame settings

Flame size	Type of cooking
High flame	Start most foods, bring water to a boil, pan broiling.
Medium flame	Maintain a slow boil, thicken sauces, gravies, steaming.
Low flame	Keep foods cooking, poaching and stewing.

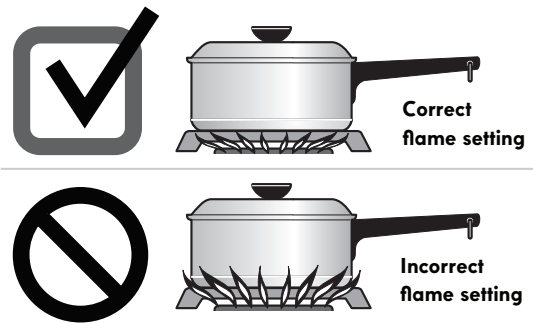

Figure 7: How to set flame for efficient cooking

1. These settings are based on medium weight metal or aluminum pans with lids. Settings may vary when using other types of pans.

Setting Surface Burners

Your gas appliance may be equipped with different sized surface burners. The ability to heat food quicker and in larger volumes increases as the burner size increases. It is important to select cookware that is suitable for the amount and type of food being prepared.

- The smaller simmer burner (on some models) is best suited for simmering delicate sauces, etc.
- The standard size burners may be used for most surface cooking needs. Some models are equipped with a center burner.
- The larger power burners (on some models) or turbo boil burner (on some models) are recommended for bringing large quantities of liquid to temperature and when preparing larger quantities of food.

To set surface burners:

1. Place cooking utensil on center of surface burner grate. Be sure the cooking utensil sets stable on the burner grate.
2. Push the desired surface control knob in and turn counterclockwise out of the **OFF** position and rotate to the **Lite** position. Visually check that the burner has lit (See [Figure 8](#)).
3. Once the burner has a flame, turn counterclockwise to the desired flame size. Use the control knob markings and adjust the flame as needed.

Important notes:

- Do not cook with the surface control knob left in the Lite position. The electronic ignitor will continue to spark if the control knob setting remains in the Lite position.
- When setting any surface control knob to the Lite position, all electronic surface ignitors will spark at the same time. However, only the surface burner you are setting will ignite.
- Never place or straddle a cooking utensil over two different surface cooking areas at the same time. This can cause uneven heating results.
- In the event of an electrical power outage, the surface burners can be lit manually. Use caution when lighting surface burners manually. To light a surface burner, hold a lit match to the burner head, then slowly turn the surface control knob to Lite. After burner lights push in and turn knob to desired setting.
- When operating the oven, it is possible for residual heat from the oven to build-up and over time to eventually transfer to the surface control knobs located directly above the oven door.
- The cooktop should not be used during a self-clean cycle. On some models, turning on any cooktop surface burner will cause the clean cycle to cancel. If the clean cycle is

anceled, the oven control display will show "SPr" for 5 seconds. The oven door will remain locked until the oven has cooled down below cleaning temperature. If the oven is below cleaning temperature, the user can start another clean cycle immediately. If the oven is in cleaning temperature range, another self-clean cycle can be set once the door unlocks (up to 4 hours).



Figure 8: Correct way to set burners

CAUTION Do not place flammable items such as plastic salt and pepper shakers, spoon holders or plastic wrappings on the cooktop when it is in use. These items could melt or ignite. Potholders, towels or wooden spoons could catch fire if placed too close to the range cooktop.

CAUTION Do not place aluminum foil, or any material that can melt on the range cooktop. If these items melt they may permanently damage the cooktop surface.

Home Canning

Be sure to read and observe all the following points when home canning with your appliance. Check with the United States Department of Agriculture (USDA) website and be sure to read all the information they have available as well as follow their recommendations for home canning procedures.

- Use only quality flat bottom canners when home canning. Use a straight-edge to check canner bottom.
- Use only a completely flat bottom canner.
- Make sure the diameter of the canner does not exceed 1 inch beyond the surface element markings or burner.
- Start with hot tap water to bring water to boil more quickly.
- Use the highest heat setting when first bringing the water to a boil. Once boiling is achieved, reduce heat to lowest possible setting to maintain that boil.

Before Setting Oven Controls

Oven Vent Location

The oven vent is located at the rear of the cooktop. When the oven is on, warm air passes through this vent. This venting is necessary for proper air circulation in the oven and good baking results. Do not block oven vent. Steam or moisture may appear on or around the oven vent during the cooking process. This is normal.

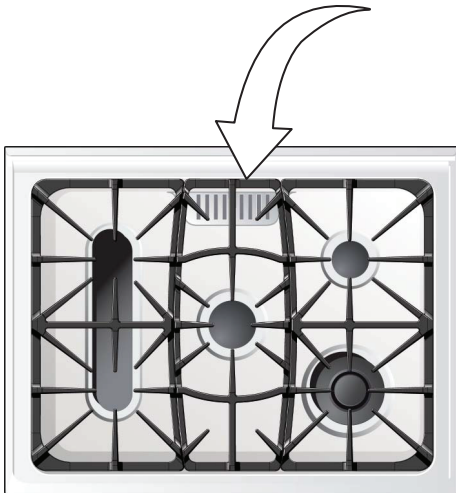

Figure 9: Do not block oven vent location

⚠ WARNING Protective Liners — Do not use aluminum foil to line the oven bottom. Only use aluminum foil as recommended in this manual. Improper installation of these liners may result in risk of electric shock or fire.

⚠ WARNING Be sure to remove all oven racks and accessories before starting a self clean cycle.

⚠ CAUTION Always use pot holders or oven mitts when using the oven. When cooking, the oven interior and exterior, as well as the oven racks, will become very hot which can cause burns.

Removing, replacing, and arranging flat or offset oven racks

- **To arrange** - Always arrange the oven racks when the oven is cool (prior to operating the oven).
- **To remove** - Pull the oven rack straight forward until it reaches the stop position. Lift up front of oven rack slightly and slide out.
- **To replace** - Place the oven rack on the rack guides on both sides of oven walls. Tilt the front of oven rack upward slightly and slide the oven rack back into place. Be sure oven racks are level before using.

Types of Oven Racks

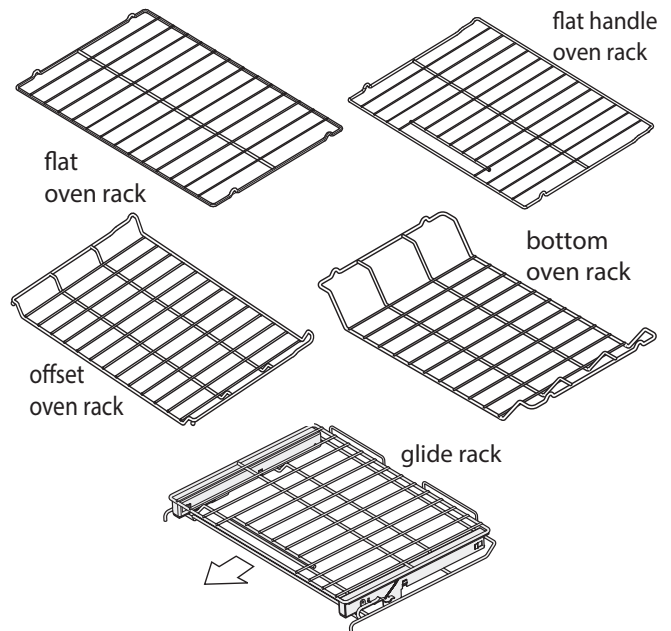

Figure 10: Types of oven racks

Oven Rack Descriptions

- Flat oven racks (or the flat handle oven rack) may be used for most cooking needs and may be placed in most oven rack positions.
- The offset oven rack (some models) provides additional step down positions from the standard flat rack design. The offset design positions the base of the rack about half of a rack position lower than the flat rack and may be used in most oven rack positions.
- The half rack (some models) design comes with a removable section that allows for taller cooking utensils.
- The extendable glide rack allows you to extend food away from the oven.

Glide Racks

The glide rack is an extendable rack that makes food preparation easier. It has glide tracks that allow the rack to be pulled away from the oven without rubbing the sides of the oven wall.

Removing and replacing the glide racks:

To remove the glide rack:

1. Using one hand, reach through the handle opening and lift up on the release lever located across the lower front of the rack, as shown in [Figure 11](#).
2. while holding up the release lever, pull the glide rack out of the oven until the stop position is reached ([See Figure 12](#)).
3. Using both hands, grasp the upper and lower portions of the glide rack.
4. Lift up the front of the rack slightly and continue to pull the rack away from the oven ([See Figure 13](#)).
5. Be sure to grasp both upper and lower rack portions together when removing or handling the glide rack. The rack portions move independently and are difficult to handle unless held together.

To replace the glide rack: ([See Figure 13](#))

1. Grasp both upper and lower portions of the glide rack.
2. Lift and hold the rack level between the oven cavity walls.
3. Tilt the front of the rack upward slightly and slide the rack completely into position. some force may be necessary to make sure the oven rack has snapped into place.

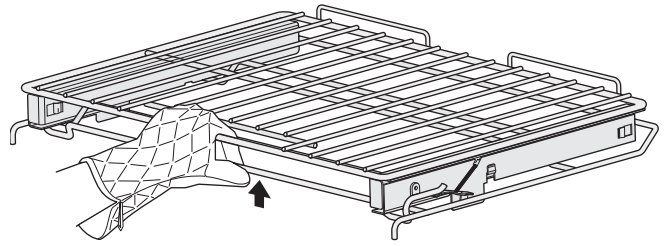

Figure 11: Extendable glide rack

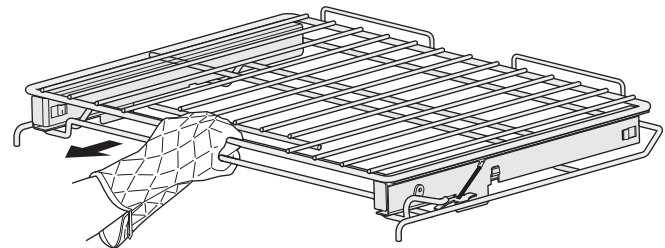

Figure 12: Removing the oven glide rack

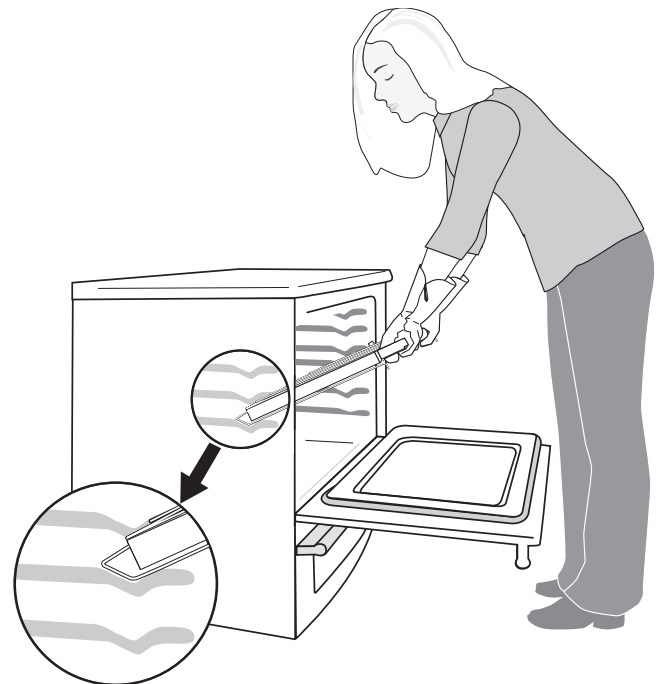
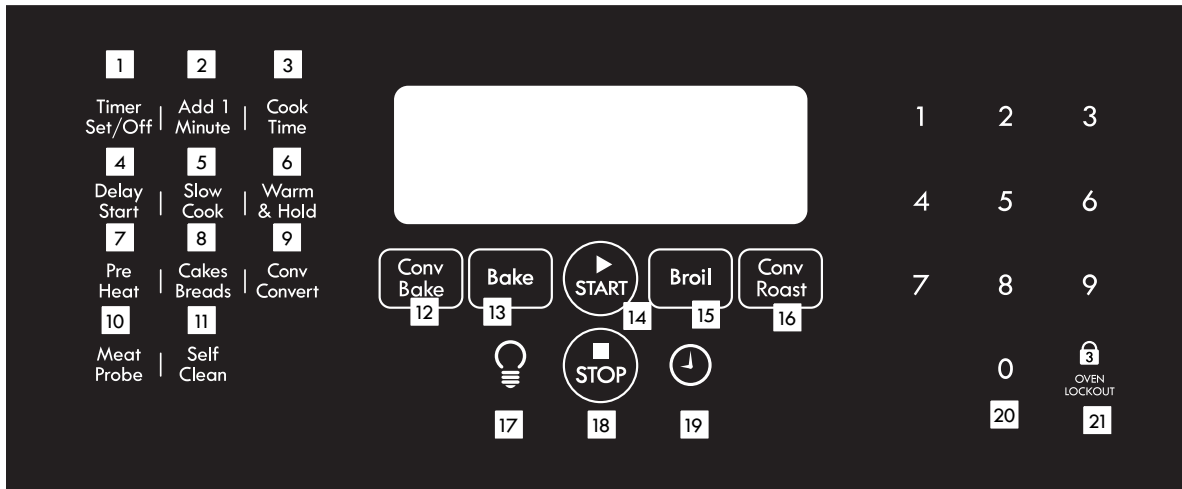

Figure 13: Replacing the oven glide rack

Setting Oven Controls



1. **Timer Set/Off** - Use to set and cancel timer.
2. **Add 1 Minute** - Each press of this key adds one minute of time to an active timer or will start timer when timer is idle.
3. **Cook Time** - Use to set a specific amount of time needed for cooking.
4. **Delay Start** - Use to set delay cooking or delay self clean.
5. **Slow Cook** - Use for cooking foods requiring long cooking times at lower temperatures.
6. **Warm & Hold** - Use to keep cooked food warm in the oven for up to 3 hours after cooking.
7. **Pre Heat** - Use to bring oven to desired temperature for cooking.
8. **Cakes Breads** - Use for baking bread and pastries.
9. **Conv Convert** - Use to convert regular recipe temperature to a convection recipe temperature.
10. **Meat Probe** - Use to set for cooking with probe feature.
11. **Self Clean** - Use to select the self clean function.
12. **Conv Bake** - Use to cook with convection feature.
13. **Bake** - Use to select normal baking function.
14. **START** - Use for starting all cooking functions
15. **Broil** - Use to select broiling function.
16. **Conv Roast** - Use for roasting hams, turkey, roasts.
17. **Oven Light** - Use to turn oven light ON and OFF.
18. **STOP** - Use to stop any cooking function.
19. **Clock** - Use with numeric keys to set the time of day.
20. **Numeric keys** - Use to enter temperatures and cooking times, and use to enter time of day when setting clock.

21. **Oven Lockout** - Use to lock oven door and control panel.

Minimum & Maximum Control Settings

All of the cooking features listed have minimum and maximum time and temperature settings that may be entered into the control. An entry error tone (3 short beeps) will sound if the entry of the temperature or time is below the minimum allowable setting or above the maximum setting for the cooking feature.

Table 2: Minimum and maximum control settings

Feature	Min. Temp. or Time	Max. Temp. or Time
Bake	170 °F (77 °C)	550 °F (288 °C)
Broil	400 °F (205 °C)	550 °F (288 °C)
Cakes/Breads	300 °F (149 °C)	550 °F (288 °C)
Timer	1 Min	11 Hr. 59 Min.
Self Clean	2 Hours	4 Hours
Conv Bake	300 °F (149 °C)	550 °F (288 °C)
Conv Roast	300 °F (149 °C)	550 °F (288 °C)
Slow Cook	LO 225 °F (108 °C)	HI 275 °F (134 °C)
Warm & Hold	170 °F (77 °C)	3 hours
Cook Time	1 Min.	11:59
Delay time 12hr	1:00	12:59
Delay time 24hr	0:00	23:59
Clock 12hr	1:00	12:59
Clock 24hr	0:00	23:59



Setting The Clock

When the appliance is first powered up, **12:00** will flash in the display (See [Figure 14](#)). The time of day must first be set before operating the oven.



Figure 14: 12:00 in display before setting clock

To set clock to 1:30:

1. Press  to begin setting the clock.
2. Enter **1 3 0** using numeric keys.
3. Press . The clock is now set.

Important note:

The clock cannot be changed when a Cook Time, Self Clean, Delay Start or cooking feature is active.

- When the timer is set for more than 1 hour it will display hours and minutes until 1 hour remains. When less than 1 hour remains, the display counts down in minutes and seconds. With less than 1 minute remaining, only seconds will display.
- If the timer is active during a cooking process, the timer will show in the display. To view the status of any other active oven function, press the key of the cooking function once and it will appear in the display for a few seconds.

Setting 12 hour or 24 hour display mode

The clock display mode allows you to select 12 hr or 24 hr modes. The factory pre-set clock display mode is 12 hours.

To set 12 hr or 24 hr display mode:



1. Press and hold  for 6 seconds.
2. Press **Self Clean** to toggle between **12 Hr day** or **24 Hr day** display modes (See [Figure 15](#)).
3. Press  to accept choice.



Figure 15: 12 Hr dAY and 24 Hr dAY settings

Changing Between Continuous Bake Setting or 12 Hour Energy Saving

The oven control has a factory preset built-in 12 Hour Energy Saving feature that will turn off the oven if the oven is left on for more than 12 hours. The control may be programmed to override this feature to bake continuously.

To change between continuous bake or 12 Hour Energy Saving feature:

1. Press and hold **Timer Set/Off** for 6 seconds
2. Press **Self Clean** to toggle between **12 Hour OFF** or **Stay On** ([Figure 16](#)) feature.
3. Press  to accept choice



Figure 16: 12 hr energy saving (L) and continuous setting (R)

Changing Oven Temperature Display

The oven control is preset for temperatures in Fahrenheit (F) when shipped from the factory. The control can be changed to display either Fahrenheit or Celsius (C).

To change the display to Fahrenheit or Celsius:

1. Press and hold **Broil** for 6 seconds.
2. Once **F** (or **C**) appears in the display, press **Self Clean** to toggle between Fahrenheit and Celsius temperature display modes.
3. Press  to accept choice.

Important note:

The oven temperature display cannot be changed during the cooking process or if a Delay Start has been set or Self Clean is active.



Figure 17: Display showing Fahrenheit and Celsius

Setting Oven Controls

Setting Silent or Audible Control mode

Silent mode allows the oven control to operate without audible tones. The control may be programmed for silent operation and later reset to operate with all the normal audible tones.

To set for silent or audible mode:

1. Press and hold **Delay Start** for 6 seconds.
2. Press **Self Clean** to toggle between **bEEP On** or **bEEP OFF**.
3. Press  to accept choice.



Figure 18: Display showing audible and silent operation

Setting Oven Controls Lockout

The control may be programmed to lock the oven door and lock the oven control keys.

To activate the oven lockout features:

1. Be sure oven door is completely closed.
2. Press and hold **Oven Lockout** for 3 seconds. **door Loc** will appear in the display. (Figure 19) The motor driven door latch mechanism will begin locking the oven door automatically. Do not open the oven door. Allow about 15 seconds for the oven door to completely lock. Once door is locked, **Loc** will appear in the display.



Figure 19: Display showing door locking and in locked position

To cancel the oven lockout feature:

1. Press and hold **Oven Lockout** for 3 seconds. The motor door latch will begin unlocking the oven door automatically. Do not open the oven door. Allow about 15 seconds for the oven door to completely unlock.
2. When the **Loc** message no longer displays, the oven door may be opened and the oven control keys will be available for use.

Important note:

- To avoid damage to the oven door latching mechanism, do not attempt to open or close the oven door whenever the **door Loc** message is displayed.
- If a control key is pressed when oven lockout is active, the control will triple beep indicating the key action is not available when the oven lockout feature is active.

Operating Oven Lights

The interior oven lights will automatically turn on when the oven door is opened.

Important note: The oven light will not operate during a self clean cycle.

Press  to turn the interior oven lights on and off whenever the oven door is closed.

The interior oven lights are located on the rear wall of the oven interior and are covered with a glass shield held by metal screws. The glass shield protects the bulb from high temperatures and should always be in place whenever the oven is in use.

To replace the interior oven light, see “[Replacing the Oven Light](#)” on page 37.

Setting Timer

The minute timer allows you to track your cooking times without interfering with the cooking process. The timer may be set from a minimum time of 1 minute to a maximum of 11 hours and 59 minutes.

To set timer for 5 minutes:

1. Press **Timer Set/Off**.
2. Enter **5** using numeric key.
3. Press  to start timer. When set time ends, **END** will show in the display and the control will sound a beep three times every 30 seconds until Timer Set/Off key is pressed.

To cancel the timer when active press **Timer Set-Off** again.

Important note:

- The timer does not start or stop the cooking process. It serves as an extra minute timer that will beep when the set time has run out. The timer may be used alone or while using any of the other oven functions.

Add 1 Minute

Use **Add 1 Minute** to set additional minutes to the timer. Each press of the key will add 1 minute. If **Add 1 Minute** is pressed when the timer is not active, the timer will activate and begin counting down from 1 minute.

To add 2 minutes to the timer:

Press **Add 1 Minute** twice.

Setting PreHeat

For best baking performance use the PreHeat feature. The Preheat feature will bring the oven up to the set cooking temperature. A reminder tone will sound indicating when the set temperature is reached and to place the food in the oven.

When the oven is finished preheating the preheat feature will perform like the Bake feature and continue to maintain the oven set temperature until cancelled.

Preheat may be set for any oven temperature between 170 °F to 550 °F (77 °C to 288 °C).

CAUTION Always use pot holders or oven mitts when using the oven. When cooking, the oven interior, oven exterior, oven racks and cooktop will become very hot which can cause burns.

To set PreHeat with default oven temperature of 350 °F (177 °C):

1. Press **PreHeat**.

2. Press .

To cancel preheating at anytime press .



Figure 20: Oven in preheat mode for baking

To set PreHeat to 450 °F (232 °C):

1. Press **PreHeat**.

2. Press **4 5 0 (2 3 2)** using numeric keys.

3. Press .

To cancel preheating at any time press .

Important note:

- Preheating is not necessary when roasting meats or cooking casseroles.
- For batter and dough-based baked goods such as cakes, pastries, and breads, use the standard bake function or refer to “[Cakes and Breads](#)” on [page 22](#) for best results.

Setting Oven Controls

Setting Bake

Use the bake feature whenever the recipe calls for baking using normal temperatures. A reminder tone will sound indicating when the set bake temperature is reached and to place the food in the oven. During the bake function the display will indicate bake is cycling to maintain the set temperature.

Bake may be set for any oven temperature between 170 °F to 550 °F (77 °C to 288 °C).

To set Bake for oven temperature of 425 °F (218 °C):

1. Press **Bake**.
2. Enter **4 2 5 (2 1 8)** using numeric keys.
3. Press **START**.

To cancel Bake at any time press **STOP**.

For best results:

- Fully preheat the oven before baking items like cookies, biscuits and breads.
- Dark or dull pans absorb more heat than shiny bakeware, resulting in dark or overbrowning of foods. It may be necessary to reduce the oven temperature or cook time to prevent overbrowning of some foods. Dark pans are recommended for pies. Shiny pans are recommended for cakes, cookies and muffins.
- Do not open oven door often. Opening the door will reduce the temperature in the oven and may increase cook time.

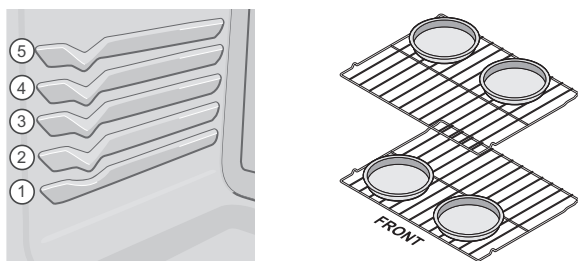

Figure 21: Rack positions and pan spacing recommendations

Radiant rack positions:

- When using any single rack, position the rack so that the food is in the center of the oven (position 3).
- If using the Glide rack, set one position lower than the flat or handle racks.
- For best results when baking cakes using two oven racks, place racks in positions 2 and 4. When baking using two oven racks, position bakeware as shown in [Figure 21](#). Allow at least 2 inches (5 cm) of space between bakeware for proper air circulation.
- Layer cakes will have best results when using the Cakes/Breads function.

Setting Convection Bake

The convection function uses a fan to circulate the oven's heat uniformly and continuously around the oven ([Figure 22](#)). This improved heat distribution allows for fast, even cooking and browning results. It also gives better baking results when using two oven racks at the same time.

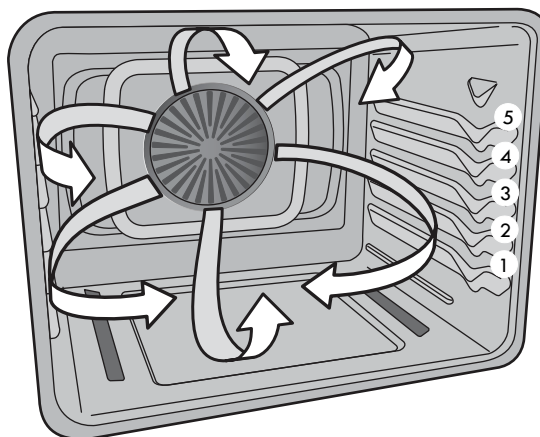

Figure 22: Air circulation in the convection function

Because most food items will cook faster and more evenly with the convection feature, it is advisable to reduce recipe's recommended temperature by 25° for best results. Follow the recipe's instructions using the minimum recommended cook time.

Convection Bake may be set for any oven temperature between 300 °F to 550 °F (149 °C to 288 °C).

Benefits of the convection bake feature:

- Foods may cook up to 25% faster, saving time and energy.
- Multiple rack baking.

For Best Results:

- Fully preheat the oven before baking items like cookies, biscuits and breads.
- For batter and dough-based baked goods such as cakes, pastries, and breads, use the standard bake function or refer to ["Cakes and Breads"](#) on [page 22](#) for best results.
- Cookies and biscuits should be baked on pans with no sides or very low side to allow heated air to circulate around the food.
- Dark or dull pans absorb more heat than shiny bakeware resulting in dark or over browning of foods. It may be necessary to reduce the oven temperature or cook time to prevent over browning of some foods. Dark pans are recommended for pies. Shiny pans are recommended for cakes, cookies and muffins

To set Convection Bake with a default oven set temperature of 350 °F (177 °C):

1. Press **Conv Bake**.
2. Press .

To cancel Convection Bake at any time press .

Convection baking rack positions:

- When using any single rack, position the rack so that the food is in the center of the oven.
- If using the Glide rack, set one position lower than suggested positions for flat or handle racks.
- For best results when baking cakes using 2 oven racks, place racks in positions 2 and 4.
- When baking, allow at least 2 inches (5 cm) of space between bakeware for proper air circulation.

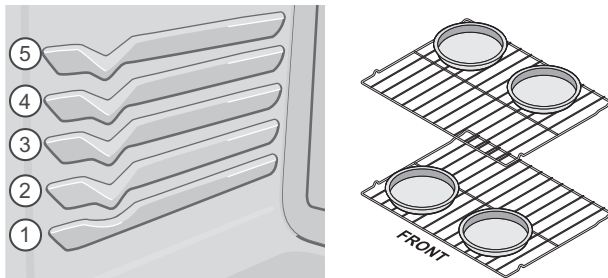

Figure 23: Convection rack positions and pan spacing

Note:

- When setting Bake or any cooking feature that preheats the oven (except Broil), the convection fan will not engage for the first 6 minutes. Afterwards, it will turn on to maintain the oven reaches set temperature.
- The convection fan will begin rotating 6 minutes after Convection Bake, Convection Roast or Convection Convert has been activated.
- If the oven door is opened when the convection function is active, the convection fan will stop rotating until the oven door is closed.
- When using Convection Bake, cook time reductions may vary depending on the amount and type of food being cooked.
- Opening the oven door too often will allow heat to escape and extend the time needed for proper baking.
- Layer cakes will have best results when using the Cakes/Breads function.

Setting Convection Convert



Pressing the **Conv Convert** key automatically converts the cooking temperature entered for any standard baking recipe to the lower temperature required for convection baking.

When Convection Convert is used with a timed Convection Bake setting of 20 minutes or more, the Convection Convert function will display a **CF** message (Figure 24) as a reminder to check food when the bake time is 75% complete. At this time the oven control will sound 1 long beep at regular intervals until the set cook time has finished.



Figure 24: Check Food reminder shown in display.

To program oven for Convection Convert with recipe temperature of 425 °F (218 °C) and to shut-off after 30 minutes:

1. Press **Conv Bake**.
2. Enter **4 2 5 (2 1 8)** using numeric keys.
3. Press  to accept.
4. Press **Cook Time**.
5. Enter **3 0** using numeric keys.
6. Press  to accept.
7. Press **Conv Convert**. Set bake temperature will convert to a lower temperature and begin baking process.

To cancel Convection Convert at any time press .

Important note:

- When using the Convection Convert feature cook time reductions may vary depending on the oven set temperature.
- Once Convection Bake, Convection Roast or Convection Convert has been activated, the convection fan will begin rotating after a 6 minute delay.
- If the oven door is opened when any convection function is active, the convection fan will stop rotating until the oven door is closed.



Setting Oven Controls

Recipe Recall

Use the Recipe Recall feature to record and recall your favorite baking recipe settings. This feature stores and recalls different recipe settings using Bake, Conv Bake, and Conv Roast.

Recipe Recall may be programmed for any baking temperature between 170 °F to 550 °F (77 °C to 288 °C).

To store a Bake recipe. The recipe in this example is for a Bake at 325°F (162°C) with a cook time of 45 minutes:

1. Press **Bake**.
2. Press **3 2 5 (1 6 2)** using the numeric keys to enter oven temperature.
3. Press .
4. Press **Cook Time**.
5. Press **4 5** using numeric keys to enter cook time.
6. Press and hold  until a tone sounds (about 3 seconds). The tone indicates that the recipe setting has been recorded for future recall.
7. Press .

Important note: The oven will automatically start heating with the recorded recipe unless  is pressed at this time.

To recall recipe stored in the example shown above. Recipe is for bake at 325°F (162°C) for 45 minutes:

1. Position cookware in oven and close door.
2. Press **Bake**. (If recipe was stored using another cooking feature press that instead.)
3. Press . The oven will begin to cook with the programmed recipe. If Cook Time was recorded this feature will also recall the cooking time.

To cancel Recipe Recall at anytime press .

To erase a stored recipe:

1. Press the function where the recipe is stored.
2. Press .
3. Press **Cook Time**, enter **0 (zero)** and hold **start key** for 3 seconds until you hear the acceptance tone.

Important note:

- The Recipe Recall stores **Bake, Conv Bake, Conv Roast, Slow Cook, Cakes Breads and Preheat settings**. This feature will not work with **Delay Start** settings.
- If a recalled recipe includes Cook Time the oven will automatically shut-off when the Cook Time is finished.

Cakes and Breads

The Cakes Breads functions are designed to give optimum baking performance for cakes or breads. These functions work well for baking cakes, brownies, pies (fresh or frozen), baked custards, cheesecakes, breads, rolls, biscuits, muffins and corn bread.

The Cakes function provides a preheat with a gentle cycling of heat giving cakes more volume and allowing delicate foods to cook more evenly.

The Breads function adds a special preheat feature to the bake cycle that thoroughly heats the oven from top to bottom to give more evenly browned foods.

To set the Cakes or Breads features with a default temperature of 350 °F (177 °C):

1. Arrange interior oven racks when cool. Preheat oven as desired and place food in oven.
2. For Cakes, press the **Cakes Breads** until **CAKES** appears in the oven control display.

For Breads, press the **Cakes Breads** until **BREADS** appears in the oven control display

3. Press .



Figure 25: Oven set for Cake baking



Figure 26: Oven set for Bread baking

Important note:

- Dark or dull pans and glass absorb more heat than shiny bakeware resulting in dark, over browned, or under cooked foods. To prevent this it may be necessary to reduce the oven temperature or cook time of some foods.
- Do not open the oven door too often. Opening the door will reduce the temperature in the oven.
- Breads will have better results baking on a single oven rack.
- Layer cakes will have best results using the Cakes/Breads function. For pan spacing and rack setting, refer to [Figure 23 on page 21](#).



Important:

Use the same pan placement recommendation and rack position used with convection bake. For multi-rack baking of cakes and breads, this is the preferred recommended setting.

Setting Cook Time

Use **Cook Time** to program the oven control to automatically turn the oven function off after a desired length of time.

To program oven to bake with oven default temperature of 350 °F (177 °C) and to shut-off after 30 minutes:

1. Press **Cook Time**.
2. Enter **3 0** using numeric keys.
3. Press  to accept.
4. Press **Bake**.
5. Press .

When the programmed cook time ends:

End will appear in the display window and the oven will shut-off automatically. (Figure 27) The oven control will beep 3 times every 30 seconds as a reminder until  is pressed.



Figure 27: Display showing cooking has ended

Important note:



- The Cook Time feature may be set with Bake, Convection Bake, Convection Roast, Slow Cook and Preheat. Cook Time will not operate with the Broil function.
- The maximum Cook Time setting is 11 hours and 59 minutes unless oven is set for continuous cooking.
- To check the time remaining during a timed cooking function, press the Cook Time key once and the time remaining will appear in the display momentarily.

Setting Delay Start

Delay Start sets a delayed starting time to oven cooking or cleaning functions. Prior to setting a delay start, be sure the time of day is set correctly.

⚠ WARNING Food poisoning hazard. Do not let food sit for more than one hour before or after cooking. Doing so can result in food poisoning or sickness. Foods that can easily spoil such as milk, eggs, fish, meat or poultry, should be chilled in the refrigerator first. Even when chilled, they should not stand in the oven for more than 1 hour before cooking begins, and should be removed promptly when finished cooking.

To program oven for a Delay Start beginning at 5:30, to shut-off automatically after 50 minutes and for baking at 375 °F (190 °C):

1. Press **Cook Time**.
2. Enter **5 0** using numeric keys.
3. Press  to accept.
4. Press **Delay Start**.
5. Enter **5 3 0** using numeric keys.
6. Press  to accept.
7. Press **Bake**.
8. Enter **3 7 5 (1 9 0)** using numeric keys.
9. Press .

When the programmed cook time ends:

End will appear in the display window and the oven will shut off automatically. (Figure 27) The oven control will beep 3 times every 30 seconds as a reminder until  key is pressed.

Important note:

- Delay Start may be set using a 24 hr clock. To set clock for 24 Hr operation See “Setting 12 hour or 24 hour display mode” on page 17 for more information.
- The Delay Start feature may be used with Convection Bake, Convection Roast, Convection Convert, Bake, Slow Cook and Preheat functions and Self Clean. Delay Start or Cook Time will not operate with the Broil function.

Setting Oven Controls

Setting Broil

Use the broil function to cook meats that require direct exposure to radiant heat for optimum browning results. The Broil feature is factory preset to broil at 550 °F. The Broil function temperature may be set at any temperature between 400 °F (205 °C) and 550 °F (288 °C).

The suggested broil settings table (Table 3) are recommendations only. Depending on cooking preferences you can increase or decrease cooking times or move food to a different rack position. If the food you are broiling is not listed in the table, follow the instructions provided in your cookbook and watch the item closely.

⚠ WARNING Should an oven fire occur, close the oven door and turn the oven off. If the fire continues, use a fire extinguisher. Do not put water or flour on the fire. Flour may be explosive.

⚠ CAUTION Always use pot holders or oven mitts when using the oven. When cooking, the oven interior, exterior, oven racks and oven will become very hot which can cause burns.

Important note:

- Always arrange oven racks when oven is cool. Be sure to close oven door when broiling.
- For best results when broiling, use quality broil pan along with a broil pan insert. A broil pan is designed to drain the fat from food, helping to reduce smoking and avoid splatter. Do not use the pan without the insert. Do not cover the insert with foil – the exposed grease could ignite.
- When broiling, always pull the oven rack out to the stop position before turning or removing food.
- Keep door closed during broil.

Table 3: Suggested Broil Settings

Food	Rack Position	Setting	Cook Time in minutes		Preparation
			1st side	2nd side	
Steak 1" thick	4th or 5th*	550 °F/288 °C	6	4	Medium
Steak 1" thick	4th or 5th*	550 °F/288 °C	7	5	Medium-well
Steak 1" thick	4th or 5th*	550 °F/288 °C	8	7	Well
Pork chops 3/4" thick	4th	550 °F/288 °C	8	6	Well
Chicken (bone in)	3rd	450 °F/232 °C	20	10	Well
Chicken (boneless)	3rd	450 °F/232 °C	8	6	Well
Fish	5th*	550 °F/288 °C	- as directed - - as directed -		Well
Shrimp	4th	550 °F/288 °C			Well
Hamburger 1" thick	5th*	550 °F/288 °C	9	7	Medium
Hamburger 1" thick	4th	550 °F/288 °C	10	8	Well

*Use the offset rack when broiling in the 5th position.

To set Broil with the default broil oven temperature of 550°F:

1. Arrange the oven racks when cool. For optimum browning results, preheat oven for 5 minutes before adding food.
2. Position bakeware in oven to the preferred rack position. (Figure 28).
3. Press **Broil**.
4. Press **START**.
5. Broil on one side until food is browned; turn and broil other side until done to your satisfaction.
6. When finished broiling press **STOP**.
7. To cancel Broil at any time press **STOP**.

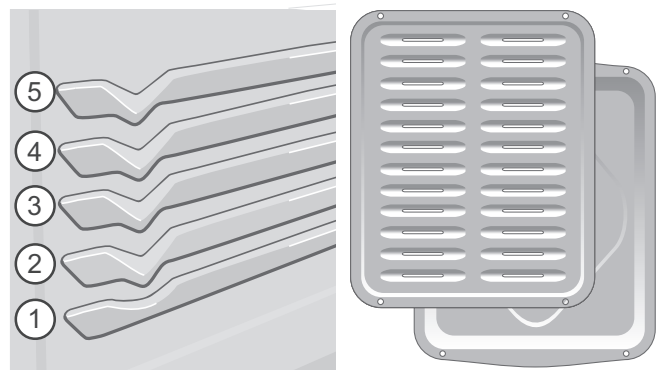

Figure 28: Broil rack positions and broil pan with insert

If a broiler pan and insert are not supplied with this appliance you may purchase them. Call Sears at 1-800-4-MY-HOME (1-800-469-4663) and order broiler pan kit 5304442087.

Setting Convection Roast

The Convection Roast function combines a cook cycle with the convection fan to roast meats and poultry. Meats cooked using the Convection Roast function will be juicier and poultry will be crisp on the outside while staying tender and moist on the inside.

Convection Roast may be set for any oven temperature between 300 °F to 550 °F (149 °C to 288 °C).

Suggestions for Convection Roast:

- Preheating is not necessary when roasting foods using Convection Roast. Since Convection Roast cooks food faster, reduce the cook time by 25% from the recommended cook time of your recipe. If necessary, increase cooking time until the desired doneness is obtained.
- The broiler pan will catch grease drippings, and the grid will help prevent splatters. The roasting rack will hold the meat. Use the offset rack on rack position 1.
- Do not cover foods when dry roasting as this will prevent the meat from browning properly.

To set Convection Roast with a default oven set temperature of 350 °F (177 °C):

1. Press **Conv Roast**.

2. Press .

To cancel Convection Roast at any time press .

Important note:

- Once Convection Bake, Convection Roast or Convection Convert has been activated, the convection fan will begin rotating after a 6 minute delay.
- If the oven door is opened when any convection function is active, the convection fan will stop rotating until the oven door is closed.
- It is not recommended to roast chicken on a roasting rack. Use a deep pan instead and roast on rack position 1.

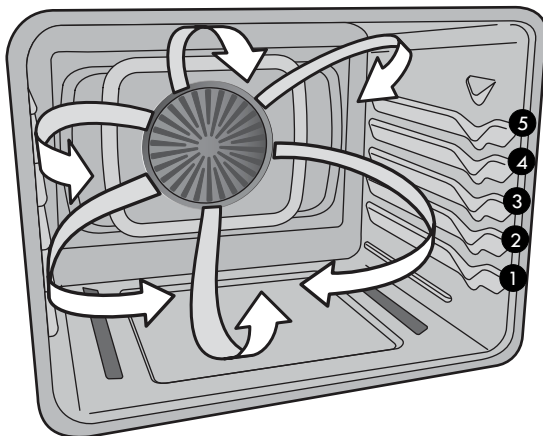

Figure 29: Air circulation in the convection function

Setting Slow Cook

The Slow Cook feature cooks foods more slowly and at lower oven temperatures for longer periods of time. Slow Cook is ideal for roasting beef, pork and poultry. Slow cooking meats may result in the exterior of meats becoming dark but will not burn the outside as it seals in the meat's juices.

Two Slow Cook settings are available, high (Hi) or low (Lo). The high setting is best for cooking foods between 4 and 5 hours. The low setting is best for cooking foods up to 9 hours or longer.

⚠ WARNING Food poisoning hazard. Do not let food sit for more than one hour before or after cooking. Doing so can result in food poisoning or sickness. Foods that can easily spoil such as milk, eggs, fish, meat or poultry, should be chilled in the refrigerator first. Even when chilled, they should not stand in the oven for more than 1 hour before cooking begins, and should be removed promptly when finished cooking.

Some tips for best results when using Slow Cook:

- Completely thaw all frozen foods before cooking.
- When using a single oven rack, place in oven rack position 2 or 3. Position racks to accommodate the size of various bakeware when cooking multiple food items.
- Do not open the oven door often or leave the door open when checking foods. If the oven heat escapes often, the Slow Cook time may need to be extended.
- Cover to keep foods moist or use a loose or vented type cover to allow foods to turn crisp or brown.
- Roasts may be left uncovered so browning can occur. Cook times will vary depending on the weight, fat content, bone, and the shape of the roast. Preheating the oven will not be necessary when using the Slow Cook feature.
- Add any cream or cheese sauces during the last hour of cooking.

To set Slow Cook:

1. Position bakeware in oven and close oven door.
2. Press **Slow Cook**. **HI** will appear in the display indicating the default temperature setting is for high.
3. If a low setting is needed, press **Slow Cook** again to select the low setting.
4. Press  to activate Slow Cook.

To cancel Slow Cook at any time press .

Important note:

- Slow Cook may be used with additional settings of Cook Time and Delay Start.
- The maximum cook time for Slow Cook function is 11 hours and 59 minutes unless the control has been changed to the continuous bake mode.

Setting Oven Controls

Meat Probe

When cooking meat such as roasts, hams or poultry, use the meat probe function to check the internal temperature without any guesswork. For some foods, especially poultry and roasts, testing the internal temperature is the best method to insure properly cooked meats.

Important note:

- Use only the meat probe supplied with appliance. Using any other probe or device may result in damage to appliance and the meat probe receptacle.
- Never leave or store meat probe inside oven.
- Handle the meat probe carefully when inserting and removing from food or probe receptacle. Do not use tongs to pull on meat probe cable when inserting or removing from food or receptacle.
- Defrost food completely before inserting meat probe to avoid damaging probe.
- To avoid possibility of burns, after cooking carefully unplug meat probe using a pot holder to protect hands.

Proper meat probe placement:

Always insert meat probe so that the probe tip rests in the center of the thickest part of meat. Do not allow meat probe to touch bone, fat, gristle or cookware.

For bone-in ham or lamb, insert meat probe into the center of lowest large muscle or joint. For dishes such as meat loaf or casseroles, insert meat probe into center of food. When cooking fish, insert meat probe just above the gill.

For whole poultry or turkey, insert meat probe into the thickest part of inner thigh, below the leg (See [Figure 30](#)).

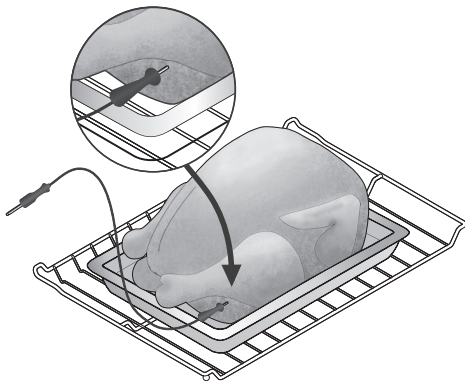





Figure 30: Probe into thickest part of thigh

Important note:

Changing how the oven reacts after reaching the target temperature must be done before starting the cooking process.

To set meat probe:

1. Prepare the food and properly insert the temperature probe into the food. Do not preheat or start cooking before properly inserting the meat probe. Probe should be inserted into the food and receptacle while the oven is still cool.
2. Place the prepared food on the desired oven rack position and slide into the oven.
3. Plug the meat probe into the probe receptacle located on the top left front oven cavity. When the meat probe is correctly plugged into the receptacle, the probe icon will illuminate in the oven control display.
4. To set the target temperature press **Meat Probe** once then enter the desired target internal temperature using the numeric key pads (default setting is 170 °F/ 77 °C).
5. Press  to accept the meat probe target temperature. Close the oven door.
6. Set the oven control for Bake, Convection Bake or Convection Roast and the desired oven temperature. The meat probe cannot be set with Broil or Self-Clean.
7. While cooking, the actual meat probe temperature will display by default. To view the target temperature press **Meat Probe** once. After 6 seconds the display will show the actual meat probe temperature. If the target temperature needs to be changed during the cooking process, press **Meat Probe** once and use the numeric keys to adjust the target temperature. Press  to accept any change.
8. The oven control will provide 3 beeps when the internal target temperature is reached. The oven will automatically change to a **Warm & Hold** setting and maintain the oven temperature at 170 ° F (77 °C). Instructions for changing how the oven reacts after reaching the internal target temperature may be found later in this section.
9. Press  to cancel cooking at any time.

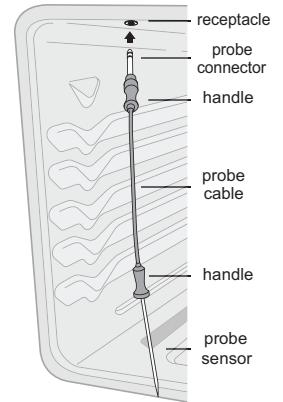

To set the oven to continue cooking after reaching the probe target temperature:

1. Press **Meat Probe** and hold for 6 seconds.
2. Press **Self Clean** and toggle until the **Continu** message appears then press  to accept.

To set the oven to cancel cooking and automatically start Warm & Hold after reaching the probe target temperature:

1. Press **Meat Probe** and hold for 6 seconds.
2. Press **Self Clean** and toggle until **CAnCEL** message appears.
3. Press  to accept.



Figure 31: Probe set to continue cooking



Figure 32: Probe set to cancel cooking

Minimal Internal Cooking temperatures

Food type	Internal temperature
Beef, veal, lamb-roasts, steak & chops	
Medium	160 °F (71 °C)
Well done	170 °F (77 °C)
Fresh pork-roasts, steaks & chops	
Medium	160 °F (71 °C)
Well done	170 °F (77 °C)
Ham	160 °F (71 °C)
Poultry	
Whole chicken, turkey	165 °F (74 °C)
Poultry breasts, roasts	165 °F (74 °C)
Stuffing (cooked alone or in bird)	165 °F (74 °C)
Leftovers	165 °F (74 °C)

Information courtesy the U.S. Department of Agriculture Food Safety and Inspection Service.

The USDA states, "Rare fresh beef is popular, but you should know that cooking it to only 140 °F/60 °C means some food poisoning organisms may survive." (Source: Safe Food Book, Your Kitchen Guide, USDA Rev. June 1985.) The lowest temperature recommended by the USDA is 145 °F/63 °C for medium rare fresh beef.

Setting Oven Controls

Warm & Hold

⚠ WARNING Food poisoning hazard. Do not let food sit for more than one hour before or after cooking. Doing so can result in food poisoning or sickness

Warm & Hold should only be used with foods that are already at serving temperatures. Warm & Hold will keep cooked foods warm and ready for serving for up to 3 hours after cooking has finished. After 3 hours the Warm & Hold will shut-off automatically. Warm & Hold will keep the oven temperature at 170 °F (77 °C).

To set Warm & Hold:

1. If needed, arrange oven racks and place cooked food in oven.
2. Press **Warm & Hold**. **Hld** will appear in the display. If no other keys are touched within 25 seconds the request for Warm & Hold will clear.
3. Press **START**. Warm & Hold will automatically turn on and then turn off after 3 hours unless cancelled.

To turn Warm & Hold off at any time press **STOP**.

To add Warm & Hold to turn ON after baking 45 minutes with a set temperature of 425 °F (218 °C):

1. Press **Cook Time**.
2. Enter **4 5** using numeric keys.
3. Press **START**.
4. Press **Bake** and enter **4 2 5 (2 1 8)** on numeric keys.
5. Press **START** to accept.
6. Press **Warm & Hold**. **Hld** will appear in the display.
7. Press **START** to accept. When the cook time is over, the Warm & Hold will automatically turn on. The Warm & Hold function will automatically turn off after 3 hours.

Important note:

- Warm & Hold will maintain the oven temperature at 170 °F (77 °C) for 3 hours.
- Warm & Hold may be set when finished cooking or may be added to automatically turn on after cooking using Cook Time. Delay Start may also be added.

Warmer Drawer

The warmer drawer keeps hot cooked foods at serving temperature. Use the warmer drawer feature to keep cooked foods hot such as vegetables, gravies, casseroles, soups, stews, breads, pastries and oven safe dinner plates at serving temperature.

Important:

Always start with hot food. Do not heat cold food with the warmer drawer. All food placed on the warmer drawer should be covered with a lid to maintain quality. For best results, when warming pastries or breads, the cover should have an opening to allow moisture to escape. Use only dish ware, utensils and cookware recommended for oven and cooktop use in the warmer drawer.

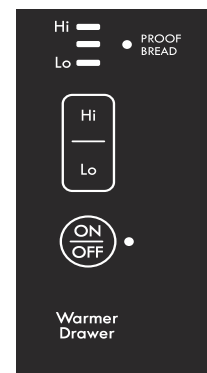

Figure 33: Warmer Drawer with three heat settings

1. Press **Warmer Drawer**. The warmer drawer indicator light will turn on.
2. Press the desired heat setting of either **LO** or **HI**. The lights will indicate the minimum or maximum settings.
3. Press either **LO** or **HI** again to adjust the warmer temperature to the level desired. The warmer drawer indicator light will remain lit until the warmer drawer is turned off.
4. When ready to serve, press the warmer drawer key until the indicator light is off.

⚠ WARNING Food poisoning hazard. Do not let food sit for more than one hour before or after cooking. Doing so can result in food poisoning or sickness.

Arranging Warmer Drawer Rack Positions

The warmer drawer rack can be set in two positions to accommodate foods and any items that need to be warmed or kept warm. The rack must be placed in the vertical position in one of two ways.

Place the rack in the upright position (Figure 34) to place low profile food items under and on top of the rack (for example, rolls or biscuits on top of the rack and a casserole dish under).

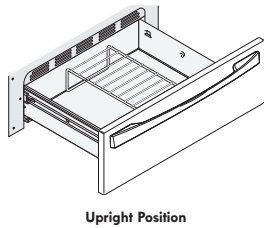

Figure 34: Warmer Drawer in upright position

In the downward position (Figure 35) to allow the placement of light weight food items and empty dish ware (for example, rolls or pastries and dinner plates).

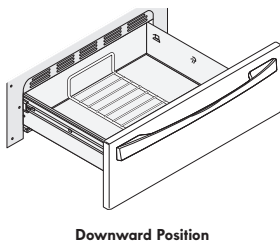

Figure 35: Warmer Drawer in downward position

Important notes:

- Use only plates, utensils and cookware recommended for oven and ceramic cooktop use. Do not use plastic wrap or aluminum foil to cover food. Plastic or aluminum foil can melt onto the cooktop.

Warmer Drawer Settings

Refer to the warmer drawer recommended food settings below. If a particular food is not listed, start with the medium level, and adjust as needed.

Table 4: Suggested settings for Warmer drawer

Food Item	Heating level
Breads/ Pastries	LO
Casseroles	LO
Dinner Plates with food	LO
Eggs	LO
Gravies	LO
Meats	MED
Sauces	MED
Soups (Cream)	MED
Stews	MED
Vegetables	MED
Fried foods	HI
Hot beverages	HI
Soups (clear)	HI

CAUTION Do not place flammable items such as plastic salt and pepper shakers, spoon holders or plastic wrappings on top of the range when it is in use. These items could melt or ignite. Potholders, towels or wooden spoons could catch fire if placed too close to the surface elements. Do not allow aluminum foil, empty glass-porcelain cookware or any material that can melt to make contact with the ceramic cooktop.

Setting Oven Controls

Proof Bread (Warmer Drawer)

The warmer drawer has a Proof Bread feature that may be used to prepare bread dough. The recommended length of time to keep fresh or thawed bread dough in the warmer drawer is about 45-60 minutes. Times may vary depending on the dough. Be sure to follow the recipe's recommended times.

Since the bread dough will nearly double in volume be sure to place the prepared dough in a large bowl. Arrange the warmer drawer rack in the downward position (Figure 36) and place the bowl with dough on the warmer drawer rack.

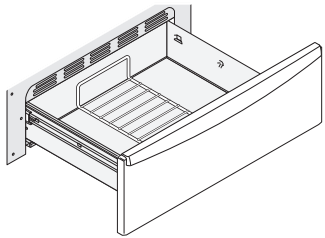

Figure 36: Warmer drawer rack down for proofing bread

To set Proof Bread using warmer drawer:

1. Arrange the warmer drawer rack in warmer drawer and place bread dough in a large bowl on warmer drawer rack.
2. Close the warmer drawer.
3. Press **ON-OFF** to turn on warmer drawer.
4. Press **Lo** once set warmer drawer to Lo power setting.
5. Press **Lo** again and the **Proof Bread indicator light** will turn on. This is the automatic setting for using the Proof Bread feature.
6. When the bread dough is ready, press **ON-OFF** to turn the warmer drawer off and remove bread dough from warmer drawer.

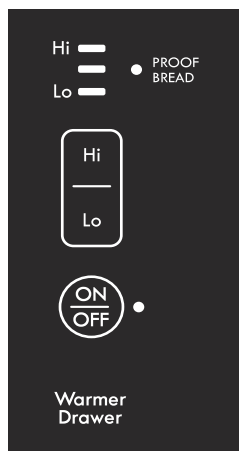

Figure 37: Use Warmer Drawer control to set Proof Bread

Setting the Sabbath feature (for use on the Jewish Sabbath and Holidays)



For further assistance, guidelines for proper usage and a complete list of models with the Sabbath feature, please visit the web at www.star-k.org.

This appliance provides special settings for use when observing the Jewish Sabbath/Holidays. Sabbath mode disables all audible tones or visual display changes on the oven control. Bake heating is the only cooking feature available while in the Sabbath mode. Oven controls are locked during Sabbath mode.

You must first set the Bake feature and temperature(s) needed for the oven, and the Cook Time and Delay Start options (if needed). Any settings made prior to setting the Sabbath mode will be visible in the displays. The Cook Time option, if set prior to the Sabbath mode, will give one audible alert at the end of Cook Time.

The Sabbath mode will override the factory preset 12 Hour Energy Saving mode and the appliance will stay on until the cooking features are cancelled. If any of the cooking features are cancelled when the appliance is in the Sabbath mode, no audible or visual indicators will be available to verify the cancellation.

If the oven interior lights are needed, be sure to activate them prior to setting the Sabbath mode. Once the oven light is turned on and the Sabbath mode is active, the oven light will remain on until the Sabbath mode is turned off and the oven lights are turned off. The oven door will not activate the interior oven lights when the oven door is opened or closed.

It is recommended that any oven temperature modification made within an active Sabbath mode be followed with 2 presses of the **START** key. This will insure the oven remains on even if an attempt is made to set the oven temperature outside of its temperature range. If the oven temperature is set outside of the temperature range, the oven will default to the nearest available temperature. Try to set the desired oven temperature again.

WARNING Food poisoning hazard. Do not let food sit for more than one hour before or after cooking. Doing so can result in food poisoning or sickness. Foods that can easily spoil such as milk, eggs, fish, meat or poultry, should be chilled in the refrigerator first. Even when chilled, they should not stand in the oven for more than 1 hour before cooking begins, and should be removed promptly when finished cooking.

To program oven to Bake with default oven temperature of 350°F and activate the Sabbath feature:





1. Be sure the clock is set with the correct time of day.
2. Arrange oven racks, place bakeware in oven and close oven door.
3. Press **Bake**.
4. Press .
5. If Cook Time or Delay Start are not needed, skip this step and continue to step 6. If a Cook Time or Delay Start are desired enter the times at this point. Refer to the “Setting PreHeat” and “Setting Bake” on page 19 for detailed instructions.
6. Press and hold **Cook Time** and **Delay Start** simultaneously for about 3 seconds to set the Sabbath feature. Once the feature is set, **SAb** (Figure 38) will appear in the display indicating the oven is properly set for the Sabbath feature.



Figure 38: Oven set for Sabbath baking.

Important note:

- Do not attempt to activate any other oven function except Bake while the Sabbath feature is active. The following keys will function correctly when the Sabbath feature is active: 0-9 number keys, Bake,  and . All other keys should not be used once the Sabbath feature is active.
- You may change the oven temperature once baking has started. Press **Bake**, use the numeric keys to enter the oven temperature change (170°F to 550°F) and press  (for Jewish Holidays only).
- Remember that the oven control will no longer provide audible tones or display any further changes when the Sabbath feature is active.
- Remember the oven will shut-off automatically after completing a Cook Time, Delay Start or Warm & Hold and therefore may only be used once during the Sabbath/Jewish Holidays.
- If a Delay Start time longer than 11 hours and 59 minutes is desired, set the oven control for the 24 hour day display mode setting. For detailed instructions see “Setting 12 hour or 24 hour display mode” on page 17.

To turn the oven off and keep the Sabbath feature active:

Press .

To turn off the Sabbath feature:

Press and hold both **Cook Time** and **Delay Start** simultaneously for at least 3 seconds to turn the Sabbath feature off. The control will provide an acceptance tone and **SAb** will disappear from the display. The oven is no longer programmed for the Sabbath feature.

What to do during a power failure or power interruption after the Sabbath feature was activated:

Should you experience a power failure or interruption, the oven will shut-off. When power is restored the oven will not turn back on automatically. The oven will remember that it is set for the Sabbath and the oven display will show the message **SF** for Sabbath failure (Figure 39).



Figure 39: Display showing Sabbath failure

The food may be safely removed from the oven while still in the Sabbath feature, however the oven cannot be turned back on until after the Sabbath/Holidays. After the Sabbath observance turn off the Sabbath feature. Press and hold both Cook Time and Delay Start keys for at least 3 seconds simultaneously to turn the Sabbath feature off. SF will disappear from the display and the oven may be used with all normal functions.

Setting Oven Controls

Restoring Factory Default Settings

Your appliance was set with predetermined (default) oven control settings. The following options may have been modified since the appliance was new:

- 12 or 24 hr display mode
- Continuous bake or 12 Hour Energy Savings mode
- Silent or audible control
- Oven temperature display (Fahrenheit or Celsius)
- Oven temperature adjustments (UPO)
- Any stored recipes will be erased.

To restore oven control to factory default settings:

⚠ CAUTION If you choose to restore any of the options by using this method, all user settings will be restored to the factory default settings. This includes the oven temperature offset that will reset to (0) zero.

1. Press and hold **7** on numeric keys until acceptance tone sounds (about 6 seconds).
2. Press . The control has been reset with the default settings.

Adjusting Oven Temperatures

Your appliance has been factory calibrated and tested to ensure accurate baking temperatures. For the first few uses, follow your recipe times and temperature recommendations carefully. If you think the oven is cooking too hot or too cool for your recipe times, you may adjust the control so the oven cooks hotter or cooler than the oven temperature displayed. The oven temperature may be increased as much as +35°F (+19°C) or decreased -35°F (-19°C) from the factory calibrated settings.

To increase (+) or decrease (-) the oven temperature by 20 °F:

1. Press and hold **Bake** for about 6 seconds. The factory offset temperature of **0 (zero)** should appear in the display.
2. Enter **2 0** using numeric keys.
3. Press **Self Clean** to toggle between plus (+) if increasing temperature or minus (-) if decreasing the temperature.
4. Press  to accept change.

Important note:

- Oven temperature adjustments will not change the Broil or Self Clean function temperatures.
- If the temperature shows an adjustment of -20 °F, and a +20 °F adjustment is needed, toggle between the (±) in the display by pressing the **Self Clean** key.
- Do not use oven thermometers such as those found in grocery stores to check the temperature settings inside your oven. These oven thermometers may vary as much as 20 to 40°F degrees from actual temperatures.

Self Clean

A self cleaning oven cleans with very high temperatures well above normal cooking temperatures. The high temperature eliminates soils completely or reduces them to a fine powdered ash you can wipe away afterwards with a damp cloth.

The Self Clean function allows you to set a cleaning time from 2 hours to 4 hours. A 3 hour cleaning time is recommended for normal cleaning, 2 hours for light cleaning, and 4 hours for heavy cleaning.

Read before starting Self Clean:

⚠ CAUTION Do not leave small children unattended near the appliance. During the self cleaning cycle, the outside of the oven can become very hot to touch and can cause burns.

⚠ CAUTION Do not line the oven walls, racks, bottom or any other part of the oven with aluminum foil. Doing so will destroy heat distribution, produce poor baking results and cause permanent damage to the oven interior. Aluminum foil will melt to the interior of the oven.

⚠ CAUTION Some birds are extremely sensitive to the fumes given off during the self cleaning cycle of any oven. Move birds to another well-ventilated room.

⚠ CAUTION Do not force the door open while self clean is active. This can damage the automatic door locking system. Use caution when opening the oven door after self cleaning. The oven may still be very hot and can cause burns. To avoid possible burns stand to the side of the oven when opening the oven door to allow hot air or steam to escape.

Important note:

- Completely remove all oven racks (including glide racks) and any accessories from oven cavity to avoid damage to oven racks. If the oven racks are not removed they may discolor.
- Remove all items from the oven including bakeware, utensils and any aluminum foil. Aluminum foil will not withstand high temperatures from a self clean cycle and will melt.
- Do not use oven cleaners or oven protective coatings in or around any part of the oven interior.
- Clean any soil from the oven frame, the door liner outside the oven door gasket and the small area at the front center of the oven bottom (Figure 40). These areas heat sufficiently to burn soil on. Clean using soap and water prior to starting Self Clean.
- Do not clean the oven door gasket (Figure 40). The woven material of the oven door gasket is essential for a good seal. Care should be taken not to rub, damage or remove the gasket. Do not use any cleaning materials on the oven door gasket. Doing so could cause damage to the door gasket.

- The cooktop should not be used during a self-clean cycle. On some models, turning on any cooktop surface burner will cause the clean cycle to cancel. If the clean cycle is canceled, the oven control display will show "SPr" for 5 seconds. The oven door will remain locked until the oven has cooled down below cleaning temperature. If the oven is below cleaning temperature, the user can start another clean cycle immediately. If the oven is in cleaning temperature range, another self-clean cycle can be set once the door unlocks (up to 4 hours).
- Remove any excessive build up caused by spills. Any spill on the oven bottom should be wiped up and removed before starting a self clean cycle. To clean, use hot, soapy water and a cloth. Large spill residue can cause heavy smoke or fire when subjected to high temperatures. Do not allow food spills with a high sugar or acid content (such as milk, tomatoes, sauerkraut, fruit juices or pie filling) to remain on the surface as they may leave a dull spot even after cleaning.

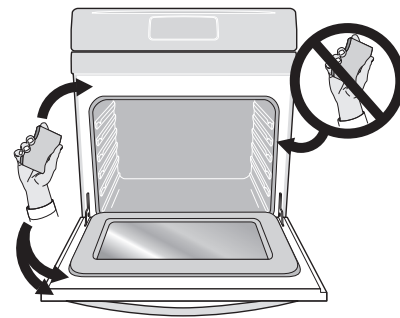



Figure 40: Oven door area to clean and not clean (gasket).

Setting Oven Controls

To set self clean:

1. Be sure the oven is empty and all oven racks are removed, and oven door is completely closed.
2. Press **Self Clean**. A 3 hour clean time will appear in the display. To choose a different clean time. Press **Self Clean** and use the numeric keys to select any time between 2 and 4 hours. Once time is selected proceed to step 3.
3. Press  to activate Self Clean.

As soon as Self Clean becomes active, a motor driven lock mechanism will begin locking the oven door automatically and **door Loc** will appear in the display (Figure 41). Do not open the oven door when **door Loc** is displayed (allow 15 seconds for the lock mechanism to lock the oven). Once the oven door has locked, **CLn** will appear in the display indicating Self Clean has started.



Figure 41: Door locking (L) and active Clean (R) shown



Figure 42: Hot oven door locked (L) door open message (R).

When Self Clean is finished:

CAUTION Use caution when opening the oven door after self cleaning. The oven may still be very hot and can cause burns. To avoid possible burns stand to the side of the oven when opening the oven door to allow hot air or steam to escape. The oven bake and broil elements may appear to have cooled after they have been turned off. The elements may still be hot and burns may occur if these elements are touched before they have cooled."

1. **CLn** message will turn off and **Hot** will appear in display window (Fig. 42, on page 34).
2. Once the oven has cooled down (about 1 hour) and **Hot** is no longer displayed, the **door Opn** message will appear. When this message turns off the oven door may be opened.

Important note:

Attempting to force open the oven door before the **door Opn** message is gone from the display can ruin the motor door latch.



3. When the oven interior has completely cooled, wipe away any residue or powdered ash with a damp cloth or paper towel.

Important note:

- The kitchen area should be well ventilated. Use an open window, ventilation fan or exhaust hood during the first self clean cycle to help eliminate the normal odors associated the initial clean cycle.
- When the clean time finishes the oven door will remain locked until the oven has cooled sufficiently. In addition to the clean time that was programmed, allow about 1 hour for the oven to cool before opening the oven door. The Self Clean function will not operate when the oven lockout is active.

Setting Delay Start Self Clean

To start a delay Self Clean with default clean time of 3 hours and a start time of 9:00 o'clock:

1. Be sure the clock is set with the correct time of day, the oven is empty and ALL oven racks are removed. Be sure oven door is completely closed.
2. Press **Delay Start**.
3. Using numeric keys enter **9 0 0** for time to start.
4. Press  to accept
5. Press **Self Clean**.
6. Press .

If it becomes necessary to stop Self Clean while active:

1. Press .
2. If Self Clean has heated the oven to a high temperature, allow enough time for the oven to cool and the **door Opn** message to appear (See Fig. 42, on page 34). When this message turns off the oven door may be opened.
3. Before restarting Self Clean, be sure to read important notes below.

Important note:

- When Self Clean is active you may check the amount of clean time remaining by pressing the Self Clean key once.
- If your clock is set with the (default) 12 hr display mode, the Delay Start for a Self Clean can only be programmed to start up to 11 hours and 59 minutes after the time showing in the display (be sure to set the clock to current time before programming a delay start). To set a Delay Start Self Clean to begin 12 or more hours (maximum is 23 hours and 59 minutes) after the time of setting, be sure to first set the control in the 24 Hr display mode.
- If Self Clean was active and then interrupted by a power failure or cancelled before the oven was thoroughly cleaned, it may be necessary to run another Self Clean cycle.
- If the oven temperature was high enough when Self Clean was interrupted the oven control may not allow another Self Clean cycle to be set for up to 4 hours.

Care and Cleaning

Cleaning Various Parts of Your Oven

Before cleaning any part of the oven, be sure all controls are turned off and the oven is cool. Remove spills and any heavy soiling as soon as possible. Regular cleaning will reduce the difficulty of major cleaning later.

Surface Type	Recommendation
Control knob Painted body parts Painted decorative trims Aluminum, plastic, or vinyl trim	Use hot, soapy water and a cloth. For more difficult soils and built-up grease, apply a liquid detergent directly onto the soil. Leave on soil for 30-60 minutes. Rinse with a damp cloth and dry. Do not use abrasive cleaners on any of these materials; they can scratch. To remove control knobs, turn to the OFF position. Grasp firmly and pull straight off the shaft. To replace knobs after cleaning, line up the flat sides of both knob and shaft, then push knob into place.
Control panel Control keypad membrane Decorative trim (some models)	Use a soft cloth and clean with mild dish detergent and water or a 50/50 solution of vinegar and water. Follow by rinsing the area with clean water; dry and polish with a soft cloth. Glass cleaners may be used if sprayed on a soft cloth first. Do not spray liquids directly on the oven control and display area. Do not use large amounts of water on the control panel. Excess water on the control area may cause damage to the appliance. Do not use other liquid cleaners, abrasive cleaners, scouring pads, or paper towels. They will damage the finish.
Stainless steel (some models)	Only use cleaners and polishes that are specifically manufactured for cleaning stainless steel. Always rub in direction of metal grain to avoid damaging. Do not use cleaners with high concentrations of chlorides or chlorine. Do not use harsh scrubbing cleaners. Polish with a lint-free cloth. Always be sure to wipe excess cleaner/polish off from the metal surface as bluish stains may occur during future oven heating that cannot be removed. Clean heavier soils with hot, soapy water and a cloth or sponge. Rinse and dry using clean water and a cloth.
Easy Clean™ Stainless Steel	Your oven finish may be Easy Clean™ Stainless Steel (some models). Clean the stainless with warm soapy water using a clean sponge or cloth. Rinse with clean water and dry with a soft clean cloth. Do not use any store bought cleaners like stainless steel cleaners or any other types of cleaners containing any abrasive, chlorides, chlorine, or ammonia. It is recommended to use mild dish soap and water or a 50/50 solution of water and vinegar.
Porcelain enamel parts Porcelain enamel broiler pan Inserts (available by mail order) Door liner and body parts	Gentle scouring with a soapy scouring pad will remove most spots. Rinse with a 1:1 solution of clear water and ammonia. If necessary, cover difficult spots with an ammonia-soaked paper towel for 30 to 40 minutes. Rinse with clean water and a damp cloth, and then scrub with a soap-filled scouring pad. Rinse and wipe dry with a clean cloth. Remove all cleaners or the porcelain may become damaged during future heating.
Oven interior (porcelain)	Oven racks must be removed from the oven cavity prior to cleaning the oven interior. Clean by using a mild, abrasive cleaner following manufacturer's instructions. Rinse with clean water and dry. For very important cleaning precautions be sure to read all the instructions in the "Self Clean" on page 33 .
Oven racks	Remove oven racks from oven cavity before starting Self Clean. Clean by using a mild, abrasive cleaner following manufacturer's instructions. Rinse with clean water, dry, and then replace in oven.
Oven door	Use soap and water to thoroughly clean the top, sides, and front of the oven door. Rinse well. You may use a glass cleaner on the outside glass of the door. Do not immerse the door in water. Do not spray or allow water or the glass cleaner to enter the door vents. Do not use oven cleaners, cleaning powders, or any harsh abrasive cleaning materials on the outside of the oven door. Do not clean the oven door gasket. On self-clean models, the oven door gasket is made of a woven material which is essential for a good seal. Care should be taken not to rub, damage, or remove this gasket.
Cooktop surface and burners	Do not use spray oven cleaners on the cooktop. See " Cleaning the cooktop and surface burners " instructions on page 36 .

Care and Cleaning

General Cleaning

Refer to the table at the beginning of this chapter for more detailed information about cleaning specific parts of the range.

⚠ CAUTION Before manually cleaning any part of the range, be sure all controls are turned off and the range is cool. The range may be hot and can cause burns.

⚠ CAUTION Ammonia must be rinsed before operating the oven. Provide adequate ventilation.

Aluminum foil and utensils

⚠ WARNING Never cover any slots, holes, or passages in the oven bottom or cover an entire oven rack with materials such as aluminum foil. Doing so blocks air flow through the oven and may cause carbon monoxide poisoning. Aluminum foil linings may trap heat, causing a fire hazard.

⚠ WARNING Protective Liners—Do not use aluminum foil to line the oven bottom. The high heat of the oven can melt these materials to the oven cavity and ruin the oven. These types of materials can also reduce the effectiveness of the air circulation in the oven and produce poor baking results. Only use aluminum foil as recommended in this manual. Improper installation of these liners may result in risk of electric shock or fire.

- Aluminum foil - Use of aluminum foil on a hot cooktop can damage the cooktop. Do not use thin aluminum cooking utensils or allow aluminum foil to touch the surface burners under any circumstances.
- Aluminum utensils - The melting point of aluminum is much lower than that of other metals. Care must be taken when aluminum pots or pans are used on the cooktop. If aluminum pans are allowed to boil dry when using the cooktop, the utensil will be damaged or destroyed.

Cleaning the cooktop and surface burners

⚠ CAUTION To avoid possible burns do not attempt any of the cleaning instructions provided below before turning OFF all of the surface burners and allow them to cool.

⚠ CAUTION Any additions, changes or conversions required in order for this appliance to satisfactorily meet the application needs must be made by an authorized qualified Agency.

Routinely clean the cooktop. Wipe with a clean, damp cloth and wipe dry to avoid scratches. Keeping the surface burner head ports and slots clean will prevent improper ignition and an uneven flame. See the following sections for more instructions.

To clean recessed and contoured areas of cooktop

If a spill occurs on or in the recessed or contoured areas, blot up spill with an absorbent cloth. Rinse with a clean, damp cloth and wipe dry.

To clean burner grates

- Clean when the grates are cool.
- Use nonabrasive plastic scrubbing pad and mild abrasive cleanser.
- Food soils containing acids may affect the finish. Clean immediately after the grates are cool.
- Thoroughly dry grates immediately following cleaning.

To clean burner caps

- Remove caps from burner heads after they have cooled.
- Clean heavy soils with a plastic scrubbing pad and absorbent cloth.
- Thoroughly dry burner caps immediately following cleaning including the bottom and inside of cap.
- Do not use abrasive cleaners. They can scratch porcelain.
- Do not clean burner caps in the dishwasher.
- Do not operate surface burners without burner caps properly in place. See IMPORTANT notes below.

To clean the surface burner heads

For proper gas flow it may be necessary to clean the burner head and slots. To clean, first use a clean DAMP cloth to soak up any spills. Remove any food from between the burner slots using a small nonabrasive brush like a toothbrush and afterwards wipe up using a damp cloth. For stubborn soils located in the slots, use a small-gauge wire or needle to clean.

Any spill on or around the electrode must be carefully cleaned. Take care not to hit the electrode with any thing hard or it could be damaged.

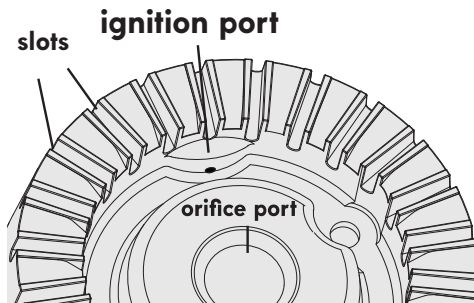

Figure 43: Cooktop burner head

To clean the burner head ignition ports

Each burner head has a small ignition port located as illustrated. Should you experience ignition problems it may be that this port hole is partially blocked with soil. With the burner head in place, use a small wire gauge needle or the end of a paper clip to clear the ignition port (refer to Figure 43; round style shown; oval models on some models not shown).

Important: Always keep the surface burner caps in place whenever a surface burner is in use.

When replacing the burner caps, be sure the burner caps are seated firmly on top of the burner heads.

The surface burner heads are secured to the cooktop and must be cleaned in place on the cooktop. For proper flow of gas and ignition of burners.

DO NOT allow spills, food, cleaning agents or any other material to enter the gas orifice holder opening.

Replacing the Oven Light

CAUTION Be sure the oven is unplugged and all parts are cool before replacing oven light.

The interior oven lights are located at the rear of the oven cavity and are covered with a glass shield held by screws. The glass shield protects the light bulb and must be in place whenever the oven is in use (See Figure 44).

To replace the oven interior light bulb:

CAUTION Be sure the range is unplugged and all parts are cool before replacing the oven light. Do not allow your fingers to touch the new bulb when replacing. This will shorten the life of the bulb. Use a paper towel or cotton glove while handling the new bulb when installing.

1. Turn electrical power off at the main source.
2. Press the wire holder to one side to release the glass shield covering the light bulb.
3. Remove interior oven light shield by turning it counter-clockwise.
4. Replace bulb with a new halogen bulb.
5. Replace glass oven light shield by rotating clockwise.
6. Turn power back on again at the main source.
7. Be sure to reset the time of day on the clock.

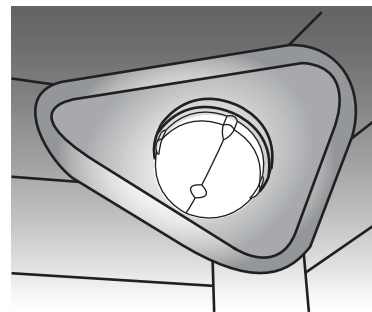

Figure 44: Oven light shown in rear corner of oven cavity

Removing and Replacing the Oven Door

⚠ CAUTION The door is heavy. For safe, temporary storage, lay the door flat with the inside of the door facing down.

To remove the oven door:

1. Open oven door completely, horizontal with floor (See Figure 45).
2. Pull the door hinge locks on both left and right door hinges down from the oven frame completely toward the oven door (See Figure 46). A tool such as a small flat-blade screwdriver may be required.
3. Firmly grasp both sides of oven door along the door sides. Do not use the oven door handle (See Figure 47).
4. Close the door to 10 degrees from the door frame (See Figure 47).
5. Lift the oven door hinge arms over the roller pins located on each side of the oven frame (See Figure 47).

To Replace Oven Door:

1. Firmly grasp both sides of oven door along the door sides. Do not use the oven door handle (See Figure 47).
2. Holding the oven door at the same angle as the removal position (See Figure 47), seat the hook of the hinge arm over the roller pins located on each side of the oven door frame (See Figure 48). The hook of the hinge arms must be fully seated onto the roller pins.
3. Fully open the oven door, horizontal with floor (See Figure 45).
4. Push the door hinge locks up toward and into the oven frame on both left and right oven door hinges to the locked position (See Figure 46).
5. Close the oven door.

Important:

Special Door Care Instructions - Most oven doors contain glass that can break. Do not close the oven door until all the oven racks are fully in place. Do not hit the glass with pots, pans, or any other object. Scratching, hitting, jarring, or stressing the glass may weaken its structure causing an increased risk of breakage at a later time.

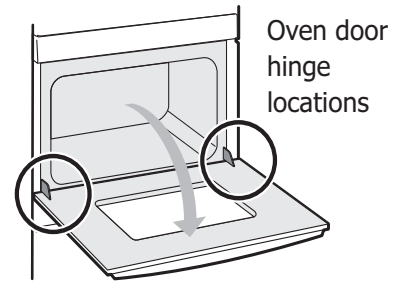

Figure 45: Door hinge location

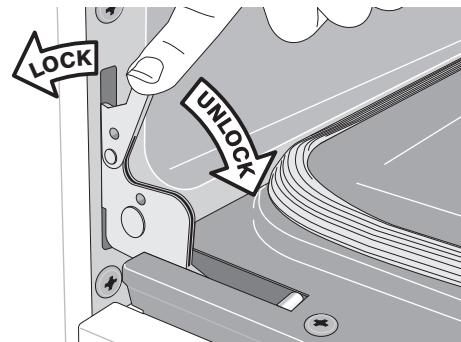

Figure 46: Door hinge locks

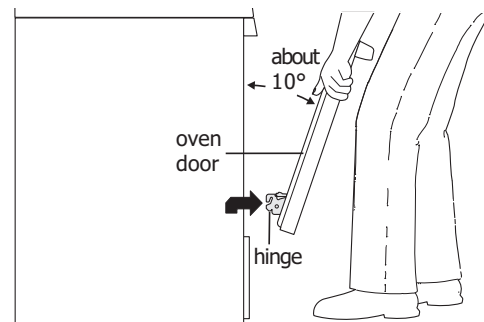

Figure 47: Holding door for removal

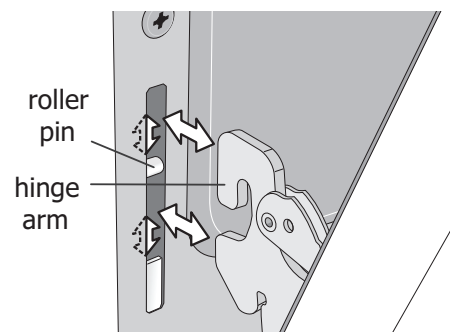

Figure 48: Location of hinge arm and roller pin
Removing and Replacing the Warmer Drawer

To remove the warmer drawer:

⚠ WARNING Electrical shock hazard can occur and result in serious injury or death. Disconnect appliance from electric power before cleaning and servicing the warmer drawer.

1. Turn power OFF to the appliance before removing the warmer drawer.
2. Open the warmer drawer completely.
3. On left warmer drawer rail, locate black release lever and press up with finger while pulling out slightly on the oven drawer handle. On right warmer drawer rail, locate black release lever and press down with finger while pulling out slightly on the warmer drawer handle (See Figure 49).

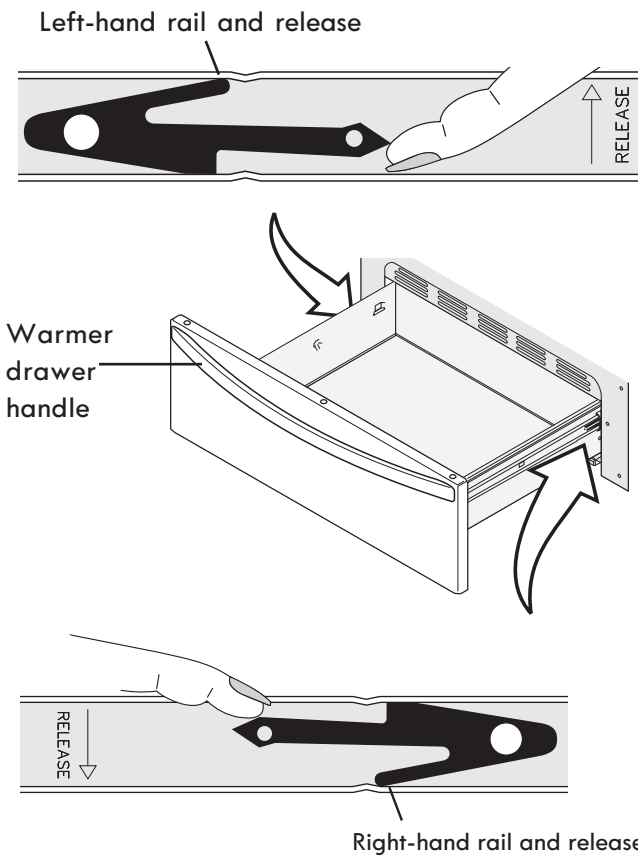

Figure 49: Removing the warmer drawer

4. The warmer drawer should now be released from the rails. Remove warmer oven drawer (using level and square motion) completely out and away from the appliance.

To replace the warmer drawer:

1. Pull the bearing glides to the front of the outer compartment glide channels until they snap into place (See Figure 50).

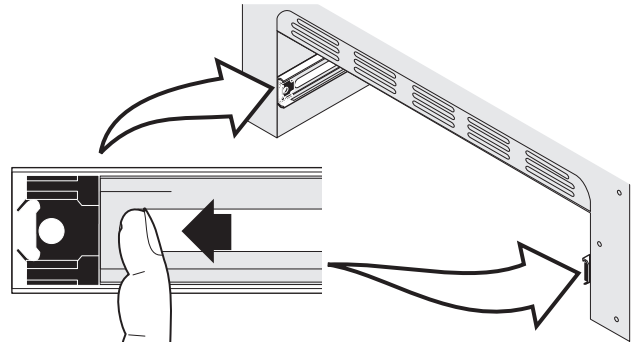

Figure 50: Bearing glide placement

2. Carefully line up both sides of the warmer drawer glide rails to the outer compartment glide channels located inside the empty warmer drawer compartment (See Figure 51).

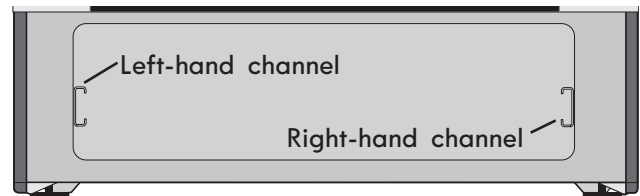

Figure 51: Channel alignment

3. While holding the warmer drawer level and square using the warmer drawer handle, push (do not force) the warmer drawer all the way into the outer compartment glide channels all the way into the range. Open the warmer drawer again to verify the glides have seated.
4. If you do not hear the levers "click" or the bearing glides do not feel seated remove the warmer drawer and repeat Steps 1 through 3 again. This will minimize possible damage to the bearing glides.





Before You Call

Oven Baking

For best cooking results, heat the oven before baking cookies, breads, cakes, pies or pastries, etc. There is no need to preheat the oven for roasting meat or baking casseroles.

The cooking times and temperatures needed to bake a product may vary slightly from your previously owned appliance.

Baking Problems and Solutions

Baking Problems	Causes	Corrections
Cookies and biscuits burn on the bottom. 	<ul style="list-style-type: none"> • Cookies and biscuits put into oven before the preheating time is completed. • Oven rack is overcrowded. • Dark pans absorb heat too fast. 	<ul style="list-style-type: none"> • Allow oven to preheat to desired temperature before placing food in oven. • Choose pan sizes that will permit 2" to 4" of air space (5.1 cm to 10.2 cm) on all sides when placed in the oven. • Use a medium weight baking sheet.
Cakes too dark on top or bottom 	<ul style="list-style-type: none"> • Cakes put in oven before preheating time is completed. • Rack position too high or too low. • Oven too hot. 	<ul style="list-style-type: none"> • Allow oven to preheat to the selected temperature before placing food in the oven. • Use proper rack position for baking needs. • Set oven temperature 25°F/13°C lower than recommended.
Cakes not done in center 	<ul style="list-style-type: none"> • Oven too hot. • Incorrect pan size. • Pan not centered in oven. 	<ul style="list-style-type: none"> • Set oven temperature 25°F/13°C lower than recommended. • Use pan size suggested in recipe. • Use proper rack position and place pan so there is 5.1 cm to 10.2 cm (2" to 4") of space on all sides of pan.
Cakes not level. 	<ul style="list-style-type: none"> • Oven not level. • Pan too close to oven wall or rack overcrowded. • Pan warped. 	<ul style="list-style-type: none"> • Place a marked glass measuring cup filled with water on the center of the oven rack. If the water level is uneven, refer to the installation instructions for leveling the oven. • Be sure to allow 5.1 cm to 10.2 cm (2" to 4") of clearance on all sides of each pan in the oven. • Do not use pans that are dented or warped.
Foods not done when cooking time is over. 	<ul style="list-style-type: none"> • Oven too cool. • Oven overcrowded. • Oven door opened too frequently. 	<ul style="list-style-type: none"> • Set oven temperature 25°F/13°C higher than suggested and bake for the recommended time. • Be sure to remove all pans from the oven except the ones to be used for baking. • Open oven door only after shortest recommended baking time.

Solutions to Common Problems

Before you call for service, review the following list. It may save you time and expense. Possible solutions are provided with the problem listed:

Problem	Solution
Oven control panel beeps and displays any F or E code error.	<ul style="list-style-type: none"> Oven control has detected a fault or error condition. Press STOP to clear the error code. Try bake or broil function. If the F or E code error repeats, turn off power to appliance, wait 5 minutes and then repower appliance. Set clock with correct time of day. Try bake or broil function again. If fault recurs, press STOP to clear.
Poor baking results	<ul style="list-style-type: none"> Many factors effect baking results. Use proper oven rack position. Center food in the oven and space pans to allow air to circulate. Preheat oven to the set temperature before placing food in the oven. Try adjusting the recipe's recommended temperature or baking time. See "Adjusting Oven Temperatures" on page 32 if you feel the oven is too hot or cold.
Appliance is not level	<ul style="list-style-type: none"> Be sure floor is level, strong and stable enough to adequately support range. If floor is sagging or sloping, contact a carpenter to correct the situation. Poor installation. Place oven rack in center of oven and place a level on the oven rack. Adjust leveling legs at base of appliance until the rack is level. Kitchen cabinet alignment may make range appear not level. Be sure cabinets are square and have sufficient room for appliance clearance.
Cannot move appliance easily. Appliance must be accessible for service.	<ul style="list-style-type: none"> Cabinets not square or are built in too tightly. Contact builder or installer to make appliance accessible. Carpet interferes with appliance. Provide sufficient space so appliance can be lifted over carpet.
Oven does not operate.	<ul style="list-style-type: none"> The time of day is not set. The oven clock must first be set in order to operate the oven. Be sure oven controls are set properly. See "Setting The Clock" on page 17 and review instructions for the desired cooking function in this manual. Service wiring is not complete.
Flames inside oven or smoking from oven vent.	<ul style="list-style-type: none"> Excessive spills in oven. Grease or food spilled onto oven bottom or oven cavity. Wipe up excessive spills before starting oven. If flames or excessive smoke are present when using broil, see "Setting Broil" on page 24.
Self clean does not work.	<ul style="list-style-type: none"> Oven control not set properly. Review "Self Clean" on page 33.
Soil not completely removed after self clean.	<ul style="list-style-type: none"> Self Clean was interrupted. Review instructions in "Self Clean" section on page 33. Excessive spills on oven bottom. Clean before starting self clean. Failure to clean soil from the oven frame, the door liner outside the oven door gasket, and the small area at the front center of the oven bottom. These areas are not in the self-cleaning area, but they get hot enough to burn on residue. Clean these areas before starting the self-cleaning cycle. Burned-on residue can be cleaned with a stiff nylon brush and water or a nylon scrubber. Be careful not to damage the oven gasket.
Oven racks discolored or do not slide easily.	<ul style="list-style-type: none"> Oven racks left in oven cavity during self clean. Always remove oven racks from oven cavity before starting a self-clean cycle. Clean using a mild abrasive cleaner following manufacturer's instructions. Rinse with clean water, dry, and replace in oven.

Before You Call

Oven smokes excessively when broiling.	<ul style="list-style-type: none">• Incorrect setting. Follow broiling instructions in “Setting Broil” on page 24. Be sure oven door is closed when broiling.• Meat too close to the broil element. Reposition broil rack to provide proper clearance between the meat and broil element. Remove excess fat from meat. Cut remaining fatty edges to prevent curling.• Grease build up on oven surfaces. Regular cleaning is necessary when broiling frequently. Grease or food splatters will cause excessive smoking.
Oven light does not work.	<ul style="list-style-type: none">• Be sure the oven light is secure in the socket. See “Replacing the Oven Light” on page 37.
Convection fan does not rotate.	<ul style="list-style-type: none">• Oven door is open. Convection fan will turn off if oven door is opened when Convection is active. Close oven door.
Entire appliance does not operate.	<ul style="list-style-type: none">• Make sure power cord is plugged properly into outlet.• Electrical power outage. Check house lights to be sure. Call your local electric company for service outage information.• Service wiring is not complete. Call 1-800-4-MY-HOME® for assistance (See back cover).
Surface burners do not ignite.	<ul style="list-style-type: none">• Surface control knob has not been completely turned to LITE. Push in and turn the surface control knob to LITE until burner ignites and then turn control knob to desired flame size.• Burner ports are clogged. With the burners OFF, use a small-gauge wire or needle to clean ports. See the Care and Cleaning section for complete instructions.• Appliance power cord is disconnected from outlet. Be sure power cord is securely plugged into the electrical outlet.• Electrical power outage.
Surface burner flame uneven or not flaming all the way around the burner cap	<ul style="list-style-type: none">• Burner ports are clogged. With the burner OFF, clean ports by using a small-gauge wire or needle.• Moisture is present after cleaning. Lightly fan the flame and allow burner to operate until flame is full. Dry the burners thoroughly and follow instructions in the Care and Cleaning section.
Surface burner flame is too high	<ul style="list-style-type: none">• Surface control knob is set too high. Adjust to lower flame setting.• Burner caps are not seated properly. Check that all surface burner caps are level and seated correctly on surface burner heads. See “Cleaning the cooktop and surface burners” on page 36 for additional cleaning instructions.• Incorrect L.P. conversion. Refer to L.P. conversion kit instructions to correct.
Surface burner flame is orange.	<ul style="list-style-type: none">• Dust particles in main line. Allow the burner to operate a few minutes until flame turns blue.• In coastal areas, a slightly orange flame is unavoidable due to salt air.
The oven control display shows “SPr” and self-clean is not working.	<ul style="list-style-type: none">• The cooktop should not be used during a self-clean cycle. On some models, turning on any cooktop surface burner will cause the clean cycle to cancel. If the clean cycle is canceled, the oven control display will show “SPr” for 5 seconds. The oven door will remain locked until the oven has cooled down below cleaning temperature. If the oven is below cleaning temperature, the user can start another clean cycle immediately. If the oven is in cleaning temperature range, another self-clean cycle can be set once the door unlocks (up to 4 hours).

Master Protection Agreements

Congratulations on making a smart purchase. Your new Kenmore Elite® product is designed and manufactured for years of dependable operation. But like all products, it may require preventive maintenance or repair from time to time. That's when having a Master Protection Agreement can save you money and aggravation.

The Master Protection Agreement also helps extend the life of your new product. Here's what the Agreement* includes:

- ☑ Parts and labor not just for repairing defects, but to help keep products operating properly under normal use. Our coverage goes well beyond the product warranty. No deductibles, no functional failure excluded from coverage— real protection.
- ☑ Expert service by experienced service technicians trusted in millions of homes every year.
- ☑ Unlimited service calls and nationwide service, as often as you want us, whenever you want us.
- ☑ "No-lemon" guarantee – replacement of your covered product after three separate product failures occur within twelve months and a fourth repair is required. Includes free delivery and installation, if necessary, of replacement product.
- ☑ Product replacement if your covered product can't be fixed.
- ☑ Annual Preventive Maintenance Check at your request – no extra charge.
- ☑ Fast help by phone – phone support from a service agent on all products to help troubleshoot problems. Think of us as a "talking owner's manual."
- ☑ Power surge protection against electrical damage due to power fluctuations.
- ☑ \$300 Food Loss Protection for any food spoilage that is the result of mechanical failure of any covered refrigerator or freezer.
- ☑ Service Promise: \$50 if first attempt repair of your covered product can't be accomplished and product is not usable while awaiting further repair service.
- ☑ 25% discount off the regular price of any non-covered repair service and related installed parts.

Once you purchase the Agreement, a simple phone call is all that it takes for you to schedule service. You can call anytime day or night.

The Master Protection Agreement is a risk free purchase. If you cancel for any reason during the product warranty period, we will provide a full refund. Or, a prorated refund anytime after the product warranty period expires. Purchase your Master Protection Agreement today!

Some limitations and exclusions apply. For prices and additional information call 1-800-827-6655.

Sears Installation Service

For Sears professional installation of home appliances, garage door openers, water heaters, and other major home items, call **1-844-553-6667**.

Acuerdos principales de protección

Enhorabuena por hacer una compra inteligente. Su nuevo producto Kenmore Elite® está diseñado y fabricado para disfrutar de años de funcionamiento confiable. Pero como todos los productos, puede requerir de mantenimiento preventivo o reparación de vez en cuando. Por ello, disponer de un Acuerdo de protección principal puede ahorrarle dinero y molestias.

El Acuerdo de protección principal también ayuda a prolongar la vida útil de su nuevo producto. Esto es lo que incluye el Acuerdo*:

- ☑ No sólo las piezas y la mano de obra para la reparación de defectos, sino también para ayudar a mantener los productos funcionando correctamente en condiciones normales de uso. Nuestra cobertura va mucho más allá de la garantía del producto. Sin deductibles y sin insuficiencia funcional excluida de la cobertura. Protección real.
- ☑ Mantenimiento realizado por técnicos expertos con la confianza de millones de hogares cada año.
- ☑ Servicio de llamadas ilimitado y servicio a nivel nacional, tan a menudo como desee y siempre que quiera.
- ☑ Garantía sin sorpresas: sustitución del producto después de tres fallos independientes dentro de un plazo de doce meses y cuando se requiera una cuarta reparación. Incluye entrega gratuita y, si es necesario, la instalación del producto de reemplazo.
- ☑ Sustitución del producto si el producto cubierto no puede arreglarse.
- ☑ Mantenimiento preventivo anual a petición: sin cargo extra.
- ☑ Ayuda rápida por teléfono: asistencia telefónica de un técnico para ayudarle a resolver los problemas con todos los productos. Piense en nosotros como un manual del propietario "hablado".
- ☑ Protección contra los daños eléctricos por sobretensión debido a las fluctuaciones del suministro.
- ☑ Protección contra la pérdida de alimentos de 300 \$ por cualquier deterioro de los alimentos como resultado de una avería mecánica de cualquier refrigerador o congelador cubierto por la garantía.
- ☑ Promesa de servicio: 50 \$ si el primer intento de reparación de su producto cubierto por la garantía no tiene éxito y el producto no puede utilizarse mientras espera al servicio de reparación.
- ☑ 25% de descuento sobre el precio habitual de cualquier servicio de reparación no cubierto y en las piezas instaladas.

Una vez adquirido el Acuerdo, una simple llamada telefónica es todo lo que necesita para programar el servicio. Puede llamar a cualquier hora del día o de la noche.

El Acuerdo de protección principal es una compra libre de riesgo. Si lo cancela por cualquier motivo durante el período de garantía del producto, le proporcionaremos un reembolso completo. O bien, un reembolso prorrateado en cualquier momento después de la expiración del período de garantía del producto. Compre hoy su Acuerdo de protección principal.

Se aplican algunas limitaciones y exclusiones. Para consultar los precios e información adicional llame al 1-800-827-6655.

Servicio de instalación de Sears

Para ponerse en contacto con el servicio profesional de Sears para la Instalación de electrodomésticos, abridores de puertas de garaje, calentadores de agua y otros importantes objetos para el hogar, llame al 1-844-553-6667.

Kenmore®

Customer Care Hotline

To schedule repair service or order parts

Para pedir servicio o ordenar piezas

1-844-553-6667

www.kenmore.com

For service in Canada Au Canada pour service

1-800-469-4663

www.sears.ca

