

Models/Modelos: 796.6155\*, 796.7155\*

# Kenmore Elite®

## Dryer Secadora

\* = color number, número de color

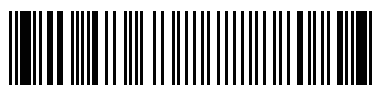

P/N MFL67652511

Sears Brands Management Corporation  
Hoffman Estates, IL 60179 U.S.A.

[www.kenmore.com](http://www.kenmore.com)



## TABLE OF CONTENTS

<b>IMPORTANT SAFETY INSTRUCTIONS</b> .....	3-6
<b>GROUNDING REQUIREMENTS</b> .....	4
<b>FEATURES AND BENEFITS</b>	
Key Parts and Components .....	7
Accessories .....	7
<b>INSTALLATION INSTRUCTIONS</b>	
Key Dimensions and Specifications .....	8
Location Requirements .....	8
Choose the Proper Location .....	8
Clearances .....	8
Gas Dryers .....	9
Gas Requirements .....	9
Electrical Requirements .....	9
Connecting the Gas Supply .....	10
Electric Dryers .....	11
Electrical Requirements .....	11
Connecting Electric Dryers .....	12
Venting the Dryer .....	13-14
Connecting the Inlet Hose .....	15
Leveling the Dryer .....	16
Reversing the Two-Way Door .....	17-22
Final Installation Check .....	23
<b>HOW TO USE</b>	
Control Panel Features .....	24
Time and Status Display .....	25
Operating the Dryer .....	26
Sorting Loads .....	27
Loading the Dryer .....	27
Cycle Guide .....	28-29
Using the Two-Way Door .....	30
Cycle Modifier Buttons .....	32
Cycle Options and Special Features .....	33
Steam Features .....	34
Steam Cycle Guide .....	35
<b>USER MAINTENANCE INSTRUCTIONS</b>	
Regular Cleaning .....	36
Cleaning the Exterior .....	36
Cleaning the Interior .....	36
Cleaning Around and Under the Dryer .....	36
Cleaning the Lint Filter .....	36
Maintaining the Exhaust System .....	37
<b>DIAGNOSTICS</b> .....	38
<b>TROUBLESHOOTING GUIDE</b>	
FAQs .....	39
Before Calling for Service .....	39-42
<b>WARRANTY</b> .....	43
<b>SERVICE</b> .....	Back Cover

## PRODUCT RECORD

In the space below, record the date of purchase, model, and serial number of your product. You will find the model and serial number printed on an identification plate located inside the dryer door. Have these items of information available whenever you contact Sears concerning your product.

Model No. \_\_\_\_\_

Date of Purchase \_\_\_\_\_

Serial No. \_\_\_\_\_

Save these instructions and your sales receipt for future reference.

# READ ALL INSTRUCTIONS BEFORE USE

## Your safety and the safety of others is very important.

We have provided many important safety messages in this manual and on your appliance. Always read and obey all safety messages.



This is the safety alert symbol.

This symbol alerts you to potential hazards that can kill or hurt you and others.

All safety messages will follow the safety alert symbol and either the word DANGER or WARNING. These words mean:



**DANGER:** Indicates a hazardous situation which, if not avoided, will result in death or serious injury.



**WARNING:** Indicates a hazardous situation which, if not avoided, could result in death or serious injury.



**CAUTION:** Indicates a hazardous situation which, if not avoided, could result in minor or moderate injury.

All safety messages will tell you what the potential hazard is, tell you how to reduce the chance of injury, and tell you what can happen if the instructions are not followed.



**WARNING:** For your safety, the information in this manual must be followed to minimize the risk of fire, explosion, or electric shock, or to prevent property damage, personal injury, or loss of life.



## WARNING

### FIRE HAZARD

Failure to follow safety warnings exactly could result in serious injury, death or property damage.

- Do not install a booster fan in the exhaust duct.
- Install all clothes dryers in accordance with the installation instructions of the manufacturer of the dryer.



## WARNING

### FIRE OR EXPLOSION HAZARD

Failure to follow safety warnings exactly could result in serious injury, death or property damage.

- Do not store or use gasoline or other flammable vapors and liquids in the vicinity of this or any other appliance.
- Installation and service must be performed by a qualified installer, service agency or the gas supplier.

### WHAT TO DO IF YOU SMELL GAS:

1. Do not try to light a match or cigarette, or turn on any gas or electrical appliance.
2. Do not touch any electrical switches. Do not use any phones in your building.
3. Clear the room, building, or area of all occupants.
4. Immediately call your gas supplier from a neighbor's phone. Carefully follow the gas supplier's instructions.
5. If you cannot reach your gas supplier, call the fire department.

- Do not install a clothes dryer with flexible plastic venting materials. If a flexible metal (foil type) duct is installed, it must be of a specific type identified by the appliance manufacturer as suitable for use with clothes dryers. Flexible venting materials are known to collapse, be easily crushed, and trap lint. These conditions will obstruct clothes dryer airflow and increase the risk of fire.

**SAVE THESE INSTRUCTIONS**

## IMPORTANT SAFETY INSTRUCTIONS

### BASIC SAFETY PRECAUTIONS

**⚠ WARNING:** To reduce the risk of fire, electric shock, or injury to persons when using this appliance, follow basic precautions, including the following:

- Read all instructions before using the dryer.
- Before use, the dryer must be properly installed, as described in this manual.
- Do not place items exposed to cooking oils in your dryer. Items contaminated with cooking oils may contribute to a chemical reaction that could cause a load to catch fire.
- Do not dry articles that have been previously cleaned in, washed in, soaked in, or spotted with gasoline, dry-cleaning solvents, or other flammable or explosive substances, as they give off vapors that could ignite or explode.
- Do not reach into the dryer if the drum or any other part is moving.
- Do not repair or replace any part of the dryer or attempt any servicing unless specifically recommended in this Use and Care Guide or in published user-repair instructions that you understand and have the skills to carry out.
- Do not tamper with controls.
- Before the dryer is removed from service or discarded, remove the door to the drying compartment.
- Do not allow children to play on or in the dryer. Close supervision of children is necessary when the dryer is used near children.
- Do not use fabric softeners or products to eliminate static unless recommended by the manufacturer of the fabric softener or product.
- Do not use heat to dry articles containing foam rubber or similarly textured rubber-like materials.
- Keep area around the exhaust opening and adjacent surrounding areas free from the accumulation of lint, dust, and dirt.
- The interior of the dryer and exhaust vent should be cleaned periodically by qualified service personnel.
- Do not install or store the dryer where it will be exposed to the weather.
- Always check the inside of the dryer for foreign objects.
- Clean the lint filter before or after each load.
- This product contains chemicals known to the State of California to cause cancer and birth defects or other reproductive harm. **Wash hands after handling.**

### CALIFORNIA SAFE DRINKING WATER AND TOXIC ENFORCEMENT ACT

This act requires the Governor of California to publish a list of substances known to the state to cause cancer, birth defects, or other reproductive harm and requires businesses to warn customers of potential exposure to such substances. Gas appliances can cause minor exposure to four of these substances, namely benzene, carbon monoxide, formaldehyde, and soot, caused primarily by the incomplete combustion of natural gas or LP fuels. Properly adjusted dryers will minimize incomplete combustion. Exposure to these substances can be minimized further by properly venting the dryer to the outdoors.

### GROUNDING REQUIREMENTS

This appliance must be grounded. In the event of malfunction or breakdown, grounding will reduce the risk of electric shock by providing a path of least resistance for electric current. This appliance must be equipped with a cord having an equipment-grounding conductor and a grounding plug. The plug must be plugged into an appropriate outlet that is properly installed and grounded in accordance with all local codes and ordinances.

**⚠ WARNING:** Improper connection of the equipment-grounding conductor can result in a risk of electric shock. Check with a qualified electrician or service person if you are in doubt as to whether the appliance is properly grounded. Do not modify the plug provided with the appliance. If it will not fit the outlet, have a proper outlet installed by a qualified electrician. This appliance must be connected to a grounded metal, permanent wiring system or an equipment grounding conductor must be run with the circuit conductors and connected to the equipment grounding terminal or lead on the appliance. Electrical shock can result if the dryer is not properly grounded.

## SAFETY INSTRUCTIONS FOR INSTALLATION

**⚠ WARNING:** To reduce the risk of fire, electric shock, or injury to persons when using this appliance, follow basic precautions, including the following:

- **Properly ground dryer to conform with all governing codes and ordinances.** Follow details in the installation instructions. Electrical shock can result if the dryer is not properly grounded.
- **Before use, the dryer must be properly installed as described in this manual.** Electrical shock can result if the dryer is not properly grounded.
- **Install and store the dryer where it will not be exposed to temperatures below freezing or exposed to the weather.**
- **All repairs and servicing must be performed by an authorized service technician unless specifically recommended in this Owner's Guide. Use only authorized factory parts.** Failure to follow this warning can cause serious injury, fire, electrical shock, or death.
- **To reduce the risk of electrical shock, do not install the dryer in humid spaces.** Failure to follow this warning can cause serious injury, fire, electrical shock, or death.
- **Connect to a properly rated, protected, and sized power circuit to avoid electrical overload.** Improper power circuits can melt, creating risk of electrical shock and/or fire hazard.
- **Remove all packing items and dispose of all shipping materials properly.** Failure to do so can result in death, fire, explosion, burns, or death.
- **Place dryer at least 18 inches above the floor for a garage installation.** Failure to do so can result in fire, explosion, burns, or death.
- **Keep all packaging from children.** Packaging material can be dangerous for children. There is a risk of suffocation.
- **Do not install near items that produce heat or open flame** such as stoves or cooking ovens. Failure to follow this warning can cause product deformation, smoke and fire.
- **Do not place candles or cigarettes on top of the product.** Failure to follow this warning can cause product deformation, smoke and fire.
- **Remove all protective vinyl film from the product.** Failure to do so can cause product deformation, smoke and fire.

## Exhaust/Ducting:

- **Gas dryers MUST be exhausted to the outside.** Failure to follow these instructions can result in fire or death.
- **The dryer exhaust system must be exhausted to the outside of the dwelling. If the dryer is not exhausted outdoors, some fine lint and large amounts of moisture will be expelled into the laundry area.** An accumulation of lint in any area of the home can create a health and fire hazard.
- **Use only rigid metal or flexible metal 4 inch diameter duct inside the dryer cabinet or for exhausting to the outside. Use of plastic or other combustible ductwork can cause a fire. Punctured ductwork can cause a fire if it collapses or becomes otherwise restricted in use or during installation.**
- **Ductwork is not provided with the dryer, and you should obtain the necessary ductwork locally. The end cap should have hinged dampers to prevent backdraft when the dryer is not in use.** Failure to follow these instructions can result in fire or death.
- **The exhaust duct must be 4 inches (10.2 cm) in diameter with no obstructions. The exhaust duct should be kept as short as possible. Make sure to clean any old ducts before installing your new dryer.** Failure to follow these instructions can result in fire or death.
- **Rigid or semi rigid metal ducting is recommended for use between the dryer and the wall. In special installations when it is impossible to make a connection with the above recommendations, a UL listed flexible metal transition duct may be used between the dryer and wall connection only. The use of this ducting will affect drying time.** Failure to follow these instructions can result in fire or death.
- **DO NOT use sheet metal screws or other fasteners which extend into the duct that could catch lint and reduce the efficiency of the exhaust system.** Secure all joints with duct tape. For complete details, follow the Installation Instructions. Failure to follow these instructions can result in fire or death.

### SAFETY INSTRUCTIONS FOR STEAM FUNCTIONS

**⚠ WARNING:** To reduce the risk of fire, electric shock, or injury to persons when using this appliance, follow basic precautions, including the following:

- Do not open the dryer door during steam cycles. Failure to follow these instructions can result in a burn hazard.
- Do not dry articles that have been previously cleaned in, washed in, soaked in, or spotted with gasoline, dry-cleaning solvents, or other flammable or explosive substances as they give off vapors that could ignite or explode. Failure to follow these instructions can result in fire or death.
- Do not fill the steam feeder with gasoline, dry-cleaning solvents, or other flammable or explosive substances. Failure to follow these instructions can result in fire or death.
- Do not touch the steam nozzle in the drum during or after the steam cycle. Failure to follow these instructions can result in a burn hazard.
- Do not fill the steam feeder with hot water (over 86°F/30°C). Failure to follow these instructions can result in a burn hazard.

### SAFETY INSTRUCTIONS FOR CONNECTING ELECTRICITY

**⚠ WARNING:** To reduce the risk of fire, electric shock, or injury to persons when using this appliance, follow basic precautions, including the following:

- Do not, under any circumstances, cut or remove the ground prong from the power cord. To prevent personal injury or damage to the dryer, the electrical power cord must be plugged in to a properly grounded outlet.
- For personal safety, this dryer must be properly grounded. Failure to do so can result in electrical shock or injury.
- Refer to the installation instructions in this manual for specific electrical requirements for your model. Failure to follow these instructions can create an electrical shock hazard and/or a fire hazard.
- This dryer must be plugged in to a properly grounded outlet. Electrical shock can result if the dryer is not properly grounded. Have the wall outlet and circuit checked by a qualified electrician to make sure the outlet is properly grounded. Failure to follow these instructions can create an electrical shock hazard and/or a fire hazard.
- The dryer should always be plugged in to its own individual electrical outlet which has a voltage rating that matches the rating plate. This provides the best performance and also prevents overloading house wiring circuits which could cause a fire hazard from overheated wires.
- Never unplug your dryer by pulling on the power cord. Always grip the plug firmly and pull straight out from the outlet. The power cord can be damaged, resulting in a risk of fire and electrical shock.
- Repair or replace immediately all power cords that have become frayed or otherwise damaged. Do not use a cord that shows cracks or abrasion damage along its length or at either end. The power cord can melt, creating electrical shock and/or fire hazard.
- When installing or moving the dryer, be careful not to pinch, crush, or damage the power cord. This will prevent injury and prevent damage to the dryer from fire and electrical shock.

## FEATURES AND BENEFITS

### KEY PARTS AND COMPONENTS

There are several important components that are referenced in this manual.

- A EASY-TO-USE CONTROL PANEL**  
Rotate the cycle selector knob to select the desired dry cycle. Add cycle options or adjust settings with the touch of a button.
- B TIME AND STATUS DISPLAY**  
The easy-to-read LED display shows cycle status and estimated time remaining.
- C CYCLE MODIFIERS**  
Adjust the cycle defaults such as temperature and dry level with the touch of a button.  
**NOTE:** Not all settings are available for all cycles.
- D CHECK VENT**  
(Duct Blockage Sensing System)  
The CHECK VENT (Duct blockage sensing system) detects and alerts you to blockages in the exhaust system that reduce airflow from the dryer. Maintaining clean exhaust system ducts improves operating efficiency and helps minimize service calls, saving you money.
- E LARGE CAPACITY STEEL DRUM WITH DRUM LIGHT**  
The ultra-large stainless steel drum offers superior durability. The drum light can be turned on during a cycle by using the DRUM LIGHT button on the control panel. The light also comes on when the door is opened, if the control is ON.
- F EASY-ACCESS REVERSIBLE DOOR**  
The wide-opening, see-through glass door provides easy access for loading and unloading. Door swing can be reversed to adjust for installation location.
- G FRONT-MOUNT LINT FILTER**  
The front-mount lint filter allows for easy access and cleaning between loads.
- H LEVELING FEET**  
Four leveling feet (two in front, and two in back) adjust to improve dryer stability on uneven floors.

Front of Dryer

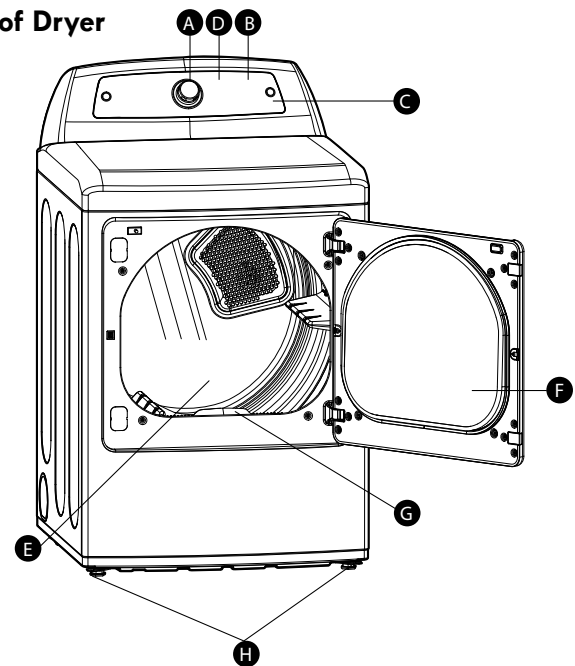

Rear of Dryer

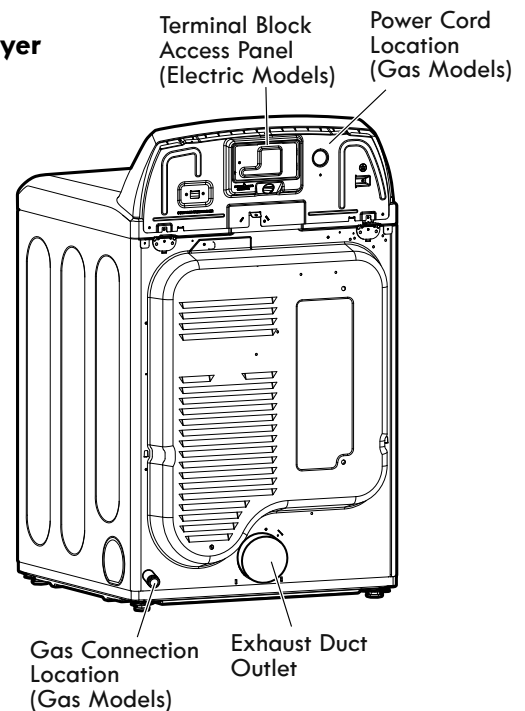

### ACCESSORIES

#### Included Accessories



safety tether kit  
(on some models)

#### Required Accessories



Y connector  
(sold separately)  
(steam models)



short hose  
(sold separately)  
(steam models)



long hose  
(sold separately)  
(steam models)

#### Optional Accessories



drying rack  
(sold separately)  
No. 3750EL0001C

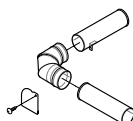

side vent kit  
(sold separately)  
Kit No. D26-49670

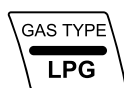

LP conversion kit  
No. 383EEL3002D

#### Safety Tether Kit

This optional kit helps prevent the dryer tipping if children climb on the door or if someone should fall onto the door. It is recommended that you install this kit, depending on your situation, but it is not required. Follow the customer installation instructions included with the kit to properly install the kit. If you do not install the kit, store it out of reach of children.

#### Two-Way Reversible Door (on some models)

Open the dryer door from the top, hamper-style, when loading the dryer to help guide clothes into the drum and prevent them from falling onto the floor. When unloading the dryer or loading bulkier items, use the swing door for easy access to the drum.

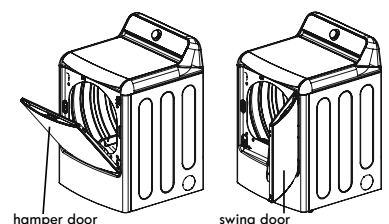

# INSTALLATION INSTRUCTIONS

## KEY DIMENSIONS AND SPECIFICATIONS

Description Dryer	Dryer (Gas and Electric)
Electrical Requirements	Refer to the rating label
Gas Requirements* NG:	4–10.5 inches WC
Gas Requirements* LP:	8–13 inches WC
Dimensions	27 in. (W) X 28.9 in. (D) X 45 in. (H), 50 ¼ in. (D with door open) 68.6 cm (W) X 73.4 cm (D) X 114.1 cm (H), 127.5 cm (D with door open)
Net Weight	Electric : 127.9 lb. (58 kg) Gas : 130.5 lb. (59.2 kg)
Drying Capacity	IEC 7.3 cu. ft.

\*Gas Models Only

## LOCATION REQUIREMENTS

**IMPORTANT:** Read all installation instructions completely before installing and operating your dryer. It is important that you review this entire manual before installing and using your dryer. It contains detailed instructions concerning electrical connections, gas connections and exhaust requirements.

### CHOOSE THE PROPER LOCATION

- Store and install the dryer where it will not be exposed to temperatures below freezing or exposed to outdoor weather conditions.
- Choose a location with a solid, level floor.
- If the dryer is being installed in a garage, place the dryer at least 18 inches (45.7cm) above the floor.
- Properly ground the dryer to conform with all governing codes and ordinances.
- To reduce the risk of electric shock, do not install the dryer in damp or wet locations.

**NOTE:** Installing the dryer in a humid space, or installing or storing the dryer where it will be exposed to the weather or freezing temperatures, may result in rust or other damage that is not covered by the product warranty.

**IMPORTANT:** If you are installing the dryer in a manufactured or mobile home, refer to the **Special Electrical Requirements for Mobile or Manufactured Homes** section.

### CLEARANCES

- Most installations require a minimum 5 ½ inch (14 cm) clearance behind the dryer for the exhaust ducting.
- Allow minimum clearances of at least 1 inch (2.5 cm) on the sides and back to minimize vibration and noise.
- Allowing additional clearance for installation and servicing is recommended.
- Be sure to allow for wall, door, or floor moldings that may increase the required clearances.
- Allow at least 21 inches (53.3 cm) in front of the dryer to open the door.

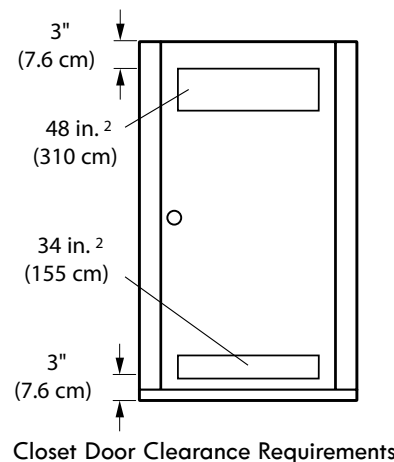
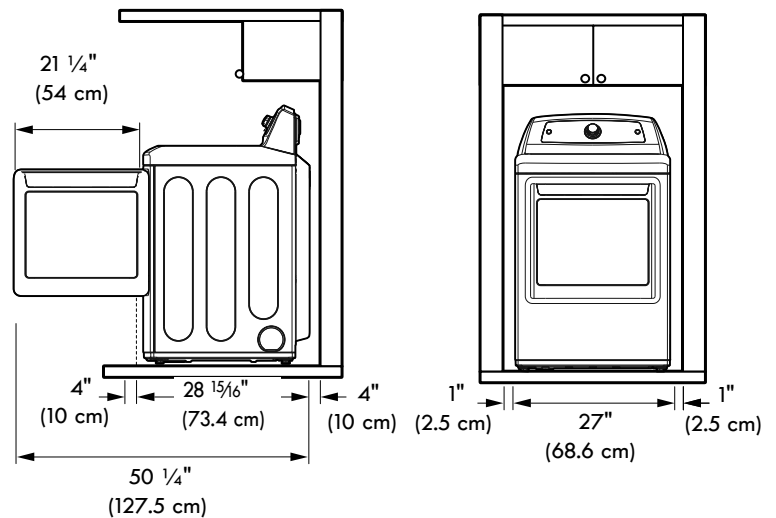

Closet Door Clearance Requirements

### Additional Instructions for Closet Installations

The closet door must allow for sufficient airflow. Refer to the diagram above for minimum vent opening requirements. A louvered door is also acceptable.



**GAS DRYERS**

**GAS REQUIREMENTS (GAS MODELS ONLY)**

**⚠ WARNING:** To reduce the risk of fire, electric shock, or injury to persons when using this appliance, follow basic precautions, including the following:

- **Gas supply requirements:** As shipped from the factory, this dryer is configured for use with natural gas (NG). It can be converted for use with propane (LP) gas. Gas pressure must not exceed 8 inches water column for (NG), or 13 inches water column for (LP).
- **A qualified service or gas company technician must connect the dryer to the gas service.** Failure to follow these instructions can result in fire, explosion, or death.
- **Isolate the dryer from the gas supply system by closing its individual manual shutoff valve during any pressure testing of the gas supply.** Failure to do so can result in fire, explosion, or death.
- **Supply line requirements:** Your laundry room must have a rigid gas supply line to your dryer. In the United States, an individual manual shutoff valve **MUST** be installed within at least 6 ft. (1.8 m) of the dryer, in accordance with the National Fuel Gas Code ANSI Z223.1 or Canadian gas installation code CSA B149.1. A 1/8 inch NPT pipe plug must be installed. Failure to do so can result in fire, explosion, or death.
- **If using a rigid pipe, the rigid pipe should be 1/2 inch IPS.** If acceptable under local codes and ordinances and when acceptable to your gas supplier, 3/8 inch approved tubing may be used where lengths are less than 20 ft. (6.1 m). Larger tubing should be used for lengths in excess of 20 ft. (6.1 m). Failure to do so can result in fire, explosion, or death.
- **Connect the dryer to the type of gas shown on the nameplate.** Failure to do so can result in fire, explosion, or death.
- **To prevent contamination of the gas valve, purge the gas supply of air and sediment before connecting the gas supply to the dryer. Before tightening the connection between the gas supply and the dryer, purge remaining air until the odor of gas is detected.** Failure to do so can result in fire, explosion, or death.
- **DO NOT use an open flame to inspect for gas leaks. Use a noncorrosive leak detection fluid.** Failure to do so can result in fire, explosion, or death.
- **Use only a new AGA- or CSA-certified gas supply line with flexible stainless steel connectors.** Failure to do so can result in fire, explosion, or death.
- **Securely tighten all gas connections.** Failure to do so can result in fire, explosion, or death.
- **Use Teflon tape or a pipe-joint compound that is insoluble in propane (LP) gas on all pipe threads.** Failure to do so can result in fire, explosion, or death.
- **DO NOT attempt any disassembly of the dryer; disassembly requires the attention and tools of an authorized and qualified service technician or company.** Failure to follow this warning can result in fire, explosion, or death.

**ELECTRICAL REQUIREMENTS FOR GAS MODELS ONLY**

**⚠ WARNING:** ELECTRIC SHOCK HAZARD

Failure to follow safety warnings could result in serious injury or death.

- **The power cord of this dryer is equipped with a 3-prong (grounding) plug for protection against shock hazard and should be plugged directly into a properly grounded 3-prong receptacle.** Failure to follow this warning can result in fire, explosion, or death.
- **Do not, under any circumstances, cut or remove the third (ground) prong from the power cord.** Failure to follow this warning can result in fire, explosion, or death.
- **For personal safety, this dryer must be properly grounded.** Failure to follow this warning can result in fire, explosion, or death.
- **This dryer must be plugged into a 120-VAC, 60-Hz. grounded outlet protected by a 15-ampere fuse or circuit breaker.** Failure to follow this warning can result in fire, explosion, or death.
- **Where a standard 2-prong wall outlet is encountered, it is your personal responsibility and obligation to have it replaced with a properly grounded 3-prong wall outlet.** Failure to follow this warning can result in fire, explosion, or death.

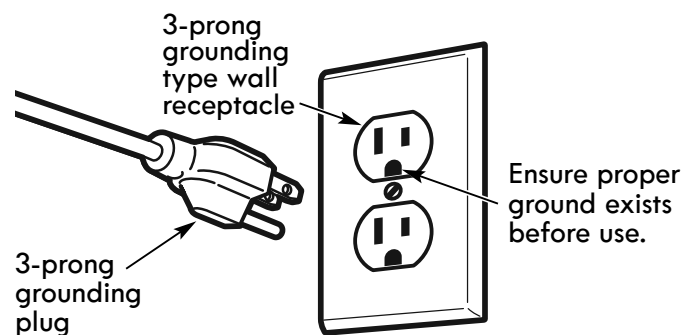

## INSTALLATION INSTRUCTIONS

### GAS DRYERS (continued)

**⚠ WARNING:** To reduce the risk of fire, electric shock, or injury to persons when using this appliance, follow basic precautions, including the following:

- **Installation and service must be performed by a qualified installer, service agency, or the gas supplier.** Failure to do so can result in fire, explosion, or death.
- **Use only a new stainless steel flexible connector and a new AGA-certified connector.** Failure to do so can result in fire, explosion, or death.
- **A gas shutoff valve must be installed within 6 ft. (1.8 m) of the dryer.** Failure to do so can result in fire, explosion, or death.
- **The dryer is configured for natural gas when shipped from the factory. Make sure that the dryer is equipped with the correct burner nozzle for the type of gas being used (natural gas or propane gas).** Failure to do so can result in fire, explosion, or death.

### CONNECTING THE GAS SUPPLY

**NOTE:** This dryer is configured from the factory set for natural gas (NG). If the dryer is to be used with propane (LP) gas, it must be converted by a qualified service technician.

- 1 Make sure that the gas supply to the laundry room is turned OFF and the dryer is unplugged. Confirm that the type of gas available in the laundry room is appropriate for the dryer.
- 2 Remove the shipping cap from the gas fitting at the back of the dryer. Be careful not to damage the threads of the gas connector when removing the shipping cap.
- 3 Connect the dryer to the laundry room's gas supply using a new flexible stainless steel connector with a  $\frac{3}{8}$  inches NPT fitting.  
**NOTE:** DO NOT use old connectors.
- 4 Securely tighten all connections between the dryer and the laundry room's gas supply.
- 5 Turn on the laundry room's gas supply.
- 6 Check all pipe connections (both internal and external) for gas leaks with a noncorrosive leak-detection fluid.
- 7 Proceed to Venting the Dryer (refer to pages 13-14).

- **If necessary, the correct nozzle (for the LP nozzle kit, order part number 383EEL3002D) should be installed by a qualified technician and the change should be noted on the dryer.** Failure to do so can result in fire, explosion, or death.
- **All connections must be in accordance with local codes and regulations.** Failure to do so can result in fire, explosion, or death.
- **Gas dryers MUST exhaust to the outdoors.** Failure to do so can result in fire, explosion, or death.

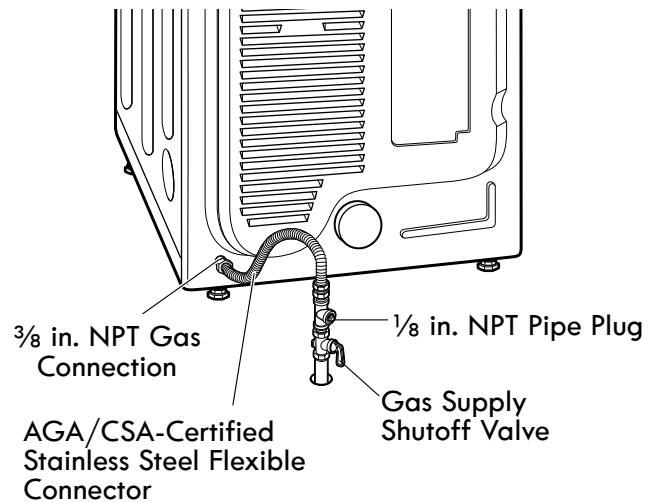

### High-Altitude Installations

The BTU rating of this dryer is AGA-certified for elevations below 10,000 feet.

If your gas dryer is being installed at an elevation above 10,000 feet, it must be derated by a qualified technician or gas supplier.

**ELECTRIC DRYERS****ELECTRICAL REQUIREMENTS**

**⚠ WARNING:** To help prevent fire, electrical shock, serious injury, or death, the wiring and grounding must conform to the latest edition of the National Electrical Code, ANSI/NFPA 70 and all applicable local regulations. Contact a qualified electrician to check the home's wiring and fuses to ensure that the home has adequate electrical power to operate the dryer.

**Special Electrical Requirements for Mobile or Manufactured Homes**

**⚠ WARNING:** To reduce the risk of fire, electric shock, or injury to persons when using this appliance, follow basic precautions, including the following:

- Any installation in a manufactured or mobile home must comply with the **Manufactured Home Construction and Safety Standards Title 24 CFR, Part 32-80 or Standard CAN/CSA0Z240 MH** and local codes and ordinances.
- A 4-wire connection is required for all mobile and manufactured home installations, as well as all new construction after January 1, 1996. Failure to follow this requirement can result in fire, explosion, or death.

**Electrical Requirements for Electric Models Only**

**⚠ WARNING:** To reduce the risk of fire, electric shock, or injury to persons when using this appliance, follow basic precautions, including the following:

- This dryer must be connected to a grounded metal, permanent wiring system, or an equipment grounding conductor must be run with the circuit conductors and connected to the equipment grounding terminal or lead on the dryer. Failure to do so can result in fire, explosion, or death.
- The dryer has its own terminal block that must be connected to a separate 240 VAC, 60-Hertz, single phase circuit, fused at 30 amperes (the circuit must be fused on both sides of the line). **ELECTRICAL SERVICE FOR THE DRYER SHOULD BE OF THE MAXIMUM RATE VOLTAGE LISTED ON THE NAMEPLATE. DO NOT CONNECT THE DRYER TO A 110-, 115-, OR 120-VOLT CIRCUIT.** Failure to follow these instructions can result in fire, explosion, or death.
- If the branch circuit to the dryer is 15 ft. (4.5 m) or less in length, use UL (Underwriters Laboratories) listed No.-10 AWG wire (copper wire only), or as required by local codes. If over 15 ft. (4.50 m), use UL-listed No.-8 AWG wire (copper wire only), or as required by local codes. Allow sufficient slack in the wiring so the dryer can be moved from its normal location when necessary. Failure to do so can result in fire, explosion, or death.
- The power cord (pigtail) connection between the wall receptacle and the dryer terminal block **IS NOT** supplied with the dryer. The type of pigtail and gauge of wire must conform to local codes and with instructions on the following pages. Failure to follow these instructions can result in fire, explosion, or death.
- A 4-wire connection is required for all new construction after January 1, 1996. A 4-wire connection must be used where local codes do not permit grounding through the neutral wire. Failure to do so can result in fire, explosion, or death.

## INSTALLATION INSTRUCTIONS

### ELECTRIC DRYERS (continued)

#### CONNECTING ELECTRIC DRYERS

### ⚠ WARNING:

Connect the power cord to the terminal block. Each colored wire should be connected to the same color screw. Wire color indicated on manual is connected to the same color screw in block. Failure to follow these instructions may result in a short or overload.

#### Four-Wire Power Cord

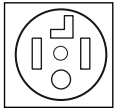

- A 4-wire connection is required for all mobile and manufactured home installations, as well as all new construction after January 1, 1996.

- A UL-listed strain relief is required.
- Use a **30-amp, 240-volt, 4-wire, UL-listed power cord with #10 AWG-minimum copper conductor** and closed loop or forked terminals with upturned ends.

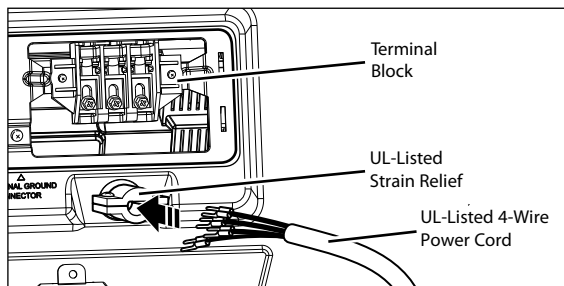

- 1 Remove the terminal block access cover on the upper back of the dryer.
- 2 Install a UL-listed strain relief into the power cord through-hole.
- 3 Thread a 30-amp, 240-volt, 4-wire, UL-listed power cord with #10 AWG-minimum copper conductor through the strain relief.

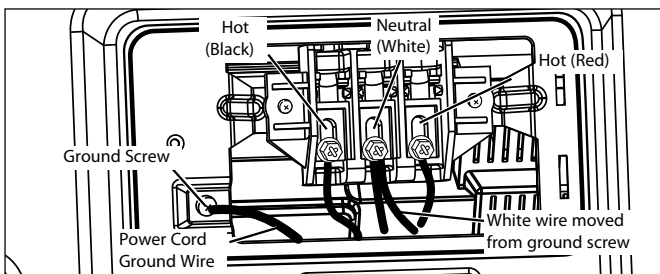

- 4 Transfer the dryer's ground wire from behind the green ground screw to the center screw of the terminal block.
- 5 Attach the two hot leads of the power cord to the outer terminal block screws.
- 6 Attach the white neutral wire to the center screw of the terminal block.
- 7 Attach the power cord ground wire to the green ground screw.
- 8 **TIGHTEN ALL SCREWS SECURELY.**
- 9 Reinstall the terminal block access cover.

Grounding through the neutral conductor is prohibited for: (1) new branch-circuit installations, (2) mobile homes, (3) recreational vehicles, and (4) areas where local codes prohibit grounding through the neutral conductor.

#### Three-Wire Power Cord

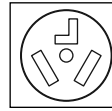

- A 3-wire connection is **NOT** permitted on new construction after January 1, 1996.
- A UL-listed strain relief is required.

- Use a **30-amp, 240-volt, 3-wire, UL-listed power cord with #10 AWG-minimum copper conductor** and closed loop or forked terminals with upturned ends.

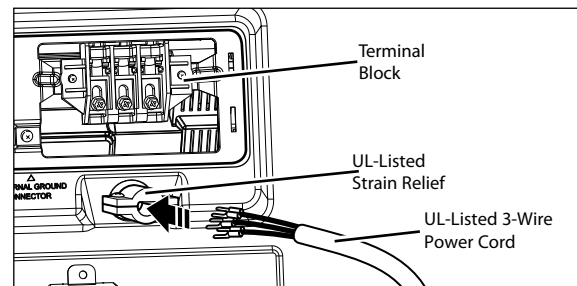

- 1 Remove the terminal block access cover on the upper back of the dryer.
- 2 Install a UL-listed strain relief into the power cord through-hole.
- 3 Thread a 30-amp, 240-volt, 3-wire, UL-listed power cord with #10 AWG-minimum copper conductor through the strain relief.

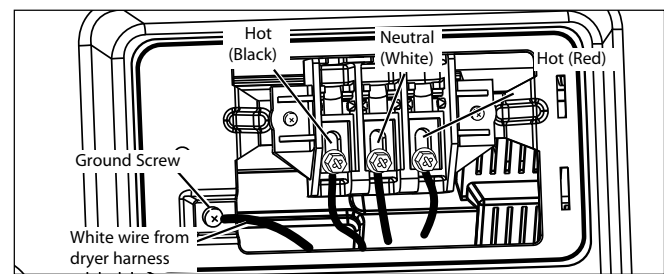

- 4 Attach the two hot leads (black and red) of the power cord to the outer terminal block screws.
- 5 Attach the neutral (white) wire to the center terminal block screw.
- 6 Connect the external ground (if required by local codes) to the green ground screw.
- 7 **TIGHTEN ALL SCREWS SECURELY.**
- 8 Reinstall the terminal block access cover.

**VENTING THE DRYER**

**IMPORTANT! CHECK THE EXHAUST SYSTEM FOR PROBLEMS**

The most common cause of dryer problems is poor exhaust venting. Before installing the new dryer, check the items listed below to make sure to get the best possible performance. This can save time and money by reducing cycle times and increasing energy efficiency.

- **DIRTY OR DAMAGED EXHAUST DUCTS.** Lint builds up in exhaust ducts over time. This decreases the airflow and makes the dryer work harder. Visually inspect the ducts from both ends and have them cleaned if they have not been cleaned recently.
- **WRONG VENT MATERIAL.** Check the vent to make sure it is rigid or semi-rigid metal ducting. If the venting is plastic or flexible foil, have it replaced before using the dryer.
- **RESTRICTED OR DAMAGED VENT HOOD.** Check the vent hood outside. It must be clean and free of lint buildup. Check the damper and make sure it opens fully and easily.
- **EXCESSIVELY LONG VENT.** Measure the length of the exhaust system and count the elbows. Use the chart below to see if the duct is too long. If it is too long, have the duct routed to another location that is within the venting guidelines.
- **DO NOT USE PLASTIC OR FOIL VENTING.** The transition duct from the dryer to the wall must be rigid or semi-rigid metal ducting. If the old transition duct is plastic or foil, REPLACE IT with semi-rigid metal ducting.

**Using the DUCT LENGTH CHART (below)**

- 1 Find the existing vent hood type in the chart below.
- 2 Select the row that matches the number of elbows in the dryer duct run.
- 3 Look to the right of the elbow number for the maximum duct length for the installation. Longer duct length will result in reduced drying performance, longer dry times and increased energy consumption. Extremely long ducts can even shorten the life of the dryer.

DO NOT exceed the maximum length for the vent hood type and number of elbows used.

**DUCT LENGTH CHART**

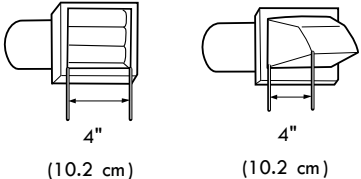
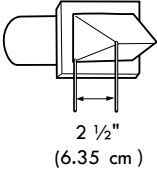
Vent Hood Type	Number of 90° Elbows	Maximum length of 4" (10.2 cm ) diameter rigid metal duct
<p>Recommended</p> 	0	65 feet (19.8 m)
	1	55 feet (16.8 m)
	2	47 feet (13.7 m)
	3	36 feet (11.0 m)
	4	28 feet (8.5 m)
<p>Only for Short-Run Installations</p> 	0	55 feet (16.8 m)
	1	47 feet (13.7 m)
	2	41 feet (12.5 m)
	3	30 feet (9.1 m)
	4	22 feet (6.7 m)

**NOTE:** Deduct 6 ft. (1.8 m) for each additional elbow. Using more than four 90° elbows is not recommended.

## INSTALLATION INSTRUCTIONS

### VENTING THE DRYER (continued)

#### Routing and Connecting Ductwork

Follow the guidelines below to maximize dryer performance and reduce lint buildup and condensation in the ductwork.

**NOTE:** Transition duct and fittings are NOT included and **must** be purchased separately.

- Use 4 inch (102mm) diameter rigid or semi-rigid metal duct.
- The exhaust duct run should be as short as possible.
- Use as few elbow joints as possible.
- The male end of each section of exhaust duct **must** point away from the dryer.
- Use duct tape on all joints. Never use screws.
- Insulate ducts that run through unheated areas in order to reduce condensation and lint buildup on duct surfaces.
- The total length of semi-rigid metal transition duct should not exceed 8 ft. (2.4 m).

**⚠ WARNING:** Failure to follow these guidelines will result in poor performance, product failure, and/or result in fire or death.

**IMPORTANT:** Failure to exhaust the dryer, per the guidelines included within these instructions, may result in unsatisfactory dryer performance. All venting and ductwork beyond the exterior of the dryer is the responsibility of the consumer. Product failure, as a result of improper venting, is not covered by the manufacturer's warranty.

#### Connecting the Dryer Vent

- 1 Verify all ducts and elbows are clean and free from any blockages.
- 2 Measure duct length. **DO NOT** exceed the maximum length listed in the Duct Length Chart.
- 3 Connect dryer exhaust to existing duct.
  - Only use duct tape or clamps.
  - **DO NOT** use screws to secure ductwork.
  - Use rigid or semi-rigid metal ducts.
  - **DO NOT** use plastic or thin metal foil tubing for ductwork.
  - The male end of each elbow must always point in the direction of the airflow.

**NOTE:** Be careful when moving the dryer into its final location. Do **NOT** crush the duct. Make sure the connections do not come loose.

Correct Venting

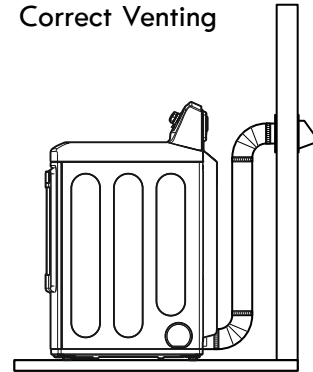

Incorrect Venting

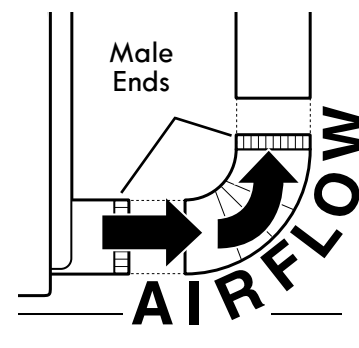
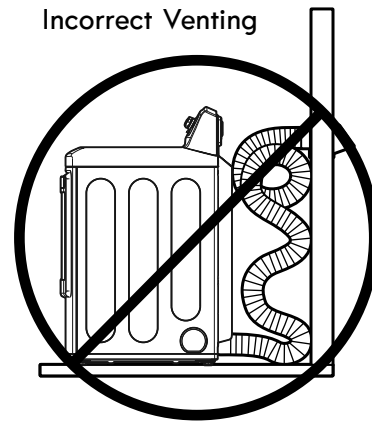

## CONNECTING THE INLET HOSE

The dryer must be connected to the cold water tap using the new water supply hose. Do not use old hoses.

### NOTE:

- Water supply pressure must be between 20 psi and 120 psi (138–827 kPa).
- Do not strip or cross-thread when connecting inlet hose to the valve.
- If the water supply pressure is more than 120 psi (827 kPa), a pressure reducing valve should be installed.
- Periodically check the condition of the hose and replace the hose if necessary.
- Replace inlet hoses after 5 years of use to reduce the risk of hose failure.
- Record hose installation or replacement dates on the hoses for future reference.

- 1 Check the rubber seal at each end of the inlet hoses. Two rubber seals are supplied with each inlet hose. They are used for preventing water leaks. Make sure the connection to the cold water tap is tight.

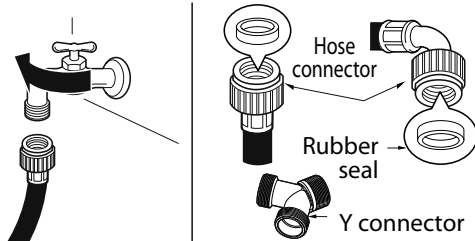

- 2 Check the installation type.

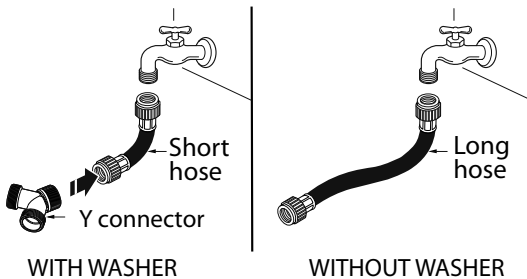

**Connect all water supply hoses tightly by hand and then tighten another 2/3 turn with pliers.**

**WITH WASHER:** When connecting the dryer to the same faucet as a washer.

- a. Shut off the cold water tap and remove the washer hose.
- b. Connect the short hose to the Y-connector.
- c. Connect the other end of the short hose to the cold water faucet.
- d. Connect the long dryer hose to one side of the Y-connector and connect the washer hose to the other side.

**WITHOUT WASHER:** If the dryer does not share the cold water tap with a washer.

- a. Connect the straight end of the long hose to the cold water faucet.

### NOTE:

- Before connecting the water line to the dryer, flush several gallons of water into a drain or bucket. This will help prevent foreign particles such as sand and scale from clogging the dryer inlet valve.
  - Do not overtighten. Damage to the coupling can result.
- 3 Connect the hose to the dryer.
    - Connect the water supply hose to the dryer inlet valve tightly by hand and then tighten another 2/3 turn with pliers. Make sure that there are no kinks in the hoses and that they are not crushed.

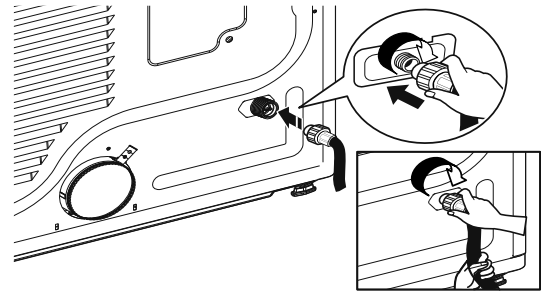

- 4 Turn on the cold water faucet.

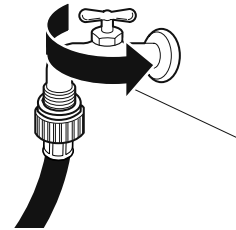

- 5 Check for leaks at the Y-connector (if used) and all hoses.

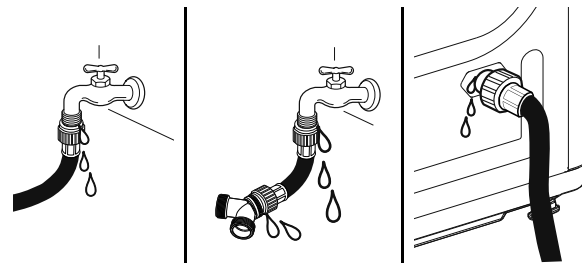

### NOTE:

- If any leaks are found, shut off the water faucet, remove the hose and check the condition of the hose washer.

## INSTALLATION INSTRUCTIONS

### LEVELING THE DRYER

#### **⚠ WARNING:**

- Wear gloves during installation.
- Failure to follow these instructions can result in injury.

To ensure that the dryer provides optimal drying performance, it must be level. To minimize vibration, noise, and unwanted movement, the floor must be a level, solid surface.

**NOTE:** Adjust the leveling feet only as far as necessary to level the dryer. Extending the leveling feet more than necessary can cause the dryer to vibrate.

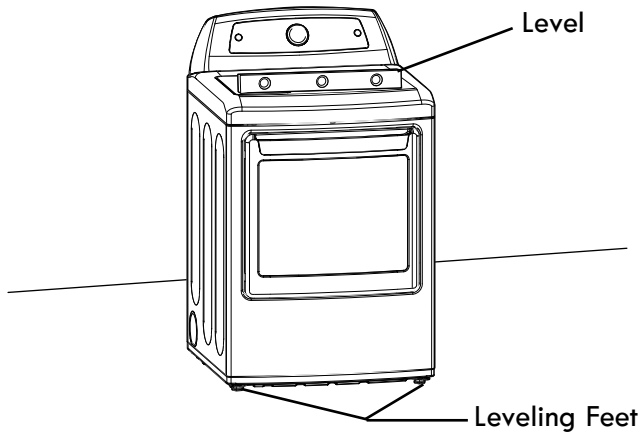

- 1 Position the dryer in the final location. Place a level across the top of the dryer.

All four leveling feet must rest solidly on the floor. Gently push on the top corners of the dryer to make sure that the dryer does not rock from corner to corner.

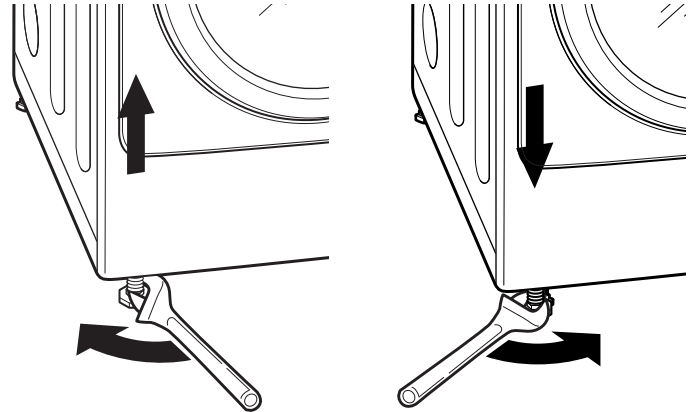

- 2 Use a wrench to turn the leveling feet. Turn the leveling foot clockwise to raise the dryer; turn the foot counterclockwise to lower the dryer. Using a level to check, adjust the feet until the dryer is level from side to side and front to back. Make sure all four feet are in firm contact with the floor.

**NOTE:** If you are installing the dryer on the optional pedestal, the dryer leveling feet should be fully retracted. Use the leveling feet on the pedestal to level the dryer.



**REVERSING THE TWO-WAY DOOR**

**Before You Begin**

**NOTE:**

The door reversal procedure for the two-way door is far more complex than for a conventional dryer door. Read through these instructions in their entirety before beginning the process, in order to gauge whether to have the procedure done by a professional installer or service person.

Service calls to reverse the door are not covered under the product warranty.

The door reversal procedure consists of four main parts:

- Removing and reinstalling the **door and hinges** (steps 1, 2 and 18)
- Removing and reversing components on the dryer **cabinet** (step 3)
- Removing and reversing components on the **door cover** (steps 4 and 5)
- Removing and reversing components **inside the door** (steps 6 through 17).

**Tools Required**

- **Phillips screwdriver**
- **Large flat-blade screwdriver** (recommended for hinge screws if they are tight or your Phillips screwdriver is worn)
- **Small flat blade screwdriver** (for lifting out parts)

**! WARNING:**

**THE DRYER DOOR IS VERY LARGE AND HEAVY.** Failure to follow the instructions below can result in damage to the dryer, property damage or personal injury.

- **To avoid damage to the dryer or the door, support the door with a stool or box that fits under the door, or have an assistant support the weight of the door.**
- **Avoid dropping the door to prevent damage to the door or the floor.**
- **Unplug the dryer or turn off power at the main circuit breaker before beginning door reversal.**

**Instructions**

**NOTE:**

The instructions here are for changing the door swing from a right to a left side hinge. If the door has been reversed, and it is necessary to change it back, use care when following these instructions. Some of the illustrations and the left/right references will be reversed, and you will need to read the instructions carefully.

**! WARNING:**

Be sure to support the weight of the door before removing the hinge screws.

**On the Cabinet:**

- 1** Open the door from the side so that the hinge screws are accessible.

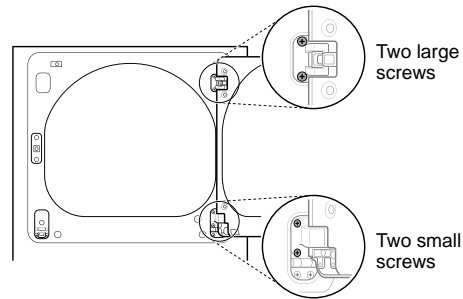

- 2** Remove the four hinge screws.

While supporting the door, remove the four hinge screws, two from each hinge. Set the door aside face down on a protected surface to prevent damage to the door or the work surface.

- 3** Reverse the components on the cabinet.

- a. Use a Phillips screwdriver to remove the two screws and the latch mechanism on the front panel of the cabinet.

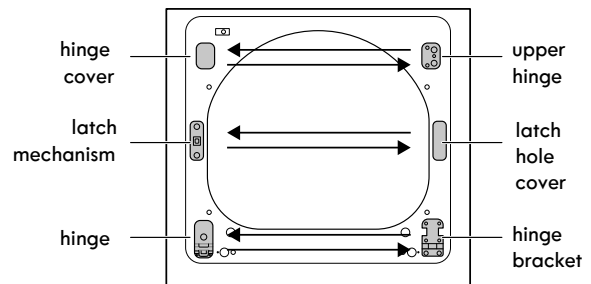

- b. Remove the latch hole cover by gently prying it up with a flat-blade screwdriver, being careful not to scratch the paint. Install the latch hole cover on the opposite side, where the latch mechanism was removed. Install the latch mechanism in the position from which you removed the latch hole cover, using the two screws removed in step a.
- c. Remove the hinge cover by gently prying it up with a flat-blade screwdriver, being careful not to scratch the paint. Rotate the hinge cover 180 degrees and install it on the opposite side, where the upper hinge was attached.

# INSTALLATION INSTRUCTIONS

## REVERSING THE TWO-WAY DOOR (continued)

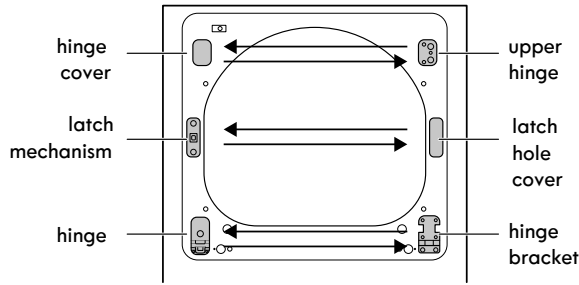

- d. Reverse the hinge and the hinge bracket at the bottom of the cabinet. Remove the two screws from the hinge bracket at bottom right and remove the hinge bracket.

Remove the lower of the two screws behind the hinge bracket. Do NOT remove the upper screw behind the hinge bracket. Set the parts aside.

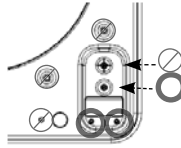

**NOTE:**

Do NOT remove any of the eight screws on the face of the cabinet (marked with ⊘ below). Doing so could result in damage to the dryer and the need for a service call to repair the dryer.

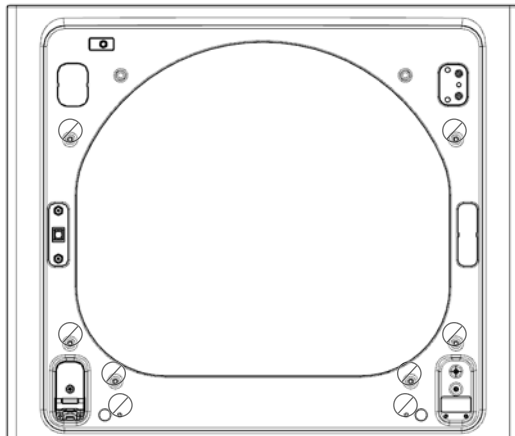

- e. Remove the three screws on the hinge at bottom left. Remove the hinge and reinstall it on the right side. The top screw occupies the hole where you removed the screw behind the hinge bracket in step d.
- f. Install the hinge bracket removed in step d on the bottom left side, first installing one screw behind the hinge bracket.

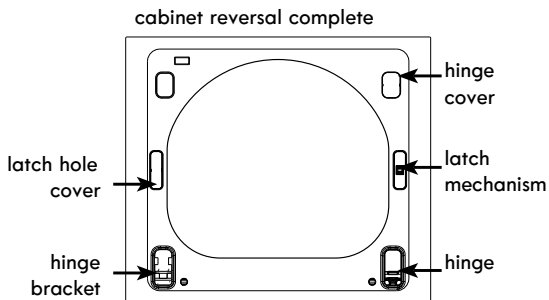
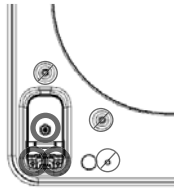

**On the Door:**

- 4 Lift off the door cover.

With the door laid inside facing up on a protected surface, remove the 12 screws on the inside of the door. Carefully lift off the door cover with the help of a small flat-blade screwdriver inserted in the upper corner (circled below).

**CAUTION:**

The edges of the door cover may be sharp. Take care when handling, or wear gloves to avoid injury.

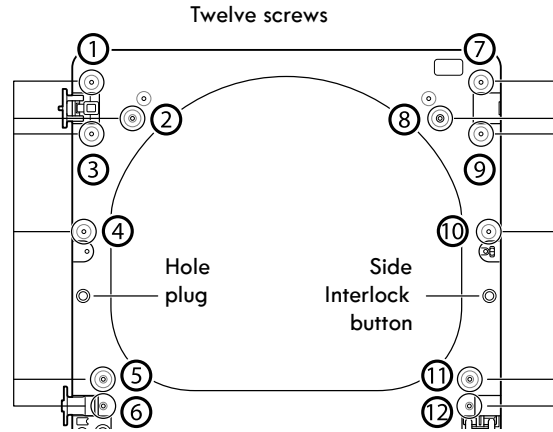

- 5 Switch the door strike and the blank cover.

Remove the four screws on the door cover that secure the door strike and the blank cover.

Switch the door strike and the blank cover, installing them on the opposite sides from which they were removed.

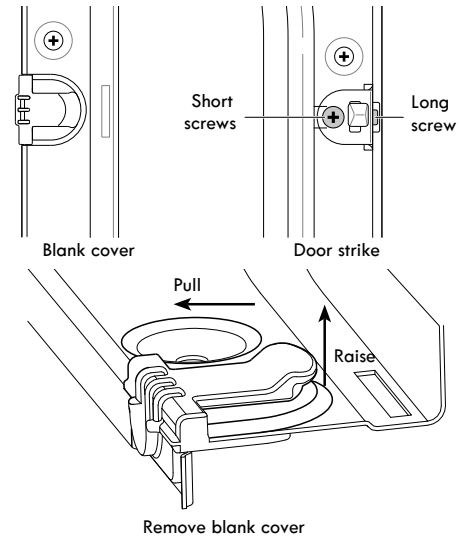

Gently pry out the hole plug on the side of the door cover and install it in the hole on the opposite side. Set the door cover aside.

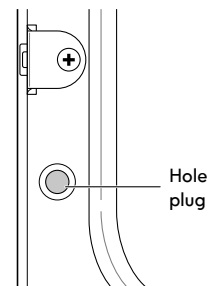

**6 Reverse the components inside the door.**

You will now be removing and reversing various components inside the door. See below for a detailed diagram and identification of the inner structure and parts of the door. (The diagram shows the "before view" of the door, with the default setup for a right side hinge swing. After following these instructions, your door should be a mirror image of the illustration.)

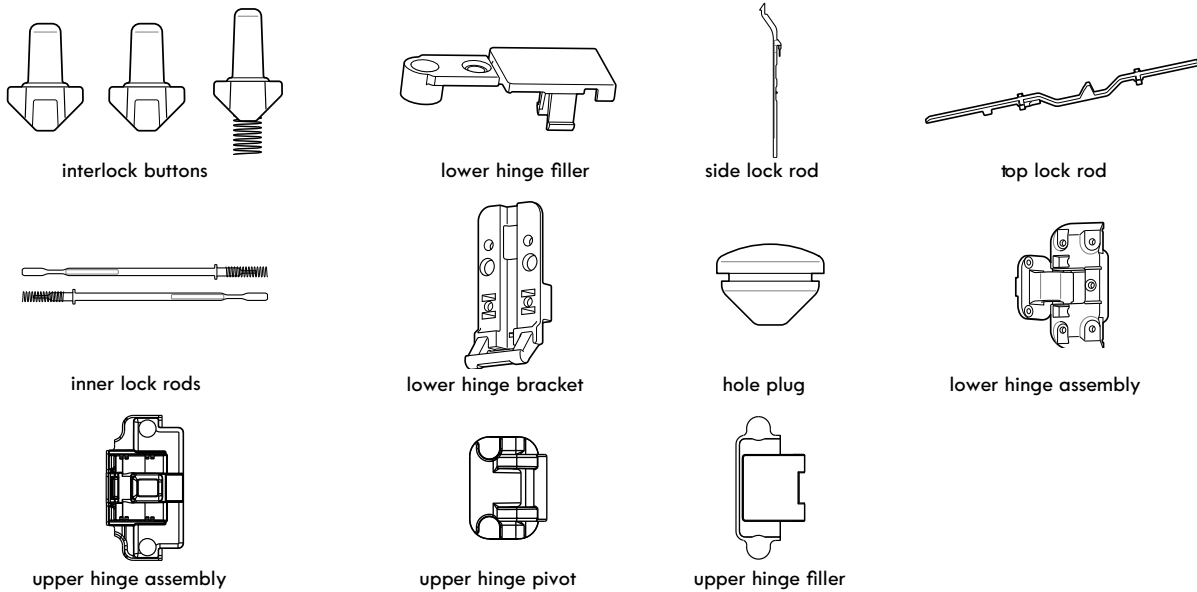
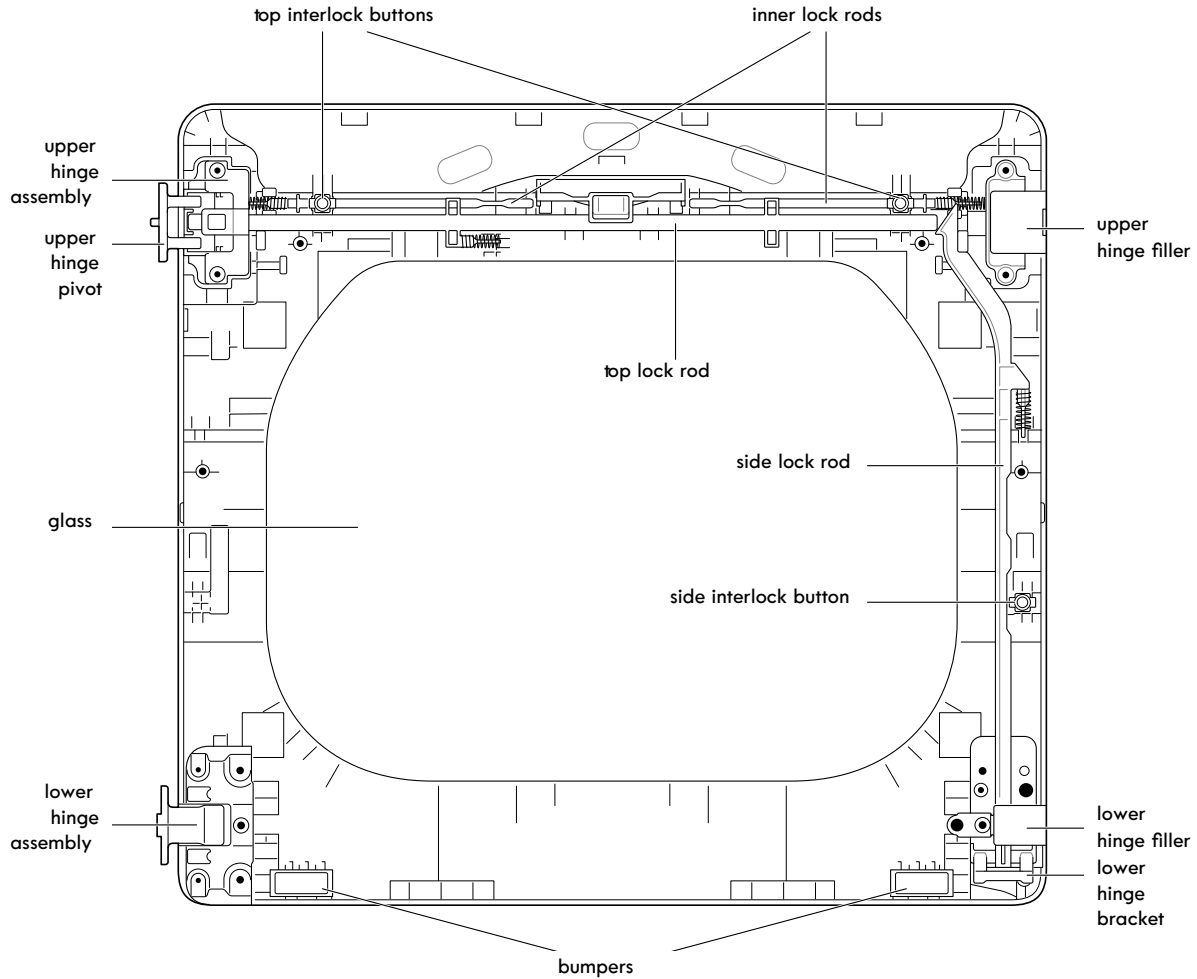

## INSTALLATION INSTRUCTIONS

### REVERSING THE TWO-WAY DOOR (continued)

- 7** Lift out the grey interlock button in the side of the door.

Make sure to remove the spring with the interlock button and to keep the two together. Set the interlock button aside. Do not confuse it with the interlock buttons from the top of the outer door.

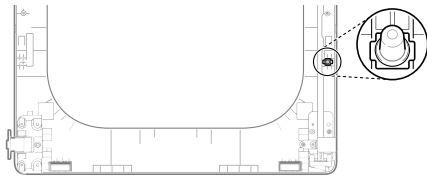

- 8** Remove the side lock rod.

Remove the side lock rod from the lower hinge bracket by lifting the top end of the rod and sliding it toward the top of the door. The spring should remain attached to the lock rod. Set the lock rod aside.

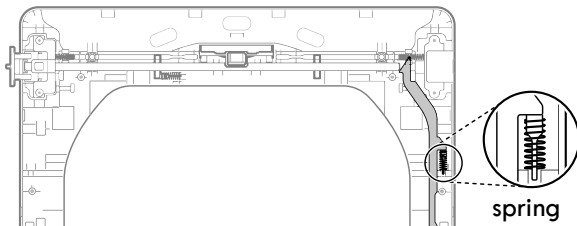

- 9** Remove the top lock rod.

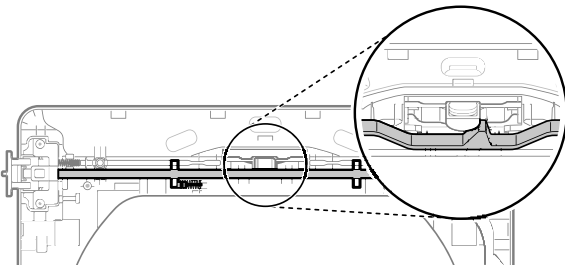

- a. Slide the lock rod to the right to remove it from the hinge assembly on the left side.  
b. While sliding the lock rod right, lift the right end up and out of the guides. Set the lock rod aside.

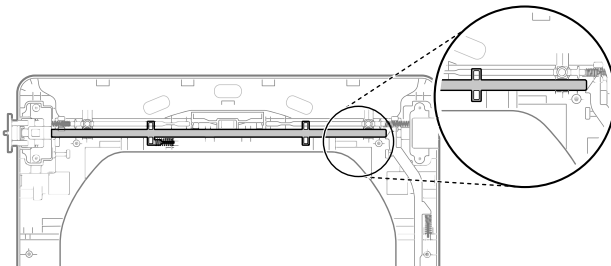

#### NOTE:

Do not remove the two inner lock rods and two interlock buttons (see page 20) located underneath the top lock rod. They do NOT need to be reversed.

- 10** Remove the upper hinge pivot.

Once the top lock rod has been removed, the hinge pivot can easily be removed from the hinge assembly on the upper left and set aside.

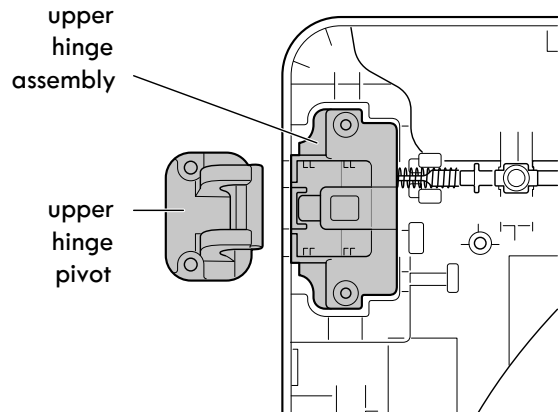

- 11** Reverse the upper hinge assembly and hinge filler.

Lift out the upper hinge filler (on the right) and set it aside.

Carefully lift the upper hinge assembly (on the left) out of the outer door frame, using a small flat-blade screwdriver if necessary. Rotate the hinge assembly 180 degrees and install it on the upper right side of the outer door. You will need to press firmly to install the hinge assembly.

The hinge pivot removed in step 10 will be installed later.

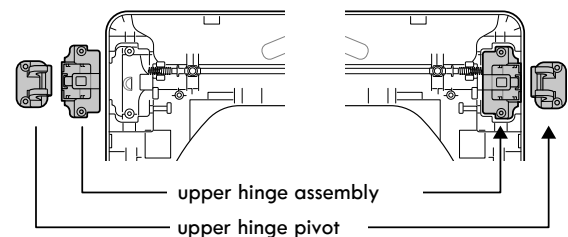

Now rotate the hinge filler 180 degrees and install it on the upper left side of the door.

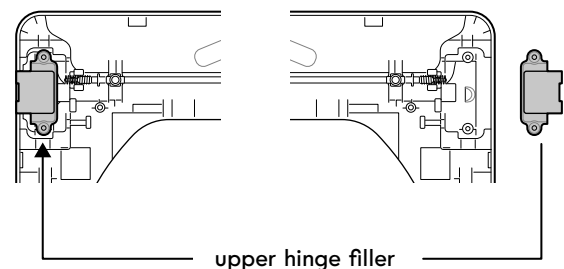

**12 Reinstall the top lock rod.**

Rotate the top lock rod (removed in step 9) 180 degrees end for end from its original position and reinstall it. The spring should now be to the right of center, with the spring on the side of the rod facing the top of the door.

- a. Insert the right end of the lock rod into the right hinge assembly. Make sure the rod is aligned with the guides in the door panel.

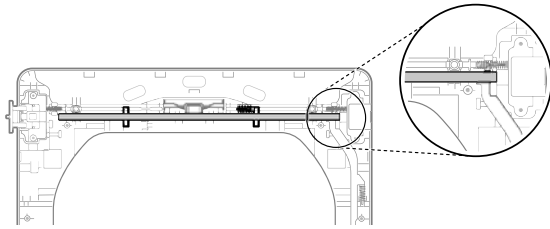

- b. Lower the rod into position, sliding it to bypass the center handle, making sure to align the lock rod with the guides all the way across the door panel. When released, the lock rod should slide completely into the hinge assembly on the right. Slide the lock rod back and forth to make sure it is correctly positioned in the guides and slides easily.

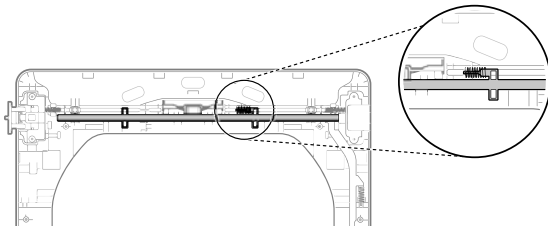

**13 Reverse the lower hinge bracket and hinge assembly.**

- a. Remove the screw from the lower hinge bracket (on the right) and lift the hinge bracket out. Set it aside. Remove the two screws from the lower hinge assembly on the bottom left and lift the hinge assembly out.

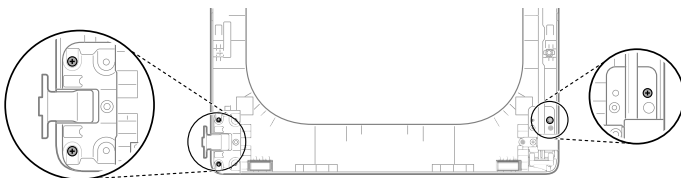

- b. Rotate the lower hinge assembly 180 degrees and install it on the right side using the two screws removed in step a.

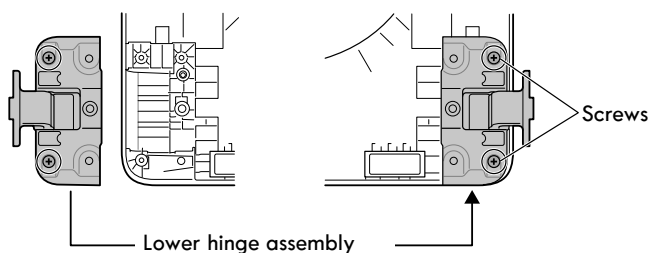

- c. Flip over the lower hinge bracket and release the tabs on the back locking the hinge filler to the hinge bracket.

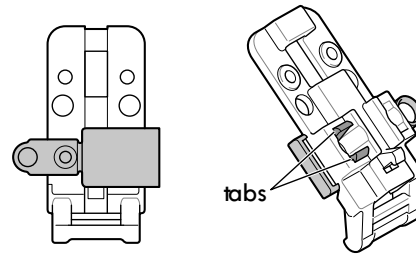

- d. Rotate the hinge filler 180 degrees and snap it back onto the front of the hinge bracket facing in the opposite direction.

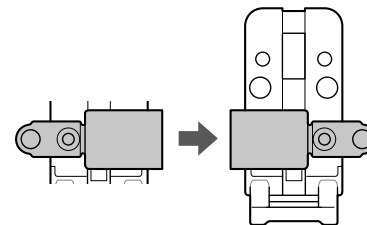

- e. Mount the lower hinge bracket and the filler on the left side of the door with the screw removed in step a.

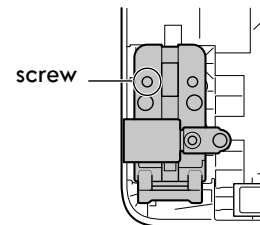

**14 Install the side lock rod.**

Flip the side lock rod over and install it on the opposite side. Insert the lower end into the left hinge and lower the rod into the guides on the door while compressing the spring inside the recess.

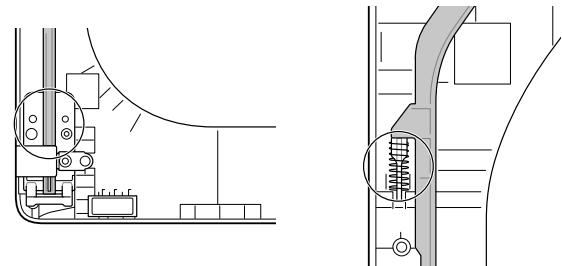

Make sure the top of the side lock rod is beside the top lock rod and the two do not overlap each other, so the two rods can interact correctly. If they are not aligned properly, the door will not operate properly.

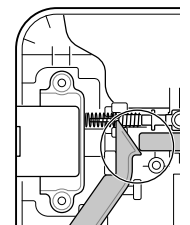

## INSTALLATION INSTRUCTIONS

### REVERSING THE TWO-WAY DOOR (continued)

#### 15 Reinstall the side interlock button.

Reinstall the side interlock button removed in step 7. Center the spring in the compartment and insert the interlock button on top of it.

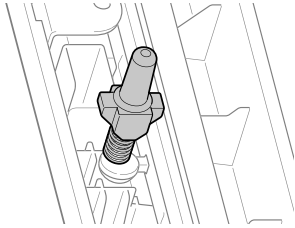

#### 16 Reinstall the door cover.

Clean the glass on the door and door cover, if necessary.

Make sure the two gray interlock buttons are properly installed and that the top and side lock rods are properly aligned where they meet. Carefully lower the door cover into place, aligning the holes in the cover with the interlock buttons on the top and side and the bumpers on the bottom. Take care not to dislodge the lock rods while mounting the door cover. Once the door cover is in place, secure it with the 12 screws removed in step 4.

The ten similar screws go around the top and sides of the door cover. Make sure to install the two different screws on the bottom edge, in the locations marked below.

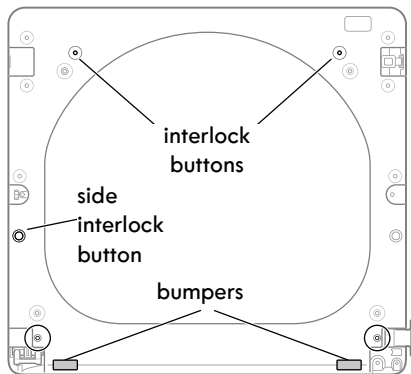

#### 17 Install the top right hinge pivot.

Pick up the upper hinge pivot removed earlier and rotate it 180 degrees. Press in the side interlock button on the left side and hold it down while pressing the hinge pivot into the hinge assembly on the top right side. If the door has been reassembled correctly, the lock rod slides back easily and locks the pivot in place. The door is now ready to remount on the opposite side of the dryer.

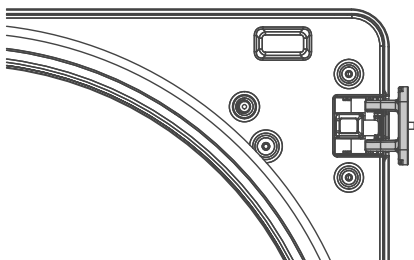

## ⚠ WARNING:

Be sure to support the weight of the door before installing the hinge screws.

#### 18 Reinstall the door.

While supporting the door, install the four hinge screws removed in step 2. Test the swing of the door to make sure the hinges and latch are properly aligned and that the door opens, closes, and latches properly in both directions.

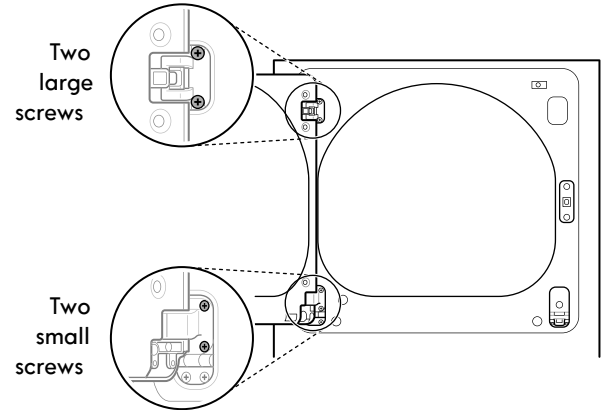

If the door doesn't operate smoothly, remove the door and then the door cover to check that the lock rods and interlock buttons are properly mounted and aligned. The interlock buttons should be oriented correctly and operating smoothly. The interlock rods should be in the proper position and should not overlap at the contact point. (See steps 12-14.)

If the door is damaged, or if the door does not work after reassembly, contact the call center at 1-800-469-4663.

## FINAL INSTALLATION CHECK

Once you have completed the installation of the dryer and it is in its final location, confirm proper operation with the following steps and tests.

- 1 Is gas turned on? (Gas models only)
- 2 Is dryer plugged in? Dryer should always be plugged into the proper outlet.

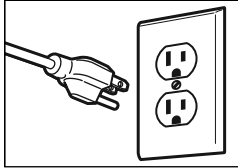

Gas dryer should use a 120-VAC, 60-Hz. grounded 3-prong outlet.

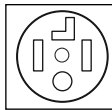

Electric dryer should use a 4-wire connection which is required for all mobile and manufactured home installations, as well as all new construction after January 1, 1996.

-- OR --



A 3-wire connection. **NOTE:** A 3-wire connection is NOT permitted on new construction after January 1, 1996.

- 3 Is the dryer transition duct connected? Make sure the transition duct behind the dryer is properly connected and is not crushed or damaged.
- 4 Is dryer level? Once the dryer is in its final location, recheck the dryer to be sure it is level. Make sure it is level front to back and side to side, and that all four leveling feet rest firmly on the floor.
- 5 Is the dryer heating normally? Perform the following dryer heating test.

## Testing Dryer Heating

- 1 Close the dryer door.
- 2 Press the POWER button to turn the dryer on.
- 3 Turn the cycle selector knob to Normal drying cycle.
- 4 Press the START/PAUSE to start the dryer. Open the dryer door and check that the air inside is warm after three minutes.

**NOTE:** If all air is not purged from the gas line, the gas igniter may turn off before the main burner ignites. If this happens, the igniter will reattempt gas ignition until all the air is purged from the gas line.

## GAS MODELS

Close the dryer door, press the POWER button to turn the dryer on, and start the dryer on a heat setting. When the dryer starts, the igniter should ignite the main burner.

## ELECTRIC MODELS

Close the dryer door, press the POWER button to turn the dryer on, and start the dryer on a heat setting. The exhaust air should be warm after the dryer has been operating for 3 minutes.

## Checking Airflow

Effective dryer operation requires proper airflow. The adequacy of the airflow can be measured by evaluating the static pressure. Static pressure in the exhaust duct can be measured with a manometer, placed on the exhaust duct approximately 2 ft. (60.9 cm) from the dryer. Static pressure in the exhaust duct should not exceed 0.6 inches (1.5 cm). The dryer should be checked while the dryer is running with no load.

## Checking Levelness

Once the dryer is in its final location, recheck the dryer to be sure it is level. Make sure it is level front to back and side to side, and that all four leveling feet are firmly on the floor.

## Checking Venting

The vent duct should be checked for lint buildup and cleaned at least once per year. If any noticeable reduction in drying performance occurs, check the duct for obstructions and blockages.

## INSTALLATION INSTRUCTIONS

### INSTALLATION TEST (DUCT CHECK)

Once you have completed the installation of the dryer, use this test to make sure the condition of the exhaust system is adequate for proper operation of the dryer. This test should be performed to alert you to any serious problems in the exhaust system of your home.

The dryer features Check Vent, an innovative sensing system that automatically detects blockages and restrictions in dryer ductwork. Keeping ductwork clean of lint buildup and free of restrictions allows clothes to dry faster and reduces energy use.

**NOTE:** The dryer should be cool before starting this test. If the dryer was warmed up during installation, run the Air Dry cycle for a few minutes to reduce the interior temperature.

To activate the installation test:

- 1 Remove the drying rack and literature, then close the dryer door.

Do not load anything in the drum for this test, as it may affect the accuracy of the results.

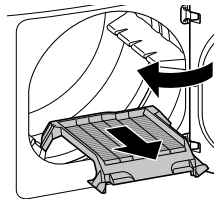

- 2 Press the Power button, then immediately press and hold both the Temp and Chime buttons until **1n5** appears in the display.

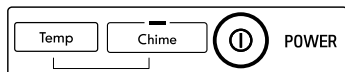

- 3 Press the START/PAUSE button.

The dryer will start the test, which lasts about 2 minutes. The heat is turned on and the temperatures in the drum are measured.



- 4 Check the display for results.

During the test cycle, monitor the CHECK VENT LED on the control panel. If the LED does not blink by the time the cycle ends, the exhaust system is adequate. If the exhaust system is severely restricted, the CHECK VENT LED blinks. Have the exhaust system checked immediately, as dryer performance will be poor.

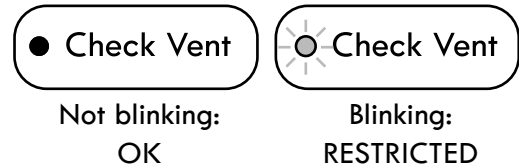

Other problems may also be shown with error codes. Refer to the table below for error code details and solutions.

- 5 End of cycle.

At the end of the test cycle, **End** appears in the display. The test cycle ends and the dryer shuts off automatically after a short delay.



Check any error codes in the chart below before calling for service.

Error Code	Possible Causes	Solutions
tE1 or tE2	Temperature sensor failure	Turn off dryer and call for service.
HS	Humidity sensor failure	Turn off dryer and call for service.
PS or PF or nP	<ul style="list-style-type: none"> <li>Electric dryer power cord is not connected correctly, or house power supply is incorrect.</li> <li>House fuse is blown, circuit breaker has tripped, or power outage has occurred.</li> </ul>	<ul style="list-style-type: none"> <li>Check power supply or connection of power cord to terminal block. Refer to the Connecting Electric Dryers section of this guide for complete instructions.</li> <li>Reset circuit breaker or replace fuse. Do not increase fuse capacity. If problem is a circuit overload, have it corrected by a qualified electrician.</li> </ul>



**RESTRICTED OR BLOCKED AIRFLOW**

**Check the duct condition.**

If the CHECK VENT LED is blinking, check the exhaust system for restrictions and damage. Repair or replace the exhaust system as needed.

**NOTE:** When the dryer is first installed, this test should be performed to alert you to any existing problems with the exhaust ducts in your home. However, since the test performed during normal operation provides more accurate information on the condition of the exhaust duct than does the installation test, the results of the two tests may not be the same.

Do not interrupt the test cycle, as this could result in inaccurate results.

Even if the LED is not blinking during the test cycle, some restrictions may still be present in the exhaust system. Refer to the Venting the Dryer section of this guide for complete exhaust system and venting requirements.

Avoid long runs or runs with multiple elbows or bends.

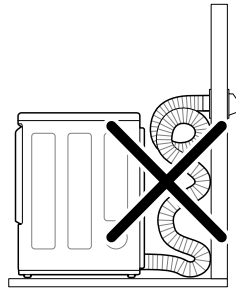

Excess or crushed transition duct

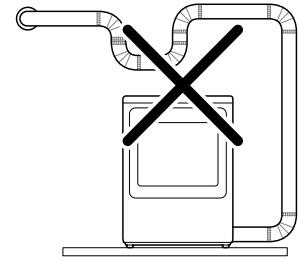

Too many elbows or exhaust too long

Check for blockages and lint buildup.

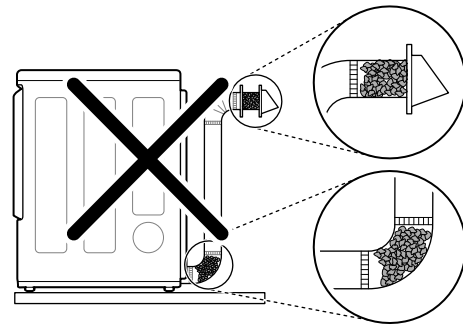

Lint buildup or blockage

Make sure the ductwork is not crushed or restricted.

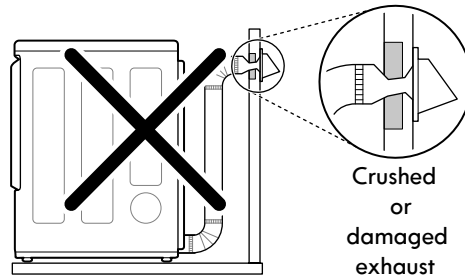

Crushed or damaged exhaust

## HOW TO USE

**! WARNING:** To reduce the risk of fire, electric shock, or injury to persons, read this entire manual, including the Important Safety Instructions, before operating this dryer.

### CONTROL PANEL FEATURES

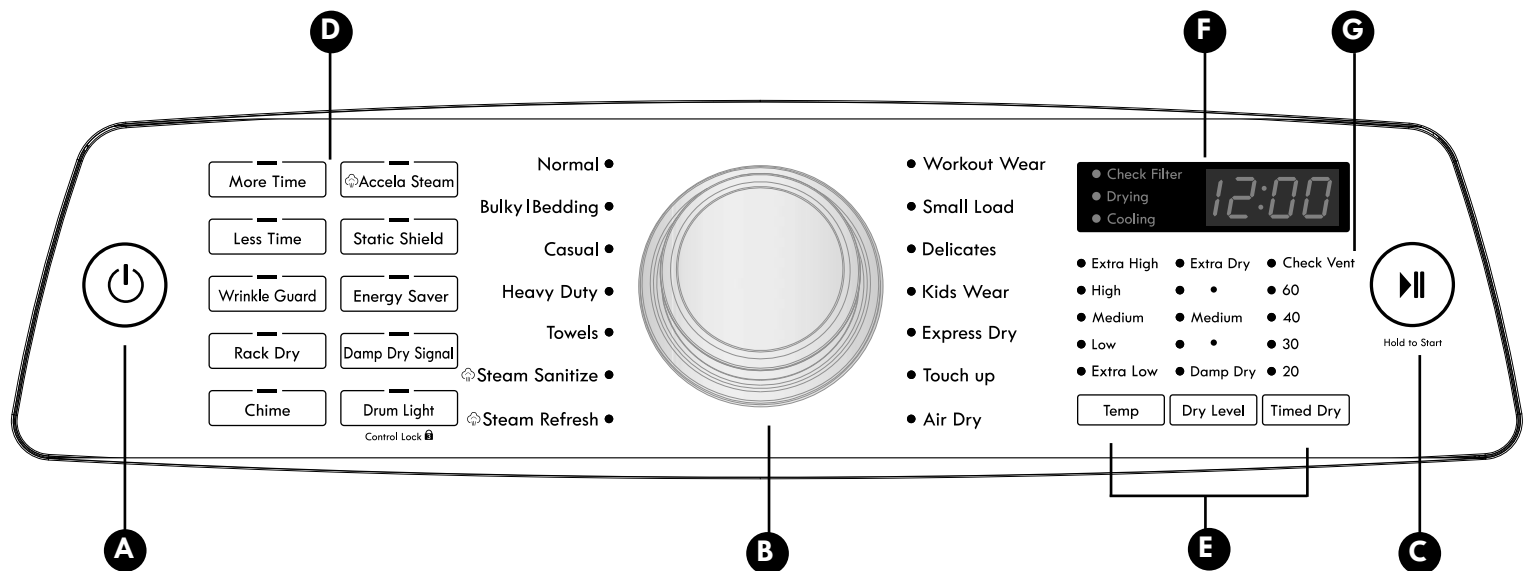

#### **A** POWER (ON/OFF) BUTTON

Press to turn the dryer ON. Press again to turn the dryer OFF. Pressing the POWER button during a cycle will cancel that cycle and any settings will be lost.

#### **B** CYCLE SELECTOR KNOB

The cycle selector knob is used to select the desired dry cycle by rotating the knob in either direction until the desired cycle LED is illuminated. Once the desired cycle has been selected, the standard presets for that cycle will show in the display. These settings can be adjusted using the cycle modifier or option buttons any time before starting the cycle.

#### **C** START/PAUSE BUTTON

Press this button to start the selected cycle. The dryer will display the estimated time (AUTO DRY) or set time (TIMED DRY) remaining and start tumbling. To pause the cycle at any time, open the dryer door or press START/PAUSE. To resume the cycle where it was stopped, press START/PAUSE again.

**NOTE:** If the dryer has been stopped for more than four minutes, the dryer will turn off automatically and all settings will be lost.

#### **D** OPTION BUTTONS

These buttons allow you to select cycle options. Some of the option buttons have secondary functions. The controls can be locked or unlocked by pressing and holding the DRUM LIGHT button for five seconds.

#### **E** CYCLE MODIFIER BUTTONS

Use these buttons to adjust the settings for the selected cycle. The settings light up above the buttons to show the current selection. The default temperature setting cannot be changed in AUTO DRY cycles. AUTO DRY cycles are modified using the Dry Level button.

#### **F** TIME AND STATUS DISPLAY

The display shows the estimated time remaining for auto cycles and actual time for timed cycles. The status of the cycle is also displayed. The CHECK VENT indicator will illuminate if there is a serious restriction in the exhaust system.

#### **G** CHECK VENT INDICATOR (DUCT BLOCKAGE SENSING SYSTEM)

The CHECK VENT duct blockage sensing system detects and alerts you to blockages in the ductwork that reduce exhaust flow from the dryer. This light does not indicate any problems with your dryer. If this light blinks, it indicates that your home's exhaust system has a serious restriction, which is not covered by your dryer's warranty.

**NOTE:** To protect your fabrics, not all settings are allowed in all cycles.

## TIME AND STATUS DISPLAY

The Time and Status Display shows the cycle time, cycle progress, and vent status. When the dryer is turned on, the display will illuminate.

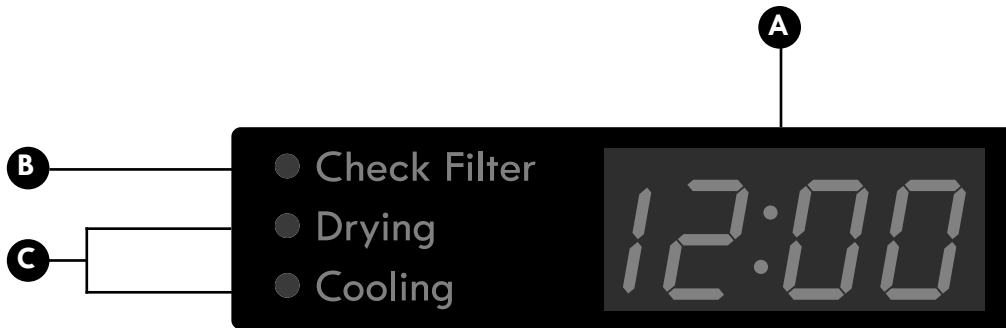

### **A** TIME DISPLAY

When a cycle is selected, the display will indicate the default time for that cycle including selected options or adjustments. In AUTO DRY cycles, the time remaining will be estimated and may change during the cycle, depending on the condition of the load. In TIMED DRY, the time displayed will be the actual time remaining.

### **B** CHECK FILTER LIGHT

The CHECK FILTER light will blink before each load, as a reminder to check the lint filter. Always clean the lint filter before every cycle.

### **C** CYCLE STATUS INDICATORS

This portion of the display shows which stage of the drying cycle is currently under way (DRYING or COOLING).

OPERATING THE DRYER

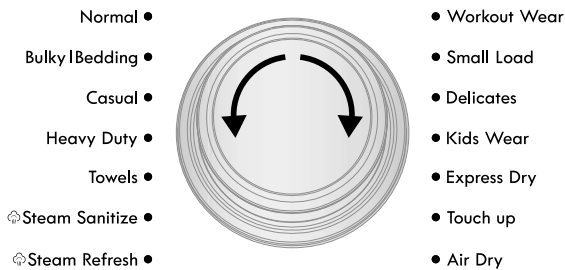
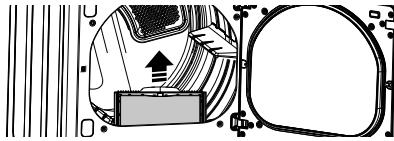
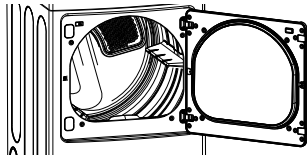

- Extra High
- High
- Medium
- Low
- Extra Low
- Extra Dry
- Medium
- Damp Dry
- Check Vent
- 60
- 40
- 30
- 20

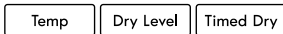

Hold to Start

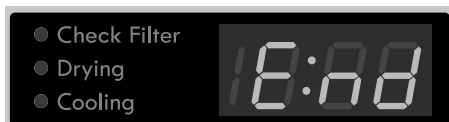

**1 LOAD THE DRYER**  
Load the dryer with the wet laundry from the washer. If the load is extra large, you may need to divide it into smaller loads for proper performance and fabric care.

**2 CLEAN THE LINT FILTER**  
If the lint filter has not already been cleaned, lift out the filter and remove the lint from the last load. This will help ensure the fastest and most efficient drying performance.

**3 TURN ON THE DRYER**  
Press the POWER button to turn ON the dryer. The cycle LEDs will illuminate and a chime will sound.

**4 SELECT A CYCLE**  
Turn the cycle selector knob in either direction until the LED for the desired cycle is illuminated. The preset temperature, dry level, and option settings for that cycle will display.

**5 SELECT CYCLE MODIFIERS**  
Default settings for the selected cycle can now be changed, if desired, using the Temp and Dry Level buttons.

**NOTE:** Not all options or modifiers are available on all cycles. Temperature can only be adjusted on Timed Dry cycles; Dry Level is only available on Auto Dry cycles. A different chime will sound and the LED will not illuminate if the selection is not allowed.

**6 SELECT CYCLE OPTIONS**  
Cycle options can be added using the option buttons.

**NOTE:** Not all options or modifiers are available on all cycles. A different chime will sound and the LED will not come on if the selection is not allowed.

**7 BEGIN CYCLE**  
Press the START/PAUSE button to begin the cycle. The cycle can be paused at any time by opening the door or by pressing the START/PAUSE button. If the cycle is not restarted within four minutes of being paused, the dryer will shut off and the settings will be lost.

**8 END OF CYCLE**  
When the cycle is finished, the chime will sound. Immediately remove your clothing from the dryer to reduce wrinkling. If WRINKLE GUARD is selected, the dryer will tumble briefly every few minutes to help prevent wrinkles from setting in the clothes.

**⚠ WARNING:** To reduce the risk of fire, electric shock, or injury to persons, read this entire manual, including the Important Safety Instructions, before operating this dryer.

## SORTING LOADS

### Fabric Care Labels

Most articles of clothing feature fabric care labels that include instructions for proper care.

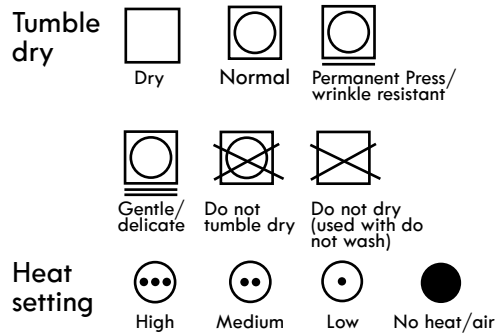

### Group Similar Items

For best results, sort clothes into loads that can be dried with the same drying cycle.

Different fabrics have different care requirements, and some fabrics will dry more quickly than others. For best fabric care results, always dry fabrics with similar care requirements together.

## LOADING THE DRYER

**⚠ WARNING:** To reduce the risk of fire, electric shock, or injury to persons when using this appliance, follow basic precautions, including the following:

- Check all pockets to make sure that they are empty. Items such as clips, pens, coins, and keys can damage both your dryer and your clothes. Flammable objects such as lighters or matches could ignite, causing a fire. Failure to do so can result in fire, explosion, or death.
- Never dry clothes that have been exposed to oil, gasoline, or other flammable substances. Washing clothes will not completely remove oil residues. Failure to obey this warning can result in fire, explosion, or death.

### Loading Tips

- Combine large and small items in the same load.
- Damp clothes will expand as they dry. Do not overload the dryer; clothes require room to tumble and dry properly.
- Close zippers, hooks, and drawstrings to prevent these items from snagging or tangling on other clothes.

### CHECK THE LINT FILTER BEFORE EVERY LOAD

Every time the dryer is turned on, the CHECK FILTER light will blink as a reminder to make sure the filter is clean. Always make sure the lint filter is clean before starting a new load; a clogged lint filter will increase drying times. To clean, pull the lint filter straight up and roll any lint off the filter with your fingers. Do not rinse or wash the filter to remove lint. Push the lint filter firmly back into place.

Always ensure the lint filter is properly installed before running the dryer. Running the dryer with a loose or missing lint filter may damage the dryer and articles in the dryer.

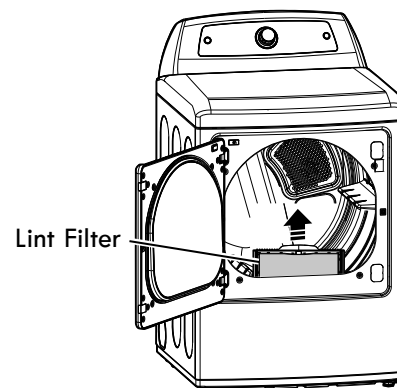

## HOW TO USE

### CYCLE GUIDE

The cycle guide below shows the available options and recommended fabric types for AUTO DRY cycles.

**\*NOTE:** The default time and actual time will vary depending on the size of the load and moisture content.

#### Auto Dry Cycles

AUTO DRY cycles utilize a sensor that detects moisture levels in the clothes and adjusts the drying time as needed to ensure superior results. The dryer automatically sets the dry level and temperature at the recommended setting for each cycle. The estimated time remaining will be shown in the display.

● = available option

■ = default setting

Type	Cycle	Fabric Type	Modifiers				Options				
			Temperature	Dry Level	Time in Min.*	More Time/ Less Time	Wrinkle Guard	Damp Dry Signal	Static Shield	Accela Steam	Energy Saver
AUTO DRY	Normal	Work clothes, etc.	Medium	Medium	Elec: 67 Gas: 63		●	●	●	●	●
				Adjustable							
	Bulky/ Bedding	Comforter, pillows, shirts	Medium	Medium	55				●		
				Adjustable							
	Casual	Permanent press, synthetic items	Low	Medium	32		●	●	●	●	
				Adjustable							
	Heavy Duty	Jeans, heavyweight items	Extra High	Medium	54		●	●	●	●	
				Adjustable							
	Towels	Towels, heavy cottons, denims	High	Medium	55		●	●	●		
				Adjustable							
	Steam Sanitize	Comforter, bedding, children's clothing, etc.	Extra High	Auto	31		●				
Steam Refresh	1-5 garments. Comforters, shirts, trousers, etc. Do not use cycle for delicate fabrics.	High	Auto	10							
		Adjustable		Adjustable	●	●					
Workout Wear†	Workout wear	Auto	Auto	27		●		●			
Small Load	Small cotton, normal, or towel loads (Max 3 lb)	Extra High	Medium	30		●					
			Adjustable								
Delicates	Lingerie, sheets, blouses	Low	Medium	28		●	●	●			
			Adjustable								
Kids Wear	Children's clothes	Extra High	Medium	35		●					

**NOTE:** To protect garments, not every dry level or option is available with every cycle. Temperature settings cannot be changed. A different chime sounds and the LED does not illuminate or the selection does not change if the selection is not allowed.

#### NSF CERTIFIED BY NSF

NSF International (formerly the National Sanitation Foundation), certifies that the STEAM SANITIZE cycle reduces 99.9% of bacteria on laundry, and none of the bacteria will carry over onto the next laundry load.

- The default settings for the STEAM SANITIZE cycle are HIGH temperature and EXTRA DRY. These default settings cannot be changed.
- Do NOT use this cycle with delicate items or fabrics.

† The Workout Wear cycle helps to maintain the performance and extend the life of garments created with special high-performance properties. The temperature and dry level are set automatically and are not adjustable.

The cycle guide below shows the available options and recommended fabric types for TIMED DRY cycles.

**Timed Dry Cycles**

Use Timed Dry cycles to select a specific amount of drying time and the drying temperature. When a TIMED DRY cycle is selected, the display shows the actual time remaining in the cycle.

Change the actual time for the cycle by pressing MORE TIME or LESS TIME. Press and hold the MORE TIME or LESS TIME buttons to rapidly change the time.

● = available option

■ = default setting

Type	Cycle	Fabric Type	Modifiers				Options				
			Temperature	Dry Level	Time in Min.	More Time/ Less Time	Wrinkle Guard	Damp Dry Signal	Static Shield	Accela Steam	Energy Saver
TIMED DRY	Express Dry	For small loads with short drying times	Extra High	Off	25	●	●		●		
			Adjustable		Max. 100						
	Touch Up	For removing light wrinkles	High	Off	20	●	●		●		
			Adjustable		Max. 100						
	Air Dry	For items that require heat-free drying such as plastics or rubber	Air Only	Off	30	●	●				
					Max. 100						
	Rack Dry	Wool sweaters, silk, lingerie	Off	Off	50	●					
			Low Extra Low Air Only		Max 100						
	Timed Dry	For loads that require a specific dry time.	Extra High	Off	20/30/40/60	●	●		●		
			Adjustable		Max 100						

**STEAM SANITIZE CYCLE**

The STEAM SANITIZE cycle is designed to reduce the amount of certain types of bacteria in clothing. When this cycle is selected, the temperature is set to HIGH and the dry level is set to EXTRA DRY. These default settings cannot be changed.

**NOTE:** Do NOT use this cycle with delicate items or fabrics.

**NSF CERTIFIED BY NSF**

NSF International (formerly the National Sanitation Foundation), certifies that the STEAM SANITIZE cycle reduces 99.9% of bacteria on laundry, and none of the bacteria will carry over onto the next laundry load.

- The default settings for the STEAM SANITIZE cycle are HIGH temperature and EXTRA DRY. These default settings cannot be changed.
- Do NOT use this cycle with delicate items or fabrics.

† The Workout Wear cycle helps to maintain the performance and extend the life of garments created with special high-performance properties. The temperature and dry level are set automatically and are not adjustable.

**USING THE TWO-WAY DOOR**

The dryer is equipped with a two-way door which opens in two directions, from the side as a swing door and from the top as a hamper door.

**Swing Door**

Use the two-way door as a swing door when unloading, or when loading bulkier items, for easy access to the drum.

To open the swing door, insert your fingers into the handle recess on the top of the door on the side opposite the hinge and pull the door open.

**CAUTION:**

Make sure the hamper door release is completely closed before using the swing door.

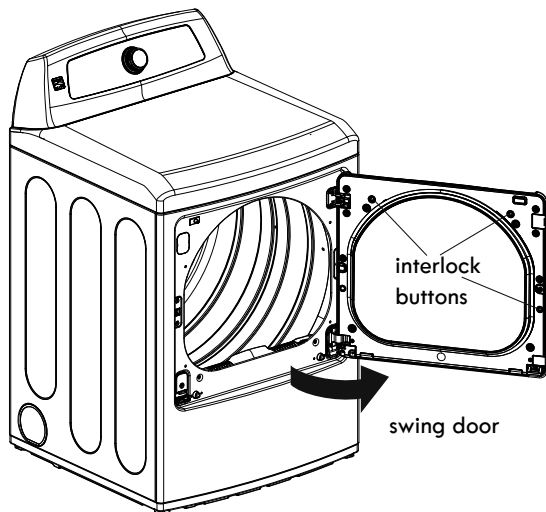

**WARNING:**

- Do not press the three interlock buttons when the door is open. The door may fall off and cause serious injury.
- Do not place heavy items on or lean against the top of the door when it is open.

The dryer could tip forward, causing injury or damage.

**Hamper Door**

Use the two-way door as a hamper door when loading. The hamper door opens about 40 degrees, acting as a chute, to help guide items into the drum and help prevent items from falling onto the floor. It also comes in handy when unloading a few small items, helping prevent the rest of the laundry from being pulled onto the floor.

To open the hamper door, press the release on the top of the door and pull the door forward.

Make sure the laundry is fully inserted in the drum before closing the door.

**CAUTION:**

Make sure the swing door latch is completely closed before pressing the hamper door release.

hamper door release

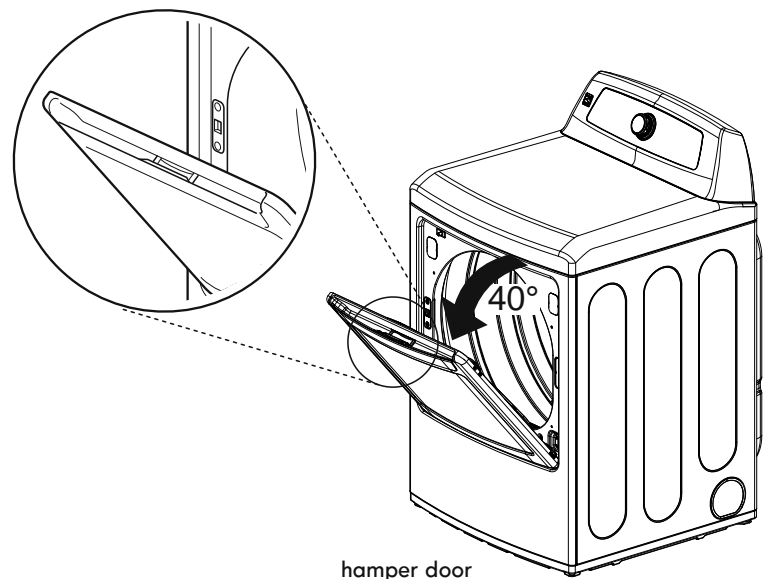

**WARNING:**

- Do not attempt to pull the hamper door open more than 40 degrees.
- Take care when opening and closing the door. If the door drops forward unexpectedly, fingers and hands can get caught in the door handle and injured.



## CYCLE MODIFIER BUTTONS

Each cycle has default settings that are selected automatically. You may also customize these settings using the cycle modifier buttons.

**AUTO DRY** cycles are designed to properly care for specific fabrics and loads. As a result, not all settings are available for each cycle selection.

**TIMED DRY** cycles have default settings, but you may also customize the temperature setting and add options.

Settings are not limited in most timed dry cycles. Use care when setting options and modifiers for these cycles to prevent damage to your clothing.

**NOTE:** To protect garments, not every dry level, temperature, or option is available with every cycle.

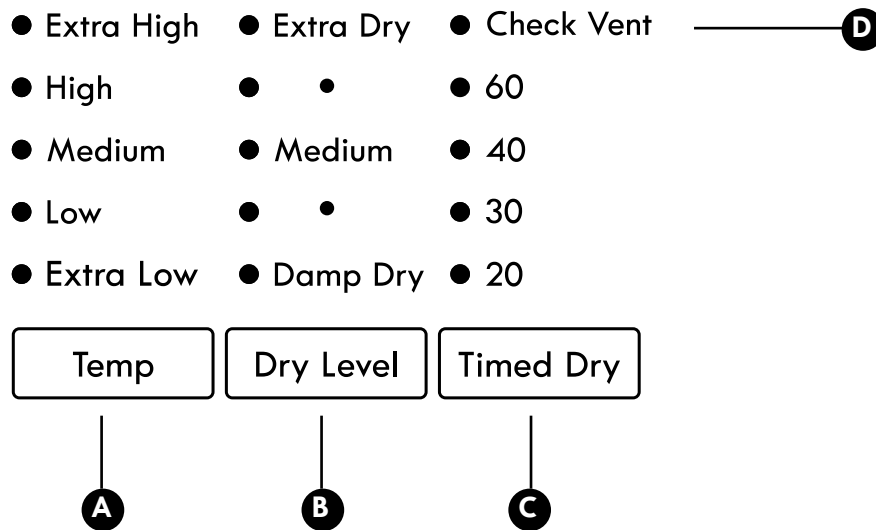

**A TEMP**  
Adjusts the temperature setting from EXTRA LOW to EXTRA HIGH. This allows precise care of your fabrics and garments. Press the TEMP button repeatedly to scroll through available settings. Temperature settings are not adjustable in AUTO DRY cycles.

**B DRY LEVEL**  
Sets the level of dryness for the selected AUTO DRY cycle. Press the DRY LEVEL button repeatedly to scroll through available settings. Use this button to adjust the dryness of the articles in the load to your preference.

- This option is not available with TIMED DRY cycles.
- The dryer will automatically adjust the cycle time.
- Selecting EXTRA DRY will increase the cycle time and dry level, while DAMP DRY will decrease the cycle time and dry level.
- Use the DAMP DRY setting for items that you wish to iron or hang for final drying.

**C TIMED DRY**  
Allows you to manually select 20, 30, 40, or 60 minutes of dry time. Use the MORE TIME/LESS TIME buttons to increase or decrease the selected drying time in 1-minute increments. Press and hold the MORE TIME or LESS TIME buttons to rapidly change the time.

**D CHECK VENT**  
(Duct Blockage Sensing System)  
The CHECK VENT (Duct blockage sensing system) detects and alerts you to blockages in the exhaust system that reduce airflow from the dryer. Maintaining clean exhaust system ducts improves operating efficiency and helps minimize service calls, saving you money.

**CYCLE OPTIONS AND SPECIAL FEATURES**

The dryer features several additional cycle options and special features to meet your individual needs.

**MORE TIME**



Use the MORE TIME/LESS TIME buttons to increase or decrease the selected drying time in 1-minute increments.

Press and hold the MORE TIME or LESS TIME buttons to rapidly change the time.

**LESS TIME**



Use the MORE TIME/LESS TIME buttons to increase or decrease the selected drying time in 1-minute increments. Press

and hold the MORE TIME or LESS TIME buttons to rapidly change the time.

**DAMP DRY SIGNAL**

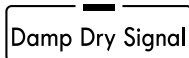

If you press the DAMP DRY SIGNAL button, the dryer will emit a chime when the clothes are just short of completely

dry, in case you want to remove them for ironing or hang drying.

**DRUM LIGHT**

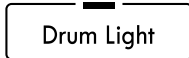

Control Lock

Use the DRUM LIGHT button to turn on the light inside the drum during cycle operation.

**NOTE:** The drum light will also come on if the dryer door is opened; however, after the dryer has been off for more than four minutes, the drum light will be disabled until the POWER button is pressed to turn on the dryer.

**WRINKLE GUARD**



Selecting this option will tumble the clothes after the cycle ends for a few seconds every few minutes without heat.

This option is active for 150 minutes after the end of the cycle, or until the door is opened. This helps prevent wrinkles if the clothes are not removed immediately after the cycle has finished.

**CHIME**

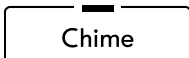

The CHIME button adjusts the volume of the chime or turns it off. Press the button repeatedly until the desired sound level

is reached.

**CONTROL LOCK**

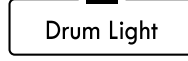

Control Lock

Use this option to disable the controls. All controls will be disabled except for the POWER button. Once set, the CONTROL LOCK must be turned off before the controls can be used. After the dryer has shut off, the POWER button will allow the dryer to be turned on, but the controls will remain locked. When the CONTROL LOCK is set, the LED will illuminate and “CL” will display alternately with the cycle time.

Press and hold the DRUM LIGHT button for five seconds to activate or deactivate the CONTROL LOCK.

**ENERGY SAVER (on some models)**

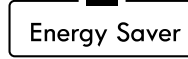

This option helps to reduce the energy consumption of the Normal cycle, depending on the size of the load.

When the Energy Saver option is selected, the cycle begins with an air dry section and the drying time is increased.

**NOTE:** The SAVE ENERGY option is turned on by default on the Normal cycle. If you want a faster drying time which begins with heated drying, turn off the SAVE ENERGY option on the Normal cycle.

**RACK DRY**



Use Rack Dry with items, such as wool sweaters, silk, and lingerie, that should dry flat. Rack Dry can also be used with

items that should not be tumbled dry, such as gym shoes or stuffed toys.

**NOTE:** Never tumble dry a load of clothing with the rack installed. When Rack Dry is used, the drum rotates as usual, but the rack does not move. Make sure all items remain completely on the rack and cannot fall off or be pulled off by the turning drum. Remove the rack after use.

**Installing the Dryer Rack**

- 1 With the dryer door open, slide the rack into the dryer drum.

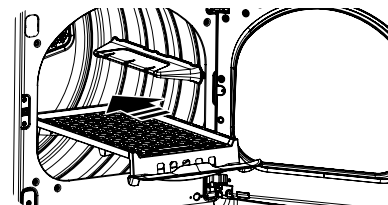

- 2 Seat the rack evenly on the edge of the inner door rim and resting flat on the inside of the dryer.

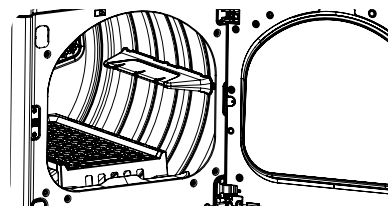



## STEAM FEATURES

### WARNING:

- Do not open the dryer door during Steam Cycles. Steam can cause severe burns.
- Do not touch the steam nozzle in the drum during or after the steam cycle.

#### Using the STEAM REFRESH cycle

The STEAM REFRESH cycle uses the power of steam to quickly reduce wrinkles and odor in fabrics. It brings new life to wrinkled clothes that have been stored for an extended period of time, and it can make heavily wrinkled clothes easier to iron. STEAM REFRESH can also be used to help reduce odors in clothes, such as clothes that were worn in a room where people had been smoking. This cycle can refresh from one to five garments, or one bulky item such as a comforter. Use  for one to three garments and  for four or five garments. For these settings, the dryer tumbles without heat while the water in the steam generator is heated. Once steam begins to flow, the dryer will only tumble for about three seconds every minute. Best results are achieved with 70/30 cotton/polyblend fabrics.

The *b 19* (big) setting should be used for bulky items, such as comforters. For this setting, the cycle begins with a heated dry segment followed by a shorter steam segment, as above.

**NOTE:** The STATIC SHIELD option can be used together with the STEAM REFRESH cycle to help prevent static electricity after the cycle.

- 1 Turn the dryer ON and select the STEAM REFRESH cycle.
- 2 Select the STATIC SHIELD option, if desired.
- 3 The default number of garments is three. Press the MORE TIME or LESS TIME button to adjust the load size, as described above.
- 4 Press the START/PAUSE button to start the cycle.

#### Using the STEAM SANITIZE cycle

The STEAM SANITIZE cycle is ideal for sanitizing non-washable items quickly and easily using the power of steam. This cycle is recommended for use with cotton and polyester materials. (Do NOT use for urethane foam, down feathers, or delicate items.)

#### IMPORTANT NOTES ABOUT STEAM FUNCTIONS:

- Steam may not be clearly visible during the steam functions. This is normal.
- Do not use Steam Refresh with items such as wool, wool blankets, leather jackets, silk, wet clothes, lingerie, foam products, or electric blankets.
- For best results, load articles of similar size and fabric type. Do not overload.
- If the home's exhaust system is restricted, the performance of the steam functions will be reduced.
- During steam operation, the clothes will tumble for only a few seconds, once a minute.

#### STATIC SHIELD

This option uses steam late in the drying cycle to reduce the static electricity caused by dry fabrics rubbing together. Change the steam time by pressing the MORE TIME and LESS TIME buttons to display the approximate number of articles in the load: 7, 9, 11, 14, 16 or 18. Steam time is approximately 1-6 minutes, depending on the number of garments selected.

**NOTE:** When STATIC SHIELD is added to auto dry cycles, the LESS and DAMP dry levels cannot be selected.

#### ACCELA STEAM

ACCELA STEAM helps prevent the overdrying of clothes by injecting steam during the drying process.

#### USING THE STEAM OPTIONS

##### Adding Steam to a Standard Cycle

- 1 Turn the dryer ON and turn the cycle selector knob to select the desired cycle.
- 2 Use the cycle modifier buttons to adjust the settings for that cycle.
- 3 Press the button for the steam option desired. Adjust for the load size using the MORE TIME or LESS TIME button.
- 4 Press the START/PAUSE button to start the cycle.

## HOW TO USE

### STEAM CYCLE GUIDE

Cycle	Steam	Default Time	Temp. Control	Dry Level	Fabric State	Fabric Type	Maximum Amount
Steam Sanitize		31 minutes			dry	comforter, bedding	single (1 each)
						children's clothing	3 lb
Steam Refresh		10 minutes	●		dry	comforter	single (1 each)
						shirts*	5 each
Sensor Cycle + Steam Option	+ Static Shield	follows selected cycle		●	wet	varies by selected cycle	8 lb (18 items)
	+ Accela Steam					●	wet
Timed Dry	+ Static Shield	38 minutes	●		wet	varies by selected cycle	8 lb (18 items)

\* Shirt: 70% cotton / 30% poly blend. Except especially delicate fabrics.

- When the lint filter or exhaust duct is clogged, steam options will not give proper results.
- For best results, load articles of similar size and fabric type. Do not overload.

#### NOTE:

- When sensor dry is selected with the STATIC SHIELD or ACCELA STEAM option, a dry level of Less or Damp cannot be selected.
- The STATIC SHIELD option may also be selected during Timed Dry cycles.
- After the steam option is selected in Timed Dry, the MORE TIME or LESS TIME buttons will change the steam time only.
- After pressing Start/Pause, the MORE TIME or LESS TIME buttons will be disabled.

**⚠ WARNING:** To reduce the risk of fire, electric shock, or injury to persons, read this entire manual, including the Important Safety Instructions, before operating this dryer.

- **Unplug the dryer or turn the power off before cleaning to avoid the risk of electric shock.** Failure to follow this warning can cause serious injury, fire, electrical shock, or death.
- **Never use harsh chemicals, abrasive cleaners, or solvents to clean the dryer.** They will damage the finish.

### REGULAR CLEANING

#### Cleaning the Exterior

Proper care of your dryer can extend its life. The outside of the machine can be cleaned with warm water and a mild, nonabrasive household detergent. Immediately wipe off any spills with a soft, damp cloth.

**IMPORTANT:** Do not use cleaning alcohols, solvents, or similar products.

NEVER use steel wool or abrasive cleansers because they can damage the surface.

#### Cleaning the Interior

Wipe around the door opening and seal with a soft, damp cloth to prevent lint and dust buildup that could damage the door seal.

Clean the window with a soft cloth dampened with warm water and a mild, nonabrasive household detergent, then wipe dry.

NEVER use steel wool or abrasive cleansers; they can scratch or damage the surface.

#### Cleaning Around and Under the Dryer

Vacuum lint and dust from around the dryer and underneath it regularly.

#### Cleaning the Lint Filter

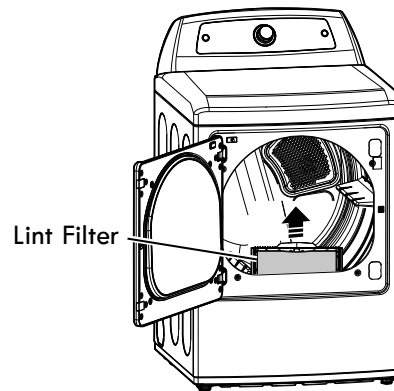

ALWAYS make sure the lint filter is clean before every cycle. The CHECK FILTER light on the control panel will blink before every cycle to remind you.

**NOTE:** NEVER operate the dryer without the lint filter.

#### To remove lint between cycles:

- 1 Open the dryer door.

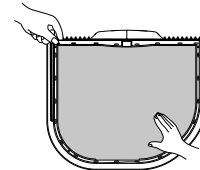

- 2 Pull the lint filter straight up.
- 3 Roll any lint off the filter with your fingers.

#### Periodic thorough cleaning:

Some fabric softeners can build up on the lint filter over time. This buildup can restrict the airflow through the filter reducing dryer efficiency and lengthening drying times. After removing lint, if the filter looks dark or dirty when held up to the light, follow these steps to clean:

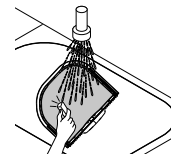

- 1 Use hot soapy water and a stiff brush to clean the filter.
- 2 Make sure the filter is completely dry before reinstalling it and using the dryer.

**NOTE:** NEVER operate the dryer with a wet lint filter.

### MAINTAINING THE EXHAUST SYSTEM

The most common cause of dryer problems is poor exhaust venting. Poor exhaust venting may result from the following conditions:

- DIRTY OR DAMAGED EXHAUST DUCTS
- WRONG VENT MATERIAL
- RESTRICTED OR DAMAGED VENT HOOD
- EXCESSIVELY LONG VENT
- THE USE OF PLASTIC OR FOIL VENTING

#### Maintaining the Exhaust System

Vent ducts should be checked for lint buildup and cleaned at least once per year. If any noticeable reduction in drying performance occurs, check the ducts for obstructions and blockages.

If the CHECK VENT indicator illuminates, the exhaust system should be checked immediately for damage or obstructions. The CHECK VENT indicator signals a serious reduction in exhaust airflow which will greatly reduce energy efficiency and increase drying times. Damaged or restricted exhaust systems are not covered by the dryer warranty. Damage to the dryer that is caused by damaged, restricted, or otherwise inadequate exhaust systems is not covered by the dryer warranty.

#### CHECK VENT Indicator

The CHECK VENT warning system is designed to help you avoid the reduced performance caused by restrictions in the household exhaust system. The CHECK VENT indicator illuminates to alert you when problems in the system occur, so you can have them repaired.

While you should always check and maintain your exhaust system regularly, the CHECK VENT warning system will detect and alert you if serious problems develop in your home's exhaust system. This includes exhaust systems that are unsatisfactory for any reason including a blockage in the venting, crushed/kinked venting, or venting which exceeds the maximum recommended length requirement as described in the installation section.

**NOTE:** The total length includes the length from the back of the dryer to the outside vent hood, PLUS a factor for every 90° elbow in the exhaust system. For example, if the distance from the back of the dryer to the vent hood is 30 feet, and there are four elbows in the system, then it exceeds the 28 foot maximum length allowed for those conditions.

The CHECK VENT indicator on the control panel will alert you that the exhaust system is not moving enough air from the dryer to the outside. This lack of airflow will lead to long dry times, poor drying and possibly dryer failure.

As a reminder, external dryer venting is considered part of your home and is not covered by the product warranty or protection agreements. There are services available for cleaning/maintaining the external venting.

#### CHECK VENT Operation

The CHECK VENT system uses components already in the dryer. By monitoring these components over the course of several cycles, the control is able to determine how much restriction there is in the exhaust system. If it detects a high level of restriction, it will turn on the CHECK VENT light to alert you to the condition. The dryer will continue to operate after the light comes on, but you should have the exhaust system cleaned or repaired immediately to avoid longer dry times and higher energy consumption.

**IMPORTANT:** In order for a dryer to properly and efficiently dry your clothes, it is extremely important that the exhaust system is as short and clean as possible. It **MUST** be less than the maximum installation requirements as outlined in the installation section. It is also very important that you make sure that when the dryer is installed, the exhaust system is clean and clear of any restrictions and is not kinked or crushed.

Failure to meet these guidelines will result in long dry times, increased energy consumption and possibly even clothing damage or dryer failure. When exhaust system restrictions become extreme, the CHECK VENT light will blink to alert you to the condition so you can have the exhaust system cleaned or repaired.

- 1 To prevent false alarms and for increased reliability, the dryer will monitor the exhaust condition for several loads. If multiple, consecutive cycles exceed the restriction limits, the control will blink the CHECK VENT indicator.
- 2 A blinking CHECK VENT indicator means the external venting should be checked for potential restrictions as soon as possible.
- 3 The CHECK VENT indicator will remain active (blinking) until the restriction is resolved AND the control has verified the improved airflow for several cycles.
- 4 After the exhaust is cleaned or repaired, it will take several cycles for the CHECK VENT indicator to reset and turn off the light.

**NOTE:** The CHECK VENT indicator is designed to measure performance over several consecutive cycles before activating or deactivating, to avoid false alarms. A very large load, such as a large comforter, could cause the CHECK VENT system to sense that the exhaust system is restricted, but this would not cause the light to blink. However, if several large loads were to run back to back, the CHECK VENT indicator could be activated.

## DIAGNOSTICS

Should you experience any problems with your dryer, it has the capability of transmitting data via your telephone to the Diagnostics Team. This gives you the capability of speaking directly to our specially trained technicians. The technician records the data transmitted from your machine and uses it to analyze the issue, providing a fast and effective diagnosis.

If you experience problems with your dryer, call 1-844-553-6667. Only use the Diagnostics feature when instructed to do so by the Diagnostics Team. The transmission sounds that you will hear are normal and sound similar to a fax machine.

Diagnostics cannot be activated unless your dryer is turned on by pressing the POWER button. If your dryer is unable to turn on, then troubleshooting must be done without using Diagnostics.

### Using Diagnostics

First, call 1-844-553-6667. If the number of the phone you are using is on file and is associated with your dryer, you will be quickly relayed to a Diagnostics Team agent. Follow the technician's instructions and perform the following steps only when requested to by the Diagnostics Team agent.

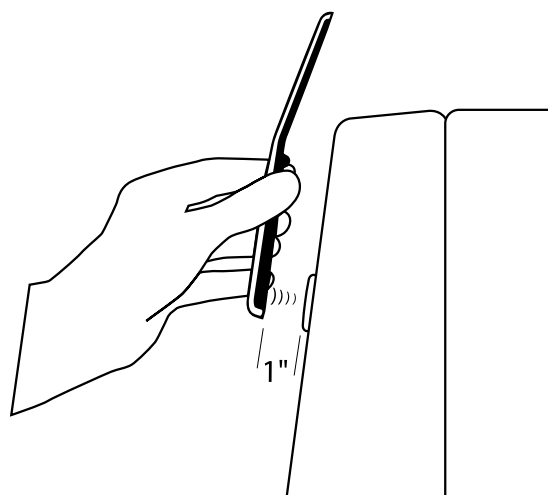
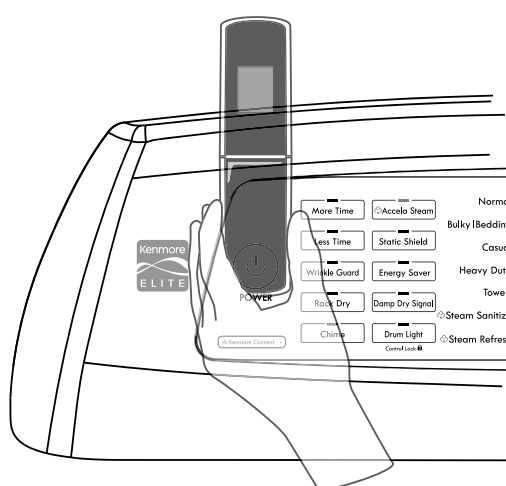

**HOLD** the mouthpiece of your phone over the POWER button, when instructed to do so by the call center, no more than one inch from (but not touching) the machine.

**NOTE:** Do not press any other buttons or turn the cycle selector knob.



**PUSH** and hold the TEMP button while continuing to hold your phone to the POWER button.



**LISTEN** for two beeps. After you hear the two beeps, release the TEMP button. Keep the phone in place until the tone transmission has finished. The display will count down the time. Once the countdown is over and the tones have stopped, resume your conversation with the technician, who will then be able to assist you in using the information transmitted for analysis.

**NOTE:**

- For best results, do not move the phone while the tones are being transmitted.
- If the call center agent is not able to get an accurate recording of the data, you may be asked to try again.
- Pressing the POWER button during the transmission will shut off Diagnostics.

## TROUBLESHOOTING GUIDE

### FAQs

**Q: When I press a button, why does my dryer beep and then nothing happens?**

**A:** The Control Lock feature is turned on. To turn off Control Lock, turn the dryer on, then press and hold the button that has \*Control Lock on or under it for 5 seconds.

**Q: Why does my dryer take so long to dry clothes?**

**A:** Proper airflow is critical to the efficient operation of clothes dryers. A lint filter which is full of lint or clogged with fabric softener sheet residue can reduce the airflow to the point that the time required to dry clothing will be greatly increased. Another factor affecting dry time is your home exhaust system. An exhaust system which is dirty and clogged with lint, or is excessively long, needs to be professionally cleaned or repaired.

**Q: Why does my dryer start by itself every few minutes?**

**A:** This is how the Wrinkle Guard feature works. The dryer runs briefly every few minutes for up to 3 hours after the cycle finishes. This feature is designed to help prevent wrinkles from setting in when the dryer is not unloaded immediately after the cycle is finished.

**Q: Why does my dryer show 3 minutes when I select the Steam Refresh cycle?**

**A:** When the Steam Refresh cycle is selected, the dryer displays the number of garments rather than the estimated cycle time, until the cycle is started. Use the MORE TIME or LESS TIME buttons to adjust the load size setting for the number of garments you desire. For a large load or single bulky item use the *bl 9* (big) setting.

### BEFORE CALLING FOR SERVICE

Problem	Possible Cause	Solutions
<p><b>*CHECK VENT indicator is blinking</b>                      * This warning light is not a dryer failure and is not covered by the dryer warranty. Contact a duct cleaning service to have your exhaust system cleaned and inspected.</p>	<p>Exhaust system is too long or has too many turns/restrictions.</p> <p>Partial blockage of the ductwork due to lint buildup or other foreign object.</p> <p>The appliance has detected a restriction in the external dryer venting.</p>	<p>Install a shorter or straighter duct run. See the Installation Instructions for details.</p> <p>Ductwork should be checked/cleaned immediately. Dryer can be used in this condition, but drying times will be longer and energy consumption will increase.</p> <p>See the CHECK VENT INDICATOR and CHECK VENT OPERATION sections for details regarding this function.</p>
<p><b>The display shows d80, d90, or d95</b></p>	<p>The ductwork is about 80%-95% blocked. These error codes are only displayed for 2 hours.</p>	<p>Do not use the dryer until the exhaust system has been cleaned and/or repaired. Using the dryer with a severely restricted exhaust is dangerous and could result in a fire or other property damage.</p> <p>Check the outside dryer vent while the dryer is operating to make sure there is strong airflow.</p> <p>If the exhaust system is extremely long, have it repaired or rerouted.</p> <p>Keep the area around the dryer clean and free of clutter.</p> <p>Check vent hood for damage or lint clogging.</p> <p>Make sure the area around the vent hood is clear.</p>
<p><b>The CHECK VENT indicator remains active (blinking) after clearing the restriction in the venting.</b></p>	<p>After clearing the restriction, the CHECK VENT system requires multiple, consecutive cycles to determine that the performance value has improved before the CHECK VENT indicator is reset.</p>	<p>If the CHECK VENT indicator remains active for more than five cycles after the restriction has been cleared, call for service.</p>



**BEFORE CALLING FOR SERVICE (continued)**

Problem	Possible Cause	Solutions
<b>Dryer will not turn on</b>	Power cord is not properly plugged in. House fuse is blown, circuit breaker has tripped, or power outage has occurred.	Make sure that the plug is securely plugged into a grounded outlet matching the dryer's rating plate. Reset circuit breaker or replace fuse. Do not increase fuse capacity. If the problem is a circuit overload, have it corrected by a qualified electrician.
<b>Buttons are disabled or CL shows in display</b>	CONTROL LOCK function is engaged.	Press and hold the DRUM LIGHT button for three seconds to activate or deactivate the function.
<b>Error code: tE1 through tE7</b>	Temperature sensor failure.	Turn off the dryer and call for service.
<b>Display shows error code PS (electric dryers only)</b>	Power cord is connected incorrectly.	White (N) and red (L2) wires on power cord. Check power cord connections for neutral connection on the center terminal. 240 volts applied to the control, so it will protect itself.
<b>Display shows error code nP or gAS</b>	Power cord connection is incorrect. Gas supply or service turned off (gas models only).	Check the connection of power cord to terminal block. Confirm that house gas shutoff and dryer gas shutoff are both fully open.
<b>Light does not turn on when door is opened</b>	Dryer has been off for more than four minutes and light is disabled.	Press the POWER button to turn on the dryer, which will enable the drum light.
<b>Dryer does not heat</b>	House fuse is blown, circuit breaker has tripped, or power outage has occurred.  Gas supply or service is turned off (gas models only).	Reset circuit breaker or replace fuse. Do not increase fuse capacity. If the problem is a circuit overload, have it corrected by a qualified electrician. <b>NOTE:</b> Due to the design of electric dryers, it is possible for a circuit problem to allow an electric dryer to run without heat. Confirm that the house gas shutoff and the dryer gas shutoff valves are both fully open. Even if gas is not supplied to the dryer, it will run and no error codes will display. Verify that other gas appliances in the home are working normally.
<b>Greasy or dirty spots on clothes</b>	Clean and dirty clothes are being dried together.  Clothes were not properly cleaned or rinsed before being placed in the dryer.	Only use your dryer to dry clean items. Soil from dirty clothes can transfer to the clean clothes in the same or later loads.  Stains on dried clothes could be stains that weren't removed during the washing process. Make sure that clothes are being completely cleaned or rinsed according to the instructions for your washer and detergent. Some difficult soils may require pre-treating prior to washing.
<b>Lint on clothes</b>	Lint filter not cleaned properly.  Laundry not sorted properly.  Excess static in clothes.  Dryer is overloaded.  Tissue, paper, etc., left in pockets.	Remove the lint from the filter before every load. With the lint removed, hold the filter up to a light to see if it is dirty or clogged. If it looks dirty, follow the cleaning instructions. With some loads that produce high amounts of lint, it may be necessary to clean the filter during the cycle.  Some fabrics are lint producers (i.e., a fuzzy white cotton towel) and should be dried separately from clothes that are lint trappers (i.e., a pair of black linen pants).  Use a fabric softener to reduce static electricity. Be sure to follow the manufacturer's instructions. Over drying a load of laundry can cause a buildup of static electricity. Adjust settings and use a shorter drying time, or use AUTO DRY cycles.  Divide extra large loads into smaller loads for drying.  Check pockets thoroughly before washing and drying clothes.

## TROUBLESHOOTING GUIDE

### BEFORE CALLING FOR SERVICE (continued)

Problem	Possible Cause	Solutions
<p><b>Drying time is not consistent</b></p>	<p>Heat settings, load size, or dampness of clothing is not consistent.</p>	<p>The drying time for a load will vary depending on the type of heat used (electric, natural gas, or LP gas), the size of the load, the type of fabrics, the wetness of the clothes, and the condition of the exhaust duct and lint filter. Even an unbalanced load in the washer can cause poor spinning, resulting in wetter clothes which will take longer to dry.</p>
<p><b>Clothes take too long to dry</b></p>	<p>Exhaust ducts are blocked, dirty, or duct run is too long.</p> <p>Load is not properly sorted.</p> <p>Large load of heavy fabrics.</p> <p>Dryer controls are not set properly.</p> <p>Lint filter needs to be cleaned.</p> <p>House fuse is blown, circuit breaker has tripped, or power outage has occurred.</p> <p>Dryer is overloaded.</p> <p>Dryer is under loaded.</p>	<p>Confirm that the exhaust duct is properly configured and free of debris, lint, and obstructions. Make sure that outside wall dampers can open properly and are not blocked, jammed, or damaged.</p> <p>Separate heavy items from lightweight items. Larger and heavier items take longer to dry. Light items in a load with heavy items can fool the sensor because the light items dry faster.</p> <p>Heavy fabrics take longer to dry because they tend to retain more moisture. To help reduce and maintain more consistent drying times for large and heavy fabrics, separate these items into smaller loads of a consistent size.</p> <p>Use the appropriate control settings for the type of load you are drying. Some loads may require an adjustment of the DRY LEVEL setting for proper drying.</p> <p>Remove the lint from the filter before every load. With the lint removed, hold the filter up to a light to see if it is dirty or clogged. If it looks dirty, follow the cleaning instructions on. With some loads that produce high amounts of lint, such as new bath towels, it may be necessary to pause the cycle and clean the filter during the cycle.</p> <p>Reset circuit breaker or replace fuse. Do not increase fuse capacity. If the problem is a circuit overload, have it corrected by a qualified electrician.</p> <p><b>NOTE:</b> Due to the design of electric dryers, it is possible for a circuit problem to allow an electric dryer to run without heat.</p> <p>Divide extra large loads into smaller loads for better drying performance and efficiency.</p> <p>If you are drying a very small load, add a few extra items to ensure proper tumbling action. If the load is very small and you are using AUTO DRY cycles, the electronic control cannot properly sense the dryness of the load and may shut off too soon. Use TIMED DRY or add some extra wet clothes to the load.</p>

Problem	Possible Cause	Solutions
<b>Clothes are wrinkled</b>	<p>Clothes dried too long (over dried).</p> <p>Clothes left in dryer too long after cycle ends.</p>	<p>Over drying a load of laundry can lead to wrinkled clothes. Try a shorter drying time or LESS DRY setting and remove items while they still retain a slight amount of moisture.</p> <p>Use the WRINKLE GUARD option. This feature will tumble the clothes briefly every few minutes for up to 150 minutes to help prevent wrinkling.</p>
<b>Clothes are shrinking</b>	<p>Garment care instructions are not being followed.</p>	<p>To avoid shrinking your clothes, always consult and follow fabric care instructions. Some fabrics will naturally shrink when washed. Other fabrics can be washed but will shrink when dried in a dryer. Use a low or no heat setting.</p>
<b>Excess static in clothes after drying</b>	<p>Fabric softener is not used or used incorrectly.</p> <p>Clothes dried too long (over dried).</p> <p>Drying synthetics, permanent press, or synthetic blends.</p>	<p>Use a fabric softener or the STATIC SHIELD option, if equipped, to reduce static electricity. Be sure to follow the manufacturer's instructions.</p> <p>Over drying a load of laundry can cause a buildup of static electricity. Adjust settings and use a shorter drying time, or use AUTO DRY cycles. Select a LESS DRY setting on AUTO DRY cycles, if necessary.</p> <p>These fabrics are naturally more prone to static buildup. Try using fabric softener, or use LESS DRY and/or shorter TIMED DRY time settings.</p>
<b>Steam Features Not Working</b>	<p>Water drips from nozzle when steam cycle starts.</p> <p>Steam is not visible during steam cycle.</p> <p>Steam is not generated and no error code is displayed.</p> <p>Garments are still wrinkled at the end of the STEAM REFRESH cycle.</p> <p>Creases or pleats are gone from garments after Steam Refresh.</p> <p>Garments have static after using the Static Shield option.</p> <p>Garments are too damp or too dry after using Static Shield option.</p> <p>Water drips down the door during steam cycles.</p> <p>Drum does not turn during steam cycles.</p> <p>Cannot see steam vapor at the beginning of the cycle.</p> <p>Odors are not completely removed at the end of the STEAM REFRESH cycle.</p>	<p>This is normal steam condensation. The dripping water will stop after a short time.</p> <p>This is normal. Check for condensation on the inside of the door during the steam portion of the cycle. Steam is not directly visible.</p> <p>Water level error. Unplug the dryer and call for service.</p> <p>Load only one to five garments (or a single bulky item). Do not mix fabric types. STEAM REFRESH is most effective on 70/30 cotton/polyblends. Do not use on 100% cotton items.</p> <p>This cycle removes wrinkles from fabric. Use an iron to replace creases and pleats in garments.</p> <p>The amount of static that builds up when wearing garments depends on the individual moisture level in the skin.</p> <p>Select the load weight manually before starting the Static Shield option.</p> <p>Steam is invisible. However, under some conditions, the condensed fog may be seen, or condensation will form on the inside of the door glass and may be seen dripping down the glass.</p> <p>The drum is turned off so that the steam vapor remains in the drum. The drum will turn for only a few seconds, once a minute.</p> <p>Steam is released at different stages of the cycle for each option. Steam cannot be seen, but condensation may form on the inside of the door when steam is being generated.</p> <p>Some odors are difficult to remove. Fabrics containing certain difficult odors or very strong odors may not refresh well and should be washed or dry cleaned instead.</p>

### **Kenmore Elite Limited Warranty**

FOR ONE YEAR from the date of sale this appliance is warranted against defects in material or workmanship when it is correctly installed, operated and maintained according to all supplied instructions.

WITH PROOF OF SALE, a defective appliance will receive free repair or replacement at option of seller.

For warranty coverage details to obtain free repair or replacement, visit the web page:  
[www.kenmore.com/warranty](http://www.kenmore.com/warranty)

This warranty applies for only 90 DAYS from the sale date in the United States if this appliance is ever used for other than private household purposes.

**This warranty covers ONLY defects in material and workmanship, and will NOT pay for:**

1. Expendable items that can wear out from normal use, including but not limited to filters, belts, bags or screw-in base light bulbs.
2. A service technician to clean or maintain this appliance, or to instruct the user in correct appliance installation, operation and maintenance.
3. Service calls to correct appliance installation not performed by Sears authorized service agents, or to repair problems with house fuses, circuit breakers, house wiring, and plumbing or gas supply systems resulting from such installation.
4. Damage to or failure of this appliance resulting from installation not performed by Sears authorized service agents, including installation that was not in accord with electrical, gas or plumbing codes.
5. Damage to or failure of this appliance, including discoloration or surface rust, if it is not correctly operated and maintained according to all supplied instructions.
6. Damage to or failure of this appliance, including discoloration or surface rust, resulting from accident, alteration, abuse, misuse or use for other than its intended purpose.
7. Damage to or failure of this appliance, including discoloration or surface rust, caused by the use of detergents, cleaners, chemicals or utensils other than those recommended in all instructions supplied with the product.
8. Damage to or failure of parts or systems resulting from unauthorized modifications made to this appliance.
9. Service to an appliance if the model and serial plate is missing, altered, or cannot easily be determined to have the appropriate certification logo.

### **Disclaimer of implied warranties; limitation of remedies**

Customer's sole and exclusive remedy under this limited warranty shall be product repair or replacement as provided herein. Implied warranties, including warranties of merchantability or fitness for a particular purpose, are limited to one year or the shortest period allowed by law. Seller shall not be liable for incidental or consequential damages. Some states and provinces do not allow the exclusion or limitation of incidental or consequential damages, or limitation on the duration of implied warranties of merchantability or fitness, so these exclusions or limitations may not apply to you.

This warranty applies only while this appliance is used in the United States.

This warranty gives you specific legal rights, and you may also have other rights which vary from state to state.

**Sears Brands Management Corporation, Hoffman Estates, IL 60179**







# Kenmore®

## Customer Care Hotline

To schedule in-home repair service  
or order replacement parts

Para pedir servicio de reparación  
a domicilio, y ordenar piezas

# 1-844-553-6667

[www.kenmore.com](http://www.kenmore.com)

