

Use & Care Guide Guide d'utilisation et d'entretien

Electronic Dryer Sécheuse électronique

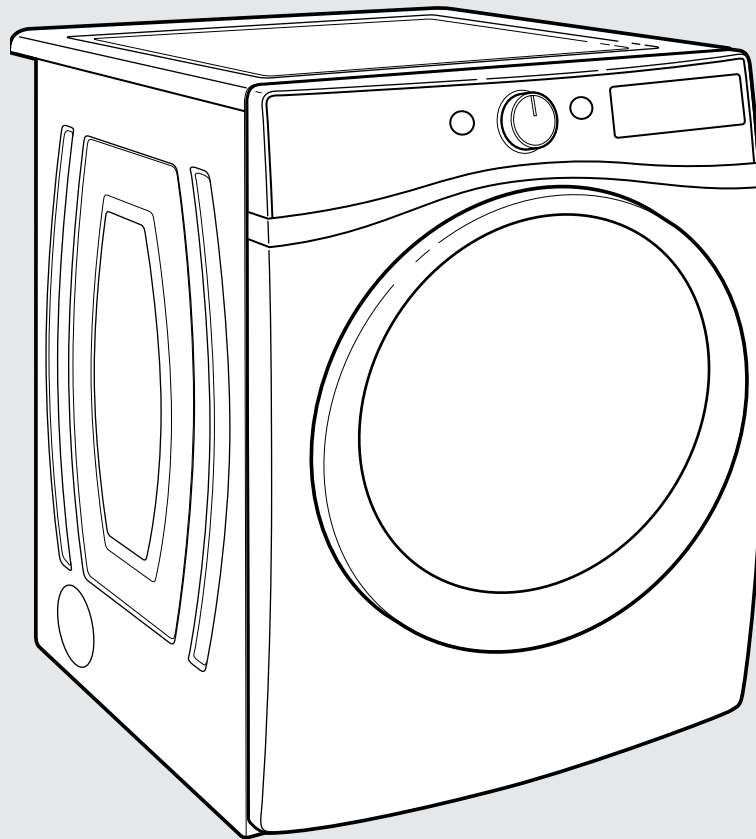

If you have any problems or questions, visit us at www.crosley.com
Pour tout problème ou question, consulter www.crosley.com

Table of Contents

DRYER SAFETY	2
ACCESSORIES	4
CHECK YOUR VENT SYSTEM FOR GOOD AIRFLOW.....	5
CONTROL PANEL AND FEATURES.....	6
CYCLE GUIDE.....	7
USING YOUR DRYER	8
CYCLE STATUS INDICATORS.....	10
ADDITIONAL FEATURES	10
DRYER CARE	11
TROUBLESHOOTING	13
WARRANTY.....	16
ASSISTANCE OR SERVICE.....	Back Cover

Table de matières

SÉCURITÉ DE LA SÈCHEUSE	17
ACCESSOIRES	19
VÉRIFICATION D'UNE CIRCULATION D'AIR ADÉQUATE POUR LE SYSTÈME D'ÉVACUATION	20
TABLEAU DE COMMANDE ET CARACTÉRISTIQUES	21
GUIDE DES PROGRAMMES.....	23
UTILISATION DE LA SÈCHEUSE	25
TÉMOINS LUMINEUX DE PROGRAMME	27
CARACTÉRISTIQUES SUPPLÉMENTAIRES.....	28
ENTRETIEN DE LA SÈCHEUSE	29
DÉPANNAGE	31
GARANTIE.....	35
ASSISTANCE OU SERVICE.....	Couverture arrière

Dryer Safety

Your safety and the safety of others are very important.

We have provided many important safety messages in this manual and on your appliance. Always read and obey all safety messages.



This is the safety alert symbol.

This symbol alerts you to potential hazards that can kill or hurt you and others.

All safety messages will follow the safety alert symbol and either the word "DANGER" or "WARNING."
These words mean:

! DANGER

You can be killed or seriously injured if you don't immediately follow instructions.

! WARNING

You can be killed or seriously injured if you don't follow instructions.

All safety messages will tell you what the potential hazard is, tell you how to reduce the chance of injury, and tell you what can happen if the instructions are not followed.



WARNING - "Risk of Fire"

- Clothes dryer installation must be performed by a qualified installer.
- Install the clothes dryer according to the manufacturer's instructions and local codes.
- Do not install a clothes dryer with flexible plastic venting materials or flexible metal (foil type) duct. If flexible metal duct is installed, it must be of a specific type identified by the appliance manufacturer as suitable for use with clothes dryers. Flexible venting materials are known to collapse, be easily crushed, and trap lint. These conditions will obstruct clothes dryer airflow and increase the risk of fire.
- To reduce the risk of severe injury or death, follow all installation instructions.
- Save these instructions.

State of California Proposition 65 Warnings:

WARNING: This product contains one or more chemicals known to the State of California to cause cancer.

WARNING: This product contains one or more chemicals known to the State of California to cause birth defects or other reproductive harm.

In the State of Massachusetts, the following installation instructions apply:

- Installations and repairs must be performed by a qualified or licensed contractor, plumber, or gasfitter qualified or licensed by the State of Massachusetts.
- If using a ball valve, it shall be a T-handle type.
- A flexible gas connector, when used, must not exceed 3 feet.

 **WARNING:**

FIRE OR EXPLOSION HAZARD

Failure to follow safety warnings exactly could result in serious injury, death or property damage.

– Do not store or use gasoline or other flammable vapors and liquids in the vicinity of this or any other appliance.

– WHAT TO DO IF YOU SMELL GAS:

- **Do not try to light any appliance.**
- **Do not touch any electrical switch; do not use any phone in your building.**
- **Clear the room, building, or area of all occupants.**
- **Immediately call your gas supplier from a neighbor's phone. Follow the gas supplier's instructions.**
- **If you cannot reach your gas supplier, call the fire department.**

– Installation and service must be performed by a qualified installer, service agency, or the gas supplier.

WARNING: Gas leaks cannot always be detected by smell.

Gas suppliers recommend that you use a gas detector approved by UL or CSA.

For more information, contact your gas supplier.

If a gas leak is detected, follow the “What to do if you smell gas” instructions.

IMPORTANT: The gas installation must conform with local codes, or in the absence of local codes, with the National Fuel Gas Code, ANSI Z223.1/NFPA 54, or the Natural Gas and Propane Installation Code, CSA B149.1.

The dryer must be electrically grounded in accordance with local codes, or in the absence of local codes, with the National Electrical Code, ANSI/NFPA 70, or the Canadian Electrical Code, Part 1, CSA C22.1.

IMPORTANT: When discarding or storing your old clothes dryer, remove the door.

IMPORTANT SAFETY INSTRUCTIONS

WARNING: To reduce the risk of fire, electric shock, or injury to persons when using the dryer, follow basic precautions, including the following:

- Read all instructions before using the dryer.
- Do not place items exposed to cooking oils in your dryer. Items contaminated with cooking oils may contribute to a chemical reaction that could cause a load to catch fire.
- Do not dry articles that have been previously cleaned in, washed in, soaked in, or spotted with gasoline, dry-cleaning solvents, or other flammable or explosive substances as they give off vapors that could ignite or explode.
- Do not allow children to play on or in the dryer. Close supervision of children is necessary when the dryer is used near children.
- Before the dryer is removed from service or discarded, remove the door to the drying compartment.
- Do not reach into the dryer if the drum is moving.
- Do not install or store the dryer where it will be exposed to the weather.
- Do not tamper with controls.
- Do not repair or replace any part of the dryer or attempt any servicing unless specifically recommended in this Use and Care Guide or in published user-repair instructions that you understand and have the skills to carry out.
- Do not use fabric softeners or products to eliminate static unless recommended by the manufacturer of the fabric softener or product.
- Do not use heat to dry articles containing foam rubber or similarly textured rubber-like materials.
- Clean lint screen before or after each load.
- Keep area around the exhaust opening and adjacent surrounding areas free from the accumulation of lint, dust, and dirt.
- The interior of the dryer and exhaust vent should be cleaned periodically by qualified service personnel.
- See “Electrical Requirements” located in the installation instructions for grounding instructions.

SAVE THESE INSTRUCTIONS

Accessories

INSTALLATION & MAINTENANCE ACCESSORIES

FACTORY CERTIFIED PARTS – these three words represent quality parts and accessories designed specifically for your appliance. Time tested engineering that meets our strict quality specifications.

FACTORY CERTIFIED PARTS

Accessories designed for your appliance:

Enhance your dryer with these premium accessories.

For more high-quality items or to order, call **1-800-901-2042**, or visit us at **www.applianceaccessories.com**. In Canada, call **1-800-807-6777** or visit us at **www.whirlpoolparts.ca**.

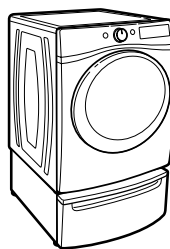

15" Pedestal

Color-matched pedestals raise the washer and dryer to a more comfortable working height. The large drawer provides convenient storage.

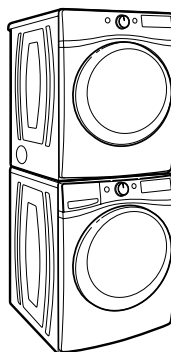

Stack Kit

If space is at a premium, the stack kit allows the dryer to be installed on top of the washer.

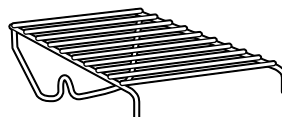

Drying Rack

The Drying Rack provides a stationary drying surface for items such as sweaters and tennis shoes. See the “Additional Features” section for more information.

Check Your Vent System for Good Airflow

⚠ WARNING



Fire Hazard

Use a heavy metal vent.

Do not use a plastic vent.

Do not use a metal foil vent.

Failure to follow these instructions can result in death or fire.

Good airflow

Along with heat, dryers require good airflow to efficiently dry laundry. Proper venting will reduce your drying times and improve your energy savings. See Installation Instructions.

The venting system attached to the dryer plays a big role in good airflow.

Service calls caused by improper venting are not covered by the warranty and will be paid for by the customer, regardless of who installed the dryer.

Maintain good airflow by:

■ Cleaning your lint screen before each load.

■ Replace plastic or foil vent material with 4" (102 mm) diameter heavy, rigid vent material.

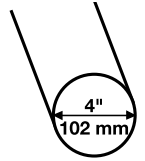

■ Use the shortest length of vent possible.

■ Use no more than four 90° elbows in a vent system; each bend and curve reduces airflow.

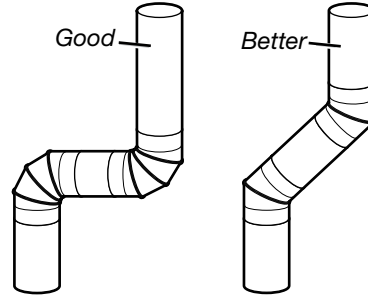

■ Remove lint and debris from the exhaust hood.

■ Remove lint from the entire length of the vent system at least every 2 years. When cleaning is complete, be sure to follow the Installation Instructions supplied with your dryer for final product check.

■ Clear away items from the front of the dryer.

Use Automatic Cycles for better fabric care and energy savings

Use the Automatic Cycles to provide the most energy savings and enhanced fabric care from the dryer. During Automatic Cycles, drying air temperature and moisture level are sensed in the load. This sensing occurs throughout the drying cycle and the dryer shuts off when the load reaches the selected dryness. Use the NORMAL dryness level to provide optimal energy savings.

With Timed Dry, the dryer runs the amount of time set and sometimes results in shrinkage, wrinkling, and static due to over-drying. Use Timed Dry for the occasional damp load that needs a little more drying time or when using the drying rack.

Control Panel and Features

Not all features and cycles are available on all models.

NOTE: The control panel features a sensitive surface that responds to a light touch of your finger. To ensure your selections are registered, touch the control panel with your finger tip, not your fingernail. When selecting a setting or option, simply touch its name.

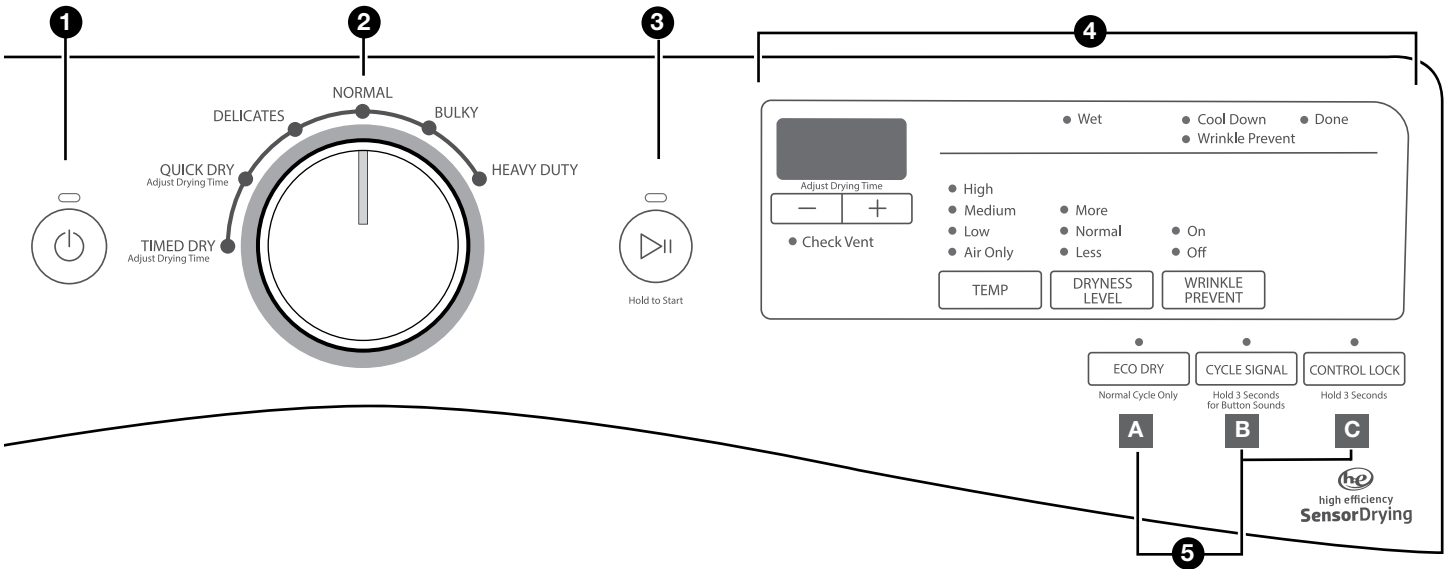

1 POWER
Touch to turn the dryer on and off. Touch to stop/cancel a cycle at any time.

2 CYCLE CONTROL KNOB
Turn the knob to select a cycle for your laundry load. Automatic Cycles are Heavy Duty, Normal, Bulky, and Delicates. Manual Cycles are Quick Dry and Timed Dry. See “Cycle Guide” for detailed descriptions of cycles.

3 START/PAUSE
Touch and hold until the LED comes on to start a cycle, or touch once while a cycle is in process to pause it.

4 LED DISPLAY AND SETTINGS
When you select a cycle, its settings will light up and the estimated time remaining (for Automatic Cycles) or actual time remaining (for Manual Cycles) will be displayed. On 2-digit displays, for times longer than 99 minutes, hours will be displayed followed by minutes.
See “Cycle Guide” for available settings on each cycle. Not all settings are available with all cycles.

Cycle Status Lights

The indicators at the top of the display will let you know what stage of the drying cycle is in process. For more information on each stage, see “Cycle Status Indicators.”

-/+ (Adjust Drying Time)

Touch “+” or “-” with Manual Cycles to increase or decrease the length of a Timed Dry or Quick Dry cycle.

Temp

When using Manual Cycles, you may select a dry temperature based on the type of load you are drying. Use the warmest setting safe for the garments in the load. Follow garment label instructions.

NOTE: Automatic Cycles use a preset temperature that is not adjustable.

Dryness Level

When using Automatic Cycles, you may select a Dryness Level based on the type of load you are drying.

NOTE: Dryness Level is for use with Automatic Cycles only.

Wrinkle Prevent Option

If you will be unable to remove a load immediately, touch Wrinkle Prevent to add up to 140 minutes of periodic tumbling to help reduce wrinkling.

5 OPTIONS
Use to select available options for your dryer.

A Eco Dry Option
Touch to activate the Eco Dry option, which allows you to increase your energy savings by using a slightly lower heat level. The Eco Dry option will increase drying times by approximately 40 minutes; the LED Display will reflect this time.

The Eco Dry option is only available for Normal. For optimal energy turn on the Eco Dry option. For optimal time turn off the Eco Dry option.

NOTE: Energy savings may vary across loads.

B Cycle Signal
Use this to turn the signal indicating the end of a drying cycle on or off.

NOTE: You may also turn off the tones that sound when a feature, setting, or option is touched. Touch and hold Cycle Signal for about one second to turn sounds on or off.

C Control Lock
Use to lock the controls of the dryer and avoid an accidental change in cycle options or preferences during a drying cycle.

Touch and hold CONTROL LOCK for 3 seconds to lock or unlock the controls of the dryer. During this time, the LED Display will count down 3-2-1. Once the controls are locked, the LED Display will display “Lc” or “Loc.”

NOTE: The Control Lock function may be enabled when recovering from a power failure. To unlock the control, touch and hold CONTROL LOCK for at least 3 seconds.

Cycle Guide – Automatic Cycles



Settings and options shown in **bold** are default settings for that cycle.

If settings are changed, the new settings will be remembered. If there is a power failure, settings will return to the default.

Use Automatic Cycles for better fabric care and energy savings

The dryer senses moisture in the load or air temperature and shuts off when the load reaches the selected dryness level.

Use the **NORMAL** dryness level to provide optimal energy savings.

Items to dry:	Cycle:	Drying Temperature:	Dryness Level:	Default Time:	Available Options:	Cycle Details:
Work clothes, casual wear, mixed cottons, sheets, corduroys	Normal	Medium	More Normal Less	78	Wrinkle Prevent Eco Dry	 Uses Medium heat to dry large loads of mixed fabrics and items. Normal is the preferred energy cycle.
Jackets, comforters, pillows	Bulky	Medium	More Normal Less	55	Wrinkle Prevent	 Use for drying large, bulky items; do not overfill dryer drum. Partway through the cycle, the signal will sound to indicate when it is time to rearrange items for optimal drying.
Heavyweight items such as towels or heavy work clothes	Heavy Duty	High	More Normal Less	45	Wrinkle Prevent	 Offers stepped drying starting with High heat followed by Medium heat for enhanced fabric care and energy savings.
Undergarments, blouses, lingerie, performance wear	Delicates	Low	More Normal Less	28	Wrinkle Prevent	 Uses Low heat to gently dry delicate items.

Cycle Guide – Manual Cycles

Settings and options shown in **bold** are default settings for that cycle.

If settings are changed, the new settings will be remembered (except on Quick Dry).

If there is a power failure, settings will return to the default.

Adjusting drying time on Timed Cycles

When you select a Timed Cycle, the time appears in the display. Use + and – to increase or decrease the time in 1-minute increments. Touch and hold to change the time in 5-minute increments.



The maximum dry time is 100 minutes.

Selecting the Drying Temperature



A High heat setting may be used for drying heavyweight items such as towels and work clothes.

A Low to Medium heat setting may be used for drying medium-weight items such as sheets, blouses, dresses, underwear, permanent press fabrics, and some knits.

Use a no heat (air only) setting for foam, rubber, plastic, or heat-sensitive fabrics.

Line dry bonded or laminated fabrics.

NOTE: If you have questions about drying temperatures for various loads, refer to the care label directions.

Items to dry:	Cycle:	Drying Temperature:	Default Time:	Available Options:	Cycle Details:
Small loads and sportswear	Quick Dry	High Medium Low Extra Air Only	26	Wrinkle Prevent	 For small loads of 3–4 items.
Any load NOTE: Select Air Only to dry foam, rubber, plastic, or heat-sensitive fabrics.	Timed Dry	High Medium Low Air Only	40	Wrinkle Prevent	 Use to dry items to a damp level for items that do not require an entire drying cycle. Select a drying temperature based on the type of fabrics in your load. If you are unsure of the temperature to select for a load, select the lower setting rather than the higher setting.

Load Size Recommendations

For best results, follow the load size recommendations noted for each cycle.

 **Small load:** Fill the dryer drum with 3–4 items, not more than 1/4 full.

 **Medium load:** Fill the dryer drum up to about 1/2 full.

 **Large load:** Fill the dryer drum up to about 3/4 full. Do not pack tightly. Items need to tumble freely.

Using Your Dryer

⚠️ WARNING



Explosion Hazard

Keep flammable materials and vapors, such as gasoline, away from dryer.

Do not dry anything that has ever had anything flammable on it (even after washing).

Failure to follow these instructions can result in death, explosion, or fire.

WARNING: To reduce the risk of fire, electric shock, or injury to persons, read the IMPORTANT SAFETY INSTRUCTIONS before operating this appliance.

1. Clean the lint screen

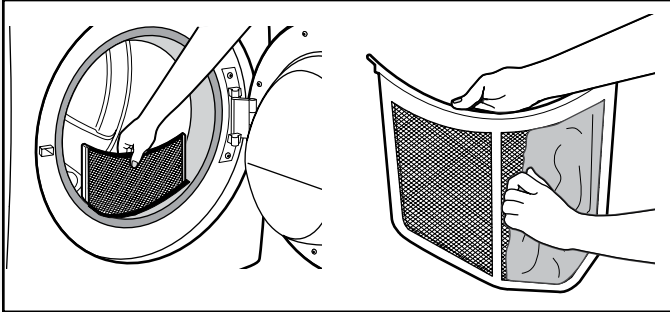

Clean the lint screen before each load. Pull the lint screen straight up. Roll lint off the screen with your fingers. Do not rinse or wash screen to remove lint. Wet lint is hard to remove. Push the lint screen firmly back into place.

For additional cleaning information, see "Dryer Care."

2. Load the dryer

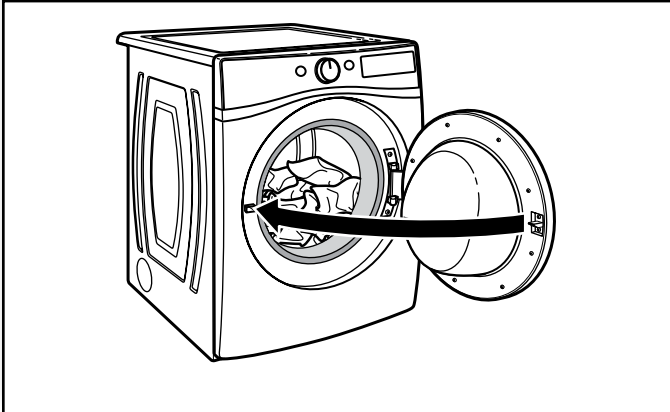

Open the door by pulling on the handle. Place laundry in the dryer. Add a dryer sheet to wet load, if desired. Close the door.

IMPORTANT: Do not tightly pack the dryer. Items need to tumble freely. Tightly packing can lead to poor drying performance and may increase wrinkling and tangling.

⚠️ WARNING



Fire Hazard

No washer can completely remove oil.

Do not dry anything that has ever had any type of oil on it (including cooking oils).

Items containing foam, rubber, or plastic must be dried on a clothesline or by using an Air Cycle.

Failure to follow these instructions can result in death or fire.

3. Touch POWER



Touch POWER to turn on the dryer.

4. Select the desired cycle

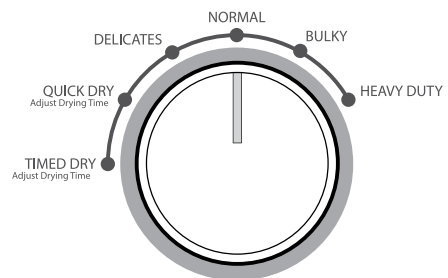

Select the desired cycle for your load. See the "Cycle Guide" for more information about each cycle.

5. Adjust cycle settings, if desired

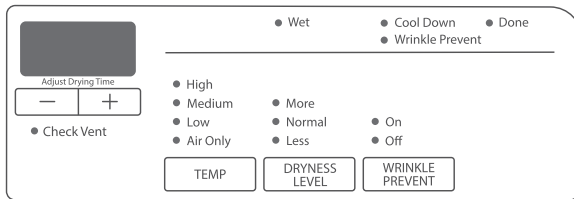

You may adjust different settings, depending on whether you have selected an Automatic Cycle, or Manual Cycle. See the “Cycle Guide” for detailed information.

NOTE: Not all options and settings are available with all cycles.

Automatic Cycles:

You can select a different dryness level, depending on your load. Touch DRYNESS LEVEL to scroll to More, Normal, or Less. Selecting More, Normal, or Less automatically adjusts the dryness level at which the dryer will shut off. Once a dryness level is set, it cannot be changed without stopping the cycle.

Automatic Cycles give the best drying in the shortest time. Drying time varies based on fabric type, load size, and dryness setting. Drying time is estimated and may change throughout the cycle. Drying time cannot be changed on Automatic Cycles.

NOTE: Automatic Cycles use a preset temperature that is not adjustable.

Manual Cycles:

When you select a Manual Cycle, the time appears in the display. Touch + and – to increase or decrease the time in 1 minute increments. Touch and hold to change the time in 5 minute increments.

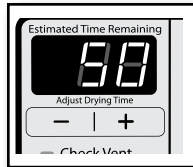

The temperature may be changed by pressing Temp until the desired dry temperature is lit. Once a cycle has started, the temperature can be changed after first pausing the cycle. Cycle time is estimated and may change throughout the cycle.

6. Select any additional options



The display will show the settings for the selected cycle. To adjust a setting, touch its name – Eco Dry, Cycle Signal, or Control Lock.

NOTE: Not all options and settings are available with all cycles.

7. Touch and hold START/PAUSE to begin cycle



Touch and hold START/PAUSE to begin the cycle.

8. Remove garments promptly after cycle is finished

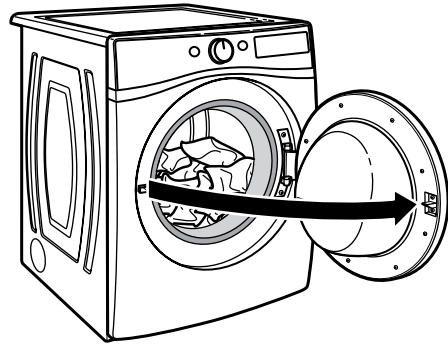

Promptly remove garments after cycle has completed to reduce wrinkling.

Changing the Automatic Cycle settings to increase or decrease drying time

If all your loads on all Automatic Cycles are consistently less dry or more dry than you would like, you may change the default settings to increase or decrease the default dryness level.

Your automatic drying settings can be adjusted to adapt to different installations, environmental conditions, or personal preference. This change is retained and will affect all of your Automatic Cycles, not just the current cycle/load. There are 5 drying settings (setting codes differ depending on model), which are displayed using the time display:

- 01/F1** Factory preset dryness level.
- 02/F2** Slightly drier clothes, 15% more drying time.
- 03/F3** Much drier clothes, 30% more drying time.
- 04/F4** Slightly wetter clothes, 15% less drying time.
- 05/F5** Much wetter clothes, 30% less drying time.

To change the drying settings:

NOTE: The settings cannot be changed while the dryer is running or paused. The dryer must be in standby mode (power is off) to adjust the default settings.

1. Before starting a cycle, touch and hold DRYNESS LEVEL for 6 seconds.
2. Touch DRYNESS LEVEL to select the dryness level shown in the time display: 01/F1, 02/F2, 03/F3, 04/F4, or 05/F5.
3. Touch START/PAUSE to save the new dryness level setting.

Cycle Status Indicators

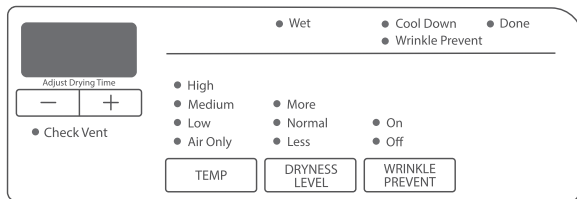

The Cycle Status Indicators show the progress of a cycle. Not all indicators are available on all models.

Check Vent

This indicator will show the status of airflow through the dryer and dryer vent system for the dryer's life. During the sensing phase at the beginning of the cycle, the Check Vent light will come on if a blocked vent or low airflow issue is detected. This light will stay on for the entire cycle. The light will be cleared when selecting a new cycle, touching POWER, or opening the door after the cycle has completed. This feature is available during Automatic cycles only. For more information on maintaining good airflow, see "Check Your Vent System for Good Airflow."

NOTE: If there are other error issues during a cycle, the Check Vent indicator will not light up. See "Troubleshooting" section.

Wet

The load is still wet and/or the cycle just started.

Cool Down

The dryer has finished drying with heat, and is now tumbling the load without heat to cool it down and reduce wrinkling.

Done

This will indicate that the selected cycle has ended and the load may be removed from the dryer. If Wrinkle Prevent option has been selected, the dryer may continue to tumble the load, even if the Done indicator is lit.

Wrinkle Prevent Option

This indicator will light if the Wrinkle Prevent option has been selected and is running. The dryer will periodically tumble the load for up to 140 minutes after the cycle has ended.

Additional Features

USING THE DRYING RACK

To purchase a drying rack for your dryer, see "Accessories" for more information. You will need your model and serial number and the purchase date. Remove and discard any packing material before use.

Use the Drying Rack for items that you do not want to tumble dry, such as sweaters and tennis shoes. When you use the drying rack, the drum continues to turn, but the rack remains stationary.

The drying rack is intended for use with the Manual Dry/Timed Dry cycles only. The drying rack cannot be used with Automatic cycles.

To use the drying rack:

IMPORTANT: Do not remove the lint screen.

1. Open dryer door.

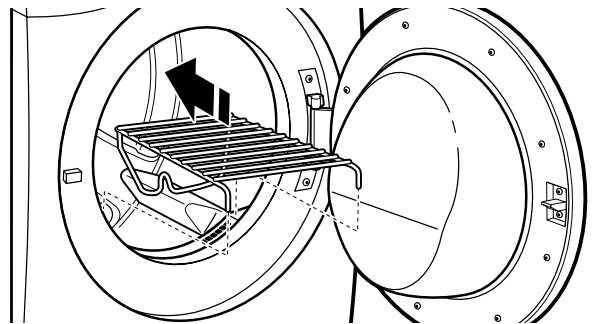

2. Align the two hooks on the front of the drying rack with the holes in the dryer door opening and press down fully into holes. Rest the rear support on the dryer back ledge.



3. Place wet items on top of the drying rack. Allow space around items for air to circulate. The drying rack does not move, but the drum will rotate; be sure to leave adequate clearance between items and the inside of the dryer drum. Make sure items do not hang over the edges or between drying rack grille.
4. Close the door.
5. Select a Timed Dry/Air Only, or Low Temperature cycle. Items containing foam, rubber, or plastic must be dried on a clothesline or by using the Air Only setting.
6. When the cycle is selected, the Estimated Time Remaining display shows the default time. You can change the actual time in the cycle by increasing or decreasing the cycle time.
7. Start the dryer.

NOTE: Check the lint screen and remove any lint accumulated from items dried on the drying rack after the cycle is finished.

Dryer Care

CLEANING THE DRYER LOCATION

Keep dryer area clear and free from items that would block the airflow for proper dryer operation. This includes clearing piles of laundry in front of the dryer.

⚠ WARNING



Explosion Hazard

Keep flammable materials and vapors, such as gasoline, away from dryer.

Place dryer at least 18 inches (460 mm) above the floor for a garage installation.

Failure to do so can result in death, explosion, or fire.

CLEANING THE DRYER INTERIOR

To clean dryer drum:

1. Use a mild hand dish detergent mixed at a low concentration with very warm water, and rub with a soft cloth.
2. Rinse well with a wet sponge or towel.
3. Tumble a load of clean clothes or towels to dry drum
OR
Use a microfiber cloth and hot water in a spray bottle to clean the drum and a second microfiber towel to dry.

NOTE: Garments that contain unstable dyes, such as denim blue jeans or brightly colored cotton items, may discolor the rear of the dryer interior. These stains are not harmful to your dryer and will not stain future loads of clothes. Dry unstable dye items inside out to avoid transfer of dye.

REMOVING ACCUMULATED LINT

From Inside the Dryer Cabinet

Lint should be removed every 2 years, or more often, depending on dryer usage. Cleaning should be done by a qualified appliance servicer.

From the Exhaust Vent

Lint should be removed every 2 years, or more often, depending on dryer usage.

CLEANING THE LINT SCREEN

Every load cleaning

The lint screen is located in the door opening of the dryer. A screen blocked by lint can increase drying time.

To clean:

1. Pull the lint screen straight up. Roll lint off the screen with your fingers. Do not rinse or wash screen to remove lint. Wet lint is hard to remove.

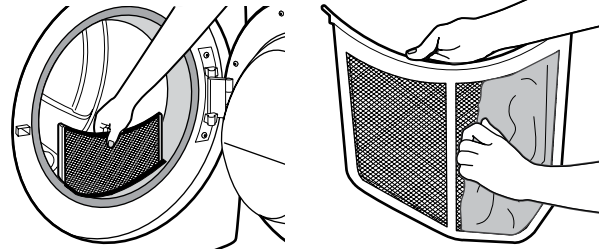

2. Push the lint screen firmly back into place.

IMPORTANT:

- Do not run the dryer with the lint screen loose, damaged, blocked, or missing. Doing so can cause overheating and damage to both the dryer and fabrics.
- If lint falls off the screen into the dryer during removal, check the exhaust hood and remove the lint. See "Venting Requirements" in the Installation Instructions.

As needed cleaning

Laundry detergent and fabric softener residue can build up on the lint screen. This buildup can cause longer drying times for your clothes, or cause the dryer to stop before your load is completely dry. The screen is probably clogged if lint falls off while the screen is in the dryer.

Clean the lint screen with a nylon brush every 6 months, or more frequently, if it becomes clogged due to a residue buildup.

To wash:

1. Roll lint off the screen with your fingers.
2. Wet both sides of lint screen with hot water.
3. Wet a nylon brush with hot water and liquid detergent. Scrub lint screen with the brush to remove residue buildup.

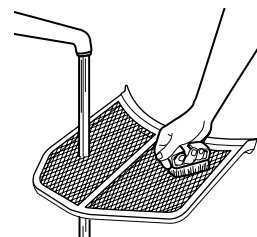

4. Rinse screen with hot water.
5. Thoroughly dry lint screen with a clean towel. Reinstall screen in dryer.

NON-USE, STORAGE, AND MOVING CARE

Non-Use or Storage Care

Operate your dryer only when you are at home. If you will be on vacation or not using your dryer for an extended period of time, you should:

1. Unplug dryer or disconnect power.
2. Clean lint screen. See "Cleaning the Lint Screen."

Moving Care

For power supply cord-connected dryers:

1. Unplug the power supply cord.
2. Gas models only: Close shut-off valve in gas supply line.
3. Gas models only: Disconnect gas supply line pipe and remove fittings attached to dryer pipe.
4. Gas models only: Cap the open gas supply line.
5. Make sure leveling legs are secure in dryer base.
6. Use tape to secure dryer door.

⚠ WARNING



Electrical Shock Hazard

Disconnect power before servicing.

Replace all parts and panels before operating.

Failure to do so can result in death or electrical shock.

For direct-wired dryers:

1. Disconnect power.
2. Disconnect wiring.
3. Make sure leveling legs are secure in dryer base.
4. Use tape to secure dryer door.

Reinstalling the Dryer

Follow the Installation Instructions to locate, level, and connect the dryer.

Troubleshooting

First try the solutions suggested here or visit our website at www.whirlpool.com/product_help –
In Canada www.whirlpool.ca for assistance and to possibly avoid a service call.

If you experience	Possible Causes	Solution
Dryer Operation		
Dryer will not run	Door not closed completely.	Make sure the dryer door is closed completely.
	START/PAUSE not touched firmly or held long enough.	Touch and hold START/PAUSE 2–5 seconds.
	Household fuse is blown or circuit breaker has tripped.	There may be 2 household fuses or circuit breakers for the dryer. Check that both fuses are intact and tight, or that both circuit breakers have not tripped. Replace the fuses or reset the circuit breaker. If the problem continues, call an electrician.
	Incorrect power supply.	Electric dryers require 240-volt power supply. Check with a qualified electrician.
	Wrong type of fuse.	Use a time-delay fuse.
Dryer will not heat	Household fuse is blown or circuit breaker has tripped.	The drum may be turning, but you may not have heat. Electric dryers use 2 household fuses or circuit breakers. Replace the fuses or reset the circuit breaker. If the problem continues, call an electrician.
	Incorrect power supply.	Electric dryers require 240-volt power supply. Check with a qualified electrician.
	Supply line valve not open.	For gas dryers, make sure that the valve on the gas supply line is open.
Unusual Noise		
Thumping noise	Dryer hasn't been used in a while.	This is due to temporary flat spots on the drum rollers. The thumping sound will diminish after a few minutes.
Rattling or vibrating noise	A small object caught between the edges of dryer drum.	Check the front and rear edges of the drum for small objects. Clean out pockets before laundering.
	Dryer isn't properly leveled.	The dryer may vibrate if not properly installed. See the Installation Instructions. All four dryer feet should be in firm contact with the floor.
	Clothing is balled up in dryer.	When balled up, the load will bounce, causing the dryer to vibrate. Separate the load items and restart the dryer.
Clicking noise	Gas valve operating.	On gas dryers, you may hear the gas valve clicking as it opens and closes. This is normal.
Loud humming or increased noise during cycle	Load is packed tightly or exhaust vent is blocked.	Reduce load size to recommended load size in "Cycle Guide." Run the dryer for 5–10 minutes. Hold your hand under the outside exhaust hood to check air movement. If you do not feel air movement or air movement is minimal, clean exhaust system of lint or replace exhaust vent with heavy metal or flexible metal vent. See the Installation Instructions.
Dryer Results		
Clothes are not drying satisfactorily or drying times are too long	Eco Dry option is on.	For optimal dry times, turn off the Eco Dry option. For optimal energy, turn on the Eco Dry option.
	Lint screen is clogged with lint.	Clean lint screen before each load.
	The exhaust vent or outside exhaust hood is clogged with lint, restricting air movement.	Run the dryer for 5–10 minutes. Hold your hand under the outside exhaust hood to check air movement. If you do not feel air movement or air movement is minimal, clean exhaust system of lint or replace exhaust vent with heavy metal or flexible metal vent. See the Installation Instructions.

Troubleshooting

First try the solutions suggested here or visit our website at www.whirlpool.com/product_help –
In Canada www.whirlpool.ca for assistance and to possibly avoid a service call.

If you experience	Possible Causes	Solution
Dryer Results (cont.)		
Clothes are not drying satisfactorily or drying times are too long (cont.)	The exhaust vent is not the correct length.	Check that the exhaust vent is not too long or has too many turns. Long venting will increase drying times. See the Installation Instructions.
	The exhaust vent diameter is not the correct size.	Use 4" (102 mm) diameter vent material.
	The dryer is not level.	Clothes not contacting the moisture sensors during Automatic cycles. See "Level Dryer" in the Installation Instructions.
	The Air Only temperature setting has been selected.	Select the correct temperature for the types of garments being dried. See "Cycle Guide."
	The load is too large and heavy to dry quickly.	Separate the load to tumble freely.
	Fabric softener sheets are blocking the grille.	The air outlet grille is just inside the door, behind the lint screen. Check that it is not blocked by a fabric softener sheet. Use only one fabric softener sheet, and use it only once.
	The dryer is located in a room with temperature below 45°F (7°C).	Proper operation of dryer cycles requires temperatures above 45°F (7°C).
	The dryer is located in a closet.	Closet doors must have ventilation openings at the top and bottom of the door. The front of the dryer requires a minimum of 1" (25 mm) of airspace, and, for most installations, the rear of the dryer requires 5" (127 mm). See the Installation Instructions.
Cycle time is too short	The load may not be contacting the sensor strips on Automatic Cycles.	Level the dryer. See the Installation Instructions. All four dryer feet should be in firm contact with the floor.
	The automatic cycle is ending early.	Change the dryness level setting on Automatic Cycles. Increasing or decreasing the dryness level will change the amount of drying time in a cycle. If loads are consistently ending too early, see also "Changing the Automatic Cycle settings to increase or decrease drying time."
Lint on load	Lint screen is clogged with lint.	Clean lint screen before each load.
Stains on load	Improper use of fabric softener.	Add dryer fabric softener sheets at the beginning of the cycle. Fabric softener sheets added to a partially dried load can stain your garments.
Stains on drum	Loose dyes in clothes.	Drum stains are caused by dyes in clothing (usually blue jeans). These will not transfer to other clothing.
Loads are wrinkled	The dryer was tightly packed.	Dry smaller loads that can tumble freely. Results may also vary depending on fabric type.

Troubleshooting

First try the solutions suggested here or visit our website at www.whirlpool.com/product_help –
In Canada www.whirlpool.ca for assistance and to possibly avoid a service call.

If you experience	Possible Causes	Solution
Dryer Results (cont.)		
Odors	Recent painting, staining, or varnishing in the area where your dryer is located.	Ventilate the area. When the odors or fumes are gone from the area, rewash and dry the clothing.
Load too hot	Load removed before cooldown portion of cycle complete.	Allow the dryer to complete the cooldown portion of the cycle before removing the load.
	Using Timed Dry cycle with a high temperature setting.	Select an Automatic Cycle with a lower heat setting to avoid overdrying the load.
Dryer Displaying Code Message or Cycle Status Indicator Lights Up		
“PF” (power failure)	The drying cycle has been interrupted by a power failure.	Touch and hold START to restart the dryer. NOTE: The Control Lock function may be enabled when recovering from a power failure. To unlock the control, touch and hold CONTROL LOCK for at least 3 seconds.
“L2” Diagnostic Code (low or no line voltage condition)	There may be a problem with your home power supply, keeping the dryer’s heater from turning on.	The dryer will continue to run when this diagnostic code is present. Touch any pad to clear the code from the display and return to the estimated time remaining. NOTE: This error will only show during the initial installation. Try the following: Check to see if a household fuse has blown or circuit breaker has tripped. Electric dryers use two household fuses or breakers. Replace the fuse or reset the circuit breaker. Confirm that the power cord is properly installed. Refer to the Installation Instructions for details. Select a Timed Dry heated cycle, and restart the dryer. If the message persists, consult a qualified electrician.
“F# E#” (F1 E1, F3 E1, etc.) variable service codes	The dryer is in need of service.	If a code beginning with an “F” appears in the display, alternating between F# and E#, the dryer control has detected a problem that requires service. Call for service.
Check Vent indicator is lit	The lint screen or vent is clogged; the vent is crushed or kinked or has too many turns.	The dryer will continue to run when this indicator is lit. Try the following: <ul style="list-style-type: none"> • Clean lint screen. • Check to see if the vent run from the dryer to the wall is crushed or kinked. • Confirm that the vent run from the dryer to the wall is free of lint and debris. • Confirm that the exterior vent exhaust hood is free of lint and debris. • Confirm that your vent system falls within the recommended run length and number of elbows for the type of vent you are using. Refer to “Plan Vent System” in the Installation Instructions for details. • Select a Timed Dry heated cycle, and restart the dryer. • If the indicator remains lit, have your entire home venting run cleaned.
“Loc” or “Lc”	The Control Lock is enabled.	Touch and hold CONTROL LOCK for 3 seconds to unlock the controls of the dryer. During this time the LED Display will count down 3-2-1. When the Control Lock is disabled, the LED Display will clear.

CROSLEY CORPORATION MAJOR APPLIANCE LIMITED WARRANTY

ATTACH YOUR RECEIPT HERE. PROOF OF PURCHASE IS REQUIRED TO OBTAIN WARRANTY SERVICE.

Please have the following information available when you call for service:

- Name, address and telephone number
- Model number and serial number
- A clear, detailed description of the problem
- Proof of purchase including dealer or retailer name and address

IF YOU NEED SERVICE:

1. Before contacting us to arrange service, please determine whether your product requires repair. Some questions can be addressed without service. Please take a few minutes to review the Troubleshooting section of the Use and Care Guide.
2. All warranty service is provided exclusively by our authorized Whirlpool Service Providers. In the U.S. and Canada, direct all requests for warranty service to:

In the U.S.A., call 1-800-253-1301. In Canada, call 1-800-807-6777.

If outside the 50 United States or Canada, contact your authorized Crosley dealer to determine whether another warranty applies.

ONE YEAR LIMITED WARRANTY

WHAT IS COVERED

For one year from the date of purchase, when this major appliance is installed, operated, and maintained according to instructions attached to or furnished with the product, Whirlpool Corporation or Whirlpool Canada LP (hereafter "Whirlpool") will pay for Factory Specified Replacement Parts and repair labor to correct defects in materials or workmanship that existed when this major appliance was purchased, or at its sole discretion, replace the product. In the event of product replacement, your appliance will be warranted for the remaining term of the original unit's warranty period.

YOUR SOLE AND EXCLUSIVE REMEDY UNDER THIS LIMITED WARRANTY SHALL BE PRODUCT REPAIR AS PROVIDED HEREIN. Service must be provided by a Whirlpool designated service company. This limited warranty is valid only in the United States or Canada and applies only when the major appliance is used in the country in which it was purchased. This limited warranty is effective from the date of original consumer purchase. Proof of original purchase date is required to obtain service under this limited warranty.

WHAT IS NOT COVERED

1. Commercial, non-residential, multiple-family use, or use inconsistent with published user, operator, or installation instructions.
2. In-home instruction on how to use your product.
3. Service to correct improper product maintenance or installation, installation not in accordance with electrical or plumbing codes, or correction of household electrical or plumbing (i.e., house wiring, fuses, or water inlet hoses),.
4. Consumable parts (i.e., light bulbs, batteries, air or water filters, preservation solutions, etc.).
5. Defects or damage caused by the use of non-genuine Whirlpool parts or accessories.
6. Conversion of products from natural gas or L.P. gas.
7. Damage from accident, misuse, abuse, fire, floods, acts of God, or use with products not approved by Whirlpool.
8. Repairs to parts or systems to correct product damage or defects caused by unauthorized service, alteration, or modification of the appliance.
9. Cosmetic damage including scratches, dents, chips, and other damage to the appliance finishes, unless such damage results from defects in materials and workmanship and is reported to Whirlpool within 30 days.
10. Discoloration, rust, or oxidation of surfaces resulting from caustic or corrosive environments including, but not limited to, high salt concentrations, high moisture or humidity, or exposure to chemicals.
11. Food or medicine loss due to product failure.
12. Pickup or delivery. This product is intended for in-home repair.
13. Travel or transportation expenses for service in remote locations where an authorized Whirlpool servicer is not available.
14. Removal or reinstallation of inaccessible appliances or built-in fixtures (i.e., trim, decorative panels, flooring, cabinetry, islands, countertops, drywall, etc.) that interfere with servicing, removal, or replacement of the product.
15. Service or parts for appliances with original model/serial numbers removed, altered, or not easily determined.

The cost of repair or replacement under these excluded circumstances shall be borne by the customer.

DISCLAIMER OF IMPLIED WARRANTIES

IMPLIED WARRANTIES, INCLUDING ANY IMPLIED WARRANTY OF MERCHANTABILITY OR IMPLIED WARRANTY OF FITNESS FOR A PARTICULAR PURPOSE, ARE LIMITED TO ONE YEAR OR THE SHORTEST PERIOD ALLOWED BY LAW. Some states and provinces do not allow limitations on the duration of implied warranties of merchantability or fitness, so this limitation may not apply to you. This warranty gives you specific legal rights, and you also may have other rights that vary from state to state or province to province.

DISCLAIMER OF REPRESENTATIONS OUTSIDE OF WARRANTY

Whirlpool makes no representations about the quality, durability, or need for service or repair of this major appliance other than the representations contained in this warranty. If you want a longer or more comprehensive warranty than the limited warranty that comes with this major appliance, you should ask Whirlpool or your retailer about buying an extended warranty.

LIMITATION OF REMEDIES; EXCLUSION OF INCIDENTAL AND CONSEQUENTIAL DAMAGES

YOUR SOLE AND EXCLUSIVE REMEDY UNDER THIS LIMITED WARRANTY SHALL BE PRODUCT REPAIR AS PROVIDED HEREIN. WHIRLPOOL SHALL NOT BE LIABLE FOR INCIDENTAL OR CONSEQUENTIAL DAMAGES. Some states and provinces do not allow the exclusion or limitation of incidental or consequential damages, so these limitations and exclusions may not apply to you. This warranty gives you specific legal rights, and you also may have other rights that vary from state to state or province to province.

Assistance or Service

Before calling for assistance or service, please check "Troubleshooting."
It may save you the cost of a service call. If you still need help, follow the instructions below.

When calling, please know the purchase date and the complete model and serial number of your appliance.
This information will help us to better respond to your request.

If you need replacement parts or to order accessories

We recommend that you use only FSP® Factory Specified Parts.
These parts will fit right and work right because they are made with the same precision
used to build every new WHIRLPOOL® appliance.

To locate FSP® replacement parts, assistance in your area, or accessories:

Whirlpool Corporation
Customer eXperience Center
1-800-253-1301
www.crosley.com

Whirlpool Canada LP
Customer eXperience Centre
1-800-807-6777
www.crosley.com

or call your nearest designated service center or refer to your Yellow Pages telephone directory.

Our consultants provide assistance with

In the U.S.A.

- Features and specifications on our full line of appliances.
- Installation information.
- Specialized customer assistance (Spanish speaking, hearing impaired, limited vision, etc.).

In the U.S.A. and Canada

- Use and maintenance procedures.
- Accessory and repair parts sales.
- Referrals to local dealers, repair parts distributors, and service companies. Whirlpool® designated service technicians are trained to fulfill the product warranty and provide after-warranty service, anywhere in the United States and Canada.

You can write with any questions or concerns at:

Crosley Corporation
111 Cloverleaf Drive, Suite 200
Winston-Salem, NC 27103

Customer eXperience Centre
Whirlpool Canada LP
Unit 200-6750 Century Ave
Mississauga, Ontario L5N 0B7

Please include a daytime phone number in your correspondence.

Assistance ou service

Avant de faire un appel pour assistance ou service, veuillez vérifier la section "Dépannage".
Cette vérification peut vous faire économiser le coût d'une visite de réparation.
Si vous avez encore besoin d'aide, suivre les instructions ci-dessous.

Lors d'un appel, veuillez connaître la date d'achat et les numéros au complet de modèle et de série de votre appareil.
Ces renseignements nous aideront à mieux répondre à votre demande.

Si vous avez besoin de pièces de rechange ou pour commander des accessoires

Si vous avez besoin de commander des pièces de rechange, nous vous recommandons d'utiliser seulement des pièces spécifiées par l'usine FSP®. Ces pièces conviendront et fonctionneront bien parce qu'elles sont fabriquées selon les mêmes spécifications précises utilisées pour construire chaque nouvel appareil WHIRLPOOL®.

Pour trouver des pièces de rechange FSP® ou des accessoires dans votre région :

Whirlpool Canada LP Centre pour l'eXpérience de la clientèle
1-800-807-6777 **www.crosley.com**

Nos consultants fournissent l'assistance pour :

- Procédés d'utilisation et d'entretien.
- Vente d'accessoires et de pièces de rechange.
- Les références aux concessionnaires, compagnies de service de réparation et distributeurs de pièces de rechange locaux. Les techniciens de service désignés par Whirlpool® sont formés pour remplir la garantie des produits et fournir un service après la garantie, partout au Canada.

Pour plus d'assistance

Vous pouvez nous soumettre toute question ou problème en écrivant à l'adresse ci-dessous :

Centre pour l'eXpérience de la clientèle
Whirlpool Canada LP
Unit 200-6750 Century Ave
Mississauga, Ontario L5N 0B7

Dans votre correspondance, veuillez indiquer un numéro de téléphone où on peut vous joindre dans la journée.