



# INSTALLATION INSTRUCTIONS

ORIGINAL INSTRUCTIONS

COMMERCIAL GAS OR ELECTRIC DRYER

MODELS XCEM2765 AND XCGM2765

# INSTRUCTIONS D'INSTALLATION

INSTRUCTIONS D'ORIGINE

SÈCHE-LINGE À GAZ OU ÉLECTRIQUE À USAGE COMMERCIAL

MODÈLES XCEM2765 ET XCGM2765

# ISTRUCCIONES DE INSTALACIÓN

ISTRUCCIONES ORIGINALES

SECADORA A GAS O ELÉCTRICA COMERCIAL

MODELOS XCEM2765 Y XCGM2765

# ISTRUZIONI D'INSTALLAZIONE

ISTRUZIONI ORIGINALI

ASCIUGATRICE A GAS O ELETTRICA COMMERCIALE

MODELLI XCEM2765 E XCGM2765



[www.whirlpoolcommerciallaundry.com](http://www.whirlpoolcommerciallaundry.com)

W10868678A

## TABLE OF CONTENTS

DRYER SAFETY .....	3
<b>FOR OWNER</b>	
MAINTENANCE INSTRUCTIONS.....	6
IF YOU NEED ASSISTANCE .....	6
<b>FOR WHIRLPOOL AUTHORIZED SERVICE PERSON</b>	
TOOLS & PARTS .....	7
DIMENSIONS/CLEARANCES .....	8
DRYER INSTALLATION REQUIREMENTS .....	9
INSTALLING LEVELING LEGS .....	10
LEVELING .....	11
ELECTRIC DRYER INSTALLATION REQUIREMENTS .....	12
GAS DRYER INSTALLATION REQUIREMENTS .....	13
DRYER VENTING REQUIREMENTS .....	15
GAS SUPPLY CONNECTION .....	17
TECHNICAL SPECIFICATIONS-GAS DRYER .....	18
COMPLETE INSTALLATION .....	19
REVERSING DRYER DOOR SWING .....	20
DRYER DISPOSAL .....	21
WARRANTY .....	22

## ÍNDICE

SEGURIDAD DE LA SECADORA .....	43
<b>PARA EL PROPIETARIO</b>	
INSTRUCCIONES DE MANTENIMIENTO.....	46
SI NECESITA ASISTENCIA.....	46
<b>PARA EL PERSONAL DE SERVICIO     AUTORIZADO DE WHIRLPOOL</b>	
HERRAMIENTAS Y PIEZAS.....	47
DIMENSIONES Y ESPACIOS LIBRES.....	48
REQUISITOS DE INSTALACIÓN DE LA SECADORA .....	49
INSTALACIÓN DE LAS PATAS NIVELADORAS.....	50
NIVELACIÓN .....	51
REQUISITOS DE INSTALACIÓN DE LA SECADORA ELÉCTRICA.....	52
REQUISITOS DE INSTALACIÓN DE LA SECADORA A GAS .....	53
REQUISITOS DE VENTILACIÓN DE LA SECADORA .....	55
CONEXIÓN DEL SUMINISTRO DE GAS.....	58
ESPECIFICACIONES TÉCNICAS - SECADORA A GAS .....	59
INSTALACIÓN COMPLETA .....	60
CAMBIO DE SENTIDO DE LA ABERTURA DE LA PUERTA.....	61
ELIMINACIÓN DE LA SECADORA .....	62
GARANTÍA.....	63

## TABLE DES MATIÈRES

SÉCURITÉ DU SECHE-LINGE .....	23
<b>POUR LE PROPRIÉTAIRE</b>	
INSTRUCTIONS D'ENTRETIEN .....	26
SI VOUS AVEZ BESOIN D'ASSISTANCE.....	26
<b>POUR LE PERSONNEL D'ENTRETIEN     AUTORISÉ PAR WHIRLPOOL</b>	
OUTILS ET PIÈCES.....	27
DIMENSIONS/DISTANCES DE DÉGAGEMENT .....	28
EXIGENCES D'INSTALLATION POUR LE SECHE-LINGE .....	29
INSTALLATION DES PIEDS DE NIVELLEMENT .....	30
NIVELLEMENT .....	31
EXIGENCES D'INSTALLATION POUR LE SECHE-LINGE ÉLECTRIQUE .....	32
EXIGENCES D'INSTALLATION POUR LE SECHE-LINGE À GAZ .....	33
EXIGENCES CONCERNANT L'ÉVACUATION DU SECHE-LINGE .....	35
RACCORDEMENT A LA CANALISATION DE GAZ .....	37
CARACTÉRISTIQUES TECHNIQUES – SECHE-LINGE À GAZ.....	38
ACHEVER L'INSTALLATION.....	39
INVERSION DU SENS D'OUVERTURE DE LA PORTE.....	40
ELIMINATION DU SECHE-LINGE .....	41
GARANTIE .....	42

## INDICE

SICUREZZA DELL'ASCIUGATRICE.....	64
<b>PER IL PROPRIETARIO</b>	
ISTRUZIONI PER LA MANUTENZIONE .....	67
COME RICHIEDERE ASSISTENZA .....	67
<b>PER IL PERSONALE DI ASSISTENZA     AUTORIZZATO WHIRLPOOL</b>	
ATTREZZI E COMPONENTI .....	68
DIMENSIONI/SPAZI .....	69
REQUISITI DELL'INSTALLAZIONE DELL'ASCIUGATRICE .....	70
INSTALLAZIONE DEI PIEDINI DI REGOLAZIONE.....	71
LIVELLAMENTO .....	72
REQUISITI DELL'INSTALLAZIONE DELL'ASCIUGATRICE ELETTRICA .....	73
REQUISITI DELL'INSTALLAZIONE DELL'ASCIUGATRICE A GAS .....	74
REQUISITI DI SCARICO DELL'ASCIUGATRICE.....	76
COLLEGAMENTO DI ALIMENTAZIONE DEL GAS .....	78
CARATTERISTICHE TECNICHE - ASCIUGATRICE A GAS.....	79
COMPLETAMENTO DELL'INSTALLAZIONE .....	80
INVERSIONE IL SENSO DI APERTURA DELLO SPORTELLO .....	81
ELIMINAZIONE DELL'ASCIUGATRICE .....	82
GARANZIA .....	83

## Your safety and the safety of others are very important.

We have provided many important safety messages in this manual and on your appliance. Always read and obey all safety messages.



This is the safety alert symbol.

This symbol alerts you to potential hazards that can kill or hurt you and others.

All safety messages will follow the safety alert symbol and either the word “DANGER” or “WARNING.” These words mean:

**⚠ DANGER**

You can be killed or seriously injured if you don't immediately follow instructions.

**⚠ WARNING**

You can be killed or seriously injured if you don't follow instructions.

All safety messages will tell you what the potential hazard is, tell you how to reduce the chance of injury, and tell you what can happen if the instructions are not followed.



**WARNING – “Risk of Fire”**

This is an additional safety alert symbol that alerts you to the risk of fire.



**WARNING - “Risk of Fire”**

- Clothes dryer installation and service must be performed by a Whirlpool authorized installer.
- Install the clothes dryer according to the manufacturer's instructions and local codes.
- Do not install a clothes dryer with flexible plastic venting materials or flexible metal (foil type) duct. If flexible metal duct is installed, it must be of a specific type identified by the appliance manufacturer as suitable for use with clothes dryers. Flexible venting materials are known to collapse, be easily crushed, and trap lint. These conditions will obstruct clothes dryer airflow and increase the risk of fire.
- To reduce the risk of severe injury or death, follow all installation instructions.
- Save these instructions.

- It is recommended that the owner post, in a prominent location, instructions for the customer's use in the event the customer smells gas. This information should be obtained from your gas supplier.
- Post the following warning in a prominent location.

### FOR YOUR SAFETY

1. DO NOT USE OR STORE GAS OR OTHER FLAMMABLE MATERIALS IN THIS APPLIANCE OR NEAR THIS APPLIANCE.
2. DO NOT SPRAY AEROSOLS IN THE VICINITY OF THIS APPLIANCE WHILE IT IS IN OPERATION.
3. DO NOT MODIFY THIS APPLIANCE.

# DRYER SAFETY

---

**WARNING:** For your safety, the information in this manual must be followed to minimize the risk of fire or explosion, or to prevent property damage, personal injury, or death.

- Do not store or use gasoline or other flammable vapors and liquids in the vicinity of this or any other appliance.
- **WHAT TO DO IF YOU SMELL GAS:**
  - Do not try to light any appliance.
  - Do not touch any electrical switch; do not use any phone in your building.
  - Clear the room, building, or area of all occupants.
  - Immediately call your gas supplier from a neighbor's phone. Follow the gas supplier's instructions.
  - If you cannot reach your gas supplier, call the fire department.
- Installation and service must be performed by a Whirlpool authorized installer, Whirlpool authorized service agency, or the gas supplier.

**WARNING:** Gas leaks cannot always be detected by smell.

For more information, contact your gas supplier.

If a gas leak is detected, follow the "What to do if you smell gas" instructions.

**IMPORTANT:** When discarding or storing your old clothes dryer, remove the door.

## IMPORTANT SAFETY INSTRUCTIONS

**WARNING:** To reduce the risk of fire, electric shock, or injury to persons when using the dryer, follow basic precautions, including the following:



- Read all instructions before using the dryer.
- This dryer is intended only for drying clothes and textiles that have been washed in water. Do not use for any other purpose.
- **WARNING:** If you smell gas, do not use the dryer or any electrical equipment nearby. Warn other people to clear the area. Contact the dryer owner immediately.
- Do not place items exposed to cooking oils in your dryer. Items contaminated with cooking oils may contribute to a chemical reaction that could cause a load to catch fire.
- If it is unavoidable that fabrics that contain vegetable or cooking oil or that have been contaminated by hair care products be placed in a tumble dryer, they should first be washed in hot water with extra detergent – this will reduce, but not eliminate the hazard.
- Do not dry articles that have been previously cleaned in, washed in, soaked in, or spotted with gas, dry-cleaning solvents, other flammable, or explosive substances as they give off vapors that could ignite or explode.
- Items that have been soiled with substances such as acetone, alcohol, gas, kerosene, spot removers, turpentine, waxes, and wax removers should be washed in hot water with extra detergent before being dried in the dryer.
- Do not dry unwashed items in the dryer.
- Do not use this dryer if industrial chemicals have been used for cleaning. The possible presence of residual quantities of aggressive or decomposed chemicals in the load may produce damage to the dryer and harmful fumes.
- Do not allow children to play on, in, or with the dryer. Close supervision of children is necessary when the dryer is used near children.
- This dryer is not intended for use by persons (including children) with reduced physical, sensory, or mental capabilities, or lack of experience or knowledge, unless they have been given supervision or instruction concerning use of the dryer by a person responsible for their safety.
- Before the dryer is removed from service or discarded, remove the door to the dryer compartment.
- Do not reach into the dryer if the drum is moving.
- Do not open door while dryer is in operation. It will stop.
- When loading or re-loading the dryer, avoid touching hot metal parts of the drum (burn risk).
- Remove all objects from pockets such as lighters and matches.
- Cleaning and user maintenance shall not be made by children without supervision.
- **WARNING:** The appliance must not be supplied through an external switching device, such as a timer, or connected to a circuit that is regularly switched on and off by a utility.
- The dryer must not be installed behind a lockable door, a sliding door, or a door with a hinge on the opposite side to that of the dryer in such a way that full opening of the dryer door is restricted.
- The appliance is intended, but not limited, to be used in public areas.
- Children of less than 3 years should be kept away unless continuously supervised.
- The appliance must be disconnected from its power source during service and when replacing parts.
- If drum rotation is blocked due to trapped textiles, disconnect the dryer from the electrical supply before gently removing the blockage.
- If the dryer is not heating, or appears to be defective or damaged, do not use it. Contact the owner.
- Do not install or store the dryer where it will be exposed to the weather.
- Do not tamper with controls.
- Clean dryer lint screen before or after each load.
- Do not use this dryer without the lint screen in place.
- Do not repair or replace any part of the dryer or attempt any servicing unless specifically recommended in this Installation Instructions that you understand and have the skills to carry out.
- Fabric softeners, or similar products, should be used as specified by the fabric softener instructions.
- Items such as foam rubber (latex foam), shower caps, waterproof textiles, rubber-backed articles and clothes or pillows fitted with foam rubber pads should not be dried in the tumble dryer.
- The final part of a tumble dryer cycle occurs without heat (cool-down cycle) to ensure that the articles are left at a temperature that ensures that the items will not be damaged.
- **WARNING:** Never stop a tumble dryer before the end of the drying cycle unless all items are quickly removed and spread out so that the heat is dissipated. (Avoids risk of spontaneous combustion).
- In case of electrical supply failure, remove the load quickly and spread it out to avoid risk of spontaneous combustion.
- Keep area around the exhaust opening and adjacent surrounding areas free from the accumulation of lint, dust, and dirt.
- The fresh air ventilation openings into the room and into the dryer must not be blocked or sealed.
- Emergency stop control: After installation, access to mains plug (gas dryer) or mains supply (electric dryer) via a double-pole switch must be maintained at all times in order to ensure immediate deactivation of the dryer in case of emergency.
- The interior of the dryer and dryer exhaust vent should be cleaned periodically by Whirlpool authorized service personnel.
- See “Electrical Requirements” section for earthing instructions.
- Adequate ventilation has to be provided to avoid the back-flow of gases into the room from appliances burning fuels, including open fires.

**SAVE THESE INSTRUCTIONS**

# MAINTENANCE INSTRUCTIONS

---

- Clean lint screen before and after each cycle.
- Removing accumulated lint:
  - From inside the dryer cabinet:  
Lint should be removed every 2 years or more often, depending on dryer usage. Cleaning should be done by a Whirlpool authorized person.
  - From the exhaust vent:  
Lint should be removed every 2 years, or more often, depending on dryer usage.
- Keep area around dryer clear and free from combustible materials, gas, and other flammable vapors and liquids.
- Keep dryer area clear and free from items that would obstruct the flow of combustion and ventilation air.

## **If dryer does not operate, check the following:**

- Electrical supply is connected.
- Circuit breaker is not tripped or house fuse is not blown.
- Door is closed. Listen closely to hear the door switch activate.
- Controls are set in a running or “on” position.
- START button has been pushed firmly.
- For gas dryers, check that gas supply shut-off valves are set in open position.

**WARNING:** Improper connection of the equipment-earthing conductor can result in a risk of electric shock. It is your responsibility to check with a qualified electrician or service representative if you are in doubt as to whether the dryer is properly grounded and meets all local codes and ordinances. Do not modify the plug provided with the dryer: If it will not fit the outlet, have a proper outlet installed by a qualified electrician.

## IF YOU NEED ASSISTANCE

---

If you need help, contact the dealer from whom you purchased the appliance, or a Whirlpool designated service company. When calling, please know the purchase date and the complete model and serial number of your appliance. This information will help us to better respond to your request.

### **IF YOU NEED SERVICE:**

Contact your authorized Whirlpool Commercial Laundry distributor. To locate your authorized Whirlpool Commercial Laundry distributor, visit [www.WhirlpoolCommercialLaundry.com](http://www.WhirlpoolCommercialLaundry.com).

For written correspondence:

**Whirlpool Commercial Laundry Service Department  
2000 N M 63  
Benton Harbor, Michigan 49022-2632 USA**

## Tools Needed:



203 mm (8")  
or 254 mm (10")  
Pipe Wrench



203 mm (8") or 254 mm (10")  
Adjustable Wrench  
that opens to 25 mm (1")



Flat-Blade Screwdriver



Phillips Screwdriver



Torx<sup>†</sup> T-20<sup>†</sup> Security  
Screwdriver or Bit



25 mm (1") Hex-Head  
Socket Wrench



8 mm (5/16") Socket Wrench

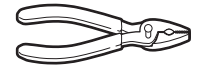

Pliers (that open to  
39 mm [1 9/16"])



Level



Utility Knife



6 mm (1/4") Nut Driver

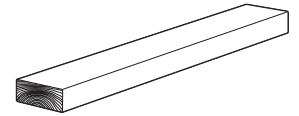

686 mm (27")  
Wood Block

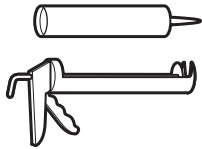

Caulk Gun and Caulk  
(for installing new exhaust vent)



Vent Clamps



Pipe-Joint Compound  
Suitable for Gas Type

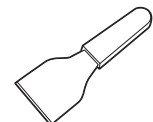

Putty Knife

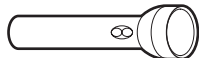

Flashlight (optional)



25 mm (1")  
Open-End Wrenches

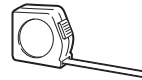

Ruler or Measuring Tape

## Parts Supplied:



Foot Boots (4)

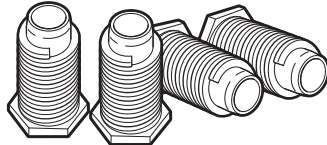

Leveling Legs (4)

**NOTE:** The circuit diagram for this dryer is located inside the lower front panel, within the Tech Sheets.

## Electric Model:

### Technical Specifications:

220 – 240 V, 50 Hz. AC  
4575W

Total mass: 68 kg max.

### Clothes Capacity:

IEC Capacity  
9 kg

**NOTE:** Sound Pressure Level, LpA: 58 dB(A)  
[uncertainty, KpA: +/-10 dB(A)].

# DIMENSIONS/CLEARANCES

## Dimensions

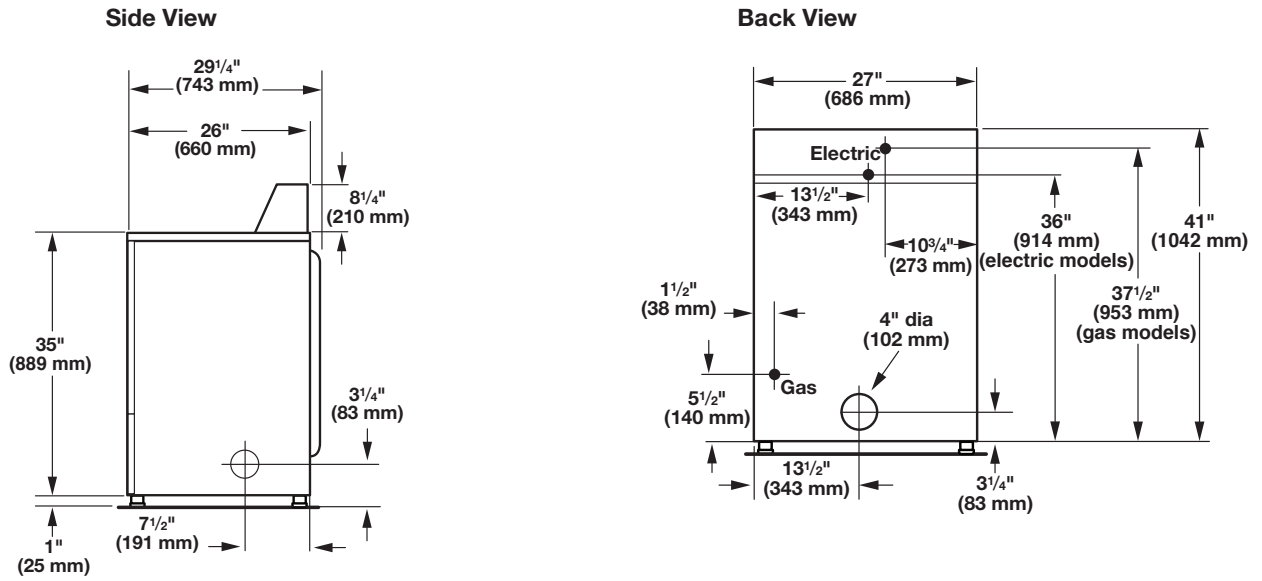

## Clearances

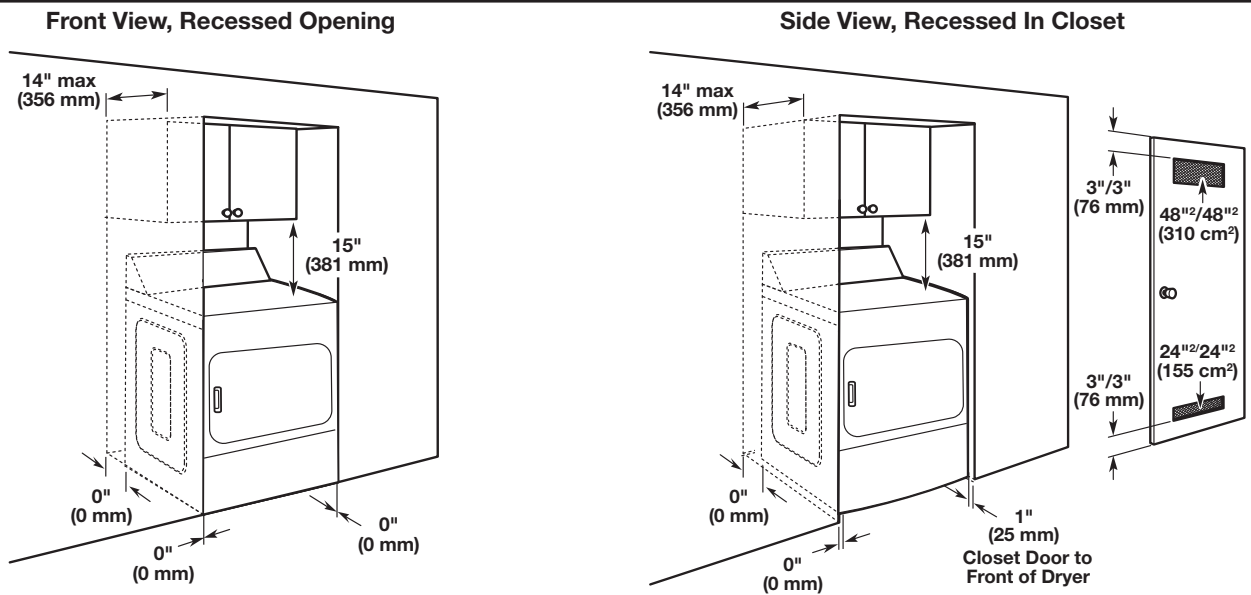



# DRYER INSTALLATION REQUIREMENTS

## Location Requirements

### **⚠ WARNING**



#### **Explosion Hazard**

**Keep flammable materials and vapors, such as petrol, away from dryer.**

**Do not install in a garage.**

**Failure to do so can result in death, explosion, or fire.**

Your dryer can be installed in a basement, laundry room, or recessed area.

This dryer is not intended for installation in a mobile home. Companion appliance location requirements should also be considered.

**IMPORTANT:** Do not install or store the dryer where it will be exposed to water and/or the weather. Proper installation is your responsibility.

#### **You will need:**

- A grounded electrical outlet located within 6 ft. (1.8 m) of where the power cord is attached to the back of the dryer. See "Electrical Requirements."
- A level floor with a maximum slope of 1" (25 mm) under entire dryer. Installing the dryer on soft floor surfaces, such as carpets or surfaces with foam backing, is not recommended.

#### **Gas dryer installation clearances**

- The location must be large enough to allow the dryer door to be fully opened.
- Additional spacing should be considered for ease of installation and servicing. The door opens more than 180°.
- Additional clearances might be required for wall, door, and floor moldings.
- Additional spacing of 1" (25 mm) on all sides of the dryer is recommended to reduce noise transfer.

#### **When installing a gas dryer:**

**IMPORTANT:** Observe all governing codes and ordinances.

- Check code requirements: Some codes limit or do not permit installation of clothes dryers in garages, closets, or sleeping quarters. Contact your local building inspector.
- Make sure that lower edges of the cabinet, plus the back and bottom sides of the dryer, are free of obstructions to permit adequate clearance of air openings for combustion air. See "Recessed Area and Closet Installation Instructions" below for minimum spacing requirements.

#### **Recessed Area and Closet Installation Instructions**

This dryer may be installed in a recessed area or closet. For recessed area and closet installations, minimum clearances can be found on the warning label on the rear of the dryer or in "Dimensions/Clearances."

The installation spacing is in inches and is the minimum allowable. Additional spacing should be considered for ease of installation, servicing, and compliance with local codes and ordinances.

If closet door is installed, the minimum unobstructed air opening in the top and bottom is required. The unobstructed opening needs to be 1 square inch per 1,000 Btu (252 kcal) of gas burner output. Output on North American gas dryers is typically 22,000 Btu; however, Canadian dryers may have lower output. Louvered doors with equivalent air openings are acceptable.

The dryer must be exhausted outdoors.

No other fuel-burning appliance may be installed in the same closet as the dryer.

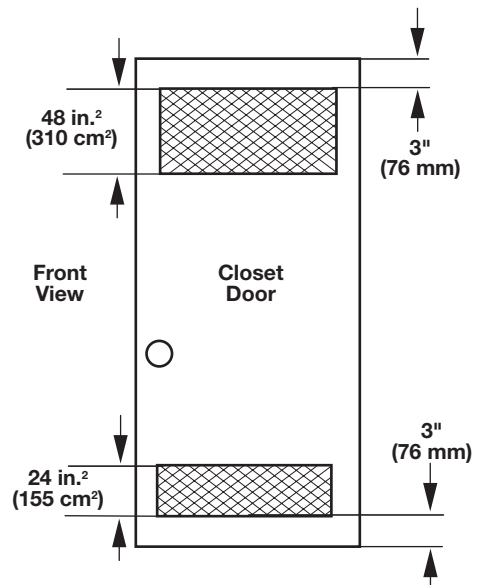

# INSTALLING LEVELING LEGS

## **⚠ WARNING**

### **Excessive Weight Hazard**

**Use two or more people to move and install dryer.**

**Failure to do so can result in back or other injury.**

### **1. Prepare dryer for leveling legs**

**NOTE:** Slide dryer onto cardboard or hardboard before moving to avoid damaging floor covering.

Using two or more people, move dryer to desired installation location.

Take tape off front corners of dryer. Open dryer and remove the literature and parts packages. Wipe drum interior with a damp cloth to remove any dust.

Take two cardboard corners from the dryer carton and place them on the floor in back of the dryer. Firmly grasp the body of the dryer and gently lay it on its back on the cardboard corners.

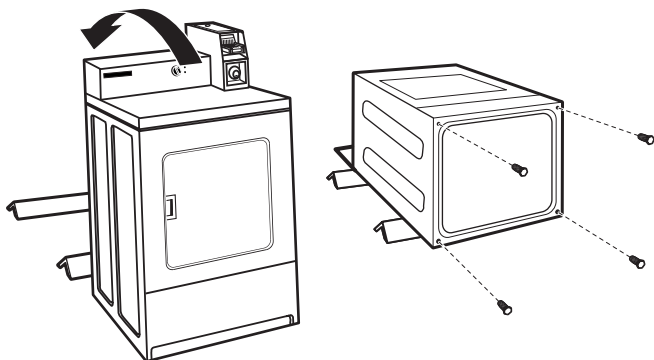

### **2. Screw in leveling legs**

Examine leveling legs and find diamond marking. Screw legs into leg holes by hand. Use an adjustable wrench or 25 mm (1") hex-head socket wrench to finish turning legs until diamond marking is no longer visible. Then fit a covered foot boot over each leg foot.

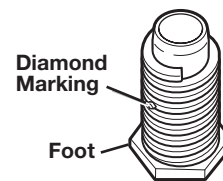

To protect the floor, use a large piece of cardboard from the dryer carton. Stand dryer up on the cardboard. Slide the dryer until it is close to its final location. Leave enough room for electrical connection and to connect the exhaust vent.

A longer leveling foot is available if needed on extremely sloped floors, Part Number 279810.

Leveling your dryer properly reduces excess noise and vibration.

## ⚠ WARNING

### Excessive Weight Hazard

Use two or more people to move and install dryer.

Failure to do so can result in back or other injury.

1. Remove cardboard from beneath dryer. Place a level on top edges of dryer, checking each side and front. If not level, tip dryer and adjust legs up or down as shown in Step 3, repeating as necessary.

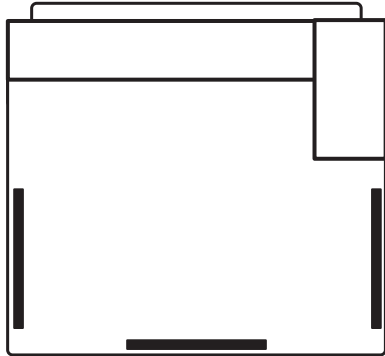

(appearance may vary)

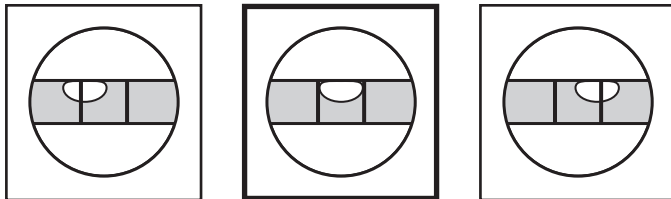

Not Level

LEVEL

Not Level

2. Grip dryer from top and rock back and forth, making sure all four legs are firmly on floor. Repeat, rocking dryer from side to side. If dryer rocks, go to Step 3 and adjust leveling legs.

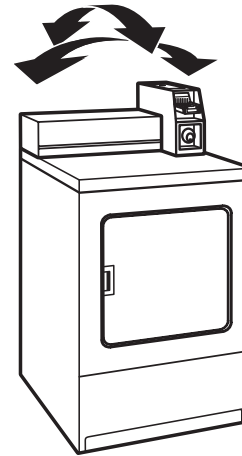

(appearance may vary)

3. If dryer is not level, use a 1" or 25 mm open-end or adjustable wrench to turn the leveling leg counterclockwise to lower the dryer or clockwise to raise the dryer. Recheck levelness of dryer and that all four legs are firmly in contact with the floor. Repeat as needed.

**HELPFUL TIP:** You may want to prop up front of dryer about 4" (102 mm) with a wood block or similar object that will support weight of dryer.

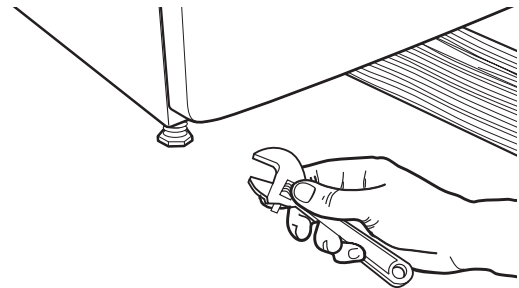

# ELECTRIC DRYER INSTALLATION REQUIREMENTS

## Electrical Requirements

### **WARNING**



#### **Dangerous Voltage**

This dryer is supplied without an electric cord and plug. It must be connected by a Whirlpool authorized service person to a single-phase electricity supply at the voltage shown on the dataplate, using a suitable fixed wiring installation in accordance with local and national wiring regulations.

- A 3-wire circular cord of minimum conductor size 2.5 mm<sup>2</sup> cross-section area should be used.
- A 25A (minimum) supply fuse should be used, and a switch with a clear OFF marking having a contact separation in both poles that provides full disconnection under over-voltage category III conditions must be incorporated into the fixed wiring in accordance with local wiring regulations by a competent electrician. The dryer should be positioned so that the disconnection switch is clearly visible and easily accessible to the user. This disconnection switch also provides the function of an emergency stop control for the user.
- A cord clamp bush is provided on the dryer, and should be tightened on completion of wiring. The electrical mains terminals are located behind the small rear access panel (terminal block cover), and connections should be made in accordance with the terminal markings. Remember to replace the terminal access panel (terminal block cover).

**NOTE:** In accordance with the European EMC Directive (2004/108/EC), the maximum electrical supply system impedance to which the electric dryer should be connected is declared to be 0.054 Ohm + j0.034 Ohm.

**NOTE:** Electrical safety standards: The manufacturer has chosen compliance with IEC/EN.60335 standards as the most appropriate for this product.

### **WARNING**



#### **Electric Shock Hazard**

**This is 3-wire appliance which must be earthed.  
Do not earth to a gas pipe.  
Failure to follow these instructions could result in death, fire, or serious injury.**

If codes permit and an additional ground bond wire is used, it is recommended that a qualified electrician determine that the ground bond path is adequate.

#### **Recommended Earthing Method**

It is your responsibility to contact a qualified electrical installer to ensure that the electrical installation is adequate and in conformance with all local codes and ordinances.

# GAS DRYER INSTALLATION REQUIREMENTS

## Electrical Requirements

### **⚠ WARNING**



**Dangerous Voltage**

**IMPORTANT:** Observe all governing codes and ordinances.

You will need a grounded electrical outlet located within 610 mm (2 feet) of either side of the dryer.

This dryer is supplied/fitted with an electrical supply cord and plug. It should be connected to electrical supply socket at the voltage shown on the rating plate. The minimum supply fuse capacity should be 10A. The dryer must be positioned so that the plug is clearly visible and accessible. This plug also provides the function of an emergency stop control for the user. If the fitted plug is not used, the electrical connection must be carried out by a competent electrician in accordance with local or national codes.

If the supply cord is damaged, it must be replaced with a specially terminated cord by an authorized service agent or a similarly competent person in order to avoid a hazard.

Do not use an adapter.

Do not use an extension cord.

**NOTE:** In accordance with the European EMC Directive (2004/108/EC), the maximum electricity supply system impedance to which the gas dryer should be connected is declared to be 0.29 Ohm + j0.18 Ohm.

**NOTE:** Electrical safety standards: The manufacturer has chosen compliance with IEC/EN.60335 standards as the most appropriate for this product.

### **⚠ WARNING**



#### **Electric Shock Hazard**

**This is a 3-wire appliance which must be earthed.**

**Do not earth to a gas pipe.**

**Do not change the power supply cord plug. If it does not fit the outlet, have a proper outlet installed by a qualified electrician.**

**Do not use an extension cord with this dryer.**

**Failure to follow these instructions could result in death, fire, or serious injury.**

If codes permit and an additional ground bond wire is used, it is recommended that a qualified electrician determine that the ground bond path is adequate.

### **EARTHING INSTRUCTIONS**

■ For an earthed cord-connected dryer:  
This dryer must be earthed. In the event of a malfunction or breakdown, earthing will reduce the risk of electric shock by providing a path of least resistance for electric current. This dryer is equipped with a cord having an equipment-earthing conductor and a earthing plug. The plug must be plugged into an appropriate outlet that is properly installed and earthed in accordance with all local codes and ordinances.

**WARNING:** Improper connection of the equipment-earthing conductor can result in a risk of electric shock. Check with a qualified electrician or Whirlpool authorized representative or personnel if you are in doubt as to whether the dryer is properly earthed. Do not modify the plug provided with the dryer: if it will not fit the outlet have a proper outlet installed by a qualified electrician.

### **SAVE THESE INSTRUCTIONS**

#### **Using the universal cord included with this dryer:**

The gas dryer is equipped with a universal cord with interchangeable plugs.

1. To use the universal cord, select the plug end that fits your electrical outlet, and plug it into the adapter on the supply cord.
2. Secure the plug end in place on the cord by aligning the 2 cover halves over the cord adapter and clipping them together.

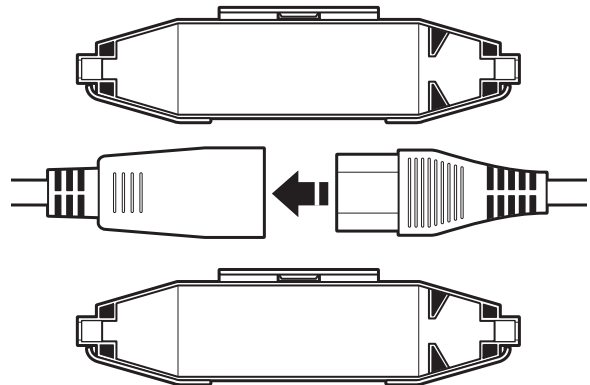

# GAS DRYER INSTALLATION REQUIREMENTS

## Gas Supply

### **WARNING**



#### **Explosion Hazard**

**Connect this dryer to a regulated gas supply. Supply pressure must be in accordance with the Technical Specifications.**

**Install a shut-off valve.**

**Securely tighten all gas connections.**

**If connected to LP, have a Whirlpool authorized service person make sure gas pressure is correct.**

**Failure to do so can result in death, explosion, or fire.**

**IMPORTANT:** Observe all governing codes and ordinances. In Australia and New Zealand, refer to AS/NZS 5601.1 – Gas Installations.

### **Gas Supply**

Before installation, check that the local gas distribution conditions, nature of gas and pressure, and the adjustment of the appliance are compatible. Burner information will be found on the model/serial rating plate in the door recess of the dryer. If this information does not agree with the type of gas available, see your dealer.

#### **Natural Gas:**

This dryer is factory adjusted for use with NATURAL GAS (G20), and no further adjustment should be required at installation.

#### **L.P. Gas:**

This dryer is also certified for use with L.P. (propane or butane) gases with appropriate conversion. No attempt shall be made to convert the appliance from the gas specified on the model/serial rating plate for use with a different gas without consulting the serving gas supplier.

Conversion must be done by a Whirlpool authorized service technician. Gas conversion kit (European Country), part number W10233219, is available for purchase from your dealer. Gas conversion kit (Australia), part number W10315369, is available for purchase from your dealer. Full instructions are supplied with the kit.

#### **Natural Gas (France/Belgium):**

This dryer is also certified for France/Belgium for use with G20/G25 gases (20 mbar/25 mbar) with appropriate conversion. No attempt should be made to convert this appliance from the gas specified on the gas rating label for use with a different gas without consulting the serving gas supplier. Gas conversion must be done by a Whirlpool authorized gas service technician. Conversion kit, part number (W10181947) is available for purchase from your dealer. Full instructions are supplied with the kit.

#### **Supply line requirements:**

Provide a rigid gas supply line to the dryer location. It should be minimum 12.5 mm (1/2") ID. When acceptable to the gas supplier and local codes, 10 mm (3/8") ID rigid supply line may be used for lengths under 6.1 m (20'). Pipe-joint compounds resistant to the action of L.P. gas must be used.

**NOTE:** For installation in Australia and New Zealand, refer to AS/NZS 5601 for pipe sizing details. All piping is to be in accordance with AS/NZS 5601.1 – Gas Installations.

Gas connection to the dryer itself should be made by means of a flexible gas hose suitable for the appliance and gas category in accordance with national installation regulations. If in doubt, contact the gas supplier. It should be minimum 10 mm (3/8") ID.

A means of restraint should be used between the dryer and the wall to avoid straining of the rigid gas supply when the dryer is moved. An appropriate length of chain and a wall hook is recommended.

The dryer gas inlet connection is a 10 mm (3/8") NPT thread. An adapter is supplied for conversion to standard ISO.228-1 thread (10 mm [3/8"] BSP).

Check for leaks by using an approved noncorrosive leak-detection solution. Bubbles will show a leak. Correct any leak found. A pressure measurement tapping is provided on the gas valve within the dryer, accessible after removal of the lower front panel.

The dryer must be disconnected from the gas supply piping system during any pressure testing of that system.

# DRYER VENTING REQUIREMENTS

## ⚠ WARNING



### Fire Hazard

Use a heavy metal vent.

Do not use a plastic vent.

Do not use a metal foil vent.

Failure to follow these instructions can result in death or fire.

**WARNING:** To reduce the risk of fire, this dryer MUST BE EXHAUSTED OUTDOORS.

**IMPORTANT:** Observe all governing codes and ordinances. In Australia and New Zealand, refer to AS/NZS 5601.1 – Gas Installations.

Dryer exhaust must not be connected into any gas vent, chimney, wall, ceiling, attic, crawlspace, or a concealed space of a building. Only rigid or flexible metal vent shall be used for exhausting.

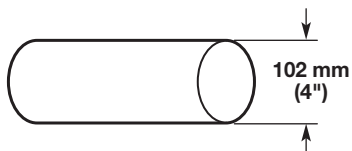

102 mm (4") Heavy, Metal Exhaust Vent

- Only a 102 mm (4") heavy, metal exhaust vent and clamps may be used.
- Do not use plastic or metal foil vent.

### Rigid metal vent:

- Recommended for best drying performance and to avoid crushing and kinking.

**Flexible metal vent:** (Acceptable only if accessible to clean)

- Must be fully extended and supported in final dryer location.
- Remove excess to avoid sagging and kinking that may result in reduced airflow and poor performance.
- Do not install in enclosed walls, ceilings, or floors.
- The total length should not exceed 2.4 m (7¾ ft.).

**NOTE:** If using an existing vent system, clean lint from entire length of the system and make sure exhaust hood is not plugged with lint. Replace plastic or metal foil vents with rigid metal or flexible metal vents. Review "Vent System Chart" and, if necessary, modify existing vent system to achieve best drying performance.

### Elbows:

- 45° elbows provide better airflow than 90° elbows.

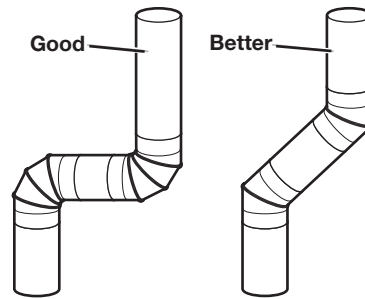

### Clamps:

- Use clamps to seal all joints.
- Exhaust vent must not be connected or secured with screws or other fastening devices that extend into interior of duct and catch lint. Do not use duct tape.

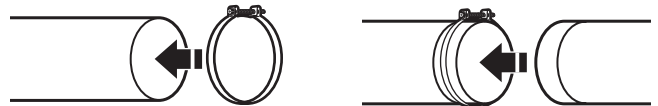

**Improper venting can cause moisture and lint to collect indoors, which may result in:**

- Moisture damage to woodwork, furniture, paint, wallpaper, carpets, etc.
- Housecleaning problems and health problems.

# DRYER VENTING REQUIREMENTS

## Vent Hoods

### 102 mm (4") Diameter Exhaust Hoods

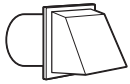

Box Hood



Louvered Hood

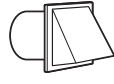

Angled Hood

Exhaust hood must be at least 305 mm (12") from the ground or any object that may be in the path of the exhaust (such as flowers, rocks, bushes, or snow).

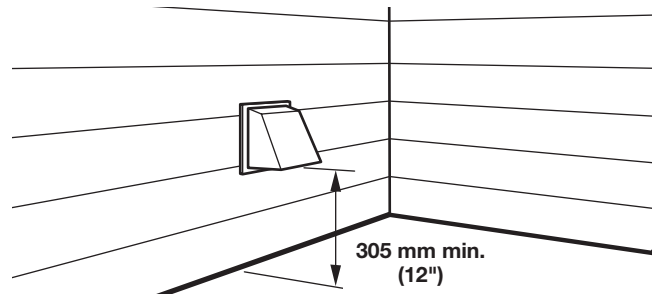

## Vent System Length

### Maximum Vent Length/Vent Connection

Maximum length of vent system depends upon the type of vent used, number of elbows, and type of exhaust hood.

Vent System Chart (Rigid Metal Vent)

No. of 90° Turns	Box and Louvered Hood	Angled Hood
0	39.6 m (130 ft.)	39.3 m (129 ft.)
1	38.1 m (125 ft.)	36.3 m (119 ft.)
2	35.1 m (115 ft.)	33.2 m (109 ft.)
3	32.3 m (106 ft.)	30.5 m (100 ft.)
4	29.9 m (98 ft.)	28.0 m (92 ft.)

For vent systems not covered by the vent specification chart, see your parts distributor.

Provision must be made for enough air for combustion and ventilation. (Check governing codes and ordinances.) See "Recessed Area and Closet Installation Instructions" in the "Location Requirements" section.

A 102 mm (4") outlet hood is preferred. However, a 64 mm (2½") outlet exhaust hood may be used. A 64 mm (2½") outlet creates greater back pressure than other hood types. For permanent installation, a stationary vent system is required.

### Connect Vent

1. If connecting to existing vent, make sure the vent is clean.
2. Using a 102 mm (4") clamp, connect vent to exhaust outlet in dryer.

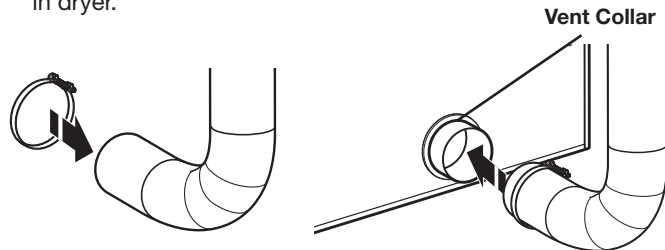

**NOTE:** Do not remove vent collar.

3. Tighten hose clamp with Phillips screwdriver.

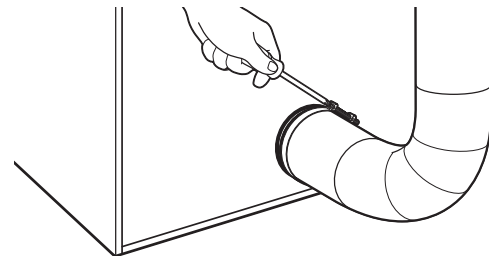

4. Make sure the vent is secured to exhaust hood with a 102 mm (4") clamp.

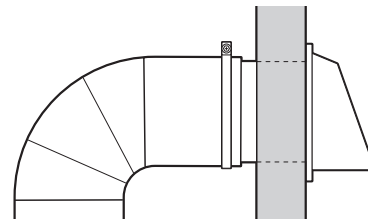

5. Move dryer into final position. Do not crush or kink vent. Make sure dryer is level.

**NOTE:** Testing for proper ventilation should be done with a Manometer. Minimum: 0.01" (0.2 mm). Maximum: 0.6" (16 mm).



# DRYER VENTING REQUIREMENTS

## If an Exhaust Hood Cannot be Used

The outside end of main vent should have a sweep elbow directed downward.

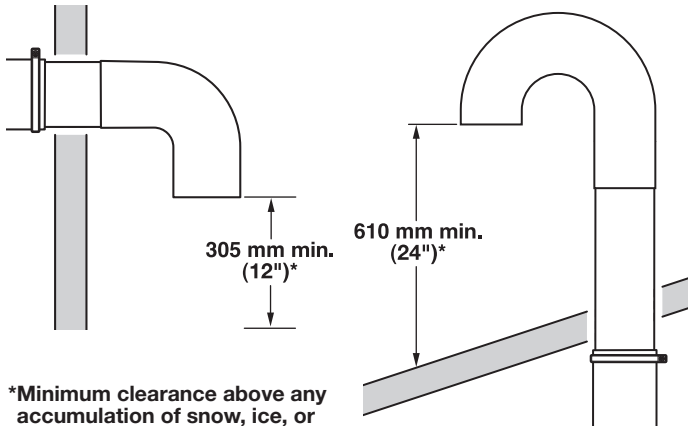

If main vent travels vertically through the roof, rather than through wall, install a 180° sweep elbow on end of vent at least 610 mm (2 ft.) above surface of roof.

The opening in wall or roof shall have a diameter 13 mm (1/2") larger than vent diameter. Vent should be centered in opening. Do not install screening over end of vent for best performance.

## Multiple Dryer Venting

A main vent can be used for venting a group of dryers. The main vent should be sized to remove 5663 l/min. (200 CFM) of air per dryer. Large-capacity lint screens of proper design may be used in main vent if checked and cleaned frequently. The room where the dryers are located should have make-up air equal to or greater than CFM of all the dryers in the room.

Back-draft dampers are available from your distributor and should be installed in the vent of each dryer to keep exhausted air from returning into dryers and to keep exhaust in balance within main vent. Unobstructed return air openings are required.

Although usually each single-load dryer should have an unobstructed outdoor air opening of 154 cm<sup>2</sup> (24 in.<sup>2</sup>) (based on 6.5 cm<sup>2</sup> [1 in.<sup>2</sup>] per 252 kcal [1,000 Btu]), common make-up air openings are also acceptable. Set up common openings so the make-up air is distributed equally to all of the dryers. Keep in mind that the coverage area must be increased by 33% to account for the use of registers or louvers over the openings. Also, make-up air openings should not be installed near the location where exhaust vents exit the building.

Each vent should enter the main vent at an angle pointing in the direction of the airflow. Vents entering from the opposite side should be staggered to reduce the exhausted air from interfering with the other vents.

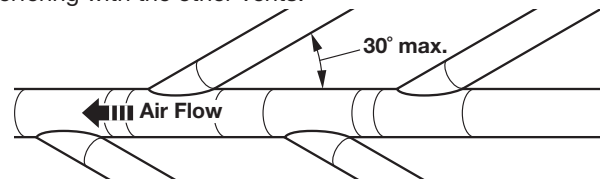

The maximum angle of each vent entering the main vent should be no more than 30°.

Keep air openings free of dry cleaning fluid fumes. Fumes create acids which, when drawn through the dryer heating units, can damage dryers and items being dried.

A clean-out cover should be located on the main vent for periodic cleaning of the vent system.

**NOTE:** For more dryer venting information, please refer to Whirlpool document W10100920.

## GAS SUPPLY CONNECTION (on some models)

### Make Gas Connection

#### **⚠ WARNING**

##### **Excessive Weight Hazard**

**Use two or more people to move and install dryer.**

**Failure to do so can result in back or other injury.**

1. Connect gas supply to dryer. If the flexible gas hose has 10 mm (3/8") BSP thread, use the supplied conversion thread adapter. Use pipe-joint compound resistant to the action of L.P. gas for gas connections.

If necessary for service, open the toe panel. Use a putty knife to press on the 2 toe panel locks located at the top of the toe panel. Pull downward on the toe panel to open. Toe panel is hinged at the bottom.

2. Open the shut-off valve in the gas supply line and make sure the dryer has its own gas supply opened.
3. Test all connections by brushing on an approved noncorrosive leak-detection solution. Bubbles will show a leak. Correct any leaks found.

# TECHNICAL SPECIFICATIONS – GAS DRYER

220–240V~50Hz 1ph 3A max. IP24 Clothes capacity: 9.0 kg max. Sound pressure level, Lpa: 58 dBA (uncertainty, Kpa: +/-10 dBA) Total mass: 68 kg max.

## Factory set for NATURAL GAS: Injector size: 2.2 mm Heat input gross: 5.9 kW

Country:	CH, CZ, CY, ES, GB, GR, HR, IE, IT, PT, SI, SK, TR	CY, CZ, DK, EE, FI, GR, HU, IT, NO, RO, SE, SK, TR
European Gas Category:	II <sub>2</sub> H3+	II <sub>2</sub> H3B/P
Gas Flow Rate:	.562703 m <sup>3</sup> /hr	0.562703 m <sup>3</sup> /hr
Supply Pressure (G20):	20 mbar	20 mbar
Factory Adjusted Pressure:	7.4 mbar	7.4 mbar

## With LP Gas Conversion Kit: Injector size: 1.25 mm Heat input gross: 6.4 kW

European Country:	CH, CZ, CY, ES, GB, GR, HR, IE, IT, PT, SI, SK, TR	CY, CZ, DK, EE, FI, GR, HU, IT, NO, RO, SE, SK, TR
European Gas Category:	II <sub>2</sub> H3+	II <sub>2</sub> H3B/P
Butane Supply Pressure (G30):	28–30 mbar	30 mbar
Adjusted Pressure:	N/A	N/A
Propane Supply Pressure (G31):	37 mbar	30 mbar
Adjusted Pressure:	N/A	N/A

## With France/Belgium NATURAL GAS conversion kit: Injector size 1.65 mm Heat input gross: 5.9 kW

European Country:	FR, BE
European Gas Category:	I <sub>2</sub> E+
Supply Pressure (G20):	20 mbar
Supply Pressure (G25):	25 mbar
Adjusted Pressure:	N/A

## Factory set for Australia/New Zealand NATURAL GAS: Injector size: 2.2 mm Heat input gross: 5.9 kW

Country:	AS, NZS
Supply Pressure (G20)	minimum 1.13 kPa
Adjusted Pressure (Test Point Pressure):	0.74 kPa
Nominal Hourly Gas Consumption	21.1 MJ/h

## With Australia LG Gas Conversion Kit: Injector Size: 1.40 mm Heat input gross: 6.54 kW

Country:	AS, NZS
Propane Supply Pressure:	2.75 kPa
Adjusted Pressure:	2.75 kPa
Nominal Hourly Gas Consumption:	23 MJ/h

## Factory set for NATURAL GAS: Injector size: 2.2 mm Heat input gross: 5.0 kW

Country:	NL
European Gas Category:	II <sub>2</sub> L3B/P
Gas Flow Rate:	0.562703 m <sup>3</sup> /hr
Supply Pressure (G25):	25 mbar
Factory Adjusted Pressure (G25) :	7.4 mbar
Supply Pressure (G30/G31):	30 mbar
Factory Adjusted Pressure (G30/G31):	N/A

**NOTE:** Conversion kit: From Natural Gas to LP Gas - Europe: Whirlpool Part No. W10233219.  
 Conversion kit: From Natural Gas to LP Gas - Australia: Whirlpool Part No. W10315369.  
 Conversion kit: From Natural Gas to Natural Gas - France/Belgium: Whirlpool Part No. W10181947.  
 Manufacturer: Whirlpool Corporation, Benton Harbor, Michigan 49022, U.S.A.  
 Manufacturing Site: Whirlpool Corporation, 1300 Marion-Agosta Rd., Marion, OH, 43302, U.S.A.  
 EU Representative: Whirlpool Europe s.r.l. Viale Guido Borghi 27, 21025 Comerio (VA) Italy

# COMPLETE INSTALLATION

1. Check the electrical requirements. Be sure that you have the correct electrical supply and the recommended earthing method. See “Electrical Requirements.”
2. Check that all parts are now installed. If there is an extra part, go back through the steps.
3. Check that you have all of your tools.
4. Dispose of/recycle all packaging materials.

<b>⚠ WARNING</b>

<b>Electric Shock Hazard</b>
<b>This dryer must be earthed.</b>
<b>Securely tighten all electrical connections.</b>
<b>Failure to do so can result in death, fire, or electric shock.</b>

5. Plug into a grounded outlet, or connect power.

6. Check dryer operation (some accumulated time may be on the timer due to factory testing). Close dryer door. Insert coins in slide and press slide in slowly. (Operating time will accumulate per number of coins and type of timing cam used.) Push START button. Using a full heat cycle (not the air cycle), let the dryer run for at least five minutes. Dryer will stop when time is used up.

**NOTE:** Dryer door must be closed for dryer to operate. When door is open, dryer stops, but timer continues to run. To restart dryer, close door and push START button.

7. **Gas models only:** Open the dryer door. Check that the inside of the dryer is warm. If the burner does not ignite and you can feel no heat inside the dryer, shut off dryer for five minutes. Check that all supply valve controls are in “ON” position and that the electrical cord is plugged in. Repeat five-minute test.
8. If drying time is too long, make sure that the lint screen is clean and that there are no obstructions to airflow in the dryer vent system.
9. Restart the dryer and allow it to complete a full heat cycle (not air cycle) to make sure it is working properly.

# REVERSING DRYER DOOR SWING (OPTIONAL)

You can change your door swing from a right-side opening to left-side opening, if desired.

## Remove the Door Assembly

1. Place a towel or soft cloth on top of dryer or work space to avoid scratching of the surface.
2. Open dryer door. Remove bottom screws from cabinet side of hinges. Loosen (do not remove) top screws from cabinet side of hinges.

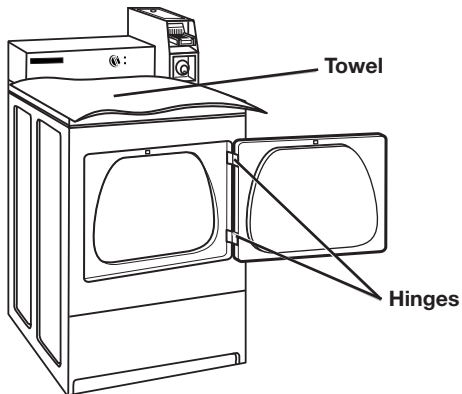

3. Lift door until top screws in cabinet are in large part of hinge slot. Pull forward off screws. Set door (handle side up) on top of dryer. Remove top screws from cabinet.
4. Remove screws attaching hinges to door.
5. Remove screws at top, bottom, and side of door (5 screws).

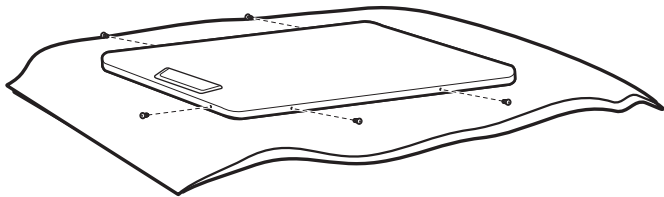

6. Holding door over towel on dryer, grasp sides of outer door and gently lift to separate it from inner door. Do not use a putty knife to pry apart. Do not pull on door seal or plastic door catch.

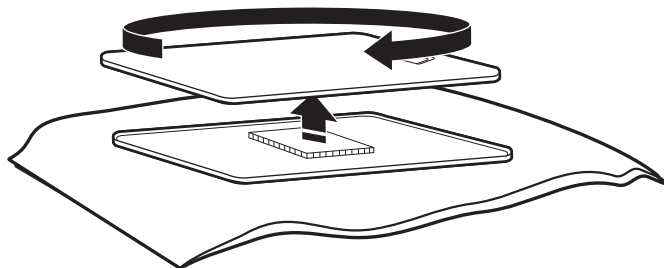

7. Be certain to keep cardboard spacer centered between doors. Reattach outer door panel to inner door panel so handle is on the side where hinges were just removed.

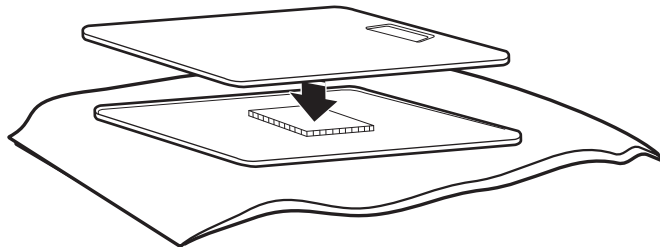

8. Reattach screws at top, bottom, and side of door (5 screws).

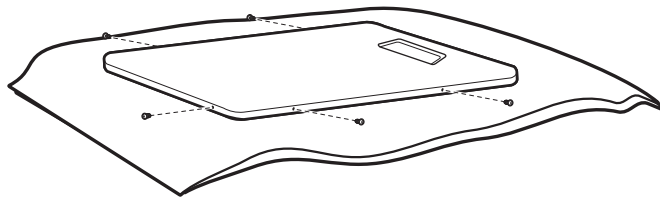

9. Attach door hinges to dryer door so that larger hole is at the bottom of the hinge and the hinge pin is toward the door front.

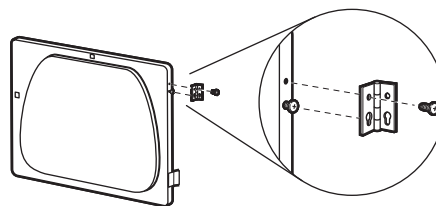

10. Remove the 4 screws that attach 2 plugs on the left side. Attach plugs to right side using the same 4 screws.
11. Insert screws into bottom holes on left side of cabinet. Tighten screws halfway. Position door so large end of door hinge slot is over screws. Slide door up so screws are in bottom of slots. Tighten screws. Insert and tighten top screws in hinges.

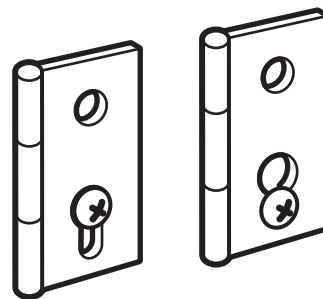

12. Close door and check that door strike aligns with door catch. If needed, slide door catch left or right within slot to adjust alignment.



This appliance is marked according to the European directive 2002/ 96/ EC on Waste Electrical and Electronic Equipment (WEEE).

By ensuring this product is disposed of correctly, you will help avoid potential negative consequences for the environment and human health, which could otherwise be caused by inappropriate waste handling of this product.

The symbol on the product, or on the documents accompanying the product, indicates that this appliance may not be treated as household waste. Instead it shall be handed over to the applicable collection point for the recycling of electrical and electronic equipment.

Disposal must be carried out in accordance with local environmental regulations for waste disposal.

For more detailed information about treatment, recovery and recycling of this product, please contact your local city office, your household waste disposal service or the shop where you purchased the product.

## MODEL NOMENCLATURE:

**CGM** – Whirlpool Gas

**FQ** – Series Revision

**CEM** – Whirlpool Electric

**2765** – Model Type Number

**IMPORTANT:** When discarding or storing your old clothes dryer, remove the door.

# WHIRLPOOL COMMERCIAL LAUNDRY LIMITED WARRANTY

## IF YOU NEED SERVICE:

Contact your authorized Whirlpool Commercial Laundry distributor. To locate your authorized Whirlpool Commercial Laundry distributor, visit [www.WhirlpoolCommercialLaundry.com](http://www.WhirlpoolCommercialLaundry.com).

For written correspondence:

**Whirlpool Commercial Laundry Service Department**  
2000 N M 63  
Benton Harbor, Michigan 49022-2632 USA

## THREE YEAR LIMITED WARRANTY

### WHAT IS COVERED

#### THREE YEAR LIMITED WARRANTY (PARTS ONLY – LABOR NOT INCLUDED)

For the first three years from the original date of purchase, when this commercial appliance is installed, maintained, and operated according to the instructions attached to or furnished with the product, Whirlpool Corporation (hereafter "Whirlpool") will pay for factory specified replacement parts to correct defects in materials or workmanship that existed when this commercial appliance was purchased. This limited warranty does not include labor.

**YOUR SOLE AND EXCLUSIVE REMEDY UNDER THIS LIMITED WARRANTY SHALL BE PRODUCT REPAIR AS PROVIDED HEREIN.** Whirlpool recommends that you use an "authorized" service provider to diagnose and repair your Commercial Laundry product. Whirlpool will not be responsible under this warranty to provide additional replacement parts as a result of incorrect diagnosis or repair by an "unauthorized" service company. Except in the European Union, this limited warranty is valid only when the commercial appliance is used in the country in which it was purchased. This limited warranty is effective from the date of the original consumer purchase. Proof of original purchase date is required to obtain service under this limited warranty.

### WHAT IS NOT COVERED

1. All other costs including labor, transportation, shipping, or custom duties for covered parts.
2. Factory specified replacement parts if this commercial appliance is used for other than normal, commercial use or when it is used in a manner that is inconsistent to published user or operator instructions and/or installation instructions.
3. Service calls to correct the installation of your commercial appliance, to instruct you on how to use your commercial appliance, to replace or repair house fuses, or to correct external wiring or plumbing.
4. Service calls to repair or replace appliance light bulbs, air filters, or water filters. Consumable parts are excluded from warranty coverage.
5. Damage resulting from improper handling of product during delivery, theft, accident, alteration, misuse, abuse, fire, flood, acts of God, improper installation, installation not in accordance with local electrical or plumbing codes, or use of products not approved by Whirlpool.
6. Pick up and delivery. This commercial appliance is designed to be repaired on location.
7. Repairs to parts or systems resulting from unauthorized modifications made to the commercial appliance.
8. The removal and reinstallation of your commercial appliance if it is installed in an inaccessible location or is not installed in accordance with published installation instructions.
9. Damage resulting from exposure to chemicals.
10. Changes to the building, room, or location needed in order to make the commercial appliance operate correctly.
11. Factory specified replacement parts on commercial appliances with original model/serial numbers that have been removed, altered, or cannot be easily determined.
12. Discoloration, rust, or oxidation of stainless steel surfaces.
13. Factory specified replacement parts as a result of incorrect diagnosis or repair by an "unauthorized" service company.

**The cost of repair or replacement under these excluded circumstances shall be borne by the customer.**

## DISCLAIMER OF IMPLIED WARRANTIES

IMPLIED WARRANTIES, INCLUDING ANY IMPLIED WARRANTY OF MERCHANTABILITY OR IMPLIED WARRANTY OF FITNESS FOR A PARTICULAR PURPOSE, ARE LIMITED TO THREE YEARS OR THE SHORTEST PERIOD ALLOWED BY LAW. Some locations may not allow limitations on the duration of implied warranties of merchantability or fitness, so this limitation may not apply to you. This warranty gives you specific legal rights, and you also may have other rights that vary.

## DISCLAIMER OF REPRESENTATIONS OUTSIDE OF WARRANTY

Whirlpool makes no representations about the quality, durability, or need for service or repair of this major appliance other than the representations contained in this Warranty. If you want a longer or more comprehensive warranty than the limited warranty that comes with this major appliance, you should ask your retailer about buying an extended warranty. The benefits to you given by this warranty are in addition to other rights and remedies available to you under a law in relation to the goods or service to which this warranty relates. Please contact Whirlpool for further information on warranty terms.

## LIMITATION OF REMEDIES; EXCLUSION OF INCIDENTAL AND CONSEQUENTIAL DAMAGES

**YOUR SOLE AND EXCLUSIVE REMEDY UNDER THIS LIMITED WARRANTY SHALL BE PRODUCT REPAIR AS PROVIDED HEREIN. WHIRLPOOL SHALL NOT BE LIABLE FOR INCIDENTAL OR CONSEQUENTIAL DAMAGES.** Some locations do not allow the exclusion or limitation of incidental or consequential damages, so these limitations and exclusions may not apply to you. This warranty gives you specific legal rights, and you also may have other rights that vary by location.

04/17

