

NX58H5650W*
NX58H5600S*
NX58J5600S*
NX58M5600S*

Free-Standing Gas Range user manual

ENGLISH

imagine the possibilities

Thank you for purchasing this Samsung product.

SAMSUNG

features of your new range

Enhanced convenience. Better cooking. Easy maintenance. Your new gas range has been designed to bring you these benefits and more.

- **Bigger is better**

With a capacity of 5.8 cubic feet, your new range has more space than many other leading brands in the United States and Canadian markets. This means greater convenience for you when cooking for the holidays or when entertaining.

- **A cooktop with 5 burners**

Power burners, simmer burners, as well as a center oval burner provide flexible cooktop heat for a variety of cookware. The center oval burner provides even heating over large areas, so it is perfect for griddle cooking.











important safety instructions

READ ALL INSTRUCTIONS BEFORE USING THIS APPLIANCE

All electrical and gas equipment with moving parts can be dangerous. Please read the important safety instructions for this appliance in this manual. The instructions must be followed to minimize the risk of injury, death, or property damage. Save this manual. Please Do Not Discard.

SAFETY SYMBOLS

What the icons and signs in this user manual mean:

 WARNING	There is a risk of death or serious personal injury.
 CAUTION	There is a risk of personal injury or property damage.
 CAUTION	To reduce the risk of fire, explosion, electric shock, or personal injury when using your gas range, follow these basic safety precautions:
	Do NOT attempt.
	Do NOT disassemble.
	Do NOT touch.
	Follow directions explicitly.
	Unplug the power cord from the electrical outlet.
	Make sure the range is plugged into an earth grounded electrical outlet to prevent electric shock. An outlet equipped with a Ground Fault Interrupter (GFI) is highly recommended.
	Call the service center for help. see page 84.
	Note

These warning icons are here to prevent injury to you and others.

Please observe them explicitly.

Do not discard this manual. Please keep it in a safe place for future reference.

WARNING: If the information in this manual is not followed exactly, a fire or explosion may result causing property damage, personal injury or death.

- **DO NOT** store or use gasoline or other flammable vapors and liquids in the vicinity of this or any other appliance.
- WHAT TO DO IF YOU SMELL GAS:
 - **DO NOT** try to light any appliance.
 - **DO NOT** touch any electrical switch.
 - **DO NOT** use any phone in your building.
 - Immediately call your gas supplier from a neighbor's phone. Follow the gas supplier's instructions.
 - If you cannot reach your gas supplier, call the fire department.
- Installation and service must be performed by a qualified installer, service agency, or the gas supplier.

ANTI-TIP DEVICE



WARNING



Tip-Over Hazard

- **A child or adult can tip the range and be killed.**
- **Install the anti-tip device on the range and/or structure as per the installation instructions in this manual.**
- **Engage the range with the installed anti-tip device.**
- **Re-engage the anti-tip device if the range is moved.**
- **Failure to follow these instructions can result in death or serious burns to children or adults.**



To prevent accidental tipping of the range, attach an approved anti-tip device to the floor. (See Installing the Anti-Tip Device in the Installation Instructions.) Check for proper installation by carefully tipping the range forward. The anti-tip device should engage and prevent the range from tipping over.

If the range is pulled out away from the wall for any reason, make sure the anti-tip device is reengaged after the range has been pushed back into place.

Follow the installation instructions found in the Installation Manual. Failure to follow these instructions can result in death, serious personal injury, and / or property damage.

STATE OF CALIFORNIA PROPOSITION 65 WARNING (US ONLY)

WARNING : This product contains chemicals known to the State of California to cause cancer and birth defects or other reproductive harm.

Gas appliances can cause low-level exposure to Proposition 65 listed substances, including but not limited to, benzene, carbon monoxide, formaldehyde and soot, substances resulting from the incomplete combustion of natural gas or LP fuels.

IMPORTANT SAFETY PRECAUTIONS



WARNING

Follow basic precautions when installing and using this range to reduce the risk of fire, electrical shock, injury, or death to persons, including:

Installation and Service



This range must be properly located and installed in accordance with the installation instructions before it is used.

Professional installation is strongly recommended.

Due to the size and weight of the range, it is highly recommended that two or more people move or install this appliance.

All ranges can tip over and cause severe injuries. Install the anti-tip device packed with this range following the instructions found in the Installation Instructions.

Never try to repair or replace this appliance on your own unless it is specifically recommended in this manual. This appliance should be serviced only by a qualified service technician.

Know the location of the gas shut-off valve and how to shut it off if necessary.

Properly remove or destroy the packaging materials after the appliance is unpacked.

Electrical/Mechanical



Unplug or disconnect power before servicing.



Do not tamper with the controls.

Grates and griddles (if equipped) are heavy. They can be dangerous if dropped.

The inner portion of the split oven rack (if equipped) could drop down accidentally if not assembled properly. Place the inner rack in the proper position within the outer rack.

Always position the oven racks at the same level on each cavity side. Uneven racks could cause food to slide to the lower side, posing a risk of burns.

Danger to Children

-  Do not store any object of interest to children on the cooktop or backguard of the range. Children climbing on the range to reach items could be killed or seriously injured.

The inner rack of the Split Rack can be dropped if it is not assembled properly. Place the Inner rack in the proper place on the Outer rack. Always insert the rack or split rack assembly (if equipped) on the same level of the oven cavity side.

Keep children away from the door when opening or closing it as they may bump themselves on the door or catch their fingers in the door.

Keep all packaging materials out of reach of children. Children may play with them. Failure to dispose of plastic bags could result in suffocation.

Do not leave children alone or unattended in an area where a range is in use. They should never be allowed to sit or stand on any part of a range.

Do not let little children touch the range.

The cooktop grates and griddle (if equipped) are heavy and presents a risk of injury if dropped on a foot. Teach children not to touch or play with grates or griddle.

-  Teach children not to touch or play with the controls or any part of the range.

We recommend you utilize the control / door lockout feature to reduce the risk of mis-use by children.

-  Before disposing of the range, cut off the power cord to prevent it from being connected to a power source. Remove the door to prevent children and animals from getting trapped.

Fire

-  Do not touch oven burners, drawer burners, or interior surfaces of the oven during or immediately after cooking. Cooking surfaces, grates, cooktop burners, and caps, as well as oven walls may be hot even though they are dark in color. Interior oven surfaces can become hot enough to cause burns. During and after use, do not touch or let clothing or other flammable materials contact oven burners, drawer burners, or interior surfaces of the oven until they have had sufficient time to cool.

-  Do not let a pot holder touch a hot heating element. Do not use a towel or other bulky cloth as a pot holder.

Do not use your range to heat unopened food containers or to dry wet items or clothing.

-  Keep oven vent ducts unobstructed. Clean vents frequently to avoid grease buildup. See page 55. There can be slight popping sound during oven cooking. This sound may occur during the normal oven burner cycling, when the oven burner flame is extinguished.

- 
- Never use your range for any purposes but cooking. Doing so could result in carbon monoxide poisoning and/or overheating of the oven.

Do not wear loose-fitting or hanging garments while using this appliance.

DO NOT STORE OR USE combustible materials, gasoline, or other flammable vapors or liquids in the vicinity of this appliance. See “WHAT TO DO IF YOU SMELL GAS” under the Gas Warnings.

Do not pour water into the cooktop well while cleaning the cooktop. This could leak down into the range gas and electrical systems creating a risk of electrical shock or high levels of Carbon Monoxide, due to corrosion of the gas valves or ports.

Do not use water on a grease fire. Water might cause a grease fire to explode, spreading the fire and creating a larger fire and health hazard. To put out a grease fire, turn off the heat source and smother the fire with tight-fitting lid or use a multipurpose dry chemical or foam-type fire extinguisher.

Never leave surface units unattended at high heat settings. Boilovers cause smoke, and greasy spillovers could ignite.

Do not use a flame to check for gas leaks. Instead, use a brush to spread a soapy water mixture around the area you are checking. If there is a gas leak, you will see small bubbles in the soapy water mixture at the point of the leak.

Do not place portable appliances, or any other object other than cookware on the cooktop. Damage or fire could occur if the cooktop is hot.

Do not attempt to operate this appliance if it is damaged, malfunctioning, or has missing or broken parts.

Never place plastic, paper, or other items that could melt or burn near the oven vents or any of the surface burners.

- 
- If the self-clean mode malfunctions, turn the oven off and disconnect the power supply. Refer to pages 82 and 83 to contact a qualified service technician.

There can be slight popping sound during oven cooking.

8_ important safety instructions

Steam and Vapors



Use care when opening the oven door. Let hot air or steam escape before removing or placing food in a hot oven.

Use only dry pot holders. Putting moist or damp pot holders on hot surfaces may result in burns from steam.

Surface Burner Warnings

- The burner spreader can be blocked by food or dust. Clean the spreader if it appears blocked. If you clean the spreader with water, assemble it only after it is completely dry. If the spreader is wet, it might prevent the burners from igniting.
- Do not pour water on the cooktop for cleaning. It can get inside the range and cause the parts inside to rust.
- Only ignite the cooktop burners with the burner caps in place. If the burner caps are not in place, you can damage the controls or cause an unintended large or dangerous flame.
- Heating of beverages can result in delayed eruptive boiling. To prevent delayed eruptive boiling, ALWAYS allow heated beverages to stand at least 20 seconds after you have turned the burner off so that the temperature in the liquid can stabilize. In the event of scalding, follow these FIRST AID instructions:
 - Immerse the scalded area in cold water for at least 10 minutes
 - Cover with clean, dry dressing
 - Do not apply any creams, oils or lotions
- The 'Spark mark' on the Dual burner spreader must be placed beside the electrode when it is assembled to prevent an abnormal flame.
- After turning on a surface burner, check to make sure that the burner has ignited. Adjust the level of the flame by turning the burner knob.
- When you set a burner to simmer, do not turn the burner knob quickly. Watch the flame to make sure it stays on.

GAS WARNINGS



If the instructions in this manual are not followed exactly, a fire or explosion may result, causing death, personal injury, or property damage.

If you smell gas:

1. Close the valve and do not use the range.
2. DO NOT light a match, candle, or cigarette.
3. DO NOT turn on any gas or electric appliances.
4. DO NOT touch any electrical switches or plug a power cord into an outlet.
5. DO NOT use any phone in your building.
6. Clear the room, building, or area of all occupants.
7. Immediately call your gas supplier from a neighbor's phone. Follow the gas supplier's instructions.
8. If you cannot reach your gas supplier, call the fire department.

Read instructions completely and carefully.



Installation of this range must conform with local codes or, in the absence of local codes, with the National Fuel Gas Code, ANSI Z223.1/NFPA.54, latest edition. In Canada, installation must conform with the current Natural Gas Installation Code, CAN/CGA-B149.1, or the current Propane Installation Code, CAN/CGA-B149.2, and with local codes where applicable. This range has been design-certified by ETL according to ANSI Z21.1, latest edition, and Canadian Gas Association according to CAN/CGA-1.1, latest edition.

Do not install this range in a place which is exposed to a strong draft.

Installation and service must be performed by a qualified installer, service agency, or gas supplier.

Have the installer show you the location of the gas shut-off valve and how to shut it off.

Always use NEW flexible connectors when installing a gas appliance. Never reuse old flexible connectors. The use of old flexible connectors can cause gas leaks and personal injury.



Never use this appliance as a space heater to heat or warm the room. Doing so may result in carbon monoxide poisoning and overheating of the oven.

Never block the oven vents (air openings). They provide the air inlet and exhaust that are necessary for the oven to operate properly with correct combustion.

IN THE COMMONWEALTH OF MASSACHUSETTS

- ★ This product must be installed by a licensed plumber or gas fitter qualified or licensed by the State of Massachusetts.

When using ball-type gas shut-off valves, you must use the T-handle type.

Multiple flexible gas lines must not be connected in series.



ELECTRICAL WARNINGS

Comply with the following electrical instructions and requirements to avoid death, personal injury from electric shock, and/or property damage from fire:



1. Plug into a grounded 3-prong outlet.
2. DO NOT remove the ground prong.
3. DO NOT use an adapter.
4. NEVER use an extension cord.

- ★ Use a dedicated 120-volt, 60-Hz, 20-amp, AC, fused electrical circuit for this appliance. A time-delay fuse or circuit breaker is recommended. DO NOT plug more than one appliance into this circuit.

The range is supplied with a 3-pronged grounded plug. This cord **MUST** be plugged into a mating, grounded 3-prong outlet that meets all local codes and ordinances. If you are unsure your electrical outlet is properly grounded, have it checked by a licensed electrician.

If codes permit the use of a separate ground wire, we recommend that a qualified electrician determine the proper path for this ground wire.

Electrical service to the range must conform to local codes. Barring local codes, it should meet the latest ANSI/NFPA No. 70 – Latest Revision (for the U.S.) or the Canadian Electrical Code CSA C22.1 – Latest Revisions.

It is the personal responsibility of the appliance owner to provide the correct electrical service for this appliance.

- ☐ NEVER connect the ground wire to plastic plumbing lines, gas lines, or hot water pipes.

DO NOT modify the plug provided with the appliance.

DO NOT put a fuse in a neutral or ground circuit.

GROUNDING INSTRUCTIONS



Grounding a range with a cord connection:

This appliance must be Earth grounded. In the event of a malfunction or breakdown, grounding will reduce the risk of electrical shock by providing a path for the electric current. This appliance is equipped with a cord having a grounding plug. The plug must be firmly plugged into an outlet that is properly installed and grounded in accordance with the local codes and ordinances.



Improper connection of the grounding plug can result in a risk of electric shock. Check with a qualified electrician if you are not sure whether the appliance is properly grounded.



NEVER modify the plug provided with the appliance. If it does not fit the existing outlet, have a qualified electrician install a proper outlet.

INSTALLATION WARNINGS



Have your range installed and properly grounded by a qualified installer, in accordance with the installation instructions. Any adjustment and service should be performed only by qualified gas range installers or service technicians.

Be sure your range is correctly installed and adjusted by a qualified service technician or installer for the type of gas (natural or LP) you will use. For your range to utilize LP gas, the installer must replace the 5 surface burner orifices and 2 oven orifices with the provided LP orifice set, and reverse the GPR adapter.



These adjustments must be made by a qualified service technician in accordance with the manufacturer's instructions and all codes and requirements of the authority having jurisdiction. Failure to follow these instructions could result in serious injury or property damage. The qualified agency performing this work assumes the gas conversion responsibility.



Do not attempt to repair or replace any part of your range unless it is specifically recommended in this manual. All other service should be referred to a qualified technician.



This appliance must be properly grounded. Plug your range into a 120-volt grounded outlet that is only used for this appliance. Do not remove the grounding (third) prong from the plug. Firmly plug the power cord into the wall outlet. If you are not sure your electrical outlet is grounded, it is your personal responsibility and obligation to have a properly grounded, three-prong outlet installed in accordance with local and national codes. Do not use a damaged power plug or loose wall outlet. Do not use an extension cord with this appliance. In addition, do not use an adapter or otherwise defeat the grounding plug. If you do not have a proper outlet or have any doubts about the outlet, consult a licensed electrician.

12_ important safety instructions

- ★ Locate the range out of kitchen traffic paths and drafty locations to prevent poor air circulation.

This appliance should be positioned so that the power plug is easily accessible.

Do not install in an area exposed to dripping water or outside weather conditions.

Remove all packaging materials from the range before operating it. These materials can ignite, causing smoke and/or fire damage.

Install this appliance on a level and hard floor that can support its weight. Synthetic flooring, like linoleum, must withstand 180 °F (82 °C) temperatures without shrinking, warping, or discoloring. Never install the range directly over interior kitchen carpeting unless a sheet of 0.25-inch plywood or a similar insulator is placed between the range and carpeting.

- ◻ Never block the vents (air openings) of the range. They provide the air inlet and exhaust necessary for the range to operate properly with correct combustion. Air openings are located behind the range, under the oven control panel, at the top and bottom of the oven door, and under the lower warming or storage drawer.

Large scratches on or sharp blows to the door glass can cause the glass to break or shatter.

- ★ Make sure the wall coverings around the range can withstand heat, up to 200 °F (93 °C), generated by the range.

Avoid placing cabinets above the range. This reduces the hazard caused by reaching over the open flames of operating burners.

Do not put any combustible material or items around the range.

If cabinets are placed above the range, allow a minimum clearance of 40 in (102 cm) between the cooking surface and the bottom of unprotected cabinets.

Install a ventilation hood or an externally vented Over The Range Microwave Oven over the range cooktop that is as wide as the range, centered over the range, and projects forward beyond the front of the cabinets. See the Installation instructions

Remove all tape and packaging. Make sure the burners are properly seated and level.

Remove any accessories from the oven and/or lower drawer.

Check to make sure no range parts have come loose during shipping.

SURFACE BURNER WARNINGS



Follow basic precautions when installing and using this range to reduce the risk of fire, electrical shock, injury, or death to persons, including:



Use proper pan sizes. Avoid pans that are unstable or warped. Select cookware having flat bottoms large enough to cover the burner grates. To avoid spillovers, make sure cookware is large enough to contain your food. This will save cleaning time and prevent hazardous accumulations of food, since heavy spattering or spillovers left on the range can ignite. Use pans with handles that can be easily grasped and remain cool.

Do not use pots or pans larger than the grate on a grate. Using pots or pans larger than a grate may cause the pots or pans to discolor or deform. It can also cause units or the wall around the grate to ignite and may generate excess carbon monoxide.

Always use the LITE position when igniting the top burners. Make sure the burners have ignited.

If ignition fails, turn the knob to Off and wait until the gas already emitted has dissipated. If you keep the knob in the LITE position without proper ignition, the emitted gas might cause an explosion.



Never leave the surface burners unattended at HIGH flame settings. Boilovers cause smoking, and greasy spillovers can ignite.

Stand away from the range when frying.



Adjust the top burner flame size so it does not extend beyond the edge of the cookware. Flames that extend past cookware edges can be hazardous.

To decrease spattering when cooking foods with lots of liquid, such as meat sauce or stew, adjust the the flame to low and stir frequently.

Only use dry pot holders. Pot holders with moisture in them can release steam and cause burns if they come in contact with hot surfaces.

Keep pot holders away from open flames when lifting cookware. Never use a towel or bulky cloth in place of a pot holder.

Keep all plastic away from the surface burners or any open flame.

When using glass cookware, make sure it is designed for top-of-range cooking.

Always make sure cookware handles are turned to the side or rear of the cooktop, but not over other surface burners. This will minimize the chance of burns, spillovers, and the ignition of flammable materials that can be caused if pots or pans are bumped accidentally.

Do not wear loose or hanging garments when using the range. They could ignite and burn you if they touch a surface burner.

Take care that your hands do not touch the burners when they are on. Turn off the burners when you change a pan or pot.

14_ important safety instructions

- Always heat frying oils slowly, and watch as they heat. If you are frying foods at high heat, carefully watch during the cooking process. If a combination of fats or oils are to be used during frying, they need to be stirred together before heating.

Use a deep fryer thermometer whenever possible. This prevents overheating the fryer beyond the smoking point.

Use as little oil as possible for shallow or deep-fat frying. Using too much oil can cause spillovers when food is added.

Items should always be removed from the cooktop when they are done cooking.

Never leave plastic items on the cooktop. Hot air from the vent can melt or ignite plastic items or cause a building up of dangerous pressure in closed plastic containers.

This cooktop is not designed to flame foods or cook with a wok or wok ring attachment. If foods are flamed, they should only be flamed under a ventilation hood that is on.

Always make sure foods being fried are thawed and dried. Moisture of any kind can cause hot fat to bubble up and over the sides of the pan.

- Never move a pan or deep-fat fryer full of hot fat. Always let it cool before moving.
- Always make sure the controls are OFF and the grates are cool before you remove them to prevent any possibility of burning.
- If the range is located near a window, NEVER hang long curtains or paper blinds on that window. They could blow over the surface burners and ignite, causing a fire hazard.

Grease is flammable and should be handled very carefully. Never try to extinguish a grease fire with water.

- If you smell gas, turn off the gas to the range and call a qualified service technician. NEVER use an open flame to locate a leak.

Always turn off the surface burner controls before removing cookware. All surface burner controls should be turned OFF when you are not cooking.

Always turn the burners off before you go to sleep or go out.

OVEN WARNINGS



WARNING

NEVER cover any holes or passages in the bottom oven cover. NEVER cover an entire oven rack with aluminum foil or like material. Covering the bottom cover and/or racks blocks airflow through the oven and could cause carbon monoxide poisoning.



Do not use aluminum foil or foil liners anywhere in the oven. Misuse traps heat and could cause a fire hazard or damage the range.



Always follow the manufacturer's directions when using cooking or roasting bags in the oven.



DO NOT clean the door gasket. The door gasket is essential for a good seal. Care should be taken not to damage or move the gasket.



Do not strike the oven glass. Do not spray water onto the oven glass when the oven is on or just after you have turned the oven off.

Stand away from the range when opening the door of a hot oven. The escaping hot air and steam can cause burns.



Do not use the oven for storage. Stored items can be damaged or ignite.



Keep the oven free from grease buildup.

Reposition oven racks only when the oven is cool to prevent burning or personal injury.



Do not heat unopened containers. Pressure in the container could build up, resulting in an explosion and/or personal injury.



Only use glass cookware that is recommended for use in gas ovens.

This prevents fire flare-ups from stored grease buildup.



Do not broil meat too close to the burner flame. Trim excess fat from meat before cooking. Meat fat can ignite, causing a fire hazard.



If a grease fire should occur in the oven, turn off the oven by pressing the Clear/Off pad. Keep the oven door closed to put out the fire.





Always bake and/or broil with the oven door closed. Broiling with the door partially or fully open can damage the surface burner control knobs and even the kitchen counter.

Keep the appliance area clear and free from combustible materials, gasoline, and other flammable vapors and liquids.



Do not use the oven to dry paper, clothes, etc. Such items might catch fire if overheated.

ELECTRIC WARMING DRAWER OR LOWER STORAGE DRAWER WARNINGS

-  The warming drawer is designed to keep hot cooked foods at serving temperature. Always start with hot food. Cold or room-temperature foods cannot be heated, warmed, or cooked in the warming drawer.
-  Do not touch the interior drawer surface or heating element. These surfaces may be hot and could burn you.
-  Use care when opening the drawer. Escaping hot air and/or steam can cause burns or personal injury.
-  Do not use aluminum foil to line the lower drawer. Aluminum foil will trap heat and alter the warming performance of the drawer. It could also damage the interior finish.

Never use the lower/warming drawer in the upper oven. Never put the lower/warming drawer in the upper oven during a self-cleaning cycle.

Never leave jars or cans of fat drippings in or near the lower drawer.

Do not leave or store paper products, plastics, canned food, or combustible materials in the drawer. Do not use the drawer to dry newspapers. They could ignite. Plastic items could melt.

SELF-CLEANING OVEN WARNINGS



Follow basic precautions when installing and using this range to reduce the risk of fire, electrical shock, injury, or death to persons, including:



Do not leave children unattended near the range during a self-cleaning cycle. The outside surfaces of the range get hot enough to burn if touched.



Stand away from the range when opening the oven door after a self-cleaning cycle. The oven will be VERY HOT and the escaping hot air and steam can cause burns.

Remove all racks and other utensils from the oven before starting a self clean cycle. The oven racks may become damaged, and foreign objects could ignite if left within the oven cavity.

Wipe off any excess spillage before using the self-cleaning operation.

Remove all cookware, oven probes, and any aluminum foil before using the self-cleaning operation.



Never self-clean with the lower drawer or drawer pan placed in the oven.



If the self-cleaning operation malfunctions, turn off the oven, disconnect the power supply, and contact a qualified service technician.



Do not use oven cleaners. Commercial oven cleaners or oven liners should NEVER be used in or around any part of the oven. Residue from oven cleaners will damage the inside of the oven during a self-cleaning operation.



Nickel oven shelves should be removed from the oven during a self-cleaning cycle. Porcelain-coated oven shelves may be cleaned in the oven during a self-cleaning cycle.

PROPER COOKING OF MEAT AND POULTRY



Make sure all meat and poultry is cooked thoroughly. Meat should always be cooked to an internal temperature of 160 °F (71 °C). Poultry should always be cooked to an internal temperature of 180 °F (82 °C). Cooking these foods to these minimally safe temperatures can help protect you and your family from food borne illnesses.

SAVE THESE INSTRUCTIONS

18_ important safety instructions

contents

INTRODUCING YOUR NEW RANGE	20	Overview
	20	
SURFACE COOKING	22	Lighting a gas surface burner
	22	Manually lighting a gas surface burner
	22	Flame size selection
	23	Gas surface burners and control knobs
	24	Cookware usage
	24	Center burner grate
	25	Wok grate (NX58H5650W* Only)
	26	Using the griddle
OPERATING THE OVEN	28	Oven control panels and displays
	31	Setting the clock
	32	Setting the timer on/off
	33	Positioning the oven racks
	34	Using the gliding rack (NX58H5650W* only)
	35	Oven vent
	35	Oven light
	36	Baking
	38	Convection baking and roasting
	41	Timed cooking
	43	Delay timed cooking
	45	Broiling
	47	Keep warm
	48	Using the easy cook feature
	51	Favorite cooking
	53	Sabbath function
	55	Extra features
USING THE WARMING DRAWER	57	About the warming drawer (Model NX58H5650W* only)
	58	Turning the warming drawer on or off
	57	
MAINTAINING YOUR APPLIANCE	59	Care and cleaning of the oven
	63	Care and cleaning of the cooktop
	67	Changing the oven light
	68	Removing and replacing the oven door
	70	Removing and replacing the warming drawer (Model NX58H5650W*)
	71	Removing and replacing the storage drawer (Model NX58H5600S*, NX58J5600S*, NX58M5600S*)
	72	Self-cleaning oven
TROUBLESHOOTING	76	Troubleshooting
	81	Troubleshooting and information codes
	76	
WARRANTY		Warranty
	82	

introducing your new range

OVERVIEW

MODEL NX58H5650W*

COOKTOP COMPONENTS

Heavy duty, continuous cast grates

- * Left burner grate
- * Center burner grate
- * Right burner grate

Note: the left and right grates can be used interchangeably.

* Wok grate

* Cooktop burner caps

Cooktop burners

Cooktop burner heads (5)

Cooktop burner cups (5)

(not shown under burners)

Electrodes (5)

(not shown under burners)

* Cooktop burner control knobs (5)

- Left-front burner control
- Left-rear burner control
- Center burner control
- Right-rear burner control
- Right-front burner control

OVEN COMPONENTS

* Oven racks (2)

Glide rack (1)

(as equipped)

Removable oven floor

Removable oven door

Griddle (1)

OVEN COMPONENTS

- Oven rack position guide
- Broil oven burner
- * Oven light (1)
- Convection fan (1)
- Convection heater (not shown)
- Bake oven burner

DISPLAY

OVEN VENT

(centered under oven control panel)

WARMING DRAWER COMPONENTS

- Removable warming drawer (1)
- Full-extension roller guide rails (2)
- Electric heating element (not shown under drawer)

ADJUSTABLE LEVELING LEGS (4)

(not shown)
ANTI-TIP BRACKET KIT (1)

MODEL NX58H5600S*, NX58J5600S*, NX58M5600S*

COOKTOP COMPONENTS

Heavy-duty continuous cast grates

- *Left burner grate
- *Center burner grate
- *Right burner grate

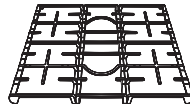

*Cooktop burner caps

Cooktop burners

Cooktop burner heads (5)

Cooktop burner cups (5)
(not shown under burners)

Electrodes (5)

(not shown under burners)

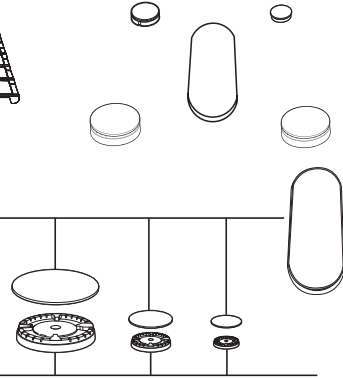

*Cooktop burner control knobs (5)

- Left-front burner control
- Left-rear burner control
- Center burner control
- Right-rear burner control
- Right-front burner control

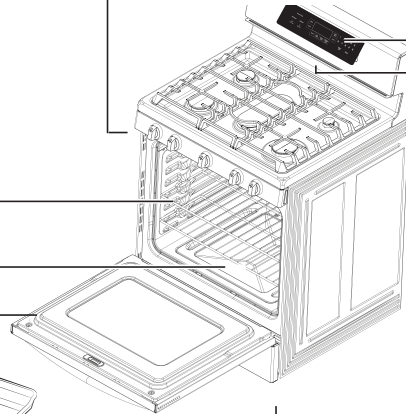

DISPLAY

OVEN VENT
(centered under oven control panel)

OVEN COMPONENTS

*Oven racks (2)

Removable oven bottom

Removable oven door

Gridle (1)

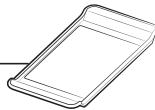

STORAGE DRAWER COMPONENTS

Removable Storage drawer (1)

OVEN COMPONENTS

Oven rack position guide

Broil oven burner

*Oven light (1)

Convection fan (1)

Bake oven burner

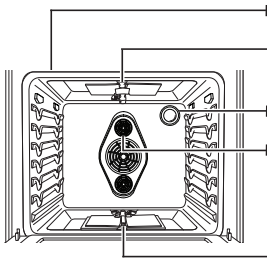

ADJUSTABLE LEVELING LEGS (4)
(not shown)

ANTI-TIP BRACKET KIT (1)

If you need an accessory marked with an * (asterisk), please contact the Samsung Call Center using the phone number listed on the last page of this manual or visit our on-line parts web site at www.samsungparts.com.

INTRODUCING YOUR NEW RANGE

surface cooking

WARNING BEFORE USING THE SURFACE BURNERS, make sure to follow all the safety warnings and precautions listed on page 8. Failure to do so could result in product damage, personal injury, and/or death.

LIGHTING A GAS SURFACE BURNER

Make sure all surface burners are positioned and assembled properly.

1. Push in and turn the control knob to the LITE position. You will hear a “clicking” sound indicating the electronic ignition system is working properly.
2. After the surface burner lights, turn the control knob to adjust the power setting of the surface burner and turn off the electronic ignition system.

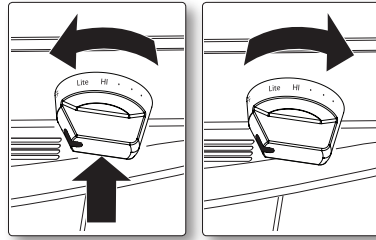

 We highly recommend using the left rear side burner for simmering tomato sauce and right rear side burner for melting chocolate

MANUALLY LIGHTING A GAS SURFACE BURNER

If a power failure occurs, the surface burners can still be lit manually.

-  Use extreme caution when manually lighting a surface burner.
1. Hold a long gas grill lighter to the surface burner you want to light.
 2. Push in and turn the control knob for that burner to the LITE position.
 3. After the burner has lit, set the control knob and the burner to the desired setting.

FLAME SIZE SELECTION

WARNING Flames larger than the bottom of the cookware will not result in faster heating, but could result in a fire hazard and/or personal injury.

The flames on the burners should always stay under the cookware. The flames should never extend beyond the bottom surface and/or up the sides of the cookware.

Always watch the flames when adjusting the heat setting with the control knob(s). The flames should always match the size of the cookware being used.

GAS SURFACE BURNERS AND CONTROL KNOBS

Your gas range cooktop has five gas burners. All sealed cooktop burners use an open-port design which provides easy assembly and accurate and dependable operation. The different burner sizes ensure you have the proper heat source for the desired cooking job.

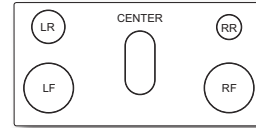

The right rear side burner provides precise cooking performance for delicate foods and foods that require low heat for long cooking times. The right rear side burner lets you use the LO setting for a very low simmer setting.

The left rear side and center round burners are general-purpose burners that can be used for most cooking. The HI to LO settings provide a wide range of cooking temperatures to meet your cooking needs.

The right and left front side burners provide maximum output. These burners can also be used as general-purpose burners, but they are designed to provide quick heat to large cookware. The right and left front side burners spread out the heat with a larger circle of flames. This provides better heat distribution for larger cookware (12 in/ 30.5 cm) or larger pots and pans.

BURNER POSITION	FUNCTION	TYPE OF FOOD
RIGHT FRONT (RF)	Quick heating	Boiling Food
RIGHT REAR (RR)	Low simmering	Chocolate, Casseroles, Sauces
CENTER	Griddle Cooking	Pancakes, Hamburgers, Fried Eggs, Hot Sandwiches
LEFT FRONT (LF)	Quick heating	Boiling Food
LEFT REAR (LR)	General heating Low simmering	General Food Tomato Sauce*, Casseroles

* Tomato sauce needs to be stirred during the low simmering

The center oval burner can also be used for large pots and pans, but is designed to be used with the center burner grate and/or the center griddle accessory (if equipped). The oval burner spreads out the heat more evenly over the large center cooking area.

Each surface burner has a control knob with settings from HI to LO. They also have a LITE setting that is only used to light the flame. The electronic ignition system sparks when the control knob is in the LITE position. The surface burner indicator next to the control knob shows which burner the knob controls.

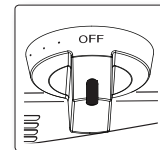

COOKWARE USAGE

Using the correct cookware can prevent many problems, such as uneven cooking or extended cooking times. Using the proper pans will reduce cooking times and cook food more evenly. Look for the following pan characteristics:

- Flat bottom and straight sides.
- Tight-fitting lid.
- Weight of handle does not tilt pan.
- Pan is well-balanced.
- Pan size matches the amount of food being prepared and the size of the surface burner.
- Made of material that conducts heat well.
- The pot/pan diameter matches the surface burner flame diameter.

What your cookware is made of determines how evenly and quickly heat is transferred from the surface burner to the pan bottom.

ALUMINUM: Excellent heat conductor. Some types of food will cause the aluminum to darken. (Anodized aluminum cookware resists staining and pitting.)

COPPER: Excellent heat conductor, but discolors easily.

STAINLESS STEEL: Slow heat conductor with uneven cooking results. Is durable, easy to clean, and resists staining.

CAST-IRON: A poor conductor, but retains heat very well. Cooks evenly once cooking temperature is reached.

ENAMELWARE: Heating characteristics will vary depending on base material.

GLASS: Slow heat conductor. Glass cookware is designed for two usages—top-of-range cooking or oven use. Only use cookware where it is designated to be used.



Do not place a small pan or pot with a bottom diameter of about 6 inches or less on the center grate. It is likely that the pan or pot will tip over. We strongly recommend you place small-sized pots or pans on the rear of either side grate.

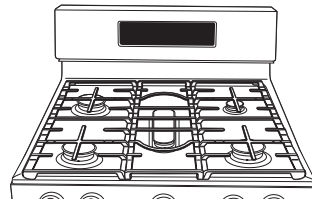

CENTER BURNER GRATE

Samsung gas ranges come with a center burner grate. This grate fits over the center oval burner. The center burner grate should not be placed over any other burners and no other center stovetop grates should be used with this range.



Center burner grate

WOK GRATE (NX58H5650W* ONLY)

Woks are often used for stir frying, pan frying, deep frying, and poaching. The wok grate provided can support a **12-14 inch pan or wok**.

HOW TO USE WOK GRATE

1. Before placing the wok grate, make sure that the burner is off and the grate is completely cool.
2. Place the wok grate on either side grate.
3. Place the wok on the wok grate.
(Make sure that the wok sits securely on the work grate.)
4. Turn on the burner and adjust the flame size.

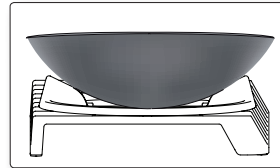
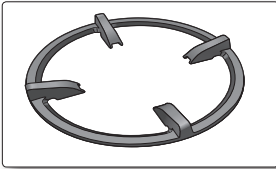

CAUTION Do not remove the wok grate until the cooktop grates, surfaces, and wok grate are completely cooled.

CAUTION When using the cooktop, oven, or broil systems, the wok grate on the cooktop may become very hot. Always use oven gloves when placing or removing the wok grate.

CAUTION Do not use a pot or pan with a flat bottom on the wok grate or a wok with a diameter that is smaller than the wok ring diameter. If you do, it is likely that the pan, pot, or wok will tip over.

CAUTION Using an oversized wok may cause the flames to spread out and damage the surrounding cooktop.

CAUTION Make sure the wok sits securely on the wok grate.

CAUTION Do not use the wok grate with the griddle at the same time.

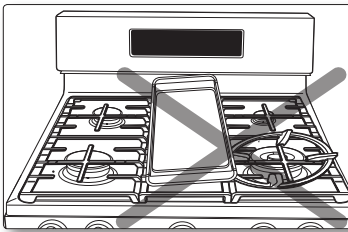

USING THE GRIDDLE

The non-fixed coated griddle provides an extra-large cooking surface for meats, pancakes, or other food usually prepared in a frying pan or skillet.

How to Place the Griddle: The griddle can only be used with the center burner. The griddle must be properly placed on the center grate as shown in the figure below.

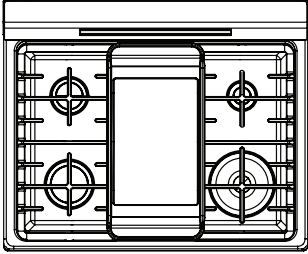

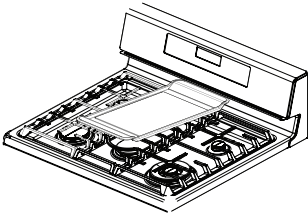

Warning: DO NOT remove the center grate when using the griddle.







How to cook: Preheat the griddle according to the guide below, and then adjust for the cooking conditions.

Type of Food	Preheat Time	Preheat Condition	Cook Condition
Pancakes	5 min	5 (MED-HI)	4 (MED)
Hamburgers	5 min	7 (HI)	5 (MED-HI)
Fried Eggs	5 min	7 (HI)	5 (MED-LO)
Bacon	-	None	4 (MED)
Breakfast Sausages	5 min	7 (HI)	5 (MED)
Grilled Cheese Sandwich	4 min	7 (HI)	6 (MED-HI)

 **DO NOT** remove the griddle until the cooktop grates, surfaces, and griddle are completely cooled.

 The griddle on the cooktop may become very hot when you use the cooktop, oven, or broil systems. Always use oven gloves when placing or removing the griddle.

-  Carefully put the griddle on the center grate.
-  Griddle settings may need to be adjusted if the griddle is used for an extended time.
-  Your griddle will discolor over time as it becomes seasoned with use.
-  After use, return the griddle to storage only after it has cooled.

Important Note :

- DO NOT overheat the griddle. This can damage the non-fixed coating.
- DO NOT use metal utensils that can damage the griddle surface. Do not use the griddle as a cutting board.
- DO NOT place or store items on the griddle.
- DO NOT turn the griddle over and use the underside for cooking. Use the top side of the griddle only.
- DO NOT use the griddle for any purpose other than cooking.
- Avoid cooking extremely greasy foods. Grease spill overs can occur.
- The griddle can become hot when surrounding burners are in use

operating the oven

OVEN CONTROL PANELS AND DISPLAYS

MODEL NX58H5650W*

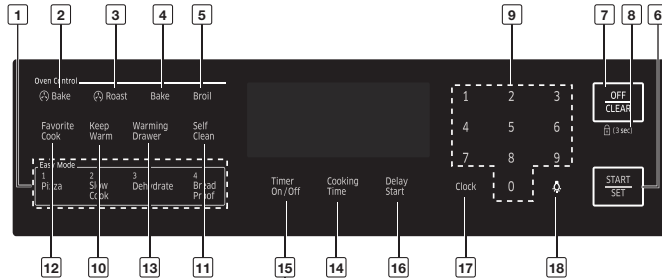

MODEL NX58H5600S*, NX58J5600S*, NX58M5600S*

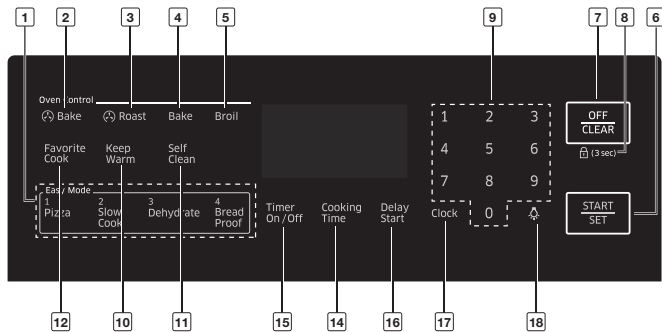

-  All oven operations are controlled with electronic touch pads. Use the following pads to program and operate all oven cooking, cleaning, and timing functions. All programmed settings and cooking statuses will show on the digital display.



Special feature, oven, and time controls

1	EASY COOK	Press to recall the Easy cook recipe setting of the oven.
2	CONVECTION BAKE (🔥 Bake)	Activates the convection bake function. Use this function to cook large amounts of baked goods on multiple shelves at the same time.
3	CONVECTION ROAST (🔥 Roast)	Activates the convection roast function. Use this function to cook large cuts of meat.
4	BAKE	Touch this pad to activate the Bake function. Evenly cooks food using the bottom oven burner.
5	BROIL	Activates the Broil function. Cooks foods using the top oven burner only.
6	START/SET	Touch this pad to start the oven cooking, cleaning, and/or timing functions.
7	OFF/CLEAR	Press to cancel all oven operations except the clock and timer.
8	HOLD 3 SEC	Deactivates the control panel touch pads to prevent the oven from accidentally being turned on. It also locks the oven door to prevent accidental tipping of the range. Touch pads will not work and the oven door will stay locked until this function is turned off.
9	NUMBER PADS	Touch these pads to set the desired times, temperatures, and preset oven functions.
10	KEEP WARM	Touch this pad to keep cooked foods warm after cooking. This lowers the oven temperature and maintains it at 150 °F to 200 °F (66 °C to 93 °C).
11	SELF CLEAN	Activates the self-cleaning oven function. Uses very high heat to burn off internal oven soilage.
12	FAVORITE COOK	Activates the favorite cook feature. This feature lets you preprogram up to three frequently used cooking cycles so they can be set and started with the touch of a button.
13	WARMING DRAWER (MODEL NX58H5650W*)	Touch this pad to activate the warming drawer. An electric heating element under the drawer uses three settings to keep cooked foods warm.
14	COOKING TIME	Touch this pad, and then the desired amount of time you want your food to cook. The oven will automatically shut off when the time has elapsed.
15	TIMER ON/OFF	Touch to select the timer feature. Activates a kitchen timer for the desired amount of time.

16 DELAY START	Allows you to set the oven to start and stop automatically. Use with Bake, Convection Bake, Convection Roast, Cook Time, or Self Clean functions.
17 CLOCK	Allows you to set the clock.
18 OVEN LIGHT	Touch this pad to turn the oven light on or off.

MINIMUM AND MAXIMUM SETTINGS

All the features listed in the following chart have minimum and maximum temperature or time settings.

FEATURE	MINIMUM SETTING	MAXIMUM SETTING
BAKE	150 °F (66 °C)	550 °F (288 °C)
BROIL	Lo	Hi
SELF-CLEAN	2 hours	4 hours
CONVECTION BAKE ( Bake)	150 °F (66 °C)	550 °F (288 °C)
CONVECTION ROAST ( Roast)	150 °F (66 °C)	550 °F (288 °C)
KEEP WARM	-	3 hours
WARMING DRAWER *	-	3 hours
BREAD PROOF	-	12 hours

* Model NX58H5650W* Only

If you set **Conversion On** for Convection Bake and/or Convection Roast, you can set the minimum temperature to 175 °F (79 °C).



Always bake and/or broil with the oven door closed. If you open the oven door while the oven is operating and leave it open, the oven burner will stop in 1 minute. This is not a product failure. The oven will automatically start again when you close the door.

Application mode : Conv. Bake, Conv. Roast, Bake, Broil, Pizza, Slow Cook, Dehydrate, Bread Proof, Favorite Cook.

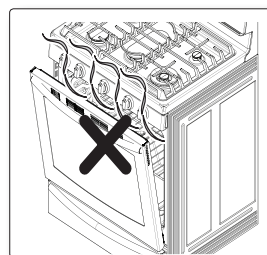

SETTING THE CLOCK

The clock must be set to the correct time of day for the automatic oven timing functions to work properly. The clock can be adjusted to show a 12-hour or 24-hour display. The 12-hour display is the default setting.

The time of day cannot be changed during a timed cooking, delayed start, self-cleaning, or Sabbath function operation.

How to set the clock

1. Press the **Clock** pad.



2. Enter the current time in hours and minutes using the number pads (e.g., 1, 3, 0).

The display will show the time of day, and the **Start** indicator will blink.



3. Press the **START/SET** pad to set and start the clock.

The display will show the time of day, and the **Start** indicator will turn off.



How to change between a 12-hour and 24-hour display

1. Press and hold the **Clock** and **0** pads for 3 seconds.
The display will show the present mode (e.g., 12Hr).

 If one pad is pressed before the other, -- -- will appear in the display.

Press the **OFF/CLEAR** pad and start again.



2. Press the **0** pad to toggle between the 12-hour and 24-hour display setting.

12Hr or **24Hr** will show in the display depending on your selection.

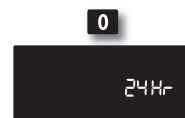

3. Press the **START/SET** pad to change the clock display mode.



SETTING THE TIMER ON/OFF

The timer counts down time remaining and beeps when the set time has elapsed. It does not start or stop cooking functions. You can use the kitchen timer at the same time as any other range functions and set it for any amount of time between 1 minute and 9 hours and 99 minutes.

How to set the timer

1. Press the **Timer On/Off** pad once for hours/minutes and twice for seconds. Press the pad three times to turn off the kitchen timer or cancel it before it starts to run.

The display will show **Timer**, and **-hr --min** will blink in the display. (Hr and min characters are not displayed on the NX58H5600S*, NX58J5600S, NX58M5600S*.)



2. Press the number pads to enter the amount of time you want in minutes, hours and minutes, or seconds (e.g., 1, 5).

The set time will show in the display.



3. Press the **Timer On/Off** pad to start the timer.

The display will show the remaining time. When time has elapsed, the oven will beep and the display will show **End** until you press the **Timer On/Off** pad. After the pad is pressed, the display will go back to showing the time of day.

You can cancel the timer at any time by pressing the **Timer On/Off** pad.



Timer On/Off

POSITIONING THE OVEN RACKS

The oven racks are removable and can be positioned in any of the seven oven rack positions. Each oven rack has a built-in stop to prevent it from accidentally being pulled completely out. Proper positioning of the oven racks will provide the best cooking results. The diagram to the right shows the rack positions.

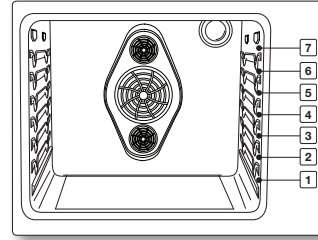

- Do not cover an oven rack with aluminum foil. This will disturb the heat circulation, resulting in poor baking.
- Do not place aluminum foil on the oven bottom. It can damage the surface of the oven bottom.
- Arrange the oven racks only when the oven is cool.
- When placing an oven rack in the topmost rack position (position 7), make sure the rack is stably situated on the embossed stop.

Oven rack positions

TYPE OF FOOD	RACK POSITION
Hamburgers and steaks	6 or 7
Toasts	5 or 6
Biscuits, muffins, brownies, cookies	4
Bundt or pound cakes	3
Angel food cake, pies	2
Roasts (small or large), ham, turkeys	1 or 2

Baking layer cakes

- Centering the baking pans in the oven will produce better cooking results.
 - When baking multiple items, make sure to leave a 1 to 1.5 in (2.5 to 3.8 cm) space around each item.
 - When baking on multiple racks, place the oven racks in positions 2 and 5.
 - When convection baking on multiple racks, place the oven racks in positions 2 and 5.
 - Place two pans in the rear of the top rack and the other two pans in the front of the bottom rack.
-  Proper positioning of food items in the oven will help you achieve the best cooking results.

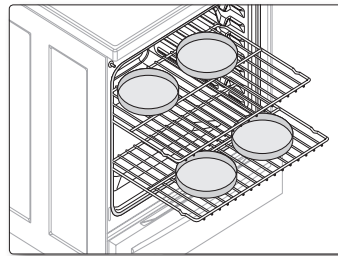

To remove an oven rack:

1. Pull the rack straight out until it stops.
2. Lift the front of the oven rack, and then pull to remove it from the oven.

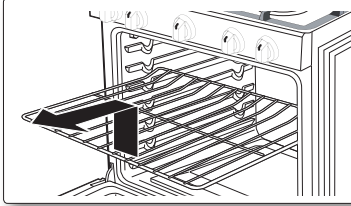

To replace an oven rack:

1. Place the back edge of the rack on the desired rack supports.
2. Lift the front of the rack, and then slide it into the oven.

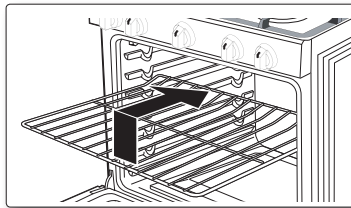

USING THE GLIDING RACK (NX58H5650W* ONLY)

The fully extendable Gliding Rack makes food preparation easier, especially when preparing heavier dishes. The Gliding Rack has 2 glide tracks that allow you to extend the rack with food on it out of the oven for easier access and removal.

Installing the Gliding rack

- With the Gliding rack in the “Closed” position and the oven off, carefully insert the Gliding Rack between the guides until the rack reaches the back.
- When using the Gliding Rack in the oven, be sure to pull on the handle of the rack only to slide it in and out. If you grasp the frame while using the rack, you can pull the entire Gliding Rack out of the oven.

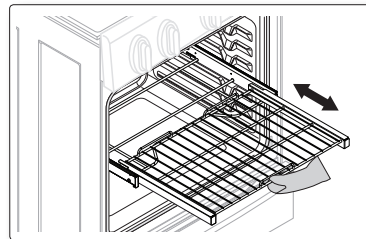
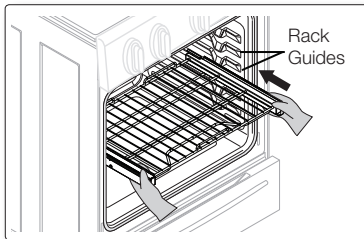

Removing the Gliding rack

- With the Sliding rack in the “Closed” position and the oven off and cool, grasp the rack and frame and pull both towards you to remove.

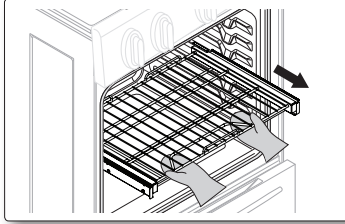

Do not install the Gliding rack directly above the Flat rack and Recessed rack. You will not be able to install it properly and the rack could fall.

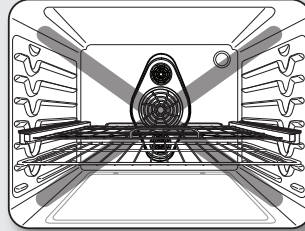
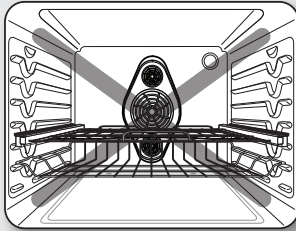

You can install the Gliding rack in any rack positions except the highest (level 7) and lowest (level 1) rack position in the oven.

OVEN VENT

The oven vent is located under the oven control panel. Do not block or place items in front of the oven vent. Proper air circulation prevents oven burner combustion problems and ensures good cooking results. Since the vent and area around the vent can become hot, use care when placing items near the oven vent. Hot steam could heat or melt items placed in front of the oven vent.

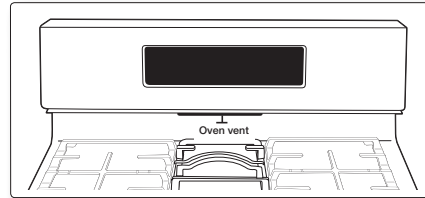

OVEN LIGHT

The oven has a light that is located on the rear oven wall in the upper right-rear corner. The light can be turned on or off by touching the Oven Light pad on the oven control panel. The oven light allows you to check cooking progress without opening the oven door. Always use a 40-watt appliance bulb when replacing the oven light. See page 61 for light-changing instructions.

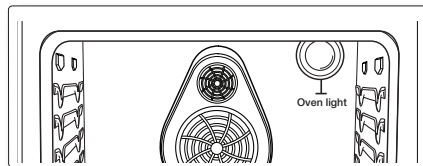

BAKING

The Bake function lets you program the oven to bake at any temperature between 150 °F (66 °C) and 550 °F (288 °C).

How to set the oven temperature

1. Position the oven rack in the desired location.
2. Press the **Bake** pad. The oven will beep every time a pad is pressed.

The default temperature, **350°**, and the **Start** indicator will blink on the display. If the default temperature is the desired cooking temperature, skip to step 4.



3. Press the number pads to enter the desired cooking temperature (for example, 3, 7, 5).

The selected cooking temperature and the **Start** indicator will blink on the display.



4. Press the **START/SET** pad.

The oven will automatically light and start preheating. The display will show a blinking •, along with **150°**, **Bake**, and the **bake element** icon, until the oven reaches **150°**. Then, the display will just show the actual oven temperature.

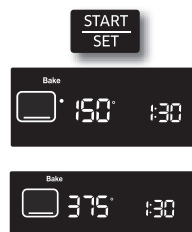

When the oven reaches the desired baking temperature, it will beep 6 times.



5. Place the food in the oven, and then close the oven door. Preheating is very important for good baking results.
6. When baking is complete, remove the item(s) from the oven, close the oven door, and then press the **OFF/CLEAR** pad.

The oven will shut off, and the display will show the time of day.



To change a programmed baking temperature, press the **Bake** pad, enter the new baking temperature, and then press the **START/SET** pad. If the oven temperature is higher than the new setting, the oven will beep 6 times, then show the new setting. The oven will complete cooking at the new temperature.

If your baking results are not what you are used to, the preset oven cooking temperature can be adjusted $\pm 30^{\circ}\text{F}$ ($\pm 15^{\circ}\text{C}$) as follows:

1. Press and hold the **Bake** and **0** pads for 3 seconds.

The display will show **AdJ** and **0**.



2. Press the **Bake** pad to toggle between + or - temperature adjustments.

3. Press the number pads to enter the desired temperature adjustment (for example, 1, 0).

The display will show **AdJ** and **10**.



4. Press the **START/SET** pad.

The oven will beep twice, and the display will show the time of day. The next time you bake, the oven will use the new temperature setting.



-  This adjustment will not affect the broiling or the self-cleaning temperatures. The adjustment will be retained in memory after a power failure.

CONVECTION BAKING AND ROASTING

The Convection Bake function lets you program the oven to bake at any temperature between 150 °F (66 °C) and 550 °F (288 °C). The Convection Roast function lets you program the oven to roast at any temperature between 150 °F (66 °C) and 550 °F (288 °C). The convection fan in the back of the oven cavity circulates the hot air evenly throughout the oven cavity. As a result, foods are evenly cooked and browned in less time than with regular heat.

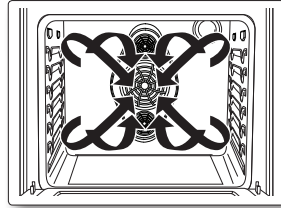

Convection baking

- Ideal for foods being cooked on multiple racks.
- Good for large quantities of baked foods.
- Provides good results with cookies, biscuits, brownies, cupcakes, cream puffs, sweet rolls, angel food cake, and bread.
- Cookies have best cooking results when cooked on flat cookie sheets.
- When convection baking on a single rack, place the oven rack in position 3 or 4.
When convection baking on multiple racks, place the oven racks in position 2 and 5.



 The oven automatically adjusts the temperature for convection baking with the Convection Auto Conversion feature. See page 51 for details.

Convection roasting

- Good for larger tender cuts of meat, uncovered.
- Place a broil pan and grid under the meat or poultry during convection roast for best results. The pan catches grease spills and the grid prevents grease splatters.



Meat and poultry are browned on all sides as if they were cooked on a rotisserie. Heated air will be circulated over, under, and around the food being roasted. The heated air seals in juices quickly for a moist and tender interior while creating a rich, golden-brown exterior.

See the “Recommended convection roasting guide” on page 40 for recommended cooking times and temperatures.

How to set the oven for convection baking or roasting

1. Position the oven rack in the desired location.
2. Press the **Convection Bake** (🌀 Bake) or **Convection Roast** (🌀 Roast) pad. The oven will beep every time a pad is pressed.
The default temperature, **350°**, will blink on the display. If the default temperature is the desired cooking temperature, skip to step 4.



3. Press the number pads to enter the desired cooking temperature (for example, 4, 2, 5).
The selected cooking temperature will blink on the display.



4. Press the **START/SET** pad.
The oven will automatically light and start preheating. The display will show a blinking •, along with **150°**, **Conv. Bake** (🌀 Bake), and the **convection bake element and fan** icons, until the oven reaches 150°. Then, the display will just show the actual oven temperature.



When the oven reaches the desired baking or roasting temperature, it will beep 6 times.



5. Place the food in the oven, and then close the oven door.
Preheating is very important for good baking results. All roasting should be done on a broil pan and grid.
6. When baking or roasting is complete, remove the item(s) from the oven, close the oven door, and press the **OFF/CLEAR** pad.
The oven will shut off, and the display will show the time of day.



To change a programmed baking or roasting temperature, press the **Convection Bake** (🌀 Bake) or **Convection Roast** (🌀 Roast) pad, enter the new cooking temperature, and then press the **START/SET** pad. If the oven temperature is above the new setting, the oven will beep 6 times, then show the new setting. The oven will complete cooking at the new temperature.

Convection roasting guide

The size, weight, thickness, roasting temperature setting, and your preference of doneness will affect the roasting time.

The following guide is based on foods starting at refrigerator temperature.

Food		Minutes Per Pound	Oven Temperature	Internal Temperature	
Beef	Rib Roast (3 to 5 lb)	Medium	28–33	350 °F (177 °C)	160 °F (71 °C)
		Well Done	30–38	350 °F (177 °C)	170 °F (77 °C)
	Tenderloin Roast (2 to 3 lb)	Medium	35–45	350 °F (177 °C)	160 °F (71 °C)
		Well Done	45–55	350 °F (177 °C)	170 °F (77 °C)
Pork	Roast (Bone-in or Boneless) (3 to 5 lb)		22–28	350 °F (177 °C)	170 °F (77 °C)
	Chops (0.5- to 1-in thick)	2 chops	30–40 total	350 °F (177 °C)	170 °F (77 °C)
		4 chops	40–50 total	350 °F (177 °C)	170 °F (77 °C)
		6 chops	45–55 total	350 °F (177 °C)	170 °F (77 °C)
Poultry	Chicken, Whole (2.5 to 3.5 lb)		26–30	375 °F (191 °C)	180 °F (82 °C)
	Turkey, Whole (Unstuffed *) (10 to 16 lb)		10–16	325 °F (163 °C)	180 °F (82 °C)
	Turkey, Whole (Unstuffed *) (18 to 24 lb)		8–15	325 °F (163 °C)	180 °F (82 °C)
	Turkey Breasts (4 to 6 lb)		18–23	325 °F (163 °C)	170 °F (77 °C)
	Cornish Hen (1 to 1.5 lb)		50–75 total	325 °F (163 °C)	180 °F (82 °C)
Lamb	Half Leg (3 to 4 lb)	Medium	25–30	325 °F (163 °C)	160 °F (71 °C)
		Well Done	30–35	325 °F (163 °C)	170 °F (77 °C)
	Whole Leg (6 to 7 lb)	Medium	25–30	325 °F (163 °C)	160 °F (71 °C)
		Well Done	30–35	325 °F (163 °C)	170 °F (77 °C)

 * Stuffed turkey requires additional roasting time. The minimum safe temperature for stuffing in poultry is 165 °F (74 °C).

TIMED COOKING

The Cook Time function lets you program the oven to cook food at a set temperature for a desired length of time. At the end of the set time, the oven will automatically shut off.



Use caution when using the Cooking Time or Delay Start functions. These functions are best used when cooking cured or frozen meats and most fruits and vegetables. Foods that can easily spoil, like milk, eggs, fish, poultry, and meats, should be chilled in a refrigerator before they are placed in the oven. Even when chilled, they should not stand for more than 1 hour before cooking begins and should be removed promptly when cooking is completed. Eating spoiled food can result in sickness from food poisoning.

How to set the oven for timed cooking

1. Position the oven rack in the desired location. Place the food in the oven, and then close the oven door.
2. Press the **Bake** pad.

The default temperature, **350°**, will blink on the display. If the default temperature is the desired cooking temperature, skip to step 4.



3. Press the number pads to enter the desired cooking temperature (for example, 3, 7, 5).

The selected cooking temperature will blink on the display.



4. Press the **Cooking Time** pad.

The display will show **-hr --min.**

(hr, min characters are not displayed on the NX58H5600S*, NX58J5600S*, NX58M5600S*)



5. Press the number pads to enter the desired cooking time.

The display will show the selected time, and the **Start** indicator will blink. You can set the time to any duration between 1 minute and 9 hours and 99 minutes.



6. Press the **START/SET** pad.

The oven will automatically light and start preheating. The display will show a blinking • along with the **default** or **selected temperature, Bake**, and the **bake element** icon, until the oven reaches that temperature.

When the oven reaches the desired temperature, it will beep 6 times. The oven will start cooking for the set amount of time, and the remaining cooking time will be displayed.

To see the time of day, press and hold the **Clock** pad. When the **Clock** pad is released, the display will go back to the remaining cooking time. When the cooking time has elapsed, the oven will automatically shut off and the display will show the time of day.

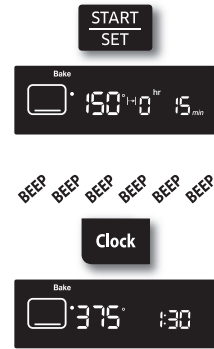

To change a programmed baking temperature, press the **Bake** pad, enter the new baking temperature, and press the **START/SET** pad. If the oven temperature is above the new setting, the oven will beep 6 times, then show the new setting. The oven will complete cooking at the new temperature.

To change a programmed cooking time, press the **Cooking Time** pad, enter the new cooking time, and then press the **START/SET** pad. The oven will continue cooking for the remaining new set time.

- ☑ Place food in the oven after preheating if the recipe calls for it. Preheating is important for good baking results. After the oven has reached the desired cooking temperature, it will beep 6 times.

DELAY TIMED COOKING

The Delay Start function lets you use the kitchen timer to automatically start and stop another cooking program (Bake, Convection Bake, or Convection Roast). Delay Start can be set before other cooking operations by up to 12 hours. The clock must be set to the correct time of day for Delay Start to work properly.



Use caution when using the Cooking Time or Delay Start functions. These functions are best used when cooking cured or frozen meats and most fruits and vegetables. Foods that can easily spoil, like milk, eggs, fish, poultry, and meats, should be chilled in a refrigerator before they are placed in the oven. Even when chilled, they should not stand for more than 1 hour before cooking begins and should be removed promptly when cooking is completed. Eating spoiled food can result in sickness from food poisoning.

How to set the oven for delay timed cooking

1. Position the oven rack in the desired location. Place the food in the oven, and then close the oven door.
2. Press the pad for the desired cooking operation, e.g., **Bake**.

The default temperature, **350°**, and the **Start** indicator will blink on the display. If the default temperature is the desired cooking temperature, skip to step 4.



3. Press the number pads to enter the desired cooking temperature (for example, 3, 7, 5).

The selected cooking temperature and the **Start** indicator will blink on the display.



4. Press the **Cooking Time** pad.

The display will show the selected cooking temperature, **Bake**, and **-hr --min.** (HR, min characters are not displayed on the NX58H5600S*, NX58J5600S*, NX58M5600S*)



5. Press the number pads to enter the desired cooking time.

The display will show the selected cooking time, and the **Start** indicator will blink. You can set the time to any amount of time between 1 minute and 9 hours and 99 minutes.



6. Press the **Delay Start** pad.

The display will show **Delay**, and -- -- will blink.



7. Press the number pads to enter the time you want the oven to turn on (for example, 4, 3, 0).

The **Start** indicator will blink under **Delay** and the selected start time.



8. Press the **START/SET** pad.

The oven will automatically turn on and beep when the set start time is reached.

The oven will automatically light and start preheating. When the oven reaches the desired cooking temperature, it will beep 6 times.

The display will count down the set cooking time.

When the cooking time has elapsed, the oven will automatically shut off and the display will show the time of day.



To change a programmed starting time, press the **Delay Start** pad, enter the new starting time, and then press the **START/SET** pad. The oven will start cooking at the new start time.

To change a programmed baking temperature, press the **Bake** pad, enter the new baking temperature, and then press the **START/SET** pad. If the oven temperature is above the new setting, the oven will beep 6 times, then show the new setting. The oven will complete cooking at the new temperature.

To change a programmed cooking time, press the **Cooking Time** pad, enter the new cooking time, and then press the **START/SET** pad. The oven will continue cooking for the remaining new set time.

 Place food in the oven after preheating if the recipe calls for it. Preheating is important for good baking results. After the oven has reached the desired cooking temperature, it will beep 6 times.

BROILING

The Broil function allows you to cook and brown foods using only a top heat source. The oven door must remain closed during broiling. The meat or fish should always be placed on a broiling grid in a broiling pan.



If a fire occurs during broiling, leave the oven door closed and turn off the oven. If the fire continues, throw baking soda on the fire or use a foam-type fire extinguisher. Do not throw water or flour on the fire. Flour may explode and water can cause a grease fire to spread. Both can cause personal injury and/or property damage.

How to set the oven for broiling

1. Place the food on a broiling pan with insert grid. Place the food and pan on the top oven rack, positioned as recommended in the "Recommended broiling guide" on page 42. Close the oven door.
2. Press the **Broil** pad once for Hi and twice for Lo. The oven will beep every time a pad is pressed.

The **Start** indicator will blink to the right of **Hi** or **Lo** and **Broil** on the display. Use Lo to cook foods such as poultry or thick cuts of meat thoroughly without overbrowning them.

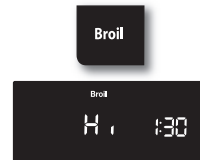

3. Press the **START/SET** pad.

The oven will automatically light the top oven burner and start cooking.

The display will show the selected broil setting (Hi or Lo), the broil element icon, and **Broil**.

Broil on one side until food is browned; turn and cook on the other side.

When cooking is completed, press the **OFF/CLEAR** pad to shut off the oven or to cancel broiling at any time. The display will show the time of day.

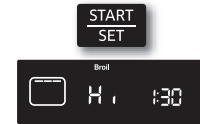

To change a programmed broiling setting, press the **Broil** pad to toggle the setting between Hi and Lo. Press the **START/SET** pad to complete cooking at the new setting.

Broiling guide

The size, weight, thickness, broiling temperature setting, and your preference of doneness will affect the broiling time. The following guide is based on meats and/or fish starting at refrigerator temperature.

Food	Quantity and/or Thickness	Rack position*	1st side time (min.)	2nd side time (min.)	Comments
Ground Beef Well Done	1 lb (4 patties) 0.5- to 0.75-in thick	6 or 7	7-10	5-7	Space evenly. Up to 8 patties may be broiled at once.
Beef Steaks Medium Well Done Medium Well Done	1-in thick 1 to 1.5 lbs 1.5-in thick 2 to 2.5 lbs	6 6 6 6	10-12 12-14 15-18 18-22	5-7 6-8 14-17 17-19	Steaks less than 1-in thick cook through before browning. Pan frying is recommended. Slash fat.
Chicken	1 whole cut-up 2 to 2.5 lbs Split lengthwise 2 breasts	4 5	30-35 15-20	15-20 7-12	Broil skin-side-down first. Spread open. Brush with melted butter before and halfway through broiling.
Fish Fillets	0.25- to 0.5-in thick	6	6-10	3-4	Handle and turn very carefully. Brush with lemon butter before and during cooking, if desired.
Ham Slices (precooked)	0.5-in thick	6	7-10	5-6	Increase time 5 to 10 minutes per side for 1.5-in thick or home-cured ham.
Pork Chops Well Done	2 (0.5-in thick)	6	8-11	4-6	Slash fat.
Lamb Chops Medium Well Done	2 (1-in thick) about 10 to 12 oz	6 6	8-12 10-16	5-8 7-11	Slash fat.

 * See illustration on page 33 for description of rack positions.

KEEP WARM

The Keep Warm function allows you to keep cooked foods warm at a low baking temperature. The Keep Warm feature keeps cooked food warm for serving up to 3 hours after cooking has finished. After 3 hours, the feature automatically shuts off the oven.

How to use the keep warm feature

1. Position the oven rack in the desired location. Place the food in the oven and close the oven door.
2. Press the **Keep Warm** pad.

The **Start** indicator will blink under the time of day and **Warm** appears on the display.



3. Press the **START/SET** pad.

The oven will automatically light and start preheating to the Keep Warm temperature (approx. 170 °F [77 °C]). The display will show the **oven element** icon, **Warm**, and the time of day.

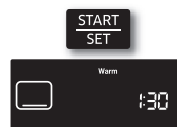

To cancel **Keep Warm** and shut the oven off, press the **OFF/CLEAR** pad. The display will show the time of day.

To program Keep Warm after a timed cooking function, press the **Keep Warm** pad after you program the timed cooking function. When Time Cook is complete, the oven will beep 6 times and lower the oven temperature to the Keep Warm setting. The oven will maintain that temperature until Keep Warm is canceled.

USING THE EASY COOK FEATURE

Pizza

The pizza function is designed to produce a crisp and browned bottom while keeping the topping moist.

How to set the Pizza function.

1. Press the **Pizza** pad.

NX58H5600S*
NX58J5600S*
NX58M5600S* NX58H5650W*



2. Press the **START/SET** pad to begin pizza cooking.

NX58H5600S*
NX58J5600S*
NX58M5600S* NX58H5650W*



- Use only 1 rack and place the rack in position 3 or 4 for the best results when using the pizza feature.
- The default temperature is 400 °F. You may adjust the oven temperature to fit your needs.
- Follow the package instructions for preheating and baking times.

Slow Cook

The Slow Cook feature can be used to cook food more slowly at lower oven temperatures. The extended cooking times allow better distribution of flavors in many recipes. This feature is ideal for roasting beef, pork, and poultry. Slow cooking meat may cause the exterior of the meat to become dark but not burnt. This is normal.

How to set the Slow Cook.

1. Press the **Slow Cook** pad once for HI or twice for LO.

NX58H5600S*
NX58J5600S*
NX58M5600S* NX58H5650W*



2. Press the **START/SET** pad to begin slow cooking.

NX58H5600S*
NX58J5600S*
NX58M5600S* NX58H5650W*



- Use only 1 rack and place the rack in position 3 or 4 for the best results.
- Preheating the oven will not be necessary.

Dehydrate

This function is designed to dry food or remove the moisture from food using heat circulation.

How to set the Dehydrate function.

1. Press the **Dehydrate** pad.



2. Press the number pads for the desired temperature.
(set between 100 °F and 175 °F)



3. Press the **START/SET** pad to start the dehydrate mode.



4. When the food is dehydrate, press the **OFF/CLEAR** pad.



- Do not preheat the oven for this function.
- After drying the food, keep it in a cool and dry place.
- If the temperature setting is out of range, an error will be displayed.

Dehydrate guide

Category	Rack position		Recommended weight (oz)	Optimum temp.
	Single rack	Multi rack		
Vegetables	3 or 4	2 and 5	9 to 21	100-150 °F
Fruits	3 or 4	2 and 5	9 to 21	100-150 °F
Meats	3 or 4	2 and 5	14 to 30	145-175 °F

Bread Proof

The proofing feature maintains a warm environment useful for rising yeast-leavened products.

How to set the oven for proofing.

1. Enter the proofing mode.
Press the **Bread Proof** pad.



2. Start the proofing function. Press the pad. The proofing feature automatically provides the optimum temperature for the proof process, and therefore does not have a temperature adjustment.



3. Press the **OFF/CLEAR** pad at any time to turn off the proofing feature.



- If you press the BREAD PROOF pad when the oven temperature is above 100°F, Hot will appear in the display. Because these functions produce the best results when started while the oven is cool, we recommend that you wait until the oven has cooled down and Hot disappears from the display.
- To avoid lowering the oven temperature and lengthening proofing time, do not open the oven door unnecessarily.
- Check bread products early to avoid over-proofing.
- Do not use the proofing mode for warming food or keeping food hot. The proofing oven temperature is not hot enough to hold foods at safe temperatures. Use the warm feature.
- For best results, place the dough in a dish in the oven on rack 3 or 4 and cover the dough with a cloth or with plastic wrap. (The plastic may need to be anchored underneath the container so the oven fan will not blow it off.)



FAVORITE COOKING

The Favorite Cook function allows you to preprogram up to 3 different cooking functions or favorite recipe settings so they can be recalled and started at a touch of a button. You can use only Bake, Convection Bake, or Roast Convection as a Favorite Cook selection. You can not use any Delay Start functions as a Favorite Cook selection.

How to set a favorite cook selection.

1. Press the pad for the cooking operation you want to store, e.g., **Bake**. The oven will beep every time a pad is pressed.

The default temperature **350°** will blink on the display. If the default temperature is the desired cooking temperature, skip to step 3.



2. Press the number pads to enter the desired cooking temperature (for example, 3, 7, 5).

The selected cooking temperature will blink on the display.



3. Press the **Favorite Cook** pad once to store these settings under Recipe 1, twice to store them under Recipe 2, or three times for Recipe 3.

The corresponding number and the setting will show on the display, and **Favorite Cook** will blink under the selected Favorite Cook setting for that recipe.



4. Press the **START/SET** pad.

The display will show the last set or used Favorite Cook temperature setting and the current time of day.



-  Press the **START/SET** pad once to save the Favorite Cook setting or twice to save and start Favorite Cook at the selected setting.



How to use or recall a favorite cook selection

1. Position the oven rack in the desired location.
2. Press the **Favorite Cook** pad . To recall the Favorite Cook setting you want from its storage location, press the **Favorite Cook** pad as shown below:
 - 1 time for Recipe 1,
 - 2 times for Recipe 2,
 - 3 times for Recipe 3.**Favorite Cook** will blink under the selected Favorite Cook setting on the display for that recipe.



3. Press the **START/SET** pad.
 - A • will blink to the left of the default or actual temperature until the selected temperature is reached. The oven will beep 6 times. The **default or actual temperature**, the cooking function, the cooking function icon, and the time of day will be displayed.
 - When the oven reaches the desired cooking temperature, it will beep 6 times.



4. Place the food in the oven and close the oven door. Preheating is very important for good baking or roasting results.
5. When cooking is complete, remove the item(s) from the oven, close the oven door, and press the **OFF/CLEAR** pad.
 - The oven will shut off and the display will show the time of day.



SABBATH FUNCTION

(For use on the Jewish Sabbath and Holidays)



For further assistance, guidelines for proper usage and a complete list of models with the Sabbath feature, please visit the web at <http://www.star-k.org>.

The Sabbath function can only be used with the Bake and Cooking Time settings. The oven will operate at the set temperature and stay on until the Sabbath function is cancelled or the set Cooking Time has elapsed. When Sabbath is selected, it overrides the preset factory energy-saving features. All display lighting, oven signals, most control pads, and the convection fan will be deactivated.

How to set the Sabbath function

1. Position the oven rack in the desired location. See page 30.
2. Press the **Bake** pad. The oven will beep every time a pad is pressed until the Sabbath function is activated. The default temperature, **350°**, will blink on the display. If the default temperature is the desired cooking temperature, skip to step 4.



3. Press the number pads to enter the desired cooking temperature (for example, 3, 7, 5). The selected cooking temperature will blink on the display.



4. Press the **START/SET** pad.



5. Press and hold the **Clock** and **Timer On/Off** pad at the same time for 3 seconds.

The display will show **SAb**. The oven signals, display LEDs, and all oven controls except the number, **Bake**, **Cooking Time**, **START/SET**, and **OFF/CLEAR** pads will be deactivated.

In approximately 20 seconds, the control panel will “click” and the oven will start the lighting and preheating process. After the oven reaches the selected cooking temperature, the oven will continue to cook at that temperature until the Cook Time has elapsed or the Sabbath function is cancelled. The display will not count down the set cook time, but the oven will shut off at the end of the set time.



How to set timed bake in Sabbath mode

To set timed bake in Sabbath mode, follow steps 1 through 3 from “How to set the Sabbath function”, and then follow the steps below.

1. Press the **Cooking Time** pad.

The display will show --hr --min.

(Hr and min characters are not displayed on the NX58H5600S*, NX58J5600S, NX58M5600S*.)



2. Press the number pads to enter the desired cooking time.

The **START** indicator will blink on the display. You can set the time to any length of time between 1 minute and 9 hours and 99 minutes.

Proceed to step 4 from “How to set the Sabbath function”.



How to change the temperature and exit the Sabbath function

To change a programmed baking temperature, press the **Bake** pad, enter the new baking temperature, and then press the **START/SET** pad. In approximately 20 seconds, the control panel will “click” and the oven will complete cooking at the new temperature.

To exit the Sabbath function, press and hold the **Clock** and **Timer On/Off** pad at the same time for 3 seconds. The display will show the time of day.

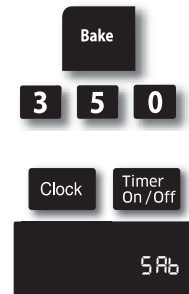

EXTRA FEATURES

12-Hour/3-Hour Energy-Saving

With this feature, should you forget and leave the oven on, the control will automatically turn off the oven after 12 hours during baking functions or after 3 hours during a broil function.

How to turn 12-hour energy-saving feature on or off.

1. Press the **Cooking Time** and **0** pads at the same time for 3 seconds.
The display will show **12 Hr** (12 hours shut-off) or **-- Hr** (no shut-off).
The default is **12 Hr**.
2. Press the **0** pad to select ON (**12 Hr**) or OFF (**-- Hr**).
3. Press the **START/SET** pad to save and start the feature settings.

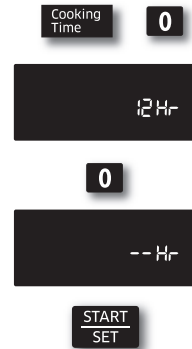

Fahrenheit or Centigrade Temperature Selection

The oven control can be programmed to display temperatures in Fahrenheit or Centigrade.

The oven has been preset at the factory to display in Fahrenheit.

How to change the display from Fahrenheit to Centigrade or from Centigrade to Fahrenheit.

1. Press the **Broil** and **0** pads at the same time for 3 seconds.
The display will show **F** (Fahrenheit) or **C** (Centigrade).
The default is **F**.
2. Press the **0** pad to select **F** or **C**. Pressing the **0** pad toggles between **F** and **C**.
3. Press the **START/SET** pad to save and set the temperature selection.

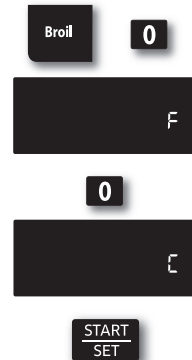

Convection Auto Conversion Feature

When using convection bake, the convection auto conversion feature will automatically convert entered regular baking temperatures to convection baking temperatures. This feature is activated so that the display will show the actual converted (reduced) temperature.

How to enable or disable the auto conversion feature.

1. Press the **Convection Bake** and **0** pads at the same time for 3 seconds.
The display will show **Con On** (enabled) or **Con Off** (disabled).
The default setting is **Con Off**.
2. Press the **0** pad to select **Con On** or **Con Off**.
3. Press the **START/SET** pad to save and set the auto conversion feature.

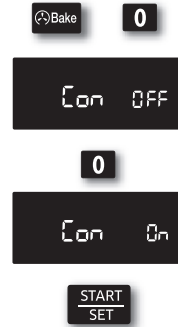

Sound On/Off

By using this feature, you can set the oven controls to operate silently.

How to turn the sound on or off.

1. Press the **Oven Light** and **0** pads at the same time for 3 seconds.
The display will show **Snd On** (sound on) or **Snd OFF** (sound off).
The default setting is **Snd On**.
2. Press the **0** pad to toggle between **Snd On** and **Snd OFF**.
3. Press the **START/SET** pad to save and set the audible signal setting.

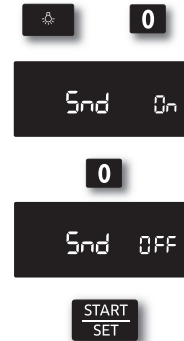

using the warming drawer

ABOUT THE WARMING DRAWER (MODEL NX58H5650W* ONLY)

The Warming Drawer lets you keep hot, cooked foods warm. Always start with hot food. Do not use the warming drawer to heat or reheat cold food.

Allow approximately 25 minutes for the warming drawer to preheat.



Do not use plastic containers or plastic wrap in the warming drawer. The plastic will melt upon direct contact with the drawer. Melted plastic may not be removable and is not covered under the warranty.

- Do not line the warming drawer with aluminum foil. Foil is an excellent heat insulator and will trap heat beneath it. This will upset the performance of the drawer and could damage the interior finish.
- Do not put liquid or water in the warming drawer.
- All foods placed in the warming drawer should be covered with a lid or aluminum foil. When warming pastries or breads, vent the cover to allow moisture to escape.
- Remove serving spoons, etc., before placing containers in the warming drawer.
- Food should be kept hot in its cooking container or transferred to a heat-safe serving dish.
- The warming drawer cannot be used during a self-cleaning cycle.
- The warming drawer will shut off automatically after 3 hours.

TURNING THE WARMING DRAWER ON OR OFF

1. Press the **Warming Drawer** pad once for low warming temperature, **twice** for medium warming temperature, **three** times for high warming temperature, or **four** times to shut off the warming drawer.

Warming Drawer and the selected temperature light will show on the display, and the warming drawer will start to heat.

2. To shut off the warming drawer, press the **Warming Drawer** pad until the drawer shuts off.

 Pressing the **OFF/CLEAR** pad does not turn off the warming drawer.



Recommended settings

DRAWER SETTING	TYPE OF FOOD*
LOW	Soft rolls, empty dinner plates
MED	Roasts (beef, pork, lamb), casseroles, vegetables, eggs, pastries, biscuits, hard rolls, gravies
HIGH	Poultry, pork chops, hamburgers, pizza, bacon, fried foods

* Different types of food may be placed in the warming drawer at the same time. For best results, do not leave food in the warming drawer for longer than 1 hour. Do not leave smaller quantities or heat-sensitive foods, such as eggs, for longer than 30 minutes.

maintaining your appliance



- Always make sure the controls are OFF and all surfaces are cool before removing and/or cleaning any of the range parts. This will prevent you from getting burned.
- If the range is pulled out from the wall for any reason, make sure the anti-tip device is reengaged after the range has been pushed back into place. Failure to take this precaution could result in the range tipping and personal injury.

CARE AND CLEANING OF THE OVEN

The oven and surface burner control panels can be easily cleaned with a damp cloth and/or glass cleaner. Heavily soiled areas can be cleaned with warm, soapy water.



- Never use steel wool or abrasive cleansers.
- Protect the surface from sharp objects.
- All of the above items can damage the surface.

Oven control panel

1. To lock the oven controls and the oven door, press and hold the **OFF/CLEAR** pad for 3 seconds. This prevents accidental oven operation and appliance tipping.

The oven will beep and the display will show Loc, the time of day, and the Lock icon.



2. Clean spatters with a damp cloth, glass cleaner, or warm, soapy water.

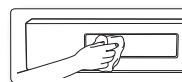

3. To unlock the controls and the door, press and hold the **OFF/CLEAR** pad for 3 seconds.

To unlock just the controls, hold the door slightly open while pressing and holding the **OFF/CLEAR** pad for 3 seconds.

The oven will beep, and Loc and the Lock icon will disappear from the display. Close the oven door, if you are holding it open.



Stainless steel surfaces



Do not use a steel-wool pad or abrasive cleaners on stainless steel surfaces. Abrasive pads and cleaners will scratch the surface and damage the surface finish.



To prevent any discolorations and/or grease stains, we recommend cleaning and removing any spills, spots, and grease from the range after each use.

1. Wipe off any spills with a damp, soft cloth.
2. Apply an approved stainless steel cleaner to a damp, clean cloth or paper towel. Clean a small area carefully following the instructions on the cleaner. Stainless steel should always be cleaned with the grain in the stainless steel, if applicable.
3. Dry and buff with a clean, dry, soft cloth.
4. Repeat steps 2 and 3 as necessary.

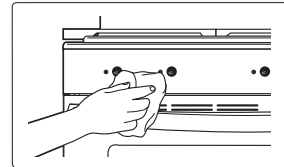
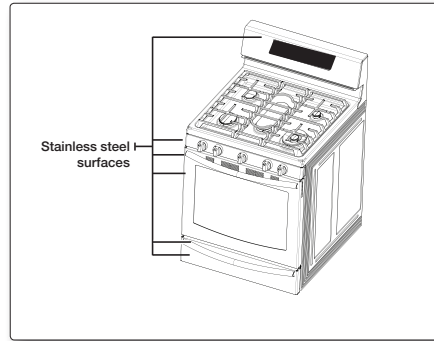

Do not spray any type of cleaner into the manifold panel holes. Within these holes are ignition switches which carry the current that lights the surface burners. Spraying into them could damage the range.

Oven racks

- If the racks are left in the oven during a self-cleaning cycle, their color will turn slightly blue and the finish will be dull. After the self-cleaning cycle is complete and the oven has cooled, rub the sides of the racks with wax paper or a cloth containing a small amount of oil. This will help the racks glide more easily into their tracks.
- Gliding racks may be cleaned by hand with an abrasive cleaner or steel wool. During cleaning, be careful not to allow water or cleaner to enter the slides on the sides of rack.



- Do not clean in a dishwasher.
- If the rack becomes hard to remove or replace, lightly wipe the oven rack guides with cooking oil. Do not wipe cooking oil on the slides.
- If the rack becomes difficult to slide, the rack may need to be lubricated using Graphite Lubrication.



- To order Graphite Lubrication, call our customer center at 1-800-SAMSUNG (726-7864) or visit our homepage (www.samsung.com/us or www.samsung.com/ca) and reference DG81-01629A.
- If you want to buy directly, visit our on-line parts distributor at <http://www.samsungparts.com/Default.aspx>.

To lubricate the slides

1. Remove the rack from the oven. See removing the gliding rack in the USING THE GLIDING RACK section.
2. Fully extend the rack on a table or countertop. Newspaper may be placed underneath the rack for easy cleanup.
3. If there is debris in the slide tracks, wipe it away using a paper towel. (Any graphite lubricant wiped away must be replaced - See steps 4 through 7.)
4. Shake the graphite lubricant before opening it. Starting with the left (front and back) slide mechanism of the rack, place four (4) small drops of lubricant on the two (2) bottom tracks of the slide close to the bearing carriers.
5. Repeat for the right (front and back) slide mechanism of the rack.
6. Open and close the rack several times to distribute the lubricant.
7. Replace the cap on the lubricant and shake it again. Turn the rack over and repeat steps 3, 4, 5 and 6.
8. Close the rack, turn rack right-side-up and place in the oven. See installing the gliding rack in the USING THE GLIDING RACK section.



- Do not spray the gliding rack with cooking spray or other lubricant sprays.

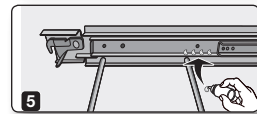
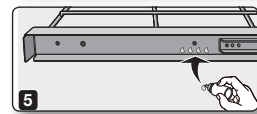
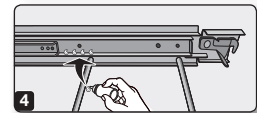
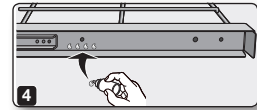
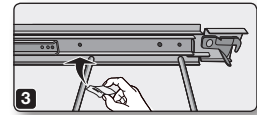
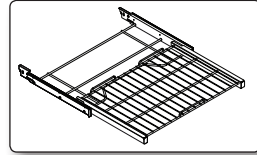

Oven racks

To keep racks shiny and looking like new, remove racks from the oven and clean by hand in hot, soapy water with a plastic or soap-filled scouring pad.

CAUTION Do not leave the oven racks in the oven during a self-cleaning cycle. The extreme heat in the self-cleaning cycle will permanently discolor the oven racks and make them difficult to slide.

If racks become difficult to slide, rub the side rails with wax paper or a cloth containing a small amount of cooking oil. This will help the racks slide more easily in the tracks.

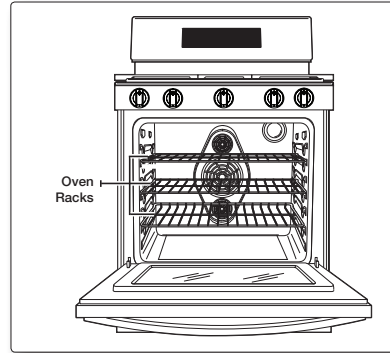

Oven door

WARNING Do not allow moisture to enter the door or contact the door gasket during cleaning. Moisture entering the door assembly and or getting on the door gasket will damage the gasket.

The oven door has multiple surfaces that require different cleaning techniques. The gasket on the inside surface of the oven door should never be cleaned or moved to clean other surfaces. The gasket is made of woven material which is essential for a good heat seal.

The inside door surface outside of the gasket should be cleaned by hand with hot, soapy water and a soapy plastic scouring pad. Rinse and dry thoroughly with a clean, soft cloth. Do not get the gasket wet or allow moisture to get inside the door assembly.

The inside door surface inside of the gasket and the inside door glass are cleaned during the oven's self-cleaning cycle.

The outside door surface is stainless steel and should be cleaned using the instructions on page 60.

The outside glass surface can be cleaned with glass cleaner or warm, soapy water with a thorough rinse. Do not let moisture get inside of the door assembly.

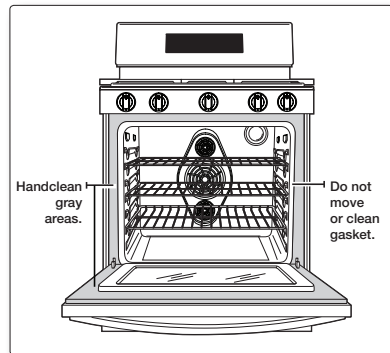

CARE AND CLEANING OF THE COOKTOP

Surface burner controls

1. Make sure all surface burner knobs are in the OFF position.
2. Pull the control knobs straight off the surface burner control valve stems.

 **CAUTION** Do not clean the control knobs in a dishwasher. They are not dishwasher-safe.

3. Clean the control knobs in warm, soapy water. Rinse and completely dry all surfaces (including back and stem hole).

 **WARNING** Do not use spray cleaners on the surface burner control panel. Spray entering the valve holes could contact electrical components resulting in death, personal injury, or product damage.

4. Clean stainless steel surfaces with stainless steel cleaner on a damp, soft cloth. See page 60.
5. Replace the control knobs in the OFF position by pushing them straight onto the control valve stems.

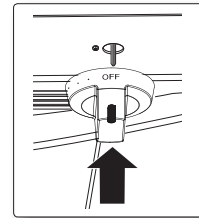
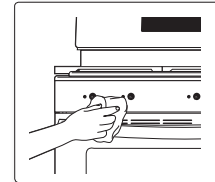
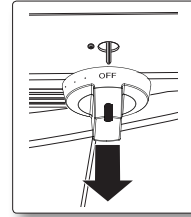

Surface burner grates and assemblies

1. Turn off all controls and make sure all parts have cooled.

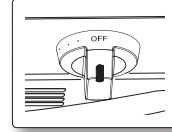

2. Lift off and remove the burner grates from the cooktop. Make note of the burner sizes and locations of all the surface burners.

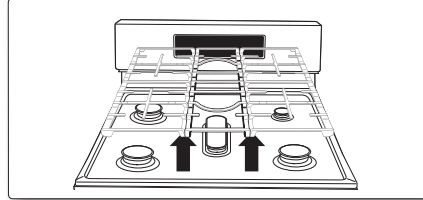

3. Lift off burner caps from top of the burner heads.
4. Lift the burner heads off the valve manifolds and starter electrodes.

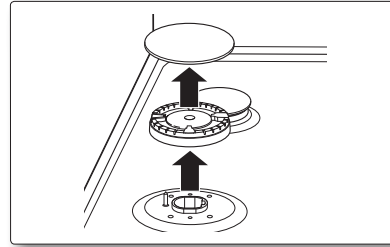

5. Clean all removable burner parts in warm, soapy water. Do not use steel-wool pads or abrasive cleaners on any burner part.
6. Rinse thoroughly and completely dry all parts before they are reassembled.



Starter electrodes are not removable and should only be wiped clean when the controls are in the OFF position.

7. Set all burner heads on top of the manifold valves in the same location you removed them from. The hole on the side of the burner heads goes over the electrodes. The burner heads are correctly installed when they are flat on the top of the manifold valves.

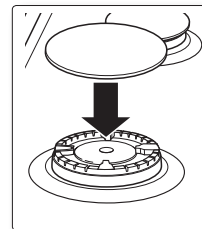
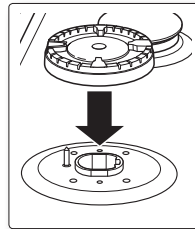

8. Set all burner caps on top of the burner heads. These also need to be flat on top of the burner heads to ensure proper and safe operation.

-  The caps on Precise simmer burner (RR) and inside Double-ring Burner (RF) can be interchangeably used.

Precise Simmer Burner (RR)

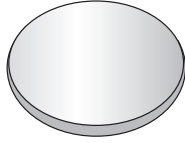

Flat surface

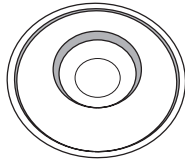

Concave line

9. Replace burner grates on top of the range cooktop.

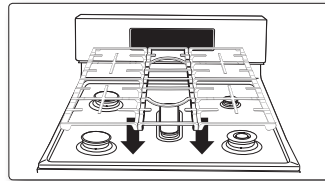

10. Push in and turn each surface burner control knob to the LITE position, let each burner light, and then set each control knob back to a burner setting to make sure each burner operates properly.

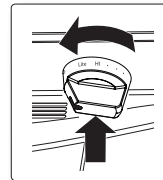

Cooktop surface

The cooktop surface is a porcelain-enamel surface. To prevent this surface from becoming dull, wipe up and clean spills as they happen. Foods with a lot of acid (tomatoes, sauerkraut, fruit juices, etc.) or foods with high sugar content can cause dull spots if allowed to set.



WARNING

Do not use a steel-wool pad or abrasive cleaners on porcelain-enamel surfaces. Abrasive pads and cleaners will scratch and damage the surface.

1. Make sure all surface burners are OFF.

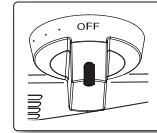

2. When surfaces have cooled, remove the burner grates.

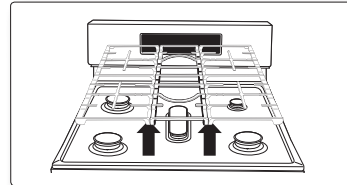

WARNING

Do not remove or lift the cooktop during cleaning. Doing so could damage the gas lines leading to the surface burner manifolds, causing poor and/or dangerous operation.

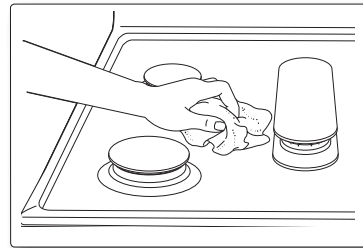

3. Clean the cooktop surface with warm, soapy water and a soft, damp cloth. If spill goes under a surface burner, remove the surface burner cap and head to access and clean the spill.
4. Rinse with clean water and dry and polish with a soft, dry cloth.
5. Reassemble burner components (if removed) and replace the burner grates.

CHANGING THE OVEN LIGHT

The oven light is a standard 40-watt appliance bulb. It will automatically come on when the oven door is opened. It can also be turned on and off when the oven door is closed by pressing the Oven Light pad on the oven control panel.

 The oven light will not work during a self-cleaning cycle.

 **WARNING** Disconnect electrical power to the range before replacing the oven light. This will prevent any personal injury due to electric shock.

1. Make sure the oven and the light bulb are cool.
 2. Open the oven door.
-  If the oven racks are in the way, they can be repositioned or removed before you change the oven light.
3. Turn the glass light cover in the rear upper-right corner counterclockwise to remove it.
 4. Turn the bulb counterclockwise to remove it from its socket.
 5. Replace the bulb with a new 40-watt appliance bulb. Turn the bulb clockwise until it is seated securely in the socket.
 6. Replace the glass light cover by turning it clockwise until it is seated securely.
 7. Close the oven door and reconnect the electrical power to the range.

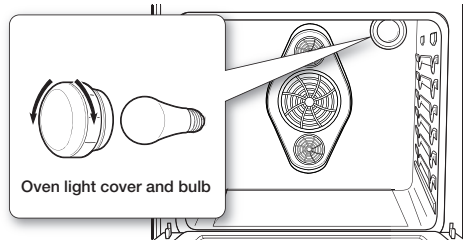

REMOVING AND REPLACING THE OVEN DOOR



- The oven door is very heavy. Do not lift it by the handle and be careful not to drop the door during removal. Improper handling could result in personal injury.
- Disconnect the electrical power to the range before removing the oven door. This prevents the oven from accidentally being turned on while the door is removed.

To remove the door

1. Completely open the oven door.

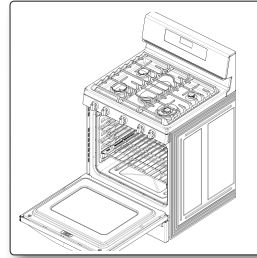

2. Unlock the two hinge locks. Pull each hinge lock down towards the door frame to unlock it so they look like the illustration to the right.

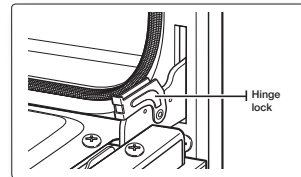

3. Close the door to the removal position, approximately 5 degrees from vertical.
4. Firmly grasp both sides of the oven door and lift the door up and out until the hinge arms clear the slots in the bottom of the oven door.
5. Carefully place the door in a safe location.

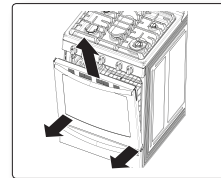

To replace the door

1. Make sure hinge arms are unlocked and in the removal position.

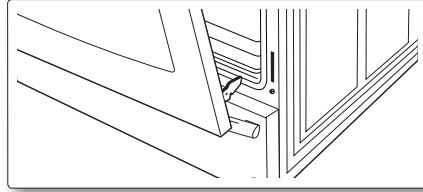

2. Firmly grasp both sides of the door.
3. While supporting the oven door, insert both door hinge arms into the slots in the bottom sides of the door frame. When the door is held at about 5 degrees, the hinge arms will slide in and down.

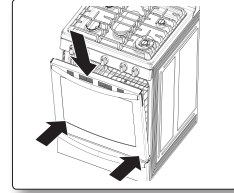

4. Completely open the oven door. If the door will not fully open, the hinge arms are not correctly inserted into the slots in the bottom of the door.
5. Lock both hinge locks. Push each lock up against the front frame of the oven cavity.
6. Close the door.
7. Reconnect power to the range.

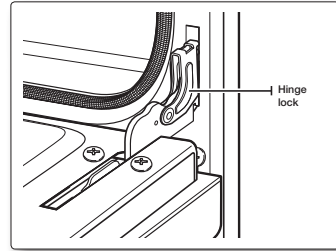

REMOVING AND REPLACING THE WARMING DRAWER (MODEL NX58H5650W*)

To remove and clean the warming drawer

1. Pull out the drawer until it stops.

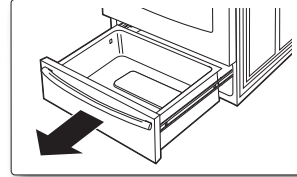

2. Locate the locking clips near the back of each full-extension roller guide rail. Using two hands, push down on the left clip and lift up on the right clip to release the clips. Pull the drawer the rest of the way out.

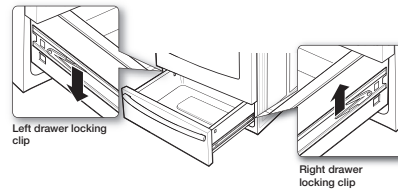

3. Clean the drawer in warm, soapy water. Rinse and dry thoroughly.

To replace the warming drawer

1. Position the ends of the full-extension roller guide rails in the side rails in the drawer opening.

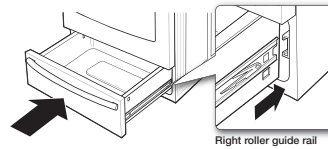

2. Push in the drawer to close it and snap the locking clips into place.

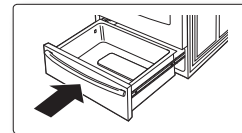

REMOVING AND REPLACING THE STORAGE DRAWER (MODEL NX58H5600S*, NX58J5600S*, NX58M5600S*)

To remove the storage drawer

1. Pull out the drawer and remove any stored content.

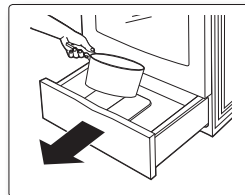

2. While supporting the drawer, pull it out until the top of the drawer sides come out of the two nylon drawer guides. Then, lift to remove the drawer.
3. Clean the drawer in warm, soapy water. Rinse and dry thoroughly.

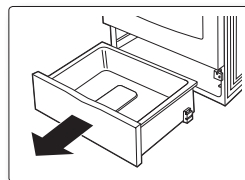

To replace the storage drawer

1. Place the top of both drawer sides in the openings on the two nylon drawer guides and push in enough to support the drawer.

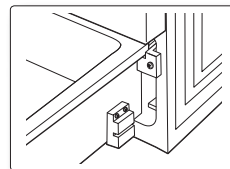

2. Replace any stored content and push in the drawer while slightly lifting the front to close it.

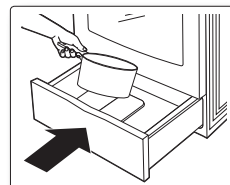

SELF-CLEANING OVEN

The self-cleaning oven uses high temperatures (well above cooking temperatures) to burn off left over grease and residue completely or reduce them to a finely powdered ash that can be wiped away with a damp cloth.



Failure to follow these precautions could result in damage to the oven, fire, and/or personal injury.

- Do not leave small children unattended near the range during a self-cleaning cycle. The outside surfaces of the range can get extremely hot.
- Some birds are extremely sensitive to fumes from a self-cleaning oven. Relocate birds to a well-ventilated room away from the range.
- Do not line the oven, oven racks, or oven bottom with aluminum foil. Doing so will result in poor heat distribution, produce poor baking results, and cause permanent damage to the oven interior. The aluminum foil will melt onto and adhere to the interior oven surfaces.
- Do not force the oven door open during the self cleaning cycle. It will damage the automatic door-locking system. The door automatically locks when the self-cleaning cycle is started and stays locked until the cycle is cancelled and the oven temperature is below 350 °F.
- Be careful opening the oven door after a self-cleaning cycle. The oven will still be VERY HOT and hot air and steam might escape when the door is opened

Before a self-cleaning cycle



Remove the racks. Leaving the oven racks in the oven during a self-cleaning cycle will discolor the oven racks and make them difficult to slide in and out of position.

- Make sure the door lock feature is turned off and the oven is cool. If they are not, the self-cleaning cycle will not start.
- On model NX58H5650W*, make sure the warming drawer is turned off. Self-clean will not start when the drawer is on.

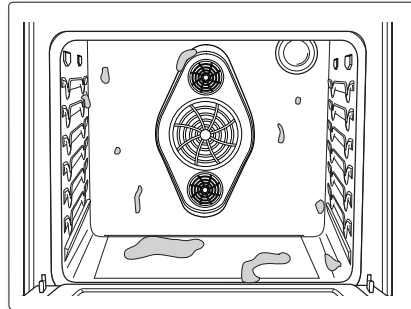

Do NOT use the surface burners while the oven is operating in the self clean mode.

- A blinking **Lock** icon indicates the oven door is in the process of being locked.



- When the **Lock** icon is on, the oven door is locked.



- When **Loc** is shown in the display, it indicates the door lock feature is on. Press and hold the **OFF/CLEAR** pad for 3 seconds to unlock the oven controls.



How to set the oven for self-cleaning

1. Make sure the oven door is completely closed.

2. Press the **Self Clean** pad on the oven control panel.

Press the pad once for a 2-hour cleaning cycle, twice for a 3-hour cleaning cycle, or three times for a 4-hour cleaning cycle.

Pressing the pad a fourth time will reselect the 2-hour default time.

The display will show **Clean**, and the **Start** indicator will blink under the selected cleaning cycle time.



3. Press the **START/SET** pad to start the cycle.

The display will show **Clean** and the selected cleaning cycle time, and the **Lock** icon will blink until the door is locked. Then the **Lock** icon will stay on until the cycle is over and the oven temperature is below 350 °F (177 °C).

The oven temperature will rise and hold the preset self-clean temperature for the duration of the selected cleaning cycle. The display will count down the cleaning cycle in minutes and hours.

When the time elapses, the oven will turn off and beep 6 times. **End** will show in the display and the **Lock** icon will blink. When the oven temperature falls below 350 °F (177 °C), the door unlocks and the **Lock** icon turns off.

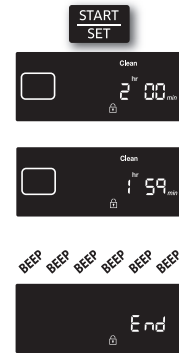

4. Press the **OFF/CLEAR** pad.

The display will go back to showing the time of day.



How to delay the start of self-cleaning

1. Make sure the oven door is completely closed.

2. Press the **Self Clean** pad on the oven control panel.

Press the pad once for a 2-hour cleaning cycle, twice for a 3-hour cleaning cycle, or three times for a 4-hour cleaning cycle.

The display will show **Clean**, and the **Start** indicator will blink under the selected cleaning cycle time.



3. Press the **Delay Start** pad.

The display will show **Delay** and -- --.



4. Press the number pads to set the time you want the oven to turn on, e.g., 4, 3, 0.

The **Start** indicator will blink under the selected delay start time and **Delay** on the display.



5. Press the **START/SET** pad.

The display will show the Delay Start time and the **Lock** icon. The oven door lock will engage automatically.

When the start time is reached, the oven will turn on automatically and start the programmed cleaning cycle.



How to cancel self-cleaning

You may find it necessary to stop or interrupt the self-cleaning cycle due to excessive smoke or fire in the oven.

- Press the **OFF/CLEAR** pad.

The oven will turn off. The Lock icon will blink under the current time of day on the display. When the oven temperature falls below 350 °F (177 °C), the oven door unlocks and the **Lock** icon turns off.



After self-cleaning



Be careful opening the oven door after a self-cleaning cycle. The oven is still very hot when the door unlocks. Escaping hot air and/or steam could burn you.

- The internal oven temperature must be below 350 °F for the automatic door lock to disengage. The door lock must be disengaged before another cooking function can be set.
- After the oven has cooled, wipe down the oven surfaces with a damp cloth to remove any ash residue.
- Stubborn spots can be cleaned with a soap-filled steel-wool pad. Lime deposits can be removed with a cloth soaked in vinegar. Rinse thoroughly after cleaning.
- If the oven is not clean after one cycle, repeat the cycle. If the oven is still hot, **HOT** will appear on the display until the oven is cool enough to start a new cycle.

troubleshooting

TROUBLESHOOTING

Samsung works hard to ensure that you don't have problems with your new gas range. If you experience a problem, look first for a solution in the table below. If, after trying the suggested solution, you're still having trouble, call Samsung at 1-800-SAMSUNG (1-800-726-7864).

PROBLEM	POSSIBLE CAUSE	SOLUTION
You smell gas.	There is a gas leak. The surface burner knob is not in the 'off' position, yet the burner itself is not ignited.	Clear the room, building, or area of all occupants. Immediately call your gas supplier from a neighbor's phone. Do not call from your phone. It is electrical and could cause a spark that could ignite the gas. Follow the gas supplier's instructions. If you cannot reach your gas supplier, call the fire department.
The range is not level.	The appliance has been installed improperly. The leveling leg(s) is (are) damaged or uneven.	Make sure the floor is level, strong, and stable. If the floor sags or slopes, contact a carpenter. Check and level the range. (See the Installation Instructions.)
	The kitchen cabinets are not properly aligned and make the range appear to be not level.	Ensure that cabinets are square and provide sufficient room for installation.
The oven control beeps and displays an error code.	You have a function error code. See the "Troubleshooting and information codes" chart on page 76.	Press the OFF/CLEAR pad and restart the oven. If the problem persists, disconnect all power to the range for at least 30 seconds and then reconnect the power. If this does not solve the problem, call for service.
All burners do not light.	The power cord is not plugged into the electrical outlet.	Make sure the electrical plug is plugged into a live, properly grounded outlet.
	A fuse in your home may be blown or the circuit breaker tripped.	Replace the fuse or reset the circuit breaker.
	The gas supply is not properly connected or turned on.	See the Installation Instructions that came with your range.

PROBLEM	POSSIBLE CAUSE	SOLUTION
Surface burners do not light.	The control knob is not set properly.	Push in the control knob and turn it to the LITE position.
	The burner caps are not in place. The burner base is misaligned.	Clean the electrodes. Put the burner cap on the burner head. Align the burner base.
Surface burner clicks during operation.	The control knob has been left in the LITE position.	After the burner lights, turn the control knob to a desired setting. If the burner still clicks, contact a service technician.
The burners do not burn evenly.	Surface burner components and caps are not assembled correctly and level.	See page 64.
	Surface burners are dirty.	Clean surface burner components. (See pages 64 and 65.)
Very large or yellow surface burner flames.	Wrong orifice is assembled.	Contact your installer. Check the burner orifice size and contact your installer if you have the wrong orifice. Check the LP gas conversion.
Surface burners light but oven burners do not light.	The oven door lock is turned on.	The display will show the Lock icon. Hold the oven door open and press the START/SET pad for 3 seconds. The oven will beep and the Lock icon will turn off.
	Gas Pressure Regulator shut off switch is in the 'off position.	Call a qualified service technician.
Display goes blank.	The electrical outlet Ground Fault Interrupter (GFI or GFCI) has been tripped and needs to be reset. Your digital control has been damaged.	Replace fuse or reset circuit breaker.
Very large or yellow oven burner flames.	The oven burner air adjustment shutters need to be adjusted.	Call for a qualified service technician.
	Gas supply is not properly connected or turned on.	See the Installation Instructions that came with your range.
Food does not bake or roast properly in the oven.	Wrong cooking mode is selected.	See pages 28-29, 40, 46.
	The oven racks have not been positioned properly for the foods being cooked.	See page 33.
	Incorrect cookware or cookware of improper size being used.	See page 24.
	Oven thermostat needs adjustment.	See page 37.
	There is aluminum foil on racks and/or oven bottom.	Remove foil.
	Clock or timers not set correctly.	See pages 31 and 32.

PROBLEM	POSSIBLE CAUSE	SOLUTION
Food does not broil properly in the oven.	Oven controls not set properly.	See page 45.
	Oven door was not closed during broiling.	See page 30.
	The rack has not been properly positioned.	See broiling guide on page 46.
Oven temperature is too hot or cold.	Oven thermostat needs adjustment.	See page 37.
Oven burner will not shut off.	The oven door lock is turned on.	The display will show the Lock icon. Hold the oven door open and press the START/SET pad for 3 seconds. The oven will beep and the Lock icon will turn off.
	The Sabbath function has been activated.	SAb and the time of day will show in the display. All other controls and signals will be deactivated. To turn off the oven only, press the OFF/CLEAR pad. To cancel the Sabbath function and reactivate the controls and signals, press and hold the SABBATH pad for 3 seconds.
Oven light (lamp) will not turn on.	The oven door lock is turned on.	The display will show the Lock icon. Hold the oven door open and press the START/SET pad for 3 seconds. The oven will beep and the Lock icon will turn off.
	The Sabbath function has been activated.	SAb and the time of day will show in the display. All other controls and signals will be deactivated. To cancel the Sabbath function and reactivate the light switch and other controls, press and hold the SABBATH pad for 3 seconds.
	Loose or burned-out bulb.	See page 67.
	The switch operating the oven light needs to be replaced.	Call for a qualified service technician.
Oven smokes excessively during broiling.	Meat or food was not properly prepared before broiling.	Cut away excess fat and/or fatty edges that may curl.
	Improperly positioned top oven rack.	See broiling guide on page 46.
	Controls are not being set properly.	See page 45.
	Greasy buildup on oven surfaces.	Regular cleaning is necessary when broiling frequently.

78_ troubleshooting

PROBLEM	POSSIBLE CAUSE	SOLUTION
Oven will not self-clean.	The oven door lock is turned on.	The display will show the Lock icon. Hold the oven door open and press the START/SET pad for 3 seconds. The oven will beep and the Lock icon will turn off.
	The warming drawer is being used.	Self-clean will not operate when the warming drawer is on.
	The oven is too hot.	Let the oven cool down and reset the controls. The self-clean cycle will not lock the oven door if the oven temperature is too hot. The door must lock before the self-clean cycle can start.
	The self-cleaning oven controls are not properly set.	Reset the self-cleaning oven controls. (See pages 73 and 75.)
Crackling or popping sound.	This is normal.	This is the sound of the metal heating and cooling during any cooking or cleaning function.
Excessive smoking during a self-cleaning cycle.	This is the first time the oven has been cleaned.	This is normal. The oven will always smoke more the first time it is cleaned. Wipe up all excessive soiling before starting the self-cleaning cycle. If smoke persists, press the OFF/CLEAR pad. Open the windows to clear the smoke from the room. After the oven has cooled and unlocked, wipe up excessive soil and reset the oven for self-cleaning.
Oven door will not open after a self-cleaning cycle.	This is normal.	The oven door will stay locked until the oven temperature drops below 350 °F.
Oven not clean after a self-cleaning cycle.	A fine dust or ash is normal.	This can be wiped clean with a damp cloth. Set the self-cleaning cycle for a longer cleaning time. The cycle was not long enough to burn off the dirt buildup. Extremely dirty ovens require hand-cleaning of excessive spillovers and food buildup before starting a self-cleaning cycle. Multiple self-cleaning cycles may be necessary to completely clean the oven.

PROBLEM	POSSIBLE CAUSE	SOLUTION
Steam or smoke coming from under the control panel.	This is normal.	The oven vent is located there. More steam is visible when using the convection functions or when baking or roasting multiple items at the same time.
Burning or oily odor emitting from the vent.	This is normal for a new oven and will disappear within 1/2 hour of the first bake cycle.	To speed the process, set a self-cleaning cycle for a minimum of 3 hours. (See pages 73 and 74.)
Strong odor.	This is temporary.	The insulation around the inside of the oven emits an odor the first few times the oven is used.
Oven racks are difficult to slide.		Apply a small amount of vegetable oil to a paper towel and wipe edges of the oven racks with the paper towel. Racks become dull and hard to slide when they are left in the oven during a self-clean cycle.
Fan noise.	This is normal.	The convection fan runs until the function is over or the door is opened.
Convection fan is not working.		The fan starts automatically when the oven meets the preheat temperature.
Warming drawer will not work (Model NX58H5650W*).	The controls are not set properly.	Reset the controls as described on pages 57 and 58.
	The Self-Clean or Sabbath function is being used.	The warming drawer will not operate during either of these operations. Try again after the function is completed or cancelled.
	The oven controls have been locked.	Unlock the controls and try again.
	There is a blown fuse or tripped circuit breaker.	Replace blown fuse or reset tripped circuit breaker.
Excessive condensation in the warming drawer (Model NX58H5650W*).	The temperature setting is too high.	See page 58.
	The foods being warmed are not covered with a lid or aluminum foil.	Cover foods with a lid or aluminum foil.
	You are trying to warm liquids.	Liquid should not be warmed in the drawer. Remove liquids.
Warming drawer or storage drawer does not slide smoothly or drags.	The drawer is not properly aligned with the full-extension roller guide rails or nylon drawer guides.	Remove and replace the drawer. (See page 70.)
	The contents in the drawer are too heavy.	Reduce the weight and/or redistribute the contents in the drawer.

80_ troubleshooting

TROUBLESHOOTING AND INFORMATION CODES

CODE SYMBOL	MEANING	SOLUTION
SE	Shorted Key.	Press the OFF/CLEAR pad and restart the oven. If the problem persists, disconnect all power to the range for at least 30 seconds and then reconnect the power. If this does not solve the problem, call for service. See the instructions below this chart.
E-27	Oven sensor opened problem.	
E-28	Oven sensor shorted problem.	
E-0A	Oven overheating.	
E-0E	Door locking error.	

For any codes not listed above, or if the suggested solution does not fix the problem, call 1-800-SAMSUNG (1-800-726-7864).

warranty

**PLEASE DO NOT DISCARD.
SAMSUNG GAS RANGE**

LIMITED WARRANTY TO ORIGINAL PURCHASER

This SAMSUNG brand product, as supplied and distributed by SAMSUNG ELECTRONICS AMERICA INC. or SAMSUNG ELECTRONICS CANADA INC. (SAMSUNG) and delivered new, in the original carton to the original consumer purchaser, is warranted by SAMSUNG against manufacturing defects in materials and workmanship for a limited warranty period of:

One (1) Year Parts and Labor

This limited warranty begins on the original date of purchase, and is valid only on products purchased and used in the United States or Canada. To receive warranty service, the purchaser must contact SAMSUNG for problem determination and service procedures. Warranty service can only be performed by a SAMSUNG-authorized service center, and any unauthorized service will void this warranty. The original dated bill of sale must be presented upon request as proof of purchase to SAMSUNG or SAMSUNG's authorized service center. Samsung will provide in-home service during the one (1) year warranty period at no charge subject to availability within the contiguous United States or Canada. In-home service is not available in all areas. To receive in-home service, product must be unobstructed and accessible to the service agent. If service is not available, Samsung may elect to provide transportation of the product to and from an authorized service center.

SAMSUNG will repair or replace this product, at our option and at no charge as stipulated herein, with new or reconditioned parts or products if found to be defective during the limited warranty period specified above. All replaced parts and products become the property of SAMSUNG and must be returned to SAMSUNG. Replacement parts and products assume the remaining original warranty, or ninety (90) days, whichever is longer.

This limited warranty shall not cover cases of incorrect electric current, voltage or supply, light bulbs, house fuses, house wiring, cost of a service call for instructions, or fixing installation errors. Furthermore, damage to the cooktop caused by the use of cleaners other than the recommended cleaners and pads and damage to the cooktop caused by hardened spills of sugary materials or melted plastic that are not cleaned according to the directions in the use and care guide are not covered. SAMSUNG does not warrant uninterrupted or error-free operation of the product.

EXCEPT AS SET FORTH HEREIN, THERE ARE NO WARRANTIES OR CONDITIONS ON THIS PRODUCT EITHER EXPRESS OR IMPLIED AND SAMSUNG DISCLAIMS ALL WARRANTIES AND CONDITIONS INCLUDING, BUT NOT LIMITED TO, ANY IMPLIED WARRANTIES AND CONDITIONS OF MERCHANTABILITY, INFRINGEMENT, OR FITNESS FOR A PARTICULAR PURPOSE. NO WARRANTY OR GUARANTEE GIVEN BY ANY PERSON, FIRM, OR CORPORATION WITH RESPECT TO THIS PRODUCT SHALL BE

BINDING ON SAMSUNG. SAMSUNG SHALL NOT BE LIABLE FOR LOSS OF REVENUE OR PROFITS, FAILURE TO REALIZE SAVINGS OR OTHER BENEFITS, OR ANY OTHER GENERAL, INDIRECT, SPECIAL, INCIDENTAL, OR CONSEQUENTIAL DAMAGES CAUSED BY THE USE, MISUSE, OR INABILITY TO USE THIS PRODUCT,

REGARDLESS OF THE LEGAL THEORY ON WHICH THE CLAIM IS BASED, AND EVEN IF SAMSUNG HAS BEEN ADVISED OF THE POSSIBILITY OF SUCH DAMAGES. NOR SHALL RECOVERY OF ANY KIND AGAINST SAMSUNG BE GREATER IN AMOUNT THAN THE PURCHASE PRICE OF THE PRODUCT SOLD BY SAMSUNG AND CAUSING THE ALLEGED DAMAGE. WITHOUT LIMITING THE FOREGOING, PURCHASER ASSUMES ALL RISK AND LIABILITY FOR LOSS, DAMAGE, OR INJURY TO PURCHASER AND PURCHASER'S PROPERTY AND TO OTHERS AND THEIR PROPERTY ARISING OUT OF THE USE, MISUSE, OR INABILITY TO USE THIS PRODUCT. THIS LIMITED WARRANTY SHALL NOT EXTEND TO ANYONE OTHER THAN THE ORIGINAL PURCHASER OF THIS PRODUCT, IS NONTRANSFERABLE, AND STATES YOUR EXCLUSIVE REMEDY.

Some provinces or territories may or may not allow limitations on how long an implied warranty lasts, or the exclusion or limitation of incidental or consequential damages, so the above limitations or exclusions may not apply to you. This warranty gives you specific legal rights, and you may also have other rights which vary from state to state or province to province. User Replaceable Parts may be sent to the customer for unit repair. If necessary, a Service Engineer can be dispatched to perform service.

To obtain warranty service, please contact SAMSUNG at:

Samsung Electronics America, Inc.
85 Challenger Road Ridgefield Park, NJ 07660
1-800-SAMSUNG (726-7864) and www.samsung.com/us/support

Samsung Electronics Canada Inc.,
2050 Derry Road West, Mississauga, Ontario L5N 0B9 Canada
1-800-SAMSUNG (726-7864) and www.samsung.com/ca/support (English),
www.samsung.com/ca_fr/support (French)

REGISTRATION

Please register your product online at www.samsung.com/register.

QUESTIONS

For questions about features, operation/performance, parts, accessories, or service, call 1-800-726-7864, or visit our Web site at www.samsung.com, www.samsung.com/ca.

Model # _____ **Serial #** _____

Please attach your receipt (or a copy) to this manual. You may need it, along with your model and serial number, when calling for assistance.

SAMSUNG



Scan the QR code* or visit
www.samsung.com/spsn
to view our helpful
How-to Videos and Live Shows

*Requires reader to be installed on your smartphone

Scan this with your smartphone

Please be advised that the Samsung warranty does NOT cover service calls to explain product operation, correct improper installation, or perform normal cleaning or maintenance.

QUESTIONS OR COMMENTS?

COUNTRY	CALL	OR VISIT US ONLINE AT
U.S.A Consumer Electronics	1-800-SAMSUNG (726-7864)	www.samsung.com/us/support
CANADA	1-800-SAMSUNG (726-7864)	www.samsung.com/ca/support (English) www.samsung.com/ca_fr/support (French)



DG68-01006A-00