

FRIGIDAIRE

All about the

Use & Care

of your

Split Type Room Air Conditioner



Refer to Page 2 for table of contents.

Welcome to the world of simple handling and no worries

Thank you for choosing Frigidaire. This manual contains all of the information required to guarantee your safety and the appropriate use of your air conditioner.

Please read all of the instructions before using the air conditioner and keep this manual for future reference.

We know you will enjoy your new air conditioner and thank you for choosing our product.

We hope you will consider us for future purchases.

Environmental advices

The packaging material used is recyclable. We recommend that you separate plastic, paper and cardboard and give them to recycling companies. do NOT throw it away with the rest of your domestic If you need to dispose of this appliance in the future, garbage.



Attention!!

The air conditioner that you have bought may be slightly different from the one illustrated in this manual. Please refer to the information related to the model you have.

This air conditioner is for domestic use only. It is not recommended for heavy commercial or industrial use.

Contents

01. Welcome.....	01
02. Environmental advices.....	01
03. Contents.....	02
04. Safety precautions.....	03
05. Operation:	
5.1 Preparing the device for operation.....	06
5.2 Product description.....	08
5.3 Remote control.....	09
- Remote control operation	
- Remote control specifications	
- Remote control battery	
- When should the batteries be replaced	
- To replace batteries	
- Remote control instructions	
5.4 Remote control description.....	11
5.5 Special functions.....	12
5.6 How the air conditioner works.....	13
- Automatic operation	
- Cool/heat and fan only operation	
- Dry operation	
- Airflow direction adjustment	
- Eco/Sleep mode	
- Timer operation	
- Optimal operation	
5.7 How to use the indoor unit.....	17
- Adjusting air flow direction	
- Adjusting the vertical air flow direction (up/down)	
- To set the horizontal air flow direction (left/right)	
- To automatically swing the air flow direction (up/down)	
5.8 Manual operation.....	19
06. Maintenance.....	20
07. Operation tips.....	22
08. Solution for problems.....	24
09. Warranty.....	26

Safety precautions

This appliance must be installed by a qualified licensed HVAC technician in accordance with all applicable codes. All electrical connections should be performed by a licensed electrician. Manufacturer's warranty will be voided with failure to comply.

Incorrect Handling could result in Serious Injury or Death!

1. Do not attempt to install the split air conditioner by yourself.
2. This air conditioner contains no user-serviceable parts. Always call an authorized Electrolux servicer for repairs.
3. When moving the air conditioner, always call an authorized Frigidaire servicer for disconnection and re-installation.
4. Do not insert fingers or place objects into the discharge area in the front of the indoor unit.
5. Do not insert fingers or place objects into the discharge area in the front of the outdoor unit.
6. Do not start or stop the air conditioner by turning off the power at the electrical box.
7. In the event of a malfunction (sparks, burning smell, etc.) immediately power off unit and call an authorized Frigidaire servicer.
8. Do not operate the air conditioner with wet hands.
9. Do not drink any water or condensation that is drained from the air conditioner.
10. Provide occasional ventilation during use. Do not direct airflow at fire places or other heat related sources as this could cause flare ups or make units run excessively.
11. Do not climb on or place objects on the outdoor unit.
12. Do not hang objects off the indoor unit.
13. Do not place objects containing water on the indoor and/or outdoor units.
14. Turn off the air conditioner at the power source when it will not be used for an extended period of time.
15. Periodically check the condition of the outdoor unit's installation base for any damage.
16. Do not apply heavy pressure to the coil fins of the indoor and/or outdoor units.
17. Operate the indoor unit with air filters in place.
18. Do not block or cover the intake grille, discharge area and outlet ports.
19. Ensure that any electrical/electronic equipment is 36" away from the indoor unit and outdoor unit.
20. Do not use or store flammable gases near the indoor and/or outdoor units.

To prevent injury to the user or other people and property damage, the following instructions must be followed.

Incorrect operation due to ignoring of instructions may cause harm or damage. The seriousness is classified by the following indications.

1. Connect with the power properly (confirm voltage upon installation). Otherwise, it may cause electric shock or fire due to excess heat generation.
2. Always ensure effective grounding. No grounding may cause electric shock.
3. Disconnect the power if strange sounds, smell, or smoke comes from it. It may cause fire and electric shock.
4. Do not operate or stop the unit by switching the power off and on. It may cause electric shock or fire due to heat generation.
5. Do not operate with wet hands or in damp environment. It may cause electric shock.
6. Do not allow water to run into electric parts. It may cause component failure, electric shock or fire.
7. Do not use the power cord near flammable gas or combustibles, such as gasoline, benzene, thinner, etc. It may cause an explosion or fire.
8. Do not use the power cord close to heating appliances. It may cause fire and electric shock.

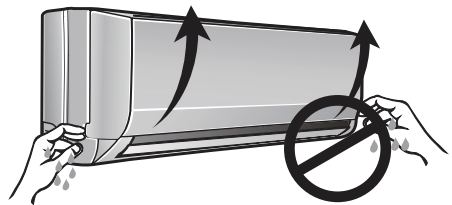
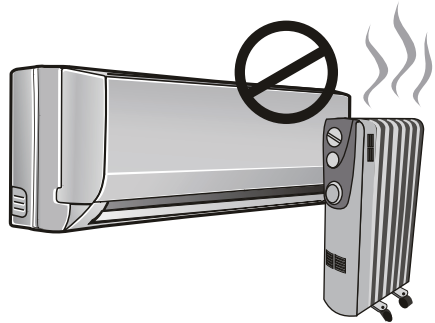

9. Do not damage or use an unspecified power cord. It may cause electric shock or fire.
10. Do not place heavy objects on the power cord and ensure that the cord will not be compressed. There is danger of fire or electric shock.

11. Do not open the unit during operation. It may cause electric shock or injury.
12. Do not drink water drained from air conditioner. It may contain contaminants that could make you sick.
13. Do not disassemble or modify unit. It may cause failure of appliance, electric shock and void the warranty.
14. When the air filter is to be removed, do not touch the metal parts of the unit. It may cause an injury.
15. When the unit is to be cleaned, power off, and turn off the circuit breaker. Do not clean unit when power is on as it may cause fire, electric shock or injury.
16. Avoid direct exposure of occupants to air flow.
17. Turn off the main power switch when not using the unit for a long time.
18. The air conditioner may be dusted with an oil free cloth or washed with a cloth dampened in a solution of warm water and mild dishwashing detergent. Rinse thoroughly and wipe dry. Wring excess water from cloth before wiping around controls.
19. Always insert the filters securely. Clean filter once every two weeks. Operation without filters may cause failure.
20. Always install circuit breaker and a dedicated power circuit. No installation may cause fire and electric shock.

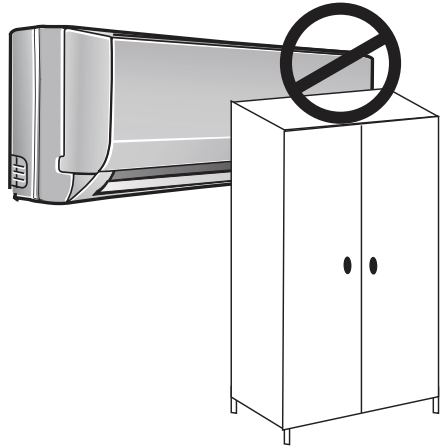
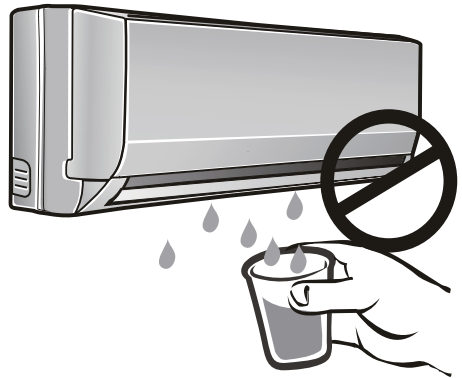

21. Do not place obstacles around air-inlets or inside of air-outlet. It may cause failure of appliance or accident.

Preparing the device for operation

1. Contact a licensed specialist to install the device.
2. Guarantee that the unit is appropriately fastened and complies with all of the aforementioned safety norms.
3. Before operating the air conditioner, ensure that the air filter is installed correctly.
4. If the unit has been out of use for a long period of time, it is recommended that the air filter be cleaned before use. During continuous use, clean the air filter every two weeks.
5. This air conditioner was designed for use under the following conditions:

MODE					
Cool		Heat*		Dehumidifier	
Temperature		Temperature		Temperature	
Indoor	Outdoor	Indoor	Outdoor	Indoor	Outdoor
61°F~86°F	0°F~110°F	61°F~86°F	-5°F~75°F	61°F~86°F	0°F~115°F

* only for models with heating function

Attention!!

If air conditioner is used outside of the above conditions, certain safety protection features may come into operation and cause the unit to function abnormally. Room relative humidity should be less than 80%. If the air conditioner operates in excess of this figure, the surface of the air conditioner may attract condensation. Please set the horizontal louver to its maximum angle (vertically to the floor), and set HIGH fan mode. Optimum performance will be achieved within these operating temperature.

Product description

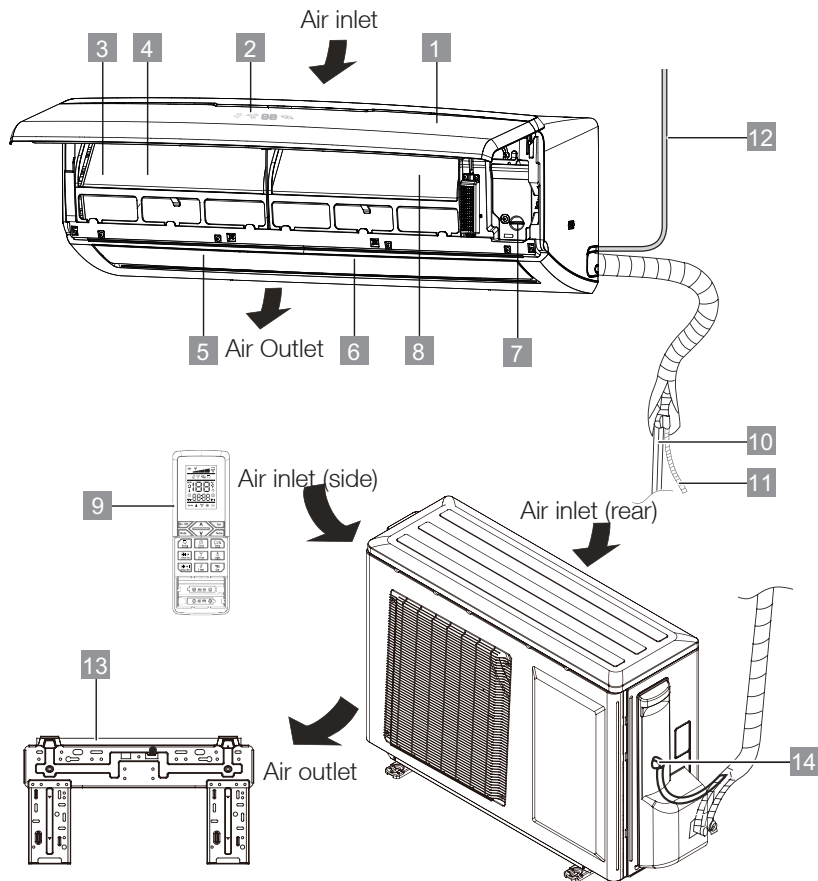

- | | |
|--------------------------------------------|------------------------------------------------|
| 1 Front panel | 8 Cold plasma generator (if applicable) |
| 2 Digital display | 9 Remote controller |
| 3 Air filter | 10 Refrigerant pipe |
| 4 Pre-dust filter | 11 Drain hose |
| 5 Horizontal air flow grille | 12 Power cable |
| 6 Vertical air flow louver (inside) | 13 Mounting plate |
| 7 Manual control button | 14 Connecting cable |

Attention!!

All the pictures in this manual are for explanation purpose only. They maybe slightly different from the airconditioner you purchased.

Display panel (indoor unit)

15 I Feel indicator:

Lights up when I Feel feature is activated.

16 Turbo indicator:

Lights up when Turbo feature is activated.

17 DIGITAL SCREEN:

- Displays the temperature settings when the air conditioner is operational.
- Displays the malfunction code when fault occurs.

18 ECO indicator:

Lights up when Eco feature is activated.

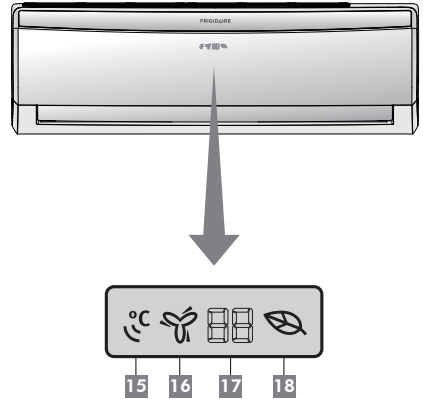

Attention!!

The description of the control is based on a typical model. The functions are the same in your air conditioner, even if there are some differences in the appearance.

Remote control

Remote control operation

1. Operation mode: Cool, Heat (Only for models with heating function), DRY, FAN, and AUTO (Automatic).
2. 24 hrs Timer.
3. Internal temperature range selection: 61°F - 86°F
4. LCD

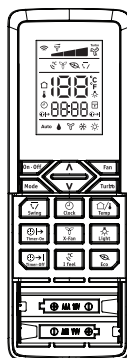

REMOTE CONTROL SPECIFICATIONS

Rated voltage	3 V
Lowest voltage of CPU emitting signal	2.4 V
Transmission distance	32-4/5 [*]
Environment	23°F ~ 140°F
<i>* With 3 V, reaches 40'</i>	

Attention!!

1. The air conditioner will not operate when curtains, doors or other materials block the signals between the remote control and the indoor unit.
2. Avoid spilling any liquid in the remote control. Do not expose to sunlight or any heat source.
3. If the infrared signal receiver in the indoor unit is exposed to sunlight, the air conditioner unit might not work properly. Use curtains or shades to avoid having sunlight directly to the receiver.
4. If other electrical equipments react to the signals sent by the remote control, change their position or consult with you local dealer.

Remote control battery: To use the remote control, it is necessary to install two alkaline AAA batteries.

When should the batteries be replaced

1. There is not a "beep" anymore from the indoor unit when using the control remote or the signal light indicator does not light.
2. The indoor unit does not respond to the remote control commands to activate the programs.

To replace batteries

1. Slide out the battery compartment cover (located at the front of the remote control).
2. Install two AAA batteries in the compartment (indicated in the drawing located inside the compartment).
3. Slide on the battery component cover.
4. If the remote control is not operated for long period of times, batteries should be discarded.

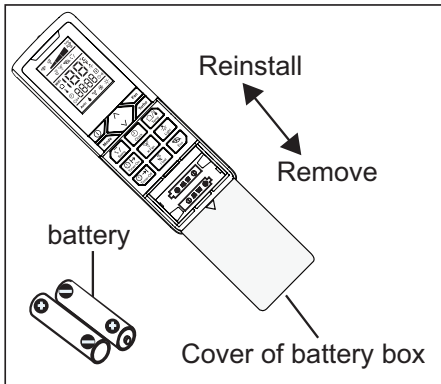

Remote control instructions

1. The signal reach distance of the remote control to the receiver that is inside the indoor unit of the air conditioner is 32 feet. Any obstruction placed between the receiver and the remote control can cause interference, limiting the capacity of the programming.
2. Any time when a button is pressed on the remote control, the air conditioner emits a "beep" that indicates that a command has been received and transmitted to the indoor unit.
3. When selecting the function of timer, the remote control (automatically) sends a signal to the indoor unit at the specific period. If the remote control is left in a position that the signal is blocked, a 15 minute delay can be produced.

Attention!!

1. When replacing batteries, do not use old batteries or a different type battery. This may cause the remote control to malfunction.
2. If you do not use the remote controller for several weeks, remove the batteries. Otherwise battery leakage may damage the remote controller.
3. The average battery life under normal use is about 6 months.
4. Replace the batteries when there is no answering beep from the indoor unit or if the transmission indicator fails to light.

Remote control description

1 ON/OFF: Press this button to start the unit operation. Push the button again to stop the unit operation.

2 UP/DOWN: Press the button to increase/decrease the temperature. Keep the button pressed for two seconds to accelerate the process. Release the button to set the temperature and the °C/°F icon will be displayed constantly. In Timer-On/Off or Clock functions, use the button to set the clock or timer adjustment.

3 MODE: Press the button to set the operation mode: AUTO, DRY, FAN, COOL and HEAT*. Default setting: AUTO.

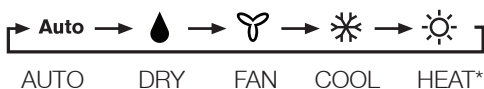

* Note: Only for models with Heat function.

4 SWING: Press this button, the louver will swing up and down automatically. Press again to cancel it and the louver will stay at its last position.

5 TIMER ON: Press the button to set the timer function for switching on the unit. If the TIMER ON symbol "⌚→" blinks, press the UP or DOWN button to set the time. Keep the button pressed for two seconds to accelerate the process. Press the button to set the timer.

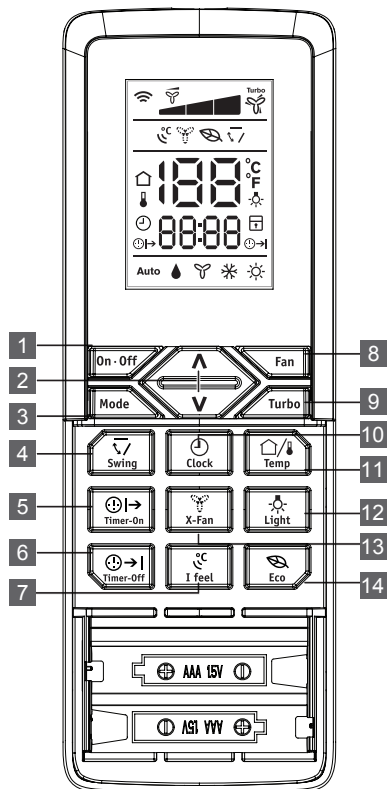

Default setting: 8:00 (24-hour mode). Press the button again to cancel the timer function.

6 TIMER OFF: Press the button to set the timer function for switching off the unit. If the TIMER OFF symbol "⌚→|" blinks, press the UP or DOWN button to set the time. Keep the button pressed for two seconds to accelerate the process. Press the button to set the timer. Default setting: 17:00 (24-hour mode). Press the button again to cancel the timer function.

7 I FEEL: Press the button to enable or disable the I FEEL function. If the I FEEL function is enabled, the I FEEL symbol "  " will be shown.

If the I FEEL symbol is enabled, the remote control will send the ambient temperature to the main unit every 10 minutes or when you press one of the buttons.

8 FAN SPEED: Press the button to set the fan speed: AUTO, LOW, MEDIUM and HIGH. Default setting: AUTO. In the DRY mode, only LOW can be set.





9 TURBO: In COOL or HEAT mode, press the button to enable or disable the turbo function. If the turbo function is enabled, the turbo symbol "  " will be shown.

If the turbo function is enabled, the unit will operate at turbo speed to cool or heat rapidly so that the ambient temperature approaches the set temperature as soon as possible.

10 CLOCK: Press the button to set the clock. If the clock symbol "  " blinks, press the UP or DOWN button to set the time. Keep the button pressed for two seconds to accelerate

the process. Press the CLOCK button again to set the clock. The clock symbol stops blinking.

11 TEMP: Press this button to change the Indoor Unit temperature Display between Set temperature and Room temperature. After display Room temperature 5s, it will turn into set temperature. When the symbol "  " is shown, the indoor unit displays the Set temperature. When the symbol "  " is shown, the indoor unit displays the Room temperature.

12 LIGHT: Press the button to switch the display of the indoor unit on or off. When switch on, the light symbol "  " will be showed. Default setting: ON.

13 X-FAN: In COOL or DRY mode, press the button to enable or disable the X-FAN function. If the X-FAN function is enabled, the X-FAN symbol "  " will be shown. Default setting: OFF.

14 ECO: In COOL or DRY mode, press this button to enable or disable Eco operation. If the ECO function is enabled, the ECO symbol "  " will be shown. Default setting: OFF. This is ideal for the users to use while sleeping.

Special functions

About LOCK: Press Mode and Fan buttons at the same time, you can lock and unlock the remote controller. The icon "  " will display when Lock function is enabled.

To switch between Fahrenheit and Celsius: Turn the remote controller off and the °C/°F can be switched by pressing Mode and DOWN buttons at the same time with keeping for 3 seconds.

How the air conditioner works

Automatic operation



When the Air Conditioner is ready for use, switch on the power and the OPERATION indicator lamp on the display panel of the indoor unit starts illuminating.

1. Use the MODE button to select AUTO.
2. Use the "MODE" button to select Auto. The unit will automatically select Cool, Fan, Heat and Dehumidifying operation depending on the difference ambient temperature and system difference temperature. The temperature can be set within a range of 16°C/61°F~30°C/86°F in 1°C/1°F increments. Keep the button pressed for two seconds to accelerate the process.
3. Press the ON/OFF button again to stop the unit operation.

Attention!!

1. In the AUTO mode, the air conditioner can logically choose the mode of Cooling, Fan, Heating and Dehumidifying by sensing the difference between the actual ambient room temperature and the set temperature on the remote controller.
2. In the AUTO mode, the fan speed can be switched.
3. If the AUTO mode is uncomfortable, you can select desired conditions manually.

COOL / HEAT / DRY (DEHUMIDIFICATION) and FAN ONLY operation

1. If the AUTO mode is not comfortable, you may manually override the settings by using COOL, HEAT*, DEHUMIDIFICATION or FAN ONLY** mode.
2. Press the "▲"/"▼" button to set the desired room temperature. When in COOL mode, the most comfortable settings are 70 °F or above. When in HEAT mode, the most comfortable settings are 82 °F or below.
3. Press the FAN to select the FAN mode of AUTO, ,  or .

4. Press the ON/OFF button, the operation lamp lights and the air conditioner start to operate as your settings. Press the ON/OFF button again to stop this unit operation.

* Note: Only for models with heating function.

**Note: The FAN ONLY mode can not be used to control the temperature. While in this mode, only steps 1,3 and 4 may be performed.

DRY (DEHUMIDIFICATION) operation

The dry mode will automatically select the drying operation based on the difference between the set temperature and the actual room temperature. The temperature is regulated while dehumidifying by repeatedly turning on and off of the cooling operation or fan only. In the Dehumidifying mode, you can not switch the fan speed. It has already been automatically set at low speed.

1. Press the MODE button to select DRY.
2. Press the "∧"/"∨" button to set the desired temperature from 61 °F to 86 °F.
3. Press the ON/OFF button, the operation lamp lights and the air conditioner starts to operate in the DRY mode. FAN SPEED is Low. Push the ON/OFF button again to stop this unit operation.

Air flow direction adjustment

Press the SWING button "↕" once and quickly, the air flow direction setting feature of the louver is activated. The horizontal louver would swing up/down automatically. Press it again to stop at its last place.

Attention!!

Due to the difference between the set temperature of the unit and the actual indoor temperature, the Air Conditioner in DRY mode will automatically switch the operation modes between COOL and FAN ONLY many times.

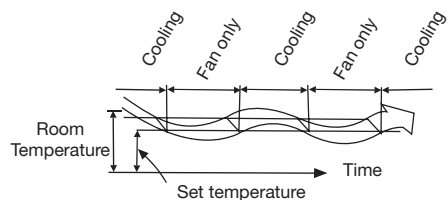

DRY FUNCTION

Attention!!

If the louver oscillates or moves in a position that could affect the cooling or heating (only for models with heating function) of the air conditioner, the direction of the oscillation/movement would alter automatically.

Eco(Sleep) mode

Press the Eco/Sleep button to activate the sleep mode. To deactivate, press the button again.

In cooling mode:

- The fan speed will be automatically controlled.
- The air conditioner will automatically increase 1 °F per hour in a 2 hour period(The indoor unit always displays the set temperature). The set temperature will be steady for the next 5 hours, then this mode will be terminated.

In heating mode (only for models with heating function)

- The fan speed will be automatically controlled.
- The air conditioner will automatically decrease 1 °F per hour in a 2 hour period.(The indoor unit always displays the set temperature). The set temperature will be steady for the next 5 hours, then this mode will be terminated.

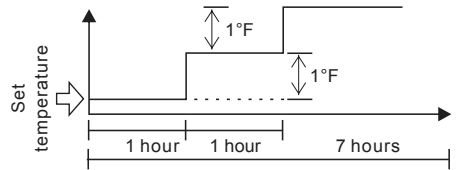

SLEEP FUNCTION (Cooling mode)

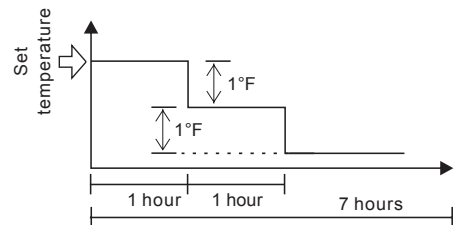

SLEEP FUNCTION (Heating mode)

TIMER Operation

TIMER button can set the auto-on time of the unit.

To set the starting time:

1. Press the "TIMER ON" button to activate the auto start timer function. Auto start can be set from 0~24 hours. After pressing "TIMER ON" button, "ON" on the display will blink, and during 5 seconds blinking, the value can be adjusted by pressing "^"/"v" button. Every press of this button, 1 minute will be increased or decreased, but continuously press the "^"/"v" button, 2 seconds later the value will be increased or decreased automatically, and after 10 minutes increase or decreased, the value will be changed 10 minutes every 0.5 second; Press the "TIMER ON" button to conform the time.
2. when repressing the "TIMER ON" button, the "TIMER ON" setting will be canceled.

To set the stopping time

1. Press the "TIMER OFF" button to activate the auto stop timer function.
2. The method of setting is the same as above of "TIMER ON".

Examples:

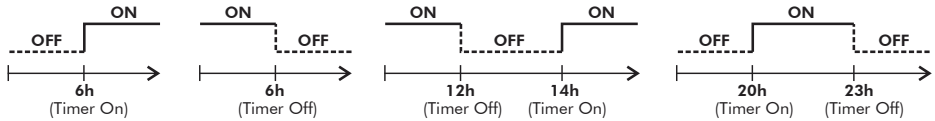

Optimal operation

To achieve optimal performance, please note the following:

1. Adjust the air flow direction correctly so that it is not directed on people.
2. Adjust the temperature to achieve the highest comfort level. Do not adjust the unit to excessive temperature levels.
3. Close doors and windows on COOL or HEAT (only for models with heating function) mode, or performance may be reduced.
4. Use TIMER ON button on the remote controller to select a time you want to start your air conditioner.
5. Do not put any object near air inlet or air outlet, as the efficiency of the air conditioner may be reduced and the air conditioner may stop running.
6. Clean the air filter periodically, otherwise cooling or heating (only for models with heating function) performance may be reduced.
7. Do not operate unit with horizontal airflow grille in closed position.

How to use the indoor unit

Adjusting air flow direction

Adjust the air flow direction properly, otherwise it might cause discomfort or uneven room temperatures. Adjust the vertical louver using the remote controller. Adjust the horizontal louver manually.

To set the horizontal air flow direction (left/ right)

Adjust the horizontal louver manually using the lever on the left or right side of the vertical louver arm (Depending on the specific model you choose), or move the lever at the left (or right, or middle which is only for 21400-36000 Btu's, depending on the specific model you choose) end of the air outlet to the desired position. Perform these adjustments before you start the unit because once it has been started, there is risk of your fingers getting caught on the fan.

To automatically swing the air flow direction (up/down)

Perform this function while the air conditioner is in operation.

Press the "↕" button on the remote controller.

To stop the function, press the "↕" button again.

Press "↕" to lock louver in desired position.

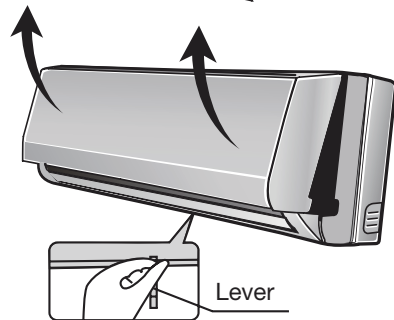
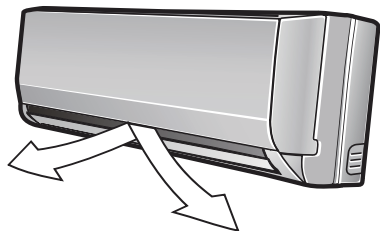
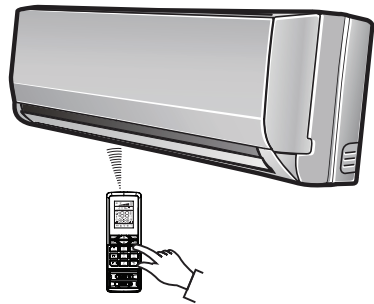
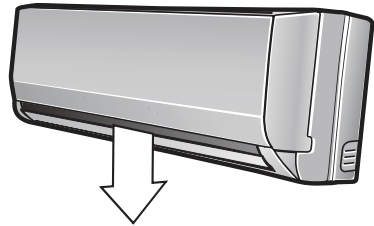

The "↕" button will be disabled when the air conditioner is not in operation (including when the TIMER ON is set).

Do not operate the air conditioner for long periods with the air flow direction set downward in cooling or dry mode. Otherwise, condensation may occur on the surface of the horizontal louver and drop on to the floor or on furnishings.

Do not move the horizontal louver manually. Always use the "↕" button. If you move this louver manually, it may malfunction during operation. If the louver malfunctions, stop the air conditioner and restart it.

Open angle of the horizontal louver should not be set too small, as COOLING or HEATING (only for models with heating function) performance may be impaired due to too restricted air flow area.

Do not operate unit with horizontal louver in closed position.

When the air conditioner is connected to power (initial operation), the horizontal louver may generate a sound for 10 seconds, this is a normal operation.

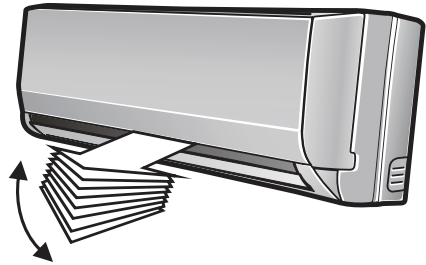

Manual operation (without remote control)

Manual operation can be used temporarily in case you can not find the remote controller or its batteries are exhausted.

1. Open and lift the front panel up to an angle until it remains fixed with a clicking sound.
2. One press of the manual control button will lead to the forced AUTO operation.
3. Close the panel firmly to its original position.

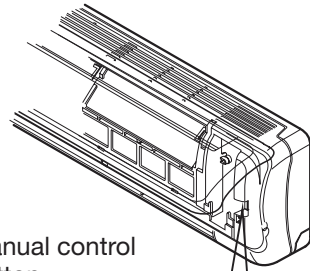
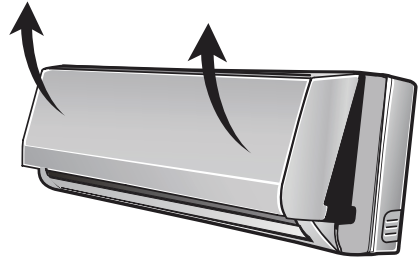

Manual control
button

Auto/OFF ●

Attention!!

Once you press the manual button, the operation mode is shifted in an order as: AUTO and OFF.

The manual operation is mainly used for testing purpose. Do not choose it unless it is necessary. To return to the remote controller operation, use the remote controller.

Maintenance

Cleaning the indoor unit and remote controller.

1. It is necessary to stop the air conditioner and disconnect the power supply before cleaning.
2. Use a dry cloth to wipe the indoor unit and remote controller.
3. A cloth dampened with cold water may be used on the indoor unit if it is very dirty.
4. The front panel of the indoor unit can be removed and cleaned with water. Then wipe it with a dry cloth.
5. Do not use a chemically treated cloth or duster to clean the unit.
6. Do not use benzine, thinner, polishing powder, or similar solvents for cleaning. These may cause the plastic surface to crack or deform.

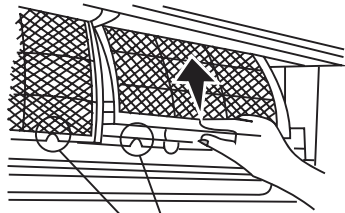
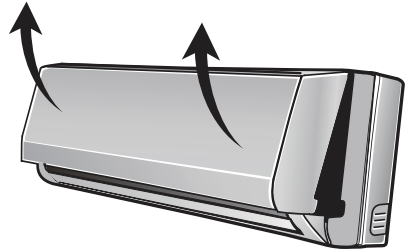

air filter

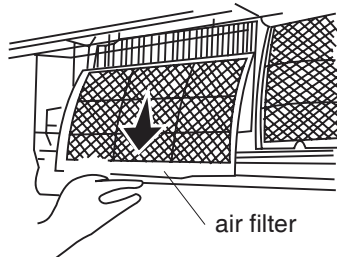

air filter

Cleaning the air filter

A clogged air filter reduces the cooling efficiency of this unit. Please clean the filter once every 2 weeks.

1. Lift the indoor unit panel up to an angle until it stops with a clicking sound.
2. Grab the handle of the air filter and lift it up slightly to take it out from the filter holder, then pull it downwards.
3. Remove the air filter (Fresh air filter if so equipped + support frame) from the unit.

Maintenance

If you plan to idle the unit for a long time, perform the following:

1. Operate in fan mode for about half a day to dry the inside of the unit.
2. Stop the air conditioner and disconnect power. Remove the batteries from the remote controller.
3. The outdoor unit requires periodic maintenance and cleaning. Do not attempt to do this yourself. Contact your dealer or servicer.

If you plan to idle the unit for a long time, perform the following:

1. Check that the wiring is not broken or disconnected.
2. Check that the air filter is installed.
3. Check whether the air outlet or inlet is blocked after the air conditioner has not been used for a long time.

Operation tips

The following events may occur during normal operation.

Protection of the air conditioner.

Compressor protection

This unit comes with a time delay function to help protect the compressor, please allow 3 minutes for the compressor to restart upon turning on the unit.

Anti-cold air (Only for models with heating function)

The unit is designed not to blow cold air in HEAT mode when the indoor heat exchanger is in one of the following three situations and the set temperature has not been reached.

1. When heating has just starting.
2. Defrosting.
3. Low temperature heating.

Defrosting (Only for models with heating function)

Frost may be generated on the outdoor unit during heat cycle when outdoor temperature is low and humidity is high resulting in lower heating efficiency of the air conditioner. During this condition, air conditioner will stop heating operation and start defrosting automatically.

The time of defrosting may vary from 0 to 8 minutes according to the outdoor temperature and the amount of frost buildup on the outdoor unit.

The indoor or outdoor fan will stop running when defrosting (Only for models with heating function).

The indoor unit will display "H1" code when defrosting, it's normal.

A white mist coming out from the indoor unit

A white mist may generate due to a large temperature difference between air inlet and air outlet in COOL mode in an indoor environment that has high relative humidity.

A white mist may generate due to moisture generated from defrosting process when the air conditioner restarts in HEAT mode operation after defrosting.

Low noise of the air conditioner

You may hear a low hissing sound when the compressor is running or has just stopped running. This sound is the sound of the refrigerant flowing or coming to stop.

You can also hear a craching sound when the compressor is running or has just stopped running. This is caused by heat expansion and cold contraction of the plastic parts in the unit when the temperature is changing.

A noise may be heard due to louver returning to its original position when power is first turned on.

Dust is blown out from the indoor unit.

This is a normal condition when the air conditioner has not been used for a long time or during first use of the unit.

A peculiar smell comes out from the indoor unit.

This is because the indoor unit gives off smells permeated from building material, furniture or smoke.

The air conditioner turns to FAN only mode from COOL or HEAT (Only for models with heating function) mode.

When indoor temperature reaches the temperature setting on air conditioner, the compressor will stop automatically, and the air conditioner turns to FAN only mode. The compressor will start again when the indoor temperature rises in COOL mode or falls in HEAT mode (Only for models with heating function) to the set point.

Dripping water condenses on the surface of indoor unit

Dripping water may generate on the surface of the indoor unit when cooling in a high relative humidity (relative humidity higher than 80%). Adjust the horizontal louver to the maximum air outlet position and select HIGH fan speed.

Heating mode (Only for models with heating function)

The air conditioner draws in heat from the outdoor unit and releases it via the indoor unit during heating operation. When the outdoor temperature falls, heat drawn in by the air conditioner decreases accordingly. At the same time, heat loading of the air conditioner increases due to larger difference between indoor and outdoor temperature. If a comfortable temperature can't be achieved by the air conditioner, we suggest you use a supplementary heating device.

Auto-restart function

Power failure during operation will stop the unit completely. For the unit without Auto-restart feature, when the power restores, the OPERATION indicator on the indoor unit starts illuminating. To restart the operation, press the ON/OFF button on the remote controller. For the unit with Auto-restart feature, when the power restores, the unit restarts automatically with all the previous settings preserved by the memory function.

Lightning or a wireless telephone operating nearby may cause the unit to malfunction.

Disconnect the unit with power and then re-connect the unit with power again. Push the ON/OFF button on the remote controller to restart operation.

Solution for problems

If your air conditioner malfunctions, check the following information to find solutions or probable causes of the failure. Do not try to repair the unit by yourself, if these solutions do not solve the failures, call your local service repair team.

Poor Equipment performance

1. The air outlet or inlet of outdoor unit is obstructed.
2. The air outlet or inlet of indoor unit is obstructed.
3. The outdoor temperature is high due to direct sunlight or another heat source.
4. A heater or a cooking stove is being used in the same room.
5. The room is occupied by multiple people, thus raising the heat load.
6. The air filter is obstructed by dust or is dirty.
7. Inappropriate temperature adjustment.
8. The capacity of the equipment is not adequate for the size of the room.
9. Air conditioner was just turned on.
10. Windows or doors are open.

The unit does not start

1. No power supply.
2. The voltage is not sufficient or incorrect.
3. Temperature is not adjusted properly.
4. Fuse may have blown.
5. The remote control batteries need to be replaced.
6. The time you have set with timer is incorrect.

Attention!!

Stop the air conditioner immediately if one of the following malfunctions occur

1. The operation indicator flashes (5 times per second) and the flashing does not stop by disconnecting the power and then restarting the unit.
2. Fuse blows frequently or circuit breaker trips frequently. (If this occurs, please contact your installer or licensed contractor).
3. Water spills over the equipment.
4. Remote control does not work.
5. Any other abnormal situations.

Major Appliance 5 Year Parts Only Limited Warranty

Your appliance is covered by a five year parts only limited warranty. For five years from your original date of purchase, Electrolux will pay for the cost of replacement parts used in the repair of the appliance if the original parts prove to be defective in materials or workmanship when such appliance is installed, used and maintained in accordance with the provided instructions.

Exclusions This limited warranty does not cover the following:

1. Products with original serial numbers that have been removed, altered or cannot be readily determined.
2. Product that has been transferred from its original owner to another party or removed outside the USA or Canada.
3. Rust on the interior or exterior of the unit.
4. Products purchased "as-is" are not covered by this warranty.
5. Food loss due to any refrigerator or freezer failures.
6. Products used in a commercial setting.
7. Service calls to correct the installation of your appliance or to instruct you how to use your appliance.
8. Service calls which do not involve malfunction or defects in materials or workmanship, or for appliances not in ordinary household use or used other than in accordance with the provided instructions.
9. Expenses for making the appliance accessible for servicing, such as removal of trim, cupboards, shelves, etc., which are not a part of the appliance when it is shipped from the factory.
10. Service calls to repair or replace appliance light bulbs, air filters, water filters, other consumables, or knobs, handles, or other cosmetic parts.
11. Surcharges including, but not limited to, any after hour, weekend, or holiday service calls, tolls, ferry trip charges, or mileage expense for service calls to remote areas, including the state of Alaska.
12. Damages to the finish of appliance or home incurred during installation, including but not limited to floors, cabinets, walls, etc.
13. Damages caused by: services performed by unauthorized service companies; use of parts other than genuine Electrolux parts or parts obtained from persons other than authorized service companies; or external causes such as abuse, misuse, inadequate power supply, accidents, fires, or acts of God.
14. The consumer will be responsible for diagnostic, labor, and parts costs as well as any removal, transportation and reinstallation expenses which are incurred during service.
15. Labor costs for any and all repairs.

Major Appliance 5 Year Parts Only Limited Warranty

DISCLAIMER OF IMPLIED WARRANTIES; LIMITATION OF REMEDIES

CUSTOMER'S SOLE AND EXCLUSIVE REMEDY UNDER THIS LIMITED PARTS ONLY WARRANTY SHALL BE THE COST OF REPLACEMENT PARTS AS PROVIDED HEREIN. CLAIMS BASED ON IMPLIED WARRANTIES, INCLUDING WARRANTIES OF MERCHANTABILITY OR FITNESS FOR A PARTICULAR PURPOSE, ARE LIMITED TO ONE YEAR OR THE SHORTEST PERIOD ALLOWED BY LAW, BUT NOT LESS THAN ONE YEAR. ELECTROLUX SHALL NOT BE LIABLE FOR CONSEQUENTIAL OR INCIDENTAL DAMAGES SUCH AS PROPERTY DAMAGE AND INCIDENTAL EXPENSES RESULTING FROM ANY BREACH OF THIS WRITTEN LIMITED WARRANTY OR ANY IMPLIED WARRANTY. SOME STATES AND PROVINCES DO NOT ALLOW THE EXCLUSION OR LIMITATION OF INCIDENTAL OR CONSEQUENTIAL DAMAGES, OR LIMITATIONS ON THE DURATION OF IMPLIED WARRANTIES, SO THESE LIMITATIONS OR EXCLUSIONS MAY NOT APPLY TO YOU. THIS WRITTEN WARRANTY GIVES YOU SPECIFIC LEGAL RIGHTS. YOU MAY ALSO HAVE OTHER RIGHTS THAT VARY FROM STATE TO STATE.

If You Need Service Keep your receipt, delivery slip, or some other appropriate payment record to establish the warranty period should service be required. If service is performed, it is in your best interest to obtain and keep all receipts. Service under this warranty must be obtained by contacting Electrolux at the addresses or phone numbers below.

This limited warranty only applies in the USA and Canada. In the USA, your appliance is warranted by Electrolux Major Appliances North America, a division of Electrolux Home Products, Inc. In Canada, your appliance is warranted by Electrolux Canada Corp. Electrolux authorizes no person to change or add to any obligations under this warranty. Obligations for service and parts under this warranty must be performed by Electrolux or an authorized service company. Product features or specifications as described or illustrated are subject to change without notice.

USA

1.866.942.1567

Electrolux Major Appliances
North America
P.O. Box 212378
Augusta, GA 30907



Canada

1.866.942.1567

Electrolux Canada Corp.
5855 Terry Fox Way
Mississauga, Ontario, Canada
L5V 3E4