

Use & Care Guide  
Manual de Uso y Cuidado  
English / Español

Model/Modelo: 790.4253\*, 790.4251\*

# Kenmore®

## Electric Range

## Estufa Eléctrica

\* = color number, número de color

P/N 139901301 Rev. C

Sears Brands Management Corporation  
Hoffman Estates, IL 60179 U.S.A.  
[www.kenmore.com](http://www.kenmore.com)  
[www.sears.com](http://www.sears.com)



# Table of Contents

Please carefully read and save these instructions .....	2	Types of Cooktop Surface Elements .....	11
Kenmore Limited Warranty .....	2	Home Canning .....	11
Before Setting Surface Controls.....	9	Setting Surface Controls .....	12
Using proper cookware .....	9	Before Setting Oven Controls.....	14
Cookware Material Types .....	9	Oven vent location .....	14
About the ceramic glass cooktop .....	9	Oven Controls .....	15
About the Radiant Surface Elements .....	10	Self Clean .....	22
Element On and Hot Surface Indicator Lights .....	10	Care & Cleaning .....	24
		Before You Call .....	28
		Solutions to Common Problems .....	29

---

## Please carefully read and save these instructions

This Use & Care Guide contains operating instructions for your appliance and feature information for several models. Your product may not have all the described features. The graphics shown are representative. The graphics on your appliance may not look exactly like those shown. Common sense and caution must be practiced with installing, operating and maintaining any appliance.

### Kenmore Limited Warranty

When installed, operated and maintained according to all instructions supplied with the product, if any non-consumable part of this appliance fails due to a defect in material and workmanship within one year from the date of purchase, call 1-800-4-MY-HOME® to arrange for free repair.

This warranty applies for only 90 days from the date of purchase if this appliance is ever used for other than private family purposes.

#### **This warranty covers only defects in material and workmanship. Sears will not pay for:**

1. Cracks in a ceramic glass cooktop that are not a result of thermal shock.
2. Stains and scratches on a ceramic glass cooktop resulting from failure to maintain it properly according to all instructions supplied with the product.
3. Consumable items that can wear out from normal use, including but not limited to filters, belts, light bulbs, and bags.
4. A service technician to instruct the user in correct product installation, operation or maintenance.
5. A service technician to clean or maintain this product.
6. Damage to or failure of this product if it is not installed, operated or maintained according to all instructions supplied with the product.
7. Damage to or failure of this product resulting from accident, abuse, misuse or use for other than its intended purpose.
8. Damage to or failure of this product caused by the use of detergents, cleaners, chemicals or utensils other than those recommended in all instructions supplied with the product.
9. Damage to or failure of parts or systems resulting from unauthorized modifications made to this product.

#### **Disclaimer of implied warranties; limitation of remedies**

Customer's sole and exclusive remedy under this limited warranty shall be product repair as provided herein. Implied warranties, including warranties of merchantability or fitness for a particular purpose, are limited to one year or the shortest period allowed by law. Sears shall not be liable for incidental or consequential damages. Some states and provinces do not allow the exclusion or limitation of incidental or consequential damages, or limitation on the duration of implied warranties of merchantability or fitness, so these exclusions or limitations may not apply to you.

This warranty applies only while this appliance is used in the United States.

This warranty gives you specific legal rights, and you may also have other rights which vary from state to state.

**Sears Brands Management Corporation, Hoffman Estates, IL 60179 U.S.A.**

# IMPORTANT SAFETY INSTRUCTIONS

Read all instructions before using this appliance.

Read all instructions before using this appliance.

This manual contains important safety symbols and instructions. Pay attention to these symbols and follow all instructions given.

Do not attempt to install or operate your appliance until you have read the safety precautions in this manual. Safety items throughout this manual are labeled with a WARNING or CAUTION statement based on the hazard type.

## DEFINITIONS

**⚠** This is the safety alert symbol. It is used to alert you to potential personal injury hazards. Obey all safety messages that follow this symbol to avoid possible injury or death.

**⚠ WARNING** - Indicates a potentially hazardous situation which, if not avoided, may result in death or serious injury.

**⚠ CAUTION** - Indicates a potentially hazardous situation which, if not avoided, may result in minor or moderate injury.

**Important:** Indicates installation, operation, maintenance, or valuable information that is not hazard related.

**⚠ WARNING** Storage in or on appliance—Flammable materials should not be stored in an oven, near surface units or in the storage drawer, warmer drawer or lower oven. This includes paper, plastic, and cloth items, such as cookbooks, plastic ware, and towels, as well as flammable liquids. Do not store explosives, such as aerosol cans, on or near the oven.

## **⚠ WARNING**

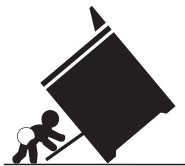

## Tip Over Hazard

- A child or adult can tip the appliance and be killed.
- Verify the device is engaged with the countertops or that the device has been installed to the walls of the cabinet, the wall, or the floor as per the installation instructions
- Ensure the anti-tip device is re-engaged with the countertop, the walls of the cabinet, the wall, or the floor as per the installation instructions when the appliance is moved.
- Do not operate the appliance without the anti-tip device in place and engaged.
- Failure to follow these instructions can result in death or serious burns to children and adults.



To check if the anti-tip bracket is installed properly, use both arms to grasp the rear edge of the

appliance back. Carefully attempt to tilt appliance forward. When properly installed, the appliance should not tilt forward.

Refer to the anti-tip bracket installation instructions supplied with your range for proper installation.

**⚠ WARNING** Do not leave children alone - Children should not be left alone or unattended in the area where appliance is in use. They should never be allowed to sit or stand on any part of the appliance, including the oven door, storage drawer, lower broiler drawer, warmer drawer, or lower double oven.

Save these instructions for future reference.

# IMPORTANT SAFETY INSTRUCTIONS

Read all instructions before using this appliance.

**⚠ WARNING** Stepping, leaning, or sitting on the door or drawers of a range can result in serious injuries and also cause damage to the appliance. Do not allow children to climb or play around the range. The weight of a child on an open oven door may cause the range to tip, resulting in serious burns or other injury.

**⚠ WARNING** Never cover any slots, holes, or passages in the oven bottom or cover an entire oven rack with materials, such as aluminum foil. Aluminum foil linings may trap heat, causing a fire hazard.

**⚠ CAUTION** Wear proper apparel. Loose-fitting or hanging garments should never be worn while using this appliance. Do not let clothing or other flammable materials come into contact with hot surfaces.

**⚠ CAUTION** Do not heat unopened food containers. Build-up of pressure may cause container to burst and result in injury.

**⚠ CAUTION** When heating fat or grease, watch it closely. Grease may catch fire if it becomes too hot.

**⚠ CAUTION** Do not use water or flour on grease fires. Smother fire or flame or use dry chemical or foam-type extinguisher. Cover the fire with a pan lid or use baking soda.

**⚠ CAUTION** Use dry potholders. Moist or damp potholders on hot surfaces may result in burns from steam. Do not let potholders touch hot cooking areas. Do not use towels or other bulky cloths.

**Important:** Safety Notice - The California Safe Drinking Water and Toxic Enforcement Act requires the governor of California to publish a list of substances known to cause cancer, birth defects, or other reproductive harms, and it requires businesses to warn customers of potential exposures to such substances.

**⚠ CAUTION** Do not store items of interest to children in the cabinets above a range or on the backguard of the range. Children climbing on the range to reach items could be seriously injured.

**⚠ CAUTION** Read and follow the below instructions and precautions for unpacking, installing, and servicing your appliance:

- Remove all tape and packaging before using the range. Dispose of the carton and plastic bags after unpacking the range. Never allow children to play with packaging material.
- Proper installation—Be sure your appliance is properly installed and grounded by a qualified technician in accordance with the National Electrical Code ANSI/NFPA No. 70 latest edition and local electrical code requirements. Install only per installation instructions provided in the literature package for this range.
- User servicing—Do not repair or replace any part of the appliance unless specifically recommended in the manuals. All other servicing should be done only by a qualified technician. This reduces the risk of personal injury and damage to the range.
- Ask your dealer to recommend a qualified technician and an authorized repair service. Know how to disconnect the power to the oven at the circuit breaker or fuse box in case of an emergency.
- Never modify or alter the construction of a range by removing the leveling legs, panels, wire covers, anti-tip brackets/screws, or any other part of the range.
- Remove the oven door from any unused range if it is to be stored or discarded.

Save these instructions for future reference.

# IMPORTANT SAFETY INSTRUCTIONS

Read all instructions before using this appliance.

- Do not attempt to operate the range during a power failure. If the power fails, always turn off the range. If the range is not turned off and the power resumes, the range will begin to operate again. Once the power resumes, reset the clock and oven functions.
- Cold temperatures can damage the electronic control. When using this appliance for the first time, or when the appliance has not been used for an extended period of time, be sure the appliance has been in temperatures above 32 °F (0 °C) for at least three hours before turning on the power to the appliance.
- Be sure to have an appropriate foam-type fire extinguisher available, visible, and easily located near the appliance.
- Placement of oven racks - Always place oven racks in desired location while oven is cool. If rack must be moved while oven is hot, use extreme caution and do not let potholder contact hot heating element in oven. Use potholders and grasp the rack with both hands to reposition. Remove all bakeware and utensils before moving the rack.
- Do not use a broiler pan without its insert. Broiler pans and inserts allow dripping fat to drain away from the high heat of the broiler. Do not cover the broiler insert with aluminum foil; exposed fat and grease could ignite.
- Protective liners - Do not use aluminum foil to line surface unit drip bowls or oven bottoms, except as suggested in the manual. Improper installation of these liners may result in a risk of electric shock, or fire.

## IMPORTANT INSTRUCTIONS FOR USING YOUR OVEN

- Never use your appliance for warming or heating the room.
- Use care when opening oven door, lower oven door, or warmer drawer (some models). Stand to the side of the range when opening the door of a hot oven. Let hot air or steam escape before you remove or replace food in the oven.
- Keep oven vent ducts unobstructed. Touching surfaces in this area when the oven is on may cause severe burns. Do not place plastic or heat-sensitive items on or near the oven vent. These items can melt or ignite.

## IMPORTANT INSTRUCTIONS FOR USING YOUR COOKTOP

- Know which knob controls each surface heating unit. Place a pan of food on the surface element unit before turning it on, and turn the element off before removing the pan.
- Use proper pan size — This appliance is equipped with one or more surface units of different sizes. Select utensils having flat bottoms large enough to cover the surface unit heating element. The use of undersized utensils will expose a portion of the heating element to direct contact and may result in ignition of clothing. Proper relationship of utensil to element will also improve efficiency.

Save these instructions for future reference.

# IMPORTANT SAFETY INSTRUCTIONS

Read all instructions before using this appliance.

- Utensil handles should be turned inward and not extend over adjacent surface elements. To reduce the risk of burns, ignition of flammable materials, and spillage due to unintentional contact with the utensil, position the utensil handle inward to keep from extending it over adjacent surface units.
- Never leave surface elements unattended at high heat settings. Boilovers cause smoking and greasy spillovers that may ignite, or a pan that has boiled dry may melt.
- Glazed cooking utensils — Only certain types of glass, glass/ceramic, ceramic, earthenware, or other glazed utensils are suitable for cook top service without breaking due to the sudden change in temperature. Check the manufacturer's recommendations for cook top use.
- When flaming foods under a ventilating hood, turn the fan on.
- Improper cookware may break due to sudden changes in temperature. Check the cookware manufacturer's recommendations for cooktop use.
- Do not use decorative surface burner covers. If an element is accidentally turned on, the decorative cover will become hot and possibly melt. Burns will occur if the hot covers are touched. Damage may also be done to the cooktop.

## IMPORTANT INSTRUCTIONS FOR CERAMIC GLASS COOKTOPS

- Do not cook on a broken cooktop. If the cooktop is broken, cleaning solutions and spills may penetrate the cooktop and create a risk of electric shock. Contact a qualified technician immediately.
- Clean cooktop with caution. If a wet sponge or cloth is used to wipe spills on a hot cooking area, be careful to avoid steam burns. Some cleaners can produce noxious fumes if applied to a hot surface.

## IMPORTANT INSTRUCTIONS FOR CLEANING YOUR RANGE

**⚠ CAUTION** Before manually cleaning any part of the range, be sure all controls are turned off and the range is cool. The range may be hot and can cause burns.

- Clean the range regularly to keep all parts free of grease that could catch fire. Pay particular attention to the area around each surface element. Do not allow grease to accumulate on the hood or filter.
- Always follow the manufacturer's recommended directions for use of kitchen cleaners and aerosols. Be aware that excess residue from cleaners and aerosols may ignite causing damage and injury.
- Clean ventilating hoods frequently. Grease should not be allowed to accumulate on the hood or filter. Follow the manufacturer's instructions for cleaning hoods.

Save these instructions for future reference.

# IMPORTANT SAFETY INSTRUCTIONS

Read all instructions before using this appliance.

## IMPORTANT INSTRUCTIONS FOR CLEANING YOUR SELF-CLEANING OVENS

- Clean only the parts listed in this manual. Before using self-clean, remove the broiler pan, any food, utensils, and bakeware from the oven. Remove oven racks unless otherwise instructed.
- Do not use oven cleaners. No commercial oven cleaner or oven liner protective coating of any kind should be used in or around any part of the oven.
- Do not clean door gasket. The door gasket is essential for a good seal. Care should be taken not to rub, damage, or move the gasket.
- Some birds are extremely sensitive to the fumes given off during the self-clean cycle of any oven. Move birds to another well-ventilated room.

**⚠ CAUTION** Do not touch surface heating units or surface cooking elements, areas near these surface heating units, or interior surface of the oven. Both surface heating and oven heating elements may be hot even though they are dark in color. Areas near surface cooking units may become hot enough to cause burns. During and after use, do not touch, or let clothing or other flammable materials touch these areas until they have had sufficient time to cool. Among these areas are the cook top, surfaces facing the cook top, the oven vent openings and surfaces near these openings, oven door and oven door window.

## GROUNDING INSTRUCTIONS

**⚠ WARNING** Avoid fire hazard or electrical shock. Failure to follow this warning may cause serious injury, fire, or death.

For personal safety, this appliance must be properly grounded. For maximum safety, the power cord must be plugged into an electrical outlet that is the correct voltage, is correctly polarized and properly grounded in accordance with local codes. It is the personal responsibility of the consumer to have the appropriate outlet with the correct, properly grounded wall receptacle installed by a qualified electrician. It is the responsibility and obligation of the consumer to contact a qualified installer to assure that the electrical installation is adequate and is in conformance with all local codes and ordinances.

See the installation instructions packaged with this appliance for complete installation and grounding instructions.

# IMPORTANT SAFETY INSTRUCTIONS

Read all instructions before using this appliance.

## PRODUCT RECORD

In the space below, record the date of purchase, model and serial number of your product. You will find the model and serial number printed on an identification plate. See [Figure 1](#) for serial plate location.

Model No. \_\_\_\_\_

Serial No. \_\_\_\_\_

Date of Purchase \_\_\_\_\_

Save sales receipt for future reference.

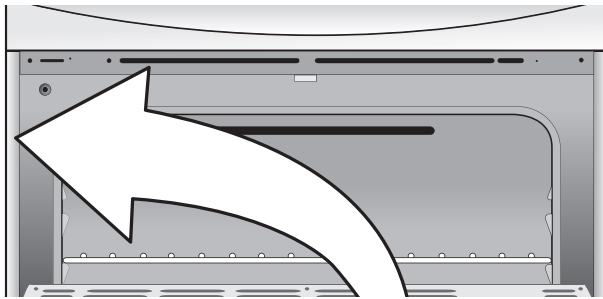

Figure 1: Serial plate location

To locate the serial plate, open storage drawer (some models) or warmer drawer (some models). The serial plate is attached to the left oven frame.

Save these instructions for future reference.



# Before Setting Surface Controls

## Using proper cookware

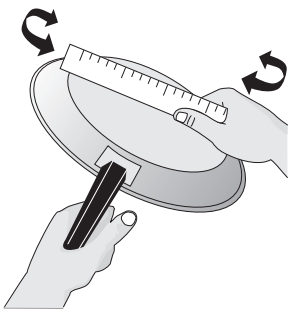

The size and type of cookware used will influence the radiant element power level setting needed for best cooking results. Be sure to follow the recommendations for using proper cookware as illustrated in both [Figure 2](#) and [Figure 3](#).

**Figure 2: Testing cookware**

Check for flatness by rotating a straight-edged ruler across the bottom of the cookware (see [Figure 2](#)). Cookware should have flat bottoms that make good contact with the entire surface heating element (see [Figure 3](#)).

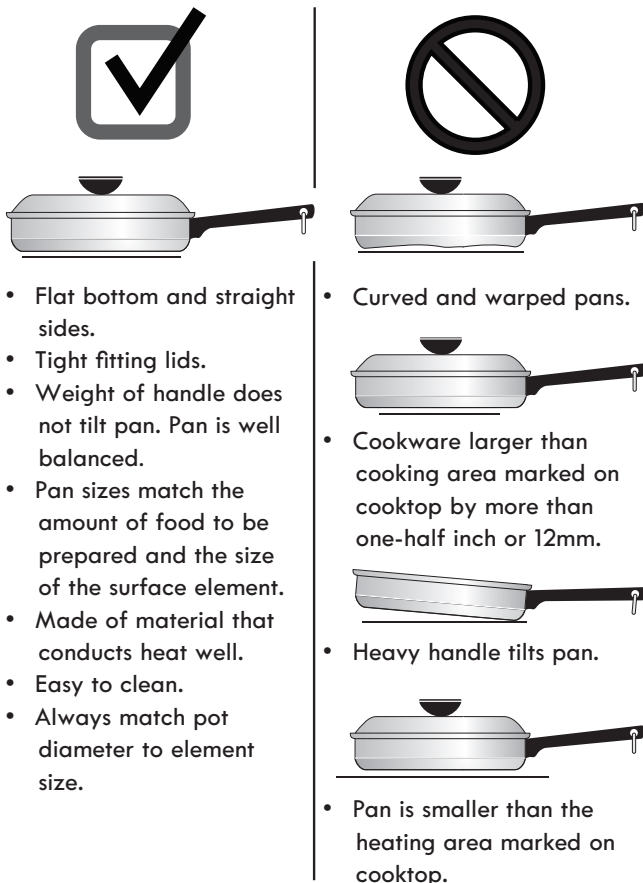

- Flat bottom and straight sides.
- Tight fitting lids.
- Weight of handle does not tilt pan. Pan is well balanced.
- Pan sizes match the amount of food to be prepared and the size of the surface element.
- Made of material that conducts heat well.
- Easy to clean.
- Always match pot diameter to element size.

- Curved and warped pans.
- Cookware larger than cooking area marked on cooktop by more than one-half inch or 12mm.
- Heavy handle tilts pan.
- Pan is smaller than the heating area marked on cooktop.

**Figure 3: Proper cookware placement**

## Cookware Material Types

The cookware material determines how evenly and quickly heat is transferred from the surface element to the pan bottom. The most popular materials available are:

**Aluminum** - Excellent heat conductor. Some types of food will cause it to darken (Anodized aluminum cookware resists staining and pitting). If aluminum pans slide across the ceramic cooktop, they may leave metal marks, which will resemble scratches. Remove these marks immediately.

**Copper** - Excellent heat conductor but discolors easily (see Aluminum).

**Stainless** - Slow heat conductor with uneven cooking results. Is durable, easy to clean and resists staining.

**Cast Iron** - A slow heat conductor however will retain heat very well. Cooks evenly once cooking temperature is reached. Not recommended for use on ceramic cooktops.

**Porcelain-enamel on metal** - Heating characteristics will vary depending on base material. Porcelain-enamel coating must be smooth to avoid scratching ceramic cooktops.

**Glass** - Slow heat conductor. Not recommended for ceramic cooktop surfaces because it may scratch the glass.

### Important note:

Do not place empty aluminum, glass, or porcelain-enamel coated cookware on the ceramic cooktop! The melting point of cookware made with these materials may be reached quickly, especially if left empty, and they may bond to the ceramic cooktop. If the cookware melts, it will damage the cooktop! Be sure to follow all the cookware manufacturer's suggestions when using any type of cookware on the ceramic cooktop.

## About the ceramic glass cooktop

The ceramic cooktop has radiant surface elements located below the surface of the glass. The design of the ceramic cooktop outlines the size and type of element available. Be sure to match the pan size with the diameter of the element outline on the cooktop and only flat-bottomed cookware should be used.

The type and size of cookware, the number of surface elements in use and their settings are all factors that will affect the amount of heat that will spread to areas beyond the surface elements. The areas surrounding the elements may become hot enough to cause burns.

## About the Radiant Surface Elements

The element temperature rises gradually and evenly. As the temperature rises, the element will glow red. To maintain the selected setting the element will cycle on and off. The heating element retains enough heat to provide a uniform and consistent heat during the off cycle.

For efficient cooking, turn off the surface element just before cooking is complete. This will allow residual heat to complete the cooking process.

**⚠ CAUTION** Radiant surface elements may appear to have cooled after they have been turned off. The glass surface may still be hot and burns may occur if the glass surface is touched before it has cooled sufficiently.

**⚠ CAUTION** Do not place plastic items such as salt and pepper shakers, spoon holders or plastic wrappings on top of the range when it is in use. These items could melt or ignite. Potholders, towels or wooden spoons could catch fire if placed too close to the surface elements.

**⚠ CAUTION** Do not allow aluminum foil, empty glass/porcelain cookware or any material that can melt to make contact with the ceramic cooktop. If these items melt on the cooktop they may damage the ceramic cooktop.

## Element On and Hot Surface Indicator Lights

Your appliance is equipped with two different types of surface control indicator lights that will glow on the control panel—the ELEMENT ON indicator light and the Hot Surface indicator lights.

The ELEMENT ON indicator lights are marked on the control panel and will glow when a surface cooking element is turned on. A quick glance at these indicator lights after cooking is an easy check to be sure all surface controls are turned off.



Figure 4: Element indicator light

The Surface indicator light is located on the cooktop. It will glow when any cooking area heats up and will remain on until the cooktop has cooled to a moderate level.



Figure 5: Element indicator light

### Important notes:

- Never place or straddle a cooking utensil over two different surface cooking elements at the same time unless the utensil is designed for that purpose. This can cause uneven heating results. This can also cause the ceramic cooktop to fracture.
- Radiant elements have a limiter that allows the radiant heating element to cycle on and off, even at the HI setting. This helps to prevent damage to the ceramic smoothtop. Cycling at the HI setting is normal and will occur more often if the cookware is too small for the radiant element or if the cookware bottom is not flat.
- Be sure to read the detailed instructions for ceramic glass cooktop maintenance and cleaning in the [“Care & Cleaning”](#) and [“Before You Call”](#) checklist sections of this Use & Care Guide.

## Types of Cooktop Surface Elements

The ceramic glass cooktop has radiant surface elements located below the surface of the glass. The patterns on the ceramic glass will outline the size and type of element available. The single radiant element or elements will have one round outline pattern shown on the cooktop. The warmer zone feature (on some models) located on the center rear area of the cooktop uses one round outline and is designed to keep food warm only. A dual radiant element (on some models) allows the user to set the smaller inner portion as a single element or both inner and outer portions may be set to heat together. See Figure 6 below.

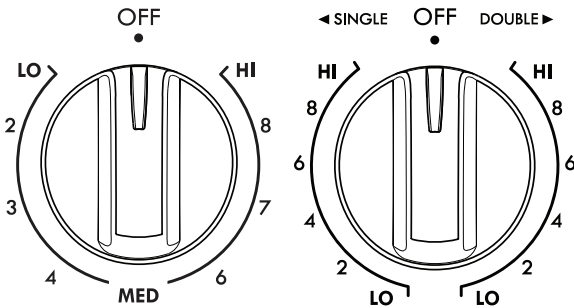

Figure 6: Single (L) and dual (R) radiant elements

### Turbo Boil Feature (some models)

Your appliance may be equipped with a special element on the ceramic cooktop marked TURBO BOIL.

These higher wattage radiant elements are best used when bringing larger quantities of liquid to temperature and when preparing larger quantities of food.

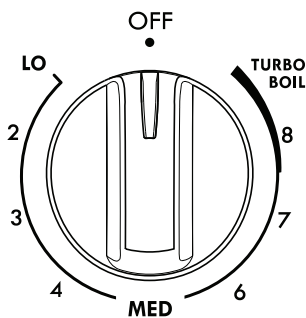

Figure 7: Turbo boil control (some models)



Figure 8: Turbo boil (some models)

## Home Canning

**CAUTION** Canning can generate large amounts of steam. Use extreme caution to prevent burns. Always raise the lid to vent steam away from you. Safe canning requires that harmful micro-organisms are destroyed and the jars are sealed completely. When canning in a water bath canner, a gentle but steady boil must be maintained continuously for the required time.

Be sure to read and observe all the following points when home canning with your appliance. Check with the United States Department of Agriculture (USDA) website ([www.usda.gov](http://www.usda.gov)) and be sure to read all the information they have available as well as follow their recommendations for home canning procedures.

- Use only quality flat bottom canners when home canning. Use a straight-edge to check canner bottom.
- Use only a completely flat bottom canner with no ridges that radiate from the bottom center when home canning. Heat is spread more evenly when the bottom surface is flat.
- Make sure the diameter of the canner does not exceed 1 inch beyond the surface element markings or burner. It is recommended to use smaller diameter canners on electric coil and ceramic glass cooktops and to center canners on the burner grates.
- Start with hot tap water to bring water to boil more quickly.
- Use the highest heat setting when first bringing the water to a boil. Once boiling is achieved, reduce heat to lowest possible setting to maintain that boil.
- Use tested recipes and follow instructions carefully. Check with your local Cooperative Agricultural Extension Service or a manufacturer of glass jars for the latest canning information.
- It is best to can small amounts and light loads.
- Do not leave water bath or pressure canners on high heat for an extended amount of time.
- Alternate surface units between each batch to allow the units and surrounding surfaces to cool down. Try to avoid canning on the same burner unit all day.

# Setting Surface Controls

## Radiant Surface Element Settings

The size and type of utensil used and the amount and type of food being cooked will influence the surface element power level setting needed for best cooking results.

The suggested settings found in are based on cooking with medium-weight aluminum pans with lids. Settings may vary when using other types of pans.

**Table 1: Suggested settings for surface elements**

Settings	Type of cooking
High (HI-9)	Start most foods, bring water to a boil, pan broiling
Medium high (7-8)	Continue a rapid boil, fry, deep fat fry
Medium (5-6)	Maintain a slow boil, thicken sauces and gravies or steam vegetables
Medium Low (2-4)	Keep foods cooking, poach, stew
Low (LO-1.8)	Keep warm, melt, simmer

### Important notes:

- For efficient cooking, turn off the element several minutes before cooking is complete. This will allow residual heat to complete the cooking process.
- The surface control knobs do not have to be set exactly on a particular spot. Use the graphics provided as a guide and adjust the control knob as needed. Each surface element provides a constant amount of heat at each setting. Refer to [Table 1](#) above for suggested power level settings.
- Start most cooking operations on a higher setting and then turn to a lower setting to finish cooking.
- Radiant elements have a limiter that allows the element to cycle on and off, even at the HI setting. This helps to prevent damage to the ceramic glass cooktop. Cycling at the HI setting is normal and can also occur if the cookware is too small for the radiant element or if the cookware bottom is not flat. Refer to [page 9](#) of this manual for using correct cookware instructions with the cooktop).
- A glowing red surface heating area extending beyond the bottom edge of the cookware indicates the cookware is too small for the surface heating area.

## Single Radiant Surface Elements

### To operate the single radiant element:

**CAUTION** Surface elements may appear to have cooled after they have been turned off. The surface element may still be hot and burns may occur if the surface element is touched before it has cooled sufficiently.

**CAUTION** Do not place plastic items such as salt and pepper shakers, spoon holders or plastic wrappings on top of the range when it is in use. These items could melt or ignite. Potholders, towels or wooden spoons could catch fire if placed too close to the surface elements.

**CAUTION** Do not allow aluminum foil, empty glass/porcelain cookware or any material that can melt to make contact with the ceramic cooktop. If these items melt on the cooktop they may damage the ceramic cooktop.

1. Place correctly sized cookware on surface element.
2. Push in and turn the surface control knob in either direction to the desired setting ([See Figure 9](#)).
3. When cooking is complete, turn the surface element to the OFF position before removing the cookware.

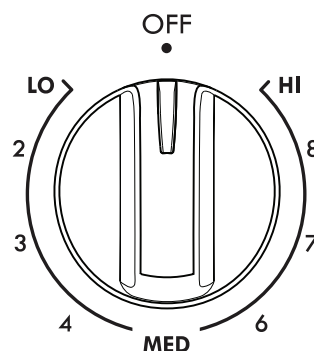

**Figure 9: Single radiant element**

## Dual Radiant Surface Elements (some models)

### To operate the dual radiant element:

**⚠ CAUTION** Surface elements may appear to have cooled after they have been turned off. The surface element may still be hot and burns may occur if the surface element is touched before it has cooled sufficiently.

**⚠ CAUTION** Do not place plastic items such as salt and pepper shakers, spoon holders or plastic wrappings on top of the range when it is in use. These items could melt or ignite. Potholders, towels or wooden spoons could catch fire if placed too close to the surface elements.

**⚠ CAUTION** Do not allow aluminum foil, empty glass/porcelain cookware or any material that can melt to make contact with the ceramic cooktop. If these items melt on the cooktop they may damage the ceramic cooktop.

1. Place correctly sized cookware on surface element.
2. Push in and turn the surface control knob clockwise to begin heating both the inner and outer portions of the element marked dual (See Figure 9).

### Important note:

Please note that you may switch from the single or dual settings at any time during cooking.

3. When cooking is complete, turn the radiant surface element off before removing the cookware.

### Important notes:

- For efficient cooking, turn off the element several minutes before cooking is complete. This will allow residual heat to complete the cooking process.
- The surface control knobs do not have to be set exactly on a particular spot. Use the graphics provided as a guide and adjust the control knob as needed. Each surface element provides a constant amount of heat at each setting. Refer to [Table 1](#) for suggested power level settings.
- Start most cooking operations on a higher setting and then turn to a lower setting to finish cooking.
- Radiant elements have a limiter that allows the element to cycle on and off, even at the HI setting. This helps to prevent damage to the ceramic glass cooktop. Cycling at the HI setting is normal and can also occur if the cookware is too small for the radiant element or if the cookware bottom is not flat. Refer to [page 9](#) of this manual for using correct cookware instructions with the cooktop).
- A glowing red surface heating area extending beyond the bottom edge of the cookware indicates the cookware is too small for the surface heating area.

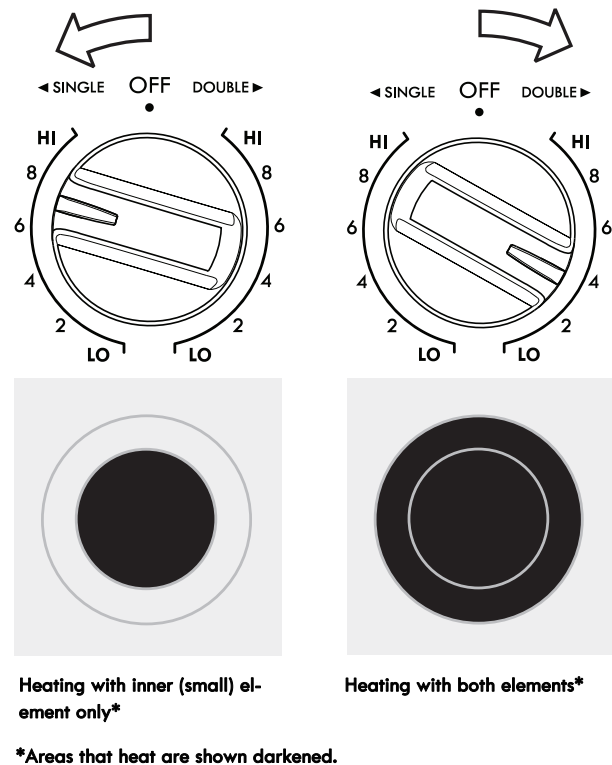

Figure 10: Dual radiant surface element operation

# Before Setting Oven Controls

## Oven vent location

The oven vent is located under the control panel (See Figure 11). When the oven is on, warm air passes through this vent. This venting is necessary for proper air circulation in the oven and good baking results. Do not block oven vent. Doing so may cause cooking failures, fires, or damage to the range. Steam or moisture may appear near the oven vent. This is normal.

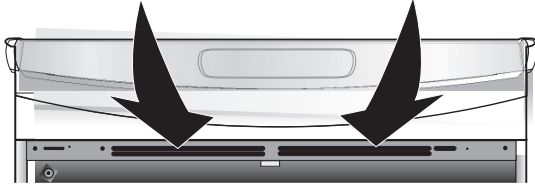

Figure 11: Oven vent location

## Removing, replacing, and arranging flat or offset oven racks

**CAUTION** Always use pot holders or oven mitts when using the oven. When cooking, the oven interior and exterior, oven racks and cooktop will become very hot which can cause burns.

**To Arrange** - Always arrange the oven racks when the oven is cool (prior to operating the oven).

**To Remove** - Pull the oven rack straight forward until it reaches the stop position. Lift up the front of the oven rack slightly and slide out.

**To Replace** - Place the oven rack on the rack guides on both sides of oven walls. Tilt the front of oven rack upward slightly and slide the oven rack back into place. Be sure oven racks are level before using.

**CAUTION** Protective Liners — Do not use aluminum foil to line the oven walls, racks, bottom, or any other parts of the range. Doing so will alter heat distribution, produce poor baking results, and may cause permanent damage to the oven interior. The temperatures reached during the self-clean process are hot enough to melt the foil. Only use aluminum foil as recommended in this manual. Improper installation of these liners may result in risk of electric shock, or fire.

## Air circulation in the oven

For best baking results allow 2" to 4" (5 cm to 10 cm) around the cookware for proper air circulation and be sure pans and cookware do not touch each other, the oven door, sides or back of the oven cavity. Hot air must be able to circulate around the cookware in the oven for even heat to reach around the food.

## Oven Rack Description

**CAUTION** Before using the self clean feature, be sure to remove all oven racks and accessories from the oven cavity to avoid damage to oven racks. If the oven racks are not removed they may discolor. Remove all items from the oven and cooktop including cookware, utensils and any aluminum foil. Aluminum foil will not withstand high temperatures from a self clean cycle and will melt.

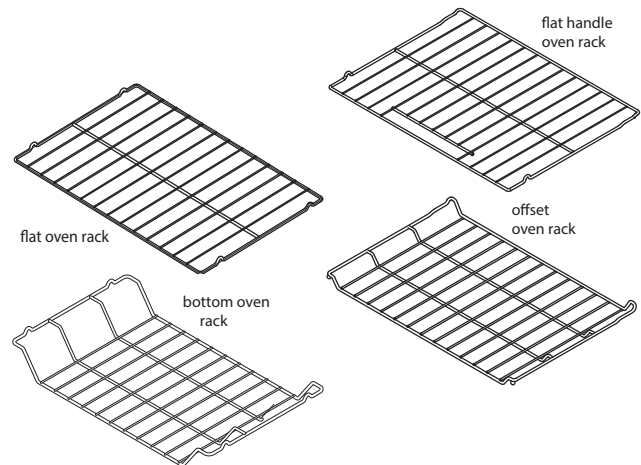
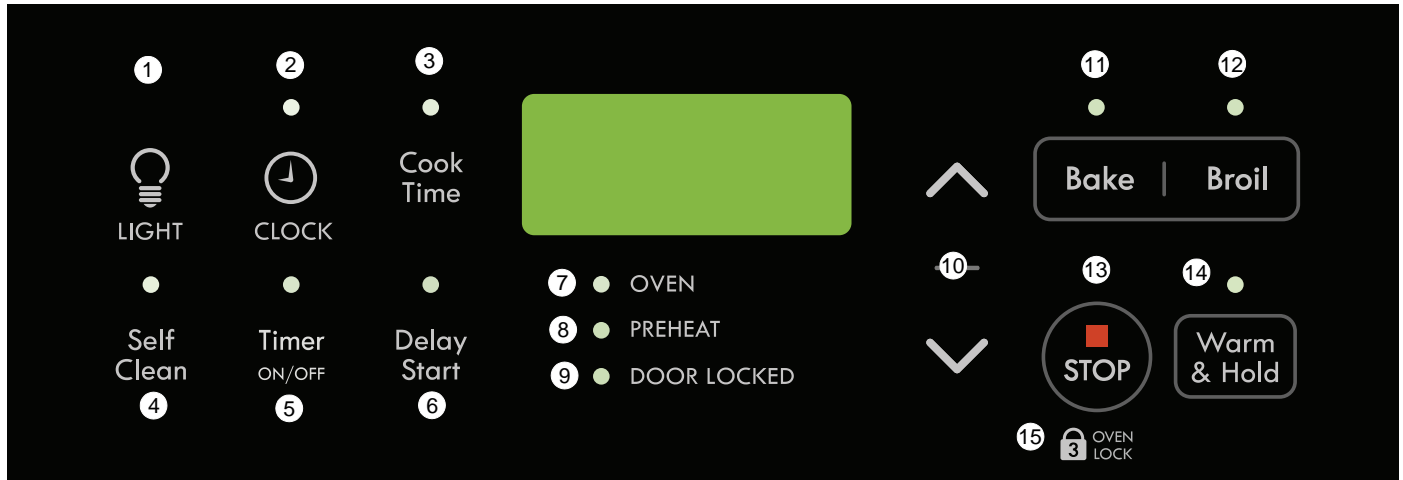

Figure 12: Types of oven racks

### Important note:

- The flat oven rack (some models) or flat handle oven rack (some models) may be used for most cooking needs.
- The offset oven rack (on some models) is designed to place the base of the rack about 1/2 of a rack position lower than flat oven racks. This design allows several additional positions between the flat rack positions.
- To maximize oven cooking space place the bottom oven rack (on some models) in the lowest rack position for roasting large cuts of meat.

# Oven Controls



1. **LIGHT** - Use to turn internal oven light on and off.
2. **CLOCK** - Use with arrow keys to set time of day.
3. **Cook Time** - Use to set a specific amount of time needed for cooking. Automatically cancels cooking process at end of set time.
4. **Self Clean** - Use to select 2, 3, or 4hr Self Clean cycle.
5. **Timer ON/OFF** - Use to set and cancel the timer and to set the Continuous Bake feature.
6. **Delay Start** - Use with Bake and Self Clean functions to program a delayed start bake or delayed start self clean cycle.
7. **OVEN indicator light** - Glows each time the oven cycles on to maintain the set oven temperature.
8. **PREHEAT indicator light** - Is on when oven is preheating. Stays on until the oven reaches the desired temperature.
9. **DOOR LOCKED indicator light** - Is on when door locks or unlocks and when oven lockout is active.
10. **Up / Down arrows** - Use with the function keys to accept settings and adjust temperature and times.
11. **Bake** - Selects Bake function. Bake light illuminates when in use.
12. **Broil** - Selects Broil function. Broil light illuminates when in use.

13. **STOP** - Cancels any active oven function except clock and timer.
14. **Warm & Hold** - Use to keep cooked food warm and at serving temperature for up to 3 hours.
15. **OVEN LOCK** - Use STOP key to activate oven door lock.

## Minimum & Maximum Control Settings

All of the cooking features listed have minimum and maximum time and temperature settings that can be entered into the control. An entry error tone (three short beeps) will sound if the entry of the temperature or time is below the minimum allowable setting or above the maximum setting for the cooking feature.

**Table 2: Minimum and maximum control settings**

Feature	Min. Temp. or Time	Max. Temp. or Time
Bake	170 °F (77 °C)	550 °F (288 °C)
Broil	LO (400 °F/205 °C)	HI (550 °F/288 °C)
Timer	1 Min	11 Hr. 59 Min.
Self Clean	2 Hours	4 Hours
Warm & Hold	170 °F (77 °C)	3 hours
Cook Time	1 Min.	11:59
Delay Time	1:00	12:59
Clock	1:00	12:59





## Oven Controls

### Setting the Clock

When the appliance is first powered up or when the power supply to the appliance has been interrupted, **12:00** will flash in the display. The time of day must first be set before operating the oven. Most models will not work properly without first setting the clock.

#### To set the clock:

1. Press **CLOCK** once. **CLO** appears in display.
2. Press  or  and the time appears in the display. Continue to hold the **Arrow** key until the correct time of day appears in the display.
3. Release the **Arrow** key to accept time of day.

#### Important note:

The time of day cannot be changed when the oven is in use.

### Silent or Audible Control Mode

The oven control is factory preset with audible tones active. The control may be programmed for silent operation.

To block the control from sounding when any key is pressed, press and hold **Delay Start** key until the control beeps once (about six seconds).

To return to the audible control mode, press and hold **Delay Start** until the control beeps once (about six seconds).

### Operating Oven Light

The oven light will automatically turn on when the oven door is opened. The oven light does not operate during a self-clean cycle.

Press the  icon to turn the oven light on or off whenever the oven door is closed. The oven light will not operate during a self clean cycle.



The oven light is located at the upper right rear wall of the oven interior and is covered with a glass shield held in place by screws. The glass shield protects the bulb from high temperatures and should always be in place when the oven is in use.

To replace the interior oven light, see [page 26](#).

### Changing the Temperature Display

The electronic oven control is set to display Fahrenheit (°F) when shipped from the factory. The display may be changed to show either Fahrenheit or Celsius (°C) oven temperatures.

#### To change temperature display mode from °F to °C or from °C to °F:

1. Press **Broil**.
2. Press  until **HI** appears in the display.
3. Press and hold **Broil** until **F** or **C** appears in the display.
4. Press either  or  to toggle between **F** or **C** mode choices and release the arrow key.
5. The display will sound an acceptance tone and the display will return to the time of day.

#### Important note:

The temperature display mode cannot be changed when the oven is in use.

### Oven Lock

The OVEN LOCK feature allows you to lock the oven portion of the appliance while the oven is not in use.

#### To activate OVEN LOCK feature:

1. Be sure the door is completely closed.
2. Press and hold **STOP** for three seconds. **Loc** will appear in the display. The DOOR LOCKED indicator light will flash while the motor driven door latch begins locking the oven door. Do not open the door during this time. Allow 15 seconds for the door to completely lock. Once oven door is locked, the time of day will appear in the display.

#### To cancel the OVEN LOCK feature:

1. Press and hold **STOP** for three seconds. The DOOR LOCKED indicator light will flash and the motor driven door latch will begin to unlock. Do not open the door at this time. The door will unlock completely in about 15 seconds.

#### Important notes:



- The Oven Lock feature automatically activates while the oven is in self clean and cannot be canceled without canceling the self clean cycle.
- To avoid possible damage to the oven door latch mechanism, do not attempt to open or close the oven door whenever the DOOR LOCKED indicator light is flashing.
- If a control key is pressed when the OVEN LOCK is active, **Loc** will appear in the display as a reminder that the oven keys are inactive when the OVEN LOCK feature is active.





## Setting the Timer

The timer may be set from 1 minute to 11 hours and 59 minutes.

### To set the timer:

1. Press **Timer ON/OFF**.
2. Press and hold  to increase the time. Release  when the desired time appears in the display.
3. Release and the timer will begin to count down.
4. When the set time has run out, the timer will sound with three beeps and will continue to beep three times every 60 seconds until **Timer ON/OFF** is pressed.

To change time remaining in timer, press and hold  or  to increase or decrease any time remaining.

To cancel the timer at any time, press **Timer ON/OFF** once.

### Important notes:

- The timer does not start or stop the cooking process. It serves as an extra timer in the kitchen that will beep when the set time has run out. The timer may be used alone or when any other oven function is active.
- The indicator light located above Timer ON/OFF will glow when the timer is active.
- The timer will display hours and minutes until 1 hour remains. When less than 1 hour remains, the display will count down in minutes and seconds. Once the timer has less than 1 minute remaining only seconds will display.

## Changing Between Continuous Bake Setting and 12-Hour Energy Saving Feature

The oven control has a factory-preset 12-Hour Energy Saving feature that will turn the oven off automatically if the oven is left on for more than 12 hours. The control may be programmed to override this feature to continuously bake.

### To change to continuous bake mode:

Press and hold **Timer ON/OFF** until the control beeps once (about six seconds). **- - hr** will appear in display. The control is set for continuous bake setting.

### To change to 12-Hour Energy Saving feature:

Press and hold **Timer Set/Off** until the control beeps once (about six seconds). **12hr** will now appear in display. The control is set for 12-Hour Energy Saving feature.

### Important note:

Changing between continuous bake or the 12-Hour Energy saving mode does not change how the cooktop controls operate.





## Oven Controls

### Setting Bake

Use the bake function whenever the recipe calls for baking using normal temperatures. The PREHEAT oven light is on until the set bake temperature is reached, when a reminder tone will sound to inform the user that the set bake temperature has been reached. Bake may be programmed for any temperature from 170 °F to 550 °F (77 °C to 288 °C). The factory preset bake temperature is 350 °F (177 °C).



**⚠ CAUTION** Always use pot holders or oven mitts when using the oven. When cooking the oven interior, oven racks and cook-top will become very hot which can cause burns.

#### To set Bake for 350 °F:

1. Arrange oven racks and close oven door.
2. Press **Bake**. The display shows **3 5 0**. The light above the Bake key illuminates while in use. The OVEN indicator light will glow each time the oven cycles on to maintain the set oven temperature.
3. To set temperature, press  or . By pressing  or , the oven temperature may be adjusted in 5 °F increments (1 °C if the control is set to display Celsius).
4. Release **Arrow** key when desired temperature appears. When the oven reaches the set temperature, the PREHEAT indicator light will turn off and the control will beep three times.

To cancel bake at anytime press .

#### To change the oven temperature after Bake has started:

1. Press **Bake**. The current set oven temperature will display.
2. Press  or  to increase or decrease the current set temperature to the new oven temperature.
3. When the new oven temperature appears, release the arrow key. The control will automatically accept the change.

#### Important note:

- If you wish to bake longer than 12 hours, see [“Changing Between Continuous Bake Setting and 12-Hour Energy Saving Feature”](#) on [page 17](#) mode for detailed information.

#### For best results:

- Fully preheat the oven before cooking items like cookies, biscuits and breads.
- When using any single rack, use rack position 2.
- Allow at least 2 inches (5 cm) space between bakeware to allow for proper air circulation.
- Do not open the oven door often. Opening the door will reduce the temperature in the oven and may increase cooking time.

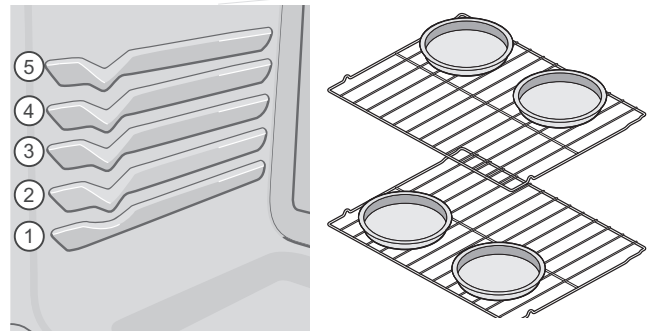

Figure 13: Rack positions (L) and pan spacing (R)





- When baking cakes or cookies using two oven racks, place cookware as shown in [Figure 13](#) and place racks in rack positions 1 and 4.
- Dark or dull pans absorb more heat than shiny bakeware, resulting in dark or over-browning of foods. It may be necessary to reduce the oven temperature or cook time to prevent over-browning of some foods. Dark pans are recommended for pies; shiny pans are recommended for cakes, cookies and muffins.

## Setting Cook Time

Use Cook Time to set the amount of time needed for baking. The oven will turn on immediately and stop automatically after the set cook time ends.



**To program the oven to begin baking immediately and to shut off automatically:**

**⚠ WARNING** Food Poisoning Hazard. Do not let food sit for more than one hour before or after cooking. Doing so can result in food poisoning or sickness.

1. Be sure that the clock displays the correct time of day.
2. Arrange oven racks and close oven door.
3. Press **Bake**. The display shows **350**.
4. By pressing  or , the temperature may be adjusted in 5 °F increments (1 °C if the control is set to display Celsius). Release key when desired set temperature is in display.
5. Press **Cook Time**. The display shows **:00**.
6. Press  or  to reach the desired cook time and release arrow key for oven control to accept cook time.
7. When the oven temperature reaches the set temperature, the PREHEAT indicator light turns off and the oven control will beep three times.
8. To cancel at anytime press .

When the cook time runs out, **End** will appear in the display. The oven control will beep three times every minute as a reminder until **STOP** is pressed.

**To change the oven temperature or cook time after baking has started:**

1. Press **Bake** (for oven temperature) or **Cook Time**.
2. To adjust temperature or cook time, press  or  and release when the desired temperature or cook time setting appears in the display.
3. Release the **Arrow** key. The oven control will beep when the change is accepted.

### Important notes:

- Cook Time and Delay Start may be set with Bake but are not available for use with Broil.
- While baking with Cook Time, press **Cook Time** to display any cook time remaining.
- The maximum Cook Time or Delay Start setting is 11 hours and 59 minutes.







## Setting Delay Start

Delay Start allows you to set a delayed starting time to the oven baking or cleaning functions.

**To program oven for a delayed starting time and to shut off automatically:**



**⚠ WARNING** Food Poisoning Hazard. Do not let food sit for more than one hour before or after cooking. Doing so can result in food poisoning or sickness. Foods that can easily spoil such as milk, eggs, fish, meat or poultry, should be chilled in the refrigerator first. Even when chilled, they should not stand in the oven for more than one hour before cooking begins, and should be removed promptly when finished cooking.

**⚠ CAUTION** Always use pot holders or oven mitts when using the oven. When cooking the oven interior, oven racks and cook-top will become very hot which can cause burn

1. Be sure that the clock displays the correct time of day.
2. Arrange oven racks and close oven door.
3. Press **Bake**. The display shows **350**.
4. Press  or , to set desired temperature (the oven temperature may be adjusted in 5 °F increments (1 °C if the control is set to display Celsius). When desired temperature is reached release arrow key for control to accept.
5. Press **Cook Time**. The display shows **:00**.
6. Press the  or  to set the desired cook time. Release arrow key when desired cook time appears in the display.
7. Press **Delay Start**. The time of day will appear in the display. Press  or  until the desired starting time appears in the display and release arrow key.
8. The oven will turn on at the set delayed starting time and begin heating. When the oven temperature reaches the set temperature, the PREHEAT indicator light will turn off and the oven control will beep three times.

To cancel at anytime, press .

**To change the oven temperature or cook time after baking has started:**

1. Press **Bake** (for oven temperature) or **Cook Time**.
2. Press  or  and release when the desired temperature or cook time setting appears in the display.

**When the cook time runs out:**

**End** will appear in the display. The oven control will beep three times every minute until  is pressed.





## Oven Controls

### Setting Broil

Use the Broil function to cook meats that require direct exposure to flame heat for optimum browning results. The Broil function is factory preset to broil at 550 °F.

The suggested broil settings found in Table 3 below are recommendations only. Increase or decrease broiling times or move to a different rack position to suit for doneness. If the food you are broiling is not listed in the table, follow the instructions provided in your cookbook and watch the item closely.

#### To set Broil:

1. Arrange the oven rack when cool. For optimum browning results, preheat oven for two minutes before adding food.
2. Position cookware in oven. Close oven door when broiling.
3. Press **Broil**. **HI** will appear in display.
4. Press  or  until the desired broil setting level appears in the display. Press  for **HI** broil or  for **LO** broil setting and release arrow key.
5. Preheat for 2 minutes. Broil with the door closed.
6. Turn food over and broil on the other side.
7. When finished broiling or to cancel at any time, press .

#### Remember:

Broiling is direct heat cooking and will produce smoke. If smoke is excessive, place food further away from the broil element.

**CAUTION** Always use pot holders or oven mitts when using the oven. When cooking the oven interior, oven racks and cooktop will become very hot which can cause burns.

**WARNING** Should an oven fire occur, leave the oven door closed and turn off the oven. If fire continues, use a fire extinguisher. Do not put water or flour on fire. Flour may be explosive and water can cause a grease fire to spread and cause personal injury.

#### Important notes:

- Always arrange oven racks when the oven is cool.
- Do not use a broil pan without the broil pan insert. Inserts are designed to drain the grease from the food and help avoid splatter and reduce smoking. Do not cover insert with foil. The exposed grease could ignite.
- When broiling, always pull the oven rack out to the stop position before turning or removing food.
- To purchase broil pan and insert call Sears at 1-800-4-MY-HOME® (1-800-469-4663) and order broiler kit 5304442087.

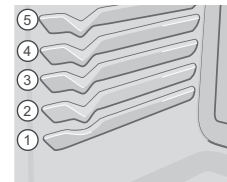
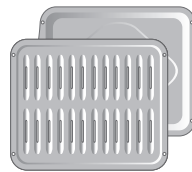

Figure 14: Broiler pan and insert Figure 15: Rack positions

Table 3: Suggested Broil Settings<sup>1</sup>

Food	Rack Position	Setting	Cook time in minutes		Internal Temperature	Doneness
			1st side	2nd side		
Steak, 1 inch thick	4th or 5th <sup>2</sup>	Hi	8	6	145°F (63°C)	Medium
Steak, 1 inch thick	4th or 5th <sup>2</sup>	Hi	10	8	160°F (71°C)	Medium-well
Steak, 1 inch thick	4th or 5th <sup>2</sup>	Hi	11	10	170°F (77°C)	Well
Pork Chops, 3/4 inch thick	4th	Hi	12	8	170°F (77°C)	Well
Chicken, bone-in	4th	Lo	25	15	170°F (77°C)	Well
Chicken, boneless	4th	Lo	10	8	170°F (77°C)	Well
Fish	4th	Hi	as directed		170°F (77°C)	Well
Shrimp	3rd	Hi	as directed		170°F (77°C)	Well
Hamburger, 1 inch thick	4th or 5th	Hi	9	7	145°F (63°C)	Medium
Hamburger, 1 inch thick	4th or 5th	H	10	8	170°F (77°C)	Well



1. Cook times are suggestions and should only be used as a guide. the USDA states, "Rare fresh beef is popular, but you should know that cooking it to only 140°F (60°C) means some food poisoning organisms may survive." (Source: Safe Food Book: Your Kitchen Guide. USDA Rev. June 1985). The lowest temperature recommended by the USDA is 145°F (63°C) for medium rare fresh beef, and 170°F (77°C) for well done.
2. Use an offset rack (if available) if you choose to use an oven rack in the top position. Watch food closely and check for desired doneness.

## Warm & Hold™





Warm & Hold will keep cooked foods warm and ready for serving for up to three hours after cooking has finished. After three hours the Warm & Hold will shut off automatically.

Warm & Hold should only be used with foods that are already at serving temperatures. Warm & Hold will maintain the oven temperature at 170 °F (77 °C).

### To set Warm & Hold:

1. If needed, arrange oven racks and place cooked food in oven.
2. Press **Warm & Hold**. **Hld** will appear in the display.
3. Press the  Arrow. The oven control will beep when Warm & Hold is accepted.
4. To turn Warm & Hold off at any time press .

### To set Warm & Hold to start after a Timed Bake automatically:



1. Press **Bake**. Press  or  to set temperature and release the arrow key for the oven to accept the set temperature.
2. Press **Cook Time**.
3. Press  or  to set time. Release arrow key when desired cook time appears in the display.
4. Press **Warm & Hold**. The oven control will beep when Warm & Hold is accepted.
5. Warm & Hold is set to turn on automatically after the Timed Bake or Delay Timed Bake has finished. The Warm & Hold indicator light will glow indicating that the Warm & Hold feature is set to start when the timed bake is finished.

## Adjusting Oven Temperature



Your appliance has been factory calibrated and tested to ensure an accurate baking temperature. For the first few uses, follow your recipe times and temperature recommendations carefully. If you think the oven is cooking too hot or too cool for your recipe times, you may adjust the User Programmable Offset (UPO) so the oven cooks hotter or cooler than the oven temperature displayed.

The oven temperature may be increased as much as +35 °F (+19 °C) or decreased -35 °F (-19 °C) from the factory calibrated settings.

### To adjust oven temperature:

1. Press **Bake**.
2. Press and hold  until **5 5 0** appears.
3. Press and hold **Bake** until **0** appears.
4. Use the  or  keys to adjust to the temperature in 1 °F increments.
5. Release the arrow key for control to accept the change.
6. If the **STOP** key is pressed during the programming mode, the UPO value will remain unchanged.

### Important notes:

- Making oven temperature adjustments will not change the Broil or Self-Clean operating temperatures.
- Do not use oven thermometers such as those found in grocery stores to check the temperature settings inside your oven. These oven thermometers may vary as much as 20 °F to 40 °F from actual temperatures.
- The oven temperature adjustment may be made if your oven control is set to display °C temperatures. Minimum and maximum settings for °C is plus or minus (±) 19 °C.
- If the display mode is set for °C, adjustments made will be in 1 °C increments on each press of  or .

## Oven Controls

### Self Clean

A self cleaning oven cleans itself with high temperatures well above normal cooking temperatures, which eliminate soils completely or reduces them to a fine powdered ash. You can wipe these soils away afterwards with a damp cloth.

The Self Clean function allows you to select three different cleaning times from 2, 3 or 4 hours. A 3-hour cleaning time is best used for normal cleaning; 2-hour time for light soils and a 4-hour clean time for heavier stubborn soils.

#### Read before starting Self Clean:

Be sure to read all following caution and important statements before starting a self clean cycle.

**⚠ WARNING** Do not leave small children unattended near appliance. During self clean cycle the outside of the oven can become very hot and cause burns if touched.

**⚠ WARNING** Do not line the oven walls, racks, oven bottom or any part of the range with aluminum foil. This will cause permanent damage to the oven interior and destroy heat distribution, and will melt to the oven interior.

**⚠ WARNING** Do not force the oven door open. This will damage the automatic door locking system. Use caution when opening the oven door after the self clean cycle ends. The oven may still be very hot and cause burns. To avoid possible burns stand to side of oven when opening door to allow steam or hot air to escape.

**⚠ WARNING** Some birds are extremely sensitive to fumes given off during the self clean cycle of any range. Move birds to a well ventilated room.

#### Important notes:

- Completely remove all oven racks and any accessories from oven cavity to avoid damage to oven racks. If the oven racks are not removed they may discolor.
- Remove all items from the oven and cooktop including cookware, utensils and any aluminum foil. Aluminum foil will not withstand high temperatures from a self clean cycle and will melt.
- Do not line the oven walls, racks, bottom, or any other parts of the range with aluminum foil. Doing so will alter heat distribution, produce poor baking results, and may cause permanent damage to the oven interior. During self-clean temperatures the oven will be hot enough to melt foil.
- Do not use oven cleaners or oven protective coatings in or around any part of the oven interior. Clean any soil from the oven frame, the inside oven gasket, including the area at the bottom center between the gasket ends, the oven door, the oven bottom (See [Figure 16](#)). These areas heat sufficiently to burn soil on. Clean using soap and water prior to starting Self Clean.

- Remove any excessive spills. Any spills on the oven bottom should be wiped up and removed before starting a self clean cycle. To clean use hot, soapy water and a cloth. Large spills can cause heavy smoke or fire when subjected to high temperatures. Do not allow food spills with high sugar or acid content (such as milk, tomatoes, sauerkraut, fruit juices or pie fillings) to remain on the surface as they may leave a dull spot even after cleaning.

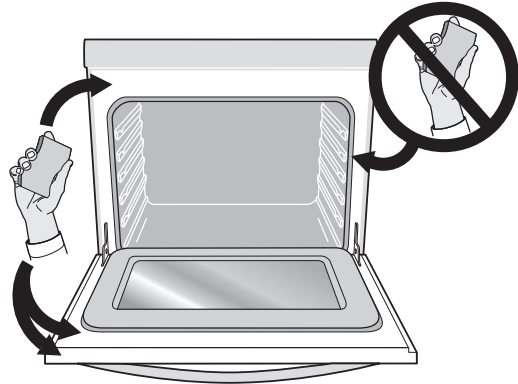

Figure 16: Areas to clean and to avoid



- Do not clean the oven door gasket ([Figure 16](#)). The woven material in the gasket is essential for a good seal. Care should be taken not to rub, damage or remove the oven door gasket. Doing so could cause damage to the door gasket and compromise the performance of the oven.

#### Important notes:

- The kitchen area should be well ventilated using an open window, ventilation fan or exhaust hood during the first self clean cycle. This will help eliminate the normal odors associated with the first self clean cycle.
- Do not attempt to open the oven door when the OVEN LOCK indicator light is flashing. Allow about 15 seconds for the motorized door latch mechanism to completely lock or unlock the oven door.
- When the clean time finishes the oven door will remain locked until the range has cooled sufficiently. In addition to the clean time that was programmed, you must allow about 1 additional hour for the oven to cool before you will be able to open the oven door.
- The Self Clean function will not operate whenever a radiant surface element is on or when the oven lockout is active.

## Setting Self Clean

### To set Select Clean to start immediately:

1. Be sure the oven is empty and all oven racks are removed. Remove all items from the cooktop. Be sure the oven door is completely closed.
2. Press **Self Clean**. The display shows **3:00**.
3. To change to a 2-hour clean time press  until **2:00** appears in the display. To select a 4-hour clean time press  until **4:00** appears in the display.
4. After selecting the clean time release the **Arrow** key for the oven control to activate the self clean. The DOOR LOCKED indicator light illuminates and **CLn** appears in the display.
5. When Self Clean cycle begins, the motorized door latch mechanism automatically starts to lock the oven door and the DOOR LOCKED indicator light flashes. Do not open the oven door when the DOOR LOCKED indicator light is flashing. Allow about 15 seconds for the oven door to completely lock.

Once the oven door is locked the DOOR LOCKED indicator light will glow steadily. When **CLn** will appear in the display Self Clean is active.



**CAUTION** Use caution when opening the oven door after self cleaning. The oven bake and broil elements may still be very hot and can cause burns. To avoid possible burns stand to the side of the oven when opening the oven door to allow hot air or steam to escape.

### When Self Clean is finished:

1. The time of day will appear in the display window and the DOOR LOCKED indicator light will continue to glow.
2. Once the oven has cooled down (about 1 hour) and the DOOR LOCKED indicator light has turned off the oven door may be opened.
3. When the oven interior has completely cooled, wipe away any residue or powdered ash with a damp cloth or paper towel.

## Delayed Start Self Clean

### To start Delay Start Self Clean:

1. Be sure the oven is empty and all oven racks are removed. Remove all items from the cooktop. Be sure oven door is completely closed.
2. Be sure the clock shows the correct time of day.
3. Press **Delay Start**.
4. Press and hold  to scroll to the time desired to start the self clean cycle. and release arrow key when the desired start time is displayed.
5. Press **Self Clean**. The display shows **3:00**.
6. Release the arrow key if a 3-hour clean is desired. To select a 2-hour clean time press  ; **2:00** appears in the display. To select a 4-hour clean time press  ; **4:00** appears in the display.
7. After selecting the desired clean time release the **Arrow** key. Self Clean is set to activate. The DOOR LOCKED indicator light will turn on and the oven door will lock in advance of the starting time. Once the starting time is reached **CLn** will appear in the display.

### If it becomes necessary to stop Self Clean when active:

1. Press .
2. If Self Clean has heated the oven to a high enough temperature, allow time for the oven to cool and for the DOOR LOCKED indicator light to turn off. When this indicator light turns off the oven door may be opened.
3. Restart Self Clean if needed.

### Important notes:

If Self Clean is active and a power failure occurs, the oven may not have thoroughly cleaned. This would depend on how much cleaning time had elapsed before the power failure. If needed after power is restored, set Self Clean again.

**CAUTION** The oven bake and broil elements may appear to have cooled after they have been turned off. The elements may still be hot and burns may occur if these elements are touched before they have cooled.

**CAUTION** Do not force the oven door open when self-clean is active. This can damage the automatic door-locking system. Use caution when opening the door after self-clean cycle is complete; the oven may still be very hot.



# Care & Cleaning

**Table 4: Cleaning Recommendations**

Surface Type	Recommendation
Control knobs Painted body parts Painted decorative trim Aluminum, plastic or vinyl trim	Use hot, soapy water and a cloth. For more difficult soils and built-up grease, apply a liquid detergent directly onto the soil. Leave on soil for 30-60 minutes. Rinse with a damp cloth and dry. Do not use abrasive cleaners on any of these materials; they can scratch. To remove control knobs, turn to OFF position. Grasp firmly and pull straight off the shaft. To replace knobs after cleaning, line up the flat sides of both knob and shaft, then push knob into place.
Control panel Control keypad membrane Decorative trim (some models)	Before cleaning the control panel, turn all controls off, activate oven lockout (on some models), and if needed remove any knobs from panel. Do not use abrasive cleaners on any of these materials; they can scratch. Clean using hot, soapy water and a cloth or sponge. Be sure to squeeze excess water from cloth or sponge before wiping control panel, especially when wiping around the controls area. Excess water in or around the controls may cause damage to the appliance. When rinsing, use clean water and a cloth or sponge and be sure to squeeze excess water from cloth or sponge before wiping the control panel.
Stainless Steel (some models)	Only use cleaners and polishes that are specifically manufactured for cleaning stainless steel. Always rub in direction of metal grain to avoid damaging. Do not use cleaners with high concentrations of chlorides or chlorine. Do not use harsh scrubbing cleaners. Polish with a lint-free cloth. Always be sure to wipe excess cleaner/polish off from the metal surface as bluish stains may occur during future oven heating that cannot be removed. Clean heavier soils with hot, soapy water and a cloth or sponge. Rinse and dry using clean water and a cloth.
Easy Clean™ Stainless Steel (some models)	Only use cleaners and polishes that are specifically manufactured for cleaning stainless steel. Always rub in direction of metal grain to avoid damaging. Do not use cleaners with high concentrations of chlorides or chlorine. Do not use harsh scrubbing cleaners. Polish with a lint free cloth. Always be sure to wipe excess cleaner/polish off from the metal surface as bluish stains may occur during future oven heating that cannot be removed. Clean heavier soils with hot, soapy water and a cloth or sponge. Rinse and dry using clean water and a cloth.
Porcelain enamel broiler pan and insert (available by mail order) Door liner and parts	Gentle scrubbing with a soapy non-abrasive scouring pad will remove most spots. Rinse with a 1:1 solution of clear water and ammonia. If necessary, cover difficult spots with an ammonia-soaked paper towel for 30 to 40 minutes. Rinse with clean water and a damp cloth, and then scrub with a soap-filled non-abrasive scouring pad. Rinse and wipe dry with a clean cloth. Do not allow food spills with high sugar or acid content (milk, tomatoes, sauerkraut, fruit juices, or pie filling) to remain on the surface; they may cause a dull spot even after cleaning.
Oven interior	For oven interior remove excessive spillovers from oven cavity bottom before starting Self Clean. Clean any soils from oven frame and door liner outside the oven door gasket. For very important cleaning precautions be sure to read all the instructions in the “Self Clean” section of the Oven Controls chapter on <a href="#">page 22</a> .
Oven racks	Remove oven racks from oven cavity before starting Self Clean. Clean by using a mild, abrasive cleaner following manufacturer's instructions. Rinse with clean water, dry, and then replace in oven.
Oven door	Use soap and water to clean the top, sides, and front of the oven door. Rinse well. You may use a glass cleaner on the outside glass of the oven door. Do not immerse the door in water. Do not spray or allow water or the glass cleaner to enter the door vents. Do not use oven cleaners, cleaning powders, or any harsh abrasive cleaning materials on the outside of the oven door.
Ceramic cooktop	Do not use spray oven cleaners on the cooktop. See “Cooktop Maintenance” on <a href="#">page 25</a> .



## Cooktop Maintenance

Consistent and proper cleaning is essential to maintaining your ceramic glass cooktop.

Prior to using your cooktop for the first time, apply the recommended CookTop® Cleaning Creme to the ceramic surface (on the web visit [www.sears.com](http://www.sears.com) for replacement cooktop cleaner, item number 40079). Buff with a non-abrasive cloth or sponge. This will make cleaning easier when soiled from cooking. The special cooktop cleaning cream leaves a protective finish on the glass to help prevent scratches and abrasions.

Sliding aluminum or copper clad bottom pans on the cooktop can cause metal markings on the cooktop surface. These marks should be removed immediately after the cooktop has cooled using the cooktop cleaning cream. Metal marks can become permanent if not removed prior to future use.

Cookware (cast iron, metal, ceramic or glass) with rough bottoms can mark or scratch the cooktop surface.

Do not:

- Slide anything metal or glass across the cooktop.
- Use cookware with dirt or dirt build up on bottom; replace with clean cookware before using.
- Use your cooktop as a cutting board or work surface in the kitchen.
- Cook foods directly on the cooktop surface without a pan.
- Drop heavy or hard objects on the ceramic glass cooktop, they may cause it to crack.

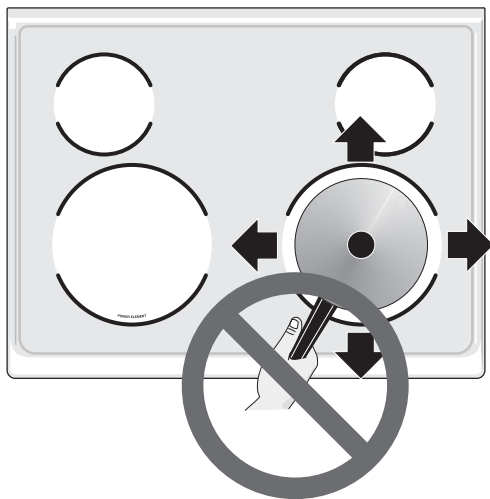

Figure 17: Cooktop care

## Cooktop Cleaning

**⚠ WARNING** Do not use a cooktop cleaner on a hot cooktop. The fumes can be hazardous to your health, and can chemically damage the ceramic-glass surface.

**⚠ CAUTION** Before cleaning the cooktop, be sure the controls are turned to OFF and the cooktop is cool. The glass surface could be hot and burns may occur if the glass surface is touched before it has cooled sufficiently.

### For light to moderate soil:

Apply a few drops of CookTop® Cleaning Creme directly to the cooktop. Use a paper towel or use a non-abrasive cloth or sponge to clean the entire cooktop surface. Make sure the cooktop is cleaned thoroughly, leaving no residue.

### For heavy, burned on soil:

Apply a few drops of CookTop® Cleaning Creme directly to the soiled area. Rub the soiled area using a non-abrasive cleaning tool, applying pressure as needed. Do not use the pad you use to clean the cooktop for any other purpose.

If soils remain, carefully scrape soils with a metal razor blade scraper, holding scraper at a 30 degree angle to the surface. Remove loosened soils with cooktop cleaning cream and buff surface clean.

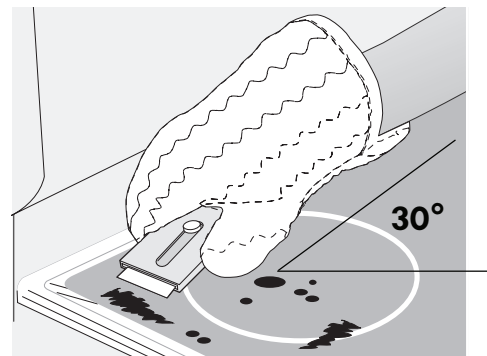

Figure 18: Figure without Border

### Plastic or foods with a high sugar content:

These types of soils need be removed immediately if spilled or melted onto the ceramic cooktop surface. Permanent damage (such as pitting of the cooktop surface) may occur if not removed immediately. After turning the surface elements off, use a razor blade scraper or a metal spatula with a mitt and scrape the soil from the hot surface (as illustrated). Allow the cooktop to cool, and use the same method for heavy or burned on soils.

## Care & Cleaning

### General Cleaning

See [Table 4](#) for more detailed information about cleaning specific parts of the range.

**⚠ CAUTION** Before manually cleaning any part of the range, be sure all controls are turned off and the range is cool. The range may be hot and can cause burns.

**⚠ CAUTION** Ammonia must be rinsed before operating the oven. Provide adequate ventilation.

### Cooktop Cleaning

**⚠ WARNING** Do not use a cooktop cleaner on a hot cooktop. The fumes can be hazardous to your health, and can chemically damage the ceramic-glass surface.

**⚠ CAUTION** Before cleaning the cooktop, be sure the controls are turned to OFF and the cooktop is cool. The glass surface could be hot and burns may occur if the glass surface is touched before it has cooled sufficiently.

### Aluminum Foil and Utensils

**⚠ WARNING** Never cover any slots, holes, or passages in the oven bottom or cover an entire oven rack with materials such as aluminum foil. Aluminum foil linings may trap heat, causing a fire hazard.

**⚠ WARNING** Protective Liners — Do not use aluminum foil to line the oven bottom. Only use aluminum foil as recommended in this manual. Improper installation of these liners may result in risk of electric shock, or fire.

- Aluminum foil - Use of aluminum foil on a hot cooktop can damage the cooktop. Do not use thin aluminum cooking utensils or allow aluminum foil to touch the surface elements under any circumstances.
- Aluminum utensils - The melting point of aluminum is much lower than that of other metals. Care must be taken when aluminum pots or pans are used on the cooktop. If aluminum pans are allowed to boil dry when using the cooktop, not only will the utensil be damaged or destroyed, but it may fuse to, break, or mark the ceramic glass surface, permanently damaging the cooktop surface.

### Replacing the Oven Light (some models)

The oven light is located at the rear of the oven cavity and is covered with a glass shield held by screws. The glass shield protects the light bulb and must be in place whenever the oven is in use.

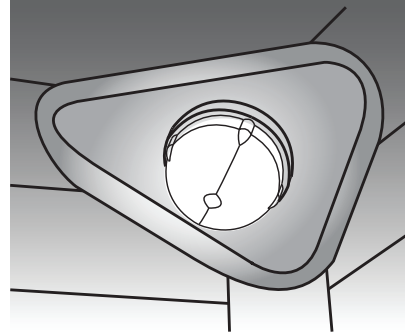

Figure 19: Replacing the oven light

### To replace the interior oven light bulb:

**⚠ CAUTION** Be sure the range is unplugged and all parts are cool before replacing oven light. Wear a leather-faced glove for protection against possible broken glass.

1. Turn electrical power off at the main source or unplug the appliance.
2. Press wire holder to one side to release the glass shield that covers the light bulb.
3. Unscrew the glass cover by turning it counter-clockwise.
4. Replace light with a new halogen bulb only.
5. Replace glass shield over bulb and snap wire holder back into place.
6. Turn power on at the main source (or plug the appliance in).
7. The clock will then need to be reset. To reset, see [“Setting the Clock”](#) on [page 16](#).

## Removing and Replacing the Lift-Off Oven Door

**⚠ CAUTION** To avoid possible injury when removing or replacing the oven door, follow the instructions below carefully and always hold the oven door with both hands positioned away from the door hinge area.

**⚠ CAUTION** The door is heavy. For safe, temporary storage, lay the door flat with the inside of the door facing down.

### To remove the oven door:

1. Open oven door completely, horizontal with the floor (See Figure 20).
2. Pull the door hinge locks on both left and right door hinges down from the oven frame completely towards the oven door (See Figure 21). A tool such as a small flat-blade screwdriver may be required.
3. Firmly grasp both sides of oven door along the door sides. Do not use the oven door handle (See Figure 22).
4. Close the door to the broil stop position (the oven door will stop into this position just before fully closing).
5. With the oven door in the broil stop position, lift the oven door hinge arms over the roller pins located on each side of the oven frame (See Figure 22).

### To replace oven door:

1. Firmly grasp both sides of oven door along the door sides. Do not use the oven door handle (See Figure 22).
2. Holding the oven door at the same angle as the removal position, seat the hook of the hinge arm over the roller pins located on each side of the oven door frame (See Figure 23). The hook of the hinge arms must be fully seated onto the roller pins.
3. Fully open the oven door, horizontal with floor (See Figure 20).
4. Push the door hinge locks up towards and into the oven frame on both left and right oven door hinges (See Figure 21) to the locked position; then, close the oven door.

## Special care instructions

Most oven doors contain glass that can break. Follow these recommendations:

- Do not close the oven door until all the oven racks are fully in place inside the oven cavity.
- Do not hit the glass with pots, pans, or any other object.
- Scratching, hitting, jarring, or stressing the glass may weaken its structure causing an increased risk of breakage at a later time.

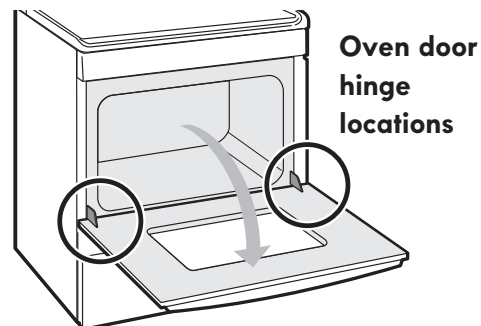

Figure 20: Oven hinge locations

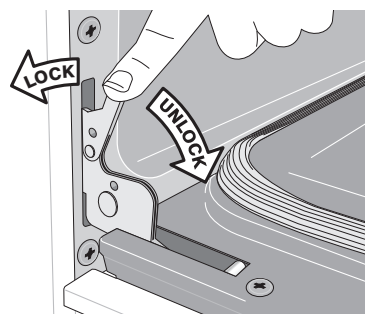

Figure 21: Hinge lock/unlock positions

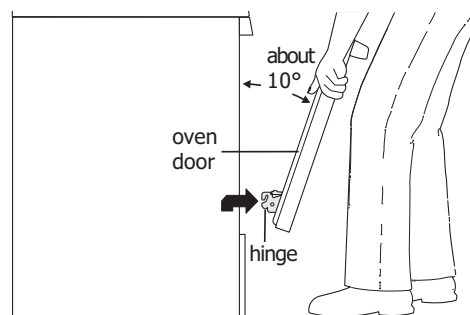

Figure 22: How to remove door

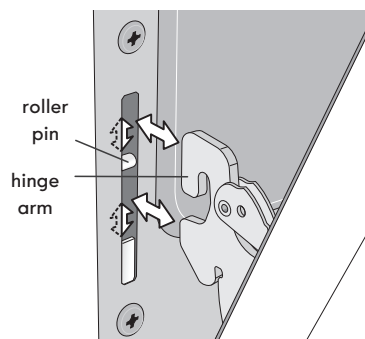

Figure 23: Hinge pin locations





# Before You Call

## Oven Baking

For best cooking results, heat the oven before baking cookies, breads, cakes, pies or pastries, etc. There is no need to preheat the oven for roasting meat or baking casseroles.

The cooking times and temperatures needed to bake a product may vary slightly from your previously owned appliance.

### Baking Problems and Solutions

Baking Problems	Causes	Corrections
Cookies and biscuits burn on the bottom 	<ul style="list-style-type: none"> <li>• Cookies and biscuits put into oven before the preheating time is completed.</li> <li>• Oven rack is overcrowded.</li> <li>• Dark pans absorb heat too fast.</li> </ul>	<ul style="list-style-type: none"> <li>• Allow oven to preheat to desired temperature before placing food in oven.</li> <li>• Choose pan sizes that permit 2" to 4" of air space (5.1 cm to 10.2 cm) on all sides when placed in the oven.</li> <li>• Use a medium weight baking sheet.</li> </ul>
Cakes too dark on top or bottom 	<ul style="list-style-type: none"> <li>• Cakes put in oven before preheating time is completed.</li> <li>• Rack position too high or too low.</li> <li>• Oven too hot.</li> </ul>	<ul style="list-style-type: none"> <li>• Allow oven to preheat to the selected temperature before placing food in the oven.</li> <li>• Use proper rack position for baking needs.</li> <li>• Set oven temperature 25 °F/13 °C lower than recommended.</li> </ul>
Cakes not done in center 	<ul style="list-style-type: none"> <li>• Oven too hot.</li> <li>• Incorrect pan size.</li> <li>• Pan not centered in oven.</li> </ul>	<ul style="list-style-type: none"> <li>• Set oven temperature 25 °F/13 °C lower than recommended.</li> <li>• Use pan size suggested in recipe.</li> <li>• Use proper rack position and place pan so there is 2" to 4" (5.1 cm to 10.2 cm) of space on all sides of pan.</li> </ul>
Cakes not level 	<ul style="list-style-type: none"> <li>• Oven not level.</li> <li>• Pan too close to oven wall or rack overcrowded.</li> <li>• Pan warped.</li> </ul>	<ul style="list-style-type: none"> <li>• Place a marked glass measuring cup filled with water on the center of the oven rack. If the water level is uneven, refer to the installation instructions for leveling the oven.</li> <li>• Be sure to allow 2" to 4" (5.1 cm to 10.2 cm) of clearance on all sides of each pan in the oven.</li> <li>• Do not use pans that are dented or warped.</li> </ul>
Foods not done when cooking time is over 	<ul style="list-style-type: none"> <li>• Oven too cool.</li> <li>• Oven overcrowded.</li> <li>• Oven door opened too frequently.</li> </ul>	<ul style="list-style-type: none"> <li>• Set oven temperature 25 °F/13 °C higher than suggested and bake for the recommended time.</li> <li>• Be sure to remove all pans from the oven except the ones to be used for baking.</li> <li>• Open oven door only after shortest recommended baking time.</li> </ul>

## Solutions to Common Problems

Before you call for service, review the following list. It may save you time and expense. Possible solutions are provided with the problem listed:

Problem	Solution
<b>Oven control panel beeps and displays any code error</b>	<ul style="list-style-type: none"> <li>Oven control has detected a fault or error condition. Press <b>STOP</b> to clear the error code.</li> <li>Try bake or broil function. If the error codes repeat, turn off power to appliance, wait five minutes and then reapply power to the appliance.</li> <li>Set clock with correct time of day. Try bake or broil function again. If fault occurs again, press <b>STOP</b> to clear.</li> </ul>
<b>Poor baking results</b>	<ul style="list-style-type: none"> <li>Many factors effect baking results. Use proper oven rack position. Center food in the oven and space pans to allow air to circulate. Preheat oven to the set temperature before placing food in the oven. Try adjusting the recipe's recommended temperature or baking time. See "<a href="#">Setting Self Clean</a>" on <a href="#">page 23</a> if you feel the oven is too hot or cold.</li> </ul>
<b>Appliance is not level</b>	<ul style="list-style-type: none"> <li>Be sure floor is level, strong, and stable enough to adequately support range. If floor is sagging or sloping, contract a carpenter to correct the situation.</li> <li>Poor installation. Place oven rack in center of oven. Place a level on the oven rack. Adjust leveling legs at base of appliance until the rack is level.</li> <li>Kitchen cabinet alignment may make range appear not level. Be sure cabinets are square and have sufficient room for appliance clearance.</li> </ul>
<b>Cannot move appliance easily. Appliance must be accessible for service.</b>	<ul style="list-style-type: none"> <li>Cabinets not square or are built in too tightly to allow clearance for appliance. Contact builder or installer to make appliance accessible.</li> <li>Carpet interferes with appliance. Provide sufficient space so appliance can be lifted over carpet.</li> </ul>
<b>Entire appliance does not operate</b>	<ul style="list-style-type: none"> <li>Make sure power cord is plugged in properly to the outlet.</li> <li>Electrical power outage. Check house lights to be sure. Call your local electric company for service outage information.</li> <li>Service wiring is not complete. Call 1-800-4-MY-HOME® for assistance (see back cover).</li> </ul>
<b>Flames inside oven or smoking from oven vent</b>	<ul style="list-style-type: none"> <li>Excessive spills in oven. Grease or food spilled onto oven bottom or oven cavity. Wipe up excessive spills before starting oven. If flames or excessive smoke are present when using broil, see "<a href="#">Self Clean</a>" on <a href="#">page 22</a>.</li> </ul>
<b>Self clean does not work</b>	<ul style="list-style-type: none"> <li>Oven control not set properly. See "<a href="#">Setting Self Clean</a>" on <a href="#">page 23</a>.</li> </ul>
<b>Soil not completely removed after self clean</b>	<ul style="list-style-type: none"> <li>Self Clean was interrupted. Review instructions in "<a href="#">Setting Self Clean</a>" section on <a href="#">page 23</a>.</li> <li>Excessive spills on oven bottom. Clean before starting self clean.</li> <li>Failure to clean soil from the oven frame, the door liner outside the oven door gasket, and the small area at the front center of the oven bottom. These areas are not in the self-cleaning area, but they get hot enough to burn on residue. Clean these areas before starting the self-cleaning cycle. Burned-on residue can be cleaned with a stiff nylon brush and water or a nylon scrubber. Be careful not to damage the oven gasket.</li> </ul>

## Before You Call

<b>Oven smokes excessively when broiling</b>	<ul style="list-style-type: none"><li>• Incorrect setting. Follow broiling instructions on <a href="#">page 22</a>.</li><li>• Meat too close to the broil element. Reposition broil rack to provide proper clearance between the meat and broil element.</li><li>• Meat not properly prepared. Remove excess fat from meat. Cut remaining fatty edges to prevent curling.</li><li>• Grease build up on oven surfaces. Regular cleaning is necessary when broiling frequently. Grease or food splatters will cause excessive smoking.</li></ul>
<b>Oven racks discolored or do not slide easily</b>	<ul style="list-style-type: none"><li>• Oven racks left in oven cavity during self clean. Always remove oven racks from oven cavity before starting a self-clean cycle. Clean using a mild abrasive cleaner following manufacturer's instructions. Rinse with clean water, dry, and replace in oven.</li></ul>
<b>Oven light does not work</b>	<ul style="list-style-type: none"><li>• Be sure the oven light is secure in the socket. See <a href="#">"Replacing the Oven Light (some models)"</a> on <a href="#">page 26</a>.</li></ul>
<b>Surface element is too hot or not hot enough</b>	<ul style="list-style-type: none"><li>• Incorrect surface control setting. Adjust power level setting.</li></ul>
<b>Surface element does not heat or does not heat evenly</b>	<ul style="list-style-type: none"><li>• Be sure the correct surface control knob is turned on for element needed.</li><li>• Lightweight or warped pans used. Use only flat, evenly balanced, medium or heavy-weight cookware. Flat pans heat better than warped pans. Cookware materials and weight of the material affect heating. Heavy and medium-weight pans heat evenly. Because lightweight pans heat unevenly, foods may burn easily.</li></ul>
<b>Oven portion of appliance does not operate</b>	<ul style="list-style-type: none"><li>• The time of day is not set. The oven clock must first be set in order to operate the oven.</li><li>• Be sure oven controls are set properly. See <a href="#">"Setting the Clock"</a> on <a href="#">page 16</a> and review instructions for the desired cooking function in this manual.</li><li>• Service wiring is not complete.</li></ul>
<b>Scratches and abrasions on cooktop surface</b>	<ul style="list-style-type: none"><li>• Coarse particles such as salt or hardened soils between cooktop and utensils can cause scratches. Be sure cooktop surface and bottoms of utensils are clean before usage. Small scratches do not affect cooking and will become less visible with time.</li><li>• Cleaning materials not recommended for ceramic-glass cooktop have been used. Apply the recommended CookTop® Cleaning Creme to the ceramic surface (on the web visit <a href="#">www.sears.com</a> for replacement cooktop cleaner, item number 40079). Buff with a nonabrasive cloth or sponge.</li><li>• Cookware with rough bottom was used. Use smooth, flat-bottomed cookware.</li></ul>
<b>Brown streaks or specks on cooktop surface</b>	<ul style="list-style-type: none"><li>• Boilovers are cooked onto surface. Use razor blade scraper to remove soil.</li></ul>
<b>Areas of discoloration with a metallic sheen on cooktop surface</b>	<ul style="list-style-type: none"><li>• Mineral deposits from water and food. Remove using the recommended CookTop® Cleaning Creme to the ceramic surface (on the web visit <a href="#">www.sears.com</a> for replacement cooktop cleaner, item number 40079). Buff with a non-abrasive cloth or sponge</li></ul>

## Master Protection Agreements

*Congratulations on making a smart purchase.* Your new Kenmore® product is designed and manufactured for years of dependable operation. But like all products, it may require preventive maintenance or repair from time to time. That's when having a Master Protection Agreement can save you money and aggravation.

The Master Protection Agreement also helps extend the life of your new product. Here's what the Agreement\* includes:

- ☑ **Parts and labor** needed to help keep products operating properly **under normal use**, not just defects. Our coverage goes **well beyond the product warranty**. No deductibles, no functional failure excluded from coverage – **real protection**.
- ☑ **Expert service** by a force of more than **10,000 authorized Sears service technicians**, which means someone you can trust will be working on your product.
- ☑ **Unlimited service calls and nationwide service**, as often as you want us, whenever you want us.
- ☑ **“No-lemon” guarantee** – replacement of your covered product if four or more product failures occur within twelve months.
- ☑ **Product replacement** if your covered product can't be fixed.
- ☑ **Annual Preventive Maintenance Check** at your request – no extra charge.
- ☑ **Fast help by phone** – we call it **Rapid Resolution** – phone support from a Sears representative on all products. Think of us as a “talking owner's manual”.
- ☑ **Power surge protection** against electrical damage due to power fluctuations.
- ☑ **\$250 Food Loss Protection** annually for any food spoilage that is the result of mechanical failure of any covered refrigerator or freezer.
- ☑ **Rental reimbursement** if repair of your covered product takes longer than promised.
- ☑ **25% discount** off the regular price of any non-covered repair service and related installed parts.

Once you purchase the Agreement, a simple phone call is all that it takes for you to schedule service. You can call anytime day or night, or schedule a service appointment online.

The Master Protection Agreement is a risk free purchase. If you cancel for any reason during the product warranty period, we will provide a full refund. Or, a prorated refund anytime after the product warranty period expires. Purchase your Master Protection Agreement today!

**Some limitations and exclusions apply. For prices and additional information in the U.S.A. call 1-800-827-6655.**

**\* Coverage in Canada varies on some items. For full details call Sears Canada at 1-800-361-6665.**

## Sears Installation Service

*For Sears professional installation* of home appliances, garage door openers, water heaters, and other major home items, in the U.S.A. or Canada call **1-800-4-MY-HOME®**.

## Acuerdos maestros de protección

*Enhorabuena por haber hecho una compra inteligente.* Su nuevo producto Kenmore® está diseñado y fabricado para brindarle años de funcionamiento fiable. Pero, como cualquier producto, puede necesitar mantenimiento preventivo o reparaciones periódicas. Es por eso que tener un Acuerdo maestro de protección podría ahorrarle dinero y molestias.

El Acuerdo maestro de protección también sirve para prolongar la durabilidad de su nuevo producto. El acuerdo\* incluye lo siguiente:

- ☑ **Piezas y mano de obra** necesarias para contribuir a mantener el funcionamiento adecuado de los productos **utilizados en condiciones normales de uso**, no sólo en caso de defectos de los productos. Nuestra cobertura va **mucho más allá que la garantía del producto**. No se aplican deducibles ni exclusiones por fallas del funcionamiento: es decir, **verdadera protección**.
- ☑ **Servicio técnico por expertos** (más de **10000 técnicos autorizados de Sears**), lo cual significa que quien repare o realice el mantenimiento de su producto será un profesional de confianza.
- ☑ **Servicio técnico a escala nacional y número ilimitado de llamadas de solicitud de servicio técnico**: se puede poner en contacto con nosotros cuantas veces lo desee y cuando lo desee.
- ☑ **Garantía “sin sorpresas”**: se reemplaza el producto cubierto por el acuerdo si ocurren cuatro o más fallas del producto en un periodo de 12 meses.
- ☑ **Reemplazo del producto**: en caso de que no se pueda reparar el producto cubierto por el acuerdo.
- ☑ **Revisión anual preventiva de mantenimiento del producto**: puede solicitarla en cualquier momento, sin costo alguno.
- ☑ **Rápida asistencia telefónica**, la cual denominamos **Solución rápida**: es decir, asistencia telefónica a través de cualquiera de nuestros representantes de Sears, sobre cualquiera de nuestros productos. Piense en nosotros como en un “manual parlante del usuario”.
- ☑ **Protección contra fallas eléctricas**, contra daños debidos a fluctuaciones de la corriente eléctrica.
- ☑ **\$250 al año para cubrir cualquier posible deterioro de alimentos** que haya tenido que desechar debido a una falla mecánica de cualquiera de nuestros refrigeradores o congeladores cubiertos por este acuerdo.
- ☑ **Devolución de gastos de alquiler de electrodomésticos** si la reparación de su producto asegurado toma más que el tiempo prometido.
- ☑ **25% de descuento** aplicable tanto a los costos del servicio de reparación, como de las piezas instaladas relacionadas que no hayan quedado cubiertos por este acuerdo.

Una vez que haya realizado el pago de este acuerdo, bastará una simple llamada telefónica para concertar una visita de servicio. Puede llamar a cualquier hora del día o de la noche, o bien concertar una visita de servicio por Internet.

La adquisición del Acuerdo maestro de protección es una inversión exenta de riesgos. Si por cualquier motivo decide cancelar dicho acuerdo durante el periodo de garantía del producto, le haremos un reintegro total del valor. O bien un importe proporcional si cancela el acuerdo en cualquier otro momento posterior al vencimiento del periodo de garantía del producto. ¡Adquiera hoy mismo su Acuerdo maestro de protección!

**Algunas limitaciones y exclusiones podrían aplicarse. Para solicitar precios e información adicional, llame al 1-800-827-6655 (en los EE.UU.).**

**\* La cobertura en Canadá varía en el caso de algunos artículos. Para obtener detalles completos al respecto, llame al 1-800-361-6665 de Sears de Canadá.**

## Servicio de instalación de Sears

*Para solicitar la instalación por profesionales de Sears* de electrodomésticos, abridores de puertas de garaje, calentadores de agua y otros artículos de uso prioritario en el hogar, **llame al 1-800-4-MY-HOME** en los EE.UU. o Canadá.



# Get it fixed, at your home or ours!

## Your Home

For troubleshooting, product manuals and expert advice:



[www.managemylife.com](http://www.managemylife.com)

---

For repair – **in your home** – of **all** major brand appliances, lawn and garden equipment, or heating and cooling systems, **no matter who made it, no matter who sold it!**

For the replacement parts, accessories and owner's manuals that you need to do-it-yourself.

For Sears professional installation of home appliances and items like garage door openers and water heaters.

**1-800-4-MY-HOME<sup>®</sup>** (1-800-469-4663)

Call anytime, day or night (U.S.A. and Canada)

[www.sears.com](http://www.sears.com)    [www.sears.ca](http://www.sears.ca)

---

## Our Home

For repair of carry-in items like vacuums, lawn equipment, and electronics, call anytime for the location of your nearest

**Sears Parts & Repair Service Center**

**1-800-488-1222** (U.S.A.)

[www.sears.com](http://www.sears.com)

**1-800-469-4663** (Canada)

[www.sears.ca](http://www.sears.ca)

---

To purchase a protection agreement on a product serviced by Sears:

**1-800-827-6655** (U.S.A.)

**1-800-361-6665** (Canada)

---

Para pedir servicio de reparación a domicilio, y para ordenar piezas:

**1-888-SU-HOGAR<sup>®</sup>**

(1-888-784-6427)

[www.sears.com](http://www.sears.com)

Au Canada pour service en français:

**1-800-LE-FOYER<sup>MC</sup>**

(1-800-533-6937)

[www.sears.ca](http://www.sears.ca)

sears

® Registered Trademark / <sup>TM</sup> Trademark of KCD IP, LLC in the United States, or Sears Brands, LLC in other countries

® Marca Registrada / <sup>TM</sup> Marca de Fábrica de KCD IP, LLC en Estados Unidos, o Sears Brands, LLC in otros países

<sup>MC</sup> Marque de commerce / <sup>MD</sup> Marque déposée de Sears Brands, LLC