

Use & Care Guide
Manual de uso y cuidado
Guide d'utilisation et d'entretien

English / Español / Français

Table of Contents...2 / Índice...20 / Table des matières...40



Designed to use only HE High Efficiency detergents.

Diseñada para utilizar solamente detergentes de alto rendimiento (HE).

Conçue pour l'utilisation d'un détergent haute efficacité seulement.

Models/Modelos/Modèles: 110.2813*410, 110.2913*410

Kenmore®

Top-Loading High Efficiency Low-Water Washer

Lavadora de carga superior, de alto rendimiento y con nivel bajo de agua

Laveuse haute efficacité à faible consommation d'eau avec chargement par le dessus

* = color number, número de color, numéro de la couleur

P/N W10682720C

Sears Brands Management Corporation
Hoffman Estates, IL 60179 U.S.A.
www.kenmore.com

Sears Canada Inc.
Toronto, Ontario, Canada M5B 2C3
www.sears.ca



TABLE OF CONTENTS

WASHER SAFETY	2	WASHER MAINTENANCE	12
WHAT'S NEW UNDER THE LID?	3	TROUBLESHOOTING	14
CONTROL PANEL AND FEATURES	4	PROTECTION AGREEMENTS	19
Dispensers.....	6	WARRANTY.....	19
CYCLE GUIDE	7	ASSISTANCE OR SERVICE.....	Back Cover
USING YOUR WASHER	9		
Using Laundry Product Dispensers.....	10		

WASHER SAFETY

Your safety and the safety of others are very important.

We have provided many important safety messages in this manual and on your appliance. Always read and obey all safety messages.



This is the safety alert symbol.

This symbol alerts you to potential hazards that can kill or hurt you and others.

All safety messages will follow the safety alert symbol and either the word "DANGER" or "WARNING."

These words mean:

⚠ DANGER

You can be killed or seriously injured if you don't immediately follow instructions.

⚠ WARNING

You can be killed or seriously injured if you don't follow instructions.

All safety messages will tell you what the potential hazard is, tell you how to reduce the chance of injury, and tell you what can happen if the instructions are not followed.

IMPORTANT SAFETY INSTRUCTIONS

WARNING: To reduce the risk of fire, electric shock, or injury to persons when using the washer, follow basic precautions, including the following:

- Read all instructions before using the washer.
- Do not wash articles that have been previously cleaned in, washed in, soaked in, or spotted with gasoline, dry-cleaning solvents, other flammable, or explosive substances as they give off vapors that could ignite or explode.
- Do not add gasoline, dry-cleaning solvents, or other flammable, or explosive substances to the wash water. These substances give off vapors that could ignite or explode.
- Under certain conditions, hydrogen gas may be produced in a hot water system that has not been used for 2 weeks or more. **HYDROGEN GAS IS EXPLOSIVE.** If the hot water system has not been used for such a period, before using the washing machine, turn on all hot water faucets and let the water flow from each for several minutes. This will release any accumulated hydrogen gas. As the gas is flammable, do not smoke or use an open flame during this time.
- Do not allow children to play on or in the washer. Close supervision of children is necessary when the washer is used near children.
- Before the washer is removed from service or discarded, remove the door or lid.
- Do not reach into the washer if the drum, tub or agitator is moving.
- Do not install or store the washer where it will be exposed to the weather.
- Do not tamper with controls.
- Do not repair or replace any part of the washer or attempt any servicing unless specifically recommended in this manual or in published user-repair instructions that you understand and have the skills to carry out.
- See "Electrical Requirements" located in the installation instructions for grounding instructions.

SAVE THESE INSTRUCTIONS

State of California Proposition 65 Warnings:

WARNING: This product contains one or more chemicals known to the State of California to cause cancer.

WARNING: This product contains one or more chemicals known to the State of California to cause birth defects or other reproductive harm.

WHAT'S NEW UNDER THE LID?

Cleaning with Less Water

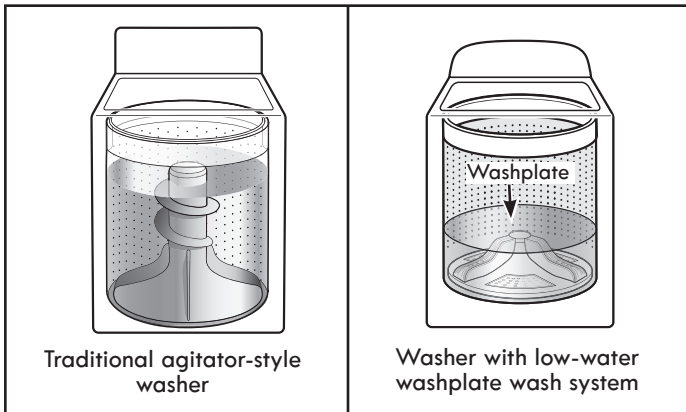

The most striking difference in your new washer is the low-water washplate wash system. The washer automatically adjusts the water level to the load size—no water level selector is needed.

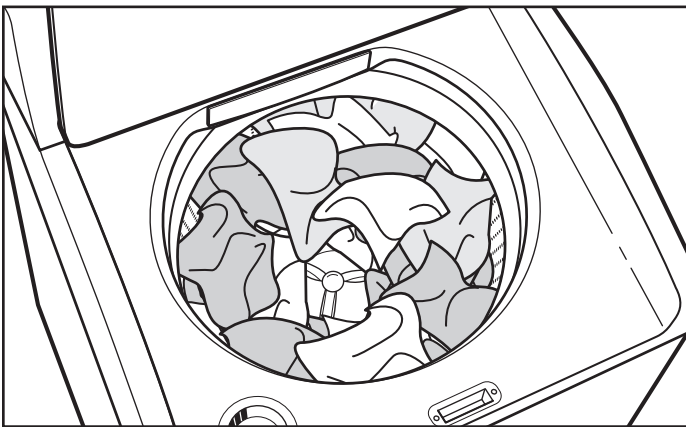

For best performance, it is recommended to load items in loose heaps evenly around the washplate.

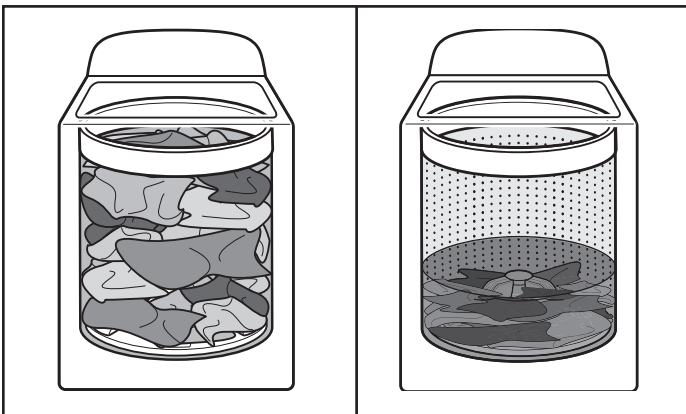

As the washer dampens and moves the load, the level of the items will settle in the basket. This is normal and does not indicate that more items should be added.

IMPORTANT: You will not see a washer basket full of water as with your past agitator-style washer. It is normal for some of the load to be above the water line.

Automatic Load Size Sensing

Once you start the cycle, the lid will lock, and the washer will begin the sensing process to determine the correct water level for the load. This may take several minutes before water is added. You will find a step-by-step description in the “Cycle Status Lights” section.

Initially the basket will start to spin prior to adding water; this is part of the sensing process and is normal. This low-water wash method uses less water and energy compared to a traditional agitator-style washer.

Choosing the Right Detergent

Use only High Efficiency detergents. The package will be marked “HE” or “High Efficiency.” Low-water washing creates excessive sudsing with a non-HE detergent. Using non-HE detergent will likely result in longer cycle times and reduced rinsing performance. It may also result in component malfunction and, over time, buildup of mold or mildew. HE detergents should be low-sudsing and quick-dispersing to produce the right amount of suds for the best performance. They should hold soil in suspension so it is not redeposited onto clean clothes. Not all detergents labeled as High Efficiency are identical in formulation and their ability to reduce suds. For example, natural, organic, or homemade HE detergents may generate a high level of suds. If you use one of these and see an “FOE2” error code appear in the display, consider using a different HE detergent. Always follow the detergent manufacturer’s instructions to determine the amount of detergent to use. Do not go over the Max line on the dispenser. See “Using Laundry Product Dispensers” for more information.



Use only High Efficiency (HE) detergent.

Improved Cleaning

Low-water cleaning means concentrated cleaning. Rather than diluting detergent as done in an agitator-style washer, this washer delivers the detergent directly to the soils. This low water wash also allows the clothing to move in a more effective way to remove soils.

Normal Sounds You Can Expect

At different stages of the wash cycle, you may hear sounds and noises that are different from those of your previous washer. For example, you may hear a clicking and hum at the beginning of the cycle, as the lid lock goes through a self-test. There will be different kinds of humming and whirring sounds as the washplate moves the load and as basket is slowing down to stop. And sometimes, you may hear nothing at all, as the washer determines the correct water level for your load or allows time for clothes to soak.

CONTROL PANEL AND FEATURES

STEAM MODEL

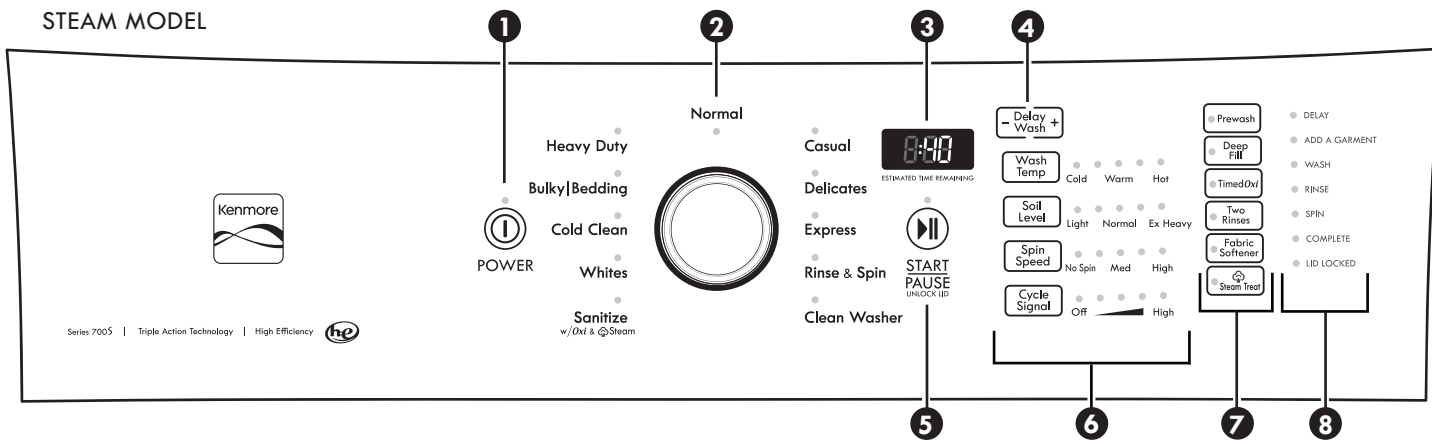

NON-STEAM MODEL

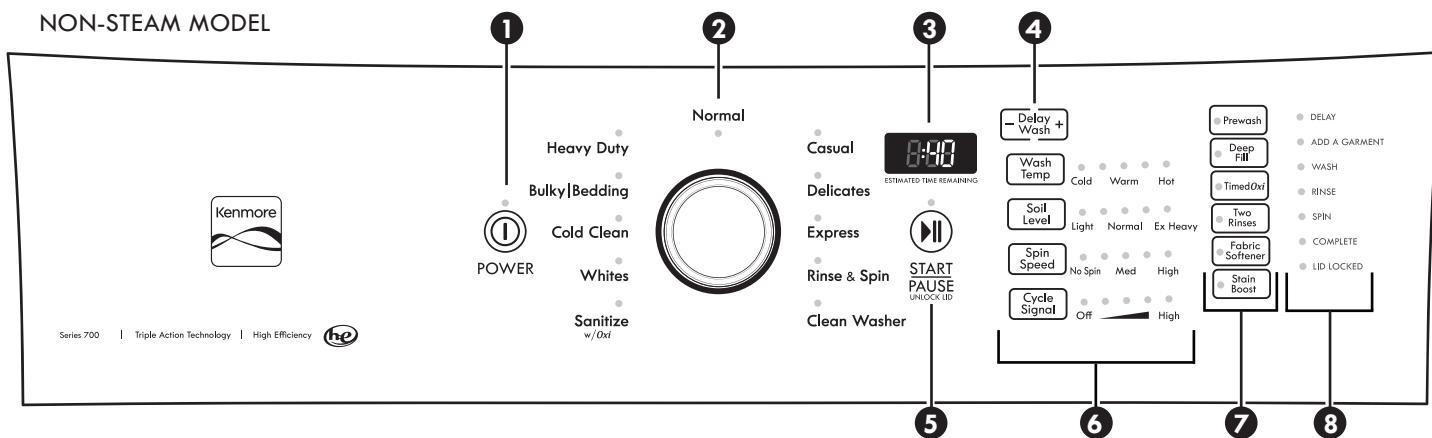

Not all features and cycles are available on all models.

NOTE: The control panel features a sensitive surface that responds to a light touch of your finger. To ensure your selections are registered, touch the control panel with your fingertip, not your fingernail. When selecting a setting or option, simply touch its name until the desired section is illuminated.

1 POWER BUTTON

Touch to turn on the washer. Touch to stop/cancel a cycle at any time.

2 WASH CYCLE KNOB

Turn the Wash Cycle knob to select a cycle for your laundry load. See “Cycle Guide” for detailed descriptions of cycles.

3 TIME DISPLAY

The Estimated Time Remaining display shows the time required for the cycle to complete. Factors such as load size and water pressure may affect the time shown in the display. Overloading, unbalanced loads, or excessive suds may cause the washer to adjust the cycle time as well.

4 DELAY WASH

Use “+” and “-” to delay the start of the wash cycle by up to 12 hours. To turn off Delay Wash, use “+” and “-” to set the delay time to “0,” or touch POWER.

5 START/PAUSE/UNLOCK LID BUTTON

Touch and hold START/PAUSE button for up to 3 seconds or until the washer starts the selected cycle; touch again to pause a cycle.

NOTE: If the washer is spinning, it may take several minutes to unlock the lid.

6 CYCLE MODIFIERS

When you select a cycle, its default settings will light up.

WASH TEMP

Wash Temp control senses and maintains uniform water temperatures by regulating incoming hot and cold water.

Select a wash temperature based on the type of fabric and soils being washed. For best results and following the garment label instructions, use the warmest wash water safe for your fabric.

- On some models and cycles, warm and hot water may be cooler than what your previous washer provided.
- Even for cold wash settings, some warm water may be added to the washer to maintain a minimum temperature.

SOIL LEVEL

Select the most suitable setting for your load. For heavily soiled items, select Ex Heavy Soil Level for more wash time. For lightly soiled items, select Light Soil Level for less wash time.

Lighter soil level setting will help reduce tangling and wrinkling.

SPIN SPEED

This washer automatically selects the spin speed based on the cycle selected. The preset speeds can be changed. Not all spin speeds are available with all cycles.

- Faster spin speeds mean shorter dry times, but may increase wrinkling in your load.
- Slower spin speeds mean less wrinkling but will leave your load more damp.

CYCLE SIGNAL

Use this option to adjust volume of the signal that sounds at end of cycle. The Cycle Signal is a helpful reminder to remove items from washer as soon as the cycle has completed.

To turn Button Sounds either On or Off:

While washer is on, touch and hold Cycle Signal for 3 seconds. Washer will make a single beep when the process is complete.

NOTE:

- Cycle Signal button will still operate, even if you turned the button sounds off.
- Whatever your preferences are, they remain in effect through a power loss.
- The Default setting for button sounds is ON.

7 CYCLE OPTIONS

You may add or remove options for each cycle. Note that not all options can be used with all cycles, and some are preset to work with certain cycles.

PREWASH

Use this option to add an extra agitation and soak time to the beginning of any cycle to break up tough stains.

DEEP FILL

Will add the most amount of water for large or bulky loads. Items need to move freely. Tightly packing the load can lead to poor cleaning performance, and may increase wrinkling and tangling.

TimedOxi

This washer is designed to dispense laundry boosters such as oxygenated stain treaters and color-safe bleach at the right time in the cycle for best cleaning performance. Do not use laundry boosters and chlorine bleach in the same cycle.

TWO RINSES

This option can be used to automatically add a second rinse to most cycles.

NOTE: If you want to Drain and Spin only, select the Rinse & Spin cycle; then touch to turn off the Two Rinses option.

FABRIC SOFTENER

This option must be set to ON if using fabric softener. It ensures that fabric softener is added at the correct time in the rinse for even distribution.

STAIN TREAT for Steam models or STAIN BOOST for Non-Steam models

This option provides enhanced cleaning action for tough stains. It will add additional agitation and soak time to the cycle.

8 CYCLE STATUS LIGHTS INDICATOR

The Cycle Status Lights show the progress of a cycle. At each stage of the process, you may notice sounds or pauses that are different from traditional washers.

DELAY

When the Delay Wash is selected, this light will come on to indicate your washer is set-up to run a delayed wash.

ADD A GARMENT

You may place additional clothing in the wash when the Add a Garment indicator is lit without sacrificing wash performance. Touch START/PAUSE once. The Lid Locked light will turn off. Open the washer lid, add garments, and close the lid. Touch and hold START/PAUSE to restart.

WASH

You will hear the motor and washplate moving the load. It is normal for some of the load to be above the water line. Low-water cleaning means concentrated cleaning. Rather than diluting detergent as done in an agitator-style washer, this washer delivers the detergent directly to the soils. The motor sounds may change at different stages in the cycle. The wash time is determined by the selected Soil Level.

RINSE

You will hear sounds similar to the wash cycle as the washer rinses and moves the load. Fabric softener will be added if the Fabric Softener option was selected.

SPIN

The washer spins the load at increasing speeds for proper water removal, based on the selected cycle and spin speed.

COMPLETE

Once the cycle is complete, this light will come on. Remove the load promptly for best results.

LID LOCKED

To allow for proper load sensing and spinning, the lid will lock and the Lid Locked light will turn on. This light indicates that the lid is locked and cannot be opened.

If you need to open the lid, touch START/PAUSE/Unlock Lid. The lid will unlock once the washer movement has stopped. This may take several minutes if the load was spinning at high speed. Touch and hold START/PAUSE/Unlock Lid again for up to 3 seconds to resume the cycle.

Dispensers

A Liquid fabric softener dispenser

Pour measured liquid fabric softener into the liquid fabric softener dispenser, if desired. It will dispense automatically at the optimum time.

- Use only liquid fabric softener in this dispenser.

B High Efficiency “HE” detergent dispenser

Add liquid or powdered HE detergent product to this dispenser for your main wash cycle. Remove tray if using powder detergent.

IMPORTANT: Make sure tray is in drawer when using liquid detergent and removed when using powder detergent and do not go over the Max line.



Use only High Efficiency (HE) detergent.

NOTE: Follow the manufacturer’s instructions to determine the amount of detergent to use. Do not add single-dose laundry packets, color-safe bleach, or fabric softener crystals to dispensers. They will not dispense correctly.

C Oxi dispenser

This dispenser holds up to $\frac{3}{4}$ cup (180 mL) Oxi booster or other laundry booster, such as powdered or liquid color-safe bleach. Laundry boosters are automatically dispensed at the proper time during the wash cycle. Be sure to select Oxi from the options to ensure proper dispensing.

NOTE: Fill dispenser with only oxi. Do not mix with bleach.

D Liquid chlorine bleach dispenser

This dispenser holds up to $\frac{3}{4}$ cup (180 mL) liquid chlorine bleach. The bleach will be automatically diluted and dispensed at the optimum time during the wash cycle. This dispenser cannot dilute powdered bleach.

NOTE: Fill dispenser with only liquid bleach.

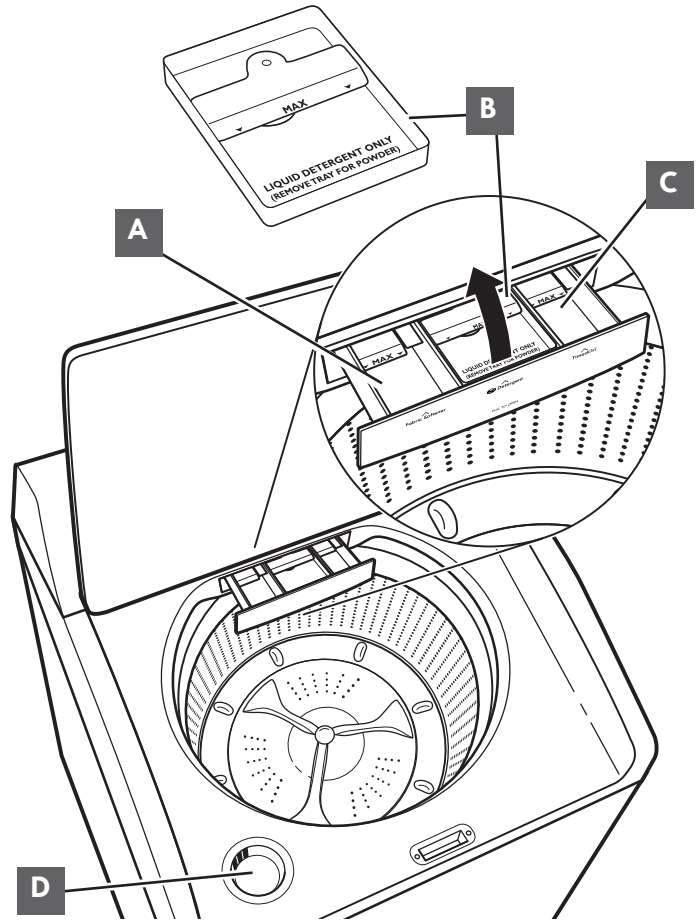

CYCLE GUIDE

Settings shown are default settings for that cycle. Once you select a cycle, the default modifiers or the previous set modifiers for that cycle will be lit. For best fabric care, choose the cycle that best fits the load being washed. Not all cycles and options are available on all models.

Items to Wash:	Cycle:	Wash Temp:*	Soil Level:	Spin Speed:	Available Options:	Cycle Details:
Cottons, linens, and mixed item loads	Normal	<input type="radio"/> Cold <input checked="" type="radio"/> Warm <input type="radio"/> Hot	<input type="radio"/> Light <input checked="" type="radio"/> Normal <input type="radio"/> Ex Heavy	<input type="radio"/> No Spin <input type="radio"/> Med <input checked="" type="radio"/> High	Prewash TimedOxi Two Rinses Fabric Softener Stain Treat or Stain Boost	Use this cycle to clean normally soiled cottons and mixed fabric loads. Default settings can be adjusted as needed.
No-iron fabrics, cottons, perm press, linens, synthetics	Casual	<input type="radio"/> Cold <input checked="" type="radio"/> Warm <input type="radio"/> Hot	<input type="radio"/> Light <input checked="" type="radio"/> Normal <input type="radio"/> Ex Heavy	<input type="radio"/> No Spin <input checked="" type="radio"/> Med <input type="radio"/> High	Prewash TimedOxi Two Rinses Fabric Softener Stain Treat or Stain Boost	Use this cycle for no-iron fabrics such as sport shirts, blouses, casual business clothes, permanent press, and blends. The cycle uses a warm wash, a cool down, and medium spin speeds for better wrinkle performance.
Machine-wash silks, hand-wash fabrics, and wool	Delicates	<input type="radio"/> Cold <input checked="" type="radio"/> Warm <input type="radio"/> Hot	<input checked="" type="radio"/> Light <input type="radio"/> Normal <input type="radio"/> Ex Heavy	<input type="radio"/> No Spin <input checked="" type="radio"/> Med <input type="radio"/> High	Prewash TimedOxi Two Rinses Fabric Softener Stain Treat or Stain Boost	Use this cycle for machine-washable delicate items. This cycle uses intermittent wash action with cool water and slow spin to gently care for fine washables and avoid shrinkage. Place small items in mesh bags before washing.
Lightly soiled items	Express	<input type="radio"/> Cold <input checked="" type="radio"/> Warm <input type="radio"/> Hot	<input checked="" type="radio"/> Light <input type="radio"/> Normal <input type="radio"/> Ex Heavy	<input type="radio"/> No Spin <input type="radio"/> Med <input checked="" type="radio"/> High	Prewash TimedOxi Two Rinses Fabric Softener Stain Treat or Stain Boost	Use this cycle to wash a few lightly soiled items that are needed in a hurry. This short cycle combines high-speed wash action and high-speed spin for best cleaning and shortened dry time.
Heavily soiled, colorfast fabrics	Sanitize w/Oxi & Steam or Sanitize w/Oxi (depending on model)	<input type="radio"/> Cold <input type="radio"/> Warm <input checked="" type="radio"/> Hot	<input type="radio"/> Light <input type="radio"/> Normal <input checked="" type="radio"/> Ex Heavy	<input type="radio"/> No Spin <input type="radio"/> Med <input checked="" type="radio"/> High	Prewash TimedOxi Two Rinses Fabric Softener Stain Treat or Stain Boost	Use this cycle to eliminate 99.9% of bacteria when used in conjunction with the Oxi option. Preset cycle setting must be used to achieve the proper sanitization. Be sure to add an Oxi product to the Oxi dispenser.
Heavily soiled white fabrics	Whites	<input type="radio"/> Cold <input type="radio"/> Warm <input checked="" type="radio"/> Hot	<input type="radio"/> Light <input type="radio"/> Normal <input checked="" type="radio"/> Ex Heavy	<input type="radio"/> No Spin <input type="radio"/> Med <input checked="" type="radio"/> High	Prewash Deep Fill TimedOxi Two Rinses Fabric Softener Stain Treat or Stain Boost	This cycle adds liquid chlorine bleach to the load at the proper time for improved whitening of soiled white fabrics.
Bright or darkly colored cottons, linens, casual and mixed loads	Cold Clean	<input checked="" type="radio"/> Cold <input type="radio"/> Warm <input type="radio"/> Hot	<input type="radio"/> Light <input type="radio"/> Normal <input checked="" type="radio"/> Ex Heavy	<input type="radio"/> No Spin <input type="radio"/> Med <input checked="" type="radio"/> High	Prewash Deep Fill TimedOxi Two Rinses Fabric Softener Stain Treat or Stain Boost	Cold water with an additional wash action gently lifts stains while caring for fabrics. Settings may be adjusted as desired, but must use only cold water settings.

* Wash temperatures vary according to the chosen cycle setting. All rinses are cold.

CYCLE GUIDE

Settings shown are default settings for that cycle. Once you select a cycle, the default modifiers or the previous set modifiers for that cycle will be lit. For best fabric care, choose the cycle that best fits the load being washed. Not all cycles and options are available on all models.

Items to Wash:	Cycle:	Wash Temp:*	Soil Level:	Spin Speed:	Available Options:	Cycle Details:
Large items such as sheets, sleeping bags, small comforters, jackets, small washable rugs	Bulky/Bedding	○ ○ ● ○ ○ Cold Warm Hot	○ ○ ● ○ ○ Light Normal Ex Heavy	○ ○ ● ○ ○ No Spin Med High	Prewash Deep Fill TimedOxi Two Rinses Fabric Softener Stain Treat or Stain Boost	Use this cycle to wash large items such as jackets and small comforters. The washer will fill with enough water to wet down the load before the wash portion of the cycle begins, and uses a higher water level than other cycles.
Sturdy fabrics, colorfast items	Heavy Duty	○ ○ ○ ● ○ Cold Warm Hot	○ ○ ○ ○ ● Light Normal Ex Heavy	○ ○ ○ ○ ● No Spin Med High	Prewash Deep Fill TimedOxi Two Rinses Fabric Softener Stain Treat or Stain Boost	Use this cycle for heavily soiled or sturdy cotton items. This cycle combines high-speed wash action, longer wash time, and extra high-speed spin to shorten drying times. Adjust temperature settings as needed.
Swimsuits, items that need rinsing only	Rinse & Spin	N/A	N/A	○ ○ ● ○ ○ No Spin Med High	Two Rinses	Combines a rinse and high speed spin for loads requiring an additional rinse cycle or to complete a load after power interruption. Also use for loads that require rinsing only. If you want to Drain & Spin only, select the Rinse & Spin cycle; then touch to turn off the Two Rinses option. Use Drain & Spin to spin excess water out of a load.
No clothes in washer	Clean Washer	N/A	N/A	N/A	N/A	Use this cycle every 30 washes to keep the inside of your washer fresh and clean. This cycle uses a higher water level. Use with liquid chlorine bleach to thoroughly clean the inside of your washer. This cycle should not be interrupted. See "Washer Care." IMPORTANT: Do not place garments or other items in the washer during the Clean Washer cycle. Use this cycle with an empty wash tub.

* Wash temperatures vary according to the chosen cycle setting. All rinses are cold.

USING YOUR WASHER

⚠ WARNING



Fire Hazard

Never place items in the washer that are dampened with gasoline or other flammable fluids.

No washer can completely remove oil.

Do not dry anything that has ever had any type of oil on it (including cooking oils).

Doing so can result in death, explosion, or fire.

⚠ WARNING



Electrical Shock Hazard

Plug into a grounded 3 prong outlet.

Do not remove ground prong.

Do not use an adapter.

Do not use an extension cord.

Failure to follow these instructions can result in death, fire, or electrical shock.

1. Sort and prepare your laundry

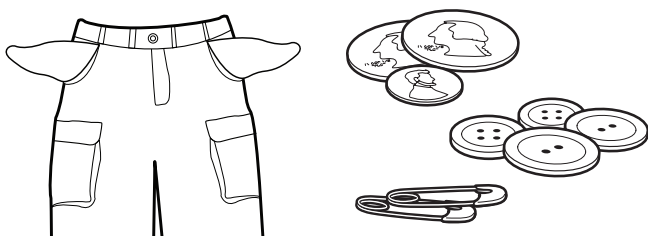

- Empty pockets. Loose change, buttons, or any small object can pass under the washplate and become trapped, causing unexpected sounds.
- Sort items by recommended cycle, water temperature, and colorfastness.
- Separate heavily soiled items from lightly soiled.
- Separate delicate items from sturdy fabrics.
- Do not dry items if stains remain after washing; heat can set stains into fabric.
- Treat stains promptly.
- Close zippers, fasten hooks, tie strings and sashes. Remove non-washable trim and ornaments.
- Mend rips and tears to avoid further damage to items during washing.

Helpful Tips:

- For best performance, use HE liquid detergent when washing bulky items.
- When washing waterproof or water-resistant items, load evenly. See "Cycle Guide" for tips and more information on using the Bulky/Bedding cycle.
- Use mesh bags to help prevent tangling when washing delicate or small items.
- Turn knits inside out to avoid pilling. Separate lint-takers from lint-givers. Synthetics, knits, and corduroy fabrics will pick up lint from towels, rugs, and chenille fabrics.

NOTE: Always read and follow fabric care labels instructions to avoid damage to your items.

2. Add laundry products, if desired

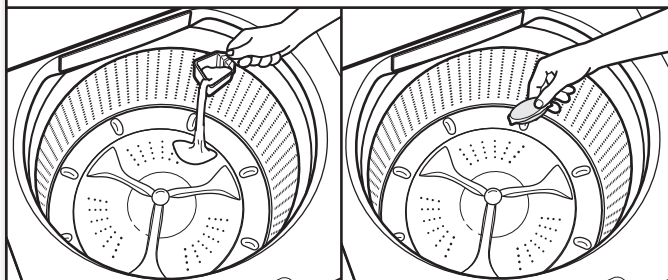

Single-dose laundry packet, color-safe bleach, or fabric softener crystals can be added to the basket prior to adding laundry.

NOTE: Do not add clothes to washer basket prior to adding laundry products. Always follow manufacturer's instructions.

3. Load laundry into washer

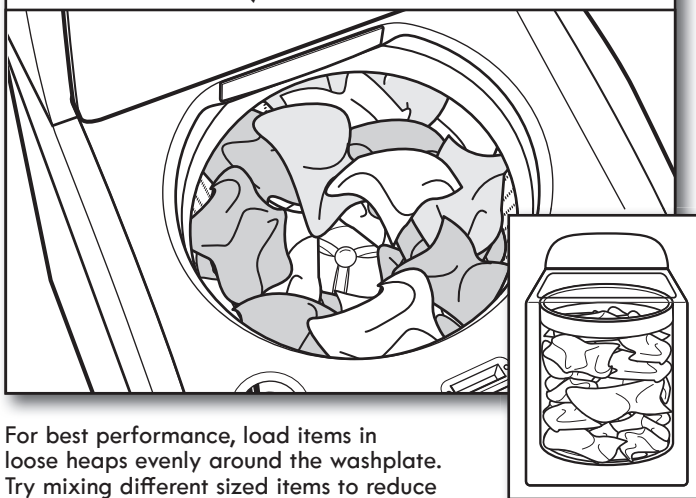

For best performance, load items in loose heaps evenly around the washplate. Try mixing different sized items to reduce tangling.

IMPORTANT: Items need to move freely for best cleaning and to reduce wrinkling and tangling.

Using Laundry Product Dispensers

NOTE: Do not add single-dose laundry packets, color-safe bleach, or fabric softener crystals to dispensers. They will not dispense correctly.

4. Add HE detergent

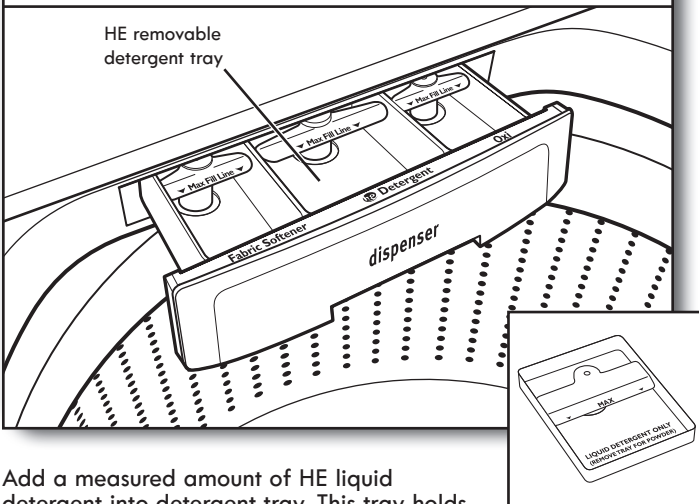

Add a measured amount of HE liquid detergent into detergent tray. This tray holds 3 oz. (89 mL). If adding powder HE detergent, remove inside tray. Do not overfill tray – adding too much detergent may cause detergent to be dispensed into the washer too early.

NOTE: Make sure tray is in drawer when using liquid detergent and removed when using powder detergent. Do not go over the Max line.

IMPORTANT: Use only High Efficiency detergents. The package will be marked “HE” or “High Efficiency.” Low-water washing creates excessive sudsing with a regular non-HE detergent. Using regular detergent will likely result in longer cycle times and reduced rinsing performance. It may also result in component failures and noticeable mold or mildew. HE detergents are made to produce the right amount of suds for the best performance. Follow the manufacturer’s instructions to determine the amount of detergent to use.

HELPFUL TIP: See “Washer Maintenance” for information on the recommended method of cleaning washer dispenser trays.

5. Add liquid chlorine bleach to dispenser

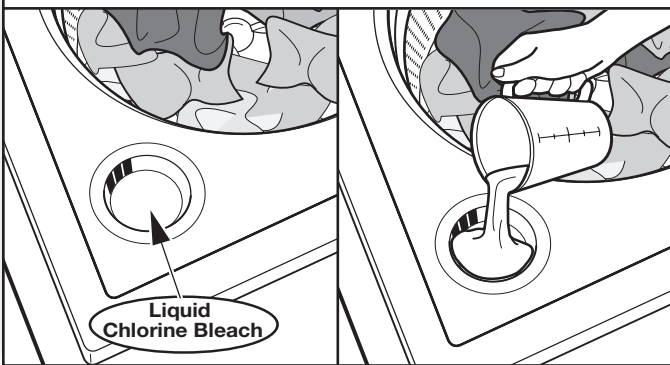

Do not overfill, dilute, or use more than 1 cup (236 mL). Do not use color-safe bleach or Oxi products in the same cycle with liquid chlorine bleach.

6. Add liquid fabric softener or Oxi to dispenser

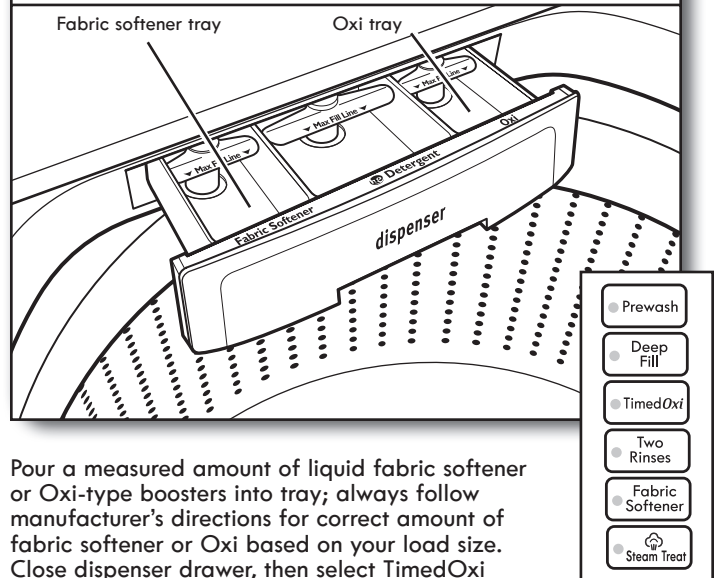

Pour a measured amount of liquid fabric softener or Oxi-type boosters into tray; always follow manufacturer’s directions for correct amount of fabric softener or Oxi based on your load size. Close dispenser drawer, then select TimedOxi and/or Fabric Softener option. Oxi is added during main wash and Fabric Softener is added during rinse.

IMPORTANT: TimedOxi and/or Fabric Softener option must be selected to ensure proper distribution at correct time in cycle. Do not overfill or dilute. Overfilling dispenser will cause fabric softener to immediately dispense into washer.

If Two Rinses option is selected, fabric softener will be dispensed into the last rinse.

It is normal for a small amount of water to remain in the dispenser at the end of a cycle.

7. Touch POWER to turn on washer



Make sure the dispenser drawer is closed completely, then touch POWER to turn on the washer. Other methods of turning the washer on include opening the lid or turning the cycle selection knob.

8. Select cycle

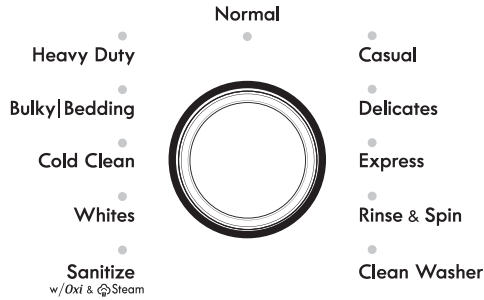

Steam model shown

Turn cycle knob to choose your wash cycle.

9. Select cycle modifiers, if desired

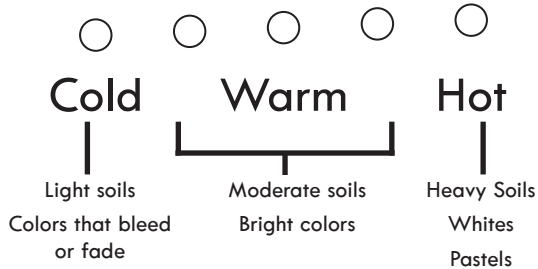
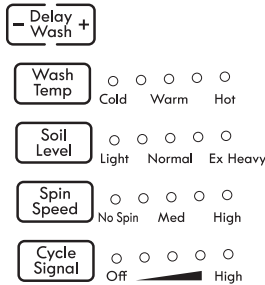

Once you select a cycle, the default settings for that cycle will be lit. Touch the cycle modifier buttons to change the Wash Temp, Soil Level, and Spin Speed, if desired. Not all settings are available with all cycles. Even for cold wash settings, some warm water may be added to the washer to maintain a minimum temperature.

NOTE: Always read and follow fabric care label instructions to avoid damage to your items. If not sure which temperature to use, refer to the diagram above or select a cooler temperature.

10. Select cycle options



Steam model shown

Select any other cycle options you may wish to add, if not previously set. Some cycles will automatically add certain options such as Two Rinses. These may be turned off, if desired.

NOTE: Not all options are available with all cycles.

11. Touch and hold START/PAUSE/Unlock Lid to begin wash cycle



Touch and hold START/PAUSE/Unlock Lid button for up to 3 seconds to start the wash cycle. When the cycle has finished, the COMPLETE indicator will light and the end of cycle signal will sound (if set). Promptly remove items when cycle is done to avoid odor, reduce wrinkling, and avoid rusting of metal hooks, zippers, and snaps.

Unlocking the lid to add garments

If you need to open the lid to add 1 or 2 missed items:

Touch START/PAUSE/Unlock Lid to pause washer; the lid will unlock once the washer movement has stopped. This may take several minutes if the load was spinning at high speed. Then close lid and touch and hold START/PAUSE/Unlock Lid again for up to 3 seconds to restart the cycle.

IMPORTANT: If lid is left open for more than 10 minutes, the water will pump out and F8E6 error code will appear on the display.

WASHER MAINTENANCE

WATER INLET HOSES

Replace inlet hoses after 5 years of use to reduce the risk of hose failure. Periodically inspect and replace inlet hoses if bulges, kinks, cuts, wear, or leaks are found.

When replacing your inlet hoses, mark the date of replacement on the label with a permanent marker.

NOTE: This washer does not include inlet hoses. See the Installation Instructions for more information.

WASHER CARE

Recommendations to Help Keep Your Washer Clean and Performing at its Best

1. Always use High Efficiency (HE) detergents and follow the HE detergent manufacturer's instructions regarding the amount of HE detergent to use. Never use more than the recommended amount because that may increase the rate at which detergent and soil residue accumulate inside your washer, which in turn may result in undesirable odor.
2. Use warm and hot wash water settings sometimes (not exclusively cold water washes), because they do a better job of controlling the rate at which soils and detergent accumulate.
3. Always leave the washer lid open between uses to help dry out the washer and prevent the buildup of odor-causing residue.

Cleaning Your Top Loading Washer

Read these instructions completely before beginning the routine cleaning processes recommended below. This Washer Maintenance Procedure should be performed, at a minimum, once per month or every 30 wash cycles, whichever occurs sooner, to control the rate at which soils and detergent may otherwise accumulate in your washer.

Cleaning the Inside of the Washer

To keep your washer odor-free, follow the usage instructions provided above, and use this recommended monthly cleaning procedure:

Clean Washer Cycle

This washer has a special cycle that uses higher water volumes in combination with liquid chlorine bleach to clean the inside of the washer.

Begin procedure

1. Chlorine Bleach Procedure:

- a. Open the washer lid and remove any clothing or items.
- b. Add 1 cup (236 mL) of liquid chlorine bleach to the bleach compartment.

NOTE: Use of more liquid chlorine bleach than is recommended above could cause washer damage over time.

- c. Close the washer lid.
- d. Do not add any detergent or other chemical to the washer when following this procedure.
- e. Select the CLEAN WASHER cycle.

WASHER CARE (cont.)

- f. Touch and hold the START/PAUSE/Unlock button to begin the cycle. The Clean Washer Cycle Operation is described below.

NOTE: For best results, do not interrupt cycle. If cycle must be interrupted, touch POWER/CANCEL. (For models with no Power/Cancel button, touch and hold START/PAUSE/Unlock for three seconds). After the Clean Washer cycle has stopped, run a Rinse & Spin cycle to rinse cleaner from washer.

Description of Clean Washer Cycle Operation:

1. This cycle will fill to a water level higher than in normal wash cycles to provide rinsing at a level above the water line for normal wash cycle.
2. During this cycle, there will be some agitation and spinning to increase the removal of soils.

After this cycle is complete, leave the lid open to allow for better ventilation and drying of the washer interior.

Cleaning the Dispensers

After a period of using your washer, you may find some residue buildup in the washer's dispensers. To remove residue from the dispensers, wipe them with a damp cloth and towel dry. Do not attempt to remove the dispensers or trim for cleaning. The dispensers and trim are not removable. If your model has a dispenser drawer, however, remove the drawer and clean it before or after you run the Clean Washer cycle. Use an all-purpose surface cleaner, if needed.

Cleaning the Outside of the Washer

Use a soft, damp cloth or sponge to wipe away any spills. Use only mild soaps or cleaners when cleaning external washer surfaces.

IMPORTANT: To avoid damaging the washer's finish, do not use abrasive products.

NON-USE AND VACATION CARE

Operate your washer only when you are home. If moving, or not using your washer for a period of time, follow these steps:

1. Unplug or disconnect power to washer.
2. Turn off water supply to washer, to avoid flooding due to water pressure surge.

CLEANING YOUR DISPENSER

You may find laundry product residue leftover in your dispenser drawer. To remove residue, follow this recommended cleaning procedure:

1. Pull drawer out until you feel resistance.
2. Push 2 tabs downward, and then continue pulling out.
3. Wash in warm, soapy water, using a mild detergent.
4. Rinse with warm water.
5. Air dry, or dry with a towel, then place back into slot.

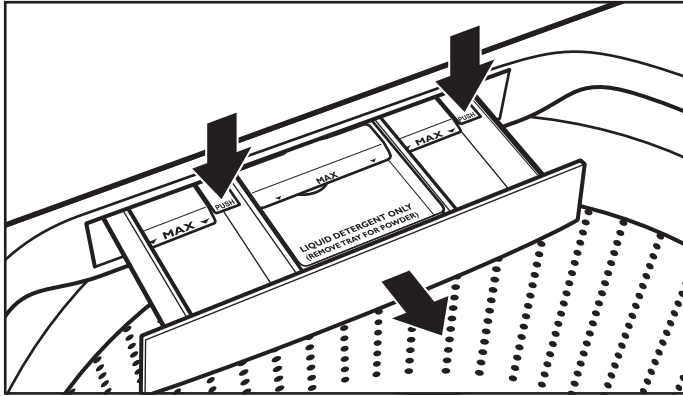

IMPORTANT: Dispenser drawer and tray are not dishwasher safe.

WINTER STORAGE CARE

IMPORTANT: To avoid damage, install and store washer where it will not freeze. Because some water may stay in hoses, freezing can damage washer. If storing or moving during freezing weather, winterize your washer.

To winterize washer:

1. Shut off both water faucets; disconnect and drain water inlet hoses.
2. Put 1 qt. (1 L) of R.V.-type antifreeze in basket and run washer on RINSE & SPIN cycle for about 30 seconds to mix antifreeze and remaining water.
3. Unplug washer or disconnect power.

TRANSPORTING YOUR WASHER

1. Shut off both water faucets. Disconnect and drain water inlet hoses.
2. If washer will be moved during freezing weather, follow WINTER STORAGE CARE directions before moving.
3. Disconnect drain hose from drain system.
4. Unplug power cord.
5. Place inlet hoses inside washer basket.
6. Drape power cord and drain hose over the console and secure with masking tape.
7. Place foam packing ring from original shipping materials back inside washer. If you do not have packing ring, place heavy blankets or towels into basket opening. Close lid and place tape over lid and down front of washer. Keep lid taped until washer is placed in new location. Transport washer in upright position.

REINSTALLING/USING WASHER AGAIN

To reinstall washer after non-use, vacation, winter storage, or moving:

1. Refer to Installation Instructions to locate, level, and connect washer.
2. Before using again, run washer through the following recommended procedure:

To use washer again:

1. Flush water pipes and hoses. Reconnect water inlet hoses. Turn on both water faucets.

⚠ WARNING



Electrical Shock Hazard

Plug into a grounded 3 prong outlet.

Do not remove ground prong.

Do not use an adapter.

Do not use an extension cord.

Failure to follow these instructions can result in death, fire, or electrical shock.

2. Plug in washer or reconnect power.
3. Run washer through Bulky/Bedding cycle to clean washer and remove antifreeze, if used. Use only HE High Efficiency detergent. Use half the manufacturer's recommended amount for a medium-size load.

TROUBLESHOOTING

First try the solutions suggested here for assistance and to possibly avoid a service call.

If you experience	Possible Causes	Solution
Vibration or Off-Balance		
Vibration, rocking, or "walking"	Feet may not be in contact with the floor and locked.	Front and rear feet must be in firm contact with floor, and washer must be level to operate properly. Jam nuts must be tight against the bottom of the cabinet.
	Washer may not be level.	Check floor for flexing or sagging. If flooring is uneven, a 3/4" (19 mm) piece of plywood under your washer will reduce sound. See "Level the Washer" in the Installation Instructions.
Vibration during spinning or washer stopped with all dial lights flashing	Load could be unbalanced.	Load items in loose heaps evenly around the washplate. Adding wet items to washer or adding more water to basket could unbalance washer.
		Avoid washing single items. Balance a single item such as a rug or jeans jacket with a few extra items. If the dial is flashing, redistribute the load, close the lid, and touch and hold START/PAUSE/Unlock Lid.
		Use Bulky/Bedding cycle for oversized, non-absorbent items such as comforters or poly-filled jackets. Other items may not be appropriate for Bulky/Bedding cycle. See "Cycle Guide."
		Item or load not suitable for selected cycle. See "Cycle Guide" and "Using Your Washer."
Noises		
Clicking or metallic noises	Objects caught in washer drain system.	Empty pockets before washing. Loose items such as coins could fall between basket and tub or may block pump. It may be necessary to call for service to remove items.
		It is normal to hear metal items on clothing such as metal snaps, buckles, or zippers touch against the stainless steel basket.
Gurgling or humming	Washer may be draining water.	It is normal to hear the pump making a continuous humming sound with periodic gurgling or surging as final amounts of water are removed during the spin/drain cycles.
Humming	Load sensing may be occurring.	You may hear the hum of the sensing spins after you have started the washer. This is normal.
Whirring	Basket may be slowing down.	You may hear the whirring sound of the basket decelerating. This is normal.
Water Leaks		
Check the following for proper installation:	Washer not level.	Water may splash off basket if washer is not level.
	Fill hoses not attached tightly.	Tighten fill-hose connection.
	Fill hose washers	Make sure all four fill hose flat washers are properly seated.
	Drain hose connection	Pull drain hose from washer cabinet and properly secure it to drainpipe or laundry tub.
		Do not place tape over drain opening.
	Check household plumbing for leaks or clogged sink or drain.	Water can back up out of a clogged sink or drainpipe. Check all household plumbing for leaks (laundry tubs, drain pipe, water pipes, and faucets.)
Washer not loaded as recommended.	An unbalanced load can cause basket to be out of alignment and cause water to splash off tub. See "Using Your Washer" for loading instructions.	
Washer not performing as expected		
Not enough water in washer	Load not completely covered in water.	This is normal operation for an HE low-water washer. The load will not be completely underwater. The washer senses load sizes and adds correct amount of water for optimal cleaning. See "What's New under the Lid." IMPORTANT: Do not add more water to washer. Adding water lifts the items off the washplate, resulting in less effective cleaning.
		Run Clean Washer cycle to optimize the water level and wash performance.

TROUBLESHOOTING

First try the solutions suggested here for assistance and to possibly avoid a service call.

If you experience	Possible Causes	Solution
Washer not performing as expected (cont.)		
Washer won't run or fill, washer stops working	Check for proper water supply.	Both hoses must be attached and have water flowing to inlet valve.
		Both hot and cold water faucets must be turned on.
		Check that inlet valve screens have not become clogged.
		Check for any kinks in inlet hoses, which can restrict water flow.

⚠ WARNING



Electrical Shock Hazard

Plug into a grounded 3 prong outlet.

Do not remove ground prong.

Do not use an adapter.

Do not use an extension cord.

Failure to follow these instructions can result in death, fire, or electrical shock.

If you experience	Possible Causes	Solution	
Washer not performing as expected (cont.)			
Washer won't run or fill, washer stops working (cont.)	Check proper electrical supply.	Plug power cord into a grounded 3-prong outlet.	
		Do not use an extension cord.	
		Ensure there is power to outlet.	
		Reset a tripped circuit breaker. Replace any blown fuses. NOTE: If problems continue, contact an electrician.	
	Normal washer operation.		Lid must be closed for washer to run.
			Washer will pause during certain phases of cycle. Do not interrupt cycle.
			Washer may be stopped to reduce suds.
	Washer may be tightly packed.		Remove several items, rearrange load evenly around the washplate. Close lid and touch and hold START/PAUSE/Unlock Lid.
			Add only 1 or 2 additional items after washer has started.
			Do not add more water to the washer.
	Not using HE detergent or using too much HE detergent.		Only use HE detergent. Suds from regular detergents can slow or stop the washer. Always measure detergent and follow detergent directions based on your load requirements.
			To remove suds, cancel cycle. Select RINSE & SPIN. Select your cycle. Touch and hold START/PAUSE/Unlock Lid. Do not add more detergent.
Washer not draining/spinning, loads are still wet	Small items may have been caught in pump or between basket and tub, which can slow draining.	Empty pockets and use garment bags for small items.	
	Using cycles with a lower spin speed.	Cycles with lower spin speeds remove less water than cycles with high spin speeds. Use the recommended cycle/spin speed for your item.	

TROUBLESHOOTING

First try the solutions suggested here for assistance and to possibly avoid a service call.

If you experience	Possible Causes	Solution
Washer not performing as expected (cont.)		
Washer not draining/ spinning, loads are still wet (cont.)	Washer may be tightly packed or unbalanced.	Tightly packed loads may not allow the washer to spin correctly, leaving the load wetter than normal. Evenly arrange the wet load for balanced spinning. Select DRAIN & SPIN to remove excess water. See "Using Your Washer" for loading recommendations.
	Load off balance.	See "Vibration or Off-Balance" in Troubleshooting section for more information.
	Check plumbing for correct drain hose installation. Drain hose extends into standpipe farther than 4.5" (114 mm).	Check drain hose for proper installation. Use drain hose form and securely attach to drainpipe or tub. Do not tape over drain opening. Lower drain hose if the end is higher than 96" (2.4 m) above the floor. Remove any clogs from drain hose.
	Not using HE detergent or using too much HE detergent.	Suds from regular detergent or using too much detergent can slow or stop draining or spinning. Use only HE detergent. Always measure and follow detergent directions for your load. To remove extra suds, select RINSE & SPIN. Do not add detergent.
Dry spots on load after cycle	High speed spins extract more moisture than traditional top-load washers.	The high spin speeds combined with air flow during the final spin can cause items near the top of the load to develop dry spots during the final spin. This is normal.
Incorrect or wrong wash or rinse temperatures	Check for proper water supply.	Make sure hot and cold inlet hoses are not reversed.
		Both hoses must be attached to both washer and faucet, and have both hot and cold water flowing to inlet valve.
		Check that inlet valve screens are not clogged.
		Remove any kinks in hoses.
Energy-saving controlled wash temperatures.	ENERGY STAR® qualified washers use cooler wash and rinse water temperatures than traditional top-load washers. This includes cooler hot and warm washes.	
Load not rinsed	Check for proper water supply.	Make sure hot and cold inlet hoses are not reversed.
		Both hoses must be attached and have water flowing to the inlet valve.
		Both hot and cold water faucets must be on.
		Inlet valve screens on washer may be clogged.
		Remove any kinks in the inlet hose.
	Not using HE detergent or using too much HE detergent.	The suds from regular detergent can cause the washer to operate incorrectly.
		Use only HE detergent. Be sure to measure correctly.
		Always measure detergent and follow detergent directions based on load size and soil level.
	Washer may be tightly packed.	The washer is less efficient at rinsing when load is tightly packed.
		Load items in loose heaps evenly around the washplate.
Use cycle designed for the fabrics being washed.		
Add only 1 or 2 additional items after washer has started.		
Fabric softener option not selected.	When using fabric softener, be sure the Fabric Softener option is selected.	
Sand, pet hair, lint, etc. on load after washing	Heavy sand, pet hair, lint, and detergent or bleach residues may require additional rinsing.	Add Two Rinses to the selected cycle.
Load is tangling	Washer not loaded as recommended.	Load items in loose heaps evenly around the washplate.
		Reduce tangling by mixing types of load items. Use the recommended cycle for the type of items being washed.
	Wash action and/or spin speed too fast for load.	Select a cycle with a slower wash action and slower spin speed. Note that items will be wetter than when using a higher spin speed.

TROUBLESHOOTING

First try the solutions suggested here for assistance and to possibly avoid a service call.

If you experience	Possible Causes	Solution
Washer not performing as expected (cont.)		
Not cleaning or removing stains	Wash load not completely covered in water.	Washer senses load size and adds correct amount of water. This is normal and necessary for clothes to move.
	Added more water to washer.	Do not add more water to washer. Adding water lifts the items off the washplate, resulting in less effective cleaning.
	Washer not loaded as recommended.	Load items in loose heaps evenly around the washplate.
		Add only 1 or 2 additional items after washer has started.
	Adding detergent on top of load.	Add detergent, Oxi products, and color-safe bleach to the bottom of the basket before adding the load items.
	Not using HE detergent or using too much HE detergent.	The suds from regular detergent can prevent washer from operating correctly.
		Use only HE detergent. Be sure to measure correctly.
		Always measure detergent and follow detergent directions based on load size and soil level.
	Not using correct cycle for fabric type.	Use a higher soil level cycle option and warmer wash temperature to improve cleaning.
		If using Express cycle (on some models), wash only a few items.
		Use Whites, Heavy Duty, or Cold Clean cycle for tough cleaning.
		See the "Cycle Guide" to match your load with the best cycle.
Not using dispensers.	Use dispensers to avoid chlorine bleach and fabric softener staining.	
	Load dispensers before starting a cycle.	
	Avoid overfilling.	
	Do not add products directly onto load.	
Not washing like colors together.	Wash like colors together and remove promptly after the cycle is complete to avoid dye transfer.	
Odors	Monthly maintenance not done as recommended.	Run the Clean Washer cycle after every 30 washes. See "Washer Care" in "Washer Maintenance."
		Unload washer as soon as cycle is complete.
	Not using HE detergent or using too much HE detergent.	Use only HE detergent. Be sure to measure correctly.
		Always follow the detergent directions.
		See "Washer Care" section.
Fabric Damage	Sharp items were in pockets during wash cycle.	Empty pockets, zip zippers, and snap or hook fasteners before washing to avoid snags and tears.
	Strings and straps could have tangled.	Tie all strings and straps before starting wash load.
	Items may have been damaged before washing.	Mend rips and broken threads in seams before washing.
	Fabric damage can occur if the load is tightly packed.	Load items in loose heaps evenly around washplate.
		Load items should move freely during wash to avoid damage.
		Use cycle designed for the fabrics being washed.
		Add only 1 or 2 additional items after washer has started.
	Garment care instructions may not have been followed.	Always read and follow garment manufacturer's care label instructions. See the "Cycle Guide" to match your load with the best cycle.
	Liquid chlorine bleach may have been added incorrectly.	Do not pour liquid chlorine bleach directly onto load. Wipe up bleach spills.
		Undiluted bleach will damage fabrics. Do not use more than recommended by manufacturer.
Do not place load items on top of bleach dispenser when loading and unloading washer.		

TROUBLESHOOTING

First try the solutions suggested here for assistance and to possibly avoid a service call.

If you experience	Possible Causes	Solution
Washer not performing as expected (cont.)		
Incorrect dispenser operation	Clogged dispensers or laundry products dispensing too soon.	Do not overfill dispenser. Overfilling causes immediate dispensing.
		Always select Fabric Softener option to assure proper dispensing.
		Load dispensers before starting a cycle.
		It is normal for small amounts of water to remain in dispenser at the end of the cycle.
	Liquid chlorine bleach not used in dispenser or TimedOxi option not selected.	Homes with low water pressure may result in residual powder in the dispenser. To avoid, select a warmer wash temperature if possible, depending on your load.
		Use only liquid chlorine bleach in the bleach dispenser.
Powdered detergent not dissolving completely in load	Using too much HE detergent.	Follow the manufacturer's instructions to determine the amount of detergent to use.
	Water temperature is very cold.	Select a warmer wash temperature.
		Try adding the detergent to the basket prior to adding laundry rather than using the detergent dispenser.
Single-dose laundry packet not dissolving	Adding laundry packet incorrectly.	Be sure laundry packet is added to washer basket before adding clothes. Follow the manufacturer's instructions to avoid damage to your items.
Error Code Appears in Display		
LF (too long to fill) appears in display	Washer taking too long to fill. Drain extends more than 4.5" (114 mm) into standpipe.	Check plumbing for correct drain hose installation. Use drain hose form and attach securely to drainpipe or tub. Do not tape over drain opening. See Installation Instructions.
"_."	Cycle knob is not on cycle.	This is not an error. The selector knob is not on a cycle. Rotate your selector knob until a cycle lights up.
F## code (F-type error code) appears in display	System error code.	Touch START/PAUSE/Unlock Lid once to clear the code. Then touch START/PAUSE/Unlock Lid again to restart washer. If code appears again, call for service.

PROTECTION AGREEMENTS

Master Protection Agreements

Congratulations on making a smart purchase. Your new Kenmore® product is designed and manufactured for years of dependable operation.

But like all products, it may require preventive maintenance or repair from time to time. That's when having a Master Protection Agreement can save you money and aggravation.

The Master Protection Agreement also helps extend the life of your new product. Here's what the Agreement* includes:

Parts and labor needed to help keep products operating properly **under normal use**, not just defects. Our coverage goes **well beyond the product warranty**. No deductibles, no functional failure excluded from coverage—**real protection**.

Expert service by a force of more than 10,000 **authorized Sears service technicians**, which means someone you can trust will be working on your product.

Unlimited service calls and nationwide service, as often as you want us, whenever you want us.

Replacement of your covered product if four or more product failures occur within twelve months.

Product replacement if your covered product can't be fixed.

Annual Preventive Maintenance Check at your request – no extra charge.

Fast help by phone – we call it **Rapid Resolution** – phone support from a Sears representative on all products. Think of us as a “talking owner's manual.”

Power surge protection against electrical damage due to power fluctuations.

Rental reimbursement if repair of your covered product takes longer than promised.

25% discount off the regular price of any non-covered repair service and related installed parts.

Once you purchase the Agreement, a simple phone call is all that it takes for you to schedule service. You can call anytime day or night, or schedule a service appointment online.

The Master Protection Agreement is a risk free purchase. If you cancel for any reason during the product warranty period, we will provide a full refund. Or, a prorated refund anytime after the product warranty period expires. Purchase your Master Protection Agreement today! **Some limitations and exclusions apply. For prices and additional information in the U.S.A., call 1-800-827-6655. *Coverage in Canada varies on some items. For full details, call Sears Canada at 1-800-361-6665.**

Sears Installation Service

For Sears professional installation of home appliances, garage door openers, water heaters, and other major home items, in the U.S.A. call **1-844-553-6667** or in Canada call **1-800-469-4663**.

KENMORE APPLIANCE WARRANTY

KENMORE LIMITED WARRANTY

FOR ONE YEAR from the date of sale this appliance is warranted against defects in material or workmanship when it is correctly installed, operated, and maintained according to all supplied instructions.

WITH PROOF OF SALE, a defective appliance will receive free repair or replacement at option of seller.

For warranty coverage details to obtain free repair or replacement, visit the web page: www.kenmore.com/warranty.

This warranty applies for only 90 DAYS from the sale date in the United States, and is void in Canada, if this appliance is ever used for other than private household purposes.

This warranty covers ONLY defects in material and workmanship, and will NOT pay for:

1. Expendable items that can wear out from normal use, including but not limited to filters, belts, bags, or screw-in base light bulbs.
2. A service technician to clean or maintain this appliance, or to instruct the user in correct appliance installation, operation, and maintenance.
3. Service calls to correct appliance installation not performed by Sears authorized service agents, or to repair problems with house fuses, circuit breakers, house wiring, and plumbing or gas supply systems resulting from such installation.
4. Damage to or failure of this appliance resulting from installation not performed by Sears authorized service agents, including installation that was not in accord with electrical, gas, or plumbing codes.
5. Damage to or failure of this appliance, including discoloration or surface rust, if it is not correctly operated and maintained according to all supplied instructions.
6. Damage to or failure of this appliance, including discoloration or surface rust, resulting from accident, alteration, abuse, misuse or use for other than its intended purpose.

7. Damage to or failure of this appliance, including discoloration or surface rust, caused by the use of detergents, cleaners, chemicals, or utensils other than those recommended in all instructions supplied with the product.

8. Damage to or failure of parts or systems resulting from unauthorized modifications made to this appliance.

9. Service to an appliance if the model and serial plate is missing, altered, or cannot easily be determined to have the appropriate certification logo.

DISCLAIMER OF IMPLIED WARRANTIES; LIMITATION OF REMEDIES

Customer's sole and exclusive remedy under this limited warranty shall be product repair or replacement as provided herein. Implied warranties, including warranties of merchantability or fitness for a particular purpose, are limited to one year or the shortest period allowed by law. Seller shall not be liable for incidental or consequential damages. Some states and provinces do not allow the exclusion or limitation of incidental or consequential damages, or limitation on the duration of implied warranties of merchantability or fitness, so these exclusions or limitations may not apply to you.

This warranty applies only while this appliance is used in the United States or Canada*.

This warranty gives you specific legal rights, and you may also have other rights which vary from state to state.

* In-home repair service is not available in all Canadian geographical areas, nor will this warranty cover user or servicer travel and transportation expenses if this product is located in a remote area (as defined by Sears Canada Inc.) where an authorized servicer is not available.

**Sears Brands Management Corporation
Hoffman Estates, IL 60179**

**Sears Canada Inc.
Toronto, Ontario, Canada M5B 2C3**

Kenmore®

For Sears Home Services in-home repair
of all Kenmore major appliances.

For the replacement parts, accessories and
Use & Care Guides that you need to do-it-yourself.

For professional installation of major home appliances
and items like air conditioners and water heaters.

1-844-553-6667

www.kenmore.com

In Canada 1-800-469-4663

www.sears.ca

Call anytime for the location of your nearest
Sears Parts & Repair Service Center

1-800-488-1222 (U.S.A.)

1-800-469-4663 (Canada)

To purchase a protection agreement on a serviceable product:

1-800-827-6655 (U.S.A.)

1-800-361-6665 (Canada)

Para pedir servicio de reparación
a domicilio, y ordenar piezas:

1-888-SU-HOGAR®

(1-888-784-6427)

www.kenmore.com

Au Canada pour service en français :

1-800-LE-FOYER^{MC}

(1-800-533-6937)

www.sears.ca

