

Use and Care Manual



Dual Fuel Range



BOSCH
Invented for life



Table of Contents

About This Manual	1
How This Manual Is Organized	1
Safety	2
Important Safety Instructions	2
Getting Started	8
Parts and Accessories	8
Control (Panel)	16
Before Using the Appliance for the First Time	20
Operation - Cooktop	21
About the Cooktop	21
Operation	21
Operation - Oven	23
About the Oven	23
Operation	23
Operation - Warming Drawer (some models)	27
About the Warming Drawer	27
Operation	28
Getting the Most Out of Your Appliance	30
Getting the Most Out of Your Cooktop	30
Getting the Most Out of Your Oven	31
Getting the Most Out of Your Warming Drawer	37
Cleaning and Maintenance	40
Cleaning - Cooktop	40
Cleaning - Oven	43
Cleaning - Drawers (Storage or Warming)	46
Maintenance	46
Service	50
Before Calling Service	50

Questions?

1-800-944-2904

www.boschappliances.com
5551 McFadden Ave.
Huntington Beach, CA 92649

We look forward to hearing from you!

About This Manual

How This Manual Is Organized

This manual contains several sections:

- The *Getting Started* section describes the features and functionality of the range, including a description of how to set up the range and operate the control panel.
- The *Operation* sections describe how to operate each range component.
- The *Getting the Most out of Your Appliance* section includes information about the modes, cooking charts and tips for improving performance.
- The *Cleaning and Maintenance* section describes how to clean and maintain your appliance.
- The *Service* section includes troubleshooting tips and your Warranty.

Before using your range, be sure to read this manual. Pay special attention to the **Safety Sections** located at the beginning of the manual.

Safety



Important Safety Instructions

READ AND SAVE THESE INSTRUCTIONS

Important Safety Instructions

Proper Installation and Maintenance

WARNING:

When properly cared for, your new appliance has been designed to be safe and reliable. Read all instructions carefully before use. These precautions will reduce the risk of burns, electric shock, fire, and injury to persons. When using kitchen appliances, basic safety precautions must be followed, including those in the following pages.

- Have the installer show you the location of the circuit breaker or fuse. Mark it for easy reference.
- This appliance must be properly installed and grounded by a qualified technician. Connect only to properly grounded outlet. Refer to Installation Instructions for details.
- All ranges can tip. Injury to persons could result. Install anti-tip device packaged with range. Verify that the anti-tip devices are engaged. See installation instructions.



Figure 1: Tipping Precautions

- This appliance is intended for normal family household use only. It is not approved for outdoor use. See the Warranty. If you have any questions, contact the manufacturer.
- Do not store or use corrosive chemicals, vapors, flammables or nonfood products in or near this appliance. It is specifically designed for use when heating or cooking food. The use of corrosive chemicals in heating or cleaning will damage the appliance and could result in injury.
- Do not operate this appliance if it is not working properly, or if it has been damaged. Contact an authorized service person.
- Do not obstruct oven vents.
- Do not repair or replace any part of the appliance unless specifically recommended in this manual. Refer all servicing to a factory authorized service center.
- In the event of an error the display flashes and beeps continuously. If this happens during self-clean, disconnect appliance from the power supply and call a qualified technician.

Gas Safety

- In the event of an error the display flashes and beeps continuously. Disconnect appliance from the power supply and call a qualified technician.

**WARNING:**

NEVER cover any slots, holes or passages in the oven bottom or cover an entire rack with materials such as aluminum foil. Doing so blocks air flow through the oven and may cause carbon monoxide poisoning. Aluminum foil linings may also trap heat, causing a fire hazard.

**WARNING:**

If the information in this manual is not followed exactly, a fire or explosion may result causing property damage, personal injury or death.

Do not store or use combustible materials, gasoline or other flammable vapors and liquids in the vicinity of this or any other appliance.

• **WHAT TO DO IF YOU SMELL GAS:**

- Do not try to light any appliance.
- Do not touch any electrical switch.
- Do not use any phone in your building.
- Immediately call your gas supplier from a neighbor's phone. Follow the gas supplier's instructions.
- If you cannot reach your gas supplier, call fire department.

Installation and service must be performed by a qualified installer, authorized service agency or the gas supplier.

- Have the installer show you where the gas shut-off valve is located.
- If a burner goes out and gas escapes, open windows and doors. Wait until gas dissipates before using the appliance.
- If you smell gas, your installer has not done a proper job of checking for leaks. If the connections are not perfectly tight, you can have a small leak and, therefore, a faint smell. Finding a gas leak is not a "do-it-yourself" procedure. Some leaks can only be found with the burner control in the ON position and this must be done by a qualified service technician.

WARNING:

Use this appliance only for its intended use as described in this manual. NEVER use this appliance as a space heater to heat or warm a room. Doing so may result in carbon monoxide poisoning and overheating the appliance. Never use the appliance for storage.

- For proper burner performance, keep igniters clean and dry.
- If a burner goes out and gas escapes, open windows and doors. Wait until gas dissipates before using the appliance.

Fire Safety

- Do not use aluminum foil or protective liners to line any part of an appliance, especially surface unit drip bowls or oven bottom. Installation of these liners may result in a risk of electric shock or fire.
- Set the burner control so that the flame does not extend beyond the bottom of the pan.
- If materials inside an oven or warming drawer should ignite, keep door closed. Turn off the appliance and disconnect the circuit at the circuit breaker box.
- Do not allow aluminum foil, plastic, paper or cloth to come in contact with a hot burner or grate. Do not allow pans to boil dry.
- If the cooktop is near a window, forced air vent, or fan, be certain that flammable materials such as window coverings do not blow over or near the burners or elements. They could catch on fire.
- Always have a working smoke detector near the kitchen.
- Never leave the cooktop unattended when in use. Boilovers cause smoking and greasy spillovers may ignite.

WARNING:

TO REDUCE THE RISK OF A RANGE TOP GREASE FIRE:

- a) Never leave surface units unattended at high settings. Boilovers cause smoking and greasy spillovers that may ignite. Heat oils slowly on low or medium settings.
- b) Always turn hood ON when cooking at high heat or when flambéing food (i.e. Crepes Suzette, Cherries Jubilee, Peppercorn Beef Flambe').
- c) Clean ventilating fans frequently. Grease should not be allowed to accumulate on fan or filter.
- d) Use proper pan size. Always use cookware appropriate for the size of the surface element.

- In the event that personal clothing or hair catches fire, drop and roll immediately to extinguish flames.
- Take care that drafts like those from fans or forced air vents do not push the flames so that they extend beyond the edges of the pan.

WARNING:

TO REDUCE THE RISK OF PERSONAL INJURY IN THE EVENT OF A GREASE FIRE, OBSERVE THE FOLLOWING:

- SMOTHER FLAMES with a close-fitting lid, cookie sheet, or metal tray, then turn off the burner. EXERCISE CAUTION TO PREVENT BURNS. If the flames do not go out immediately, EVACUATE AND CALL THE FIRE DEPARTMENT.
- NEVER PICK UP A FLAMING PAN—You may be burned.
- DO NOT USE WATER, including wet rags or towels—a violent steam explosion will result.
- Use an extinguisher ONLY if:
 - 1) You know you have a CLASS ABC extinguisher and you already know how to operate it.
 - 2) The fire is small and contained in the area where it started.
 - 3) The fire department is being called.
 - 4) You can fight the fire with your back to an exit.

- Have an appropriate fire extinguisher available, nearby, highly visible and easily accessible near the oven.

- Smother flames from food fires other than grease fires with baking soda. Never use water on cooking fires.
- Whenever possible, do not operate the ventilation system during a cooktop fire. However, do not reach through fire to turn it off.

Burn Prevention

- DO NOT TOUCH SURFACE UNITS OR AREAS NEAR UNITS - Surface units may be hot even though they are dark in color. Areas near surface units may become hot enough to cause burns. During and after use, do not touch, or let clothing, potholders, or other flammable materials contact surface units or areas near units until they have had sufficient time to cool. Among these areas are the cooktop and areas facing the cooktop.
- DO NOT TOUCH HEATING ELEMENTS OR INTERIOR SURFACES OF OVEN - Heating elements may be hot even though they are dark in color. Interior surfaces of an oven become hot enough to cause burns. During and after use, do not touch, or let clothing, potholders, or other flammable materials contact heating elements or interior surfaces of oven until they have had sufficient time to cool. Other surfaces of the appliance may become hot enough to cause burns. Among these surfaces are oven vent openings, surfaces near these openings and oven doors.
- Exercise caution when opening the appliance. Standing to the side, open the door (or drawer) slowly and slightly to let hot air and/or steam escape. Keep your face clear of the opening and make sure there are no children or pets near the unit. After the release of hot air and/or steam, proceed with your cooking. Keep doors shut unless necessary for cooking or cleaning purposes. Do not leave open doors unattended.
- Do not heat or warm unopened food containers. Build-up of pressure may cause the container to burst and cause injury.
- Always place oven racks in desired location while oven is cool. If a rack must be moved while oven is hot, do not let potholder contact the heating elements.
- Always turn hood ON when cooking at high heat or when flambéing food (i.e. Crepes Suzette, Cherries Jubilee, Peppercorn Beef Flambe').
- Use high heat settings on the cooktop only when necessary. To avoid bubbling and splattering, heat oil slowly on no more than a low-medium setting. Hot oil is capable of causing extreme burns and injury.
- Never move a pan of hot oil, especially a deep fat fryer. Wait until it is cool.
- Use caution when cooking foods with high alcohol content (e.g. rum, brandy, bourbon) in the oven. Alcohol evaporates at high temperatures. There is a risk of burning as the alcohol vapors may catch fire in the oven. Use only small quantities of alcohol in foods, and open the oven door carefully.

Child Safety

- When children become old enough to use the appliance, it is the legal responsibility of the parents or legal guardians to ensure that they are instructed in safe practices by qualified persons.
- Do not allow anyone to climb, stand, lean, sit, or hang on any part of an appliance, especially a door, warming drawer, or storage drawer. This can damage the appliance, and the unit may tip over, potentially causing severe injury.
- Do not allow children to use this appliance unless closely supervised by an adult. Children and pets should not be left alone or unattended in the area where the appliance is in use. They should never be allowed to play in its vicinity, whether or not the appliance is in use.

CAUTION:

Items of interest to children should not be stored in an appliance, in cabinets above an appliance or on the backsplash. Children climbing on an appliance to reach items could be seriously injured.



CAUTION:

All igniters spark when any single burner is turned on. Do not touch any of the burners when the cooktop is in use.

IMPORTANT SAFETY NOTICE:

The California Safe Drinking and Toxic Enforcement Act requires the Governor of California to publish a list of substances known to the state to cause cancer, birth defects or other reproductive harm, and requires businesses to warn customers of potential exposure to such substances.

- 1) The burning of gas cooking fuel and the elimination of soil during self-cleaning can generate small amounts of Carbon Monoxide.
- 2) The fiberglass insulation in self-clean ovens gives off very small amounts of formaldehyde during the first several cleaning cycles.
- 3) California lists formaldehyde as a potential cause of cancer. Carbon Monoxide is a potential cause of reproductive toxicity.
- 4) Exposure to these substances can be minimized by:
 - a) Providing good ventilation when cooking with gas.
 - b) Providing good ventilation during and immediately after self cleaning the oven.
 - c) Operating the unit according to the instructions in this manual.

Cleaning Safety

- Do not clean the appliance while it is still hot. Some cleaners produce noxious fumes when applied to a hot surface. Wet cloths or sponges can cause burns from steam.
- When self-cleaning, confirm that the door locks and will not open. If the door does not lock, do not run Self-Clean. Contact service.
- Birds have very sensitive respiratory systems. Keep pet birds out of the kitchen or other rooms where kitchen fumes could reach them. During self clean, fumes are released that may be harmful to birds. Other kitchen fumes such as overheating margarines and cooking oils may also be harmful.
- Keep oven free from grease build up.

Cookware Safety

- Do not place food directly on oven bottom.
- Follow the manufacturer's directions when using cooking or roasting bags.
- Hold the handle of the pan when stirring or turning food. This helps prevent spills and movement of the pan.
- Use Proper Pan Size. The use of undersized cookware will expose a portion of the heating element or burner to direct contact and may result in ignition of clothing. Select cookware having flat bottoms large enough to cover the surface heating unit. This appliance is equipped with one or more surface units of different size. Proper relationship of cookware to heating element or burner will also improve efficiency.
- Always position handles of utensils inward so they do not extend over adjacent work areas, burners, or the edge of the cooktop. This reduces the risk of fires, spills and burns.
- Adjust burner flame size so that it does not extend beyond the edge of the cookware. Proper relationship of cookware to burner flame reduces safety risks.

Food Safety**CAUTION:**

To maintain food safety, follow these guidelines:

- 1) DO NOT use the warming drawer to heat cold food (exception: it is safe to use the drawer to crisp crackers, chips or dry cereal and to warm plates.)
- 2) Be sure to maintain proper food temperature. The USDA recommends holding hot food at 140°F or warmer.
- 3) DO NOT warm food for longer than one hour.

Getting Started

Parts and Accessories

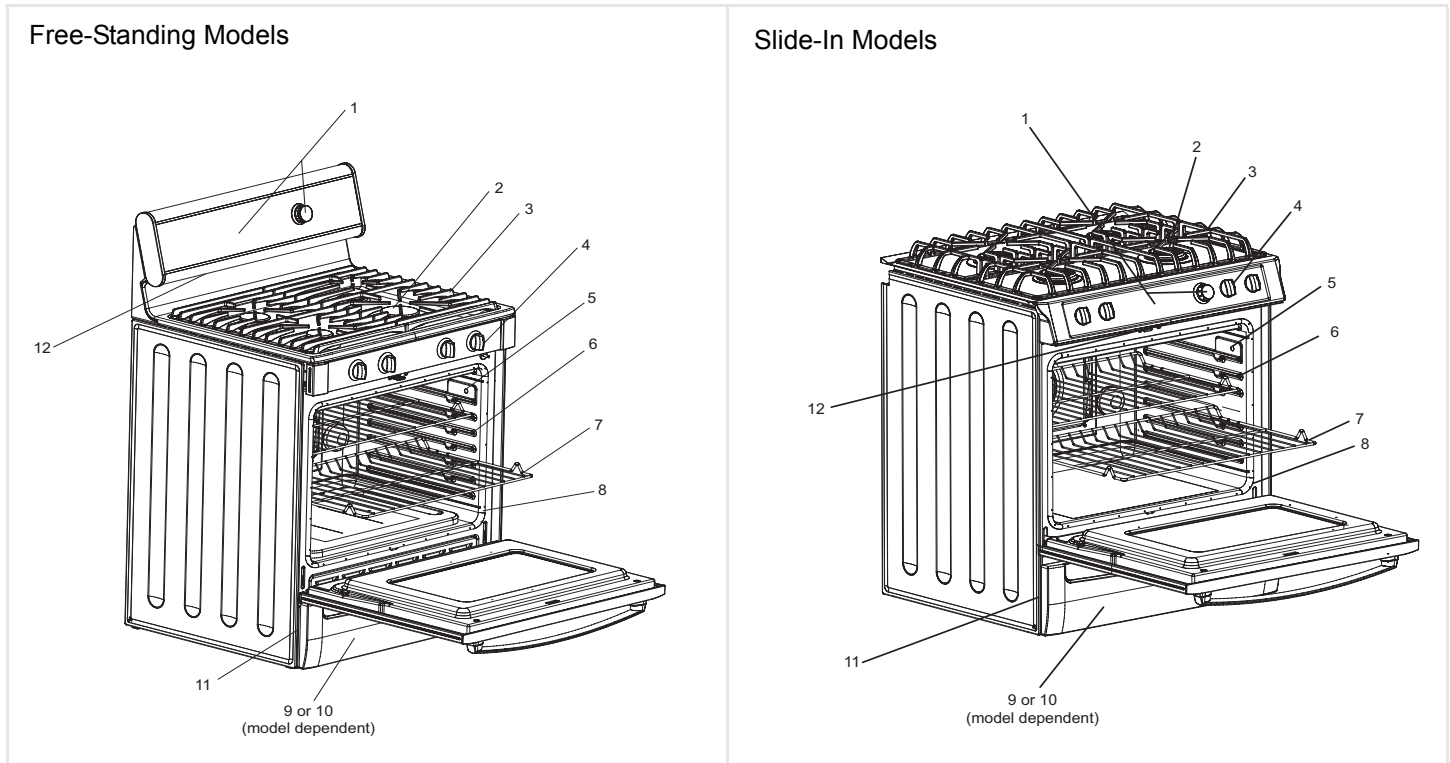

Figure 2: Parts and Accessories

Table 1: Parts and Accessories Key

#	Part	#	Part
1	Oven Control Panel and Knob	13	Cooktop Scraper (glass ceramic models only) (not shown)
2	Burner Caps (4)	14	Weiman Cook Top® glass ceramic cooktop cleaner (glass ceramic models only) (not shown)
3	Burner Grates (2 or 4; varies by model)	15	Anti-Tip Bracket (not shown)
4	Cooktop Control Knob	16	Broiler Pan (not shown)
5	Probe Receptacle	17	Oven Rack, Half (some models) (not shown)
6	Rack Positions/ Rack Guides	18	Oven Rack, Full Extension (some models) (not shown)
7	Oven Racks, Flat (2 or 3; varies by model)	19	Literature Package (not shown)
8	Oven Door Gasket	20	Oven Lights (2) (oven back wall) (not shown)
9	Storage Drawer (some models) ^a	21	Convection Fan and Element (oven back wall; not shown)

Table 1: Parts and Accessories Key

#	Part	#	Part
10	Warming Drawer (some models) ^a	22	Broil Element (top of oven interior) (not shown)
11	Model # and Serial # Plate	23	Oven Door Lock (not visible) (not shown)
12	Oven Vent		

a. Depending on the model, your appliance has either a storage drawer or a warming drawer.

Sealed Gas Burners

The cooktop has sealed gas burners. As a result, there are no parts under the cooktop to clean, disassemble or adjust. Spills stay on top of the cooktop where they are easier to wipe up.

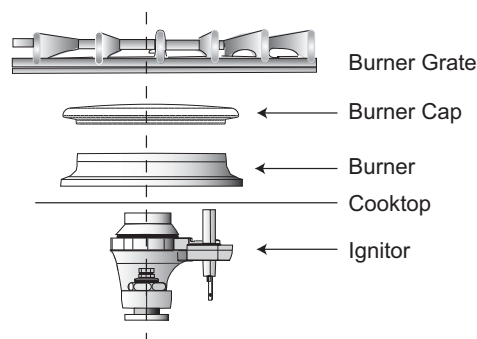

Figure 3: Right Side Burner - Side View

Burner Caps

The cooktop has four burner caps. Match the size of the burner cap to the size of the burner. Burner caps are not interchangeable.

Make sure the burner cap is completely seated on the burner base before attempting to light the burner. If the burner cap is not placed correctly, the burner may not light or the flame may not burn completely or correctly. The appliance comes with two different types of burner caps: standard and diffusion (model dependent). See the sections below for further information on each.

Diffusion Burner Caps

Depending on the model, the appliance is equipped with 1 to 4 diffusion burner caps. They provide a more even heat, especially when cooking at lower temperatures.

Burner Grates



WARNING:

To prevent flare-ups, do not use the cooktop without all burner caps and all burner grates properly positioned. Do not use a grate if the feet are missing or damaged.

Models with Stainless Steel Cooktop:

There are two burner grates: one for the left side of the cooktop and one for the right side of the cooktop. Position them so that the circular opening is over the

burner cap. Burner grates should rest flat on the cooktop. The rubber feet on the grates should rest in the indents on the cooktop.

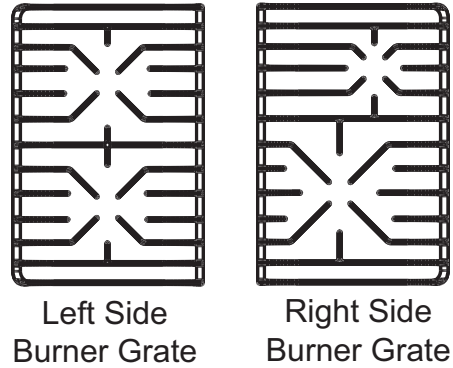

Figure 4: Grates for Free-standing Models

Models with Glass Ceramic Cooktop:

There are four burner grates: one for each burner.

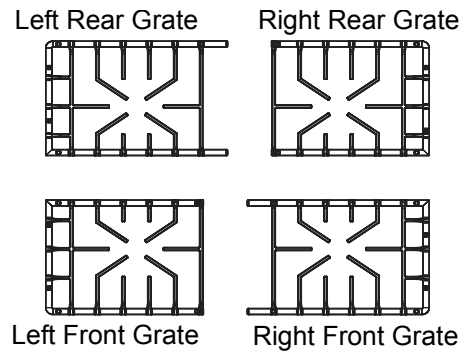

Figure 5: Grates for Slide-in Models - Top View

Position them so that the circular opening is over the burner cap. In the back, the edge of the right side grate rests on top of the edge of the left side grate. In the front, the edge of the left side grate rests on top of the edge of the right side grate.

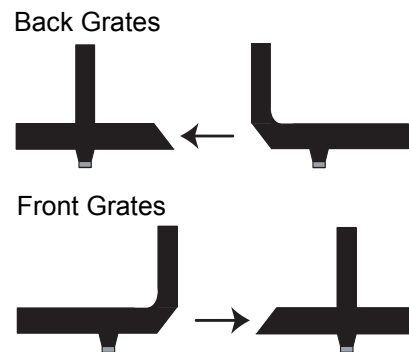

Figure 6: Installing Grates for Slide-in Models - Side View

The locating pins on the outside edges of the cooktop fit into notches on the bottom of the grates.

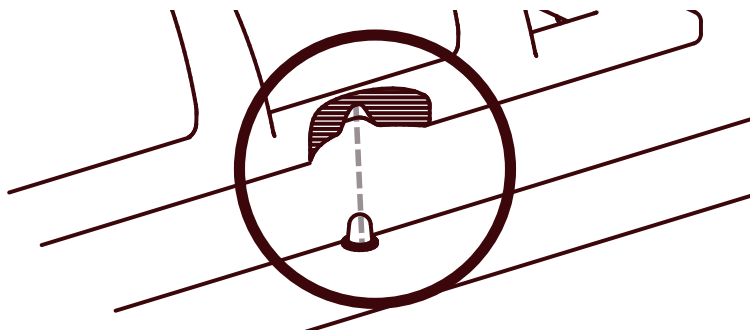

Figure 7: Grates for Slide-in Models - Locating Pins

Burner grates should rest flat on the cooktop. When properly positioned, the grates will be level and will not move back and forth.

Electronic Ignitor

The cooktop uses electronic ignitors to light the burners. There is no pilot light. Each burner has its own ignitor. For proper operation, keep the ignitor clean and dry. It is necessary to clean these when there is a boilover or when the burner does not light even though the ignitor clicks.



CAUTION:

All ignitors spark when any single burner is turned on. Do not touch any of the burners when the cooktop is in use.

High Power Burner

The high power burner is the largest burner. It is the most powerful burner on the cooktop. It retains heat longer than normal burner caps and, at low settings, prohibits the flame from touching the cookware. This results in a gentle, more predictable heat. Use the low settings on this burner to simmer large amounts of sauces or soups. Use the high settings to quickly bring large amounts of water to a boil.

Precision Burner

The precision burner is the smallest burner on the cooktop. It is well suited for gentle cooking of small amounts of food. Use the burner to melt butter or chocolate or to prepare delicate sauces.

Oven Racks

Depending on model, the range is equipped with one of the following combinations:

- Two flat racks and one full extension rack
- Two flat racks and one half rack

Flat Oven Racks

The racks are designed with a stop so they will stop before coming completely out of the oven and not tilt.



CAUTION:

To avoid burns, place oven racks in desired positions before turning oven on. Always use oven mitts when the oven is warm. If a rack must be moved while the oven is hot, do not let oven mitts contact hot elements.

Inserting Racks Into Oven

1. Grasp rack firmly on both sides.
2. Tilt rack up to allow stop into rack guide.

3. Bring rack to a horizontal position and press the rest of the way in. Rack should be straight and flat, not crooked.

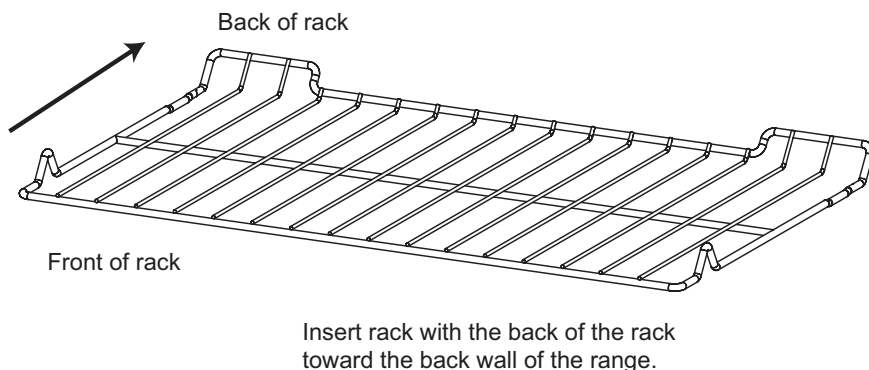

Figure 8: Inserting a Rack

Removing Flat Racks From Oven

1. Grasp rack firmly on both sides and pull rack toward you.
2. When the stop is reached, tilt rack up and pull the rest of the way out.

Extension Oven Rack (some models)

The Full Extension Rack allows for easier access to cooking foods. The bottom section extends as far as the standard flat rack. However, the top section extends beyond the bottom section bringing the food closer to the user. To order a full extension rack, contact Service or a dealer near you.

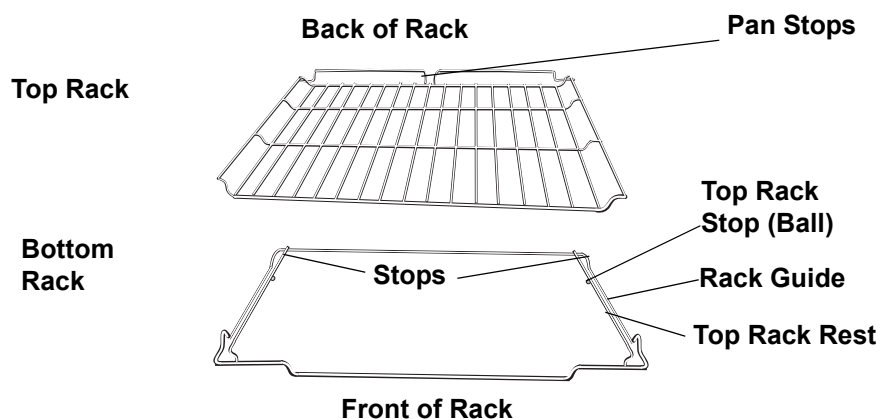

Figure 9: Full Extension Rack

Removing and Replacing



Note:

The full extension rack must be in the closed position when removing and replacing. Grasp the entire rack (both sections).

1. Grasp the bottom section and pull straight out.
2. Once the stop is reached, grasp the top section and pull straight out until the second stop is reached. If the top rack will not extend fully, it is not installed correctly. Reinstall it so that the pan stop is in the back of the oven.

Disassembly (for cleaning)

The two sections of the rack are designed to come apart for easier cleaning.

1. Place rack on flat surface in the closed position top side up.

2. Rotate one side of top rack towards you until it is past the stop (ball).
3. Pull the rack up and out, rotated side first.

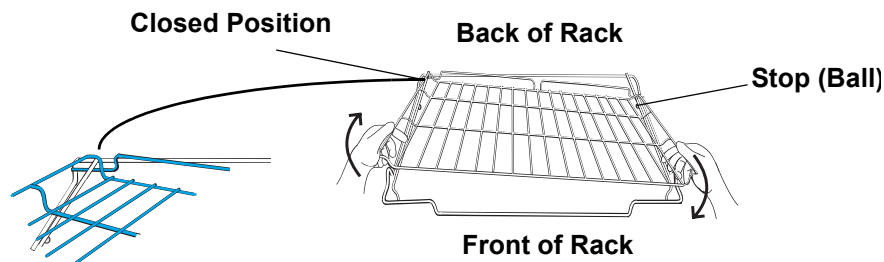

Figure 10: Disassembly

Reassembly



CAUTION:

Always verify that top rack is installed correctly after reassembly. The back edges of the top rack must be under the rack guide on the bottom rack. DO NOT simply rest the top rack on top of the bottom one.

1. To reassemble rack, hold top rack diagonally across bottom rack.
2. Insert one side of top rack to closed position.
3. Rotate the other side toward the back of the rack until it passes the stop (ball).
4. Push top rack the rest of the way in.

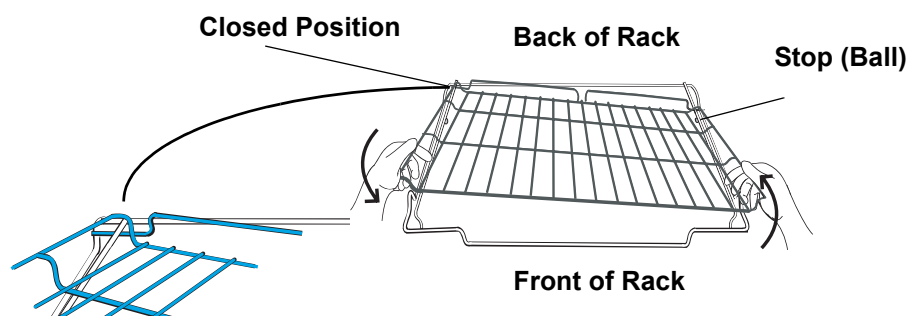

Figure 11: Reassembly

Cleaning

Clean rack with hot sudsy water. Dry thoroughly. For stubborn dirt, use a soap filled steel wool pad. DO NOT clean the rack in the self-cleaning oven.

Half Oven Rack (Some Models)

The half oven rack can be used as a simple flat rack or as a half-sized rack. With the right half of the rack removed, you can place a tall item (such as a turkey) on one side of the rack below and a shorter item (such as a casserole) on the other side. A second shorter item can then be placed on the half rack (above the first shorter item). This allows for easier access to all items and better utilization of the oven cavity.



Tip:
The removable section can also be used outside of the oven as a trivet or cooling rack.

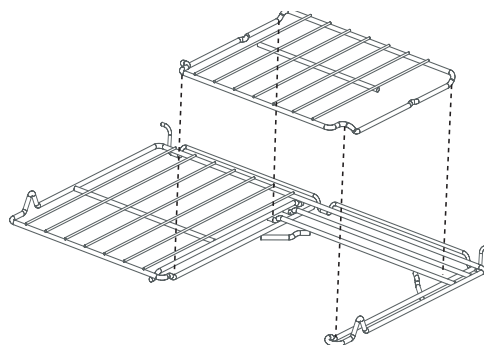

Figure 12: Half Oven Rack

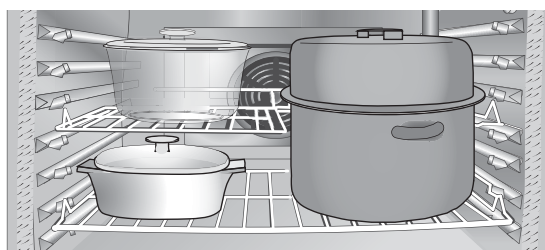

Figure 13: Half Oven Rack in Use

Oven Bottom



CAUTION:

Do not place food directly on oven bottom. Do not use aluminum foil or protective liners to line any part of an appliance, especially surface unit drip bowls or oven bottom. Installation of these liners may result in a risk of electric shock or fire.

Combustion Vents (slide-in models only)

The combustion vents are located along the back edge of the cooktop. They allow the burners to operate properly. Do not block these vents.



CAUTION:

DO NOT block combustion vents. Blocked vents could lead to fire or unintentional release of carbon monoxide.

Oven Vent

Free-standing Models:

The oven vent is located below the display above the rear left cooktop burner. It is normal to see steam escaping from the vent and condensation may collect on the backguard and cooktop.



CAUTION:

This area may become hot when the oven is in use. To prevent carbon monoxide build-up, do not block the vent. The oven vent is also important for air circulation.

Slide-in Models:

The oven vent is located above the oven door handle. Warm air may be released from the vent before, during and after cooking. It is normal to see steam escaping from the vent and condensation may collect in this area. This

area may be warm when the oven is in use. Do not block the vent as it is important for air circulation.

Automatic Shutoff

The oven will automatically shut off after 12 hours (24 hours if the time format is set for 24 hour in the Select Function section).

Self Cleaning

The oven features a self-cleaning function that eliminates the manual labor involved with cleaning your oven.

Indicators and Other Features

Beep - Signals that more information must be entered or confirms the receipt of an entry. A Beep also signals the end of a program or an oven error.

End-of-Cycle Indicator - To indicate when a mode is finished, 3 consecutive beeps will sound.

Default Settings - The cooking modes automatically select the default temperature. These can be changed when a different one is needed.

Flashing Symbol or Number - Signals an incomplete setting and calls for another step or START to be pressed.

F Number Codes - These codes display when there is a problem with the range.

Cooling Fan (Slide-in models only)

The cooling fan runs during all oven modes. You may hear it running and you may feel warm air as it is released from the oven vent. The cooling fan may continue to run after the oven is shut off. This is normal. When the oven has cooled to a pre-determined temperature, the cooling fan turns off.

Convection Fan

The convection fan operates during any convection mode and dehydrate. When the oven is operating in the convection mode, the fan will turn off automatically when the door is opened. The convection fan does run during self-clean, although not at the beginning of the mode.



Note:

On some models, the convection fan also runs during preheat for the bake mode.

Control (Panel)

Oven Control Panel

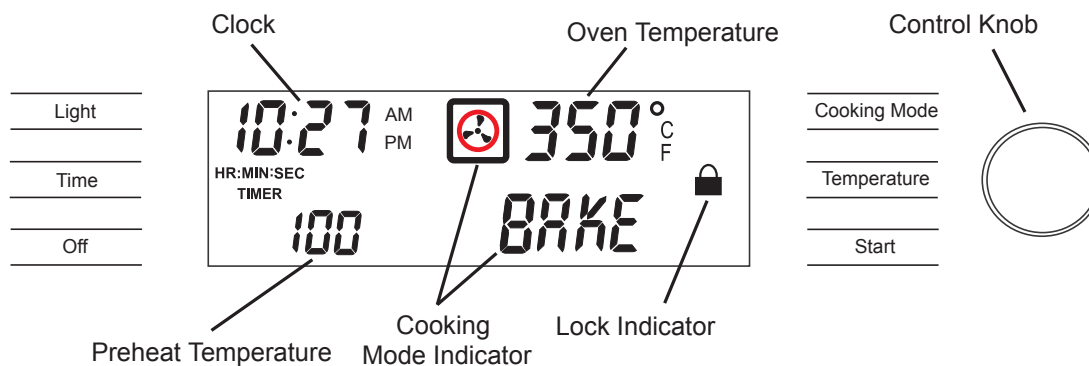

Figure 14: Oven Control Panel

Table 2: Oven Control Panel

Clock– Shows the time of day with a 12 or 24 hour option. Also displays the timer and times associated with delayed cooking and cleaning modes. Turn the control knob to toggle between timer and clock display. **Press TIME and turn the control knob to change the time of day or the timer.**

Cooking Mode - Press pad to display cooking mode.

Cooking Mode Icon – Shows the cooking elements that are active for the mode that is selected. The icon will also display a fan if the convection fan is utilized in the selected mode.

Control Knob - Used to set the clock, timers, select cooking mode and temperature. Turn clockwise to increase and turn counterclockwise to decrease.

Light - Press pad to turn oven light on or off.

Door Locking Indicator - Icon is displayed during the self-clean mode when the door is locked. DO NOT attempt to open the door until the lock symbol is no longer present.

Off - Press pad to turn off oven and/or warming drawer.

Oven Temperature - Shows the oven temperature.

Preheat Temperature - Displays temperature of oven during preheat mode.

Probe Indicator (some models) - Indicates that the probe is properly inserted into the probe receptacle in the oven.

Start - Press pad to complete an entry.

Temperature - Press pad to select cooking temperature.

Time - Press pad to set or change the time of day or the timer.

Timer – There are two timers - TIMER 1 AND TIMER 2; Each counts down the time in hours and minutes. With less than 60 minutes remaining, the timer also displays seconds. Press Time to access the timers.

Warming Drawer Indicator - Indicates that the warming drawer (some models) is on. Also displays the warming drawer setting.

You control the operation of the range by using the touch pads, dial and control knobs.

The touchpads, in conjunction with the dial, are used to select an oven mode, set the oven temperature, set the time(s) and to set up your range. To use the touchpad, press the center part of the pad with the flat part of your fingertip. A beep will sound to indicate that the selection has been made. Turn the dial to the desired setting and press START.

The knobs are used to control the heat level of the burners. Push down and turn to the ⚡ symbol to light and then to the desired heat setting.

See the sections on Using the Cooktop, Using the Oven and Using the Warming Drawer for detailed instructions.

The Clock

About the Clock

- Always set the clock after installation or after a power failure. Once power returns to the oven, the clock defaults to 12:00 am.
- The time of day is displayed in hours and minutes.
- The clock time will appear during all oven operations except when the timer is running.
- The oven is preset to a 12 hour clock and indicates AM and PM. To switch to a 24 hour clock, see "Select Function" section.
- If you do not complete the operation of setting the clock, the oven will beep periodically as a reminder to set the clock time. Press OFF to stop the beeping.

Setting the Clock

1. CLOCK will be displayed and the hour digits will flash. Turn knob to select hour and AM or PM.
2. Press TIME. CLOCK will still be displayed and the minute digits will flash.
3. Turn knob. Set minutes.
4. Press TIME and the clock is now set.



Note:

If operation is not completed, the oven will beep periodically as a reminder to set clock time. Press OFF.

Changing the Clock

1. Press TIME. TIMER 1 flashes in display.
2. Turn knob to select CLOCK.
3. Press TIME and hour digits flash.
4. Turn knob to change hours.
5. Press TIME again and minute digits flash.
6. Turn knob to change minutes.
7. Press TIME again and the clock is set.

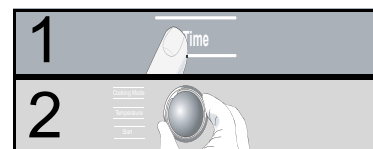

Note:

To cancel the TIME selection when setting the clock, press OFF anytime while in the clock mode.

The Select Functions Menu

SELECT FUNCTIONS is the section of the menu where you can set or change the range features listed below.

To access the SELECT FUNCTION menu

1. Press and hold COOKING MODE pad for five (5) seconds. SELECT FUNCTION is displayed.
2. Turn knob slowly to desired feature. There will be a slight delay before each message (or feature) can be seen in the display. Turn knob slowly and wait approximately one second for display to show next feature.
3. Press START to choose the function.
4. Turn knob to desired setting and press START. When all settings for the function are complete, SELECT FUNCTION flashes again.
5. Press OFF to exit the Select Functions Menu.



Change the Beep Volume

The volume of the control beep can be changed from LOW (softest) to HIGH (loudest). The control default for beep volume is Medium.

1. Access SELECT FUNCTIONS Menu.
2. Turn knob clockwise until VOLUME is displayed.
3. Press START.
4. Turn knob to select volume level Low, Medium or High.
5. Press START.



Change the Temperature Scale

The oven has been preset to the Fahrenheit temperature scale. The feature allows you to switch between Fahrenheit and Celsius temperature.

1. Access SELECT FUNCTIONS Menu.
2. Turn knob clockwise until SELECT TEMP F-C is displayed.
3. Press START.
4. Turn knob to select Fahrenheit (F) or Celsius (C).
5. Press START to accept new selection.



Turn Clock Display ON or OFF

Clock time display can be turned off. The default display is on.

1. Access SELECT FUNCTIONS Menu.
2. Turn knob clockwise until CLOCK DISPLAY is displayed.
3. Press START.
4. Turn knob to select ON or OFF
5. Press START to accept new selection.



Access Demo Mode

The demo mode is for appliance store use only.



Change the Display Language

Language choices are English, Spanish, and French. English is the default language.



Note:

The SELECT FUNCTIONS menu is displayed in English only, regardless of which language is selected.

1. Access SELECT FUNCTIONS Menu.
2. Turn knob clockwise until desired language is displayed.
3. Press START.
4. Turn knob clockwise to select a different language.
5. Press START to accept a language change.



Lock / Unlock the Oven Control Panel

The oven keypad can be locked for safety purposes. This feature can be used to prevent changes to the oven function. This function DOES NOT lock the oven door.

1. Access SELECT FUNCTIONS Menu.
2. Turn knob clockwise until LOCK KEYS is flashing.
3. Press START. KEY PAD LOCKED is displayed. The display will beep if a key is pressed to indicate that the keypad is locked.
4. To unlock keypads, press COOKING MODE and hold for 5 seconds. Display will read UNLOCKING KEY PAD.
5. When unlocked, the clock will again appear in the display.



Change the Oven Temperature Offset

This feature allows the adjustment of the oven temperature if food is consistently too brown or too light.

1. Access SELECT FUNCTIONS Menu.
2. Turn knob clockwise until OVEN TEMP OFFSET is displayed.
3. Press START. 0° F is displayed.

4. Turn the knob to the right to increase temperature to +25° F and to the left to decrease to -25° F. The temperature changes by 5° F increments.
5. Press START to accept a temperature change.



Reset the Factory Settings

This feature is used to change all the “Select Functions” settings back to the original factory settings (or defaults).

1. Access SELECT FUNCTIONS Menu.
2. Turn knob clockwise until RESET DEFAULTS is displayed.
3. Press START. Display reads SELECT FUNCTIONS.



Set the Sabbath Feature

About the Sabbath Feature

The Sabbath Feature enables those of particular faiths to use their ovens on the Sabbath.

- The oven will bake for 73 hours before automatically turning off.
- While baking in Sabbath mode, the display will show SABBATH and the BAKE icon will be displayed. The clock will be off and no temperature will show in the display.
- During the Sabbath mode, only the OFF key will operate. Press OFF at any-time during the Sabbath mode to end the mode and turn off the oven.
- At the end of 73 hours, the oven will turn off automatically and the display will show SABBATH END. Press OFF to return to time of day.
- The warming drawer does not operate with the Sabbath feature unless the feature is also activated in the oven.
- The probe CANNOT be used during the Sabbath mode.

Setting the Sabbath Feature for the Oven Only

1. Verify that the oven is turned off.
2. Access SELECT FUNCTIONS Menu.
3. Turn knob clockwise until SABBATH OPTION appears.
4. Press START. BAKE will show in display and temperature will flash.
5. Turn knob to set oven temperature.
6. Turn oven light on if desired (press LIGHT).



Note:

The light cannot be changed after this point. It will stay on or off, as selected, during the entire Sabbath mode.

7. Press START. Oven starts after 5 seconds.

The oven operates for 73 hours and then turns off automatically.

Setting the Sabbath Feature for both the Warming Drawer and the Oven



Note:

Warming drawer does not operate with the Sabbath feature unless the feature is also activated in the oven.

1. Turn the warming drawer on to the desired heat setting. See “Turning on the Warming Drawer” on page 28
2. Verify that the oven is turned off.
3. Access SELECT FUNCTIONS Menu.
4. Turn knob clockwise until SABBATH OPTION appears.
5. Press START. BAKE will show in display and temperature will flash.
6. Turn knob to set oven temperature.
7. Turn oven light on if desired (press LIGHT).



Note:

The light cannot be changed after this point. It will stay on or off, as selected, during the entire Sabbath mode.

8. Press START. Oven starts after 5 seconds. Sabbath Feature is activated for both the warming drawer and the oven.

The oven and warming drawer operate for 73 hours and then turn off automatically.

Setting the Sabbath Feature for the Warming Drawer Only

The warming drawer does not operate with the Sabbath feature unless the feature is also activated in the oven. See “Setting the Sabbath Feature for both the Warming Drawer and the Oven” on page 19.



Change the Time Format

The clock can be set to a 12 hour or 24 hour format. The default for clock format is 12 hour.

1. Access SELECT FUNCTIONS Menu.
2. Turn knob clockwise until TIME FORMAT is displayed.
3. Press START.
4. Turn knob to select 12 hour or 24 hour format.
5. Press START to accept new selection.



Turn Automatic Convection Conversion ON or OFF

This feature automatically converts package or recipe temperatures for use with the convection bake mode. The default setting is “on”.

1. Access SELECT FUNCTIONS Menu.
2. Turn knob clockwise until AUTO CONVECT BAKE is displayed.
3. Press START.
4. Turn knob to select ON or OFF.
5. Press START to accept new selection.

Before Using the Appliance for the First Time

- Remove all packing materials and labels from range. Remove packing materials from inside the oven and inside the drawer.
- While cool, wipe with a clean, damp sponge and dry.
- For models with a glass ceramic cooktop, apply the glass ceramic cooktop cleaner. Buff with a clean cloth. See “Cleaning and Maintenance” on page 40.
- There may be a slight odor during first uses; this is normal and will disappear.
- Read and understand all Safety Precautions and Use and Care Manual information prior to operating.

Operation - Cooktop

This section explains how to operate the cooktop. See “Getting the Most Out of Your Cooktop” on page 30 for guidelines to improve cooktop results.

About the Cooktop

Use the cooktop for surface cooking applications such as boiling, frying, simmering, steaming and sauteing.

Operation

Setting the Burner Heat Level

Burner Control Knobs (some models)

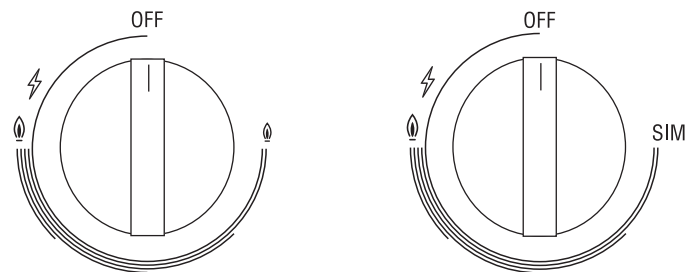

Figure 15: Burner Control Knobs (some models)

Lighting the Burner

Push in and turn the knob counterclockwise to the ⚡ symbol.



Note:

If the burner does not light within four seconds, turn the burner off. Verify that the burner cap is positioned correctly on the burner base and that the ignitor is clean and dry. If the burner still fails to ignite, see “Cooktop Troubleshooting Chart” on page 50.



CAUTION:

All ignitors spark when any single burner is turned on. Do not touch any of the burners when the cooktop is in use.

Failure to operate knobs properly may result in personal injury and damage to the appliance.



WARNING:

The burning of gas cooking fuel can create small amounts of Carbon Monoxide, Benzene, Formaldehyde and Soot. To minimize exposure to these substances the burners should be adjusted by a certified installer or agency to ensure proper combustion. Ensure proper ventilation with an open window or use a ventilation fan or hood when cooking with Gas. Always operate the unit according to the instructions in this manual.

Lighting the Burner during a Power Failure

Cooktop burners can be lit manually during a power failure. Hold a match at the port and turn the knob to the HI position. Wait until the flame is burning all the way around the burner before adjusting the flame to the desired setting.

Setting the Flame Size

After lighting, turn the knob counterclockwise to the desired flame size. See "Cooking Guide" on page 30 for recommended burner settings.



CAUTION:

To prevent possible burns, the flame should not extend beyond the edge of the cookware. This instruction is based on safety considerations. Damage to the cookware or the appliance may also result.

Turning the Burner off

Turn knob clockwise to the OFF position.



Note:

A "pop" may be heard when the burner is turned off. The "pop" may be louder with LP gas than with natural gas. This is normal.

Operation - Oven

This section explains how to operate the oven. See “Getting the Most Out of Your Oven” on page 31 for guidelines to improve oven results.

About the Oven

Operation



CAUTION:

Do not use aluminum foil or protective liners to line any part of an appliance, especially surface unit drip bowls or oven bottom. Installation of these liners may result in a risk of electric shock or fire.

Setting the Cooking Mode and Temperature



Note:

To back out of a current mode, press OFF. (Selecting OFF when not setting the cooking mode will turn the oven off.)

1. Press COOKING MODE.
2. SELECT COOK MODE will flash in the display.
3. Turn knob to display cooking mode.
4. BAKE will flash in the display.
5. If no change is made within 5 seconds, control will beep and flash. If this occurs, press START.
6. To change the cooking mode, turn knob.
7. Press START.
8. The selected mode will appear in the display, along with the default temperature for that mode, which will be blinking.
9. To select a different temperature, turn knob to the right or left (in 5° increments) to desired temperature.
10. Press START. If not pressed, oven automatically turns on in 5 seconds.
11. The display alternates between the cooking mode and preheat.



The preheated temperature is displayed, starting at 100°F. The actual temperature increases until set temperature is reached, at which point the oven will beep.

12. To change temperature during cooking, press TEMPERATURE. Turn the knob to select new temperature and press START.
13. Once cooking has been completed, press OFF to turn off oven.

Automatic Convection Conversion (models with convection bake)

In the convection bake mode, the temperature is automatically reduced 25° F from the package or recipe temperature. Simply enter the package or recipe temperature when setting the mode and the range calculates the correct temperature.

The Automatic Convection Conversion feature can be turned off to allow for manual temperature adjustment. See “Turn Automatic Convection Conversion ON or OFF” on page 20 for details.

When the Automatic Convection Conversion feature is activated, the display will read AUTO CONV BAKE. When the feature is turned off, it will read CONV BAKE.

Hot Oven Indicator

After the oven has been turned off, HOT appears in the display where the cooking mode was to indicate that the oven is off but still hot. When the oven temperature drops below 176° F, HOT is no longer seen in the display.



Using the Timer



Note:

- If you do not finish setting the timer, the oven will beep periodically as a reminder to set the time. Press OFF to exit the TIMER mode. (Selecting OFF when not setting the timer will turn the oven off.)
- Turn the knob to display the time of day or further information about the oven mode when the timers are in use.

To set the timer:

1. Press TIME and TIMER 1 will flash in display. 
2. Turn clockwise and TIMER 2 will be displayed. Select TIMER 1 or 2, then press TIME. SET TIMER 1 (2) appears in display. Minutes flash. 
3. Turn knob to set minutes. If setting only minutes, press START. Otherwise, continue to step 4. 
4. Press TIME again and the hours will flash.
5. Turn knob to set hours.
6. Press TIME again. The TIMER is now set.
7. If TIME or START is not pressed, oven will begin beeping and timer display will begin flashing.

Changing the Timer/s

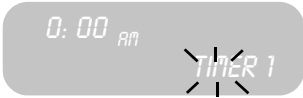
1. Press TIME. TIMER 1 will appear in display. Select either TIMER 1 or 2. 
2. Press TIME. RESET TIMER 1 (2) appears in the display. Minute digits flash.
3. Turn knob clockwise or counterclockwise to change minutes.
4. Press TIME again and hour digits will flash.
5. Turn knob clockwise or counterclockwise to change hours.
6. Press TIME and new time is set.

Clearing the Timer/s

1. Press TIME once. TIMER 1 flashes.
2. Turn knob to select CLEAR TIMER 1(2). Press TIME. 
3. If TIME pad is not pressed, range will beep and display will continue flashing.
4. Press TIME to return to the main screen.

Cancelling

If operation is not completed, the oven will beep periodically as a reminder to set time. Press OFF to exit the Timer mode. Selecting OFF when not in a setting mode will turn off the oven.

Using Timed or Delayed Cook

The TIMED COOK feature sets the oven to a cooking mode for a set period of time and then turns it off. The TIMED COOK feature is available for each of the following oven modes: Bake, Convection Bake and Convection Roast.

- Be sure that the time-of-day clock displays the correct time before beginning. See "Changing the Clock" on page 17 to adjust the time.
- At end of the programmed cooking time, the oven will automatically turn off.

- Delayed cooking is not recommended for foods that need to rise (i.e.; cookies, cakes, breads, souffles, etc.)

Setting a Timed Mode

1. Press COOKING MODE.
2. SELECT COOK MODE will be displayed.
3. Turn knob to display cooking mode.
4. BAKE will flash in the display. Turn knob to change the cooking mode.
5. Press START.
6. Turn knob to select desired temperature.



Note:

Time required for the oven to reach temperature must be included in the set cooking time.

7. Press TIME. TIMED BAKE appears.
8. Press TIME. SET BAKE TIME appears in the display and minutes flash.
9. Set minutes. Press TIME.
10. Hours Flash. Set hours. Press START.
11. TIMED BAKE appears in display and the oven begins to preheat.



After cooking is complete, display flashes TIME COOK END and reminder beeps will sound. Press OFF to clear.

Delaying the Start of a Timed Mode

1. Follow steps 1 through 7 above.
2. Turn knob until DELAYED BAKE appears.
3. Press TIME. SET BAKE TIME appears in display and minutes flash.
4. Set minutes and then press TIME. Hours Flash.
5. Set hours and then press TIME. SET BAKE END appears in the display.
6. Press TIME.
7. Use knob to enter the time of day the oven will stop cooking or turn off.
8. Set hours and then press TIME.
9. Set minutes and then press TIME.



Note:

The clock automatically calculates time of day at which cooking mode starts and stops. The displayed cooking time counts down by the minute.

10. At the end of the programmed cooking time, the oven will automatically turn off. Display will show TIME COOK END and reminder beeps will sound. Press OFF to clear.



Note:

Remove food from oven immediately after cycle has finished to prevent overcooking. Food left in the oven will cook even after the cycle is complete.

To Check the Cooking Time and Stop Time After a Delay Has Been Set

1. Press TIME.
2. Turn knob to BAKE END or BAKE TIME.
3. Press TIME.

Setting the Sabbath Feature

See "Set the Sabbath Feature" on page 19.

Using the Probe (some models)

This section explains how to operate the probe. See "The Probe (some models)" on page 32 for guidelines, tips and suggestions.

The probe can be used to determine the internal doneness or the “END” temperature of many foods, especially meats and poultry.

The temperature range for the probe is 135°F to 200°F (57°C to 93°C). Oven temperature can be set for 100°F up to 450°F (38°C up to 232°C).

Setting the Probe

1. Prepare meat and place in roasting pan (or on rack in roasting pan as recipe specifies). Insert the probe into the meat. See “Inserting the Probe” on page 32 for detailed instructions. Make sure the probe is not touching gristle, fat, bone, the roast rack or the pan.



Note:

Do not connect to probe receptacle until probe tip is properly inserted into meat.

2. Place roasting pan with meat in cold oven on recommended oven rack. Plug probe into the probe receptacle. The probe symbol will appear in display.



Note:

The probe temperature can only be set when the probe is installed in the oven.

3. Press COOKING MODE then rotate knob to select BAKE, CONVECTION BAKE or CONVECTION ROAST.
4. Press START. The default oven temperature will appear.
5. Turn knob to change oven temperature if necessary.
6. Touch START.
7. Turn knob to set the probe temperature (desired end temperature of the food).
8. Press START.

The chosen oven temperature is displayed in the upper right hand corner of the display.

The probe temperature is displayed in the center to the left of the cooking mode. It starts at 80 degrees and increases in 5°F increments until the chosen probe temperature is reached.

The oven is preheated when the beep signals once.

When the set probe temperature is reached, END appears in display and oven turns off.

Changing the Oven Temperature When Using the Probe

1. Touch TEMPERATURE. Oven temp will flash in the display.
2. Turn the knob to desired temperature and press START twice.

Changing the Probe Temperature

1. Touch TEMPERATURE. The oven temperature will flash.
2. Press START and PROBE TEMP will flash.
3. Turn the knob to desired temperature and press START again.



Note:

Always remove probe from oven when cooking is complete. The probe symbol will remain in the display until the probe is removed. Do not leave probe attachment in oven during self-clean. Oven will not self-clean with the probe installed in the oven

Operation - Warming Drawer (some models)

This section explains how to operate the warming drawer. See “Getting the Most Out of Your Warming Drawer” on page 38 for guidelines to improve warming drawer results.

About the Warming Drawer

The warming drawer will keep hot, cooked foods at serving temperature. Warming drawer settings are Low, Medium, and High.

Warming Drawer Specifications

Parts Key:

1. Stainless Steel Drawer Interior
2. Gasket
3. Rail Lock

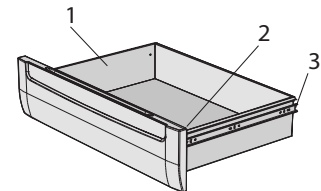

Figure 16: Warming Drawer Parts

Drawer Interior: 25" W x 17" D x 5" H

Dish sizes:

- 2 -9 x 13" Pyrex 3-quart dishes, side by side.
- 2 -9 1/2 x 15" Pyrex 4-quart dishes, side by side.
- 4 -10 1/2" plates, single or stacked
- 3 -11" plates, single or stacked

Warming Drawer Settings: The warming drawer has three settings: Low, Medium and High. These icons are seen in the display when the corresponding setting is selected:

For recommended settings, see “Warming Drawer Chart” on page 39.

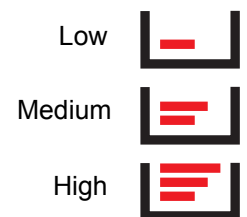

Figure 17: Warming Drawer Settings

Operation



CAUTION:

To maintain food safety, follow these guidelines:

- DO NOT use the warming drawer to heat cold food (exception: it is safe to use the drawer to crisp crackers, chips or dry cereal and to warm plates).
- Be sure to maintain proper food temperature. The USDA recommends holding hot food at 140°F or warmer.
- DO NOT warm food for longer than one hour.



CAUTION:

Plastic containers, plastic wrap or aluminum foil can melt if in direct contact with the drawer or a hot cooking container. If it melts onto the drawer, it may not be removable.

Preheating

For best results, preheat the warming drawer when warming food.

Preheat Times:

- Low: 10 minutes
- Medium: 15 minutes
- High: 20 minutes

Turning on the Warming Drawer

When Only Using the Warming Drawer

1. Press COOKING MODE.
2. SELECT COOK MODE will be displayed.
3. Turn knob to select WARMING DRAWER.
4. Press START.
5. Turn knob to select heat setting.
6. Press START.

When Also Using The Oven

1. Press COOKING MODE.
2. Press START to select WARMING DRAWER.
3. Turn knob to select heat setting.
4. Press START.

Setting the Sabbath Feature



Note:

The warming drawer does not operate with the Sabbath feature unless the feature is also activated in the oven. See "Setting the Sabbath Feature for both the Warming Drawer and the Oven" on page 19.

1. Turn the warming drawer on the desired heat level.
2. Activate the Sabbath Feature. See "Set the Sabbath Feature" on page 19.

Turning Off the Warming Drawer

When Only Using the Warming Drawer

1. Press OFF.

When Using the Warming Drawer and the Oven

1. Press OFF.
2. Turn knob to select CANCEL DRWR, CANCEL OVEN, or CANCEL BOTH.
3. Press OFF.

Crisping Stale Items

- Place food in low sided dishes or pans.
- Preheat on Low.
- Check crispness after 45 minutes. Add time as needed.

Warming Empty Serving Bowls and Plates

- Use only heat-safe dishes.
- Warm on setting appropriate for cooking container.
- Check dish temperature during warming period.
- Place empty plates or dishes in a cold warming drawer. Do not preheat drawer prior to placing dishes.

Getting the Most Out of Your Appliance

Getting the Most Out of Your Cooktop

Cooktop Cooking Guide

Boiling Water

Time to boil can vary greatly depending on environmental conditions. Try the following tips to decrease boil time:

- Use a lid.
- Use a pan that is appropriately sized for the amount of water and the size of the burner.
- Select a pan with a flat base (See “Cookware Selection Guide” on page 30 for details).
- Choose a medium-weight pan (rather than a heavy-weight one).
- Start with water that is already warm.
- Boil the smallest amount of water necessary. Smaller volumes will boil faster than larger volumes.

Recommended Settings

Use this chart as a guide for heat settings. A range of heat settings are listed because the actual setting depends on:

- type and quality of pan (See “Selecting Cookware”),
- type, quantity and temperature of the food,
- burner used and
- the cook’s preference.

Table 3: Cooking Guide

Uses	Heat Settings
Bringing water to boil	9 - High
Pan frying, sautéing, browning meat, deep fat frying	6-8 - Med-High
Most frying, eggs, pancakes, slow boil	4-5 - Med
Simmering, finish cooking, covered foods, steaming	2-3 - Med Low
Melting butter and chocolate	1 - Low

Cookware Selection Guide

Cookware Characteristics

Pan selection directly affects cooking speed and uniformity. For best results select pans with flat bases. When a pan is hot, the base (pan bottom) should rest evenly on the surface without wobbling (rocking). Flat, medium-to-heavy-weight pans are best.

To Test the Flatness of Your Pans

Turn the pan upside down on the countertop and place a ruler flat against the bottom of the pan. The bottom of the pan and the straight edge of the ruler should be flush against each other.



Another simple test to determine even heat distribution across the cookware bottom is to place 1" (25.4 mm) of water in the pan. Bring the water to a boil and observe the location of the bubbles as the water starts to boil. Good, flat cookware will have an even distribution of bubbles over the bottom surface area.

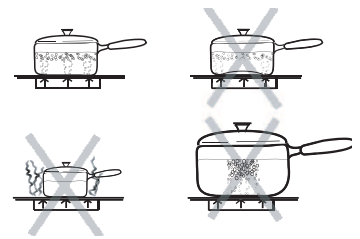

Match Pan Diameter to Flame Size

The flame should be the same size as the bottom of the pan or smaller. Do not use small pans with high flame settings as the flames can lick up the sides of the pan.

Place oversized pans that span two burners front to rear, not side to side.

Tight Fitting Lids – A lid shortens cooking/boiling time by holding heat inside the pot.

Cookware Tips

- Use of pots and pans with rounded (either concave or convex) warped or dented bottoms should be avoided. See drawings.
- Make sure the bottom of the pot or pan being used is clean and dry.
- Use pots and pans with thick, smooth metal bottoms.

Specialty Pans

Specialty pans such as griddles, roasters, pressure cookers, woks, water bath canners and pressure canners must have the same features as described above. Use only a flat-bottomed wok.

Getting the Most Out of Your Oven

Oven Cooking Guide

Rack Position

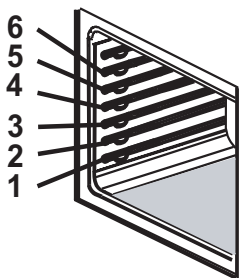

- RACK POSITION 6 (highest position) – melting cheese, broiling thin foods
- RACK POSITION 5 – broiling most meats, toasting bread
- RACK POSITION 4 – broiling thicker meats
- RACK POSITION 3 – most baked goods when baking on one rack, such as on cookie sheet or baking pan, cakes, frozen foods, biscuits, brownies, muffins
- RACK POSITION 2 – Used for pies, casseroles, breads, bundt or pound cakes, small roasts or poultry.
- RACK POSITION 1 (lowest position) – Used for angel food cake, large roasts, turkey.

Figure 18: Rack Positions

Multiple Rack Cooking

When using multiple racks, follow the placement recommendations below.

- **Two rack:** Use rack positions 2 and 5.
- **Three rack:** (for convection bake): Use positions 1, 3 and 6. The rack in position 3 can be extension rack if desired.

Pan Placement

Baking results are better if pans are placed in the center of the oven. If baking more than one pan on a rack, allow at least 1" to 1 ½" of air space around the pan. When baking four cake layers at the same time, stagger pans on two racks so that one pan is not directly above the other. To allow for best baking results stagger pans as shown in the graphic below.

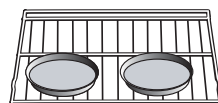

Pan placement on one rack

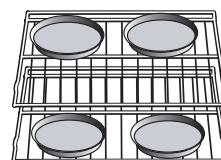

Pan placement on two racks

Figure 19: Pan Placement

Baking Pans

Here are some tips for cooking with baking pans:

- Glass baking dishes absorb heat, therefore reduce oven temperature 25°F when baking in glass.
- Shiny, smooth metal reflects heat resulting in lighter, more delicate browning.
- Dark, rough or dull pans will absorb heat resulting in browner, crisper crust. Some manufacturers recommend reducing temperature 25° F when using these pans. Follow manufacturer recommendations.
- Use glass or dark metal pans for pies.
- Insulated baking pans may increase the recommended baking time.

Preheating the Oven

Preheat the oven if the recipe recommends it. Preheating is necessary for good results when baking cakes, cookies, pastry and breads. Setting a higher temperature does not shorten preheat time. Place oven racks in proper position before preheating. A beep will confirm that oven is preheated and selected oven temperature will be displayed.



Note:

Preheating the oven is not recommended when using the probe (some models). A hot oven will impair your ability to easily connect the probe to the receptacle and to insert it into the meat.

The Probe (some models)

- The oven is well insulated and the retained heat will continue to cook the meat after the oven has shut off. For this reason, remove the meat from the oven as soon as the control beeps.
- Since meat continues to cook after being removed from the oven, set the internal (probe) temperature 5 - 10 degrees below the desired final internal temperature (exception: poultry). Allow standing time (10 -20 minutes) before carving the meat.
- Always use the handle of the probe for inserting and removing. Use a potholder to remove since the probe becomes hot.
- Remove the probe from the oven when it is not being used.
- The probe cannot be used with frozen meats. For best results, completely thaw meats before using the probe.

Inserting the Probe

- For meats, insert the probe tip into the thickest part and do not touch bone, fat, or gristle.
- For large poultry products and turkeys, insert the probe in the thickest part of the inner thigh.
- For other foods, such as a meatloaf, the probe tip should be located in the center of the thickest part of the food.

Oven Cooking Modes



Bake, Proof and Warm

Baking is cooking with dry, heated air. Both the upper and lower element cycle to maintain the oven temperature. Bake mode can be used to prepare foods like pastries and casseroles as well as to roast meats.

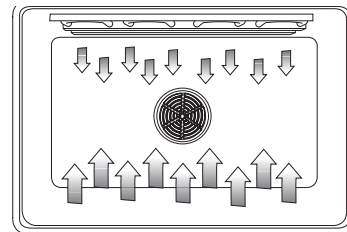

Note:

Depending on the model, you may hear the convection fan while the oven is preheating for the bake mode. This is normal.

In the Proofing mode, the oven will use the upper and lower element to maintain a low temperature to proof bread.

- Proofing is the rising of a yeast dough.
- The Proofing mode temperatures are 85° to 110° F. The default temperature is 100° F.
- Loosely cover the bowl or pan and use any rack that accommodates the size of the container.
- Keep the door closed and use the oven light to check the rising of the dough.

In Warming mode, the upper and lower elements maintain a low temperature in the oven cavity in order to keep food at serving temperature.

- Use the Warming setting on the oven to keep foods hot until ready to serve.
- Warming mode temperatures are 140° - 220° F. Default temperature is 170°.
- Foods that must be kept moist should be covered with a lid or aluminum foil.



CAUTION:

When using Warm mode, follow these guidelines:

- Do not use the Warm Mode to heat cold food.
- Be sure to maintain proper food temperature. The USDA recommends holding hot food at 140°F or warmer.
- DO NOT warm food for longer than one hour.



Convection Bake

Convection baking is similar to baking. Heat comes from the lower heating element and a third element behind the backwall. The main difference in convection baking is that the heat is circulated throughout the oven by the convection fan.

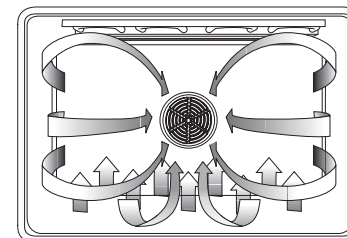

The Convection Bake mode is well-suited for baking large quantities of food on multiple racks. It can be used to prepare cookies, pies, cupcakes, pastries, breads, snack foods and appetizers among other items. The benefits of Convection Baking include:

- Slight decrease in cooking time
- Three rack cooking (more even browning)
- Higher Volume (yeast items rise higher)
- Ability to cook more items at once

For Best Results:

- Reduce recipe temperature by 25° F. Refer to Convection Baking chart.
- Place food in low-sided, uncovered pans such as cookie sheets without sides.
- Center baking pans side to side on the oven rack

Automatic Convection Conversion

In the convection bake mode, the temperature is automatically reduced 25° F from the package or recipe temperature. Simply enter the package or recipe temperature when setting the mode and the range calculates the correct temperature.

The Automatic Convection Conversion feature can be turned off to allow for manual temperature adjustment. See “Turn Automatic Convection Conversion ON or OFF” on page 20 for details.

When the Automatic Convection Conversion feature is activated, the display will read AUTO CONV BAKE. When the feature is turned off, it will read CONV BAKE.

Table 4: Convection Baking Chart

Food	Item	Rack Position	Temp. (°F) (preheated oven) ^a	Convection Bake Time (min.) ^b
Cake	Cupcakes	3	350	17-19
	Bundt Cake	2	350	37-43
	Angel Food	1	350	35-39
Pie	2 Crust, fresh, 9"	2	400-450	45-55
	2 Crust, frozen fruit, 9"	2	400	68-78
Cookies	Sugar	3	375-400	6-11
	Chocolate Chip	3	375-400	8-13
	Brownie	3	375	29-36
Breads	Yeast bread, loaf, 9x5	2	400	18-22
	Yeast rolls	3	400-425	12-15
	Quick bread, loaf, 8x4	2	375-400	45-55
	Biscuits	3	400-425	11-15
	Muffins	3	450	15-19
Pizza	Frozen	3	425-475	23-26
	Fresh	3	450-475	12-15

- This temperature must be manually reduced by 25° F if the Automatic Convection Conversion feature has been turned off.
- This chart is a guide. Actual times depend on the mixes or recipes baked. Follow recipe or package directions.

**Broil**

Broiling uses intense heat radiated from the upper element. The Broil mode is best suited to cooking thin, tender cuts of meat (1" or less), poultry and fish. It can also be used to brown breads and casseroles. Always broil with the door closed.

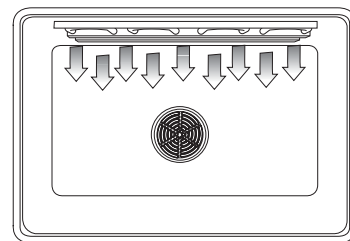

The benefits of Broiling include:

- Fast and efficient cooking
- Cooking without the addition of fats or liquids
- Browning as the food cooks

For Best Results:

- Preheat oven 3-4 minutes. Do not preheat for more than 5 minutes.
- Steaks and Chops should be at least 3/4" thick
- Brush fish and poultry with butter or oil to prevent sticking
- Use the broil pan and grid included with your range
- Do not cover the broiler grid with foil. It is designed to drain fats and oils away from the cooking surface to prevent smoking and spattering
- Turn meats once halfway through the recommended cooking time (see Broil Chart for examples).
- When top browning casseroles, use only metal or glass ceramic dishes such as Corningware®.
- Never use heat-proof glass (Pyrex®); they can't tolerate the high temperature.

Table 5: Broiling Chart

Food	Item / Thickness	Rack Position	Broil Setting	Internal Temp. (°F)	Time Side 1 (min.) ^a	Time Side 2 (min.) ^a
Beef	Steak (3/4"-1") Medium Rare	5	high	145	5-7	4-6
	Medium	5	high	160	6-8	5-7
	Well	5	high	170	7-9	6-8
	Hamburgers (3/4"-1") - Well	4	high	160	7-9	8-10
Poultry	Breast (bone in)	4	low	170	21-23	18-20
Pork	Pork chops (1")	4	high	160	6-8	4-6
	Sausage - fresh	3	high	160	5-7	4-6
	Ham slice (1/2")	5	high	160	2-4	2-3
Seafood	Fish filets (3/4"-1") buttered	5	low	Cook until opaque and flakes easily	9-11	Do Not Turn
Lamb	Chops (1") Medium rare	5	high	145	4-6	2-4
	Medium	5	high	160	5-7	4-6
	Well	5	high	170	6-8	5-7
Bread	Garlic bread slices (1")	5	high	N/A	2-4	Do Not Turn

a. Broiling times are approximate and may vary slightly, Times are based on cooking with a preheated broil element.

**Convection Broil (some models)**

Convection Broil is similar to Broil. It combines intense heat from the upper element with heat circulated by a convection fan. The Convection Broil mode is well suited for cooking thick, tender cuts of meat, poultry and fish. Convection Broil is typically not recommended for browning breads, casseroles and other foods.

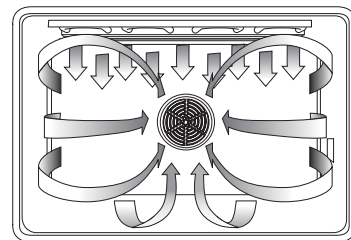

Always convection broil with the door closed. In addition to the benefits of standard broiling, convection broiling is faster than standard Broiling.



Note:
The only heat setting for the Convection Broil mode is High.

For Best Results:

- Preheat oven 3-4 minutes. Do not preheat more than 5 minutes.
- Meats should be at least 1 1/2" thick.
- Turn meats once halfway through the cooking time (See Convection Broil Chart for examples).
- Use the broil pan and grid included with your range.
- Do not cover the broiler grid with foil. It is designed to drain fats and oils away from the cooking surface to prevent smoking and spattering.
- Salt after cooking.

Table 6: Convection Broiling Chart

Food	Item / Thickness	Rack Position	Broil Setting	Internal Temp. (°F)	Time Side 1 (min.) ^a	Time Side 2 (min.) ^a
Beef	Steak (1 1/2" or more)	3	high	145	11-13	9-11
	Medium Rare					
	Medium					
	Well					
Hamburger (more than 1") - Well	4	high	160	11-13	8-10	
Poultry	Chicken quarters	4	high	180 - thigh 170 - breast	14-16	12-14
Pork	Pork chops (1 1/4" or more)	4	high	160	7-9	6-8
	Sausage - fresh	4	high	160	5-7	3-5

a. Convection broiling times are approximate and may vary slightly. Times are based on cooking with a pre-heated broil element.

**Convection Roast**

Convection Roast uses heat from the top and bottom elements as well as heat circulated by the convection fan. The Convection Roast mode is well suited to preparing tender cuts of meat and poultry.

The benefits of Convection Roasting, include:

- As much as 25% faster cooking than standard Roasting/ Baking
- Rich, golden browning

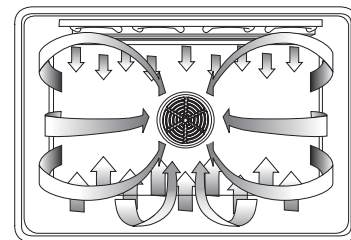
**For Best Results:**

- Use the same temperature as indicated in the recipe.
- Check doneness early as roasting time may decrease by as much as 25%. Refer to Convection Roast Chart for examples.
- Do not cover meat or use cooking bags.
- Use the broil pan and grid provided with the range for roasting. A low-sided, uncovered pan can also be used.
- Use a meat thermometer to determine the internal temperature of the meat.
- If the meat is browned to your liking, but is not yet done, a small strip of foil can be placed over the meat to prevent overbrowning.
- Let meat stand covered with foil 10-15 minutes after removing from the oven.

Table 7: Convection Roast Chart

Meats	Item	Weight (lbs.)	Oven Temp. (°F)	Roasting Time ^a (min. per lb.)	Internal Temp. (°F)
Beef	Rib roast	4-6	325	25-32 28-32	145 (med/rare) 160 (medium)
	Rib eye roast (boneless)	4-6	325	24-32 27-32	145 (med/rare) 160 (medium)
	Rump, eye, tip, sirloin (boneless)	3-6	325	25-30 28-32	145 (med/rare) 160 (medium)
	Tenderloin roast	2-3	425	15-25	145 (med/rare)
Pork	Loin roast (boneless or bone in)	5-8	350	15-25	160
	Shoulder	3-6	350	20-30	160
Poultry	Chicken - whole	3-4	375	14-20	180
	Turkey - unstuffed ^b	12-15	325	10-14	180
	Turkey - unstuffed ^b	16-20	325	9-13	180
	Turkey - unstuffed ^b	21-25	325	6-10	180
	Turkey breast	3-8	325	20-25	170
	Cornish hen	1-1 1/2	350	45-75 (total time)	180
Lamb	Half leg	3-4	325	30-35 25-30	160 (medium) 170 (well)
	Whole leg	6-8	325	25-30 30-35	160 (medium) 170 (well)

a. Roasting times are approximate and may vary depending on the shape of the meat.

b. Stuffed turkey requires additional roasting time. The minimum safe temperature for stuffing in poultry is 165°F.



Dehydrate

The dehydrate mode dries with heat from a third element behind the back wall of the oven. The heat is circulated throughout the oven by the convection fan. Use dehydrate to dry and/or preserve foods such as fruits, vegetables and herbs. This mode holds an optimum low temperature (100° F - 160° F) while circulating the heated air to slowly remove moisture. The oven will stay on for 48 hours before shutting off automatically.

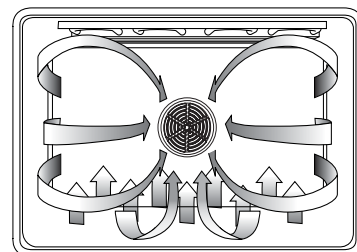

For Best Results:

- Dry most fruits and vegetables at 140° F. Dry herbs at 100° F. (Refer to the Dehydrate Chart for examples).
- Drying times vary depending on the moisture and sugar content of the food, the size of the pieces, the amount being dried and the humidity in the air. Check food at the minimum drying time.
- Multiple drying racks (not included) can be used simultaneously.
- Treat fruits with antioxidants to avoid discoloration.
- Consult a food preservation book, county Cooperative Extension Office or library for additional information.

Table 8: Dehydrate Chart

Food	Item	Preparation	Approx. Drying Time* (hours)	Test for Doneness
Fruit	Apples	Dipped in 1/4 cup lemon juice and 2 cups water; 1/4" slices	11-15	Slightly pliable
	Bananas	Dipped in 1/4 cup lemon juice and 2 cups water; 1/4" slices	10-15	Soft, pliable
	Cherries	Wash, towel dry. Fresh cherries, remove pits.	10-15	Pliable, leathery, chewable
	Orange peels/ slices	1/4" slices of orange; orange part of skin thinly peeled from oranges	Peels: 2-4 Slices: 12-16	Orange peel: dry and brittle. Orange slices: skins are dry, brittle, fruit is slightly moist
	Pineapple rings	Towel dried. Wash and towel dry. Sliced 1/2" thick, skin (outside) down on rack	Canned: 9-13 Fresh: 8-12 12-17	Soft and pliable
	Strawberries			Dry and brittle
Vegetables	Peppers	Wash and towel dry. Remove membrane of peppers, coarsely chopped about 1" pieces	16-20	Leathery with no moisture inside
	Mushrooms	Wash and towel dry. Cut stem end off.	7-12	Tough and leathery, dry
	Tomatoes	Cut into 1/8" slices. Wash and towel dry. Cut thin slices, 1/8" thick, drain well.	16-23	Dry, brick red color
Herbs	Oregano, sage, parsley, thyme, fennel	Rinse and dry with paper towel	Dry at 100°F for 3-5 hours	Crisp and brittle
	Basil	Use basil leaves 3 to 4 inches from top. Spray with water, shake off moisture and pat dry.	Dry at 100°F for 3-5 hours	Crisp and brittle

Getting the Most Out of Your Warming Drawer

General Tips

Refer to the Warming Drawer Chart for recommended settings.

- To keep several different foods hot, set the temperature for the food needing the highest setting.
- Place items needing the highest setting toward the side of the drawer and items needing less heat in the center of the drawer.
- Food should be at serving temperature (above 140° F) before being placed in the warming drawer. DO NOT use to heat cold food other than crisping crackers, chips, and dry cereal, or warming dishes or plates.
- Preheat empty serving dish while preheating drawer if desired.
- Place cooked, hot food in warming drawer in its original cooking container or in a heat-safe serving dish.
- Aluminum foil may be used to cover food; However, DO NOT line the warming drawer with aluminum foil.
- Do not use the warming drawer for storage.

Table 9: Warming Drawer Chart

Food	Temperature	Covered / Uncovered
Bacon	Hi	Uncovered
Beef, Medium and well done	Med	Covered
Beef, rare	Med	Covered
Bread, hard rolls	Med	Uncovered
Bread, soft rolls, coffee cakes	Med	Covered
Biscuits	Med	Covered
Casseroles	Med	Covered
Eggs	Med	Covered
Fish, seafood	Med	Covered
Fried foods	Hi	Uncovered
Gravy, cream sauces	Med	Covered
Ham	Med	Covered
Pancakes	Hi	Covered
Pies, one crust	Med	Covered
Pies, two crusts	Med	Uncovered
Pizza	Hi	Covered
Pork	Med	Covered
Potatoes, baked	Hi	Covered
Potatoes, mashed	Med	Covered
Poultry, roasted	Med	Covered
Vegetables	Med	Covered
Plates	Low	Uncovered
Plate of food	Med	Covered

Cleaning and Maintenance

Cleaning - Cooktop

**CAUTION:**

Do not clean the appliance while it is still hot. Some cleaners produce noxious fumes when applied to a hot surface. Wet clothes or sponges can cause burns from steam.

**CAUTION:**

All ignitors spark when any single burner is turned on. Do not touch any of the burners when the cooktop is in use.

Daily Cleaning

Wipe with a warm soapy water; Rinse and dry. After a spill or boilover, turn off the burner and allow the cooktop to cool. Clean around the burner and burner ports. Reassemble burner(s) and check for proper operation.

Additional Steps for Glass Ceramic Models:

Apply glass ceramic cooktop cleaner.

Cleaning Guidelines

Avoid these Cleaners

- Glass cleaners which contain ammonia or chlorine bleach. These ingredients may permanently etch or stain the cooktop.
- Caustic Cleaners
- Oven cleaners such as Easy Off® may etch the cooktop surface.
- Abrasive Cleaners
- Metal scouring pads and scrub sponges such as Scotch Brite® can scratch and/ or leave metal marks.
- Soap-filled scouring pads such as SOS® can scratch the surface.
- Powdery cleaners containing chlorine bleach can permanently stain cooktop
- Flammable cleaners such as lighter fluid or WD-40.

Table 10: Cooktop Cleaning Chart

Cooktop Part/Material	Suggested Technique(s)	Important Reminders
Burner Base / Matte Finish	<ul style="list-style-type: none">• Detergent and hot water; rinse and dry.• detergent-filled steel wool pads such as Brillo® or S.O.S.®. Rinse and dry.	<ul style="list-style-type: none">• Clean ports with a stiff nylon bristle toothbrush to clean port openings.• Do not scratch or gouge the port openings

Table 10: Cooktop Cleaning Chart

Cooktop Part/Material	Suggested Technique(s)	Important Reminders
Burner Cap and exterior finish / Porcelain Enamel	<ul style="list-style-type: none"> Hot sudsy water; rinse and dry thoroughly. Nonabrasive cleansers such as Fantastic® or Formula 409®. Mild abrasive cleansers such as Bon Ami®, Ajax®, Comet®. Liquid cleaners such as Soft Scrub®. 	<ul style="list-style-type: none"> Carefully reassemble the burner when finished. Verify that the burner cap is properly seated. Do not use a toothpick; it may break off. Acidic and sugar-laden spills deteriorate the porcelain enamel. Remove soil immediately. Do not use wet sponge or towel on hot porcelain. Do not soak burner caps. Do not wash in the dishwasher Always apply minimal pressure with abrasive cleaners. Never use oven cleaners, caustic cleaning agents or abrasive cleaning agents on exterior of range.
Control Knobs / Plastic	<ul style="list-style-type: none"> Hot sudsy water; rinse and dry immediately. 	<ul style="list-style-type: none"> To remove knobs, place in off position and pull straight out. Do not soak knobs. Do not force knobs onto valve shaft. Do not use abrasive scrubbers or cleansers, such as BonAmi®, Ajax®, or Comet®. They may permanently damage the finish.
Exterior Finish / Stainless Steel	<ul style="list-style-type: none"> Hot water and detergent Non-abrasive cleaners such as Fantastic® or Formula 409®. Rinse and dry immediately. Cleaner polish such as Stainless Steel Magic® to protect the finish from staining and pitting; enhances appearance. Hard water spots: Household white vinegar. Mild Abrasive Cleaners: Kleen King® stainless steel liquid cleaner, Cameo® aluminum & stainless steel cleaner, Bon Ami®. Heat discoloration: Bar Keepers Friend®. 	<ul style="list-style-type: none"> Stainless steel resists most food stains and pit marks providing the surface is kept clean and protected. Use clean, soft cloths, sponges or paper towels. Wipe area dry to avoid water marks. Never allow food stains or salt to remain on stainless steel for any length of time. Rub lightly in the direction of polish lines. Chlorine or chlorine compounds in some cleaners are corrosive to stainless steel. Check ingredients on label before using.
Grates / Matte Finish	<ul style="list-style-type: none"> Hot water and detergent. Rinse and dry immediately Nonabrasive cleaners such as Fantastic® or Formula 409®. Rinse and dry immediately. Mild abrasive cleaners such as Bon Ami® or Soft Scrub®. 	<ul style="list-style-type: none"> The grates are heavy; use care when lifting. Place on a protected surface. Blisters / crazing / chips are common due to the extreme temperatures on grate fingers and rapid temperatures changes. Acidic and sugar-laden spills deteriorate the enamel. Remove soil immediately Abrasive cleaners, used too vigorously or too often, can eventually mar the enamel.

Table 10: Cooktop Cleaning Chart

Cooktop Part/Material	Suggested Technique(s)	Important Reminders
Exterior Finish / Glass Ceramic	<ul style="list-style-type: none"> Apply a small amount of the glass ceramic cooktop cleaner. When dry, buff surface with a clean paper towel or cloth. Wipe off spatters with a clean, damp sponge or paper towel. Rinse and dry. Use white vinegar if smudge remains; rinse. For suggestions on how to clean hard to remove soil, see See “Cleaning Techniques for Stubborn Soil (Glass Ceramic Cooktop Models)” on page 42 	<ul style="list-style-type: none"> Wait until the surface has completely cooled before applying any type of cleaner. <p>Exception: Remove dry sugar, sugar syrup, tomato products and milk immediately with the razor blade scraper (See See “Cleaning Techniques for Stubborn Soil (Glass Ceramic Cooktop Models)” on page 42)</p>
Igniters / Ceramics	<ul style="list-style-type: none"> Carefully wipe with a cotton swab dampened with water, ammonia or a non-abrasive cleaner such as Formula 409®. Gently scrape soil off with a toothpick. 	<ul style="list-style-type: none"> Keep the ignitor ports clean for proper performance. It is necessary to clean these when there is a boilover or when the burner does not light even though the electronic ignitors click. A damp igniter will prevent burner from igniting. For proper burner performance, keep igniters clean and dry. Remove any lint that may remain after cleaning.

Table 11: Cleaning Techniques for Stubborn Soil (Glass Ceramic Cooktop Models)

Type of Soil	Possible Solution
Dry sugar, sugar syrup, milk or tomato spills. Melted plastic film or foil. All these items require immediate removal. Remove only these types of spills while the surface is hot using the razor blade scraper. Be sure to use a new, sharp razor in your scraper.	<ul style="list-style-type: none"> Remove pan and turn off the burner. Wearing an oven mitt, hold scraper at 30° angle, using care not to gouge or scratch the glass. Push soil off the heated area. After the surface has cooled, remove the residue and apply the glass ceramic cooktop cleaner.
Burned-on food soil, dark streaks, and specks	<ul style="list-style-type: none"> Soften by laying a damp paper towel or sponge on top of soil for about 30 minutes. Use a plastic scrubber and glass ceramic cooktop cleaner or use the razor blade scraper. Rinse and dry.
Greasy spatters	<ul style="list-style-type: none"> Use a soapy sponge or cloth to remove grease; rinse thoroughly and dry. Apply glass ceramic cooktop cleaner.
Hard Water Spots - Hot cooking liquids dripped on surface	<ul style="list-style-type: none"> The minerals in some water can be transferred onto the surface and cause stains. Use undiluted white vinegar, rinse and dry. Recondition with glass ceramic cooktop cleaner.
Surface scratches - Small scratches are to be expected on the glass surface, but do not affect cooking. In time, small scratches will become smoother and much less noticeable with daily use of the glass ceramic cooktop cleaner.	<ul style="list-style-type: none"> Apply glass ceramic cleaning creme before using to remove sand-like grains and grit such as salt and seasoning.

Using the Razor Blade Scraper (Glass Ceramic Cooktop Models)

Use the scraper on glass ceramic surfaces to remove dried or baked on foods.

Only use the scraper on glass ceramic surface. Never use it on other material (metal trim, grates, burners, etc.) as it could damage the surface.

Hold the scraper at a 30° angle. Move it over the soil to lift it off of the cooktop. Finish with a clean, damp sponge or paper towel. Apply white vinegar if smudge remains and rinse.

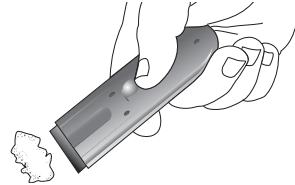

Figure 20: Scraper

Cleaning the Control Knobs

1. Pull out and off to remove each knobs. Wipe with hot, soapy cloth, rinse and dry. Do not soak.
2. To replace, push knob straight onto shaft.

Cleaning - Oven

Daily Cleaning

Daily cleaning of the inside of the oven is not necessary. When soil builds up, use the self-clean function as explain in “Self Cleaning the Oven” on page 44. See “Oven Cleaning Chart” on page 43 for instructions for specific surfaces and items.

Cleaning Guidelines

Avoid these cleaners

- Do not use caustic cleaners such as Easy Off®. They may etch the surface.
- Flammable cleaners such as lighter fluid or WD-40

Table 12: Oven Cleaning Chart

Part	Recommendations
Racks	Wash with hot sudsy water. Rinse thoroughly and dry, or gently rub with cleansing powder or soap filled pads as directed. If racks are cleaned in the oven during the self-clean mode, they will lose their shiny finish and may not glide smoothly. If this happens, wipe the rack edges with a small amount of vegetable oil, then wipe off excess.
Fiberglass Gasket	DO NOT HAND CLEAN GASKET.
Glass (other than cooktop)	Wash with soap and water or glass cleaner. Use Fantastik® or Formula 409® to remove grease spatters and stubborn stains.
Painted Surfaces	Clean with hot sudsy water or apply Fantastik® or Formula 409® to a clean sponge or paper towel and wipe clean. Avoid using powdered cleansers, steel wool pads and oven cleaners.
Porcelain Surfaces	Immediately wipe up acid spills like fruit juice, milk and tomatoes with a dry towel. Do not use a moistened sponge/towel on hot porcelain. When cool, clean with hot sudsy water or apply Bon-Ami® or Soft Scrub® to a damp sponge. Rinse and dry. For stubborn stains, use soap filled pads. It is normal for porcelain to show fine lines with age due to exposure to heat and food soil.

Table 12: Oven Cleaning Chart

Part	Recommendations
Stainless Surfaces	Always wipe or rub with grain. Clean with a soapy sponge then rinse and dry, or wipe with Fantastik® or Formula 409® sprayed onto a paper towel. Protect and polish with Stainless Steel Magic® and a soft cloth. Remove water spots with a cloth dampened with white vinegar. Use Bar Keeper's Friend® to remove heat discoloration.
Plastic & Controls	When cool, clean with soapy water, rinse and dry.

Self Cleaning the Oven

	<p>WARNING:</p> <ul style="list-style-type: none"> • During the elimination of soil during self-cleaning, small amounts of Carbon Monoxide can be created and the fiberglass insulation could give off very small amounts of formaldehyde during the first several cleaning cycles. To minimize exposure to these substances, provide good ventilation with an open window, or use a ventilation fan or hood. • Do not block the oven vents(s) during the self-cleaning cycle. Always operate the unit according to the instructions in the manual. • When self-cleaning, confirm that the door locks and will not open. If the door does not lock, stop self-clean operation and contact service.
---	--

The oven features a self-cleaning function that eliminates the manual labor involved with cleaning your oven. During self-cleaning, the oven uses a very high temperature to burn away food soil and grease.

- Do not clean parts or accessories in the self-clean oven.
- It is common to see smoke and/or an occasional flame-up during the Self-Clean cycle, depending on the content and amount of soil remaining in the oven. If a flame persists, turn off the oven and allow it to cool before opening the door to wipe up the excessive food soil.
- The oven door locks at the beginning of the self-clean cycle.
- The oven light does not operate during this mode.
- During Self-Clean, the kitchen should be well ventilated to help eliminate odors associated with Self-Clean. Odors will lessen with use.
- Four hours is the preset length of cleaning. The range can also be set to clean for 3 or 5 hours.
- The mode automatically stops at the end of the clean hours.
- When the oven cools after cleaning, the automatic door lock will release and the door can be opened.
- To cancel or stop while the mode is operating, press OFF.
- The door will not unlock until the oven reaches a safe temperature.

Preparing the Oven for Self Clean



WARNING:

A flexible door gasket is necessary for a good seal. Do not clean, rub, damage or move the gasket.

1. Remove all utensils and bakeware.

2. Remove oven racks. If oven racks are left in the oven during the self-clean cycle, they will permanently lose the shiny finish and change to a dull dark finish. See "Oven Cleaning Chart" on page 43 for proper care.
3. Wipe up excessive soil, spills and grease before self-cleaning the oven. Excess grease will cause flames and smoke inside the oven during self-cleaning.

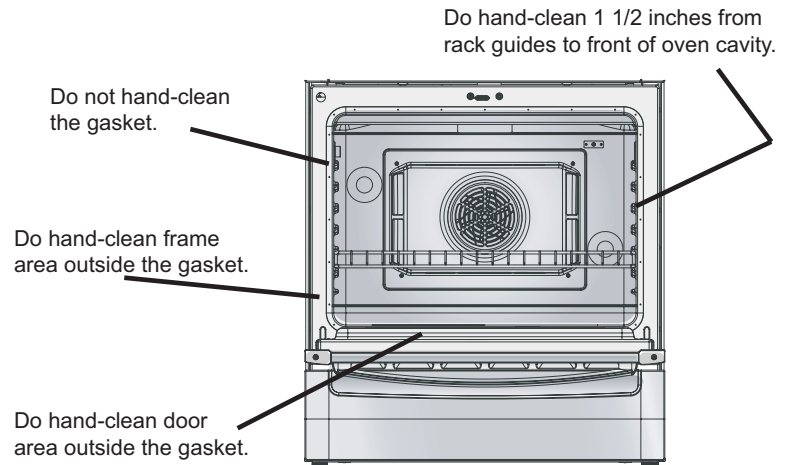

Figure 21: Cleaning Guidelines

4. Review illustration above. Some areas of the oven must be cleaned by hand before the cycle begins. Use a soapy sponge or plastic scrubber or a detergent-filled S.O.S.[®] pad. Hand-clean the oven door edge, oven front frame and up to 1-1/2 inches inside the frame with detergent and hot water. Do not clean or rub the gasket on the oven. The gasket is designed to hold in heat during the self-clean cycle. Rinse all areas thoroughly then dry.
5. Be sure oven light is turned off and the light bulbs and lens covers are in place. Do not operate oven without light bulb and cover in place.

Important: Do not use Commercial Oven Cleaners on the self-clean oven or any part because they will damage the finish or part.

Setting the Self-Clean Mode

1. Press COOKING MODE.
2. Turn knob until SELF CLEAN mode appears. Press START.
3. The default cleaning time is 4 hours. To change cleaning time, turn knob to change number of hours. Otherwise, continue to step 4.
4. Press START. SELF CLEAN flashes. Press START.
5. REMOVE RACKS appears in the display as a reminder to remove oven racks.
6. Press START again to begin the self-clean.



Note:

The door locks at the beginning of the cycle; The door lock symbol will appear in the display at this point. If door does not lock, press OFF and do not self-clean; phone service.



Note:

Delaying the Start of the Self-Clean

The time of day must be correctly set for this option to work properly. See section “Setting the Clock” in “Getting Started”.

1. Press COOKING MODE.
2. Turn knob until SELF CLEAN mode appears. Press START.
3. The default cleaning time is 4 hours. To change cleaning time, turn knob to change number of hours. Otherwise, continue to step 4.
4. Press START.
5. Turn knob until DELAYED CLEAN mode appears. Press START.
6. SELF CLEAN END appears in the display.
7. Turn knob to enter the time of day you want the self-clean to end: Set hours, press time, set minutes.
8. Press START. The display will remind you to remove oven racks.
9. Press START. The display shows DELAYED CLEAN. The self-clean will automatically start at the appropriate time.



Note:

In the Delayed Self-Clean Mode, the door latch automatically activates at the beginning of the cycle. The door lock symbol will appear in the display.



Note:

The oven lights do not operate in the Self-Clean mode.

After Self-Cleaning

1. At the end of the programmed cleaning time, the oven will automatically turn off. SELF CLEAN END appears in the display. Press OFF to clear.



Note:

The door will not unlock until the oven reaches a safe temperature.

2. The self-clean mode may produce ash which will settle in the bottom of the oven. If this happens, remove ash with a damp cloth before using the oven.
3. Wipe rack edges with cooking oil to allow for proper glide. Wipe off excess.

After self-cleaning, the entire oven can be safely cleaned with a soapy sponge, rinsed and dried. If stubborn soil remains, follow the guidelines on this page.

- Always use the mildest cleaner that will remove the soil.
- Rub metal finishes in the direction of the grain.
- Use clean, soft cloths, sponges or paper towels.
- Rinse thoroughly with a minimum of water so it does not drip into door slots.
- Dry to avoid water marks.

Cleaning - Drawers (Storage or Warming)

Daily Cleaning

Wash with hot soapy water, rinse and dry.

Maintenance

Cooktop Maintenance

Glass Ceramic Cooktop Models

- Regular, daily care using the glass ceramic cooktop cleaner will protect the surface and make it easier to remove food soil and water spots.
- The glass ceramic cooking surface is a durable material resistant to impact but not unbreakable if a pan or other object is dropped on it.
- Avoid placing a wok support ring, trivet or other metal stand on glass surface.

Stainless Steel Cooktop Models

No maintenance is required other than daily cleaning as described in “Cleaning Guidelines” on page 40.

Oven Maintenance

Removing the Oven Door



CAUTION:

When removing the door:

- Make sure oven is cool and power to the oven has been turned off before removing the door. Failure to do so could result in electrical shock or burns.
- The oven door is heavy and fragile. Use both hands to remove the oven door. The door front is glass. Handle carefully to avoid breaking.
- Grasp only the sides of the oven door. Do not grasp the handle as it may swing in your hand and cause damage or injury.
- Failure to grasp the oven door firmly and properly could result in personal injury or product damage.
- To avoid injury from hinge bracket snapping closed, be sure that both levers are securely in place before removing the door. Also, do not force door open or closed - the hinge could be damaged and injury could result.
- Do not lay removed door on sharp or pointed objects as this could break the glass. Lay on a flat, smooth surface, positioned so that the door cannot fall over.

To remove the oven door:

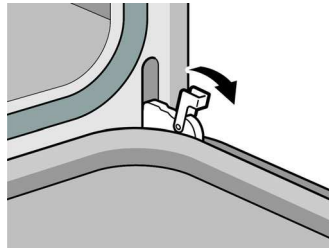

1. Be sure to read the above CAUTION before attempting to remove the door.
2. Open the door completely.
3. Flip levers on hinges toward you.

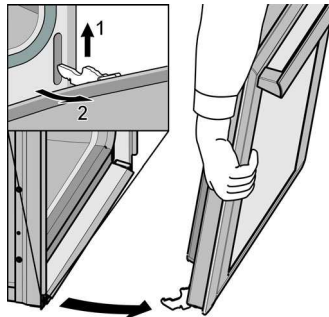

4. Holding the door firmly on both sides and using both hands, close the door gently until it stops against the levers, about 30° from the closed position.
5. Carefully lift the door up and out of the hinge slots. Hold firmly; the door is heavy.
6. Place the door in a convenient and stable location for cleaning.

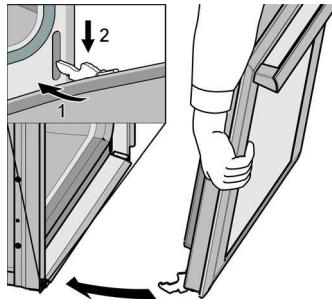
To replace the oven door:

1. Hold the door firmly in both hands.
2. Hold the door at a 30° angle from the closed position and insert hinges into the slots.
You may need to rock the door forward and backward slightly to seat the hinge feet.
3. The door may need to be removed and re-inserted until the hinges sit correctly in the slots.

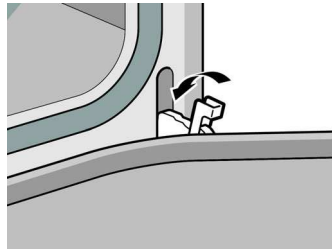

4. Open door all the way to expose hinges, levers, and slots.
5. Push levers forward and down until seated on the bracket.
6. Close and open door slowly to be sure it is correctly and securely in place. Door must be straight, not crooked.

Replacing an Oven Light

Each light assembly consists of a removable lens, a light bulb and a light socket housing that is fixed in place.

Light socket is live when door is open if main power supply is not turned off.

**WARNING:**

- Make sure the appliance and lights are cool and power to the appliance has been turned off before replacing the light bulb(s). Failure to do so could result in electrical shock or burns.
- The lenses (if equipped) must be in place when using the appliance.
- The lenses (if equipped) serve to protect the light bulb from breaking.
- The lenses (if equipped) are made of glass. Handle carefully to avoid breaking. Broken glass could cause an injury.
- Light socket is live when door is open

1. Read the WARNING above.
2. Turn off power at the main power supply (fuse or breaker box).
3. Remove the lens by unscrewing it.
4. Remove the light bulb from its socket by unscrewing it.
5. Replace the bulb with a new 40 watt appliance bulb. Avoid touching the bulb with fingers, as oils from hands can damage the bulb when it becomes hot.
6. Screw the lens back on.
7. Turn power back on at the main power supply (fuse or breaker box).

Service

Before Calling Service

Use these suggestions before calling for service to avoid service charges

Troubleshooting Charts

The Cooktop

Table 13: Cooktop Troubleshooting Chart

Cooktop Problem	Possible Causes and Suggested Solutions
Scraper is not working properly.	<ul style="list-style-type: none">The scraper blade is dull. The scraper is packaged with single-edge, stainless steel blades. Replace with a standard single-edge blade.
Cooking results are not what was expected.	<ul style="list-style-type: none">The cooktop is not level. Adjust leveling legs on bottom of range.Cooking pan is not the appropriate size or type. See "Cookware Selection Guide" on page 30.
Water takes too long to boil	<ul style="list-style-type: none">Time to boil can vary greatly depending on environmental conditions. See "Boiling Water" on page 30 for tips to decrease time to boil.
Burners click continuously	<ul style="list-style-type: none">Knob(s) are in the "light" position. Turn knobs to the "OFF" position or to desired flame setting.
Surface burners do not light	<ul style="list-style-type: none">Gas is turned off. Make sure the gas shut-off valve is in the ON position and the gas supply to the house is not shut off.Unit is not hooked up to the gas supply. Call gas company.Plug is not completely inserted into outlet or the house wiring is incorrect. Check the power supply, verify that the unit is grounded with the correct polarity, make sure the unit is plugged in.Circuit breaker is tripped. Check circuit breaker and reset if necessary. Check and/or replace fuse.Burner ports are clogged. Turn the cooktop off and allow the burners to cool. Remove burner caps and use a stiff nylon bristle toothbrush to push debris through burner ports.Misaligned burner cap. Verify that burner caps are properly positioned over burners.Ignitor is wet, damaged or dirty. Check ignitor for moisture. If wet, allow to air dry before using. Check for burned-on food or grease. See cleaning recommendations. Burner will not light if ignitor is wet, damaged or dirty.
Uneven or too high flame; burner is hard to light	<ul style="list-style-type: none">Burner ports are clogged. Turn the cooktop off and allow the burners to cool. Remove burner caps and use a stiff nylon bristle toothbrush to push debris through burner ports.Misaligned burner cap. Verify that burner caps are properly positioned over burners.Burner cap is wet. Turn off burner and allow to cool. Dry burner cap and base thoroughly.
Uneven flame - LP gas users	<ul style="list-style-type: none">Call service.

The Oven

Table 14: Oven Troubleshooting Chart

Oven Problem	Possible Causes and Suggested Solutions
The oven mode or temperature selected or the numbers selected do not appear in the display	The knob was turned too rapidly. Turn knob slower until correct wording or temperature appears. Review manual instructions when setting clock, timer, or Self-Clean.
Oven door is locked and will not release, even after cooling	Turn the oven off at the circuit breaker and wait 5 minutes. Turn breaker back on. The oven should reset itself and will be operable.
Oven is not heating	Check circuit breaker or fuse box to your house. Make sure there is proper electrical power to the oven. Be sure oven temperature has been selected.
Oven is not cooking evenly	Adjust oven calibration if necessary (see “Change the Oven Temperature Offset” on page 18). Refer to cooking charts for recommended rack position.
Baking results are not as expected	Refer to cooking charts for recommended rack position. Check “Getting the Most Out of Your Oven” on page 31 for tips and suggestions. Adjust oven calibration if necessary (see “Change the Oven Temperature Offset” on page 18).
Food takes longer to cook than expected	The oven is carefully calibrated to provide accurate results. However, the temperature can be offset if food is consistently too brown or too light. See “Change the Oven Temperature Offset” on page 18.
Food is overcooked	The oven is carefully calibrated to provide accurate results. However, the temperature can be offset if food is consistently too brown or too light. See “Change the Oven Temperature Offset” on page 18.
Convection Bake Results are not as Expected	If the Automatic Convection Conversion Feature is turned off, the temperature must be manually reduced by 25°F. If the feature is active, the temperature is automatically adjusted. See “Turn Automatic Convection Conversion ON or OFF” on page 20 for more information. Refer to cooking charts and tips for rack positions, cooking times and pan selection. Adjust oven calibration if necessary. See “Change the Oven Temperature Offset” on page 18.
Oven temperature is too hot or too cold	The oven thermostat needs adjustment. See Oven Temperature Offset on page 18.
Oven light is not working properly	Replace or reinsert the light bulb if loose or defective. Touching the bulb with fingers may cause the bulb to burn out.
Oven light will not turn off	Check for obstruction in oven door. Check to see if hinge is bent. When the Sabbath feature is activated, the oven light will stay on or off (as selected during set-up) during the entire Sabbath mode.
Cannot remove lens cover on light	There may be soil build-up around the lens cover. Wipe lens cover area with a clean dry towel prior to attempting to remove the lens cover.
Oven will not Self-Clean properly	Allow the oven to cool before running Self-Clean. Always wipe out loose soils or heavy spillovers before running Self-Clean. If oven is badly soiled, set oven for a five-hour Self-Clean. See “Preparing the Oven for Self Clean” on page 44.
Clock and timer are not working properly	Make sure there is electrical power to oven. See Clock and Timer sections on page 16.

Table 14: Oven Troubleshooting Chart

Oven Problem	Possible Causes and Suggested Solutions
Porcelain chips	When oven racks are removed and replaced, always tilt racks upward and do not force them to avoid chipping the porcelain.
"F" and a number appears in display and control beeps	This is a fault code. Press OFF to clear the display and stop beeping. Reset oven if necessary. If fault code remains and beep continues, record fault code, cancel oven and call authorized service technician.
With a new range there is a strong odor when oven is turned on	This is normal with a new range and will disappear after a few uses. Operating the self-clean cycle will also "burn-off" the smell more quickly.
Control does not react when the pad is touched	Be sure that pad is clean. Touch the center of the touchpad. Use the flat part of your finger.
Fan is running during modes that don't use convection	On some models, the convection fan will run while the oven is preheating for the bake mode. This is normal. Slide-in models also have a cooling fan that runs during every cooking mode.
Warm air or steam escapes from oven vent	It is normal to see or feel steam or warm air escaping from the oven vent. Do not block the vent.
Cooling fan runs after oven is turned off (Slide-in ranges only).	This is normal. When the oven has cooled to a pre-determined temperature, the cooling fan turns off.

How to Obtain Service or Parts

To reach a service representative, see the contact information at the front of the manual. Please be prepared with the information printed on your product data plate when calling.

Product Data Plate

The data plate shows the model and serial number. Refer to the data plate on the appliance when requesting service. It is located on the frame near the drawer. Open the drawer to view it.

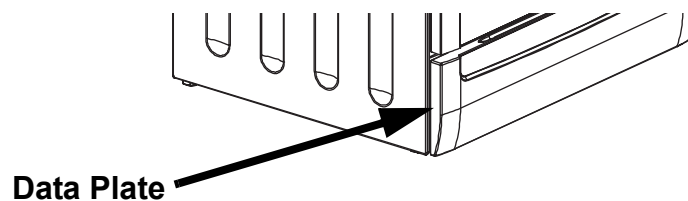

Figure 22: Data Plate

Warranty

What this Warranty Covers & Who it Applies to:

The limited warranty provided by BSH Home Appliances in this Statement of Limited Product Warranty applies only to the Bosch freestanding and slide-in range, ("Product") sold to you, the first using purchaser, provided that the Product was purchased: (1) for your normal, household (non-commercial) use, and has in fact at all times only been used for normal household purposes; (2) new at retail (not a display, "as is", or previously returned model), and not for resale, or commercial use; and (3) within the United States or Canada, and has at all times remained within the country of original purchase. The warranties stated herein apply only to the first purchaser of the Product and are not transferable. Bosch reserves the right to request proof of purchase at the time any warranty

claim is submitted to confirm that the Product falls within the scope of this limited product warranty.

Please make sure to return your registration card; while not necessary to effectuate warranty coverage, it is the best way for Bosch to notify you in the unlikely event of a safety notice or product recall.

How Long the Warranty Lasts:

Bosch warrants that the Product is free from defects in materials and workmanship for a period of three hundred sixty-five days (365) days from the date of purchase. The foregoing timeline begins to run upon the date of purchase, and shall not be stalled, tolled, extended, or suspended, for any reason whatsoever.

Repair/Replace as Your Exclusive Remedy:

During this warranty period, Bosch or one of its authorized service providers will repair your Product without charge to you (subject to certain limitations stated herein) if your Product proves to have been manufactured with a defect in materials or workmanship. If a reasonable number of attempts to repair the Product have been made without success, then Bosch will replace your Product (upgraded models may be available to you, in Bosch's sole discretion, for an additional charge). All removed parts and components shall become the property of Bosch at its sole option. All replaced and/or repaired parts shall assume the identity of the original part for purposes of this warranty and this warranty shall not be extended with respect to such parts. Bosch's sole liability and responsibility hereunder is to repair manufacturer-defective Product only, using a Bosch-authorized service provider during normal business hours. For safety and property damage concerns, Bosch highly recommends that you do not attempt to repair the Product yourself, or use an un-authorized servicer; Bosch will have no responsibility or liability for repairs or work performed by a non-authorized servicer. If you choose to have someone other than an authorized service provider work on your Product, THIS WARRANTY WILL AUTOMATICALLY BECOME NULL AND VOID. Authorized service providers are those persons or companies that have been specially trained on Bosch products, and who possess, in Bosch's opinion, a superior reputation for customer service and technical ability (note that they are *independent entities* and are *not* agents, partners, affiliates or representatives of Bosch). Notwithstanding the foregoing, Bosch will not incur any liability, or have responsibility, for the Product if it is located in a remote area (more than 100 miles from an authorized service provider) or is reasonably inaccessible, hazardous, threatening, or treacherous locale, surroundings, or environment; in any such event, if you request, Bosch would still pay for labor and parts and ship the parts to the nearest authorized service provider, but you would still be fully liable and responsible for any travel time or other special charges by the service company, assuming they agree to make the service call.

Out of Warranty Product:

Bosch is under no obligation, at law or otherwise, to provide you with any concessions, including repairs, pro-rates, or Product replacement, once this warranty has expired.

Warranty Exclusions:

The warranty coverage described herein excludes all defects or damage that are not the direct fault of Bosch, including without limitation, one or more of the following: (1) use of the Product in anything other than its normal, customary and intended manner (including without limitation, any form of commercial use, use or storage of an indoor product outdoors, use of the Product in conjunction with air or water-going vessels); (2) any party's willful misconduct, negligence, misuse, abuse, accidents, neglect, improper operation, failure to maintain, improper or negligent installation, tampering, failure to follow operating instructions, mishandling, unauthorized service (including self-performed "fixing" or exploration of the appliance's internal workings); (4) adjustment, alteration or modification of any kind; (5) a failure to comply with any applicable state, local, city, or county electrical, plumbing and/or building codes, regulations, or laws, including failure to install the product in strict conformity with local fire and build-

ing codes and regulations; (6) ordinary wear and tear, spills of food, liquid, grease accumulations, or other substances that accumulate on, in, or around the Product; and (7) any external, elemental and/or environmental forces and factors, including without limitation, rain, wind, sand, floods, fires, mud slides, freezing temperatures, excessive moisture or extended exposure to humidity, lightning, power surges, structural failures surrounding the appliance, and acts of God. In no event shall Bosch have any liability or responsibility whatsoever for damage to surrounding property, including cabinetry, floors, ceilings, and other structures or objects around the Product. Also excluded from this warranty are scratches, nicks, minor dents, and cosmetic damages on external surfaces and exposed parts; Products on which the serial numbers have been altered, defaced, or removed; service visits to teach you how to use the Product, or visits where there is nothing wrong with the Product; correction of installation problems (you are solely responsible for any structure and setting for the Product, including all electrical, plumbing or other connecting facilities, for proper foundation/flooring, and for any alterations including without limitation cabinetry, walls, floors, shelving, etc.); and resetting of breakers or fuses. TO THE EXTENT ALLOWED BY LAW, THIS WARRANTY SETS OUT YOUR EXCLUSIVE REMEDIES WITH RESPECT TO PRODUCT, WHETHER THE CLAIM ARISES IN CONTRACT OR TORT (INCLUDING STRICT LIABILITY, OR NEGLIGENCE) OR OTHERWISE. THIS WARRANTY IS IN LIEU OF ALL OTHER WARRANTIES, WHETHER EXPRESS OR IMPLIED. ANY WARRANTY IMPLIED BY LAW, WHETHER FOR MERCHANTABILITY OR FITNESS FOR A PARTICULAR PURPOSE, OR OTHERWISE, SHALL BE EFFECTIVE ONLY FOR THE PERIOD THAT THIS EXPRESS LIMITED WARRANTY IS EFFECTIVE. IN NO EVENT WILL THE MANUFACTURER BE LIABLE FOR CONSEQUENTIAL, SPECIAL, INCIDENTAL, INDIRECT, "BUSINESS LOSS", AND/OR PUNITIVE DAMAGES, LOSSES, OR EXPENSES, INCLUDING WITHOUT LIMITATION TIME AWAY FROM WORK, HOTELS AND/OR RESTAURANT MEALS, REMODELLING EXPENSES IN EXCESS OF DIRECT DAMAGES WHICH ARE DEFINITELY CAUSED EXCLUSIVELY BY BOSCH, OR OTHERWISE. SOME STATES DO NOT ALLOW THE EXCLUSION OR LIMITATION OF INCIDENTAL OR CONSEQUENTIAL DAMAGES, AND SOME STATES DO NOT ALLOW LIMITATIONS ON HOW LONG IMPLIED WARRANTY LASTS, SO THE ABOVE LIMITATIONS MAY NOT APPLY TO YOU. THIS WARRANTY GIVES YOU SPECIFIC LEGAL RIGHTS, AND YOU MAY ALSO HAVE OTHER RIGHTS, WHICH VARY FROM STATE TO STATE. No attempt to alter, modify or amend this warranty shall be effective unless authorized in writing by an officer of BSH.

How to Obtain Warranty Service:

To obtain warranty service for your Product, you should contact the nearest Bosch authorized service center.

BSH Home Appliances - 5551 McFadden Avenue, Huntington Beach, CA 92649 / 800-944-2904



BOSCH

Invented for life