



# REFRIGERATOR USER INSTRUCTIONS

THANK YOU for purchasing this high-quality product. Register your new refrigerator at [www.maytag.com](http://www.maytag.com). In Canada, register your refrigerator at [www.maytag.ca](http://www.maytag.ca).

For future reference, please make a note of your product model and serial numbers. These can be located on the inside wall of the refrigerator compartment.

Model Number \_\_\_\_\_ Serial Number \_\_\_\_\_

Para obtener acceso a "Instrucciones para el usuario del refrigerador" en español, o para obtener información adicional acerca de su producto, visite: [www.maytag.com](http://www.maytag.com).

Necesitará su número de modelo y de serie, ubicado en el interior del compartimiento del refrigerador.

## Table of Contents/Table des matières

<b>REFRIGERATOR SAFETY</b> .....	<b>2</b>	<b>SÉCURITÉ DU RÉFRIGÉRATEUR</b> .....	<b>20</b>
Proper Disposal of Your Old Refrigerator.....	3	Mise au rebut appropriée de votre vieux réfrigérateur.....	21
<b>INSTALLATION INSTRUCTIONS</b> .....	<b>3</b>	<b>INSTRUCTIONS D'INSTALLATION</b> .....	<b>21</b>
Unpack the Refrigerator.....	3	Déballage du réfrigérateur .....	21
Location Requirements.....	4	Exigences d'emplacement .....	22
Electrical Requirements .....	4	Spécifications électriques.....	22
Water Supply Requirements.....	4	Spécifications de l'alimentation en eau.....	23
Connect the Water Supply.....	5	Raccordement de la canalisation d'eau.....	23
Refrigerator Doors.....	6	Portes du réfrigérateur.....	24
Reversibility Kit Instructions.....	11	Instructions pour l'ensemble d'inversion du sens d'ouverture.....	30
Adjust the Doors .....	11	Ajustement des portes.....	30
<b>REFRIGERATOR USE</b> .....	<b>12</b>	<b>UTILISATION DU RÉFRIGÉRATEUR</b> .....	<b>31</b>
Using the Controls .....	12	Utilisation des commandes .....	31
<b>REFRIGERATOR FEATURES</b> .....	<b>13</b>	<b>CARACTÉRISTIQUES DU RÉFRIGÉRATEUR</b> .....	<b>32</b>
Refrigerator Shelves.....	13	Tablettes du réfrigérateur .....	32
Deli Drawer.....	13	Tiroir pour spécialités alimentaires .....	32
Crisper .....	13	Bac à légumes .....	32
<b>FREEZER FEATURES</b> .....	<b>14</b>	<b>CARACTÉRISTIQUES DU CONGÉLATEUR</b> .....	<b>33</b>
Freezer Shelf .....	14	Tablette du congélateur.....	33
<b>DOOR FEATURES</b> .....	<b>14</b>	<b>CARACTÉRISTIQUES DE LA PORTE</b> .....	<b>33</b>
Door Rails.....	14	Tringles de porte .....	33
Door Bins.....	14	Balconnets de porte .....	34
Utility Compartment .....	14	Compartiment utilitaire .....	34
Ice Maker.....	15	Machine à glaçons.....	34
<b>REFRIGERATOR CARE</b> .....	<b>15</b>	<b>ENTRETIEN DU RÉFRIGÉRATEUR</b> .....	<b>35</b>
Cleaning .....	15	Nettoyage.....	35
Changing the Light Bulb .....	16	Remplacement des ampoules d'éclairage.....	35
Vacation and Moving Care .....	16	Entretien avant les vacances ou lors d'un déménagement.....	36
<b>TROUBLESHOOTING</b> .....	<b>17</b>	<b>DÉPANNAGE</b> .....	<b>37</b>
Refrigerator Operation .....	17	Fonctionnement du réfrigérateur.....	37
Temperature and Moisture .....	18	Température et humidité .....	38
Ice and Water.....	18	Glaçons et eau.....	38
<b>ACCESSORIES</b> .....	<b>18</b>	<b>ACCESSOIRES</b> .....	<b>39</b>
<b>WARRANTY</b> .....	<b>19</b>	<b>GARANTIE</b> .....	<b>40</b>
<b>BRAND BADGE PLACEMENT TEMPLATE</b> .....	<b>BACK COVER</b>	<b>GABARIT DE POSITIONNEMENT DE L'INSIGNE DE LA MARQUE</b> .....	<b>COUVERTURE ARRIÈRE</b>

# REFRIGERATOR SAFETY

## Your safety and the safety of others are very important.

We have provided many important safety messages in this manual and on your appliance. Always read and obey all safety messages.



This is the safety alert symbol.

This symbol alerts you to potential hazards that can kill or hurt you and others.

All safety messages will follow the safety alert symbol and either the word "DANGER" or "WARNING."

These words mean:

**⚠ DANGER**

You can be killed or seriously injured if you don't immediately follow instructions.

**⚠ WARNING**

You can be killed or seriously injured if you don't follow instructions.

All safety messages will tell you what the potential hazard is, tell you how to reduce the chance of injury, and tell you what can happen if the instructions are not followed.

## IMPORTANT SAFETY INSTRUCTIONS

**WARNING:** To reduce the risk of fire, electric shock, or injury when using your refrigerator, follow these basic precautions:

- Plug into a grounded 3 prong outlet.
- Do not remove ground prong.
- Do not use an adapter.
- Do not use an extension cord.
- Disconnect power before servicing.
- Replace all parts and panels before operating.
- Remove doors from your old refrigerator.
- Connect to a potable water supply only.
- Use nonflammable cleaner.
- Keep flammable materials and vapors, such as gasoline, away from refrigerator.
- Use two or more people to move and install refrigerator.
- Disconnect power before installing ice maker (on ice maker kit ready models only).
- Use a sturdy glass when dispensing ice (on some models).
- Do not hit the refrigerator glass doors (on some models).
- This appliance is not intended for use by persons (including children) with reduced physical, sensory or mental capabilities, or lack of experience and knowledge, unless they have been given supervision or instruction concerning use of the appliance by a person responsible for their safety.
- Children should be supervised to ensure that they do not play with the appliance.

**SAVE THESE INSTRUCTIONS**

State of California Proposition 65 Warnings:

WARNING: This product contains one or more chemicals known to the State of California to cause cancer.

WARNING: This product contains one or more chemicals known to the State of California to cause birth defects or other reproductive harm.

## Proper Disposal of Your Old Refrigerator

### **! WARNING**

#### **Suffocation Hazard**

**Remove doors from your old refrigerator.**

**Failure to do so can result in death or brain damage.**

**IMPORTANT:** Child entrapment and suffocation are not problems of the past. Junked or abandoned refrigerators are still dangerous – even if they will sit for “just a few days.” If you are getting rid of your old refrigerator, please follow these instructions to help prevent accidents.

#### **Before You Throw Away Your Old Refrigerator or Freezer:**

- Take off the doors.
- Leave the shelves in place so that children may not easily climb inside.

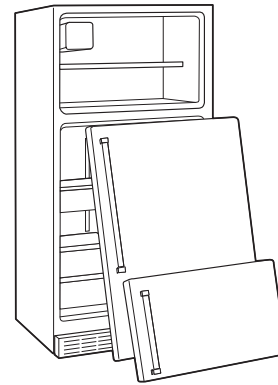

#### **Important information to know about disposal of refrigerants:**

Dispose of refrigerator in accordance with Federal and Local regulations. Refrigerants must be evacuated by a licensed, EPA certified refrigerant technician in accordance with established procedures.

## INSTALLATION INSTRUCTIONS

### Unpack the Refrigerator

### **! WARNING**

#### **Excessive Weight Hazard**

**Use two or more people to move and install refrigerator.**

**Failure to do so can result in back or other injury.**

#### **When Moving Your Refrigerator:**

Your refrigerator is heavy. When moving the refrigerator for cleaning or service, be sure to cover the floor with cardboard or hardboard to avoid floor damage. Always pull the refrigerator straight out when moving it. Do not wiggle or “walk” the refrigerator when trying to move it, as floor damage could occur.

#### **Remove the Packaging**

**IMPORTANT:** Do not remove the white foam air return insert from behind the control panel on the ceiling of the refrigerator. If the insert is removed, ice may migrate down from the freezer and cause icicles to form.

- Remove tape and glue residue from surfaces before turning on the refrigerator. Rub a small amount of liquid dish soap over the adhesive with your fingers. Rinse with warm water and dry with a soft cloth.
- Do not use sharp instruments, rubbing alcohol, flammable fluids, or abrasive cleaners to remove tape or glue. These products can damage the surface of your refrigerator. For more information see, “Refrigerator Safety.”

#### **Clean Before Using**

After you remove all of the package materials, clean the inside of your refrigerator before using it. See the cleaning instructions in “Refrigerator Care.”

#### **Important information to know about glass shelves and covers:**

Do not clean glass shelves or covers with warm water when they are cold. Shelves and covers may break if exposed to sudden temperature changes or impact, such as bumping. Tempered glass is designed to shatter into many small, pebble-size pieces. This is normal. Glass shelves and covers are heavy. Use both hands when removing them to avoid dropping.

## Location Requirements

### **⚠ WARNING**



#### Explosion Hazard

Keep flammable materials and vapors, such as gasoline, away from refrigerator.

Failure to do so can result in death, explosion, or fire.

**IMPORTANT:** This refrigerator is designed for indoor household use only.

To ensure proper ventilation for your refrigerator, allow for ½" (1.25 cm) of space on each side and at the top. Allow for 1" (2.54 cm) of space behind the refrigerator. If your refrigerator has an ice maker, allow extra space at the back for the water line connections. When installing your refrigerator next to a fixed wall, leave a 2" (5.08 cm) minimum space on the hinge side (some models require more) to allow the door to swing open.

**NOTE:** This refrigerator is intended for use in a location where the temperature ranges from a minimum of 55°F (13°C) to a maximum of 110°F (43°C). The preferred room temperature range for optimum performance, which reduces electricity usage and provides superior cooling, is between 60°F (15°C) and 90°F (32°C). It is recommended that you do not install the refrigerator near a heat source, such as an oven or radiator.

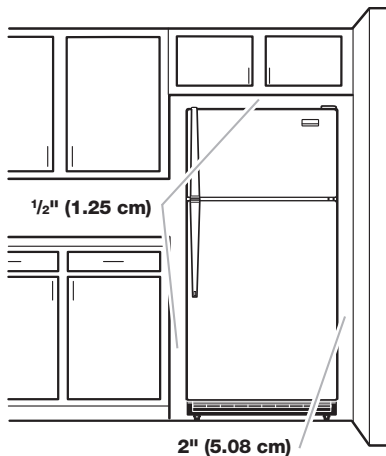

## Electrical Requirements

### **⚠ WARNING**



#### Electrical Shock Hazard

Plug into a grounded 3 prong outlet.

Do not remove ground prong.

Do not use an adapter.

Do not use an extension cord.

Failure to follow these instructions can result in death, fire, or electrical shock.

Before you move your refrigerator into its final location, it is important to make sure you have the proper electrical connection.

#### Recommended Grounding Method

A 115-volt, 60 Hz, AC-only, 15- or 20-amp fused, grounded electrical supply is required. It is recommended that a separate circuit serving only your refrigerator be provided. Use an outlet that cannot be turned off by a switch. Do not use an extension cord.

**NOTE:** Before performing any type of installation, cleaning, or removing a light bulb, turn cooling off or turn the control (Thermostat, Refrigerator, or Freezer control depending on the model) to OFF, and then disconnect the refrigerator from the electrical source. When you are finished, reconnect the refrigerator to the electrical source and turn cooling on or reset the control (Thermostat, Refrigerator, or Freezer control depending on the model) to the desired setting. See "Using the Controls" in the User Instructions, User Guide, or Use & Care Guide.

## Water Supply Requirements

Gather the required tools and parts before starting installation. Read and follow the instructions provided with any tools listed here.

#### TOOLS NEEDED:

- Flat-blade screwdriver
- ¼" nut driver
- 7/16" and ½" open-end or two adjustable wrenches
- ¼" drill bit
- Cordless drill

**NOTE:** Your refrigerator dealer has a kit available with a ¼" (6.35 mm) saddle-type shut-off valve, a union, and copper tubing. Before purchasing, make sure a saddle-type valve complies with your local plumbing codes. Do not use a piercing-type or 3/16" (4.76 mm) saddle valve which reduces water flow and clogs more easily.

#### IMPORTANT:

- All installations must meet local plumbing code requirements.
- Use copper tubing and check for leaks. Install copper tubing only in areas where the household temperatures will remain above freezing.

## Water Pressure

A cold water supply with water pressure of between 30 and 120 psi (207 and 827 kPa) is required to operate the water dispenser and ice maker. If you have questions about your water pressure, call a licensed, qualified plumber.

### Reverse Osmosis Water Supply

**IMPORTANT:** The pressure of the water supply coming out of a reverse osmosis system going to the water inlet valve of the refrigerator needs to be between 30 and 120 psi (207 and 827 kPa).

If a reverse osmosis water filtration system is connected to your cold water supply, the water pressure to the reverse osmosis system needs to be a minimum of 40 to 60 psi (276 to 414 kPa). If the water pressure to the reverse osmosis system is less than 40 to 60 psi (276 to 414 kPa):

- Check to see whether the sediment filter in the reverse osmosis system is blocked. Replace the filter if necessary.
- Allow the storage tank on the reverse osmosis system to refill after heavy usage.

If you have questions about your water pressure, call a licensed, qualified plumber.

## Connect the Water Supply

Read all directions before you begin.

**IMPORTANT:** If you turn the refrigerator on before the water line is connected, turn the ice maker off.

### Connect to Water Line

1. Unplug refrigerator or disconnect power.
2. Turn off main water supply. Turn on nearest faucet long enough to clear line of water.
3. Locate a ½" to 1¼" (1.25 cm to 3.18 cm) vertical cold water pipe near the refrigerator.  
**IMPORTANT:**
  - Make sure it is a cold water pipe.
  - Horizontal pipe will work, but drill on the top side of the pipe, not the bottom. This will help keep water away from the drill and normal sediment from collecting in the valve.
4. Determine the length of copper tubing you need. Measure from the connection on the lower-left rear of refrigerator to the water pipe. Add 7 ft (2.1 m) to allow for cleaning. Use ¼" (6.35 mm) O.D. (outside diameter) copper tubing. Be sure both ends of copper tubing are cut square.
5. Using a cordless drill, drill a ¼" hole in the cold water pipe you have selected.

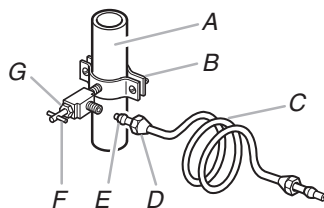

A. Cold water pipe  
B. Pipe clamp  
C. Copper tubing  
D. Compression nut  
E. Compression sleeve  
F. Shut-off valve  
G. Packing nut

6. Fasten the shut-off valve to the cold water pipe with the pipe clamp. Be sure the outlet end is solidly in the ¼" drilled hole in the water pipe and that the washer is under the pipe clamp. Tighten the packing nut. Tighten the pipe clamp screws slowly and evenly so washer makes a watertight seal. Do not overtighten or you may crush the copper tubing.

7. Slip the compression sleeve and compression nut on the copper tubing as shown. Insert the end of the tubing into the outlet end squarely as far as it will go. Screw compression nut onto outlet end with adjustable wrench. Do not overtighten.
8. Place the free end of the tubing in a container or sink and turn on the main water supply. Flush the tubing until water is clear. Turn off the shut-off valve on the water pipe. Coil the copper tubing.

### Connect to Refrigerator

1. Unplug refrigerator or disconnect power.
2. Attach the copper tubing to the valve inlet using a compression nut and sleeve as shown. Tighten the compression nut. Do not overtighten.
3. Use the tube clamp on the back of the refrigerator to secure the tubing to the refrigerator as shown. This will help avoid damage to the tubing when the refrigerator is pushed back against the wall.
4. Turn shut-off valve on.
5. Check for leaks. Tighten any connections (including connections at the valve) or nuts that leak.

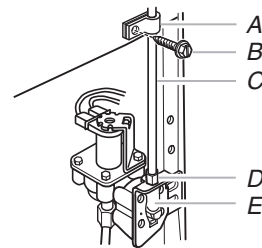

A. Tube clamp  
B. Tube clamp screw  
C. Copper tubing  
D. Compression nut  
E. Valve inlet

6. The ice maker is equipped with a built-in water strainer. If your water conditions require a second water strainer, install it in the ¼" (6.35 mm) water line at either tube connection. Obtain a water strainer from your nearest appliance dealer.

### Complete the Installation

## ⚠ WARNING



### Electrical Shock Hazard

**Plug into a grounded 3 prong outlet.**

**Do not remove ground prong.**

**Do not use an adapter.**

**Do not use an extension cord.**

**Failure to follow these instructions can result in death, fire, or electrical shock.**

1. Plug into a grounded 3 prong outlet.

**NOTE:** Allow 24 hours to produce the first batch of ice. Discard the first three batches of ice produced. Allow 3 days to completely fill ice container.

## Refrigerator Doors

Depending on the width of your doorway, you may need to remove the doors to move the refrigerator into your home. Also, the door hinges are factory installed on the right-hand side. If you want the door to open from the other direction, you must reverse the door swing.

### IMPORTANT:

- Before you begin, turn the refrigerator control off, unplug refrigerator or disconnect power. Remove food and any adjustable door or utility bins from doors.
- Depending on your model, your refrigerator has either **Style 1 – Contour Doors** or **Style 2 – Standard Doors**. Reference the graphic specific to your model later in this section following "Final Steps."

**NOTE:** A Reversibility Kit, which includes a new Brand Badge and hole covers, is available.

**Tools Needed:**  $\frac{5}{16}$ " hex-head socket wrench, #2 phillips screwdriver, flat-blade screwdriver,  $\frac{5}{16}$ " open-end wrench, flat 2" putty knife

6. Remove the washer from the bottom of the center hinge pin.
7. Lift the refrigerator door from the bottom hinge and set aside.
8. Using a hex-head socket wrench, remove the four  $\frac{5}{16}$ " hex-head hinge screws from the bottom hinge and pull the hinge from the bottom of the refrigerator door.

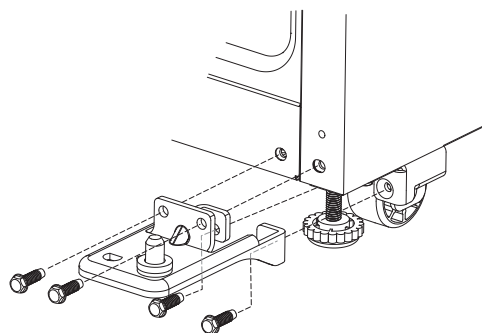

### Remove Doors and Hinges

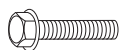

$\frac{5}{16}$ " Hex-head Hinge Screw

1. Unplug refrigerator or disconnect power.
  2. Using a hex-head socket wrench, remove the three  $\frac{5}{16}$ " hex-head hinge screws from the top hinge and lift up to remove the hinge. See Top Hinge graphic.
- NOTE:** Provide additional support for the doors while the hinges are being moved. Do not depend on the door magnets to hold the doors in place while you are working.
3. Lift the freezer door off of the center hinge and set it aside.
  4. Remove the washer from the top of the center hinge pin.

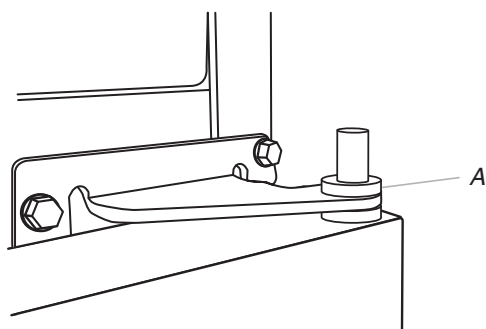

A. Washer

5. Using a hex-head socket wrench and an open-end wrench, remove the three screws from the center hinge and remove the hinge. Set aside.

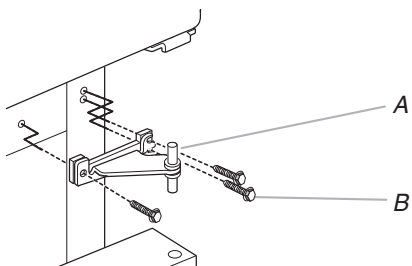

A. Center hinge  
B.  $\frac{5}{16}$ " hex-head hinge screws

### Reverse Doors and Hinges (optional)

**IMPORTANT:** If you want to reverse your doors so that they open in the opposite direction, follow these steps. If you are not reversing the doors, see "Replace Doors and Hinges."

See complete graphics later in these instructions.

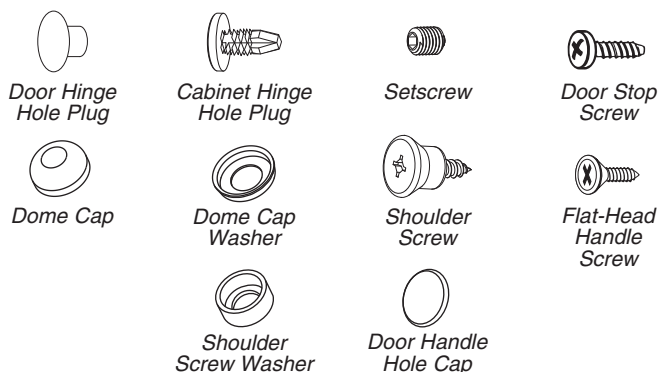

### Reverse Center Hinge

1. Remove the three dome caps and screws from the handle side and use them to fill the holes created when the hinge screws were removed.

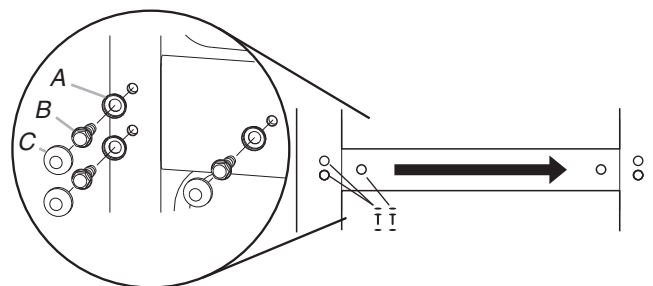

A. Dome cap washers  
B. Hex-head hinge screws

C. Dome caps

2. Using the three  $\frac{5}{16}$ " hex-head hinge screws, removed in Step 1, insert two screws halfway into the holes, leaving space to insert the center hinge.
3. Once the refrigerator door is in place, slide the center hinge from the right onto the screws, insert the third screw, and then tighten all screws completely.



**NOTE:** Make sure the washers are in place on both the top and bottom pins of the center hinge.

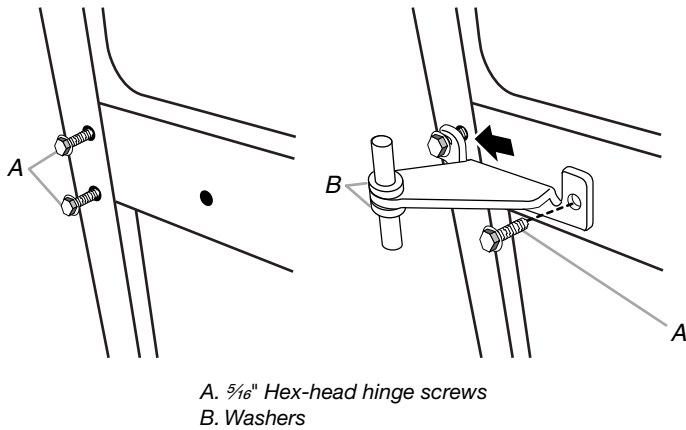

### Reverse Freezer Door

1. Remove the three cabinet hole plugs from the top of the cabinet and place them in the hinge holes on the opposite side.

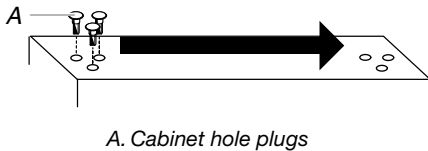

2. Remove the door handles.
  - Remove the two flat-head handle screws from the bottom of the freezer door handle.
  - Using the  $\frac{1}{8}$ " hex key, loosen the setscrew attaching the top of the handle.
  - Pull the handle away from the door to release it from the shoulder screw. Keep all parts together.

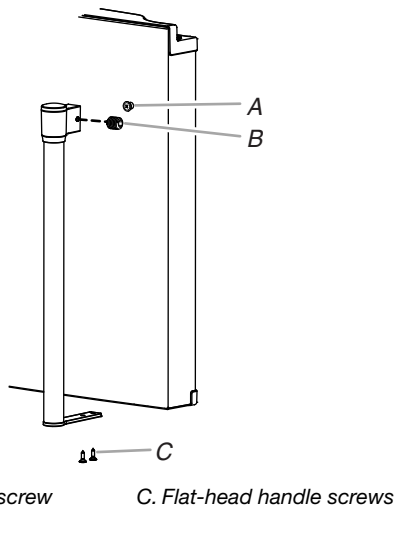

3. Using the plastic tool (provided), remove the brand badge from the freezer door by prying up the right-hand side and slowly peeling the badge away from the door, revealing the hole to mount the door handle.

#### NOTES:

- To avoid scratching the finish, do not use a sharp or metallic object to pry the brand badge from the door.
- Rub a small amount of liquid dish soap over any adhesive residue with your fingers. Rinse the door with warm water and dry with a soft cloth.

4. Remove the shoulder screw and its washer from the left-hand side of the door and fasten it into the hole that was behind the brand badge.
5. Remove the door stop from the bottom of the freezer door.

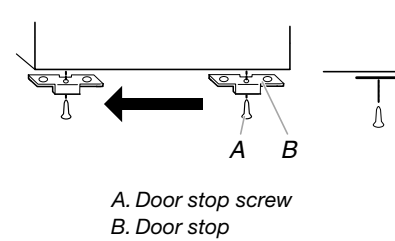

6. Move the door stop to the opposite side, making sure that the hole in the door stop plate is aligned perfectly with the hole for the center hinge pin.
7. Using the screw removed earlier, fasten the door stop to the bottom of the freezer door.

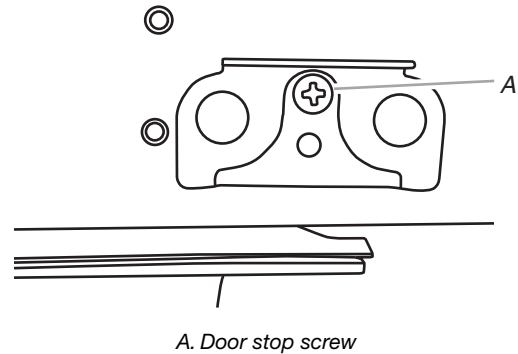

8. Place the handle on the shoulder screw and push the handle toward the door until the mounting base is flush against the door.
9. Fasten the bottom of the handle to the bottom of the freezer door.
10. Tighten all screws. Set aside the freezer door until the hinges and refrigerator door are in place.

### Reverse Refrigerator Door

1. Remove the door stop from the bottom of the refrigerator door.

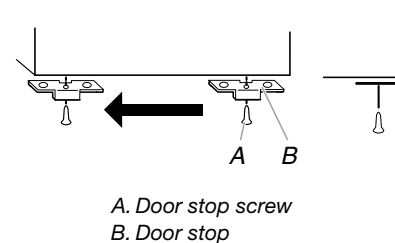

2. Replace the door stop on the opposite side of the refrigerator door, making sure that the hole in the door stop plate is aligned perfectly with the hole for the bottom hinge pin.
3. Fasten the door stop to the door.
4. Remove the door handles.
  - Remove the screws from the top of the refrigerator door handle.
  - Remove the setscrew from the lower part of the handle.
  - Pull the handle away from the door to release it from the shoulder screw. Keep all parts together.

- Remove the cap covering the hole on the opposite side of the door where the refrigerator door handle will be installed and discard the cap.

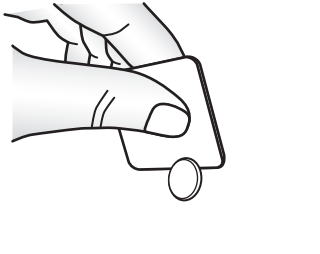

- Remove the shoulder screw and its washer from the left-hand side of the door and fasten it into the hole that was behind the cap.
- Place the handle on the shoulder screw and push the handle toward the door until the mounting base is flush against the door.
- Fasten the top of the refrigerator handle to the top of the refrigerator door.

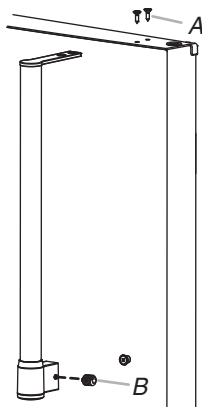

A. Flat-head handle screws  
B. Setscrew

- Cover the remaining hole with the cap (provided).



- Remove door hinge hole plug from the refrigerator door. Move to opposite side.
- Tighten all screws. Set aside refrigerator door until bottom hinge is installed on the opposite side of the refrigerator.

### Reverse Top Hinge - Contour door models only

- Remove the screw attaching the hinge pin to the hinge. Turn the hinge over so that it is pointing in the opposite direction.
- Place the plastic spacer beneath the hinge so that it will be between the hinge and the cabinet, making sure the holes are aligned.

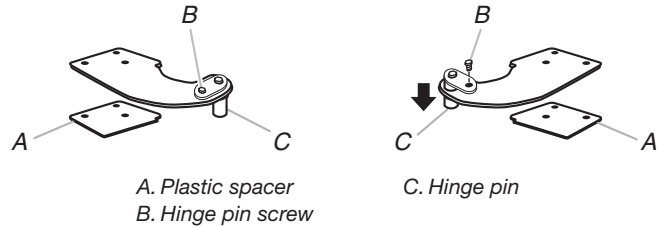

- Fasten the top hinge to the opposite side of the cabinet, inserting the screws only halfway, so you will be able to replace and align the freezer door later.

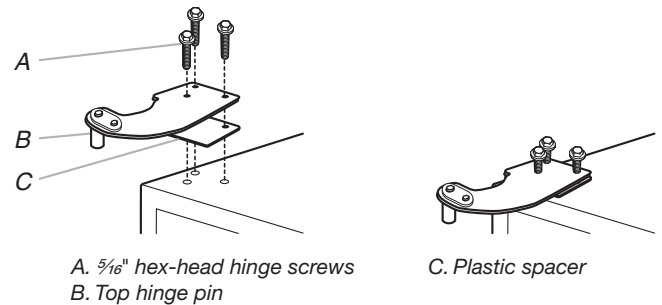

### Replace Doors and Hinges

**IMPORTANT:** Provide additional support for the doors while the hinges are being moved. Do not depend on the door magnets to hold the doors in place while you are working.

### Install Refrigerator Door

- Insert the hinge pin into the bottom hinge of the refrigerator door and fasten the hinge to the cabinet. Do not tighten completely.

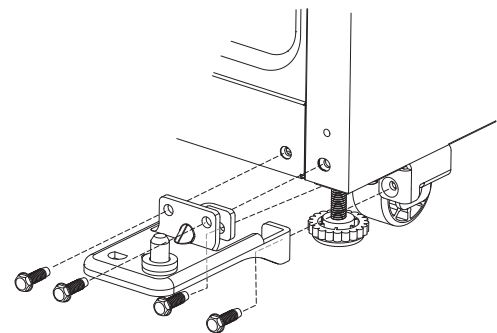

A. Bottom hinge

- Place the washer on top of the bottom hinge pin.
- Place the refrigerator door onto the bottom hinge pin.
- Measure the distance from the bottom of the refrigerator door to the floor. The distance should be approximately 1 1/2" (4.6 cm).

**NOTE:** If necessary, loosen the bottom hinge, without removing the screws, adjust the door to the correct height and fully tighten the screws.



## Install Freezer Door

1. Place washer on the upper hinge pin of the center hinge.
2. Place the freezer door on the upper hinge pin of the center hinge.
3. Insert the top hinge pin into the drilled hole in the top of the freezer door. Do not tighten the screws completely.
4. Align the doors so that the bottom of the freezer door aligns evenly with the top of the refrigerator door. Tighten all screws.  
**NOTE:** The distance between the doors should be approximately  $\frac{3}{4}$ " (19 mm).

## Style 1—Contour Door

### Door Removal & Replacement

#### Top Hinge

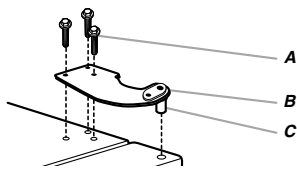

- A.  $\frac{5}{16}$ " Hex-Head Hinge Screws  
B. Top Hinge  
C. Hinge Pin

#### Center Hinge

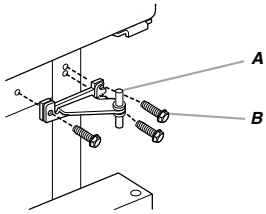

- A. Center Hinge  
B.  $\frac{5}{16}$ " Hex-Head Hinge Screws

#### Bottom Hinge

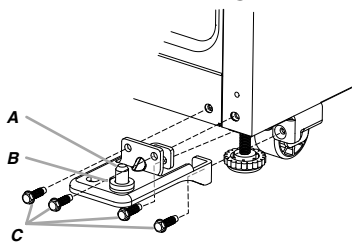

- A. Bottom Hinge  
B. Washer  
C.  $\frac{5}{16}$ " Hex-Head Hinge Screws

## Final Steps

1. Plug in the refrigerator or reconnect the power.
2. Reset the controls. See "Using the Controls."
3. Return all removable door parts to doors and food to refrigerator.

## Door Swing Reversal (optional)

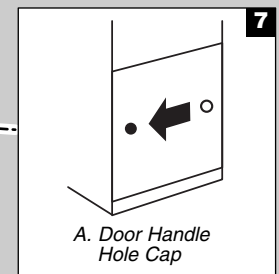
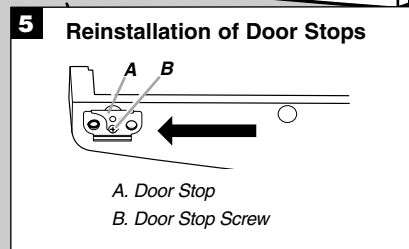
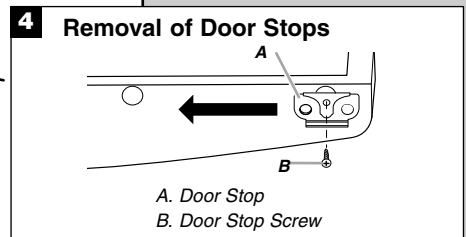
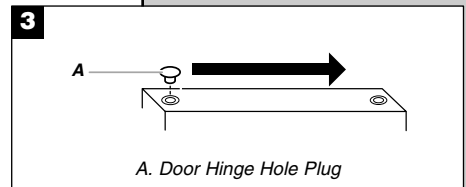
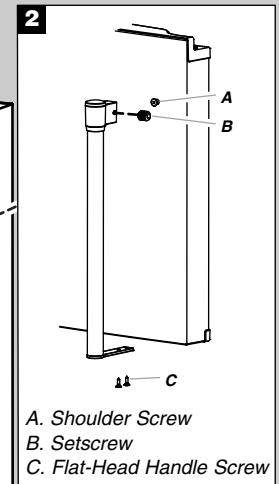
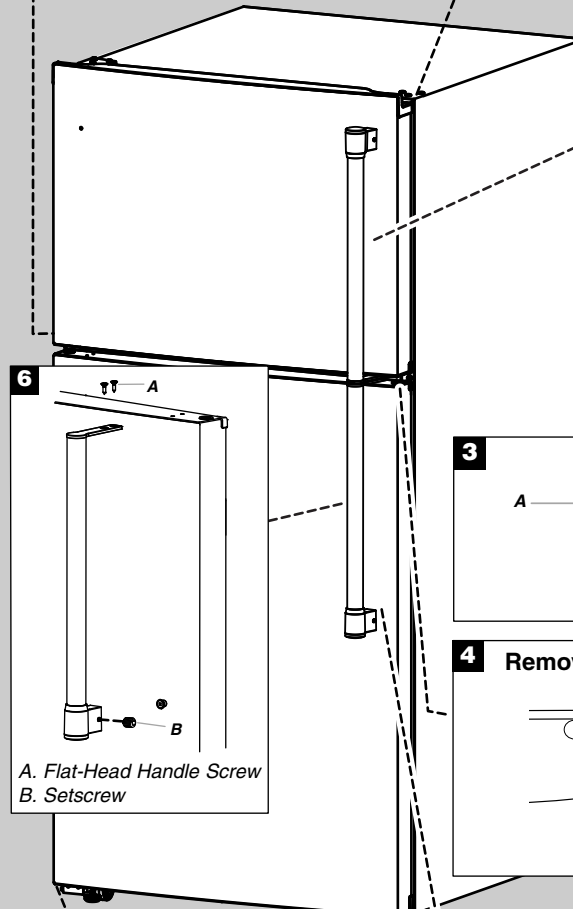
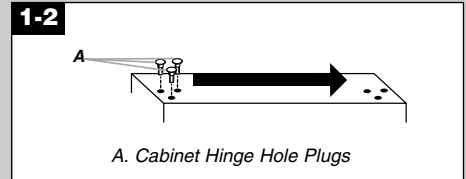
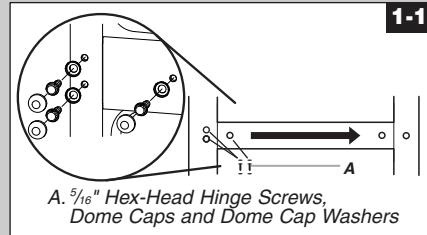

**Door Removal & Replacement**

**Top Hinge**

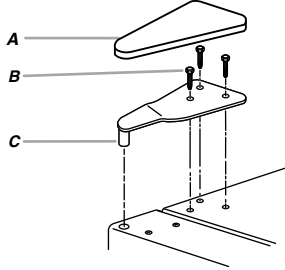

- A. Top Hinge Cover
- B. 5/16" Hex-Head Hinge Screws
- C. Top Hinge

**Center Hinge**

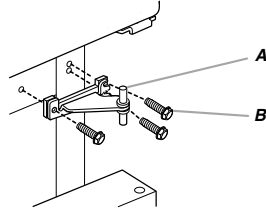

- A. Center Hinge
- B. 5/16" Hex-Head Hinge Screws

**Bottom Hinge**

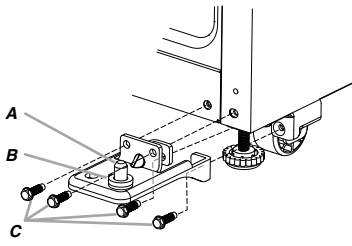

- A. Bottom Hinge
- B. Washer
- C. 5/16" Hex-Head Hinge Screws

**Door Swing Reversal (optional)**

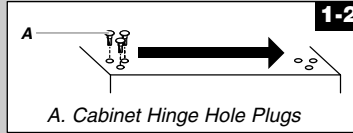

- A. Cabinet Hinge Hole Plugs

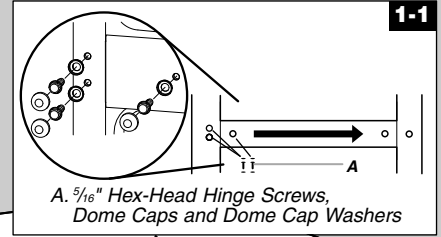

- A. 5/16" Hex-Head Hinge Screws, Dome Caps and Dome Cap Washers

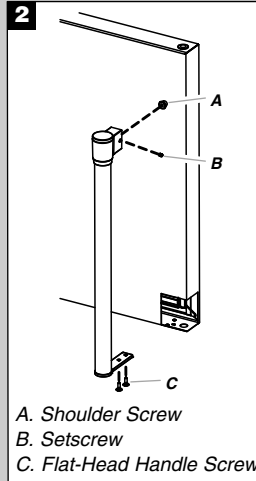

- A. Shoulder Screw
- B. Setscrew
- C. Flat-Head Handle Screw

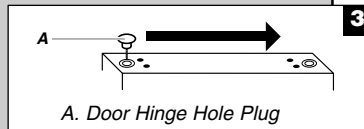

- A. Door Hinge Hole Plug

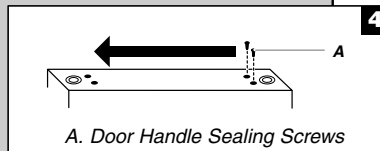

- A. Door Handle Sealing Screws

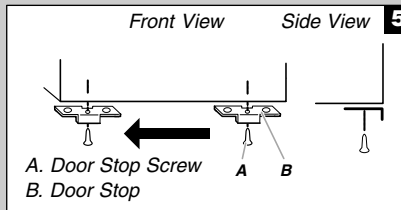

- A. Door Stop Screw
- B. Door Stop

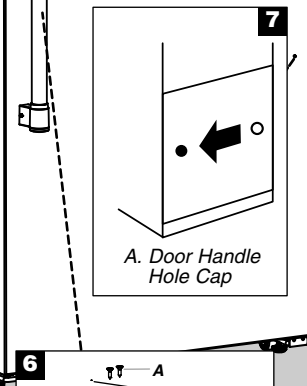

- A. Door Handle Hole Cap

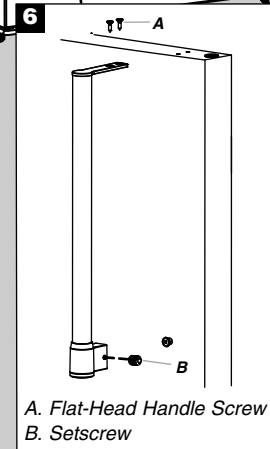

- A. Flat-Head Handle Screw
- B. Setscrew

---

## Reversibility Kit Instructions

If your model came with a Reversibility kit, please use the Brand Badge Placement template and the following instructions to install the Brand Badge on the opposite side of the freezer door.

### Parts Included:

Brand badge removal tool  
Brand badge template (on last page of User Instructions)  
Door handle hole cap

### Tools Needed:

Scissors  
Masking tape

### Freezer Door

1. Using the removal tool (provided), remove the brand badge from the freezer door by lifting up the right-hand side and peeling the badge away from the door from right to left.  
**NOTE:** To avoid scratching the door, do not use a sharp or metallic object to pry the brand badge from the door.
2. Rub a small amount of liquid dish soap over any adhesive residue with your fingers. Rinse the door with warm water and dry with a soft cloth.
3. Cut the template along the dotted lines that match the shape of the brand badge.
4. Align the edges of the template with the side and top of the freezer door and tape the template to the door.  
**NOTE:** When the template is correctly aligned, the hole in the door, where the handle was, will be within the cutout of the template, as shown.

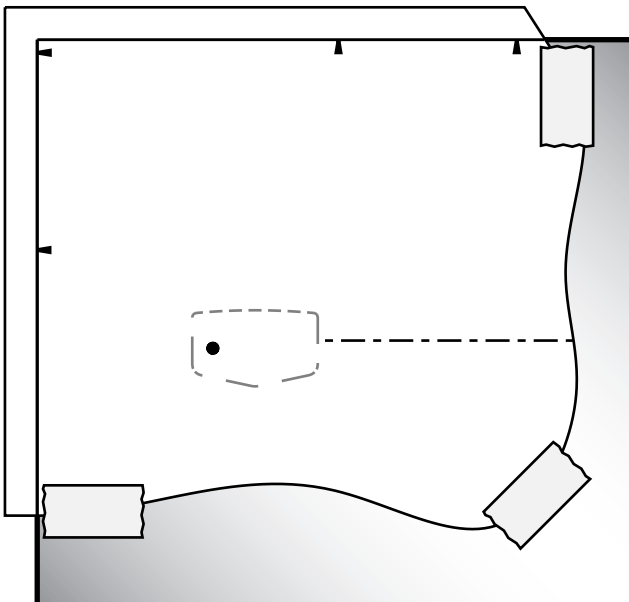

5. Using the cutout as a guide, press the brand badge onto the freezer door making sure that the hole is completely covered.
6. Slowly remove the template.

---

## Adjust the Doors

**IMPORTANT:** Your refrigerator complies with American Disabilities Act (ADA) guidelines.

---

### Door Closing

Your refrigerator has two front adjustable levelers - one on the right and one on the left. If your refrigerator seems unsteady or you want the doors to close easier, adjust the refrigerator's tilt using the following instructions:

1. Turn the leveler to lower or raise that side of the refrigerator. It may take several turns to adjust the tilt of the refrigerator.
  - To raise, turn the leveler to the right.
  - To lower, turn the leveler to the left.

**NOTE:** Having someone push against the top of the refrigerator takes some weight off the levelers and rollers which makes it easier to adjust.

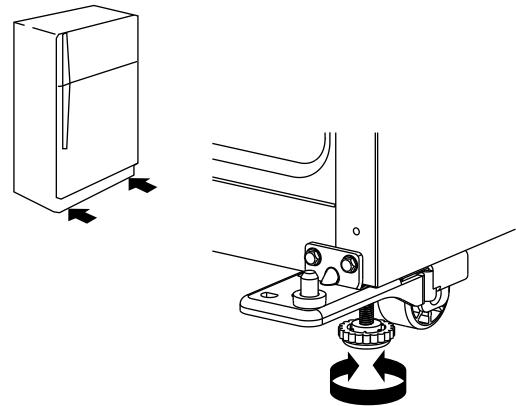

2. Open both doors again to make sure they close as easily as you like. If not, tilt the refrigerator slightly more to the rear by turning both leveling legs to the left; it may take several more turns.  
**NOTE:** To keep the refrigerator level, you should turn both leveling legs the same amount.
3. Using a level, be sure that the refrigerator is still level side to side. Readjust if necessary.

---

### Door Aligning

If the space between your doors looks uneven, you can adjust it using the following instructions:

1. Depending on your model, remove the top hinge cover.
2. Loosen the top hinge screws using a  $\frac{5}{16}$ " socket or wrench.
3. Have someone hold the door in place or put a spacer between the doors while you tighten the top hinge screws.
4. Replace the top hinge cover, if removed in Step 1.

# REFRIGERATOR USE

## Using the Controls

Your refrigerator has two controls that affect the temperature. The Temperature control is located at the top front of the refrigerator compartment and the Airflow control is located on the back wall of the freezer compartment.

### IMPORTANT:

- The recommended setting should be correct for normal household refrigerator use. The controls are set correctly when milk or juice is as cold as you like and when ice cream is firm.
- Wait 24 hours for your refrigerator to cool completely before adding food. If you add food before the refrigerator has cooled completely, your food may spoil.

**NOTE:** Adjusting the refrigerator and freezer temperature controls to a colder than recommended setting will not cool the compartments any faster.

- If the temperature is too warm or too cold in the refrigerator or freezer, first check the air vents to be sure they are not blocked before adjusting the controls.

### Temperature Control

For your convenience, the temperature control is preset at the factory. When you first install your refrigerator, make sure the control is still preset as shown.

#### Recommended Setting

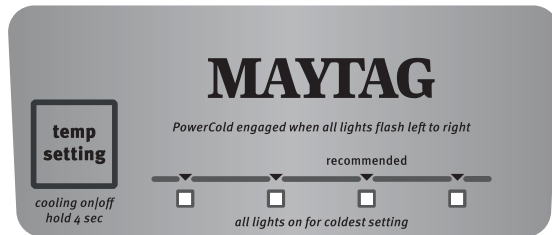

### Cooling Off/On

- To turn cooling off, press and hold TEMP SETTING for 4 seconds until all lights turn on for 1 second. To turn cooling back on, press and hold TEMP SETTING again for 4 seconds.

**NOTE:** Neither compartment will cool when the control is set to OFF.



Cooling On | Off  
Hold 4 sec

### Adjusting the Temperature Control

If you need to adjust the temperature in either the refrigerator or freezer compartment, use the settings listed in the following chart as a guide.

**NOTE:** Except when starting the refrigerator, do not adjust the control more than one setting at a time. Wait 24 hours between adjustments for the temperature to stabilize.

- Press TEMP SETTING to toggle between the four LED lights which indicate the temperature setting. Reading from left to right, the LED in the first position is the least cold. The LEDs indicate increasingly colder settings as you continue to the right until all four LEDs are illuminated.

**NOTE:** For the first to fourth setting, only one LED of the four LEDs will be lit. All four LEDs will be lit when you have reached the coldest setting.

CONDITION/REASON:	ADJUSTMENT:
REFRIGERATOR too warm	TEMP SETTING control one setting higher
FREEZER too warm/ Too little ice	AIRFLOW or TEMP SETTING control one setting higher
REFRIGERATOR too cold	TEMP SETTING control one setting lower
FREEZER too cold	AIRFLOW or TEMP SETTING control one setting lower

### Additional Feature

#### PowerCold® Feature

The PowerCold® feature sets the freezer and refrigerator to the lowest temperature settings to assist with periods of high refrigerator use, full grocery loads, or temporarily warm room temperatures.

- To turn on the PowerCold® feature, press TEMP SETTING continually until all the LED lights are blinking on/off progressively from left to right. Press TEMP SETTING again to return to the COLD set point.

**NOTE:** Depending on the environment conditions, the PowerCold® feature will remain activated up to 24 hours. When the feature turns off, the temperature will return to the recommended set point.

### Airflow Control

The Airflow control regulates the amount of air flowing between the freezer and the refrigerator compartments.

When you plug in the refrigerator for the first time, turn the Airflow control to the Recommended setting.

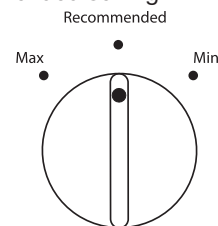

#### Adjusting the Airflow Control

If you want to temporarily increase the cold airflow to a specific compartment, adjust the control.

- Max - Increase airflow to the freezer.
- Min - Increase airflow to the refrigerator.

**IMPORTANT:** Once the performance is achieved, return the Airflow control to the Recommended setting to keep the refrigerator operating at optimum efficiency.

CONDITION/REASON:	ADJUSTMENT:
Heavy ice use	Max
Hot room temperature	Max - to maintain ice-making production rate
Large quantity of groceries	Min - to quickly chill food and beverages

# REFRIGERATOR FEATURES

Your model may have some or all of these features.

## Important information to know about glass shelves and covers:

Do not clean glass shelves or covers with warm water when they are cold. Shelves and covers may break if exposed to sudden temperature changes or impact, such as bumping. Tempered glass is designed to shatter into many small, pebble-size pieces. This is normal. Glass shelves and covers are heavy. Use both hands when removing them to avoid dropping.

## Refrigerator Shelves

The shelves in your refrigerator are adjustable to match your individual storage needs.

Storing similar food items together in your refrigerator and adjusting the shelves to fit different heights of items will make finding the exact item you want easier. It will also reduce the amount of time the refrigerator door is open, and save energy.

### To remove and replace a shelf:

1. Remove items from the shelf.
2. Slide the shelf straight out to the stop.
3. Depending on your model, lift back or front of the shelf past the stop. Slide shelf out the rest of the way.
4. Replace the shelf by sliding the back of the shelf into the track in the wall of the cabinet.
5. Guide the front of the shelf into the shelf track. Be sure to slide the shelf in all the way.

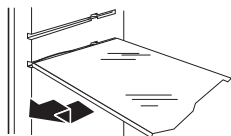

## Deli Drawer

The deli drawer design allows flexible positioning.

### Deli Drawer

#### To remove and replace the deli drawer:

1. Slide deli drawer out to the stop.
2. Lift front of deli drawer with one hand while supporting bottom of drawer with other hand. Slide drawer out the rest of the way.
3. Replace the drawer by sliding it back in fully past the drawer stop.

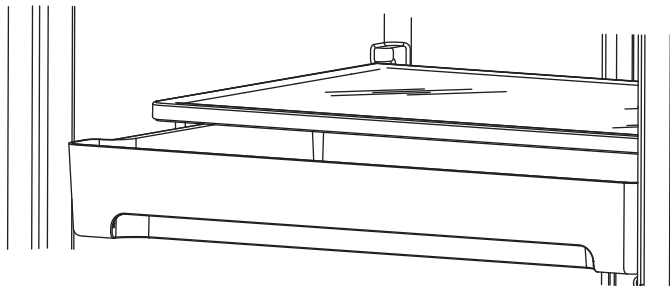

## Meat Storage Guide

Store most meat in original wrapping as long as it is airtight and moisture-proof. Rewrap if necessary. See the following chart for storage times. When storing meat longer than the times given, freeze the meat.

Fresh fish or shellfish..... Use same day as purchased  
Chicken, ground beef, variety meats (liver) ..... 1-2 days  
Cold cuts, steaks/roasts ..... 3-5 days  
Cured meats..... 7-10 days  
Leftovers - Cover leftovers with plastic wrap, aluminum foil, or plastic containers with tight lids.

## Crisper

### Crisper Drawers

#### To remove and replace the crisper drawer:

1. Slide the crisper drawer straight out to the stop. Lift the front and slide the drawer out the rest of the way.
2. Replace the drawer by sliding the drawer in fully past the stop.

### Crisper Cover

#### To remove and replace the crisper cover:

1. Remove the crisper(s).
2. Pull the glass straight out.
3. Replace the glass by pushing it straight in.

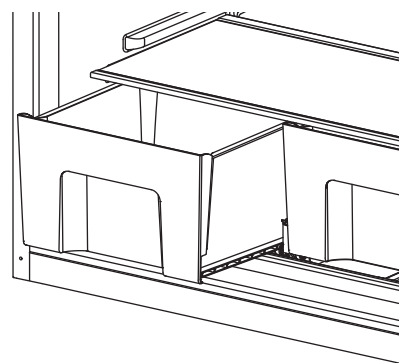

### Crisper Humidity Control

You can control the amount of humidity in the moisture-sealed crisper. Adjust the control to LOW or HIGH.

LOW (open) lets moist air out of the crisper for best storage of fruits and vegetables with skins.

- Fruit: Wash, let dry, and store in refrigerator in plastic bag or crisper. Do not wash or hull berries until they are ready to use. Sort and keep berries in original container in crisper or store in a loosely closed paper bag on a refrigerator shelf.

- Vegetables with skins: Place in plastic bag or plastic container and store in crisper.

HIGH (closed) keeps moist air in the crisper for best storage of fresh, leafy vegetables.

- Leafy vegetables: Wash in cold water, drain, and trim or tear off bruised and discolored areas. Place in plastic bag or plastic container and store in crisper.

## FREEZER FEATURES

Your model may have some or all of these features.

### Important information to know about glass shelves and covers:

Do not clean glass shelves or covers with warm water when they are cold. Shelves and covers may break if exposed to sudden temperature changes or impact, such as bumping. Tempered glass is designed to shatter into many small, pebble-size pieces. This is normal. Glass shelves and covers are heavy. Use both hands when removing them to avoid dropping.

### Freezer Shelf

Depending on your model, the shelf may be wire or glass.

#### To remove and replace a shelf:

1. Remove items from the shelf.
2. Slide the shelf straight out to the stop.
3. Depending on your model, lift back or front of the shelf past the stop. Slide shelf out the rest of the way.
4. Replace the shelf by sliding the back of the shelf into the track in the wall of the cabinet.
5. Guide the front of the shelf into the shelf track. Be sure to slide the shelf in all the way.

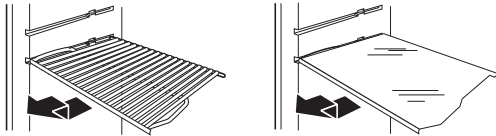

### Frozen Food Storage Guide

Storage times will vary according to the quality and type of food, the type of packaging or wrap used (should be airtight and moisture-proof), and the storage temperature. Seal the package or container securely to avoid taste and odor transfer throughout the product. Ice crystals inside a sealed package are normal. This simply means that moisture in the food and air inside the package have condensed, creating ice crystals.

Put no more unfrozen food into the freezer than will freeze within 24 hours (no more than 2 to 3 lbs of food per cubic foot [907 to 1,350 g per L] of freezer space). Leave enough space in the freezer for air to circulate around packages. The freezer door must close tightly.

**NOTE:** For more information on preparing food for freezing, check a freezer guide or reliable cookbook.

## DOOR FEATURES

Your model may have some or all of these features.

### Door Rails

The door rails may be removed for easier cleaning.

#### To remove and replace the rails:

1. Depending on your model, remove the rails by pushing in slightly on the front of the bracket while pulling out on the inside tab. Repeat these steps for the other end.
2. Replace the rails by aligning the ends of the brackets with the buttons on the sides of the door liner. Firmly snap bracket and assembly onto the tabs above the shelf as shown.

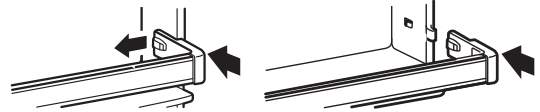

### Door Bins

#### To remove and replace the bins:

1. Remove the bin by lifting it and pulling it straight out.
2. Replace the bin by sliding it in above the desired support and pushing it down until it stops.

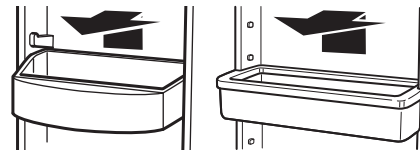

### Utility Compartment

The utility compartment may be removed for easier cleaning.

#### To remove and replace the utility compartment:

1. Remove the utility compartment by squeezing against one side while raising the utility compartment up and pulling it straight out.
2. Replace the utility compartment by positioning one side in the lock and sliding in the opposite side until it stops.

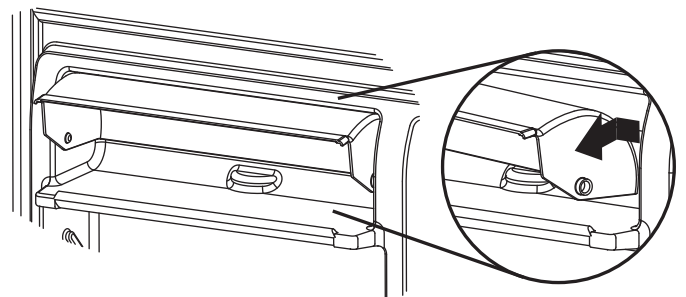



## Ice Maker

**IMPORTANT:** For models with a water filter, after connecting the refrigerator to a water source or replacing the water filter, fill and discard three full containers of ice to prepare the water filter for use.

### Turning the Ice Maker On/Off

To turn the ice maker on, simply lower the wire shut-off arm.  
To manually turn the ice maker off, lift the wire shut-off arm to the Off (arm up) position and listen for the click.

**NOTE:** Your ice maker has an automatic shutoff. As ice is made, the ice cubes will fill the ice storage bin and the ice cubes will raise the wire shut-off arm to the Off (arm up) position. Do not force the wire shut-off arm up or down.

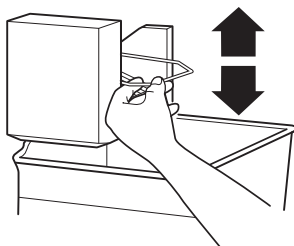

### Ice Storage Bin

1. Wash the ice storage bin with mild soap and warm water.
2. Slide the ice storage bin under the ice maker and push it toward the back as far as it will go.
3. Lower the arm on the ice maker to the “On” position.  
**NOTE:** It usually takes approximately 24 hours for the ice maker to begin producing ice. You may notice the ice has an “off-taste.” If so, discard the first three batches of ice produced. After that the “off-taste” should be gone.

### Ice Production Rate

- The ice maker should produce approximately 8 to 12 batches of ice in a 24-hour period. Allow 3 days to completely fill the ice container.
- To increase ice production, lower the freezer and refrigerator temperatures. See “Using the Controls.” Wait 24 hours between adjustments.

### Remember

- The quality of your ice will be only as good as the quality of the water supplied to your ice maker. Avoid connecting the ice maker to a softened water supply. Water softener chemicals (such as salt) can damage parts of the ice maker and lead to poor quality ice. If a softened water supply cannot be avoided, make sure the water softener is operating properly and is well maintained.
- Do not use anything sharp to break up the ice in the bin. This can cause damage to the ice storage bin and the dispenser mechanism.
- Do not store anything on top of or in the ice maker or ice storage bin.

## REFRIGERATOR CARE

### Cleaning

#### **⚠ WARNING**



#### Explosion Hazard

**Use nonflammable cleaner.**

**Failure to do so can result in death, explosion, or fire.**

Both the refrigerator and freezer sections defrost automatically. However, clean both sections about once a month to avoid buildup of odors. Wipe up spills immediately.

#### **IMPORTANT:**

- Because air circulates between both sections, any odors formed in one section will transfer to the other. You must thoroughly clean both sections to eliminate odors. To avoid odor transfer and drying out of food, wrap or cover foods tightly.
- For stainless steel models, stainless steel is corrosion-resistant and not corrosion-proof. To help avoid corrosion of your stainless steel, keep your surfaces clean by using the following cleaning instructions.

#### **To Clean Your Refrigerator:**

**NOTE:** Do not use abrasive or harsh cleaners such as window sprays, scouring cleansers, flammable fluids, muriatic acid, cleaning waxes, concentrated detergents, bleaches, or cleansers containing petroleum products on exterior surfaces (doors and cabinet), plastic parts, interior and door liners, or gaskets. Do not use paper towels, scouring pads, or other harsh cleaning tools.

1. Unplug refrigerator or disconnect power.
2. Hand wash, rinse, and dry removable parts and interior surfaces thoroughly. Use a clean sponge or soft cloth and a mild detergent in warm water.
3. Clean the exterior surfaces.  
**Painted metal:** Wash painted metal exteriors with a clean, soft cloth or sponge and a mild detergent in warm water. Rinse surfaces with clean, warm water and dry immediately to avoid water spots.

**Stainless steel:** Wash stainless steel surfaces with a clean, soft cloth or sponge and a mild detergent in warm water. Rinse surfaces with clean, warm water and dry immediately to avoid water spots.

**NOTE:** When cleaning stainless steel, always wipe in the direction of the grain to avoid cross-grain scratching.

4. There is no need for routine condenser cleaning in normal home operating environments. If the environment is particularly greasy or dusty or there is significant pet traffic in the home, the condenser should be cleaned every 2 to 3 months to ensure maximum efficiency. If you need to clean the condenser:
  - Remove the base grille.
  - Use a vacuum cleaner with a soft brush to clean the grille, the open areas behind the grille, and the front surface area of the condenser.
  - Replace the base grille when finished.
5. Plug in refrigerator or reconnect power.

---

## Changing the Light Bulb

**NOTE:** Applies to some models.

**IMPORTANT:** The light bulbs in both the refrigerator and freezer compartments of your new refrigerator use LED technology. If the lights do not illuminate when the refrigerator and/or freezer door is opened, call for assistance or service.

---

### Refrigerator Compartment Light

---

The refrigerator light bulb is located behind the control.

1. Unplug refrigerator or disconnect power.
2. Remove the light bulb and replace it with an appliance bulb of the same size and shape.
  - To replace the LED bulb with an LED bulb, order part number W10716219 (4 watts).

**NOTE:** Some LED replacement bulbs are not recommended for wet/damp environments. The refrigerator and freezer compartments are considered to be wet/damp environments. If using a brand of LED bulb other than the recommended LED bulb, before installation, read and follow all instructions on the LED packaging.
  - To replace an LED bulb with an incandescent bulb, use only incandescent bulbs for household appliances with a maximum of 60 watts.
3. Plug in refrigerator or reconnect power.

---

### Freezer Compartment Light

---

1. Unplug refrigerator or disconnect power.
2. Remove the light shield (on some models).
  - Top of the freezer compartment - Slide the light shield toward the back of the compartment to release it from the light assembly.

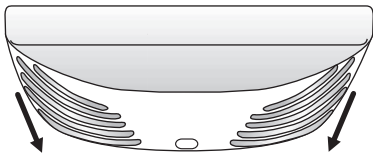

3. Remove the light bulb and replace it with an appliance bulb of the same size and shape.
  - To replace an LED light bulb in the freezer compartment, order part number W10565137 (3.6 watts).

**NOTE:** Some LED replacement bulbs are not recommended for wet/damp environments. The refrigerator and freezer compartments are considered to be wet/damp environments. If using a brand of LED bulb other than the recommended LED bulb, before installation, read and follow all instructions on the LED packaging.
  - If an incandescent bulb is used to replace an LED bulb, use only incandescent bulbs for household appliances with a maximum of 25 watts.
4. Replace the light shield.
5. Plug in refrigerator or reconnect power.

---

## Vacation and Moving Care

---

### Vacations

---

#### If You Choose to Leave the Refrigerator On While You're Away:

1. Use up any perishables and freeze other items.
2. If your refrigerator has an automatic ice maker and is connected to the household water supply, turn off the water supply to the refrigerator. Property damage can occur if the water supply is not turned off.
3. If you have an automatic ice maker, turn off the ice maker.

**NOTE:** Raise the wire shut-off arm to the Off (up) position.
4. Empty the ice bin.

#### If You Choose to Turn Off the Refrigerator Before You Leave:

1. Remove all food from the refrigerator.
2. If your refrigerator has an automatic ice maker:
  - Turn off the water supply to the ice maker at least one day ahead of time.
  - When the last load of ice drops, raise the wire shut-off arm to the Off (up) position.
3. Turn off the Temperature controls. See "Using the Controls."
4. Clean refrigerator, wipe it, and dry well.
5. Tape rubber or wood blocks to the tops of both doors to prop them open far enough for air to get in. This stops odor and mold from building up.

---

### Moving

---

When you are moving your refrigerator to a new home, follow these steps to prepare it for the move.

1. If your refrigerator has an automatic ice maker:
  - Turn off the water supply to the ice maker at least one day ahead of time.
  - Disconnect the water line from the back of the refrigerator.
  - When the last load of ice drops, raise the wire shut-off arm to the Off (up) position.
2. Remove all food from the refrigerator and pack all frozen food in dry ice.
3. Empty the ice bin.
4. Turn off the Temperature controls. See "Using the Controls."
5. Unplug refrigerator.
6. Clean, wipe, and dry thoroughly.
7. Take out all removable parts, wrap them well, and tape them together so they don't shift and rattle during the move.
8. Depending on the model, raise the front of the refrigerator so it rolls more easily OR raise the leveling screws so they don't scrape the floor. See "Adjust the Door(s)" or "Door Closing and Door Alignment."
9. Tape the doors closed and tape the power cord to the back of the refrigerator.

When you get to your new home, put everything back and refer to the "Installation Instructions" section for preparation instructions. Also, if your refrigerator has an automatic ice maker, remember to reconnect the water supply to the refrigerator.

# TROUBLESHOOTING

First try the solutions suggested here. If you need further assistance or more recommendations that may help you avoid a service call, refer to the warranty page in this manual and scan the code with your mobile device, or visit [www.maytag.com/product\\_help](http://www.maytag.com/product_help). In Canada, visit [www.maytag.ca](http://www.maytag.ca).

Contact us by mail with any questions or concerns at the address below:

In the U.S.A.:

Maytag Brand Home Appliances  
Customer eXperience Center  
553 Benson Road  
Benton Harbor, MI 49022-2692

In Canada:

Maytag Brand Home Appliances  
Customer eXperience Centre  
200 – 6750 Century Ave.  
Mississauga, Ontario L5N 0B7

Please include a daytime phone number in your correspondence.

## Refrigerator Operation

### The refrigerator will not operate

#### ⚠ WARNING



#### Electrical Shock Hazard

**Plug into a grounded 3 prong outlet.**

**Do not remove ground prong.**

**Do not use an adapter.**

**Do not use an extension cord.**

**Failure to follow these instructions can result in death, fire, or electrical shock.**

- **Power cord unplugged?** Plug into a grounded 3 prong outlet.
- **Is outlet working?** Plug in a lamp to see if the outlet is working.
- **Household fuse blown or circuit breaker tripped?** Replace the fuse or reset the circuit breaker. If the problem continues, call an electrician.
- **Controls on?** Make sure the refrigerator control is ON. See “Using the Controls.”
- **New installation?** Allow 24 hours following installation for the refrigerator to cool completely.  
**NOTE:** Adjusting the temperature controls to coldest setting will not cool the refrigerator more quickly.

### The lights do not work

**Light bulb burned out?** Replace light bulb. See “Changing the Light Bulb.”

### The motor seems to run too much

Your new refrigerator may run longer than your old one due to its high-efficiency compressor and fans. The unit may run even longer if the room is warm, a large food load is added, the door is opened often, or if the door has been left open.

### The refrigerator seems noisy

Refrigerator noise has been reduced over the years. Due to this reduction, you may hear intermittent noises from your new refrigerator that you did not notice from your old model. Below are listed some normal sounds with explanations.

- **Buzzing** - heard when the water valve opens to fill the ice maker
- **Pulsating** - fans/compressor adjusting to optimize performance
- **Hissing/Rattling** - flow of refrigerant, movement of water lines, or from items placed on top of the refrigerator
- **Sizzling/Gurgling** - water dripping on the heater during Defrost cycle
- **Popping** - contraction/expansion of inside walls, especially during initial cooldown
- **Water running/dripping** - may be heard when ice melts during defrosting and water runs into the drain pan
- **Creaking/Cracking** - occurs as ice is being ejected from the ice maker mold

### The doors will not close completely or they pop open

- **Door blocked open?** Move food packages away from door.
- **Bin or shelf in the way?** Push bin or shelf back in the correct position.
- **Crisper cover in the way?** Make sure the crisper cover is fully pushed in so that the back rests on the supports.
- **Refrigerator not tilted toward the rear?** So the doors will close easier, raise the front of the refrigerator so that it tilts slightly downward toward the rear. See “Adjust the Doors.”
- **Door closed too quickly?** Close the door slowly and firmly to keep the door from popping open.

The door is difficult to open

## ⚠ WARNING



### Explosion Hazard

Use nonflammable cleaner.

Failure to do so can result in death, explosion, or fire.

- **Gaskets dirty or sticky?** Clean gaskets and contact surfaces with mild soap and warm water. Rinse and dry with soft cloth.

## Temperature and Moisture

### Temperature is too warm

- **New installation?** Allow 24 hours following installation for the refrigerator to cool completely.
- **Door opened often or left open?** Allows warm air to enter refrigerator. Minimize door openings and keep door fully closed.
- **Large load of food added?** Allow several hours for refrigerator to return to normal temperature.
- **Controls set correctly for the surrounding conditions?** Adjust the controls a setting colder. Check temperature in 24 hours. See “Using the Controls.”

### There is interior moisture buildup

**NOTE:** Some moisture buildup is normal.

- **Humid room?** Contributes to moisture buildup.
- **Door opened often or left open?** Allows humid air to enter refrigerator. Minimize door openings and keep door fully closed.

## Ice and Water

### The ice maker is not producing ice or not enough ice

- **Refrigerator connected to a water supply and the supply shut-off valve turned on?** Connect refrigerator to water supply and turn water shut-off valve fully open.
- **Kink in the water source line?** A kink in the line can reduce water flow. Straighten the water source line.
- **Ice maker turned on?** Make sure wire shut-off arm or switch (depending on model) is in the On position.
- **New installation?** Wait 24 hours after ice maker installation for ice production to begin. Allow 3 days to completely fill the ice container.
- **Large amount of ice recently removed?** Allow 24 hours for ice maker to produce more ice.
- **Ice cube jammed in the ice maker ejector arm?** Remove ice from the ejector arm with a plastic utensil.
- **Reverse osmosis water filtration system connected to your cold water supply?** This can decrease water pressure. See “Water Supply Requirements.”

### The ice cubes are hollow or small

**NOTE:** This is an indication of low water pressure.

- **Water shut-off valve not fully open?** Turn the water shut-off valve fully open.
- **Kink in the water source line?** A kink in the line can reduce water flow. Straighten the water source line.
- **Reverse osmosis water filtration system connected to your cold water supply?** This can decrease water pressure. See “Water Supply Requirements.”
- **Questions remain regarding water pressure?** Call a licensed, qualified plumber.

### Off-taste, odor, or gray color in the ice

- **New plumbing connections?** New plumbing connections can cause discolored or off-flavored ice.
- **Ice stored too long?** Discard ice. Wash ice bin. Allow 24 hours for ice maker to make new ice.
- **Odor transfer from food?** Use airtight, moisture-proof packaging to store food.
- **Are there minerals (such as sulfur) in the water?** A water filter may need to be installed to remove the minerals.

## ACCESSORIES

The following accessories are available for your refrigerator. To order, contact us and ask for the part number.

In the U.S.A., visit [www.maytag.com/accessories](http://www.maytag.com/accessories) or call 1-800-688-9900.

In Canada, visit [www.maytag.ca](http://www.maytag.ca) or call 1-800-807-6777.

### affresh® Stainless Steel Cleaner:

In U.S.A., order Part #W10355016

In Canada, order Part #W10355016B

### affresh® Stainless Steel Wipes:

In U.S.A., order Part #W10355049

In Canada, order Part #W10355049B

### affresh® Kitchen & Appliance Cleaner:

In U.S.A., order Part #W10355010

In Canada, order Part #W10355010B

### Air Filter:

Order Part #W10311524

### Reversibility Kit:

Order Part # W10395149

# MAYTAG® REFRIGERATION LIMITED WARRANTY

ATTACH YOUR RECEIPT HERE. PROOF OF PURCHASE IS REQUIRED TO OBTAIN WARRANTY SERVICE.

Please have the following information available when you call the Customer eXperience Center:

- Name, address and telephone number
- Model number and serial number
- A clear, detailed description of the problem
- Proof of purchase including dealer or retailer name and address

## IF YOU NEED SERVICE:

1. Before contacting us to arrange service, please determine whether your product requires repair. Some questions can be addressed without service. Please take a few minutes to review the Troubleshooting or Problem Solver section of the Use and Care Guide, scan the QR code on the right to access additional resources, or visit [https://www.maytag.com/product\\_help](https://www.maytag.com/product_help).
2. All warranty service is provided exclusively by our authorized Maytag Service Providers. In the U.S. and Canada, direct all requests for warranty service to:

**Maytag Customer eXperience Center**

**In the U.S.A., call 1-800-688-9900. In Canada, call 1-800-807-6777.**

If outside the 50 United States or Canada, contact your authorized Maytag dealer to determine whether another warranty applies.



[https://www.maytag.com/product\\_help](https://www.maytag.com/product_help)

## TEN YEAR LIMITED WARRANTY

### WHAT IS COVERED

#### FIRST YEAR LIMITED WARRANTY (PARTS AND LABOR)

For one year from the date of purchase, when this major appliance is installed, operated and maintained according to instructions attached to or furnished with the product, Maytag brand of Whirlpool Corporation or Whirlpool Canada, LP (hereafter "Maytag") will pay for factory specified replacement parts and repair labor to correct defects in materials or workmanship that existed when this major appliance was purchased, or at its sole discretion replace the product. In the event of product replacement, your appliance will be warranted for the remaining term of the original unit's warranty period.

#### SECOND THROUGH TENTH YEAR LIMITED WARRANTY (COMPRESSOR ONLY - LABOR NOT INCLUDED)

In the second through tenth years from the date of original purchase, when this major appliance is installed, operated and maintained according to instructions attached to or furnished with the product, Maytag will pay for a factory specified replacement compressor to correct non-cosmetic defects in materials or workmanship in this part that prevent function of the refrigerator and that existed when this major appliance was purchased. This limited 10-year warranty is for the compressor only and does not include labor.

YOUR SOLE AND EXCLUSIVE REMEDY UNDER THIS LIMITED WARRANTY SHALL BE PRODUCT REPAIR AS PROVIDED HEREIN. Service must be provided by a Maytag designated service company. This limited warranty is valid only in the United States or Canada and applies only when the major appliance is used in the country in which it was purchased. This limited warranty is effective from the date of original consumer purchase. Proof of original purchase date is required to obtain service under this limited warranty.

### WHAT IS NOT COVERED

1. Commercial, non-residential or multiple-family use, or use inconsistent with published user, operator or installation instructions.
2. In-home Instruction on how to use your product.
3. Service to correct improper product maintenance or installation, installation not in accordance with electrical or plumbing codes or correction of household electrical or plumbing (i.e. house wiring, fuses or water inlet hoses).
4. Consumable parts (i.e. light bulbs, batteries, air or water filters, preservation solutions, etc.).
5. Defects or damage caused by the use of non-genuine Maytag parts or accessories.
6. Damage from accident, misuse, abuse, fire, floods, acts of God or use with products not approved by Maytag.
7. Repairs to parts or systems to correct product damage or defects caused by unauthorized service, alteration or modification of the appliance.
8. Cosmetic damage including scratches, dents, chips, and other damage to appliance finishes unless such damage results from defects in materials and workmanship and is reported to Maytag within 30 days.
9. Discoloration, rust or oxidation of surfaces resulting from caustic or corrosive environments including but not limited to high salt concentrations, high moisture or humidity or exposure to chemicals.
10. Food or medicine loss due to product failure.
11. Pick-up or delivery. This product is intended for in-home repair.
12. Travel or transportation expenses for service in remote locations where an authorized Maytag servicer is not available.
13. Removal or reinstallation of inaccessible appliances or built-in fixtures (i.e. trim, decorative panels, flooring, cabinetry, islands, countertops, drywall, etc.) that interfere with servicing, removal or replacement of the product.
14. Service or parts for appliances with original model/serial numbers removed, altered or not easily determined.

**The cost of repair or replacement under these excluded circumstances shall be borne by the customer.**

### DISCLAIMER OF IMPLIED WARRANTIES

IMPLIED WARRANTIES, INCLUDING ANY IMPLIED WARRANTY OF MERCHANTABILITY OR IMPLIED WARRANTY OF FITNESS FOR A PARTICULAR PURPOSE, ARE LIMITED TO ONE YEAR OR THE SHORTEST PERIOD ALLOWED BY LAW. Some states and provinces do not allow limitations on the duration of implied warranties of merchantability or fitness, so this limitation may not apply to you. This warranty gives you specific legal rights, and you also may have other rights that vary from state to state or province to province.

### DISCLAIMER OF REPRESENTATIONS OUTSIDE OF WARRANTY

Maytag makes no representations about the quality, durability, or need for service or repair of this major appliance other than the representations contained in this warranty. If you want a longer or more comprehensive warranty than the limited warranty that comes with this major appliance, you should ask Maytag or your retailer about buying an extended warranty.

### LIMITATION OF REMEDIES; EXCLUSION OF INCIDENTAL AND CONSEQUENTIAL DAMAGES

YOUR SOLE AND EXCLUSIVE REMEDY UNDER THIS LIMITED WARRANTY SHALL BE PRODUCT REPAIR AS PROVIDED HEREIN. MAYTAG SHALL NOT BE LIABLE FOR INCIDENTAL OR CONSEQUENTIAL DAMAGES. Some states and provinces do not allow the exclusion or limitation of incidental or consequential damages, so these limitations and exclusions may not apply to you. This warranty gives you specific legal rights, and you also may have other rights that vary from state to state or province to province.



**Standard Door  
Porte Standard**

45/32"  
(10,6 cm)

Align with top of the door.  
Aligner avec le sommet de la porte.

Align with side of the door.  
Aligner avec le côté de la porte.

429/32"  
(12,5 cm)

Ideal position of hole (shown as suggestion)  
Position idéale du trou (suggérée)

