

Gas and Electric Dryer Installation Instructions

Instructions d'installation – Sécheuse à gaz et électrique

Table of Contents

DRYER SAFETY	2
INSTALLATION REQUIREMENTS	4
Tools and Parts.....	4
LOCATION REQUIREMENTS.....	5
Installation Clearances	5
Dryer Dimensions.....	5
ELECTRICAL REQUIREMENTS - U.S.A. ONLY	6
Grounding Instructions.....	7
ELECTRIC DRYER POWER HOOKUP - CANADA ONLY	7
Electrical Requirements	7
Grounding Instructions.....	7
GAS DRYER POWER HOOKUP - U.S.A. AND CANADA	8
Electrical Requirements	8
Grounding Instructions.....	8
Gas Supply Requirements.....	8
Gas Type.....	8
Gas Supply Line.....	8
Gas Supply Connection Requirements	9
Burner Input Requirements.....	9
Dryer Gas Pipe.....	9
INSTALL LEVELING LEGS.....	9
MAKE ELECTRICAL CONNECTION - U.S.A. ONLY	10
Electrical Connection.....	10
Power Supply Cord Connection.....	10
Direct Wire Connection.....	12
MAKE GAS CONNECTION - U.S.A. AND CANADA.....	16
VENTING.....	16
Venting Requirements.....	16
Plan Vent System.....	17
Install Vent System.....	18
CONNECT VENT	19
LEVEL DRYER.....	19
COMPLETE INSTALLATION CHECKLIST	20
REVERSE DOOR SWING.....	21
TROUBLESHOOTING	23

Table des matières

SÉCURITÉ DE LA SÉCHEUSE	24
EXIGENCES D'INSTALLATION	26
Outillage et pièces	26
EXIGENCES D'EMPLACEMENT	27
Distances de dégagement à respecter pour l'installation.....	27
Dimensions de la sécheuse.....	27
RACCORDEMENT DE LA SÉCHEUSE ÉLECTRIQUE – CANADA SEULEMENT	28
Spécifications électriques.....	28
Instructions de liaison à la terre	29
RACCORDEMENT ÉLECTRIQUE DE LA SÉCHEUSE À GAZ - ÉTATS-UNIS ET CANADA	29
Spécifications électriques.....	29
Instructions de liaison à la terre	29
Spécifications de l'alimentation en gaz	30
Type de gaz.....	30
Canalisation de gaz.....	30
Spécifications du raccordement de l'alimentation en gaz.....	31
Spécifications de l'alimentation du bruler	31
INSTALLATION DES PIEDS DE NIVELLEMENT	31
RACCORDEMENT AU GAZ - ÉTATS-UNIS ET CANADA	32
L'ÉVACUATION.....	32
Exigences concernant l'évacuation	32
Planification des circuits de conduits	33
Installation du système d'évacuation.....	34
RACCORDEMENT DU SYSTÈME D'ÉVACUATION	35
ÉTABLIR L'APLOMB DE LA SÉCHEUSE.....	36
ACHEVER L'INSTALLATION LISTE DE VÉRIFICATION	36
INVERSION DU SENS D'OUVERTURE DE LA PORTE.....	37
DÉPANNAGE	39

Para obtener acceso al “Instrucciones de instalación” en español, o para obtener información adicional acerca de su producto, visite: www.whirlpool.com
Tenga listo su número de modelo completo. Puede encontrar el número de modelo y de serie dentro de la cavidad superior de la puerta.

INSTALLATION NOTES

Date of purchase: _____
Date of installation: _____
Installer: _____
Model number: _____
Serial number: _____

NOTES CONCERNANT L'INSTALLATION

Date d'achat : _____
Date d'installation : _____
Installateur : _____
Numéro de modèle : _____
Numéro de série : _____

DRYER SAFETY

Your safety and the safety of others are very important.

We have provided many important safety messages in this manual and on your appliance. Always read and obey all safety messages.



This is the safety alert symbol.

This symbol alerts you to potential hazards that can kill or hurt you and others.

All safety messages will follow the safety alert symbol and either the word “DANGER” or “WARNING.”

These words mean:

⚠ DANGER

You can be killed or seriously injured if you don't immediately follow instructions.

⚠ WARNING

You can be killed or seriously injured if you don't follow instructions.

All safety messages will tell you what the potential hazard is, tell you how to reduce the chance of injury, and tell you what can happen if the instructions are not followed.



WARNING - “Risk of Fire”

- Clothes dryer installation must be performed by a qualified installer.
- Install the clothes dryer according to the manufacturer's instructions and local codes.
- Do not install a clothes dryer with flexible plastic venting materials or flexible metal (foil type) duct. If flexible metal duct is installed, it must be of a specific type identified by the appliance manufacturer as suitable for use with clothes dryers. Flexible venting materials are known to collapse, be easily crushed, and trap lint. These conditions will obstruct clothes dryer airflow and increase the risk of fire.
- To reduce the risk of severe injury or death, follow all installation instructions.
- Save these instructions.

IMPORTANT: When discarding or storing your old clothes dryer, remove the door.

WARNING: For your safety, the information in this manual must be followed to minimize the risk of fire or explosion, or to prevent property damage, personal injury, or death.

- Do not store or use gasoline or other flammable vapors and liquids in the vicinity of this or any other appliance.
- **WHAT TO DO IF YOU SMELL GAS:**
 - Do not try to light any appliance.
 - Do not touch any electrical switch; do not use any phone in your building.
 - Clear the room, building, or area of all occupants.
 - Immediately call your gas supplier from a neighbor's phone. Follow the gas supplier's instructions.
 - If you cannot reach your gas supplier, call the fire department.
- Installation and service must be performed by a qualified installer, service agency, or the gas supplier.

WARNING: Gas leaks cannot always be detected by smell.

Gas suppliers recommend that you use a gas detector approved by UL or CSA.

For more information, contact your gas supplier.

If a gas leak is detected, follow the "What to do if you smell gas" instructions.

IMPORTANT: The gas installation must conform with local codes, or in the absence of local codes, with the National Fuel Gas Code, ANSI Z223.1/NFPA 54 or the Canadian Natural Gas and Propane Installation Code, CSA B149.1.

The dryer must be electrically grounded in accordance with local codes, or in the absence of local codes, with the National Electrical Code, ANSI/NFPA 70 or Canadian Electrical Code, CSA C22.1.

In the State of Massachusetts, the following installation instructions apply:

- Installations and repairs must be performed by a qualified or licensed contractor, plumber, or gasfitter qualified or licensed by the State of Massachusetts.
- If using a ball valve, it shall be a T-handle type.
- A flexible gas connector, when used, must not exceed 3 feet.

 **WARNING**

Fire Hazard

Failure to follow safety warnings exactly could result in serious injury, death, or property damage.

Do not install a booster fan in the exhaust duct.

Install all clothes dryers in accordance with the installation instructions of the manufacturer of the dryer.

INSTALLATION REQUIREMENTS

TOOLS AND PARTS

Gather the required tools and parts before starting installation. Read and follow the instructions provided with any tools listed here.

Tools needed for all installations:

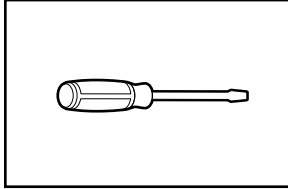

Flat-blade screwdriver

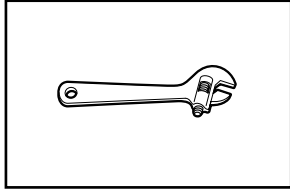

Adjustable wrench that opens to 1" (25 mm) or hex-head socket wrench

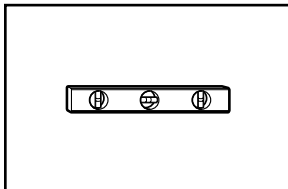

Level

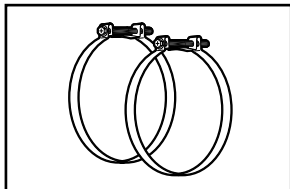

Vent clamps

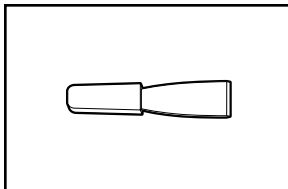

Plastic putty knife

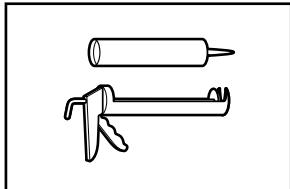

Caulking gun and compound (for installing new exhaust vent)

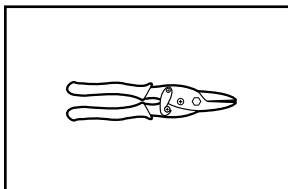

Tin snips (new vent installations)

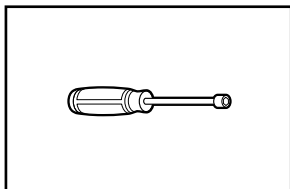

1/4" (6 mm) nut driver (recommended)

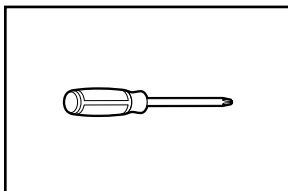

#2 Phillips screwdriver

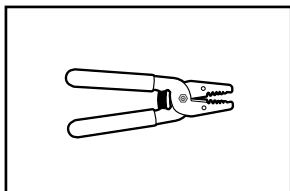

Wire stripper (direct wire installations)

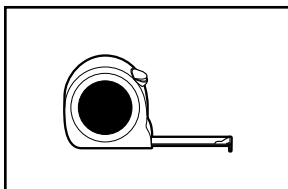

Tape measure

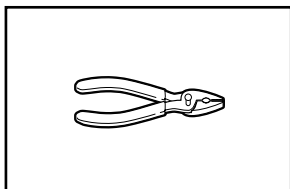

Pliers

Tools needed for gas installations:

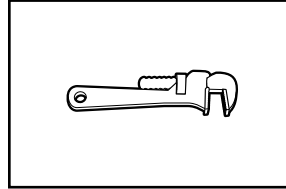

8" (203 mm) or 10" (254 mm) pipe wrench

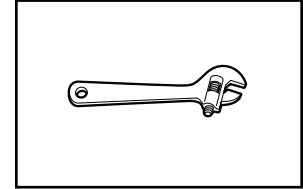

8" (203 mm) or 10" (254 mm) adjustable wrench (for gas connections)



Pipe-joint compound resistant to LP gas

Parts supplied (all models):

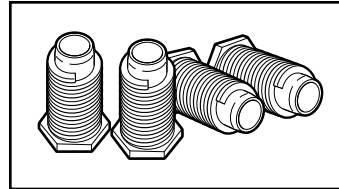

Leveling legs (4)

If using a power supply cord:

Use a UL listed power supply cord kit marked for use with clothes dryers. The kit should contain:

- A UL listed 30-amp power supply cord, rated 120/240 volt minimum, with a temperature rating of 140°F (60°C) minimum. The cord should be type SRD or SRDT and be at least 4 ft. (1.22 m) long. The wires that connect to the dryer must end in ring terminals or spade terminals with upturned ends.
- A UL listed strain relief.

Parts needed: (Not supplied with dryer)

Check local codes. Check existing electrical supply and venting. See "Electrical Requirements" and "Venting Requirements" before purchasing parts.

Mobile home installations require metal exhaust system hardware available for purchase from the dealer from whom you purchased your dryer. For further information, please refer to the "Assistance or Service" section in your "Use and Care Guide."

LOCATION REQUIREMENTS

⚠ WARNING



Explosion Hazard

Keep flammable materials and vapors, such as gasoline, away from dryer.

Place dryer at least 18 inches (460 mm) above the floor for a garage installation.

Failure to do so can result in death, explosion, or fire.

You will need:

- A location allowing for proper exhaust installation. See "Venting Requirements."
- A separate 15 or 20-amp circuit needed for gas dryers and 30-amp circuit needed for electric dryers.
- If using power supply cord, a grounded electrical outlet located within 2 ft. (610 mm) of either side of dryer.
- Floor must support dryer weight of 200 lbs. (90.7 kg). Also consider weight of companion appliance.
- Level floor with maximum slope of 1" (25 mm) under entire dryer. If slope is greater than 1" (25 mm), clothes may not tumble properly and automatic sensor cycles may not operate correctly.
- For garage installation, place dryer at least 18" (460 mm) above floor.

IMPORTANT: Do not operate, install, or store dryer where it will be exposed to water, weather, or at temperatures below 45°F (7°C). Lower temperatures may cause dryer not to shut off at end of automatic sensor cycles, resulting in longer drying times.

NOTE: No other fuel-burning appliance can be installed in the same closet as a dryer.

INSTALLATION CLEARANCES

For each arrangement, consider allowing more space for ease of installation and servicing, spacing for companion appliances and clearances for walls, doors, and floor moldings. Space must be large enough to allow door to fully open. Add spacing on all sides of dryer to reduce noise transfer. If a closet door or louvered door is installed, top and bottom air openings in door are required.

Check code requirements. Some codes limit, or do not permit, installation of the dryer in garages, closets, mobile homes, or sleeping quarters. Contact your local building inspector.

DRYER DIMENSIONS

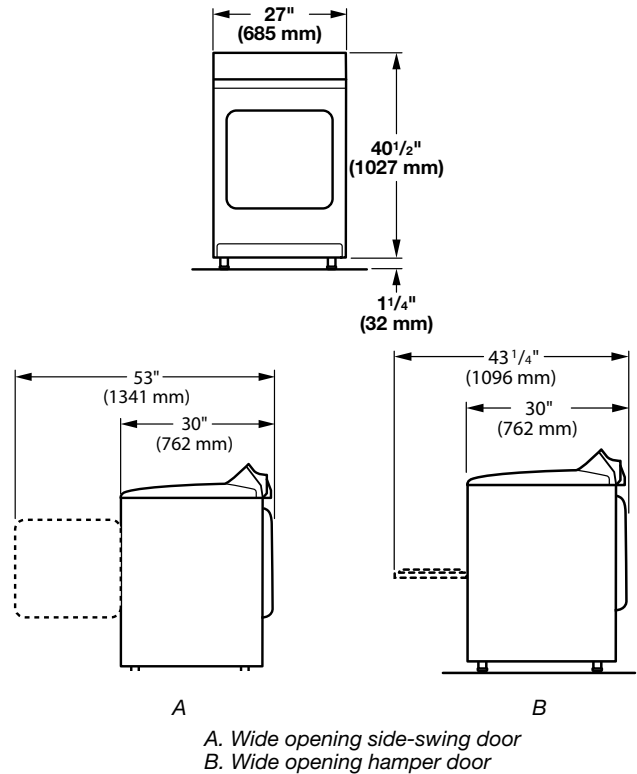

*Most installations require a minimum 6" (152 mm) clearance behind the dryer for the exhaust vent with elbow. See "Venting Requirements."

Spacing for recessed area or closet installation

The dimensions shown are for the recommended spacing allowed.

- Additional spacing should be considered for ease of installation and servicing.
- Additional clearances might be required for wall, door, and floor moldings.
- Additional spacing of 1" (25 mm) on all sides of the dryer is recommended to reduce noise transfer.
- For closet installation, with a door, minimum ventilation openings in the top and bottom of the door are required. Louvered doors with equivalent ventilation openings are acceptable.
- Companion appliance spacing should also be considered.

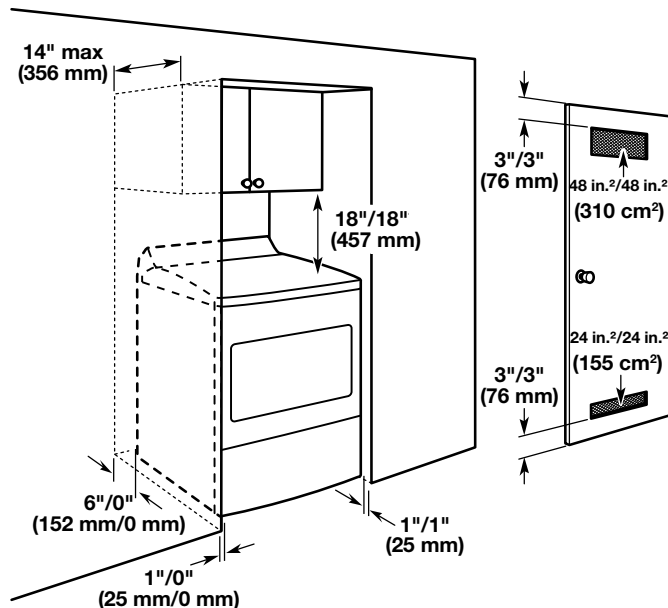

Recommended/Minimum spacing

Mobile home - Additional installation requirements:

This dryer is suitable for mobile home installations. The installation must conform to the Manufactured Home Construction and Safety Standard, Title 24 CFR, Part 3280 (formerly the Federal Standard for Mobile home construction and Safety, Title 24, HUD Part 280) or Standard CAN/CSA-Z240 MH.

Mobile home installations require:

All dryers:

- Metal exhaust system hardware, available for purchase from your dealer. For further information, see "Assistance or Service" section in your "Use and Care Guide."
- Special provisions must be made in mobile homes to introduce outside air into dryer. Openings (such as a nearby window) should be at least twice as large as dryer exhaust opening.

For gas dryers mobile home installations:

- Mobile Home Installation Hold-down Kit is available to order. For further information, see "Assistance or Service" section in your "Use and Care Guide."

ELECTRICAL REQUIREMENTS - U.S.A. ONLY (SPÉCIFICATIONS ÉLECTRIQUES – ÉTATS-UNIS SEULEMENT)

It is your responsibility:

- To contact a qualified electrical installer.
- To be sure that the electrical connection is adequate and in conformance with the National Electrical Code, ANSI/NFPA 70 - latest edition and all local codes and ordinances.

The National Electrical Code requires a 4-wire power supply connection for homes built after 1996, dryer circuits involved in remodeling after 1996, and all mobile home installations.

A copy of the above code standards can be obtained from: National Fire Protection Association, One Batterymarch Park, Quincy, MA 02269.

- To supply the required 3- or 4-wire, single phase, 120/240 volt, 60 Hz, AC only electrical supply (or 3- or 4-wire, 120/208 volt electrical supply, if specified on the serial/rating plate) on a separate 30-amp circuit, fused on both sides of the line. Connect to an individual branch circuit. Do not have a fuse in the neutral or grounding circuit.
- Do not use an extension cord.
- If codes permit and a separate ground wire is used, it is recommended that a qualified electrician determine that the ground path is adequate.

Electrical Connection

To properly install your dryer, you must determine the type of electrical connection you will be using and follow the instructions provided for it here.

- This dryer is manufactured ready to install with a 3-wire electrical supply connection. The neutral ground conductor is permanently connected to the neutral conductor (white wire) within the dryer. If the dryer is installed with a 4-wire electrical supply connection, the neutral ground conductor must be removed from the external ground connector (green screw), and secured under the neutral terminal (center or white wire) of the terminal block. When the neutral ground conductor is secured under the neutral terminal (center or white wire) of the terminal block, the dryer cabinet is isolated from the neutral conductor.
- If local codes do not permit the connection of a neutral ground wire to the neutral wire, see "Optional 3-wire connection" section.
- A 4-wire power supply connection must be used when the appliance is installed in a location where grounding through the neutral conductor is prohibited. Grounding through the neutral is prohibited for (1) new branch-circuit installations, (2) mobile homes, (3) recreational vehicles, and (4) areas where local codes prohibit grounding through the neutral conductors.

If using a power supply cord:

Use a UL listed power supply cord kit marked for use with clothes dryers. The kit should contain:

- A UL listed 30-amp power supply cord, rated 120/240 volt minimum, with a temperature rating of 140°F (60°C) minimum. The cord should be type SRD or SRDT, and be at least 4 ft. (1.22 m) long. The wires that connect to the dryer must end in ring terminals or spade terminals with upturned ends.
- A UL listed strain relief.

If your outlet looks like this:

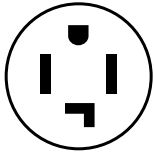

4-wire receptacle (14-30R)

Then choose a 4-wire power supply cord with ring or spade terminals and UL listed strain relief. The 4-wire power supply cord, at least 4 ft. (1.22 m) long, must have 4 10-gauge solid copper wires and match a 4-wire receptacle of NEMA Type 14-30 R. The ground wire (ground conductor) may be either green or bare. The neutral conductor must be identified by a white cover.

If your outlet looks like this:

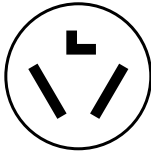

3-wire receptacle (10-30R)

Then choose a 3-wire power supply cord with ring or spade terminals and UL listed strain relief. The 3-wire power supply cord, at least 4 ft. (1.22 m) long, must have 3 10-gauge solid copper wires and match a 3-wire receptacle of NEMA Type 10-30R.

If connecting by direct wire:

Power supply cable must match power supply (4-wire or 3-wire) and be:

- Flexible armored cable or nonmetallic sheathed copper cable (with ground wire), covered with flexible metallic conduit. All current-carrying wires must be insulated.
- 10-gauge solid copper wire (do not use aluminum) at least 5 ft. (1.52 m) long.

GROUNDING INSTRUCTIONS

- For a grounded, cord-connected dryer: This dryer must be grounded. In the event of malfunction or breakdown, grounding will reduce the risk of electric shock by providing a path of least resistance for electric current. This dryer uses a cord having an equipment-grounding conductor and a grounding plug. The plug must be plugged into an appropriate outlet that is properly installed and grounded in accordance with all local codes and ordinances.
- For a permanently connected dryer: This dryer must be connected to a grounded metal, permanent wiring system, or an equipment-grounding conductor must be run with the circuit conductors and connected to the equipment-grounding terminal or lead on the dryer.

WARNING: Improper connection of the equipment-grounding conductor can result in a risk of electric shock. Check with a qualified electrician or service representative or personnel if you are in doubt as to whether the dryer is properly grounded. Do not modify the plug on the power supply cord: if it will not fit the outlet, have a proper outlet installed by a qualified electrician.

SAVE THESE INSTRUCTIONS

ELECTRIC DRYER POWER HOOKUP- CANADA ONLY

ELECTRICAL REQUIREMENTS

⚠ WARNING



Electrical Shock Hazard

Plug into a grounded 4 prong outlet.

Failure to do so can result in death or electrical shock.

It is your responsibility:

- To contact a qualified electrical installer.
- To be sure that the electrical connection is adequate and in conformance with Canadian Electrical Code, C22.1-latest edition and all local codes. A copy of above codes standard may be obtained from: Canadian Standards Association, 178 Rexdale Blvd., Toronto, ON M9W 1R3 CANADA.
- To supply the required 4-wire, single phase, 120/240 volt, 60 Hz, AC only electrical supply on a separate 30-amp circuit, fused on both sides of the line. A time-delay fuse or circuit breaker is recommended. Connect to an individual branch circuit.
- This dryer is equipped with a CSA International Certified Power Cord intended to be plugged into a standard 14-30R wall receptacle. The cord is 5 ft. (1.52 m) long. Be sure wall receptacle is within reach of dryer's final location.

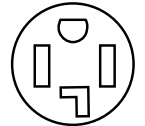

4-wire receptacle (14-30R)

For further information, please reference service numbers located in "Assistance or Service" section of your "Use and Care Guide."

GROUNDING INSTRUCTIONS

- For a grounded, cord-connected dryer: This dryer must be grounded. In the event of malfunction or breakdown, grounding will reduce the risk of electric shock by providing a path of least resistance for electric current. This dryer is equipped with a cord having an equipment-grounding conductor and a grounding plug. The plug must be plugged into an appropriate outlet that is properly installed and grounded in accordance with all local codes and ordinances.

WARNING: Improper connection of the equipment-grounding conductor can result in a risk of electric shock. Check with a qualified electrician or service representative or personnel if you are in doubt as to whether the dryer is properly grounded. Do not modify the plug provided with the dryer: if it will not fit the outlet, have a proper outlet installed by a qualified electrician.

SAVE THESE INSTRUCTIONS

GAS DRYER POWER HOOKUP - U.S.A. AND CANADA

ELECTRICAL REQUIREMENTS

⚠ WARNING



Electrical Shock Hazard

- Plug into a grounded 3 prong outlet.
- Do not remove ground prong.
- Do not use an adapter.
- Do not use an extension cord.
- Failure to follow these instructions can result in death, fire, or electrical shock.

- 120 Volt, 60 Hz, AC only, 15- or 20- amp fused electrical supply is required. A time-delay fuse or circuit breaker is recommended. It is also recommended that a separate circuit serving only this dryer be provided.

GROUNDING INSTRUCTIONS

- For a grounded, cord-connected dryer: This dryer must be grounded. In the event of malfunction or breakdown, grounding will reduce the risk of electric shock by providing a path of least resistance for electric current. This dryer is equipped with a cord having an equipment-grounding conductor and a grounding plug. The plug must be plugged into an appropriate outlet that is properly installed and grounded in accordance with all local codes and ordinances.

WARNING: Improper connection of the equipment-grounding conductor can result in a risk of electric shock. Check with a qualified electrician or service representative or personnel if you are in doubt as to whether the dryer is properly grounded. Do not modify the plug provided with the dryer: if it will not fit the outlet, have a proper outlet installed by a qualified electrician.

SAVE THESE INSTRUCTIONS

GAS SUPPLY REQUIREMENTS

⚠ WARNING



Explosion Hazard

- Use a new CSA International approved gas supply line.
- Install a shut-off valve.
- Securely tighten all gas connections.
- If connected to LP, have a qualified person make sure gas pressure does not exceed 13" (330 mm) water column.
- Examples of a qualified person include:
licensed heating personnel,
authorized gas company personnel, and
authorized service personnel.
- Failure to do so can result in death, explosion, or fire.

GAS TYPE

Natural Gas:

This dryer is equipped for use with Natural gas. It is design-certified by CSA International for LP (propane or butane) gases with appropriate conversion.

- Your dryer must have the correct burner for the type of gas in your home. Burner information is located on the rating plate in the door well of your dryer. If this information does not agree with the type of gas available, contact your dealer or call the phone numbers referenced in the "Assistance or Service" section of your "Use and Care Guide."

LP Gas Conversion:

IMPORTANT: Conversion must be made by a qualified technician.

No attempt shall be made to convert the dryer from the gas specified on the model/serial rating plate for use with a different gas without consulting your gas company.

GAS SUPPLY LINE

Option 1 (Recommended Method)

Flexible stainless steel gas connector:

- If local codes permit, use a new flexible stainless steel gas connector (Design Certified by the American Gas Association or CSA International) to connect your dryer to the rigid gas supply line. Use an elbow and a 3/8" flare x 3/8" NPT adapter fitting between the stainless steel gas connector and the dryer gas pipe as needed to prevent kinking.

Option 2 (Alternate Method)

Approved aluminum or copper tubing

- Must include 1/8" NPT minimum plugged tapping accessible for test gauge connection, immediately upstream of the gas connection to the dryer.
- 1/2" IPS pipe is recommended.
- 3/8" approved aluminum or copper tubing is acceptable for lengths under 20 ft. (6.1 m) if local codes and gas supplier permit.
- If you are using Natural gas, do not use copper tubing.

- Lengths over 20 ft. (6.1 m) should use larger tubing and a different size adapter fitting.
- If your dryer has been converted to use LP gas, 3/8" LP compatible copper tubing can be used. If the total length of the supply line is more than 20 ft. (6.1 m), use larger pipe.
NOTE: Pipe-joint compounds that resist the action of LP gas must be used. Do not use TEFLON^{®†} tape.
- Must include shut-off valve

In the U.S.A.:

An individual manual shut-off valve must be installed within six (6) ft. (1.8 m) of the dryer in accordance with the National Fuel Gas Code, ANSI Z223.1. The location should be easy to reach for opening and closing.

In Canada:

An individual manual shut-off valve must be installed in accordance with the B149.1, Natural Gas and Propane Installation Code. It is recommended that an individual manual shutoff valve be installed within six (6) ft. (1.8 m) of the dryer. The location should be easy to reach for opening and closing.

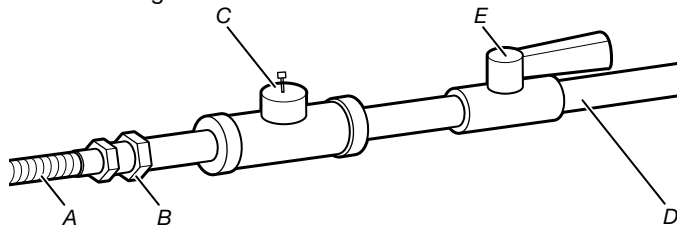

- A. 3/8" flexible gas connector
- B. 3/8" pipe to flare adapter fitting
- C. 1/8" NPT minimum plugged tapping
- D. 1/2" NPT gas supply line
- E. Gas shutoff valve.

GAS SUPPLY CONNECTION REQUIREMENTS

- Use an elbow and a 3/8" flare x 3/8" NPT adapter fitting between the flexible gas connector and the dryer gas pipe, as needed to avoid kinking.
- Use only pipe-joint compound. Do not use TEFLON^{®†} tape.
- This dryer must be connected to the gas supply line with a listed flexible gas connector that complies with the standard for connectors for gas appliances, ANSI Z21.24 or CSA 6.10.

BURNER INPUT REQUIREMENTS

Elevations above 2,000 ft. (610 m):

- When installed above 2,000 ft. (610 m) a 4% reduction of the burner Btu rating shown on the model/serial number plate is required for each 1,000 ft. (305 m) increase in elevation.

Gas supply pressure testing

- The dryer must be disconnected from the gas supply piping system during pressure testing at pressures greater than 1/2 psi.

DRYER GAS PIPE

- The gas pipe that comes out through the rear of your dryer has a 3/8" male pipe thread.

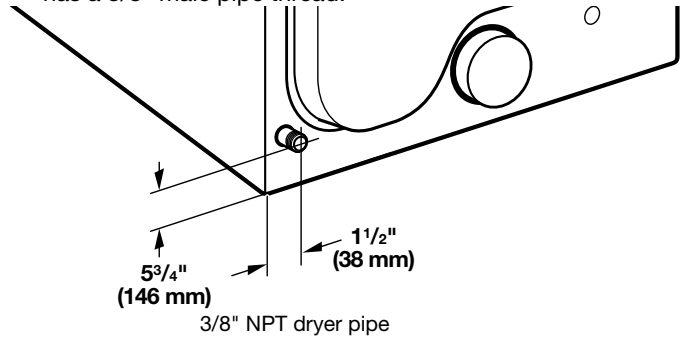

NOTE: For a garage installation, the gas pipe height must be an additional 18" (460 mm) from the floor.

INSTALL LEVELING LEGS

⚠ WARNING

Excessive Weight Hazard

Use two or more people to move and install dryer. Failure to do so can result in back or other injury.

1. Prepare dryer for leveling legs

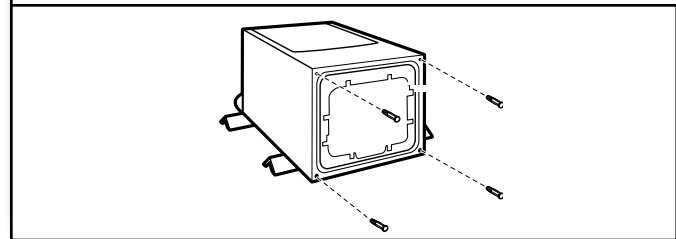

Firmly grasp dryer body (not console panel) and gently lay dryer down on back cardboard corner posts.

IMPORTANT: If laying dryer on its back, use the cardboard corner posts the dryer was packed with to avoid damaging the back of the dryer.

2. Screw in leveling legs

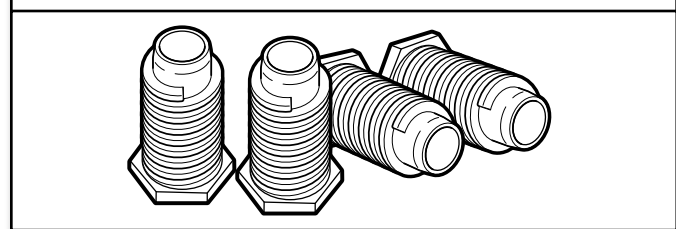

Using a wrench and tape measure, screw leveling legs into leg holes until bottom of foot is approximately 1" (25 mm) from bottom of dryer.

Now stand the dryer on its feet. Slide the dryer until it is close to its final location. Leave enough room to connect the exhaust vent.

For mobile home use

Gas dryers must be securely fastened to the floor.

Mobile home installations require a Mobile Home Installation Hold-down Kit. For ordering information please reference the "Use and Care Guide."

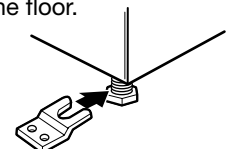

†©TEFLON is a registered trademark of Chemours.

MAKE ELECTRICAL CONNECTION - U.S.A. ONLY (EFFECTUER LE RACCORDEMENT ÉLECTRIQUE - ÉTATS-UNIS SEULEMENT)

ELECTRICAL CONNECTION

Power Supply Cord

⚠ WARNING



Fire Hazard

Use a new UL listed 30 amp power supply cord.

Use a UL listed strain relief.

Disconnect power before making electrical connections.

Connect neutral wire (white or center wire) to center terminal (silver).

Ground wire (green or bare wire) must be connected to green ground connector.

Connect remaining 2 supply wires to remaining 2 terminals (gold).

Securely tighten all electrical connections.

Failure to do so can result in death, fire, or electrical shock.

Electrical Connection Options

1. Choose electrical connection type

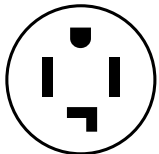

Power supply cord 4-wire receptacle (NEMA Type 14-30R):
Go to Power Supply Cord Connection.

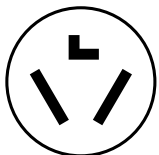

Power supply cord 3-wire receptacle (NEMA Type 10-30R):
Go to Power Supply Cord Connection.

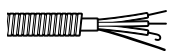

4-wire direct connection:
Go to Direct Wire Connection.

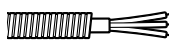

3-wire direct connection:
Go to Direct Wire Connection.

NOTE: If local codes do not permit connection of a cabinet-ground conductor to neutral wire, go to "Optional 3-wire connection." This connection may be used with either a power supply cord or a direct wire connection.

2. Remove terminal block cover

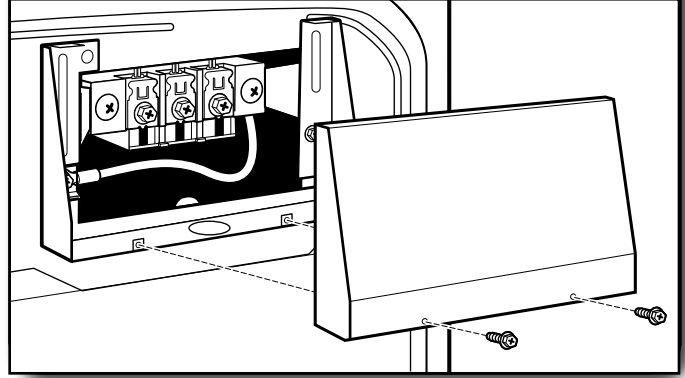

Remove hold-down screws and terminal block cover.

POWER SUPPLY CORD CONNECTION

Power Supply Cord Strain Relief

1. Attach power supply cord strain relief

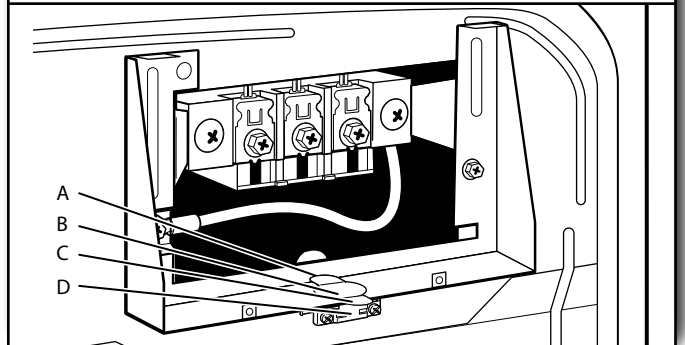

Remove the screws from a 3/4" (19 mm) UL listed strain relief (UL marking on strain relief). Put the tabs of the two clamp sections (C) into the hole below the terminal block opening (B) so that one tab is pointing toward the dryer (A) and the other is pointing away from the dryer (D), and hold in place. Tighten strain relief screws just enough to hold the two clamp sections (C) together.

2. Attach power supply cord to strain relief

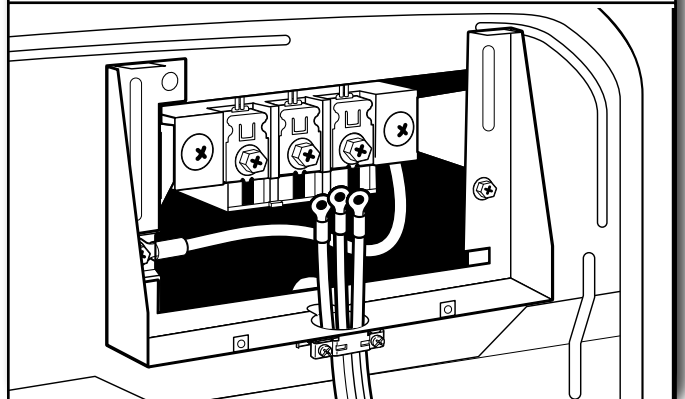

Put power supply cord through the strain relief. Be sure that the wire insulation on the power supply cord is inside the strain relief. The strain relief should have a tight fit with the dryer cabinet and be in a vertical position. Do not further tighten strain relief screws at this point.

If your outlet looks like this:

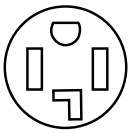

Power supply cord 4-wire receptacle (NEMA Type 14-30R):
Go to "4-Wire Power Supply Cord Connection".

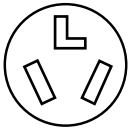

Power supply cord 3-wire receptacle (NEMA Type 10-30R):
Go to "3-Wire Power Supply Cord Connection".

4-wire Power Supply Cord Connection

IMPORTANT: A 4-wire connection is required for mobile homes and where local codes do not permit the use of 3-wire connections.

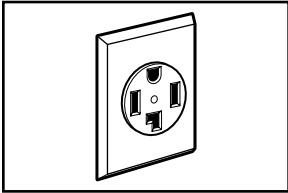

4-wire receptacle (NEMA type 14-30R)

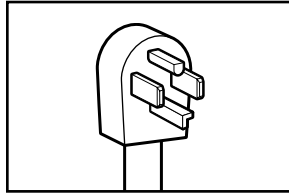

4-prong plug

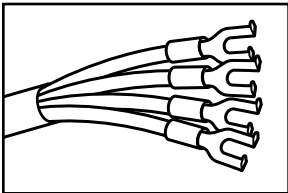

Spade terminals with upturned ends

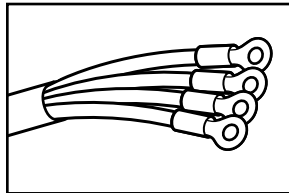

Ring terminals

1. Prepare to connect neutral ground wire and neutral wire

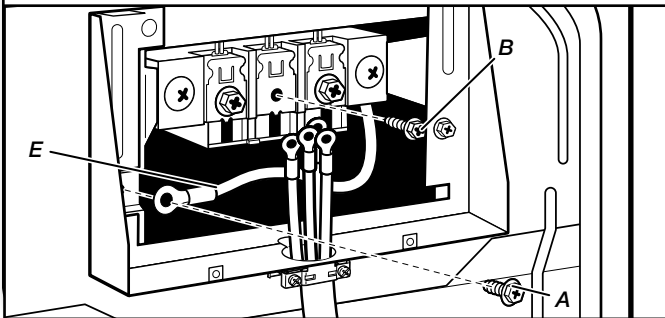

Remove center terminal block screw (B). Remove neutral ground wire (E) from external ground conductor screw (A). Reinstall ground conductor screw (A).

2. Connect neutral ground wire and neutral wire

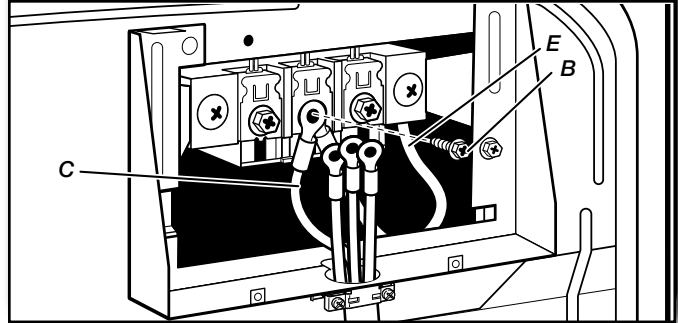

Connect neutral ground wire (E) and neutral wire (white) (C) of power supply cord under center terminal block screw (B). Tighten screw.

3. Connect ground wire

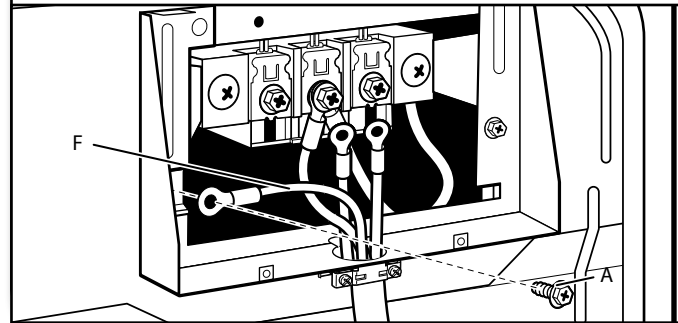

Connect ground wire (F) (green or bare) of power supply cord to external ground conductor screw (A). Tighten screw.

4. Connect remaining wires

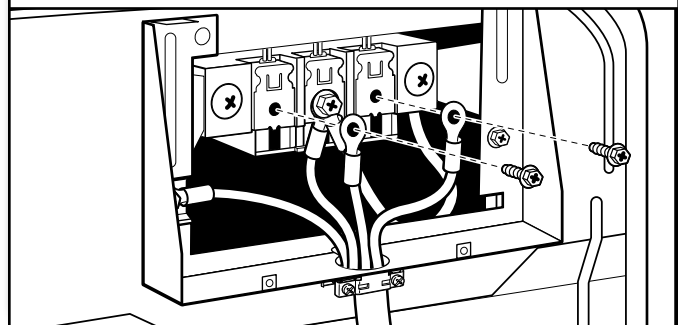

Connect remaining wires to outer terminal block screws. Tighten screws. Finally, reinsert tab of terminal block cover into slot of dryer rear panel. Secure cover with hold-down screw. Now, go to "Venting Requirements."

3-wire Power Supply Cord Connection

Use where local codes permit connecting cabinet-ground conductor to neutral wire.

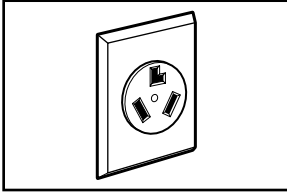

3-wire receptacle (NEMA type 10-30R)

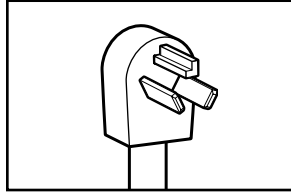

3-prong plug

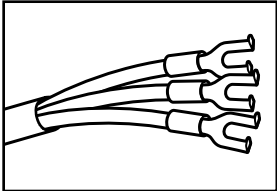

Spade terminals with upturned ends

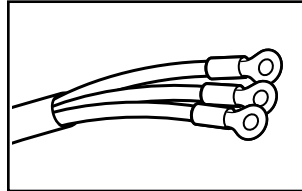

Ring terminals

1. Remove center screw

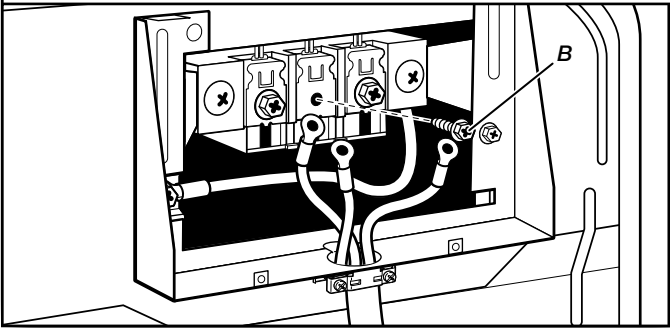

Remove center terminal block screw (B).

2. Connect neutral wire

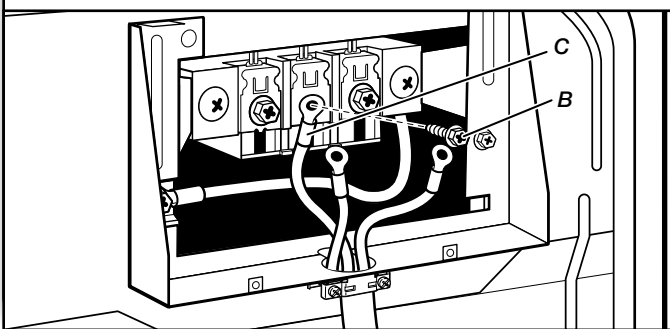

Connect neutral wire (white or center) (C) of power supply cord to center terminal block screw (B). Tighten screw.

3. Connect remaining wires

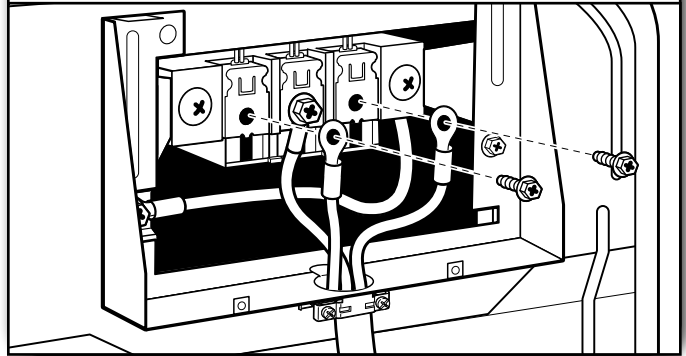

Connect remaining wires to outer terminal block screws. Tighten screws. Finally, reinsert tab of terminal block cover into slot of dryer rear panel. Secure cover with hold-down screws. Now, go to "Venting Requirements."

DIRECT WIRE CONNECTION

⚠ WARNING



Fire Hazard

Use 10 gauge copper wire.

Use a UL listed strain relief.

Disconnect power before making electrical connections.

Connect neutral wire (white or center wire) to center terminal (silver).

Ground wire (green or bare wire) must be connected to green ground connector.

Connect remaining 2 supply wires to remaining 2 terminals (gold).

Securely tighten all electrical connections.

Failure to do so can result in death, fire, or electrical shock.

Direct Wire Strain Relief

1. Attach direct wire strain relief

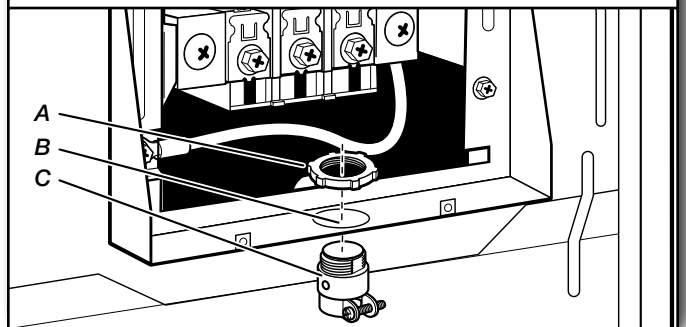

Unscrew the removable conduit connector (A) and any screws from a 3/4" (19 mm) UL listed strain relief (UL marking

on strain relief). Put the threaded section of the strain relief (C) through the hole below the terminal block opening (B). Reaching inside the terminal block opening, screw the removable conduit connector (A) onto the strain relief threads.

2. Attach direct wire cable to strain relief

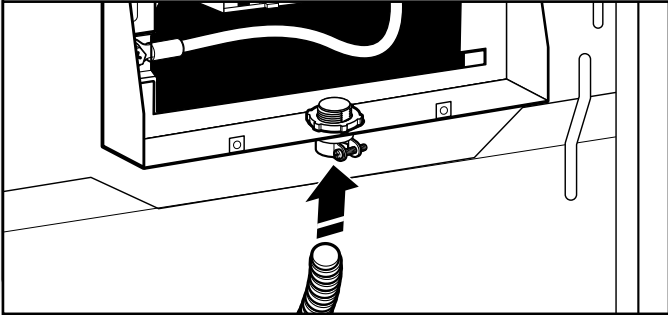

Put direct wire cable through the strain relief. The strain relief should have a tight fit with the dryer cabinet and be in a vertical position. Tighten strain relief screw against the direct wire cable.

If your wiring looks like this:

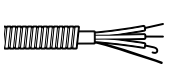

4-wire direct connection:
Go to "4-Wire Direct Connection" on this page.

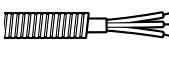

3-wire direct connection:
Go to "3-Wire Direct Connection" on page 11.

4-wire Direct Wire Connection

IMPORTANT: A 4-wire connection is required for mobile homes and where local codes do not permit 3-wire connections.

1. Prepare your 4-wire cable for direct connection

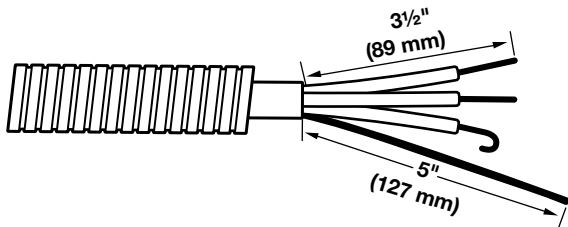

Direct wire cable must have 5 ft. (1.52 m) of extra length so dryer may be moved if needed.

Strip 5" (127 mm) of outer covering from end of cable, leaving bare ground wire at 5" (127 mm). Cut 1 1/2" (38 mm) from remaining 3 wires. Strip insulation back 1" (25 mm). Shape ends of wires into hooks.

2. Prepare to connect neutral ground wire and neutral wire

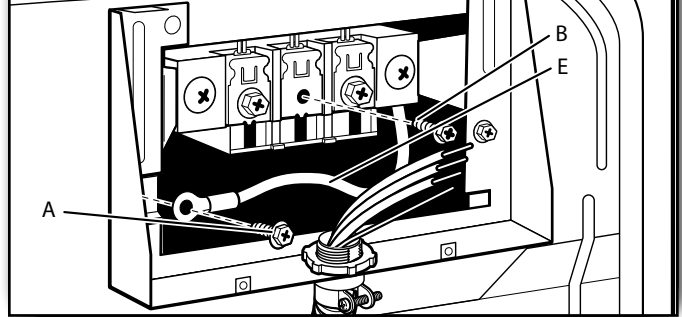

Remove center terminal block screw (B). Remove neutral ground wire (E) from external ground conductor screw (A).

3. Connect neutral ground wire and neutral wire

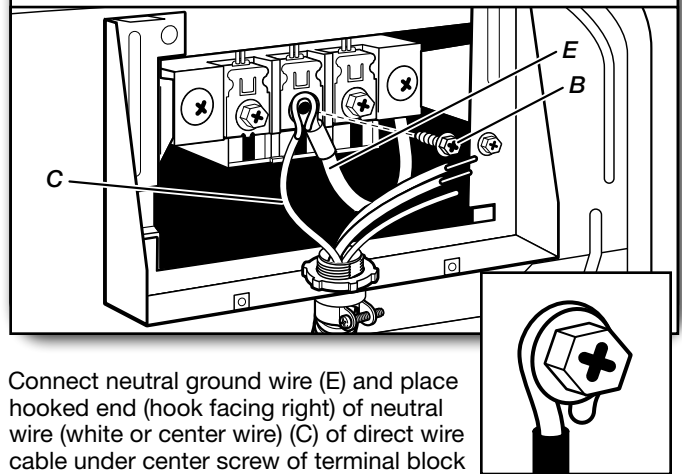

Connect neutral ground wire (E) and place hooked end (hook facing right) of neutral wire (white or center wire) (C) of direct wire cable under center screw of terminal block (B). Squeeze hooked ends together and tighten screw.

4. Connect ground wire

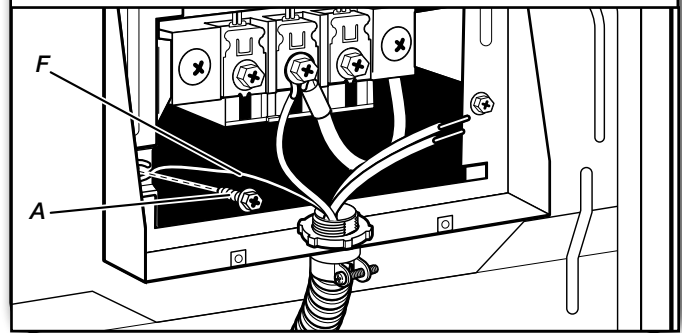

Connect ground wire (green or bare) (F) of direct wire cable to external ground conductor screw (A). Tighten screw.

5. Connect remaining wires

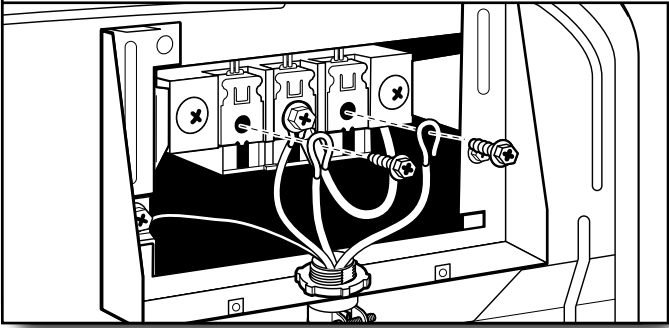

Place hooked ends of remaining direct wire cable wires under outer terminal block screws (hooks facing right). Squeeze hooked ends together and tighten screws. Finally, reinsert tab of terminal block cover into slot of dryer rear panel. Secure cover with hold-down screw. Now, go to "Venting Requirements."

3-wire Direct Wire Connection

Use where local codes permit connecting cabinet-ground conductor to neutral wire.

1. Prepare your 3-wire cable for direct connection

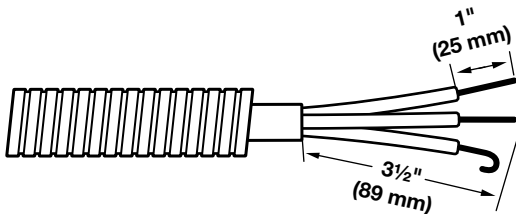

Direct wire cable must have 5 ft. (1.52 m) of extra length so dryer may be moved if needed.

Strip 3 1/2" (89 mm) of outer covering from end of cable. Strip insulation back 1" (25 mm). If using 3-wire cable with ground wire, cut bare wire even with outer covering. Shape wire ends into hooks.

2. Remove center screw

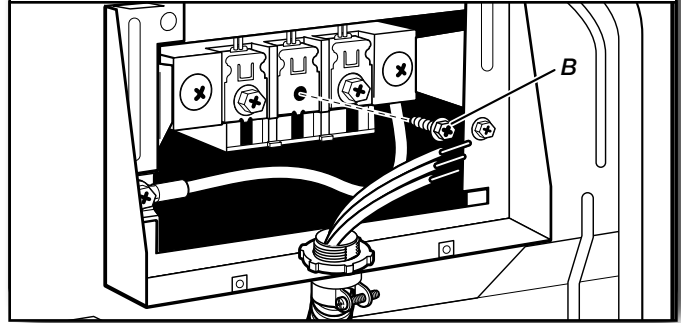

Remove center terminal block screw (B).

3. Connect neutral wire

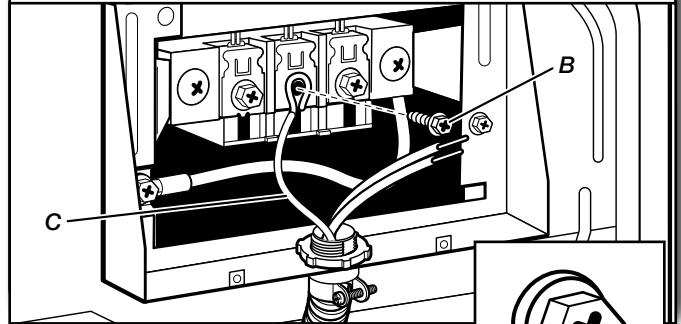

Place hooked end of neutral wire (white or center) (C) of direct wire cable under center terminal block screw (B). Squeeze hooked end together. Tighten screw.

4. Connect remaining wires

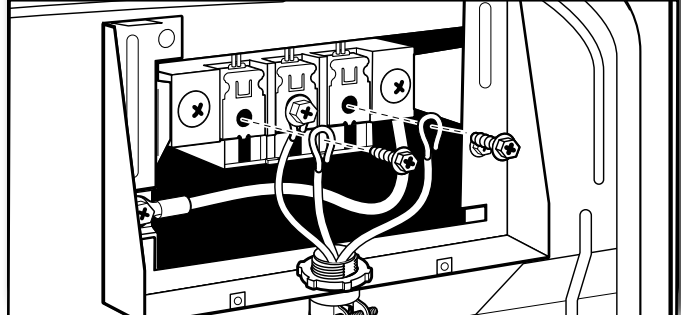

Place hooked ends of remaining direct wire cable wires under outer terminal block screws (hooks facing right). Squeeze hooked ends together and tighten screws. Finally, reinsert tab of terminal block cover into slot of dryer rear panel. Secure cover with hold-down screw. Now, go to "Venting Requirements."

Optional 3-wire Connection

You must verify with a qualified electrician that this grounding method is acceptable before connecting.

1. Prepare to connect neutral ground wire and neutral wire

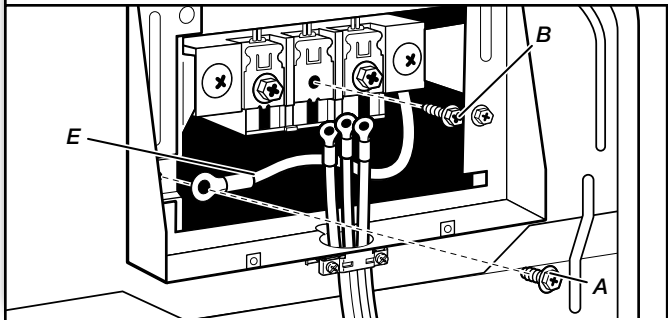

Remove center terminal block screw (B). Remove neutral ground wire (E) from external ground conductor screw (A).

2. Connect neutral ground wire and neutral wire

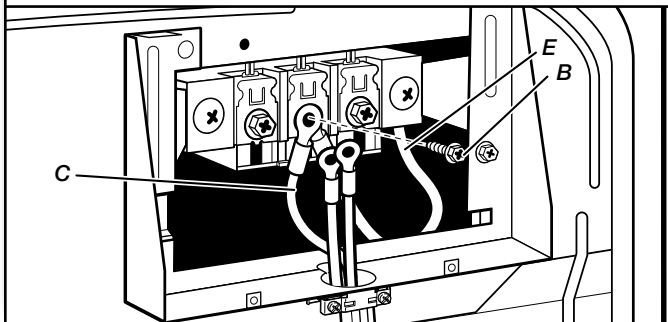

Connect neutral ground wire (E) and neutral wire (white or center wire) (C) of power supply cord or cable under center terminal block screw (B). Tighten screw.

3. Connect remaining wires

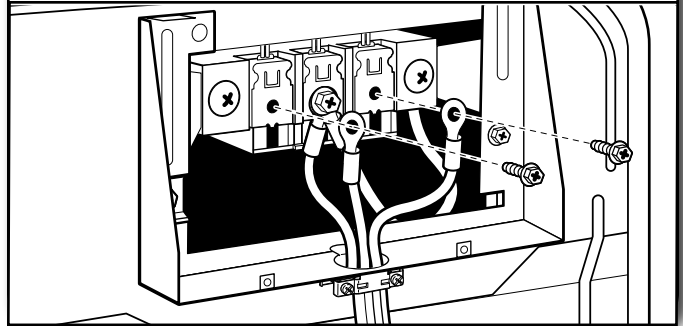

Connect remaining wires to outer terminal block screws. Tighten screws.

4. Connect external ground wire

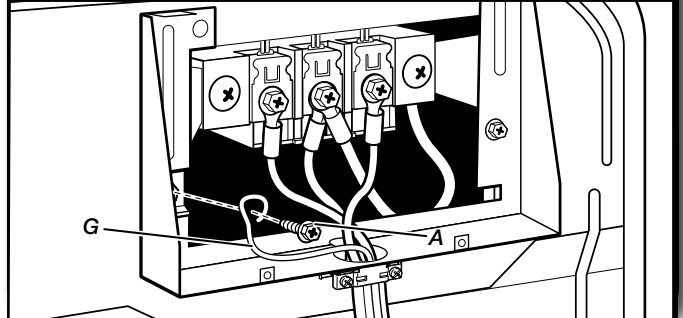

Connect a separate copper ground wire (G) from the external ground conductor screw (A) to an adequate ground. Finally, reinsert tab of terminal block cover into slot of dryer rear panel. Secure cover with hold-down screw. Now, go to "Venting Requirements."

MAKE GAS CONNECTION - U.S.A. AND CANADA

1. Connect gas supply to dryer

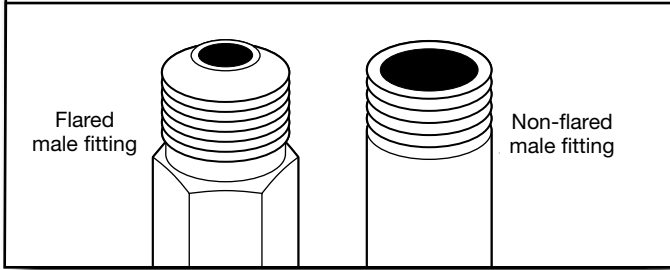

Remove red cap from gas pipe. Using a wrench to tighten, connect gas supply to dryer. Use pipe-joint compound on threads of all non-flared male fittings. If flexible metal tubing is used, be sure there are no kinks.

NOTE: For LP gas connections, you must use pipe-joint compound resistant to action of LP gas. Do not use TEFLON[®] tape.

2. Plan pipe fitting connection

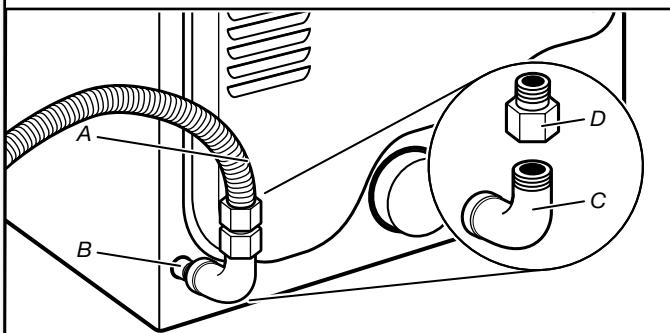

- A. 3/8" flexible gas connector
- B. 3/8" dryer pipe
- C. 3/8" to 3/8" pipe elbow
- D. 3/8" pipe-to-flare adapter fitting

A combination of pipe fittings must be used to connect dryer to existing gas line. Recommended connection is shown. Your connection may be different, according to supply line type, size, and location.

3. Open shut-off valve

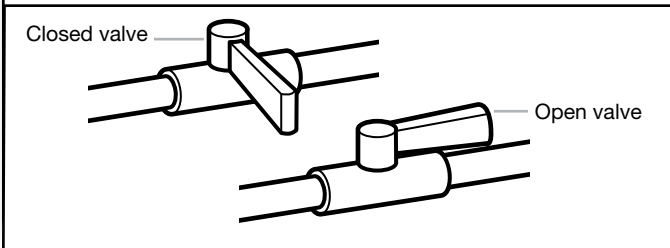

Open shut-off valve in supply line; valve is open when handle is parallel to gas pipe. Then, test all connections by brushing on an approved noncorrosive leak-detection solution. Bubbles will show a leak. Correct any leaks found.

VENTING

VENTING REQUIREMENTS

⚠ WARNING



Fire Hazard

- Use a heavy metal vent.
- Do not use a plastic vent.
- Do not use a metal foil vent.
- Failure to follow these instructions can result in death or fire.

WARNING: To reduce the risk of fire, this dryer MUST BE EXHAUSTED OUTDOORS.

IMPORTANT: Observe all governing codes and ordinances. Dryer exhaust must not be connected into any gas vent, chimney, wall, ceiling, attic, crawlspace, or a concealed space of a building. Only rigid or flexible metal vent shall be used for exhausting.

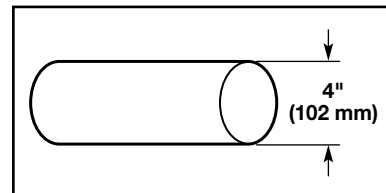

4" (102 mm) heavy metal exhaust vent

- Only a 4" (102 mm) heavy metal exhaust vent and clamps may be used.
- Do not use plastic or metal foil vent.

Rigid metal vent:

- Recommended for best drying performance and to avoid crushing and kinking.

Flexible metal vent: (Acceptable only if accessible to clean)

- Must be fully extended and supported in final dryer location.
- Remove excess to avoid sagging and kinking that may result in reduced airflow and poor performance.
- Do not install in enclosed walls, ceilings, or floors.
- The total length should not exceed 7³/₄ ft. (2.4 m).
- The length of flexible metal vent used must be included in the overall vent system design as shown in the "Vent System Charts."

NOTE: If using an existing vent system, clean lint from entire length of the system and make sure exhaust hood is not plugged with lint. Replace plastic or metal foil vents with rigid metal or flexible metal vents. Review Vent System Chart and, if necessary, modify existing vent system to achieve best drying performance.

Exhaust hoods:

- Must be at least 12" (305 mm) from ground or any object that may obstruct exhaust (such as flowers, rocks, bushes, or snow).

Recommended Styles:

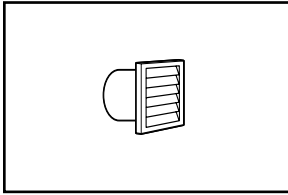

Louvered Hood

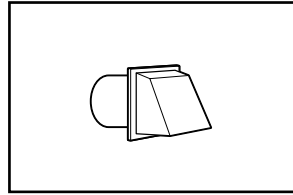

Box Hood

Acceptable Style:

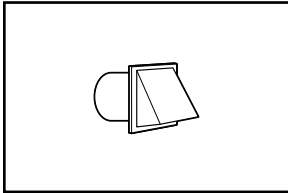

Angled Hood

Elbows:

- 45° elbows provide better airflow than 90° elbows.

Recommended Styles:

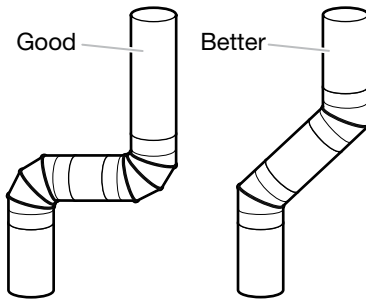

Clamps:

- Use clamps to seal all joints.
- Exhaust vent must not be connected or secured with screws or other fastening devices that extend into interior of duct and catch lint. Do not use duct tape.

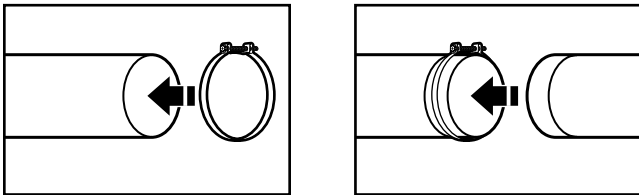

Improper venting can cause moisture and lint to collect indoors, which may result in:

- Moisture damage to woodwork, furniture, paint, wallpaper, carpets, etc.
- Housecleaning problems and health problems.

Vent products can be purchased from your dealer. For more information, see "Assistance or Service" section in your "Use and Care Guide."

PLAN VENT SYSTEM

Recommended exhaust installations

Typical installations vent the dryer from the rear of the dryer. Other installations are possible.

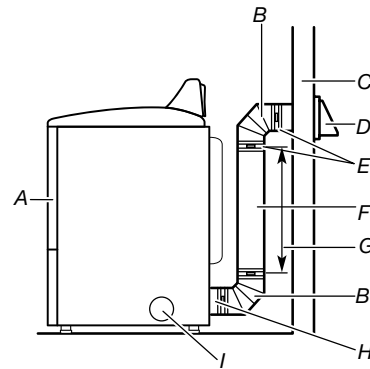

- A. Dryer
- B. Elbow
- C. Wall
- D. Exhaust hood
- E. Clamps
- F. Rigid metal or flexible metal vent
- G. Vent length necessary to connect elbows
- H. Exhaust outlet
- I. Optional side exhaust outlet

Optional exhaust installations:

⚠ WARNING

Fire Hazard

Cover unused exhaust holes with a manufacturer's exhaust cover kit.

Contact your local dealer.

Failure to follow these instructions can result in death, fire, electrical shock, or serious injury.

If you prefer, dryer may be converted to exhaust through the bottom and sides. You must contact your local dealer to have dryer converted.

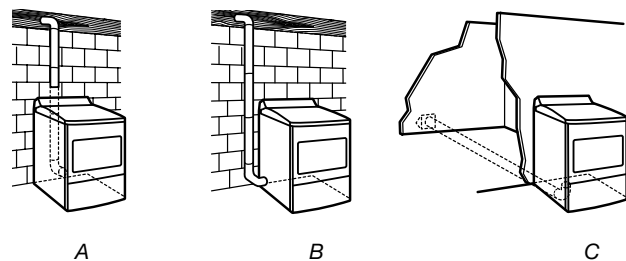

- A. Standard rear offset exhaust installation
- B. Left or right side exhaust installation
- C. Bottom exhaust installation

Special provisions for mobile homes:

Exhaust vent must be securely fastened to a noncombustible portion of mobile home and must not terminate beneath the mobile home. Terminate exhaust vent outside.

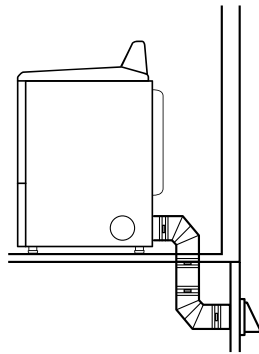

Mobile Home Exhaust installation

Determine vent path:

- Select route that will provide straightest and most direct path outdoors.
- Plan installation to use fewest number of elbows and turns.
- When using elbows or making turns, allow as much room as possible.
- Bend vent gradually to avoid kinking.
- Use as few 90° turns as possible.

Determine vent length and elbows needed for best drying performance:

- Use following Vent System Chart to determine type of vent material and hood combinations acceptable to use.

NOTE: Do not use vent runs longer than those specified in Vent System Chart. Exhaust systems longer than those specified will:

- Shorten life of dryer.
- Reduce performance, resulting in longer drying times and increased energy usage.

The Vent System Charts provide venting requirements that will help achieve best drying performance.

Vent System Chart			
Number of 90° turns or elbows	Type of vent	Box/louvered hoods	Angled hoods
0	Rigid metal	64 ft. (20 m)	58 ft. (17.7 m)
1	Rigid metal	54 ft. (16.5 m)	48 ft. (14.6 m)
2	Rigid metal	44 ft. (13.4 m)	38 ft. (11.6 m)
3	Rigid metal	35 ft. (10.7 m)	29 ft. (8.8 m)
4	Rigid metal	27 ft. (8.2 m)	21 ft. (6.4 m)

NOTE: Bottom exhaust installations have a 90° turn inside the dryer. To determine maximum exhaust length, add one 90° turn to the charts.

INSTALL VENT SYSTEM

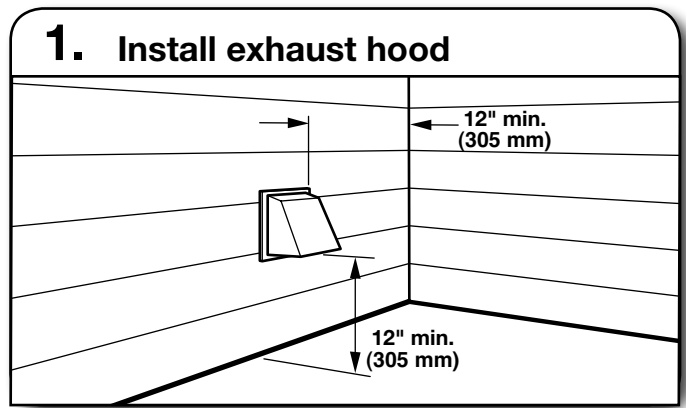

Install exhaust hood and use caulking compound to seal exterior wall opening around exhaust hood.

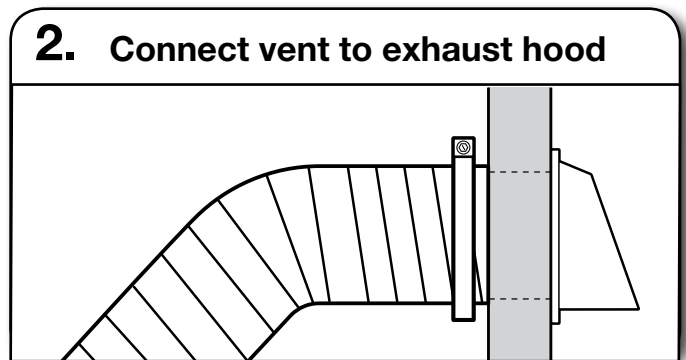

Vent must fit over the exhaust hood. Secure vent to exhaust hood with 4" (102 mm) clamp. Run vent to dryer location using straightest path possible. Avoid 90° turns. Use clamps to seal all joints. Do not use duct tape, screws, or other fastening devices that extend into interior of vent to secure vent, because they can catch lint.

CONNECT VENT

1. Connect vent to exhaust outlet

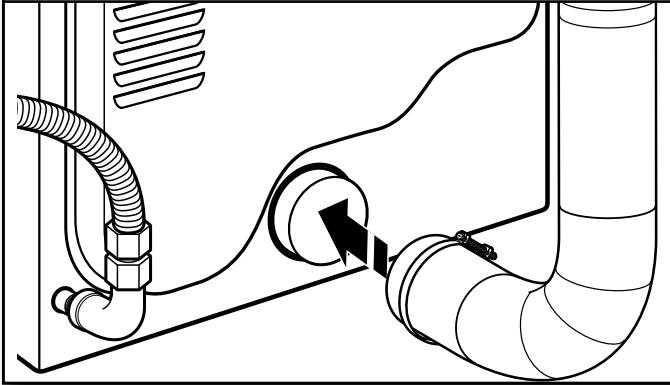

Using a 4" (102 mm) clamp, connect vent to exhaust outlet in dryer. If connecting to existing vent, make sure vent is clean. Dryer vent must fit over dryer exhaust outlet and inside exhaust hood. Check that vent is secured to exhaust hood with a 4" (102 mm) clamp.

2. Move dryer to final location

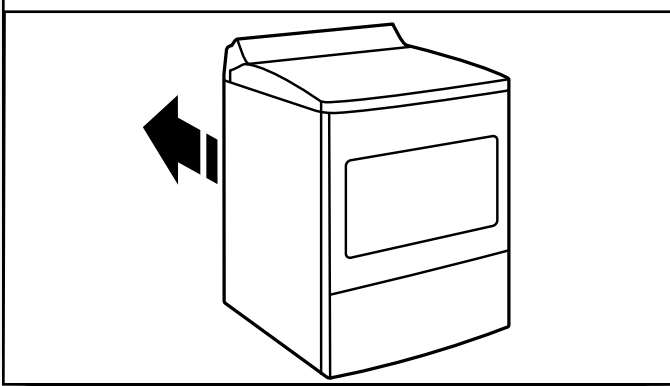

Move dryer to final location. Avoid crushing or kinking vent.

LEVEL DRYER

1. Level Dryer

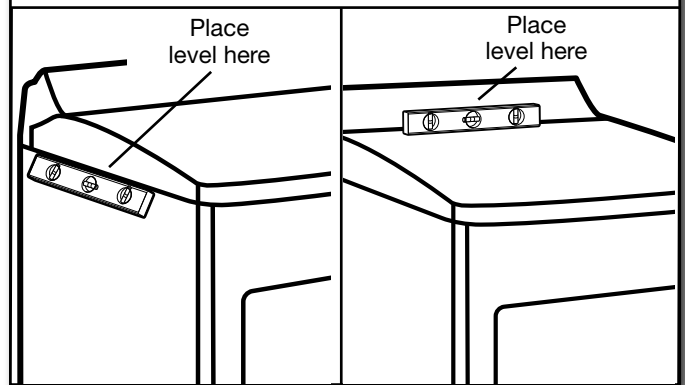

Check levelness of dryer from side to side. Repeat from front to back.

NOTE: The dryer must be level for the moisture sensing system to operate correctly.

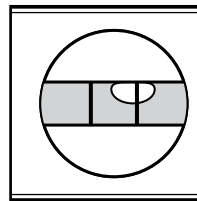

Not Level

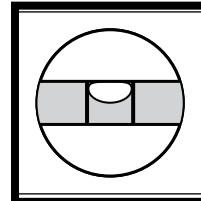

LEVEL

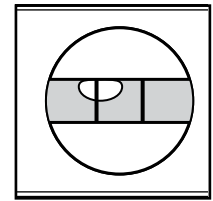

Not Level

2. Adjust leveling legs

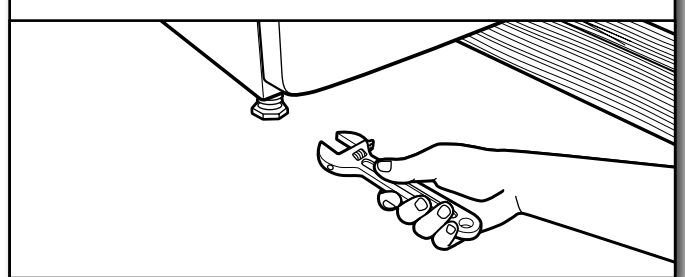

If dryer is not level, prop up using a wood block. Use wrench to adjust legs up or down, and check again for levelness.

COMPLETE INSTALLATION CHECKLIST

- Check that all parts are now installed. If there is an extra part, go back through steps to see what was skipped.
- Check that you have all of your tools.
- Dispose of/recycle all packaging materials.
- Check dryer's final location. Be sure vent is not crushed or kinked.
- Check that dryer is level. See "Level Dryer."
- Remove film on console and any tape remaining on dryer.
- Wipe dryer drum interior thoroughly with a damp cloth to remove any dust.
- Read "Dryer Use" in your "Use and Care Guide."

Electric Models:

- For power supply cord installation, plug into a grounded outlet. For direct wire installation, turn on Power.

Gas Models:

- Check that gas supply is on.
- Check for leaks.

All Models:

- Select a Timed Dry heated cycle, and start dryer. Do not select Air Only Temperature setting.

If dryer will not start, check the following:

- Controls are set in a running or "ON" position.
- Start button has been pushed firmly.
- Dryer is plugged into an outlet and/or electrical supply is connected.
- Household fuse is intact and tight, or circuit breaker has not tripped.
- Dryer door is closed.

This dryer automatically runs an installation diagnostic routine at the start of its first cycle.

If you receive an L2 code, there may be a problem with your home power supply keeping the dryer's heater from turning on. See "Troubleshooting."

If your Airflow screen reads "Check Vent", your dryer vent may be crushed or blocked. See "Troubleshooting."

NOTE: You may notice an odor when dryer is first heated. This odor is common when heating element is first used. The odor will go away.

REVERSE DOOR SWING

1. Place towel on dryer

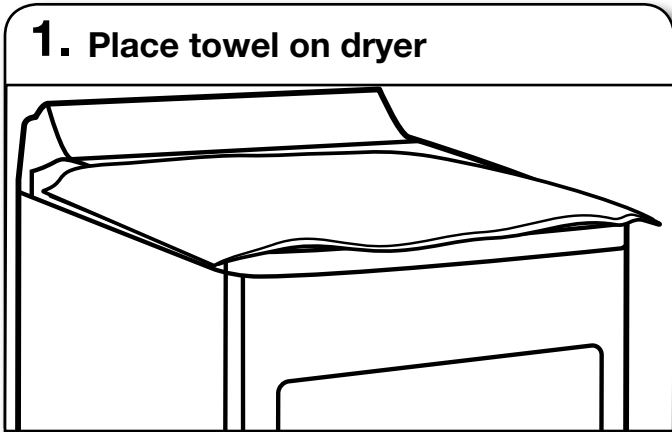

Place towel on top of dryer to avoid damaging the surface.

2. Remove bottom screws

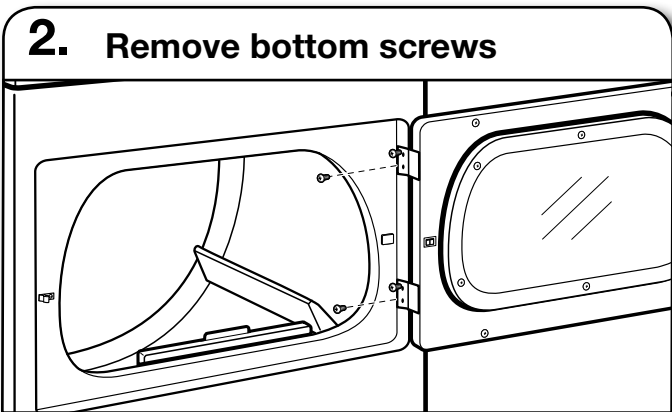

Open dryer door. Remove bottom screws from dryer cabinet side of hinges. Loosen (do not remove) top screws from dryer cabinet side of hinges.

3. Lift door off top screws

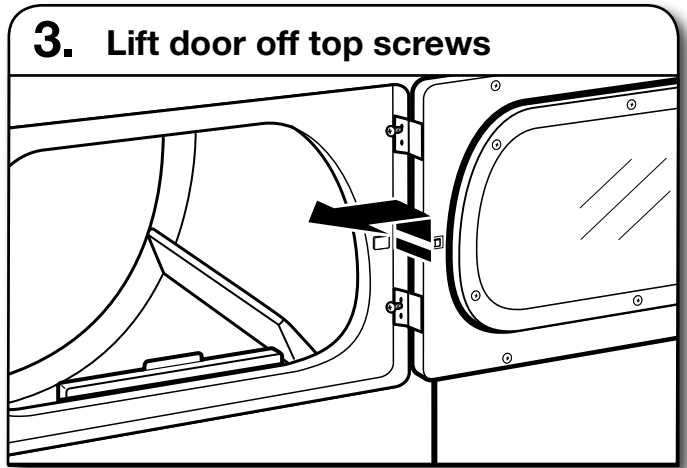

Lift door until top screws in dryer cabinet are in large part of hinge slot. Pull door forward off screws. Set door (handle side up) on top of dryer. Remove top screws from dryer cabinet.

4. Remove screws from hinges

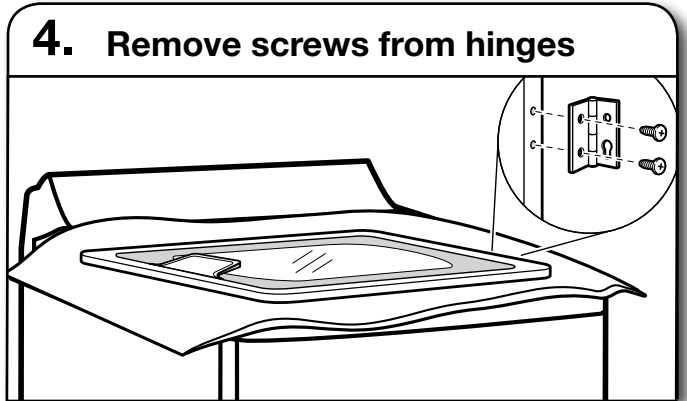

Remove screws attaching hinges to door.

5. Flip door over

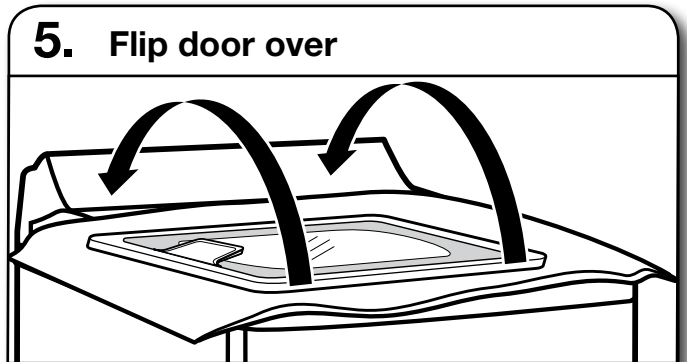

Flip door over so handle side is down.

6. Remove screws from door

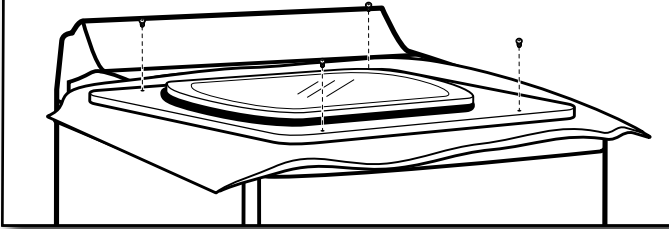

Remove screws at top, bottom, and side of door (4 screws). Keep door screws separate from hinge screws as they are different sizes.

7. Separate inner from outer door

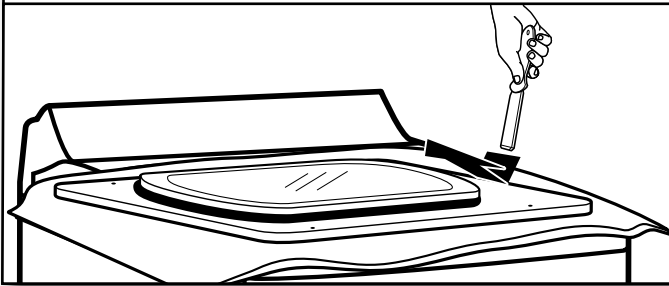

Holding door over towel on dryer, pry inner door and lift to separate it from outer door.

NOTE: Do not pull on door seal or plastic door catches.

8. Rotate outer door

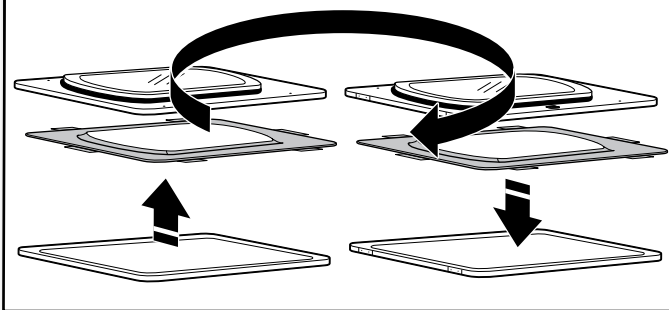

Rotate outer door 180° and set it back down on inner door. Be certain to keep cardboard spacer centered between doors. Reattach outer door panel to inner door panel so handle is on the side where hinges were just removed. Insert 4 door screws.

9. Attach door hinges

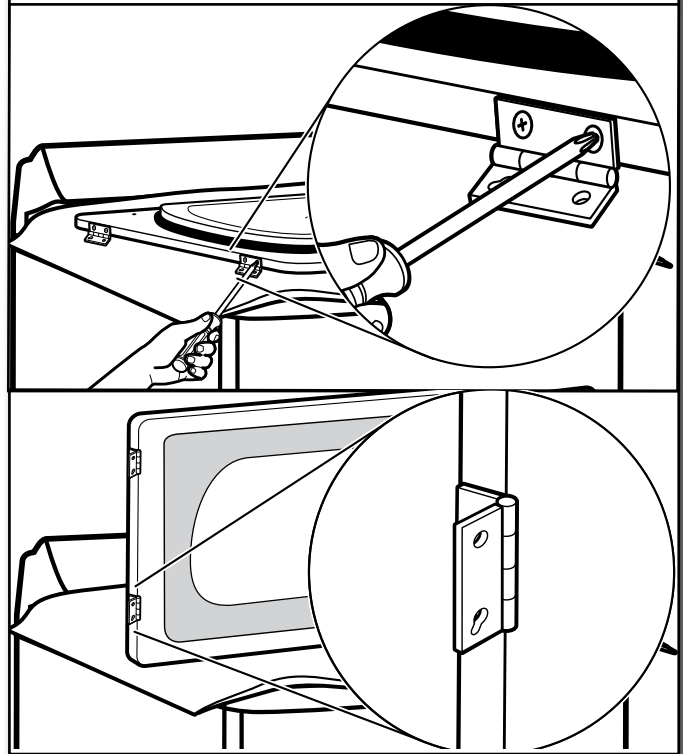

Reattach door hinges to dryer door so that the larger hole is at the bottom of the hinge.

10. Remove door strike and door strike label

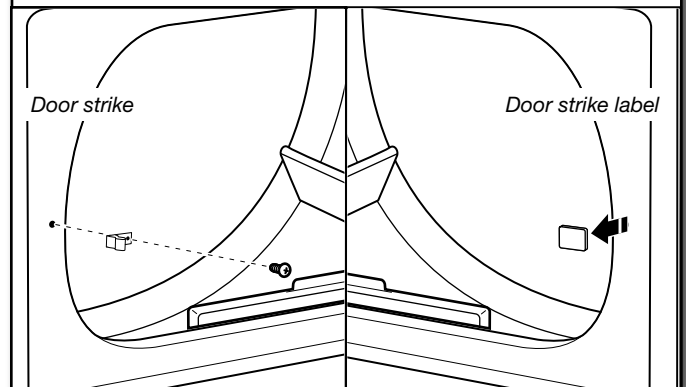

Remove door strike and door strike label from dryer cabinet. Insert the door strike into hole where door strike label was removed and secure with screw. Cover original door strike hole with door strike label and press firmly into place.

11. Remove and transfer plugs

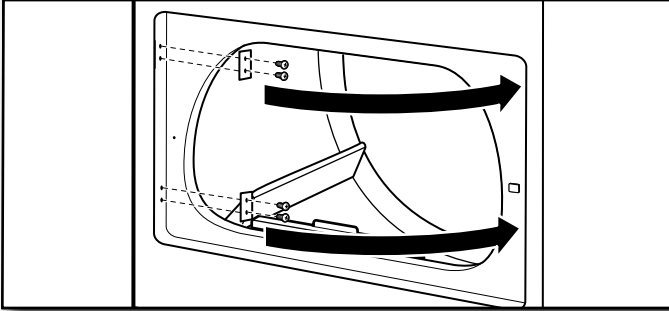

Remove the 4 screws that attach 2 plugs on the left side. Transfer plugs to opposite side using the same 4 screws.

12. Insert screws in hinge holes on dryer cabinet

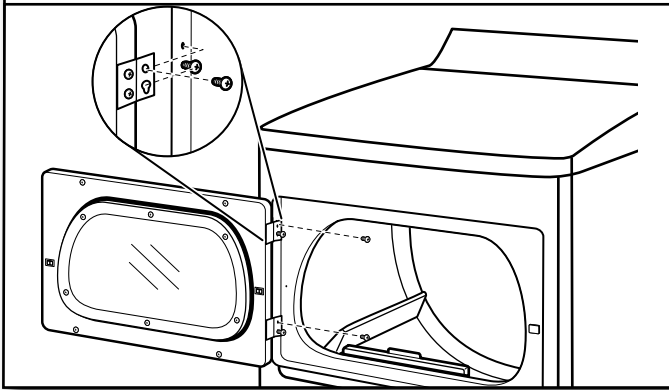

NOTE: 2 people may be needed to reinstall door.

Insert screws into the bottom holes on left side of dryer cabinet. Tighten screws halfway. Position door so large end of door hinge slot is over screws. Slide door up so screws are in bottom of slots. Tighten screws. Insert and tighten top screws in hinges.

13. Check door strike alignment

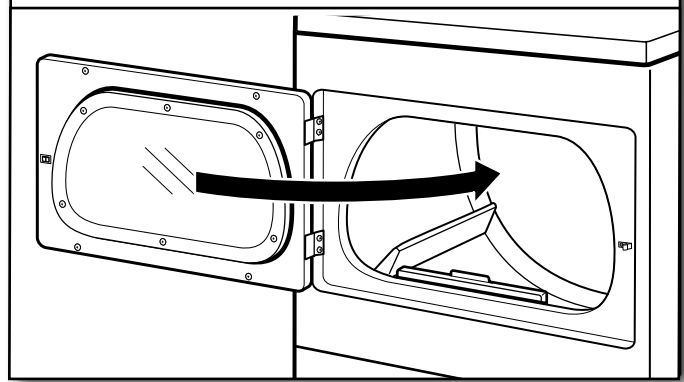

Close door and check that door strike aligns with door catch. If it is needed, slide door catch left or right within slot to adjust alignment.

TROUBLESHOOTING

See the Use and Care Guide or visit our website and reference "Frequently Asked Questions" to possibly avoid the cost of a service call.

